

# **EIMAC** **power grid tubes**

QUICK REFERENCE CATALOG 175

**EIMAC**  
**division of varian**  
301 Industrial Way  
San Carlos, CA 94070  
(415) 592-1221



division of varian

# TUBE TYPE INDEX

To find a specific tube, first look for the initial numerical portion of the type number. Tubes are listed sequentially according to this number. When more than one tube has the same initial number, the tubes will be

listed alphabetically by the first set of letter designations. Within these parameters, tubes are then listed numerically or alphabetically by the remaining number of letter designations.

TUBE	PAGE	TUBE	PAGE	TUBE	PAGE	TUBE	PAGE
2C39A	16	4CV250,000A	77	6775/4-400C	88	8660/4CX1500B	66
2C39BA	16	4CW800B	78	6816	72	8661/4CW10,000A	79
2C39WA	16	4CW800F	78	6884	72	8745/7815/7815R	17
3CPX1500A7	29	4CW2000A/8244	78	7034/4X150A	71	8755	21
3CV30,000A3	44	4CW10,000A/8661	79	7203/4CX250B	58	8755A	21
3CV30,000H3	44	4CW25,000A	79	7211	19	8757	21
3CW5,000A1/8240	46	4CW50,000E	80	7289/2C39A	16	8809/4CX600J	64
3CW5,000A3/8242	46	4CW50,000J	80	7480	45	8847	22
3CW5,000F1/8241	46	4CW100,000D	81	7580W/4CX250R	60	8847A	22
3CW5,000F3/8243	46	4CW100,000E	82	7609	71	8873	56
3CW5,000H3	47	4CW250,000A	83	7698	19	8874	41
3CW10,000H3	47	4CX250B/7203	58	7815/8745	17	8875	41
3CW20,000A1	48	4CX250BC/8957	59	7815AL	17	8877/3CX1500A7	30
3CW20,000A3	48	4CX250FG/8621	58	7815R/8745	17	8892	22
3CW20,000A7	49	4CX250K/8245	60	7815RAL	17	8893	23
3CW20,000H3	49	4CX250M/8246	60	7843	92	8904/4CX350FJ	62
3CW20,000H7	50	4CX250R/7580W	60	7850W/4CX250R	60	8906	23
3CW30,000H3	50	4CX300A/8167	61	7855/Y-503	18	8906AL	23
3CW30,000H7	51	4CX300Y/8561	61	7855KAL	18	8907	23
3CW40,000H3	51	4CX350A/8321	62	8158/3CX10,000A1	35	8907AL	23
3CX100A5	16	4CX350F/8322	62	8159/3CX10,000A3	35	8909/4CX5000J	67
3CX400U7/8961	21	4CX350FJ/8904	62	8160/3CX10,000A7	36	8910/4CX15,000J	70
3CX1000A7/8283	30	4CX600B	63	8161/3CX2500A3	31	8921/4CX600JA	64
3CX1500A7/8877	30	4CX600F	63	8162/3CX3000F7	33	8930	73
3CX2500A3/8161	31	4CX600J/8809	64	8163/3-400Z	54	8933	24
3CX2500F3/8251	31	4CX600JA/8921	64	8164/3-1000Z	55	8938	42
3CX2500H3	31	4CX1000A/8168	64	8165/4-65A	86	8940	24
3CX3000A1/8238	32	4CX1000K/8352	65	8166/4-1000A	89	8941	24
3CX3000F1/8239	32	4CX1500A	65	8167/4CX300A	61	8942	25
3CX3000A7	33	4CX1500B/8660	66	8168/4CX1000A	64	8954	93
3CX3000F7/8162	33	4CX3000A/8169	66	8169/4CX3000A	66	8957/4CX250BC	59
3CX5000A3	34	4CX5000A/8170	67	8170/4CX5000A	67	8959	85
3CX5000H3	34	4CX5000J/8909	67	8170W/4CX5000R	68	8960	91
3CX10,000A1/8158	35	4CX5000R/8170W	68	8171/4CX10,000D	68	8961/3CX400U7	29
3CX10,000A3/8159	35	4CX10,000D/8171	68	8188/4PR400A	91	8962	42
3CX10,000A7/8160	36	4CX10,000J	69	8189/4PR1000A	91	8963	43
3CX10,000H3	36	4CX15,000A/8281	69	8238/3CX3000A1	32		
3CX15,000A3	37	4CX15,000J/8910	70	8239/3CX3000F1	32		
3CX15,000A7	37	4CX35,000C/8349	70	8240/3CW5000A1	46		
3CX15,000H3	38	4PR60C/8252W	90	8241/3CW5000F1	46		
3CX20,000A3	38	4PR250C/8248	90	8242/3CW5000A3	46		
3CX20,000A7	39	4PR400A/8188	91	8243/3CW5000F3	46		
3CX20,000H3	39	4PR1000A/8189	91	8244/4CW2000A	78		
3-400Z/8163	54	4X150A/7034	71	8245/4CX250K	60		
3-500Z	54	5-500A	94	8248/4PR250C	90		
3-1000Z/8164	55	5D22/4-250A	87	8251/3CX2500F3	31		
4-65A/8165	86	5CX1500A	95	8252W/4PR60C	90		
4-125A/4D21	86	5CX3000A	95	8281/4CX15,000A	69		
4-250A/5D22	87	X-2159	84	8283/3CX1000A7	30		
4-400C/6775	89	X-2170	84	8295A	96		
4-500A	89	X-2176	53	8321/4CX350A	62		
4-1000A/8166	88	X-2177	53	8349/4CX35,000C	70		
4D21/4-125A	86	Y-503/7855	18	8351/4CV100,000C	76		
4CPX250K/8590	57	Y-518	26	8352/4CX1000K	65		
4CS250R	92	Y-519	26	8403	20		
4CV8000A	74	Y-540	27	8533	20		
4CV35,000A	74	Y-579	27	8533W	20		
4CV50,000E	75	Y-579A	28	8561/4CX300Y	61		
4CV50,000J	75	6696A	52	8590/4CPX250K	57		
4CV100,000C/8351	76	6697A	40	8621/4CX250FG	58		

Note: Refer to page 97 for replacement types.

# QUICK REFERENCE GUIDE TO CATALOG CONTENTS

SECTION	PAGES
Introduction and Power Grid Tube Selection Guide .....	4-15
Planar Triodes .....	16-28
External Anode, Forced Air Cooled Triodes .....	29-43
External Anode, Vapor Cooled Triodes .....	44-45
External Anode, Water Cooled Triodes .....	46-53
Internal Anode, Radiation Cooled Triodes .....	54-55
External Anode, Forced-Air Cooled Tetrodes .....	56-73
External Anode, Vapor Cooled Tetrodes .....	74-77
External Anode, Water Cooled Tetrodes .....	78-85
Internal Anode, Radiation Cooled Tetrodes .....	86-91
External Anode, Conduction Cooled Tetrodes .....	92-93
External Anode, Forced Air Cooled Pentodes .....	94-96
Replacement Tubes .....	97
JEDEC/EIMAC Cross-Reference List .....	98-99
Sockets and Accessories .....	100-111

## INTRODUCTION

The EIMAC division of Varian manufactures a complete line of power grid tubes and accessories, including diodes, triodes tetrodes, pentodes and associated equipment.

EIMAC employs over 600 persons at the division's main plant in San Carlos, California, and another 400 at a recently-expanded facility in Salt Lake City, Utah.

Major production activity at the San Carlos plant includes the manufacture of ceramic/metal power grid tubes. Glass power tubes and a wide line of planar triodes and X-ray tubes are major production items at the Salt Lake City plant.

These two facilities, among the most modern electron tube production plants in the world, have all manufacturing areas designed on a product flow system for maximum efficiency. Clean rooms for critical assembly work are ventilated and filtered for maximum product yield and reliability. Giant EIMAC-developed rotary vacuum pumps provide a high production rate. Facilities for processing ceramic materials include some of

the most modern equipment available. Extensive environmental test equipment is at hand for checking product performance under unusual conditions of shock, vibration, humidity and high altitude.

Quality assurance procedures are very strict, and include both operator surveillance, batch sampling and statistical controls.

The EIMAC development and circuit techniques laboratories are especially designed for production of experimental tube types and for modification of existing designs to meet special customer requirements. New tube types and circuit techniques are continually explored in the EIMAC laboratories.

Power grid tube Application Engineering information and Marketing Services are available from the San Carlos facility of EIMAC. Planar triode application information is available at the Salt Lake plant. Marketing and application information on all EIMAC products are available from any of the Varian/EIMAC Electron Device Group field offices throughout the world.

## INTERPRETATION OF CATALOG DATA

Data provided for EIMAC products in this catalog include maximum ratings, typical operation, characteristics and a brief description of the product.

The **maximum rating** is an absolute limit on a particular operating parameter or on a combination of parameters. Operation above the maximum rating of any parameter is not recommended, as it may impair the performance or the life of the product.

Data provided under **typical operation** represent operating conditions within the maximum ratings that are suitable for a particular application and do not imply that the product cannot be operated satisfactorily under other conditions in the same application.

The term **plate output power** is the calculated output power from the tube itself and is equal to plate input minus plate dissipation. The term **useful power output** is the output measured at the load of the output circuit, and does not include power lost in the circuit.

Information furnished by EIMAC in this catalog is believed to be accurate and reliable. Characteristics and operating values are based upon performance tests or calculated data. These figures may change without notice as the result of additional data or product refinement. EIMAC division of Varian should be consulted before using this catalog information for final equipment design.

# EIMAC TUBE TYPE NUMBERING SYSTEM

EIMAC tube types are identified by either a non-descriptive, sequentially-assigned 4-digit type number, standardized and registered with the ELECTRONIC INDUSTRIES ASSOCIATION (EIA) for non-duplication throughout the world, or by an EIMAC-originated coded numbering system, designed to convey descriptive information about the tube. Many tube types can be identified with either number, and are branded with both.

In general, the EIMAC type number consists of: a numeral indicating the number

of electrodes, one or more letters denoting special characteristics, a numeral representing the plate dissipation rating, and a final letter to distinguish the tube from others which may bear similar or preceding letters and numerals. Triode types carry an additional number to indicate their approximate amplification factor.

To illustrate the system, a typical 1500-watt, ceramic, external-anode, forced-air cooled EIMAC triode is broken down as follows:

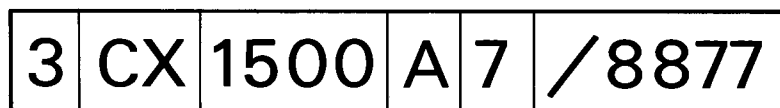

## Number of Electrodes

- 2 - Diode
- 3 - Triode
- 4 - Tetrode
- 5 - Pentode

## EIA Type Number

## Plate Dissipation (Watts)

## Description

- C - Ceramic Envelope (No Glass)
- L - External Anode, Liquid Convection Cooling
- N - External Anode, Natural Convection Air Cooling
- P - Primarily for Pulse Applications
- \*R - Internal Anode, Radiation Cooled
- S - External Anode, Conduction Cooled
- V - External Anode, Vapor Cooled
- W - External Anode, Water Cooled
- X - External Anode, Forced-Air Cooled
- \* - In older types, the dash, as in the case of the 4-250A, carries the meaning of "R" given above.

## Version

Distinguishes tubes which, although alike as to number of electrodes and plate dissipation, are not necessarily interchangeable physically or electrically.

## Triode Amplification Factor

- 1-0 to 10
- 2-11 to 20
- 3-21 to 30
- 4-31 to 50
- 5-51 to 100
- 6-101 to 200
- 7-201 to 500
- 8-501 to 1000

# POWER GRID TUBE SELECTION GUIDE

The EIMAC Power Grid Tube Selection Guide is arranged for ease in making type selections by use rather than tube type. The Guide is applications-oriented.

Tube types are listed according to the principle modes of service for which they are rated. Under each mode of service, EIMAC tube types suitable for the application are tabulated in descending order of the most significant tube parameter in the left hand column. For example, in the POWER AMPLIFIER tabulation, tube types are listed in

descending order of typical rf power output; PULSE REGULATOR tubes are listed in descending order of peak current capability. This format places emphasis on tube application and facilitates comparison in terms of the significant ratings of the EIMAC types available for a given application.

After preliminary selection of a tube type (or types) from the Guide, the final choice should be based upon the complete ratings from the EIMAC data sheet for the tube in question and consultation with the EIMAC Application Engineering Department.

## RADIO FREQUENCY POWER AMPLIFIER

### Linear Service

Peak Env. Power <sup>‡</sup> Typical (kW)	Rated Anode Diss. (kW)	Frequency* F1 / upper useful (MHz)	Inter-Mod. Distortion Typical <sup>†</sup>		Cooling	EIMAC Type Number	Tube Type
			3rd (dB)	5th (dB)			
1180	1250	30 / 50	—	—	water	X-2159	Tetrode
600	650	50 / 100	—	—	water	X-2170	Tetrode
230	250	30 / 50	-31	-43	vapor	4CV250,000A	Tetrode
230	250	30 / 50	-31	-43	water	4CW250,000A	Tetrode
168	100	108 / 150	—	—	water	4CW100,000E	Tetrode
123	100	30 / 50	-26	-40	vapor	4CV100,000C	Tetrode
105	50	110 / 220	—	—	vapor	3CV50,000A7	Triode <sup>1</sup>
55	35	30 / 50	-30	-40	air	4CX35,000C	Tetrode
45	50	110 / 200	-46	-60	vapor	4CV50,000J	Tetrode
45	50	110 / 200	-46	-60	water	4CW50,000J	Tetrode
27.5	20	250 / 500	—	—	air	8963	Triode <sup>2</sup>
27.5	20	110 / 220	—	—	air	3CX20,000A7	Triode <sup>2</sup>
17	15	110 / 220	-40	-39	air	3CX15,000A7	Triode <sup>1</sup>
17	20	140 / 220	-40	-39	water	3CW20,000A7	Triode <sup>1</sup>
17	10	140 / 220	-40	-39	air	3CX10,000A7	Triode <sup>1</sup>
14	10	100 / 220	-30	-36	air	4CX10,000D	Tetrode
12	15	110 / 220	-41	-41	air	4CX15,000J	Tetrode
10.5	10	100 / 220	-35	-40	air	4CX10,000J	Tetrode
10	5	100 / 220	-30	-38	air	4CX5000A	Tetrode
10	5	100 / 220	-30	-38	air	4CX5000R	Tetrode
5.8	3	150 / 220	-40	-43	air	5CX3000A	Pentode
5.3	5	30 / —	-26	-40	air	290	Pentode
5.5	3	110 / —	-51	-45	air	3CX3000A7	Triode <sup>1</sup>
5.3	3	150 / 220	-32	-36	air	4CX3000A	Tetrode
5.8	3	30 / —	-26	-41	air	264/8576	Pentode
3.3	5	100 / 220	-41	-44	air	4CX5000J	Tetrode
2.06	1	220 / 400	-31	-39	air	3CX1000A7	Triode <sup>1</sup>

<sup>‡</sup> Plate power output, calculated or measured at low frequency.

\* F1 is the maximum frequency at which maximum ratings apply. Operation at the upper useful frequency normally involves operation at reduced anode voltage and reduced plate input power.

<sup>†</sup> Calculated or measured by two-tone method at 2.0 MHz.

1. Grounded grid 2. VHF TV

RADIO FREQUENCY POWER AMPLIFIER — LINEAR, CONTINUED

Peak Env. Power† Typical (Watts)	Rated Anode Diss. (Watts)	Frequency* F1/upper useful (MHz)	Inter-Mod. Distortion Typical†		Cooling	EIMAC Type Number	Tube Type
			3rd (dB)	5th (dB)			
2050	1500	220 / 400	-38	-44	air	3CX1500A7	Triode <sup>1</sup>
2030	1500	500 / —	-44	-44	air	8938	Triode <sup>1</sup>
1785	1500	110 / 220	-33	-42	air	5CX1500A	Pentode
1160	1000	110 / 220	-43	-47	air	4CX1500B	Tetrode
1080	1000	110 / —	-29	-37	air	3-1000Z	Triode <sup>1</sup>
940	500	110 / —	-40	-45	air	3-500Z	Triode <sup>1</sup>
645	500	110 / —	-33	-41	air	5-500A	Pentode
590	200	500 / 900	-35	-36	conduction	8873	Triode <sup>1</sup>
590	400	500 / 900	-35	-36	air	8874	Triode <sup>1</sup>
590	300	500 / 900	-35	-36	air	8875	Triode <sup>1</sup>
590	400	110 / —	-28	-35	air	3-400Z	Triode <sup>1</sup>
580	600	30 / —	-43	-43	air	4CX600J	Tetrode
495	400	110 / —	—	—	air	4-400C	Tetrode
350	350	500 / —	-27	-50	air	8930	Tetrode
295	250	500 / —	-25	-30	air	4CX250R	Tetrode
295	250	500 / —	-25	-30	conduction	4CS250R	Tetrode
263	350	30 / 220	-30	-35	air	4CX350A	Tetrode
263	350	30 / 220	-30	-35	air	4CX350F	Tetrode
263	350	30 / 220	-40	-45	air	4CX350FJ	Tetrode
226	200	500 / —	—	—	conduction	8560A	Tetrode

† Plate power output, calculated or measured at low frequency.

\* F1 is the maximum frequency at which maximum ratings apply. Operation at the upper useful frequency normally involves operation at reduced anode voltage and reduced plate input power.

† Calculated or measured by two-tone method at 2.0 MHz.

1. Grounded grid

## RF POWER AMPLIFIER

### Class C, CW or FM Service

Plate Pwr. Output Typical* (kW)	Rated Plate Diss. (kW)	Freq.† F1/upper useful (MHz)	Power Gain*	Cooling	EIMAC Type Number	Tube Type
1650	1250	30 / 50	x200	water	X-2159	Tetrode
1050	650	50 / 100	x300	water	X-2170	Tetrode
460	250	30 / 50	x150	vapor	4CV250,000A	Tetrode
460	250	30 / 50	x150	water	4CW250,000A	Tetrode
220	100	108 / 150	x1800	water	4CW100,000E	Tetrode
168	100	30 / 50	x1350	vapor	4CV100,000C	Tetrode
165	100	30 / 50	x140	water	4CW100,000D	Tetrode
137	50	110 / 220	x900	vapor	4CV50,000E	Tetrode
137	50	110 / 220	x900	water	4CW50,000E	Tetrode
110	35	30 / 50	x425	air	4CX35,000C	Tetrode
80	60	40 / 80	x130	water	6696A	Triode
80	80	40 / 80	x130	vapor	7480	Triode
80	35	40 / 80	x130	air	6697A	Triode
64	20	90 / 150	x66	air	3CX20,000A3	Triode
64	20	90 / 150	x66	air	3CX20,000H3	Triode
42	25	100 / 150	x37	water	3CW25,000A3	Triode
36.5	15	110 / 225	x166	air	4CX15,000A	Tetrode
30.0	15	100 / 150	x45	air	3CX15,000A3	Triode
25.0	15	110 / 160	x50	air	3CX15,000A7	Triode
24.5	10	140 / 200	x6	air	3CX10,000A3	Triode <sup>1</sup>
24.5	20	140 / 200	x6	water	3CW20,000A3	Triode <sup>1</sup>
16	5	100 / 220	x1050	air	4CX5000A	Tetrode

\* Power output and power gain are calculated or measured at low frequency.

† F1 is the maximum frequency at which maximum ratings apply. Operation at the upper useful frequency normally involves operation at reduced anode voltage and reduced plate input power.

1. Grounded grid

RF FREQUENCY POWER AMPLIFIER — CLASS C, CW or FM, CONTINUED

Plate Pwr. Output Typical* (Watts)	Rated Plate Diss. (Watts)	Frequency† F1/ upper useful (MHz)	Power Gain*	Cooling	EIMAC Type Number	Tube Type
16,000	10,000	100 / 220	x1050	air	4CX10,000D	Tetrode
16,000	10,000	100 / 220	x1050	water	4CW10,000A	Tetrode
16,000	5000	100 / 220	x1050	air	4CX5000R	Tetrode
11,000	3000	150 / 220	x260	air	4CX3000A	Tetrode
10,000	4000	75 / 150	x73	air	3CX2500A3	Triode
10,000	4000	75 / 150	x73	air	3CX2500F3	Triode
10,000	5000	75 / 150	x73	water	3CW5000A3	Triode
10,000	5000	75 / 150	x73	water	3CW5000F3	Triode
8500	3000	150 / 220	x160	air	5CX3000A	Pentode
3400	1000	110 / —	x225	air	4-1000A	Tetrode
3200	1500	110 / 220	x350	air	4CX1500A	Tetrode
3180	1500	110 / 220	x350	air	5CX1500A	Pentode
2600§	1500	250 / —	x33	air	3CX1500A7	Triode <sup>1</sup>
1500§§	1500	500 / —	x30	air	8938	Triode <sup>1</sup>
1265	500	110 / —	x140	air	4-500A	Pentode
1100	400	110 / —	x190	air	4-400C	Tetrode
1000	250	110 / —	x190	air	4-250A	Tetrode
840	350	100 / 150	x31	air	5867A	Triode
805	250	60 / —	x9	air	6569	Triode <sup>1</sup>
805	500	110 / —	x67	air	4-500A	Tetrode
745	400	60 / —	x8	air	6580	Triode <sup>1</sup>
680	1500	— / 900	x10	air	8962	Triode <sup>2</sup>
600	300	110 / 220	x158	air	4CX300Y	Tetrode
500	300	500 / —	x177	air	4CX300A	Tetrode
450	350	500 / —	—	air	8930	Tetrode
380	250	500 / —	x190	conduction	4CS250R	Tetrode
380	250	500 / —	x130	air	4CX250BC	Tetrode
380	250	500 / —	x130	air	4CX250FG	Tetrode
380	250	500 / 1500	x130	air	4CX250K	Tetrode
380	250	500 / 1500	x130	air	4CX250M	Tetrode
380	250	500 / —	x190	air	4CX250R	Tetrode
380	250	150 / 500	x130	air	4X150A	Tetrode
380	250	150 / 500	x130	air	7609	Tetrode
380	250	500 / —	x130	conduction	8560A	Tetrode
375	125	120 / —	x150	air	4-125A	Tetrode
320	200	500 / —	x35	conduction	8873	Triode
320	400	500 / —	x35	air	8874	Triode
320	300	500 / —	x35	air	8875	Triode
270	65	150 / —	x160	convection	4-65A	Tetrode
216	400	1000 / —	11.5	air	3CX400U7	Triode <sup>2</sup>
100	115	1215 / —	x27 @ 400 MHz	air	6816	Tetrode
100	115	1215 / —	x27 @ 400 MHz	air	6884	Tetrode
100	115	1215 / —	x27 @ 400 MHz	air	7457	Tetrode
100	115	1215 / —	x27 @ 400 MHz	conduction	7843	Tetrode

\* Power output and power gain are calculated or measured at low frequency.

† F1 is the maximum frequency at which maximum ratings apply. Operation at the upper useful frequency normally involves operation at reduced anode voltage and reduced plate input power.

§ Power output shown is measured useful, delivered to load, at 104 MHz.

§ § Useful power output, measured at 430 MHz

1. Grounded grid

2. 900 MHz



# RF POWER AMPLIFIER

## Class C – Plate Modulated Service

Carrier Pwr. Output Typical*	Plate Diss. at Typical Conditions	Frequency† F1 / upper useful	Power Gain*	Cooling	EIMAC Type Number	Tube Type
(kW - W)	(kW - W)	(MHz)				
1375 kW	800 kW	30 / 50	x200	water	X-2159	Tetrode
700 kW	160 kW	50 / 100	x290	water	X-2170	Tetrode
285 kW	119 kW	30 / 50	x120	vapor	4CV250,000A	Tetrode
285 kW	119 kW	30 / 50	x120	water	4CW250,000A	Tetrode
140 kW	47 kW	30 / 50	x110	vapor	4CV100,000C	Tetrode
140 kW	35 kW	108 / 150	x260	water	4CW100,000E	Tetrode
138 kW	22 kW	30 / 50	x160	water	4CW100,000D	Tetrode
110 kW	22 kW	110 / 220	x160	water	4CW50,000E	Tetrode
110 kW	22 kW	110 / 220	x160	vapor	4CV50,000E	Tetrode
60 kW	20 kW	40 / 80	x30	water	6696A	Triode
60 kW	20 kW	40 / 80	x30	air	6697A	Triode
60 kW	20 kW	40 / 80	x30	vapor	7480	Triode
55 kW	13 kW	30 / 50	x440	air	4CX35,000C	Tetrode
27.5 kW	7.5 kW	90 / 150	x18	air	3CX20,000A3	Triode
27.5 kW	7.5 kW	90 / 150	x18	air	3CX20,000H3	Triode
23.5 kW	5.8 kW	110 / 225	x155	air	4CX15,000A	Tetrode
23.5 kW	5.8 kW	110 / 225	x155	vapor	4CV35,000A	Tetrode
18.0 kW	5.4 kW	100 / 150	x37	air	3CX15,000A3	Triode
12.4 kW	2.6 kW	140 / 200	x24	air	3CX10,000A3	Triode
8500 W	3500 W	100 / 220	x230	air	4CX10,000D	Tetrode
8500 W	3500 W	100 / 220	x230	air	4CX5000A	Tetrode
8500 W	3500 W	100 / 220	x230	air	4CX5000R	Tetrode
5750 W	1250 W	150 / 220	x190	air	4CX3000A	Tetrode
5300 W	950 W	75 / 150	x45	air	3CX2500A3	Triode
5300 W	950 W	75 / 150	x45	air	3CX2500F3	Triode
2630 W	670 W	110 / —	x290	air	4-1000A	Tetrode
2320 W	780 W	110 / 220	x230	air	4CX1500A	Tetrode
1960 W	575 W	110 / 220	x195	air	5CX1500A	Pentode
1765 W	485 W	110 / —	x50	air	3-1000Z	Triode
830 W	245 W	110 / —	x140	air	4-500A	Tetrode
785 W	280 W	110 / —	x110	air	5-500A	Pentode
640 W	185 W	110 / —	x25	air	3-500Z	Triode
630 W	195 W	110 / —	x190	air	4-400C	Tetrode
510 W	165 W	110 / —	x160	air	4-250A	Tetrode
300 W	80 W	120 / —	x90	air	4-125A	Tetrode
300 W	200 W	110 / 220	x175	air	4CX300 Y	Tetrode
270 W	280 W	500 / —	—	air	8930	Tetrode
235 W	65 W	500 / —	x160	conduction	4CS250R	Tetrode
235 W	65 W	500 / —	x135	air	4CX250BC	Tetrode
235 W	65 W	500 / —	x135	air	4CX250F	Tetrode
235 W	65 W	500 / 1500	x135	air	4CX250K	Tetrode
235 W	65 W	500 / 1500	x135	air	4CX250M	Tetrode
235 W	65 W	500 / —	x160	air	4CX250R	Tetrode
235 W	65 W	500 / —	x135	air	4CX300A	Tetrode
235 W	65 W	150 / 500	x135	air	4X150A	Tetrode
235 W	65 W	150 / 500	x135	air	7609	Tetrode
235 W	65 W	500 / —	x135	conduction	8560A	Tetrode
210 W	45 W	150 / —	x65	convection	4-65A	Tetrode
45 W	45 W	1215 / —	x15 @ 400 MHz	air	6884	Tetrode
45 W	45 W	1215 / —	x15 @ 400 MHz	air	7457	Tetrode
45 W	45 W	1215 / —	x15 @ 400 MHz	conduction	7843	Tetrode

\* Power output and power gain are calculated or measured at low frequency.

† F1 is the maximum frequency at which maximum ratings apply. Operating at the upper useful frequency normally involves operation at reduced anode voltage and reduced plate input power.

# OSCILLATOR OR AMPLIFIER

## Class C – Industrial Service

Plate Pwr. Output Typical* (kW)	Rated Plate Diss. (kW)	Filament Heating Power (Watts)	Frequency† F1 / upper useful (MHz)	Cooling	EIMAC Type Number	Tube Type
1800	1000	26640	30 / 60	water	X-2176	Triode
900	500	13320	30 / 60	water	X-2177	Triode
80	60	2665	40 / 80	water	6696A	Triode
80	35	2665	40 / 80	air	6697A	Triode
80	80	2665	40 / 80	vapor	7480	Triode
70	40	1600	90 / —	water	3CW40,000H3	Triode
60	20	1600	90 / —	air	3CX20,000H3	Triode
42	30	1020	90 / —	water	3CW30,000H3	Triode
42	30	1020	100 / —	vapor	3CV30,000H3	Triode
41.2	15	1020	90 / —	air	3CX15,000H3	Triode
29	10	742	90 / —	air	3CX10,000H3	Triode
28	20	742	90 / —	water	3CW20,000H3	Triode
20.6	10	566	90 / —	water	3CW10,000H3	Triode
18.6	5	566	90 / —	air	3CX5000H3	Triode
10	5	379	75 / 150	water	3CW5000H3	Triode
5	2.5	379	75 / 150	air	3CX2500A3/F3/H3	Triode
1.2	0.3	125	40 / 80	air	304TL	Triode
0.68	0.35	70	100 / —	air	5867A	Triode

\* Calculated or measured at low frequency.

† F1 is the maximum frequency at which maximum ratings apply. Operation at the upper useful frequency normally involves operation at reduced anode voltage and reduced plate input power.

# VOLTAGE OR CURRENT

## REGULATOR SERVICE

Maximum Pass Current (A <sub>dc</sub> )	Maximum Hold-off Voltage (kV <sub>dc</sub> )	Minimum Tube Drop (V <sub>dc</sub> )	Rated Anode Diss. (kW)	Cooling	EIMAC Type Number	Tube Type
300	40	3000	1250	water	X-2159	Tetrode
150	40	2500	650	water	X-2170	Tetrode
50	40	4400	250	water	4CW250,000A	Tetrode
35	40	2700	100	water	4CW100,000E	Tetrode
30	40	3300	100	water	4CW100,000D	Tetrode
15	35	3000	50	water	4CW50,000E	Tetrode
15	40	2200	35	air	4CX35,000C	Tetrode
7.5	10	1500	20	water	3CW20,000A1	Triode
7.5	20	1200	20	water	3CW20,000A7	Triode
7	10	1300	12	air	3CX10,000A1	Triode
6	20	800	25	water	4CW25,000A	Tetrode
4	20	500	15	air	3CX15,000A7	Triode
4	15	2000	10	water	4CW10,000A	Tetrode
3	12	1300	5	water	3CW5000A1	Triode
2	12	1000	3	air	3CX3000F1	Triode
2	6	1000	2	water	4CW2000A	Tetrode
1	8	250	1.5	air	3CX1500A7	Triode
1	6	500	1	air	4CX1000A	Tetrode
1	6	500	0.8	water	4CW800B	Tetrode
1	6	500	0.8	water	4CW800F	Tetrode
0.8	4.5	300	0.4	air	8874	Triode
0.8	4.5	300	0.3	air	8875	Triode
0.8	4.5	300	0.2	convection	8873	Triode
0.6	30	500	1	air	4PR1000A	Tetrode
0.6	8	400	0.5	air	3-500Z	Triode
0.2	20	1800	0.4	air	4PR400A	Tetrode
0.2	50	1000	0.25	air	4PR250C	Tetrode
0.1	18	1200	0.125	air	4PR125A	Tetrode
0.1	15	500	0.065	convection	4PR65A	Tetrode

# RF POWER AMPLIFIER

## Grid Pulsed Service

Peak RF Pwr. Output Typical $\beta$ (kW)	Rated Anode Diss. (kW)	Frequency† F1 / upper useful (MHz)	Maximum Anode Voltage (kVdc)	Maximum Anode Current $\beta$ (A)	Cooling	EIMAC Type Number	Tube Type
3900	1250	30 / 50	30	195	water	X-2159	Tetrode
2000	650	50 / 100	30	100	water	X-2170	Tetrode
1000	100	108 / 150	30	50	water	4CW100,000E	Tetrode
500	50	110 / 220	30	33	vapor	4CV50,000E	Tetrode
500	50	110 / 220	30	33	water	4CW50,000E	Tetrode
160	15	110 / 225	12	20	air	4CX15,000A	Tetrode
80	10	110 / 220	10	13	air	4CX10,000D	Tetrode
80	10	110 / 220	10	13	air	4CX5000A	Tetrode
80	10	100 / 220	10	13	air	4CX5000R	Tetrode
35	1.5	— / 500	20	8	air	3CPX1500A7	Triode
34	1.0	110 / —	15	3.5	air	4PR1000A	Tetrode
28*	0.25	500 / 1500	7	6.0	air	4CPX250K	Tetrode
28*	0.25	500 / 1500	7	6.0	air	4CX250K	Tetrode
28*	0.25	500 / 1500	7.0	6.0	air	4CX250M	Tetrode
26	1500	500 / —	5	8	air	8938	Triode
11	0.40	110 / —	10	1.7	air	4PR400A	Tetrode
10‡	0.25	500 / 1500	5.5	0.8	air	4CPX250K	Tetrode
4.0	0.125	120 / —	9.0	0.7	air	4PR125A	Tetrode
2.6	0.300	110 / 220	3.0	1.3	air	4CX300Y	Tetrode
2.0	0.065	150 / —	7.5	0.4	convection	4PR65A	Tetrode
1.6	0.20	500 / —	3.0	0.8	conduction	8873	Triode
1.6	0.40	500 / —	3.0	0.8	air	8874	Triode
1.6	0.30	500 / —	3.0	0.8	air	8875	Triode
1.6	0.25	500 / —	3.0	0.8	air	4CX250B <sub>1</sub>	Tetrode
1.6	0.25	500 / —	3.0	0.8	air	4CX250F <sub>1</sub>	
1.6	0.25	500 / 1500	3.0	0.8	air	4CX250K <sub>1</sub>	
1.6	0.25	500 / 1500	3.0	0.8	air	4CX250M <sub>1</sub>	

$\beta$  Average during the pulse. Power output data is anode power (does not include circuit losses), calculated or measured at low frequency.

† F1 is the maximum frequency at which maximum ratings apply. Operation at the upper useful frequency normally involves operation at reduced anode voltage and reduced anode power input.

\* Anode and screen-grid pulsed

‡ Cathode driven, screen pulsed

# AF POWER AMPLIFIER

## OR

# MODULATOR SERVICE

AF Pwr. Output Typical* (2 tubes) (kW - W)	Typical* Plate Diss. Per Tube (kW - W)	Class of Service	Driving Power (2 tubes)	Cooling	EIMAC Type Number	Tube Type
1900 kW	420 kW	AB1	0	water	X-2159	Tetrode
950 kW	210 kW	AB1	0	water	X-2170	Tetrode
660 kW	260 kW	AB1	0	vapor	4CV250,000A	Tetrode
660 kW	260 kW	AB1	0	water	4CW250,000A	Tetrode
246 kW	57 kW	AB1	0	vapor	4CV100,000C	Tetrode
246 kW	57 kW	AB1	0	water	4CW100,000D	Tetrode
200 kW	46 kW	AB1	0	water	4CW100,000E	Tetrode
195 kW	42 kW	AB1	0	water	4CW50,000E	Tetrode
195 kW	42 kW	AB1	0	vapor	4CV50,000E	Tetrode
195 kW	42 kW	AB1	0	vapor	4CV50,000J	Tetrode
195 kW	42 kW	AB1	0	water	4CW50,000J	Tetrode
152 kW	44 kW	AB2	600	water	6696A	Triode
152 kW	44 kW	AB2	600	air	6697A	Triode
152 kW	44 kW	AB2	600	vapor	7480	Triode
70 kW	20 kW	AB1	0	air	4CX35,000C	Tetrode
66 kW	20.5 kW	AB1	0	vapor	4CV35,000A	Tetrode
57 kW	14 kW	AB1	0	water	4CW25,000A	Tetrode
57 kW	14 kW	AB1	0	air	4CX15,000A	Tetrode
31.9 kW	9 kW	AB1	0	air	4CX10,000D	Tetrode
29.1 kW	10 kW	AB1	0	air	3CX10,000A1	Triode
29.1 kW	10 kW	AB1	0	water	3CW20,000A1	Triode
17.5 kW	4.2 kW	AB1	0	air	4CX5000A	Tetrode
17.5 kW	4.2 kW	AB1	0	air	4CX5000R	Tetrode
1.45 kW	4.75 kW	AB1	0	vapor	4CV8000A	Tetrode
13.0 kW	2.5 kW	B	113	water	3CW5000A3	Triode
13.0 kW	2.5 kW	B	113	air	3CX2500A3	Triode
13.0 kW	2.5 kW	B	113	air	3CX2500F3	Triode
13.0 kW	2.5 kW	B	113	water	3CW5000F3	Triode
11.4 kW	3.3 kW	AB1	0	air	4CX3000A	Tetrode
10.0 kW	2.95 kW	AB1	0	water	3CW5000A1	Triode
10.0 kW	2.95 kW	AB1	0	water	3CW5000F1	Triode
10.0 kW	2.95 kW	AB1	0	air	3CX3000A1	Triode
10.0 kW	2.95 kW	AB1	0	air	3CX3000F1	Triode
3.9 kW	900 W	AB2	4.7	air	4-1000A	Tetrode
3.22 kW	920 W	AB1	0	air	5CX1500A	Pentode
3.2 kW	920 W	AB1	0	air	4CX1500A	Tetrode
1.72 kW	500 W	AB1	0	air	4-500A	Tetrode
1.66 kW	458 W	AB1	0	air	5-500A	Pentode
1.75 kW	400 W	AB2	3.5	air	4-400C	Tetrode
1.42 kW	445 W	AB2	25	air	3-500Z	Triode
1.31 kW	340 W	B	26	air	3-400Z	Triode
1.04 kW	190 W	AB2	1.9	air	4-250A	Tetrode
800 W	225 W	AB1	0	air	4CX300A	Tetrode
780 W	350 W	AB1	0	air	8930	Tetrode
600 W	200 W	AB1	0	air	{ 4CX250BC 4CX250F 4X150A 7609 }	Tetrode
400 W	125 W	AB2	1.0	air	4-125A	Tetrode
270 W	63 W	AB2	1.3	air	4-65A	Tetrode

\* Measured in watts, unless otherwise specified.

# SWITCH TUBE OR PULSED REGULATOR SERVICE

Peak Anode Current (A)	Maximum Hold-off Voltage (kVdc)	Rated Anode Diss. (kW)	Cooling	EIMAC Type Number	Tube Type
780	60	1250	water	X-2159	Tetrode
400	60	650	water	X-2170	Tetrode
300	40	250	water	4CW250,000A	Tetrode
150	75	35	air	Y-546	Tetrode <sup>1</sup>
150	75	100	water	Y-647	Tetrode <sup>2</sup>
150	40	100	water	4CW100,000D	Tetrode
150	75	100	water	Y-676	Tetrode <sup>3</sup>
150	40	100	water	4CW100,000E	Tetrode
150	40	35	air	4CX35,000C	Tetrode
130	25	60	water	6696A	Triode
130	25	35	air	6697A	Triode
100	50	5	air	X-2187	Triode <sup>4</sup>
100	35	50	water	4CW50,000E	Tetrode
100	35	50	vapor	4CV50,000E	Tetrode
70	20	25	water	4CW25,000A	Tetrode
60	20	15	air	4CX15,000A	Tetrode
60	30	15	air	Y-456	Tetrode <sup>5</sup>
50	30	25	water	Y-569	Tetrode <sup>6</sup>
50	15	1.5	air	3CPX1500A7	Triode
40	15	10	air	4CX10,000D	Tetrode
40	18	5	air	Y-573	Pentode <sup>7</sup>
40	18	3	air	Y-574	Pentode <sup>8</sup>
40	20	6.0	water	Y-633	Tetrode <sup>9</sup>
40	20	20	water	3CW20,000A7	Triode
40	15	5	air	4CX5000A	Tetrode
40	15	5	air	4CX5000R	Tetrode
40	25	10	water	Y-442	Tetrode <sup>10</sup>
25	20	3	air	4CX3000A	Tetrode
18	20	0.06	air	4PR60C	Tetrode
15	10	3	air	3CX3000F7	Triode
12	12	1	air	Y-575	Pentode <sup>11</sup>
12	4	0.6	air	4CX600B/F	Tetrode
12	4	0.8	water	4CW800B/F	Tetrode
12	25	0.75	air	8941	Planar Triode
12	20	0.75	air	8942	Planar Triode
12	6.5	0.75	air	8940	Planar Triode
10	50	1.0	air	8960	Tetrode
10	7	1.5	air	4CX1500A	Tetrode
8	30	1.0	air	4PR1000A	Tetrode
8	40	1.0	air	Y-364	Tetrode <sup>12</sup>
8	7.5 (oil)	0.6	air or oil	8954	Tetrode
6	12	0.15	air	Y-518	Planar Triode
6	7	0.25	air	4CPX250K	Tetrode
6	4	0.15	air	Y-519	Planar Triode
5	12	0.15	air	Y-540	Planar Triode

1. Specially processed 4CX35,000C

4. Focused oxide cathode

7. Specially processed Type 290

10. Specially processed 4CX5000R

2. Specially processed 4CW100,000D

5. Specially processed 4CX15,000A

8. Specially processed Type 8576/264

11. Specially processed 8295A

3. Specially processed 4CW100,000E

6. Prototype: 4CW25,000A

9. Prototype: 4CX5000R

12. Specially processed 4PR1000A

SWITCH TUBE OR PULSED REGULATOR SERVICE, CONTINUED

Peak Anode Current (A)	Maximum Hold-off Voltage (kVdc)	Rated Anode Diss. (Watts)	Cooling	EIMAC Type Number	Tube Type
5	10	150	air	8755	Planar Triode
5	4	150	air	8847	Planar Triode
5	3.5	100	air	7211	Planar Triode
5	3.5	150	air	8757	Planar Triode
5	3.5	100	air	8403	Planar Triode
4	50	250	air	4PR250C	Tetrode
4	20	400	air	4PR400A	Tetrode
3	10	400	air	Y-504	Triode <sup>13</sup>
3	4.5	100	air	7815RAL	Planar Triode
3	3.5	100	air	7815R	Planar Triode
3	3.5	100	air	7855	Planar Triode
3	3.5	150	air		Planar Triode
2.1	18	125	air	4PR125A	Tetrode
1.5	4.5	100	air	8745	Planar Triode
1.2	15	65	convection	4PR65A	Tetrode

13. Specially processed 3-400Z

## EIMAC PLANAR TRIODES

EIMAC planar triodes provide greater power, higher efficiency and more reliability than "standard" designs. Many EIMAC planars include internal shielding to reduce degradation effects caused by cathode sublimation. Other types feature a cool cathode to provide long tube life. A broad choice of anodes is available for a wide selection of cooling techniques. High quality and rigid inspection of all planars provide low failure rate and low cost per tube operating hour.

You are not limited by listed planar types. EIMAC's Application Engineering Department is ready to help you design planars into your equipment, or to propose new planar designs to glove-fit your requirements. Write for our planar triode brochure or contact Product Manager, EIMAC division of Varian, 1678 South Pioneer Road, Salt Lake City, Utah 84104. Phone: (801) 487-7561.

### 2C39A, 2C39BA, 2C39WA, 3CX100A5, 7289

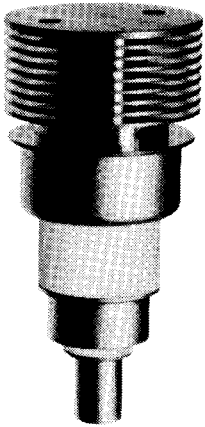

These ceramic/metal planar UHF triodes are usable to 3000 MHz as power amplifiers, oscillators, or frequency multipliers. Narrow mechanical tolerances and exacting electrical testing assure tube-to-tube uniformity.

Of these types, only the 7289 is now recommended for Military equipment usage, and is specified as the replacement to be used in older equipments originally supplied with 2C39A, 2C39WA, or 3CX100A5.

The 2C39BA is specially tested for emission and control characteristics, for applications which are unusually sensitive to these parameters.

All the types are identical in appearance and dimensionally the same.

#### CHARACTERISTICS

Plate Dissipation (Max.)	100 watts
Grid Dissipation (Max.)	2 watts
Frequency for Max. Ratings (CW)	2500 MHz
(Pulsed)	3000 MHz
Cooling	Forced Air
Cathode	Oxide-coated Unipotential
Heater: Voltage (2C39A)	6.3 volts
(remaining types)	6.0 volts
Current (2C39A)	1.03 amperes
(remaining types)	1.00 ampere
Capacitances: Grid-Cathode	.63 pF
Grid-Plate	2.01 pF
Plate-Cathode	0.035 pF
Amplification Factor (Mu)	100
Transconductance (Sm)	25 mmhos
Base	Special, Coaxial
Socket	Special
Maximum Seal & Anode Core Temperature	250°C
Maximum Length	2.70 in; 68.60 mm
Maximum Diameter	1.27 in; 32.20 mm
Weight (approximate)	2.5 oz; 71 gm
Operating Position (all types)	Any

Class of Operation	Type of Service	MAXIMUM RATINGS			TYPICAL OPERATION					
		Plate Voltage (volts)	Plate Current (amps)	Cathode Current (amps)	Freq. (MHz)	Plate Voltage (volts)	Plate Current (amps)	Duty	Pulse Length (μs)	Output Power (watts)
C	RF Amp. or Osc.	1000	0.100	0.125	500	900	0.09	—	—	40*
C	RF Amp. or Osc.	1000	0.100	0.125	2500	900	0.09	—	—	17*
C	Plate Modulated RF Amp. or Osc.	600	0.100	0.125	500	600	0.065	—	—	16*

\*Useful Power Output, delivered to the load.



Planar Triodes  
**7815, 7815AL,**  
**7815RAL, 8745/7815R**

These ceramic/metal planar UHF triodes are intended for pulse and high altitude applications. Electrically similar to the 7289, they feature a longer grid-anode ceramic insulator with a higher voltage breakdown rating. Pulse ratings apply to 70,000 feet altitude, making these tubes especially suitable for airborne applications.

The 7815 and 7815AL are identical except for special tests performed on the 7815AL to prove reliability in airline DME and transponder usage. Both have a knurled-knob anode assembly.

The 7815RAL, and 8745/7815R have a 100-watt transverse cooler on the anode, and are identical except for special high-voltage processing and testing on the 8745/7815R.

**CHARACTERISTICS**

Plate Dissipation (Max.) (7815 & 7815AL) . . .10 watts  
 Plate Dissipation (Max.) (8745/7815R) . . .100 watts  
 Grid Dissipation (Max.) . . . . . 2 watts  
 Frequency for Max. Ratings (Pulsed) . . . . 3000 MHz  
 Cooling (7815 & 7815AL) Conduction or Forced Air  
 Cooling (8745/7815R, 7815RAL) . . . . . Forced Air  
 Cathode . . . . . Oxide-coated Unipotential  
 Heater: Voltage (7815AL) . . . . . .5.7 volts  
 (remaining types) . . . . . .6.0 volts  
 Current (7815AL) . . . . . 0.95 ampere  
 (remaining types) . . . . . 1.00 ampere  
 Capacitances: Grid-Cathode . . . . . .6.3 pF  
 Grid-Plate . . . . . .1.98 pF  
 Plate-Cathode . . . . . 0.025 pF  
 Amplification Factor (Mu) . . . . . 100  
 Transconductance (Sm) . . . . . 25 mmhos  
 Base . . . . . Special, Coaxial  
 Socket . . . . . Special  
 Maximum Seal & Anode Core Temperature . .250°C  
 Maximum Length (all types) . . . .2.70 in; 68.60 mm  
 Maximum Diameter:  
 (7815 & 7815AL) . . . . .1.20 in; 30.50 mm  
 (8745/7815R, 7815RAL) . . . .1.27 in; 32.20 mm  
 Weight (approximate):  
 (7815 & 7815AL) . . . . .1.8 oz; 51 gm  
 (8745/7815R, 7815RAL) . . . . .2.5 oz; 71 gm  
 Operating Position (all types) . . . . . Any

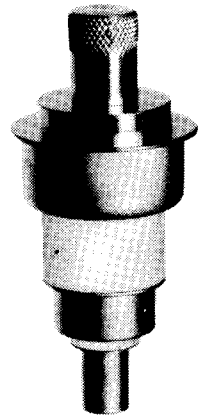

7815  
7815AL

Class of Operation	Type of Service	MAXIMUM RATINGS			TYPICAL OPERATION					
		Plate Voltage (volts)	Plate Current (amps)	Cathode Current (amps)	Freq. (MHz)	Plate Voltage (volts)	Plate Current (amps)	Duty	Pulse Length (μs)	Output Power (watts)
C	Grid-pulsed Amp. or Osc.	2500	3.0	4.8	1100	2200	1.9	0.002	3	2000*
C	Plate-pulsed Amp. or Osc.	3500	3.0	4.8	3000	3500	3.0	0.0033	6	1600*

**TYPE 8745 ONLY**

C	Grid-pulsed Amp. or Osc.	3500	3.0	4.8	1100	2200	1.9	0.002	3	2000*
C	Plate-pulsed Amp. or Osc.	4500	3.0	4.8	3000	3500	3.0	0.0025	3	1600*

\*Useful Power Output, delivered to the load.

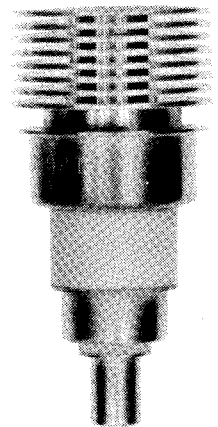

8745/7815R,  
7815RAL

**Planar Triodes**  
**7855, 7855KAL,**  
**Y-503**

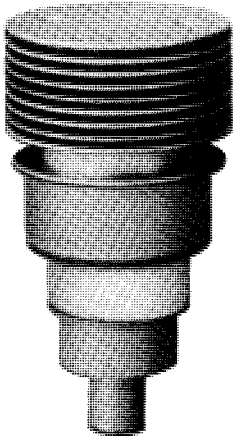

7855

These ceramic/metal planar UHF triodes feature rugged design, high transconductance and high  $\mu$ , a frequency-stable anode, and an arc-resistant cathode, all to assure stable operation under adverse conditions and minimize catastrophic failure due to an arc during circuit malfunction.

Test evaluation of the 7855KAL is based on the operating conditions found in commercial airborne applications, such as transponders, emphasizing cathode emission capability at reduced heater voltage and high-voltage holdoff.

The 7855 has a 100-watt transverse cooler, while the 7855KAL includes a knurled-knob anode assembly and is rated for lower plate dissipation.

The Y-503 is a 7855 with a threaded anode shank, to allow conduction, heat-sink, or liquid cooling.

**CHARACTERISTICS**

- Plate Dissipation (Max.) (7855) . . . . . 100 watts
- Plate Dissipation (Max.) (7855KAL) . . . . . 10 watts
- Plate Dissipation (Max.) (Y-503) . . . . . Dependent on Cooling Technique
- Grid Dissipation (Max.) . . . . . 2 watts
- Frequency for Max. Ratings (CW) . . . . . 2500 MHz (Pulsed) . . . . . 3000 MHz
- Cooling (7855) . . . . . Forced Air
- Cooling (7855KAL) . . . . . Conduction or Forced Air
- Cooling (Y-503) . . . . . Technique Optional
- Cathode . . . . . Oxide-coated Unipotential
- Heater: Voltage (7855 & Y-503) . . . . . 6.0 volts (7855 KAL) . . . . . 5.7 volts
- Current (7855 & Y-503) . . . . . 1.0 ampere (7855KAL) . . . . . 0.95 ampere
- Capacitances: Grid-Cathode . . . . . 6.8 pF
- Grid-Plate . . . . . 2.5 pF
- Plate-Cathode . . . . . 0.035 pF
- Amplification Factor ( $\mu$ ) . . . . . 80
- Transconductance ( $S_m$ ) . . . . . 25 mmhos
- Base . . . . . Special, Coaxial
- Socket . . . . . Special
- Maximum Seal & Anode Core Temperature . . 250° C
- Maximum Length: (7855 & 7855KAL) . . . . . 2.40 in; 60.96 mm (Y-503) . . . . . 1.81 in; 45.97 mm
- Maximum Diameter (7855) . . . . . 1.27 in; 32.20 mm (7855KAL) . . . . . 1.20 in; 30.50 mm (Y-503) . . . . . 0.79 in; 20.00 mm
- Operating Position (all types) . . . . . Any
- Weight (approximate) (7855) . . . . . 2.0 oz; 57 gm (7855KAL) . . . . . 1.4 oz; 40 gm (Y-503) . . . . . 0.65 oz; 18 gm
- Operating Position (all types) . . . . . Any

Class of Operation	Type of Service	MAXIMUM RATINGS			TYPICAL OPERATION					
		Plate Voltage (volts)	Plate Current (amps)	Cathode Current (amps)	Freq. (MHz)	Plate Voltage (volts)	Plate Current (amps)	Duty	Pulse Length ( $\mu$ s)	Output Power (watts)
C	Grid-pulsed Amp. or Osc.	2500	3.0	4.5	1100	2000	1.3	0.001	0.5	750*
C	Plate-pulsed Amp. or Osc.	3500	3.0	4.5	—	—	—	—	—	—

\*Useful Power Output, delivered to the load.

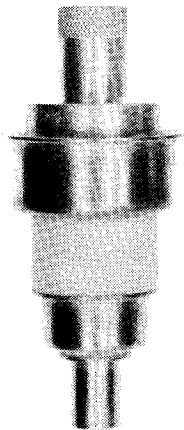

7855KAL



Y-503

# Planar Triodes 7211, 7698

These ceramic/metal planar UHF triodes feature a large cathode area and a long grid-plate ceramic insulator, resulting in higher current ratings and making them useful in pulse service and high altitude environments. Features are high  $\mu$ , high transconductance, great mechanical strength, and an arc-resistant extended interface cathode to assure long and reliable life under adverse conditions.

The 7211 and 7698 are identical except for the installation of a 100-watt transverse cooler on the anode of the 7211, while the 7698 carries a knurled-knob assembly on its anode.

## CHARACTERISTICS

Plate Dissipation (Max.) (7211)	100 watts
Plate Dissipation (Max.) (7698)	10 watts
Grid Dissipation (Max.) (both types)	2 watts
Frequency for Max. Ratings (CW)	2500 MHz
(Pulsed)	3000 MHz
Cooling (7211)	Forced Air
Cooling (7698)	Conduction or Forced Air
Cathode	Oxide-coated Unipotential
Heater: Voltage	6.3 volts
Current	1.3 amperes
Capacitances: Grid-Cathode	8.0 pF
Grid-Plate	2.25 pF
Plate-Cathode	0.06 pF
Amplification Factor ( $\mu$ )	80
Transconductance ( $S_m$ )	30 mmhos
Base	Special, Coaxial
Socket	Special
Maximum Seal & Anode Core Temperature	250°C
Maximum Length (both types)	2.70 in; 68.60 mm
Maximum Diameter (7211)	1.27 in; 32.20 mm
(7698)	1.20 in; 30.50 mm
Weight (approximate) (7211)	0.22 oz; 63 gm
(7698)	0.16 oz; 48 gm
Operating Position (both types)	Any

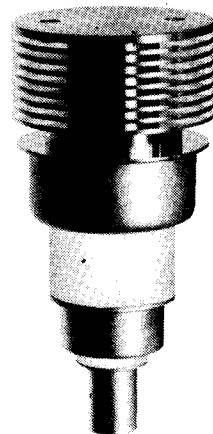

7211

Class of Operation	Type of Service	MAXIMUM RATINGS			TYPICAL OPERATION					
		Plate Voltage (volts)	Plate Current (amps)	Cathode Current (amps)	Freq. (MHz)	Plate Voltage (volts)	Plate Current (amps)	Duty	Pulse Length ( $\mu$ s)	Output Power (watts)
C	RF Amp. (gnd. grid)	2500	0.150	0.190	700	630	0.140	—	—	45*
C	RF Osc. (gnd. grid)	2500	0.150	0.190	2500	1000	0.140	—	—	30*
C	Grid-pulsed Amp. or Osc.	2500	5.0	7.5	1100	2200	2.5	0.002	3	2500†
C	Plate-pulsed Amp. or Osc.	3500	5.0	7.5	3000	3500	4.8	0.0025	3	3000†

\*Useful Power Output, delivered to the load.

† Useful Pulse Power, delivered to the load.

**7289** see 2C39A

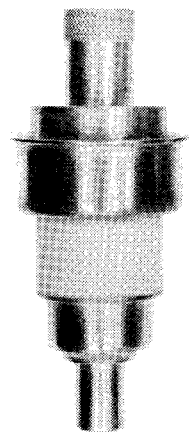

7698  
(see 7211)

**Planar Triodes**  
**8403**

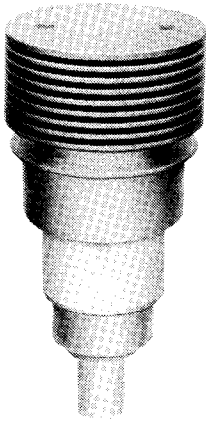

The 8403 is a rugged, high-mu planar triode of ceramic/metal construction, for use as a grid-pulsed, plate pulsed, or CW oscillator, frequency multiplier, or amplifier up to 3000 MHz.

The tube incorporates a frequency-stable anode and a cathode designed for high current capability.

**CHARACTERISTICS**

Plate Dissipation (Max.)	100 watts
Grid Dissipation (Max.)	2 watts
Frequency for Max. Ratings (CW)	2500 MHz
(Pulsed)	2000 MHz
Cooling	Forced Air
Cathode	Oxide-coated Unipotential
Heater: Voltage	.6.3 volts
Current	.1.3 amperes
Capacitances: Grid-Cathode	.8.0 pF
Grid-Plate	.3.1 pF
Plate-Cathode	.0.065 pF
Amplification Factor (Mu)	.80
Transconductance (Sm)	.30 mmhos
Base	Special, Coaxial
Socket	Special
Maximum Seal & Anode Core Temperature	.250°C
Maximum Length	.2.39 in; 60.60 mm
Maximum Diameter	.1.27 in; 32.20 mm
Weight (approximate)	.2.0 oz; 57 gm
Operating Position	.Any

Class of Operation	Type of Service	MAXIMUM RATINGS			TYPICAL OPERATION					
		Plate Voltage (volts)	Plate Current (amps)	Cathode Current (amps)	Freq. (MHz)	Plate Voltage (volts)	Plate Current (amps)	Duty	Pulse Length (μs)	Output Power (watts)
C	RF Amp. or Osc.	1000	0.150	0.190	2500	900	0.140	—	—	25*
C	Grid-pulsed Amp. or Osc.	2500	5.0	7.5	1090	2000	4.0	0.005	0.5	1000†
C	Plate-pulsed Amp. or Osc.	3000	5.0	7.5	3000	3500	5.0	0.0025	3	2000†

\*Useful Power Output, delivered to the load.

† Useful Pulse Power, delivered to the load.

**8533, 8533W**

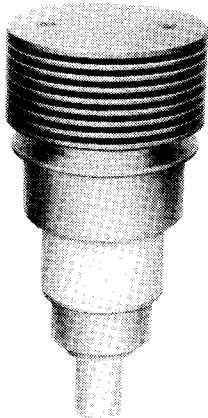

The 8533 is a planar triode designed for use as a grid or plate pulsed oscillator, amplifier, frequency multiplier, or switch tube at high plate voltage.

The design incorporates an extended grid-to-anode ceramic insulator and a matrix cathode of the arc-resistant extended-interface type, permitting reliable operation up to 8 kVdc in RF or pulse modulator applications.

The 8533W is identical to the 8533 except that the four lower radiator fins have a maximum diameter of 1.13 in. (28.7 mm) as opposed to the normal diameter of 1.27 in. (32.11mm).

**CHARACTERISTICS**

Plate Dissipation (Max.)	100 watts
Grid Dissipation (Max.)	1.5 watts
Frequency for Max. Ratings (Pulsed)	3000 MHz
Cooling	Forced Air
Cathode	Oxide-coated Unipotential
Heater: Voltage	.6.3 volts
Current	.1.3 amperes
Capacitances: Grid-Cathode	.8.0 pF
Grid-Plate	.1.65 pF
Plate-Cathode	.0.06 pF
Amplification Factor (Mu)	.145
Nominal Cutoff Amp. Factor (Mu)	.90
Transconductance (Sm)	.30 mmhos
Base	Special, Coaxial
Socket	Special
Maximum Seal & Anode Core Temperature	.250°C
Maximum Length	.2.70 in; 68.60 mm
Maximum Diameter	.1.27 in; 32.20 mm
Weight (approximate)	.2.2 oz; 63 gm
Operating Position	.Any

Class of Operation	Type of Service	MAXIMUM RATINGS			TYPICAL OPERATION					
		Plate Voltage (volts)	Plate Current (amps)	Cathode Current (amps)	Freq. (MHz)	Plate Voltage (volts)	Plate Current (amps)	Duty	Pulse Length (μs)	Output Power (watts)
C	Grid-pulsed Amp. or Osc.	8000	5.0	7.5	1030	8000	5.0	0.0033	1	15,000†
C	Plate-pulsed Amp. or Osc.	10,000	5.0	7.5	—	—	—	—	—	—
—	Switch Tube or Pulse Modulator	8000	—	7.5	—	—	—	—	—	—

† Useful Pulse Power, delivered to the load.

**8745** see 7815

# Planar Triodes 8755, 8755A

The 8755 and 8755A are miniature ceramic/metal rugged planar triodes for advanced airborne and space applications up to 3000 MHz. The tubes are identical except the 8755A includes an internal spewing shield and will exhibit longer life in most applications.

The tubes are intended for use as an amplifier, oscillator, or frequency multiplier, either grid or plate pulsed, and may also be used in modulator or regulator service. Both tubes have a frequency-stable anode design and an arc-resistant cathode to assure stable and reliable life under adverse conditions.

Both tubes are supplied without radiator, and may be conduction, convection, heat-sink, or liquid cooled. Radiators for forced-air cooling, permitting up to 150 watts of dissipation, are available.

## CHARACTERISTICS

Plate Dissipation (Max.) . . . . . Dependent on Cooling Technique  
 Grid Dissipation (Max.) . . . . . 1.5 watts  
 Frequency for Max. Ratings (CW) . . . . . 2500 MHz  
 (Pulsed) . . . . . 3000 MHz  
 Cooling . . . . . Technique Optional  
 Cathode . . . . . Oxide-coated Unipotential  
 Heater: Voltage . . . . . 6.3 volts  
 Current . . . . . 1.3 amperes  
 Capacitances: Grid-Cathode . . . . . 9.5 pF  
 Grid-Plate . . . . . 1.05 pF  
 Plate-Cathode . . . . . 0.06 pF  
 Amplification Factor (Mu) . . . . . 135  
 Nominal Cutoff Amp. Factor (Mu) . . . . . 90  
 Transconductance (Sm) . . . . . 30 mmhos  
 Anode . Threaded stud, 3/8-24 UNF, for heat transfer;  
 Concentric flange for electrical contact.  
 Base . . . . . Special, Coaxial  
 Socket . . . . . Special  
 Maximum Seal & Anode Core Temperature . . 250°C  
 Maximum Length . . . . . 1.37 in; 34.80 mm  
 Maximum Diameter . . . . . 0.785 in; 19.94 mm  
 Weight (approximate) . . . . . 0.56 oz; 16 gm  
 Operating Position (both types) . . . . . Any

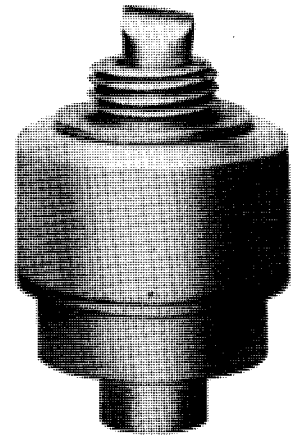

Class of Operation	Type of Service	MAXIMUM RATINGS			TYPICAL OPERATION					
		Plate Voltage (volts)	Plate Current (amps)	Cathode Current (amps)	Freq. (MHz)	Plate Voltage (volts)	Plate Current (amps)	Duty	Pulse Length (μs)	Output Power (watts)
C	Grid-pulsed Amp. or Osc.	8000	5.0	7.5	1180	1750	1.0	0.001	3.5	650†
C	Plate-pulsed Amp. or Osc.	10,000	5.0	7.5	—	—	—	—	—	—
—	Switch Tube or Pulse Modulator	8000	—	7.5	—	—	—	—	—	—

† Useful Pulse Power, delivered to the load.

# 8757

The 8757 is a miniature, frequency-stable, ceramic/metal rugged planar triode for advanced airborne and space applications up to 3500 MHz.

It may be used as an amplifier, oscillator, or frequency multiplier in the CW, grid or plate pulsed mode, as well as a modulator or regulator.

The tube has an anode designed to produce exceptional frequency stability, and an arc-resistant cathode, both assuring stable, reliable, and long-life operation under adverse conditions.

The 8757 is supplied without radiator and may be conduction, convection, heat-sink, or liquid cooled. Radiators for forced-air cooling, permitting an anode dissipation up to 150 watts, are available.

## CHARACTERISTICS

Plate Dissipation (Max.) . . . . . Dependent on Cooling Technique  
 Grid Dissipation (Max.) . . . . . 1.5 watts  
 Frequency for Max. Ratings (CW) . . . . . 3000 MHz  
 (Pulsed) . . . . . 3500 MHz  
 Cooling . . . . . Technique Optional  
 Cathode . . . . . Oxide-coated Unipotential  
 Heater: Voltage . . . . . 6.3 volts  
 Current . . . . . 1.3 amperes  
 Capacitances: Grid-Cathode . . . . . 9.0 pF  
 Grid-Plate . . . . . 1.65 pF  
 Plate-Cathode . . . . . 0.04 pF  
 Amplification Factor (Mu) . . . . . 75  
 Nominal Cutoff Amp. Factor (Mu) . . . . . 60  
 Transconductance (Sm) . . . . . 30 mmhos  
 Anode . Threaded stud, 3/8-24 UNF, for heat transfer;  
 Concentric flange for electrical contact.  
 Base . . . . . Special, Coaxial  
 Socket . . . . . Special  
 Maximum Seal & Anode Core Temperature . . 250°C  
 Maximum Length . . . . . 1.30 in; 33.00 mm  
 Maximum Diameter . . . . . 0.785 in; 19.94 mm  
 Weight (approximate) . . . . . 0.56 oz; 16 gm  
 Operating Position . . . . . Any

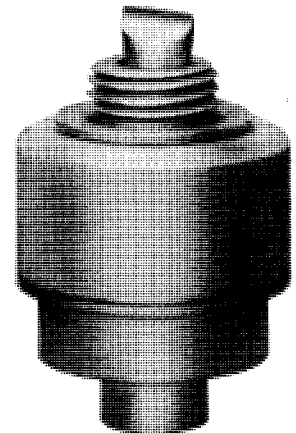

Class of Operation	Type of Service	MAXIMUM RATINGS			TYPICAL OPERATION					
		Plate Voltage (volts)	Plate Current (amps)	Cathode Current (amps)	Freq. (MHz)	Plate Voltage (volts)	Plate Current (amps)	Duty	Pulse Length (μs)	Output Power (watts)
C	RF Amp. or Osc.	2500	0.250	—	—	—	—	—	—	—
C	Grid-pulsed Amp. or Osc.	3000	5.0	—	3500	2500	5.0	0.0033	1.0	3000†
C	Plate-pulsed Amp. or Osc.	3500	5.0	—	—	—	—	—	—	—
—	Switch Tube or Pulse Modulator	3500	—	7.5	—	—	—	—	—	—

† Useful Pulse Power, delivered to the load.

**Planar Triodes  
8847, 8847A**

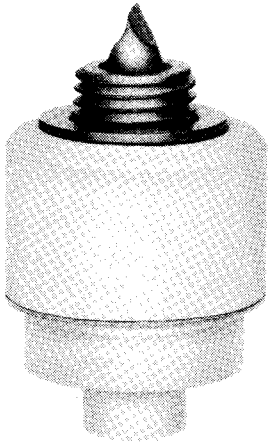

The 8847 and 8847A are miniature, ceramic/metal, rugged planar triodes for advanced airborne and space applications up to 3500 MHz.

The 8847A is identical to the 8847 except that heater power is reduced 25%. The tube should be used where input power consumption and heat dissipation are of major concern. Both tubes are supplied without radiator and may be conduction, convection, heat-sink, or liquid cooled. Radiators permitting forced-air cooling with up to 150 watts of anode dissipation are available.

Both tubes have a frequency-stable anode design and an arc-resistant cathode, for stable, reliable, and long-life operation under adverse conditions. Either tube may be used as an amplifier, oscillator, or frequency multiplier, in the CW mode, or grid or plate pulsed, as well as a modulator or regulator.

**CHARACTERISTICS**

- Plate Dissipation (Max.) . . . . . Dependent on Cooling Technique
- Grid Dissipation (Max.) . . . . . 1.5 watts
- Frequency for Max. Ratings (CW) . . . . . 3000 MHz
- (Pulsed) . . . . . 3500 MHz
- Cooling . . . . . Technique Optional
- Cathode . . . . . Oxide-coated Unipotential
- Heater: Voltage (8847) . . . . . 6.3 volts
- (8847A) . . . . . 6.0 volts
- Current (8847) . . . . . 1.30 amperes
- (8847A) . . . . . 0.95 ampere
- Capacitances: Grid-Cathode . . . . . 9.5 pF
- Grid-Plate . . . . . 1.4 pF
- Plate-Cathode . . . . . 0.06 pF
- Amplification Factor (Mu) . . . . . 75
- Nominal Cutoff Amp. Factor (Mu) . . . . . 60
- Transconductance (Sm) . . . . . 30 mmhos
- Anode . Threaded stud, 3/8-24 UNF, for heat transfer; Concentric flange for electrical contact.
- Base . . . . . Special, Coaxial
- Maximum Seal & Anode Core Temperature . . 250°C
- Maximum Length . . . . . 1.37 in; 34.80 mm
- Maximum Diameter . . . . . 0.785 in; 19.94 mm
- Weight (approximate) . . . . . 0.56 oz; 16 gm
- Operating Position (both types) . . . . . Any

Class of Operation	Type of Service	MAXIMUM RATINGS			TYPICAL OPERATION					
		Plate Voltage (volts)	Plate Current (amps)	Cathode Current (amps)	Freq. (MHz)	Plate Voltage (volts)	Plate Current (amps)	Duty	Pulse Length (μs)	Output Power (watts)
C	RF Amp. or Osc.	2500	0.250	—	—	—	—	—	—	—
C	Grid-pulsed Amp. or Osc.	3000	5.0	—	1600	3000	3.0	0.0033	6	3000†
C	Plate-pulsed Amp. or Osc.	3500	5.0	—	—	—	—	—	—	—
—	Switch Tube or Pulse Modulator	3500	—	7.5	—	—	—	—	—	—

† Useful Pulse Power, delivered to the load.

**8892**

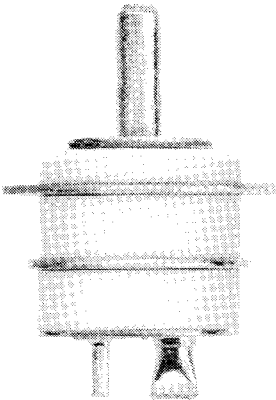

The 8892 is a compact, rugged ceramic/metal planar triode intended for CW use or as a plate or grid pulsed oscillator or amplifier. It features high power output, high plate efficiency, and excellent frequency stability under severe environmental conditions.

The construction of the 8892 readily lends itself to cavity circuit operation, resulting in a very compact RF source. The tube is capable of providing up to 1 kW of peak power at 6000 MHz.

**CHARACTERISTICS**

- Plate Dissipation (Max.) . . . . . 50 watts
- Grid Dissipation (Max.) . . . . . 1.5 watts
- Frequency for Max. Ratings (Pulsed) . . . . 6000 MHz
- Cooling . . . . . Conduction and Forced Air
- Cathode . . . . . Oxide-coated Unipotential
- Heater: Voltage . . . . . 6.3 volts
- Current . . . . . 0.65 ampere
- Capacitances: Grid-Cathode . . . . . 5.0 pF
- Grid-Plate . . . . . 1.6 pF
- Plate-Cathode . . . . . 0.06 pF
- Amplification Factor (Mu) . . . . . 60
- Transconductance (Sm) . . . . . 30 mmhos
- Anode: . . 1/8 in. dia. smooth stud for heat transfer; Concentric flange for electrical contact.
- Grid & Cathode Contacts: . . . . . Concentric Flanges
- Base Heater Contacts . . . . . Pin Type, isolated heater
- Maximum Seal & Anode Core Temperature . . 250°C
- Maximum Length . . . . . 1.13 in; 28.70 mm
- Maximum Diameter . . . . . 0.76 in; 19.25 mm
- Weight (approximate) . . . . . 0.25 oz; 7 gm
- Operating Position . . . . . Any

Class of Operation	Type of Service	MAXIMUM RATINGS			TYPICAL OPERATION					
		Plate Voltage (volts)	Plate Current (amps)	Cathode Current (amps)	Freq. (MHz)	Plate Voltage (volts)	Plate Current (amps)	Duty	Pulse Length (μs)	Output Power (watts)
C	Grid-pulsed Amp. or Osc.	2000	3.0	4.2	5000	2000	2.0	0.0025	3	1000†
C	Plate-pulsed Amp. or Osc.	2500	3.0	4.2	—	—	—	—	—	—

† Useful Pulse Power, delivered to the load.

# Planar Triodes 8893

The 8893 is a compact, rugged ceramic/metal planar triode intended for CW use or as a plate or grid pulsed oscillator or amplifier. It features high power output, high plate efficiency, and excellent frequency stability under severe environmental conditions.

The construction of the 8893 readily lends itself to cavity circuit operation, resulting in a very compact RF source.

The 8893 is supplied with a threaded anode shank, and the anode is capable of 100 watts dissipation with appropriate forced air, conduction, heat-sink, or liquid cooling.

## CHARACTERISTICS

Plate Dissipation (Max.)	Dependent on Cooling Technique
Grid Dissipation (Max.)	1.5 watts
Frequency for Max. Ratings (Pulsed)	4000 MHz
Cooling	Technique Optional
Cathode	Oxide-coated Unipotential
Heater: Voltage	6.3 volts
Current	1.3 amperes
Capacitances: Grid-Cathode	8.5 pF
Grid-Plate	2.15 pF
Plate-Cathode	0.1 pF
Amplification Factor (Mu)	60
Transconductance	30 mmhos
Anode:	Threaded stud, 10-32, for heat transfer; Concentric flange for electrical contact.
Grid & Cathode Contacts	Concentric Flanges
Base Heater Contacts	Pin Type, heater isolated
Maximum Seal & Anode Core Temperature	250°C
Maximum Length	1.07 in; 27.18 mm
Maximum Diameter	0.76 in; 19.25 mm
Weight (approximate)	0.35 oz; 10 gm
Operating Position	Any

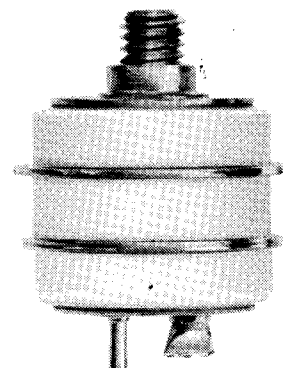

Class of Operation	Type of Service	MAXIMUM RATINGS			TYPICAL OPERATION					
		Plate Voltage (volts)	Plate Current (amps)	Cathode Current (amps)	Freq. (MHz)	Plate Voltage (volts)	Plate Current (amps)	Duty	Pulse Length (μs)	Output Power (watts)
C	RF Amp. or Osc.	2000	—	—	—	—	—	—	—	—
C	Grid-pulsed Amp. or Osc.	2000	5.0	6.5	2500	1500	3.0	0.01	3	1000†
C	Plate-pulsed Amp. or Osc.	3500	5.0	6.5	—	—	—	—	—	—

† Useful Pulse Power, delivered to the load.

# 8906, 8906AL, 8907, 8907AL

These rugged ceramic/metal planar triodes are designed for CW use or as a grid or plate pulsed oscillator, amplifier, or frequency multiplier up to 3000 MHz, as well as for pulse modulator or voltage-regulator service.

The 8906 and 8906AL, and the 8907 and 8907AL, are electrically identical except for special tests performed on the AL versions to prove reliability in airline DME and transponder service.

These tubes have unusually low heater power requirements for their high current capability. They normally can be used to replace types 7815 or 7815R, at the same heater voltage, where higher current capability and/or longer life are required. They can normally also replace types 7211 and 7698 when a 25% lower heater power requirement is desired.

The cathode of these tubes is of the arc-resistant, extended-interface type, well proven for reliable, long-life operation under adverse conditions.

## CHARACTERISTICS

Plate Dissipation (Max.) (8906 & 8906AL)	.10 watts
Plate Dissipation (Max.) (8907 & 8907AL)	100 watts
Grid Dissipation (Max.) (all types)	1.5 watts
Frequency for Max. Ratings (CW)	2500 MHz
(Pulsed)	3000 MHz
Cooling (8906 & 8906AL)	Conduction & Convection
Cooling (8907 & 8907AL)	Forced Air
Cathode	Oxide-coated Unipotential
Heater: Voltage (8906 & 8907)	6.0 volts
(8906AL & 8907AL)	5.7 volts
Current (8906 & 8907)	1.0 ampere
(8906AL & 8907AL)	0.95 ampere
Capacitances: Grid-Cathode	8.0 pF
Grid-Plate	1.98 pF
Plate-Cathode	0.06 pF
Amplification Factor (Mu)	60
Nominal Cutoff Amp. Factor (Mu)	60
Transconductance	30 mmhos
Base	Special, Coaxial Socket
Maximum Seal & Anode Core Temperature	250°C
Maximum Length (all types)	2.70 in; 68.60 mm
Maximum Diameter	(8906 & 8906AL) 1.20 in; 30.50 mm
(8907 & 8907AL)	1.27 in; 32.20 mm
Weight (approximate)	(8906 & 8906AL) 1.8 oz; 48 gm
(8907 & 8907AL)	2.2 oz; 63 gm
Operating Position (all types)	Any

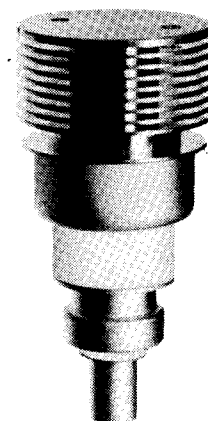

Class of Operation	Type of Service	MAXIMUM RATINGS			TYPICAL OPERATION					
		Plate Voltage (volts)	Plate Current (amps)	Cathode Current (amps)	Freq. (MHz)	Plate Voltage (volts)	Plate Current (amps)	Duty	Pulse Length (μs)	Output Power (watts)
C	RF Amp. (gnd. grid)	2500	0.15	—	700	630	0.14	—	—	45*
C	RF Amp. (gnd. grid)	2500	0.15	—	2500	1000	0.14	—	—	30*
C	Grid-pulsed Amp.	3500	5.0	—	1100	2200	2.5	0.002	3	2500†
C	Plate-pulsed Osc.	4500	5.0	—	3000	3500	4.8	0.0025	3	3000†
—	Switch Tube or Pulse Modulator	3500	—	7.5	—	—	—	—	—	—

\* Useful Power Output, delivered to the load.

† Useful Pulse Power, delivered to the load.

**Planar Triodes**  
**8933**

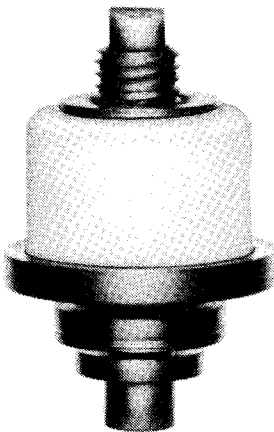

The 8933 is a miniature, ceramic/metal, rugged planar triode for advanced airborne and space applications up to 3000 MHz where high RF pulse power is required, or for switch tube service up to 8 kVdc.

In addition to low inter-electrode capacitance, high transconductance and amplification factor, the 8933 has an arc-resistant cathode and a spewing shield, assuring stable, reliable long-life operation under adverse conditions.

The 8933 is supplied without radiator and may be conduction, convection, heat-sink, or liquid cooled. Radiators for forced-air cooling, permitting an anode dissipation up to 150 watts, are available.

**CHARACTERISTICS**

- Plate Dissipation (Max.) . . . . . Dependent on Cooling Technique
- Grid Dissipation (Max.) . . . . . 1.5 watts
- Frequency for Max. Ratings (CW) . . . . . 2500 MHz (Pulsed) . . . . . 3000 MHz
- Cooling . . . . . Technique Optional
- Cathode . . . . . Oxide-coated Unipotential
- Heater: Voltage . . . . . 6.3 volts
- Current . . . . . 1.3 amperes
- Capacitances: Grid-Cathode . . . . . 9.5 pF
- Grid-Plate . . . . . 1.4 pF
- Plate-Cathode . . . . . 0.06 pF
- Amplification Factor (Mu) . . . . . 120
- Transconductance (Sm) . . . . . 30 mmhos
- Anode: . . Threaded stud, 0.3125-24 UNF-2A thread for heat transfer; Concentric flange for electrical contact.
- Base . . . . . Special, Coaxial
- Maximum Seal & Anode Core Temperature . . . 250°C
- Maximum Length . . . . . 1.50 in; 38.10 mm
- Maximum Diameter . . . . . 0.95 in; 24.13 mm
- Weight (approximate) . . . . . 0.7 oz; 19 gm
- Operating Position . . . . . Any

Class of Operation	Type of Service	MAXIMUM RATINGS			TYPICAL OPERATION					
		Plate Voltage (volts)	Plate Current (amps)	Cathode Current (amps)	Freq. (MHz)	Plate Voltage (volts)	Plate Current (amps)	Duty	Pulse Length (μs)	Output Power (watts)
C	Grid-pulsed Amp. or Osc.	8000	5.0	7.5	1030	5000	3.3	0.0033	0.5	8000†
C	Grid-pulsed Amp. or Osc.	8000	5.0	7.5	1030	4700	1.5	0.0033	0.5	3250‡
C	Plate-pulsed Amp. or Osc.	10,000	5.0	7.5	—	—	—	—	—	—
—	Switch Tube or Pulse Modulator	8000	—	7.5	—	—	—	—	—	—

† Useful Pulse Power, delivered to the load. Approximate stage gain = 6 dB.  
‡ Useful Pulse Power, delivered to the load. Approximate stage gain = 10 dB.

**8940**

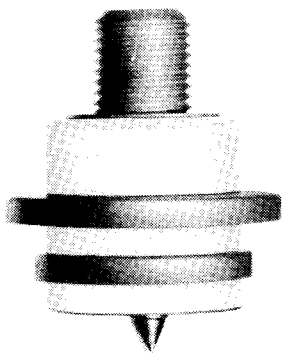

The 8940 is a ceramic/metal rugged planar triode for advanced airborne, ground, and space applications up to 3000 MHz.

The tube may be used as an amplifier, oscillator, or frequency multiplier, in the grid or plate pulsed mode, as well as a modulator or series regulator tube. Design features include a large area arc-resistant cathode and a vaporization shield to assure stable and reliable long-life operation under adverse conditions.

The 8940 is normally supplied without radiator and may be conduction, convection, heat-sink, or liquid cooled, such as immersion cooling in an insulating medium (e.g., FC-75). Radiators for forced-air cooling as well as heat-sink adaptors, permitting anode dissipation up to 750 watts, are available.

**CHARACTERISTICS**

- Plate Dissipation (Max.) . . . . . Dependent on Cooling Technique
- Grid Dissipation (Max.) . . . . . 2.0 watts
- Frequency for Max. Ratings (CW) . . . . . 2500 MHz (Pulsed) . . . . . 3000 MHz
- Cooling . . . . . Technique Optional
- Cathode . . . . . Oxide-coated Unipotential
- Heater: Voltage . . . . . 6.3 volts
- Current . . . . . 2.25 amperes
- Capacitances: Grid-Cathode . . . . . 16.0 pF
- Grid-Plate . . . . . 0.4 pF
- Plate-Cathode . . . . . 0.11 pF
- Amplification Factor (Mu) . . . . . 65
- Transconductance (Sm) . . . . . 100 mmhos
- Anode: Threaded stud, 1/2-20 UNF for heat transfer; Tapered flange for electrical contact.
- Grid, Cathode/Heater Contacts. . . . . Special, Coaxial
- Heater Contact . . . . . Special
- Maximum Seal & Anode Core Temperature . . . 250°C
- Maximum Length . . . . . 1.98 in; 50.29 mm
- Maximum Diameter . . . . . 1.37 in; 34.80 mm
- Weight (approximate) . . . . . 2.0 oz; 56 gm
- Operating Position . . . . . Any

Class of Operation	Type of Service	MAXIMUM RATINGS			TYPICAL OPERATION					
		Plate Voltage (volts)	Plate Current (amps)	Cathode Current (amps)	Freq. (MHz)	Plate Voltage (volts)	Plate Current (amps)	Duty	Pulse Length (μs)	Output Power (watts)
C	Grid-pulsed Amp. or Osc.	4000	12	—	1200	4000	3.0	0.01	500	6000†
C	Plate-pulsed Amp. or Osc.	6500	12	—	2000	3500	10.0	0.0033	6	10,000†
—	Switch Tube or Pulse Modulator	4000	—	16	—	—	—	0.0033	6	—
A, B, or C	RF Amp. or Osc.	4000	0.6	—	800	1400	0.32	—	—	180*

\*Useful Power Output, delivered to the load.

† Useful Pulse Power, delivered to the load.



**CHARACTERISTICS**

The 8941 is a ceramic/metal rugged planar triode for advanced airborne, ground, and space applications.

The tube is intended primarily as a modulator or series regulator tube, and can be used also in grid or plate pulsed RF applications.

The tube features an arc-resistant cathode and is normally supplied without radiator so it may be conduction, convection, heat-sink, or liquid cooled such as immersion cooling in an insulating medium (e.g., FC-75). Radiators for forced-air cooling as well as heat-sink adaptors permitting anode dissipation up to 750 watts are available.

- Plate Dissipation (Max.) . . . . . Dependent on Cooling Technique
- Grid Dissipation (Max.) . . . . . 2.0 watts
- Frequency for Max. Ratings (Pulsed) . . . . . 2000 MHz
- Cooling . . . . . Technique Optional
- Cathode . . . . . Oxide-coated Unipotential
- Heater: Voltage . . . . . 6.3 volts
- Current . . . . . 2.25 amperes
- Capacitances: Grid-Cathode . . . . . 14.0 pF
- Grid-Plate . . . . . 2.5 pF
- Plate-Cathode . . . . . 0.11 pF
- Amplification Factor (Mu) . . . . . 200
- Transconductance (Sm) . . . . . 75 mmhos
- Anode: Threaded stud, 1/2-20 UNF for heat transfer; Tapered flange for electrical contact.
- Grid, Cathode/Heater contacts . . . . Special, Coaxial
- Heater Contact . . . . . Special
- Maximum Seal & Anode Core Temperature . . . . 250°C
- Maximum Length . . . . . 2.23 in; 56.64 mm
- Maximum Diameter . . . . . 1.36 in; 34.54 mm
- Weight (approximate) . . . . . 2.0 oz; 56 gm
- Operating Position . . . . . Any

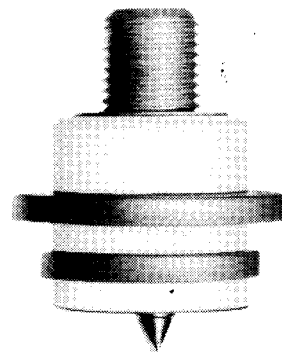

Class of Operation	Type of Service	MAXIMUM RATINGS			TYPICAL OPERATION					
		Plate Voltage (volts)	Plate Current (amps)	Cathode Current (amps)	Freq. (MHz)	Plate Voltage (volts)	Plate Current (amps)	Duty	Pulse Length (μs)	Output Power (watts)
B or C	Grid-pulsed Amp. or Osc.	10,000	12	—	—	—	—	—	—	—
B or C	Plate-pulsed Amp. or Osc.	15,000	12	—	—	—	—	—	—	—
—	Switch Tube or Pulse Modulator	15,000	—	16	—	—	—	0.0033	6	—

**8942**

**CHARACTERISTICS**

The 8942 is a ceramic/metal rugged planar triode for advanced airborne, ground, and space applications up to 2000 MHz.

The tube may be used as an amplifier, oscillator, or frequency multiplier, in the grid or plate pulsed mode, as well as a modulator or series regulator tube. Design features include a large-area arc-resistant cathode and a vaporization shield to assure stable and reliable long-life operation under adverse conditions.

The 8942 is normally supplied without radiator and may be conduction, convection, heat-sink or liquid cooled, such as immersion cooling in an insulating medium (e.g., FC-75). Radiators for forced-air cooling as well as heat-sink adaptors permitting anode dissipation up to 750 watts are available.

- Plate Dissipation (Max.) . . . . . Dependent on Cooling Technique
- Grid Dissipation (Max.) . . . . . 2.0 watts
- Frequency for Max. Ratings (Pulsed) . . . . . 2000 MHz
- Cooling . . . . . Technique Optional
- Cathode . . . . . Oxide-coated Unipotential
- Heater: Voltage . . . . . 6.3 volts
- Current . . . . . 2.25 amperes
- Capacitances: Grid-Cathode . . . . . 15.0 pF
- Grid-Plate . . . . . 3.0 pF
- Plate-Cathode . . . . . 0.11 pF
- Amplification Factor (Mu) . . . . . 115
- Transconductance (Sm) . . . . . 90 mmhos
- Anode: Threaded stud, 1/2-20 UNF for heat transfer; Tapered flange for electrical contact.
- Grid, Cathode/Heater contacts . . . . Special, Coaxial
- Heater Contact . . . . . Special
- Maximum Seal & Anode Core Temperature . . . . 250°C
- Maximum Length . . . . . 2.23 in; 56.64 mm
- Maximum Diameter . . . . . 1.36 in; 34.54 mm
- Weight (approximate) . . . . . 2.0 oz; 56 gm
- Operating Position . . . . . Any

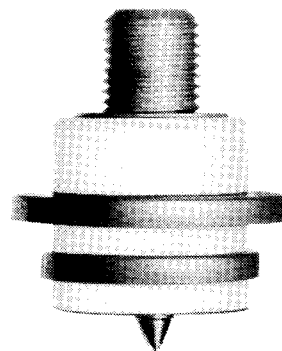

Class of Operation	Type of Service	MAXIMUM RATINGS			TYPICAL OPERATION					
		Plate Voltage (volts)	Plate Current (amps)	Cathode Current (amps)	Freq. (MHz)	Plate Voltage (volts)	Plate Current (amps)	Duty	Pulse Length (μs)	Output Power (watts)
C	Grid-pulsed Amp. or Osc.	6000	12	—	—	—	—	—	—	—
C	Plate-pulsed Amp. or Osc.	7500	12	—	1300	7500	12	0.001	1.0	30,000†
—	Switch Tube or Pulse Modulator	8000	—	16	—	—	—	—	—	—

† Useful Pulse Power, delivered to the load.

**Y-503** see 7855

# Planar Triodes Y-518

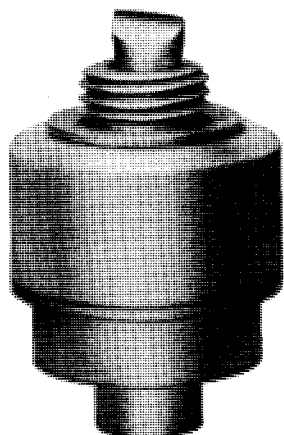

The Y-518 is a miniature ceramic/metal rugged planar triode for advanced airborne, ground, and space applications up to 3000 MHz.

The Y-518 may be used as an amplifier, oscillator, or frequency multiplier in the CW mode, grid or plate pulsed mode, or as a modulator or regulator. Design features include an arc-resistant cathode to assure stable, reliable, and long-life operation under adverse conditions.

The tube is supplied without radiator, with a threaded anode shank, and may be conduction, convection, heat-sink, or liquid cooled. Radiators for forced-air cooling, as well as heat-sink adaptors, permitting anode dissipation up to 300 watts, are available.

## CHARACTERISTICS

Plate Dissipation (Max.) . . . . . Dependent on Cooling Technique  
 Grid Dissipation (Max.) . . . . . 1.5 watts  
 Frequency for Max. Ratings (CW) . . . . . 2500 MHz (Pulsed) . . . . . 3000 MHz  
 Cooling . . . . . Technique Optional  
 Cathode . . . . . Oxide-coated Unipotential  
 Heater: Voltage . . . . . 6.3 volts  
           Current . . . . . 1.3 amperes  
 Capacitances: Grid-Cathode . . . . . 9.7 pF  
                   Grid-Plate . . . . . 1.2 pF  
                   Plate-Cathode . . . . . 0.065 pF  
 Amplification Factor (Mu) . . . . . 135  
 Transconductance (Sm) . . . . . 40 mmhos  
 Anode: Threaded stud, 3/8-24 UNF, for heat transfer; Concentric flange for electrical contact.  
 Base . . . . . Special, Coaxial  
 Maximum Seal & Anode Core Temperature . . . . . 250°C  
 Maximum Length . . . . . 1.37 in; 34.80 mm  
 Maximum Diameter . . . . . 0.785 in; 19.90 mm  
 Weight (approximate) . . . . . 0.56 oz; 16 gm  
 Operating Position . . . . . Any

Class of Operation	Type of Service	MAXIMUM RATINGS			TYPICAL OPERATION					
		Plate Voltage (volts)	Plate Current (amps)	Cathode Current (amps)	Freq. (MHz)	Plate Voltage (volts)	Plate Current (amps)	Duty	Pulse Length (μs)	Output Power (watts)
C	RF Amp. or Osc.	7500	0.3	—	—	—	—	—	—	—
C	Grid-pulsed Amp. or Osc.	8000	6.0	—	1100	4000	1.8	0.001	12	2500†
C	Plate-pulsed Amp. or Osc.	10,000	6.0	—	—	—	—	—	—	—
—	Switch Tube or Pulse Modulator	10,000	—	9.0	—	—	—	—	—	—

† Useful Pulse Power, delivered to the load.

# Y-519

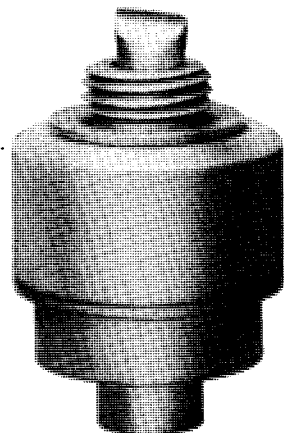

The Y-519 is a miniature, frequency-stable, ceramic/metal, rugged planar triode for advanced airborne and space applications up to 3000 MHz.

The Y-519 may be used as an amplifier, oscillator, or frequency multiplier in the CW and the grid or plate pulsed mode, as well as a modulator or series regulator tube. Design features include an arc-resistant cathode to assure stable and long-life operation under adverse conditions.

The Y-519 is supplied without radiator and may be conduction, convection, heat-sink, or liquid cooled. Radiators for forced-air cooling, permitting an anode dissipation up to 300 watts, and beryllium oxide heat-sink adaptors, are also available.

## CHARACTERISTICS

Plate Dissipation (Max.) . . . . . Dependent on Cooling Technique  
 Grid Dissipation (Max.) . . . . . 1.5 watts  
 Frequency for Max. Ratings (CW) . . . . . 2500 MHz (Pulsed) . . . . . 3000 MHz  
 Cooling . . . . . Technique Optional  
 Cathode . . . . . Oxide-coated Unipotential  
 Heater: Voltage . . . . . 6.3 volts  
           Current . . . . . 1.3 amperes  
 Capacitances: Grid-Cathode . . . . . 9.75 pF  
                   Grid-Plate . . . . . 1.70 pF  
                   Plate-Cathode . . . . . 0.065 pF  
 Amplification Factor (Mu) . . . . . 75  
 Transconductance (Sm) . . . . . 40 mmhos  
 Anode: . . . Threaded stud, 3/8-24 UNF-2A, for heat transfer; tapered flange for electrical contact.  
 Base . . . . . Special, Coaxial  
 Maximum Seal & Anode Core Temperature . . . . . 250°C  
 Maximum Length . . . . . 1.37 in; 34.80 mm  
 Maximum Diameter . . . . . 0.78 in; 19.90 mm  
 Weight (approximate) . . . . . 0.56 oz; 16 gm  
 Operating Position . . . . . Any

Class of Operation	Type of Service	MAXIMUM RATINGS			TYPICAL OPERATION					
		Plate Voltage (volts)	Plate Current (amps)	Cathode Current (amps)	Freq. (MHz)	Plate Voltage (volts)	Plate Current (amps)	Duty	Pulse Length (μs)	Output Power (watts)
C	RF Amp. or Osc.	3000	0.3	—	1600	1800	0.2	—	—	80*
C	Grid-pulsed Amp. or Osc.	3000	6.0	—	1600	3000	3.0	0.0033	200	3500†
C	Plate-pulsed Amp. or Osc.	3500	6.0	—	—	—	—	—	—	—
—	Switch Tube or Pulse Modulator	3000	—	9.0	—	—	—	—	—	—

\* Useful Power Output, delivered to the load.

† Useful Pulse Power, delivered to the load.

## Planar Triodes Y-540

### CHARACTERISTICS

Plate Dissipation (Max.)	Dependent on Cooling Technique
Grid Dissipation (Max.)	1.5 watts
Cooling	Technique Optional
Cathode	Oxide-coated Unipotential
Heater: Voltage	.6.3 volts
Current	1.3 amperes
Capacitances: Grid-Cathode	.9.0 pF
Grid-Plate	1.4 pF
Plate-Cathode	0.06 pF
Amplification Factor (Mu)	145
Transconductance (Sm)	30 mmhos
Anode:	Threaded stud, 5/16-24 UNF-2A for heat transfer and electrical contact.
Grid, Cathode, Heater Contacts:	Special, Solder Tabs
Maximum Seal & Anode Core Temperature	250°C
Maximum Length	1.56 in; 39.60 mm
Maximum Diameter	0.78 in; 19.90 mm
Weight (approximate)	0.56 oz; 16 gm
Operating Position	Any

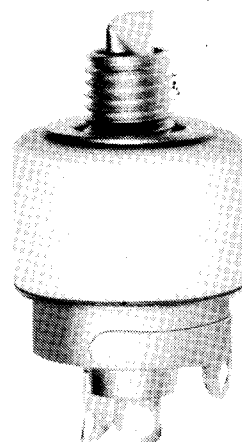

The Y-540 is a rugged ceramic/metal planar triode designed for switch tube or pulsed regulator service in advanced ground, airborne, or space applications.

Design features include an arc-resistant cathode to assure stable and reliable long-life operation under adverse conditions. An added feature is the increased grid-to-cathode insulator length to permit operation at high plate voltages and/or higher altitudes.

The Y-540 is normally supplied without a radiator and may be conduction, convection, heat-sink, or liquid cooled, as immersion cooling in an insulating medium (e.g., FC-75). Radiators for forced-air cooling, as well as heat-sink adaptors, permitting anode dissipation up to 150 watts, are available. The tube is supplied with solder tabs on the cathode, heater, and grid terminals.

Class of Operation	Type of Service	MAXIMUM RATINGS			TYPICAL OPERATION					
		Plate Voltage (volts)	Plate Current (amps)	Cathode Current (amps)	Freq. (MHz)	Plate Voltage (volts)	Plate Current (amps)	Duty	Pulse Length (μs)	Output Power (watts)
—	Switch Tube or Pulse Modulator	8000	5.0	6.5	—	—	—	—	—	—

## Y-579

### CHARACTERISTICS

Plate Dissipation (Max.)	150 watts
Grid Dissipation (Max.)	1.5 watts
Frequency for Max. Ratings (CW)	2500 MHz
Cooling	Forced Air
Cathode	Oxide-coated Unipotential
Heater: Voltage	.6.0 volts
Current	1.3 amperes
Capacitances: Grid-Cathode	.6.5 pF
Grid-Plate	2.0 pF
Plate-Cathode	0.035 pF
Amplification Factor (Mu)	100
Transconductance (Sm)	25 mmhos
Base	Special, Coaxial
Socket	Special
Maximum Seal & Anode Core Temperature	250°C
Maximum Length	2.70 in; 68.60 mm
Maximum Diameter	1.27 in; 32.20 mm
Weight (approximate)	.2.2 oz; 63 gm
Operating Position	Any

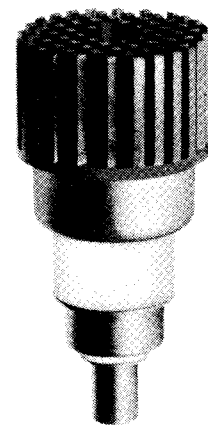

The Y-579 is a rugged ceramic/metal planar triode designed for use in TV translator service up to 3000 MHz. The tube may also be used in CW mixer, oscillator, or amplifier service. The Y-579 is supplied with an air-cooling radiator for forced-air cooling.

The Y-579 has a specially designed dispenser-type cathode which permits the high average current ratings needed in TV translator service and which is particularly insensitive to back heating.

Class of Operation	Type of Service	MAXIMUM RATINGS			TYPICAL OPERATION					
		Plate Voltage (volts)	Plate Current (amps)	Cathode Current (amps)	Freq. (MHz)	Plate Voltage (volts)	Plate Current (amps)	Duty	Pulse Length (μs)	Gain (dB)
C	RF Amp. or Osc.	2500	0.4	—	—	—	—	—	—	—
A	TV Translator Amplifier	—	—	—	400 800	1300	0.09	—	—	15* 13†

\*Peak Sync. level.

† Approximate average level.

**Planar Triodes  
Y-579A**

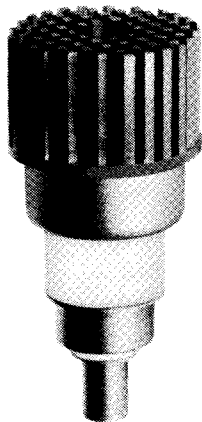

The Y-579A is a high-gain (up to 20 dB) version of the basic Y-579. It is a rugged ceramic/metal planar triode designed for use in TV translator service up to 3000 MHz. The tube may also be used in CW oscillator or mixer and amplifier service.

The Y-579A has higher Mu and transconductance than the Y-579, and includes the specially designed dispenser-type cathode which permits the high average current ratings needed in TV translator service and which is particularly insensitive to back heating. The high Mu and Sm make this tube ideally suited for applications where high gain is required; gain in excess of 18 dB may be expected with suitable cavity design.

The tube is supplied with an air-cooling radiator for forced-air cooling.

**CHARACTERISTICS**

- Plate Dissipation (Max.) . . . . . 150 watts
- Grid Dissipation (Max.) . . . . . 1.5 watts
- Frequency for Max. Ratings (CW) . . . . . 3000 MHz
- Cooling . . . . . Forced Air
- Cathode . . . . . Oxide-coated Unipotential
- Heater: Voltage . . . . . 6.0 volts
- Current . . . . . 1.3 amperes
- Capacitances: Grid-Cathode . . . . . 7.0 pF
- Grid-Plate . . . . . 2.0 pF
- Plate-Cathode . . . . . 0.035 pF
- Amplification Factor (Mu) . . . . . 200
- Transconductance (Sm) . . . . . 30 mmhos
- Base . . . . . Special, Coaxial
- Socket . . . . . Special
- Maximum Seal & Anode Core Temperature . . . 250°C
- Maximum Length . . . . . 2.70 in; 68.60 mm
- Maximum Diameter . . . . . 1.26 in; 32.20 mm
- Weight (approximate) . . . . . .2.2 oz; 63 gm
- Operating Position . . . . . Any

Class of Operation	Type of Service	MAXIMUM RATINGS			TYPICAL OPERATION					
		Plate Voltage (volts)	Plate Current (amps)	Cathode Current (amps)	Freq. (MHz)	Plate Voltage (volts)	Plate Current (amps)	Duty	Pulse Length (μs)	Gain (dB)
C	RF Amp. or Osc.	2500	0.4	—	—	—	—	—	—	—
A	TV Translator Amplifier	—	—	—	400	1300	0.09	—	—	20*
					800	—	—	—	—	18†

\*Peak Sync. level.

† Approximate average level.

## External Anode, Forced Air Cooled Triodes **3CPX1500A7**

### CHARACTERISTICS

Plate Dissipation (Max.) . . . . . 1500 watts  
 Grid Dissipation (Max.) . . . . . 25 watts  
 Cooling . . . . . Liquid Immersion or Forced Air  
 Cathode:  
   Voltage . . . . . 5.5 volts  
   Current . . . . . 11.2 amperes  
 Capacitances (Gnd. Cath. Connection):  
   Input . . . . . 38.5 pF  
   Output . . . . . 0.1 pF  
   Feed-through . . . . . 10 pF  
 Amplification Factor . . . . . 200  
 Transconductance . . . . . 55,000  $\mu$ hos  
 Base . . . . . Special 7-pin  
 Recommended Air System Socket . . . . . SK-2200  
 Recommended Air Chimney . . . . . SK-2216  
 Maximum Seal & Anode Core Temperature . . . . . 250°C  
 Maximum Length . . . . . 4.02 in; 102.00 mm  
 Maximum Diameter . . . . . 3.38 in; 86.00 mm  
 Weight (approximate) . . . . . 24.0 oz; 685 gm  
 Operating Position . . . . . Any

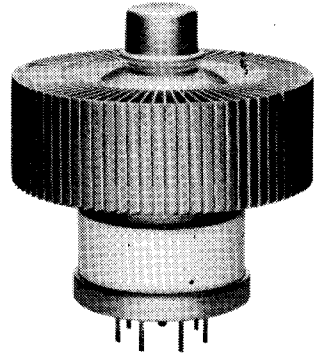

The 3CPX1500A7 is a rugged ceramic/metal high-mu power triode, designed with beam-forming cathode and control-grid geometry to allow the simplicity of design and circuit advantages of a triode with the gain of a tetrode.

The tube is intended for pulse modulator or pulse regulator service. The external anode may be forced-air cooled, or for higher voltage holdoff capability the complete tube may be liquid immersed for both insulation improvement and cooling.

Type of Cooling	Type of Service	MAXIMUM RATINGS		TYPICAL OPERATION				
		Plate Voltage (kV)	Plate Current (amps)	Driven Element	Plate Voltage (kV)	Plate Current (amps)	Drive Power (watts)	Output Power (kW)
Forced-Air	Pulse Regulator or Modulator	10.0	50.0†	Grid	10.0	40.0	700	306†
Liquid-Immersed	Pulse Regulator or Modulator	15.0	50.0†	Grid	15.0	40.0	735	506†

†  $t_p = 10 \mu$ sec, see pulse rating curve for longer pulse.

## **3CX400U7/8961**

### CHARACTERISTICS

Plate Dissipation (Max.) . . . . . 400 watts  
 Grid Dissipation (Max.) . . . . . 5 watts  
 Frequency for Max. Ratings (CW) . . . . . 1000 MHz  
 Cooling . . . . . Forced Air  
 Cathode . . . . . Oxide-coated Unipotential  
   Voltage . . . . . 6.3 volts  
   Current . . . . . 3.0 amperes  
 Capacitances (Gnd. Grid Connection):  
   Input . . . . . 18.4 pF  
   Output . . . . . 6.1 pF  
   Feed-through . . . . . 0.07 pF  
 Amplification Factor . . . . . 240  
 Transconductance . . . . . 29,000  $\mu$ hos  
 Base . . . . . Special, Coaxial  
 Recommended Air-System Socket . . . . . None; collets available  
 Maximum Seal & Anode Core Temperature . . . . . 250°C  
 Maximum Length . . . . . 2.50 in; 63.70 mm  
 Maximum Diameter . . . . . 2.10 in; 52.90 mm  
 Weight (approximate) . . . . . 5.5 oz; 155 gm  
 Operating Position . . . . . Any

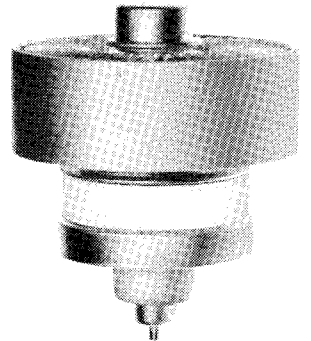

The 3CX400U7/8961 is designed for use above 200 MHz as a CW, pulse, or linear RF amplifier, particularly in the 806 to 950 MHz portion of the spectrum allocated to land mobile service. This high-mu triode is designed with beam-forming cathode and control-grid geometry, is of ceramic/metal construction, and has an anode rated for 400 watts of dissipation with forced-air cooling.

With an amplification factor of over 200 and minimum current interception by the grid the tube has excellent power gain in cathode-driven (grounded grid) circuitry. Over 200 watts of useful CW RF power may be obtained with better than 33% efficiency and better than 10 dB of gain in the UHF region.

Class of Operation	Type of Service	MAXIMUM RATINGS		TYPICAL OPERATION					
		Plate Voltage (volts)	Plate Current (amps)	Freq. (MHz)	Driven Element	Plate Voltage (volts)	Plate Current (amps)	Drive Power (watts)	Output Power (watts)
C	RF Power Amplifier	1500	0.40	850	Cath.	1500	0.40	13	225†

† Useful Power Output

External Anode, Forced Air Cooled Triodes

# 3CX1000A7/8283

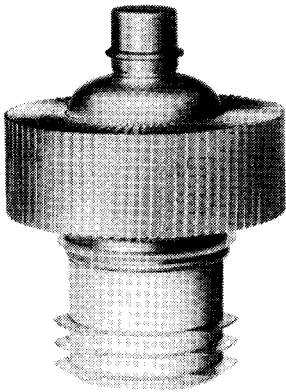

The 3CX1000A7/8283 ceramic/metal zero-bias triode is intended for Class AB<sub>2</sub> linear amplifier service in either grid-driven or cathode-driven configuration. It is recommended for use as a grid-driven push-pull audio amplifier or modulator and as a cathode driven linear amplifier through the VHF-TV bands.

## CHARACTERISTICS

- Plate Dissipation (Max.) . . . . . 1000 watts
- Grid Dissipation (Max.) . . . . . .45 watts
- Frequency for Max. Ratings (CW) . . . . . 220 MHz
- Cooling . . . . . Forced Air
- Filament . . . . . Thoriated tungsten mesh
- Voltage . . . . . 5.0 volts
- Current . . . . . 30.5 amperes
- Capacitances (Gnd. Cath. Connection):
- Input . . . . . 32.0 pF
- Output . . . . . 0.1 pF
- Feed-through . . . . . 14.0 pF
- Capacitances (Gnd. Grid Connection):
- Input . . . . . 32.0 pF
- Output . . . . . 14.0 pF
- Feed-through . . . . . 0.1 pF
- Amplification Factor . . . . . 200
- Base . . . . . Special Breechblock
- Recommended Air-System Socket . . . . . SK-860 or SK-870
- Recommended Air Chimney . . . . . SK-816
- Maximum Seal & Anode Core Temperature . . . . . 250°C
- Maximum Length . . . . . 4.80 in; 121.90 mm
- Maximum Diameter . . . . . 3.38 in; 85.80 mm
- Weight (approximate) . . . . . 2.0 lb; 0.91 kg
- Operating Position . . . . . Vertical, base up or down

Class of Operation	Type of Service	MAXIMUM RATINGS		TYPICAL OPERATION				
		Plate Voltage (volts)	Plate Current (amps)	Driven Element	Plate Voltage (volts)	Plate Current (amps)	Drive Power (watts)	Output Power (watts)
C	RF Power Amplifier	3500	0.70	Grid	—	—	—	—
C	RF Power Amplifier Plate Modulated	2000	0.55	Grid	—	—	—	—
AB <sub>2</sub>	RF Linear Amplifier	3500	1.0	Cath.	3500	0.86	100	2060
AB <sub>2</sub>	AF Amplifier or Modulator	3500	1.0	Grid	2500	2.0*	44	3100*

\*Two tubes.

# 3CX1500A7/8877

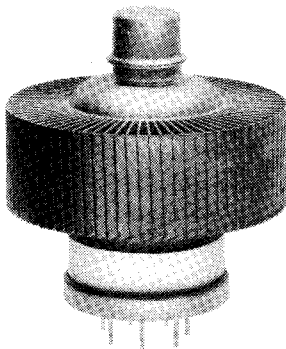

The 3CX1500A7/8877 ceramic/metal power triode is designed for use as a cathode-driven Class AB<sub>2</sub> or Class B amplifier, in audio or RF applications including the VHF band, or as a cathode driven plate modulated Class C RF amplifier. As a linear amplifier, high power gain may be obtained without sacrifice of low intermodulation distortion characteristics. Low grid interception and high amplification factor combine to make drive requirements exceptionally low for a tube of this power capacity.

## CHARACTERISTICS

- Plate Dissipation (Max.) . . . . . 1500 watts
- Grid Dissipation (Max.) . . . . . .25 watts
- Frequency for Max. Ratings (CW) . . . . . 250 MHz
- Cooling . . . . . Forced Air
- Cathode . . . . . Oxide-coated Unipotential
- Voltage . . . . . 5.0 volts
- Current . . . . . 10.5 amperes
- Capacitances (Gnd. Cath. Connection):
- Input . . . . . 38.5 pF
- Output . . . . . 0.1 pF
- Feed-through . . . . . 10.2 pF
- Capacitances (Gnd. Grid Connection):
- Input . . . . . 38.5 pF
- Output . . . . . 10.2 pF
- Feed-through . . . . . 0.1 pF
- Amplification Factor . . . . . 200
- Transconductance . . . . . 55,000 μmhos
- Base . . . . . Special 7-pin
- Recommended Air-System Socket
- Grounded Grid . . . . . SK-2210
- Recommended Air-System Socket
- Grounded Cathode . . . . . SK-2200
- Recommended Air Chimney . . . . . SK-2216
- Maximum Seal & Anode Core Temperature . . . . . 250°C
- Maximum Length . . . . . 4.02 in; 102.20 mm
- Maximum Diameter . . . . . 3.38 in; 85.80 mm
- Weight (approximate) . . . . . 1.6 lbs; 0.7 kg
- Operating Position . . . . . Any

Class of Operation	Type of Service	MAXIMUM RATINGS		TYPICAL OPERATION					
		Plate Voltage (volts)	Plate Current (amps)	Freq. (MHz)	Driven Element	Plate Voltage (volts)	Plate Current (amps)	Drive Power (watts)	Output Power (watts)
C	RF Power Amplifier Plate Modulated	3200	0.80	30	Cath.	2400	0.60	41	1000
B	RF Linear Amplifier	4000	1.0	108	Cath.	4000	1.0	78	2600†
AB <sub>2</sub>	RF Linear Amplifier	4000	1.0	220	Cath.	2500	1.0	57	1520†
AB <sub>2</sub>	RF Linear Amplifier	4000	1.0	30	Cath.	3500	1.0	64	2075†

†Useful Power Output.

External Anode, Forced Air Cooled Triodes

**3CX2500A3/8161**

**3CX2500F3/8251**

CHARACTERISTICS

The 3CX2500A3/8161 high-power triode is widely employed in AM, FM, and TV service. Its coaxial filament and grid terminals insure low-inductance connection to these electrodes and allow operation at maximum ratings through 75 MHz, or at reduced ratings to 110 MHz. The use of an external forced-air-cooled anode results in a compact structure with high power-handling capability. The envelope structure is ceramic/metal for high strength and reliability.

The 3CX2500F3/8251 is identical except for the addition of flexible filament and grid leads on the base which can simplify low frequency installations.

- Plate Dissipation (Max.) . . . . . 4000 watts
- Grid Dissipation (Max.) . . . . . 150 watts
- Frequency for Max. Ratings (CW) . . . . . 75 MHz
- Cooling . . . . . Forced Air
- Filament . . . . . Thoriated tungsten
- Voltage . . . . . 7.5 volts
- Current (3CX2500A3) . . . . . 51.5 amperes
- (3CX2500F3) . . . . . 50.5 amperes
- Capacitances (Gnd. Cath. Connection):
- Input . . . . . 35.0 pF
- Output . . . . . 0.9 pF
- Feed-through . . . . . 20.0 pF
- Amplification Factor . . . . . 20
- Transconductance . . . . . 20,000  $\mu$ mhos
- Base (3CX2500A3) . . . . . Coaxial
- (3CX2500F3) . . . . . Flexible leads
- Maximum Seal & Anode Core Temperature . . . . . 250°C
- Maximum Length (3CX2500A3) 9.00 in; 228.60 mm
- (3CX2500F3) . . . . . 18.44 in; 468.40 mm
- Maximum Diameter (both types) 4.16 in; 105.70 mm
- Weight (approximate) (3CX2500A3) . . . . . 6.2 lb; 2.8 kg
- (3CX2500F3) . . . . . 7.5 lb; 3.4 kg
- Operating Position . . . . . Vertical, base up or down

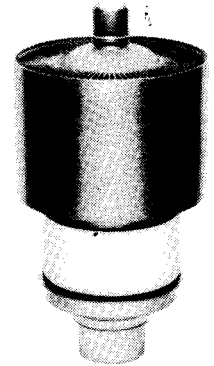

Class of Operation	Type of Service	MAXIMUM RATINGS		TYPICAL OPERATION				
		Plate Voltage (volts)	Plate Current (amps)	Driven Element	Plate Voltage (volts)	Plate Current (amps)	Drive Power (watts)	Output Power (watts)
C	RF Power Amplifier	6000	2.5	Grid	6000	2.1	136	10,000
C	RF Power Amplifier Plate Modulated	5500	2.0	Grid	5000	1.3	115	5300
AB	AF Amplifier or Modulator	6000	2.5	Grid	6000	3.0*	113	13,000*

\*Two tubes.

**3CX2500H3**

CHARACTERISTICS

The 3CX2500H3 is a ceramic/metal, forced-air cooled, external-anode power triode designed primarily for use in industrial radio-frequency heating services. Its anode is conservatively rated at 4000 watts of plate dissipation with low air flow and pressure drop.

Input of 12.5 kW is permissible up to 75 MHz. Plentiful reserve emission is available from its 380 watt filament. The grid structure is rated at 150 watts, making this tube an excellent choice for severe applications.

- Plate Dissipation (Max.) . . . . . 4000 watts
- Grid Dissipation (Max.) . . . . . 150 watts
- Frequency for Max. Ratings (CW) . . . . . 75 MHz
- Cooling . . . . . Forced Air
- Filament . . . . . Thoriated tungsten
- Voltage . . . . . 7.5 volts
- Current . . . . . 50.0 amperes
- Capacitances (Gnd. Cath. Connection):
- Input . . . . . 35.0 pF
- Output . . . . . 0.9 pF
- Feed-through . . . . . 20.0 pF
- Amplification Factor . . . . . 20
- Base . . . . . Flexible filament leads
- Maximum Seal & Anode Core Temperature . . . . . 250°C
- Maximum Length . . . . . 18.44 in; 468.40 mm
- Maximum Diameter . . . . . 4.25 in; 107.90 mm
- Weight (approximate) . . . . . 6.5 lb; 3.0 kg
- Operating Position . . . . . Vertical, base up or down

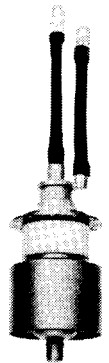

Class of Operation	Type of Service	MAXIMUM RATINGS		TYPICAL OPERATION			
		Plate Voltage (volts)	Plate Current (amps)	Plate Voltage (volts)	Plate Current (amps)	Drive Power (watts)	Output Power (watts)
C	RF Industrial Oscillator	6000	2.5	6000	2.1	136	10,000

External Anode, Forced Air Cooled Triodes

**3CX3000A1/8238**

**3CX3000F1/8239**

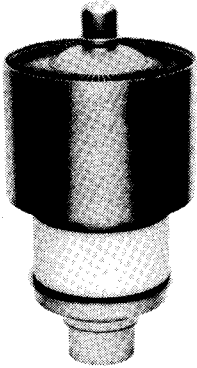

The 3CX3000A1/8238 low- $\mu$  power triode is forced-air cooled and is intended for use as an audio amplifier or modulator. Available high plate current under Class AB<sub>1</sub> operating conditions permits high power gain with a minimum of distortion. The tube is coaxial in construction.

The 3CX3000F1/8239 is identical except for the addition of flexible filament and grid leads on the base which can simplify some installations.

**CHARACTERISTICS**

- Plate Dissipation (Max.) . . . . . 3000 watts
- Grid Dissipation (Max.) . . . . . 50 watts
- Cooling . . . . . Forced Air
- Filament . . . . . Thoriated tungsten
- Voltage . . . . . 7.5 volts
- Current (3CX3000A1) . . . . . 51.5 amperes
- (3CX3000F1) . . . . . 50.5 amperes
- Amplification Factor . . . . . 5.0
- Transconductance . . . . . 11,000  $\mu$ mhos
- Base (3CX3000A1) . . . . . Coaxial
- (3CX3000F1) . . . . . Flexible leads
- Maximum Seal & Anode Core Temperature . . . 250°C
- Maximum Length (3CX3000A1) 9.00 in; 228.60 mm
- (3CX3000F1) . . . . . 18.44 in; 464.40 mm
- Maximum Diameter (both types) 4.16 in; 105.70 mm
- Weight (approximate) (3CX3000A1) . . . 6.2 lb; 2.8 kg
- (3CX3000F1) . . . . . 7.5 lb; 3.4 kg
- Operating Position . . . . . Vertical, base up or down

Class of Operation	Type of Service	MAXIMUM RATINGS		TYPICAL OPERATION				
		Plate Voltage (volts)	Plate Current (amps)	Driven Element	Plate Voltage (volts)	Plate Current (amps)	Drive Power (watts)	Output Power (watts)
AB <sub>1</sub>	AF Amplifier or Modulator	6000	2.5	Grid	5500	2.2*	0	8250*

\*Two tubes.

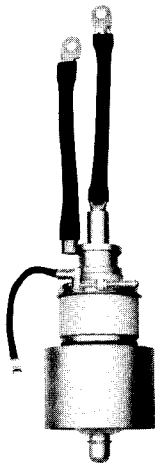

3CX3000F1/8239



**3CX3000A7**  
**3CX3000F7/8162**

**CHARACTERISTICS**

The 3CX3000A7 high-mu forced-air cooled power triode provides relatively high power output as an amplifier, oscillator, or modulator at low plate voltages. The tube has a low inductance cylindrical filament-stem structure which readily becomes part of a linear filament tank circuit for VHF operation. The grid provides good shielding between the input and output circuits for grounded-grid applications and conveniently terminates in a ring between the plate and filament terminals. Operation with zero grid bias in many applications offers circuit simplicity by eliminating the bias supply. Grounded-grid operation is attractive, since a power gain of over twenty times can be obtained.

The 3CX3000F7/8162 tube is identical except for the addition of flexible leads on the base for grid and filament connections which can simplify socketing in low frequency applications.

- Plate Dissipation (Max.) . . . . . 3000 watts
- Grid Dissipation (Max.) . . . . . 225 watts
- Frequency for Max. Ratings (CW) . . . . . 110 MHz
- Cooling . . . . . Forced Air
- Filament . . . . . Thoriated tungsten
- Voltage . . . . . 7.5 volts
- Current (3CX3000A7) . . . . . 51.5 amperes
- (3CX3000F7) . . . . . 50.5 amperes
- Capacitances (Gnd. Cath. Connection):
- Input . . . . . 38.0 pF
- Output . . . . . 0.6 pF
- Feed-through . . . . . 24.0 pF
- Capacitances (Gnd. Grid. Connection):
- Input . . . . . 38.0 pF
- Output . . . . . 24.0 pF
- Feed-through . . . . . 0.6 pF
- Amplification Factor . . . . . 160
- Base (3CX3000A7) . . . . . Special, Coaxial
- (3CX3000F7) . . . . . Flexible leads
- Maximum Seal & Anode Core Temperature 250°C
- Maximum Length (3CX3000A7) 9.00 in; 228.60 mm
- (3CX3000F7) . . . . . 18.44 in; 468.40 mm
- Maximum Diameter (both types) 4.15 in; 105.50 mm
- Weight (approximate) (3CX3000A7) . . . 6.2 lb; 2.8 kg
- (3CX3000F7) . . . . . 7.5 lb; 3.4 kg
- Operating Position . . . . . Vertical, base up or down

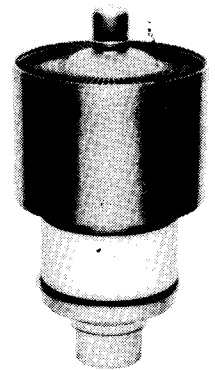

Class of Operation	Type of Service	MAXIMUM RATINGS		TYPICAL OPERATION				
		Plate Voltage (volts)	Plate Current (amps)	Driven Element	Plate Voltage (volts)	Plate Current (amps)	Drive Power (watts)	Output Power (watts)
C	RF Power Amplifier	5000	2.5	Cath.	4800	1.5	435	5500†
AB <sub>2</sub>	RF Linear Amplifier	5000	2.5	Cath.	4800	2.0	410	7260
AB <sub>2</sub>	RF Linear Amplifier AM Service	5000	2.5	Grid	4000	0.74	11.5	1130
AB <sub>2</sub>	AF Amplifier or Modulator	5000	2.5	Grid	4000	3.6*	115	10,500*

\*Two tubes. † Useful Power Output.

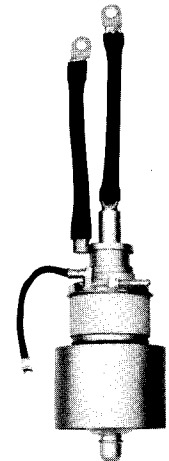

3CX3000F7/8162

External Anode, Forced Air Cooled Triodes

### 3CX5000A3

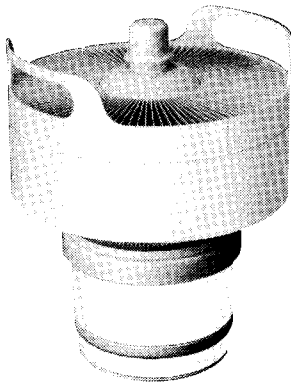

The 3CX5000A3 is an air-cooled, ceramic/metal power triode designed primarily for use as a power oscillator in industrial heating applications. It is also recommended for use as a grounded-grid FM amplifier, as a conventional plate-modulated amplifier, or as a linear amplifier.

The air-cooled anode is conservatively rated at 5 kW dissipation with low pressure drop. Plentiful reserve emission is available from the 560-watt filament. The grid structure is rated at 100 watts making this tube an excellent choice for severe applications.

#### CHARACTERISTICS

- Plate Dissipation (Max.) . . . . . 5000 watts
- Grid Dissipation (Max.) . . . . . 100 watts
- Frequency for Max. Ratings (CW) . . . . . 110 MHz
- Cooling . . . . . Forced Air
- Filament . . . . . Thoriated tungsten
- Voltage . . . . . 7.5 volts
- Current . . . . . 75.0 amperes
- Capacitances (Gnd. Cath. Connection):
- Input . . . . . 51.0 pF
- Output . . . . . 1.5 pF
- Feed-through . . . . . 25.0 pF
- Amplification Factor . . . . . 18
- Base . . . . . Special, Coaxial
- Recommended Air-System Socket . . . . . SK-1300
- Recommended Air Chimney . . . . . Y-463
- Maximum Seal & Anode Core Temperature . . . . . 250°C
- Maximum Length . . . . . 8.75 in; 222.20 mm
- Maximum Diameter . . . . . 6.40 in; 162.70 mm
- Weight (approximate) . . . . . 9.5 lb; 4.3 kg
- Operating Position . . . . . Vertical, base up or down

Class of Operation	Type of Service	MAXIMUM RATINGS		TYPICAL OPERATION				
		Plate Voltage (volts)	Plate Current (amps)	Driven Element	Plate Voltage (volts)	Plate Current (amps)	Drive Power (watts)	Output Power (watts)
C	RF Power Amplifier	7500	3.0	Grid	—	—	—	—
C	RF Power Amplifier Plate Modulated	5000	2.5	Grid	—	—	—	—
C	RF Industrial Oscillator	10,000	3.0	—	9000	2.5	208	18,600
B or AB	AF Amplifier or Modulator	7500	4.0	Grid	—	—	—	—

### 3CX5000H3

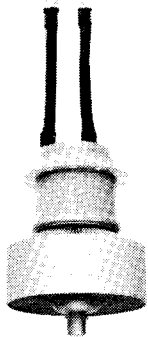

The 3CX5000H3 is an air-cooled ceramic/metal power triode intended for use in industrial radio-frequency heating services, or for conventional RF or audio amplifier or modulator applications. The air-cooled anode is conservatively rated at 5 kW dissipation with low pressure drop.

Full input may be run up to 90 MHz. The 100-watt grid structure makes this tube an excellent choice for severe applications.

#### CHARACTERISTICS

- Plate Dissipation (Max.) . . . . . 5000 watts
- Grid Dissipation (Max.) . . . . . 100 watts
- Frequency for Max. Ratings (CW) . . . . . 90 MHz
- Cooling . . . . . Forced Air
- Filament . . . . . Thoriated tungsten
- Voltage . . . . . 7.5 volts
- Current . . . . . 74.5 amperes
- Capacitances (Gnd. Cath. Connection)
- Input . . . . . 51.0 pF
- Output . . . . . 1.5 pF
- Feed-through . . . . . 25.0 pF
- Amplification Factor . . . . . 18
- Base . . . . . Flexible filament leads
- Maximum Seal & Anode Core Temperature . . . . . 250°C
- Maximum Length . . . . . 17.50 in; 444.50 mm
- Maximum Diameter . . . . . 6.45 in; 163.80 mm
- Weight (approximate) . . . . . 10.0 lb; 4.5 kg
- Operating Position . . . . . Vertical, base up or down

Class of Operation	Type of Service	MAXIMUM RATINGS		TYPICAL OPERATION				
		Plate Voltage (volts)	Plate Current (amps)	Driven Element	Plate Voltage (volts)	Plate Current (amps)	Drive Power (watts)	Output Power (watts)
C	RF Power Amplifier	7500	3.0	Grid	—	—	—	—
C	RF Power Amplifier Plate Modulated	5000	2.5	Grid	—	—	—	—
C	RF Industrial Oscillator	10,000	3.0	—	9000	2.5	208	18,600
B or AB	AF Amplifier or Modulator	7500	4.0	Grid	—	—	—	—

External Anode, Forced Air Cooled Triodes  
**3CX10,000A1/8158**

The 3CX10,000A1/8158 ceramic/metal, air-cooled power triode is primarily intended for use as an audio amplifier or modulator, or for voltage regulator applications where high current capability and low tube voltage drop are important. Up to 12 kW of anode power can be dissipated by the air-cooled anode. A water-cooled version, the 3CW20,000A1, is available with a 20 kW dissipation rating.

**CHARACTERISTICS**

Plate Dissipation (Max.) . . . . . 12,000 watts  
 Grid Dissipation (Max.) . . . . . 100 watts  
 Cooling . . . . . Forced Air  
 Filament . . . . . Thoriated tungsten  
   Voltage . . . . . 7.5 volts  
   Current . . . . . 99.0 amperes  
 Capacitances (Gnd. Cath. Connection):  
   Input . . . . . 51.0 pF  
   Output . . . . . 4.1 pF  
   Feed-through . . . . . 28.5 pF  
 Amplification Factor . . . . . 6.0  
 Transconductance . . . . . 20,000  $\mu$ mhos  
 Base . . . . . Coaxial  
 Recommended Air-System Socket . . . . . SK-1300  
 Recommended Air Chimney . . . . . SK-1306  
 Maximum Seal & Anode Core Temperature . . . . . 250°C  
 Maximum Length . . . . . 8.75 in; 222.20 mm  
 Maximum Diameter . . . . . 7.05 in; 179.10 mm  
 Weight (approximate) . . . . . 12.0 lb; 5.5 kg  
 Operating Position . . . . . Vertical, base up or down

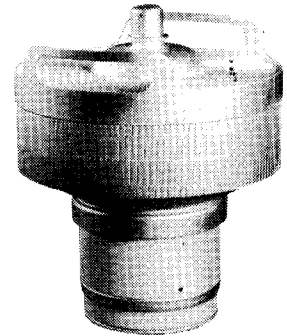

Class of Operation	Type of Service	MAXIMUM RATINGS		TYPICAL OPERATION				
		Plate Voltage (volts)	Plate Current (amps)	Driven Element	Plate Voltage (volts)	Plate Current (amps)	Drive Power (watts)	Output Power (watts)
AB <sub>1</sub>	AF Amplifier or Modulator	7000	5.0	Grid	7000	7.0*	0	29,100*
A	AF Amplifier or Modulator	7000	5.0	Grid	2500	4.0	0	1800
A	Voltage Regulator	10,000	5.0	—	—	—	—	—

\*Two tubes.

**3CX10,000A3/8159**

The 3CX10,000A3/8159 is a medium- $\mu$ , ceramic/metal, forced-air cooled power triode intended for use as a power oscillator in industrial heating applications or as an RF power amplifier in Class C or Class AB<sub>2</sub> linear service.

**CHARACTERISTICS**

Plate Dissipation (Max.) . . . . . 10,000 watts  
 Grid Dissipation (Max.) . . . . . 250 watts  
 Frequency for Max. Ratings (CW) . . . . . 160 MHz  
 Cooling . . . . . Forced Air  
 Filament . . . . . Thoriated tungsten  
   Voltage . . . . . 7.5 volts  
   Current . . . . . 99.0 amperes  
 Capacitances (Gnd. Cath. Connection):  
   Input . . . . . 53.0 pF  
   Output . . . . . 1.4 pF  
   Feed-through . . . . . 34.0 pF  
 Capacitances (Gnd. Grid Connection):  
   Input . . . . . 53.0 pF  
   Output . . . . . 34.0 pF  
   Feed-through . . . . . 1.4 pF  
 Amplification Factor . . . . . 20  
 Base . . . . . Coaxial  
 Recommended Air-System Socket . . . . . SK-1300  
 Recommended Air Chimney . . . . . SK-1306  
 Maximum Seal & Anode Core Temperature . . . . . 250°C  
 Maximum Length . . . . . 8.75 in; 222.20 mm  
 Maximum Diameter . . . . . 7.05 in; 179.10 mm  
 Weight (approximate) . . . . . 12.0 lb; 5.5 kg  
 Operating Position . . . . . Vertical, base up or down

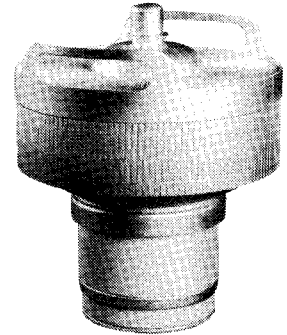

Class of Operation	Type of Service	MAXIMUM RATINGS		TYPICAL OPERATION				
		Plate Voltage (volts)	Plate Current (amps)	Driven Element	Plate Voltage (volts)	Plate Current (amps)	Drive Power (watts)	Output Power (watts)
C	RF Power Amplifier	7000	4.0	Cath.	7000	4.0	4100	24,500
C	RF Power Amplifier Plate Modulated	5500	3.0	Grid	5000	3.0	515	12,400
C	RF Industrial Oscillator	7000	4.0	—	7000	4.0	—	22,400
AB <sub>2</sub>	RF Linear Amplifier	7000	5.0	Cath.	7000	4.0	2050	20,000

## External Anode, Forced Air Cooled Triodes 3CX10,000A7/8160

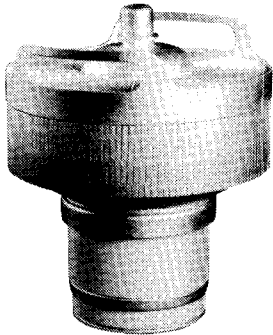

The 3CX10,000A7 ceramic/metal power triode is intended for use as a zero-bias Class B amplifier in audio or RF applications, or as a Class C amplifier, CW or modulated.

Operation in Class B with zero grid bias offers circuit simplicity by eliminating the bias supply, and in addition, grounded-grid operation is attractive since a power gain as high as twenty times can be obtained with the tube.

### CHARACTERISTICS

Plate Dissipation (Max.)	10,000 watts
Grid Dissipation (Max.)	500 watts
Frequency for Max. Ratings (CW)	160 MHz
Cooling	Forced Air
Filament	Thoriated tungsten
Voltage	7.5 volts
Current	99.0 amperes
Capacitances (Gnd. Cath. Connection)	
Input	59.0 pF
Output	0.2 pF
Feed-through	36.0 pF
Amplification Factor	200
Base	Coaxial
Recommended Air-System Socket	SK-1300 or SK-1320
Recommended Air Chimney	SK-1306
Maximum Seal & Anode Core Temperature	250°C
Maximum Length	8.75 in; 222.20 mm
Maximum Diameter	7.05 in; 179.10 mm
Weight (approximate)	12.0 lb; 5.5 kg
Operating Position	Vertical, base up or down

Class of Operation	Type of Service	MAXIMUM RATINGS		TYPICAL OPERATION				
		Plate Voltage (volts)	Plate Current (amps)	Driven Element	Plate Voltage (volts)	Plate Current (amps)	Drive Power (watts)	Output Power (watts)
C	RF Power Amplifier	8000	4.0	Cath.	7600	3.7	1510	22,500
C	RF Power Amplifier Plate Modulated	6500	3.0	Grid	5000	3.0	380	11,900
B	RF Linear Amplifier	8000	5.0	Cath.	7000	5.0	1540	24,200
B	RF Linear Amplifier AM Service	8000	5.0	Cath.	7000	2.4	330	5600
B	AF Amplifier or Modulator	8000	5.0	Grid	7000	10.0*	560	47,700*

\*Two tubes.

## 3CX10,000H3

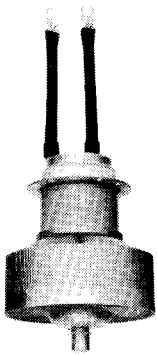

The 3CX10,000H3 ceramic/metal power triode is designed primarily for use in industrial RF heating service. Its air-cooled anode is conservatively rated at 10 kW of dissipation capability.

Input of 40 kW is permissible up to 90 MHz. Connection and mounting are simplified, with no socket necessary; the grid termination is a heavy mounting flange, and flexible leads are used for the filament lines.

This tube is an excellent choice for severe applications.

### CHARACTERISTICS

Plate Dissipation (Max.)	10,000 watts
Grid Dissipation (Max.)	250 watts
Frequency for Max. Ratings (CW)	90 MHz
Cooling	Forced Air
Filament	Thoriated tungsten
Voltage	7.5 volts
Current	99.0 amperes
Capacitances (Gnd. Cath. Connection):	
Input	53.0 pF
Output	1.4 pF
Feed-through	34.0 pF
Amplification Factor	20
Base	Flexible filament leads
Maximum Seal & Anode Core Temperature	250°C
Maximum Length	17.75 in; 450.80 mm
Maximum Diameter	7.05 in; 179.10 mm
Weight (approximate)	13.0 lb; 5.9 kg
Operating Position	Vertical, base up or down

Class of Operation	Type of Service	MAXIMUM RATINGS		TYPICAL OPERATION				
		Plate Voltage (volts)	Plate Current (amps)	Driven Element	Plate Voltage (volts)	Plate Current (amps)	Drive Power (watts)	Output Power (watts)
C	RF Industrial Oscillator	10,000	4.0	—	9000	4.0	570	29,000

External Anode, Forced Air Cooled Triodes  
**3CX15,000A3**

The 3CX15,000A3 is an air-cooled, ceramic/metal power triode designed primarily for use as a power oscillator in industrial radio frequency heating applications. It is also recommended for use as a conventional plate-modulated amplifier, or as a linear amplifier. The one kilowatt filament and rugged 500 watt grid structure make this tube especially suitable for heavy duty service.

**CHARACTERISTICS**

- Plate Dissipation (Max.) . . . . . 15,000 watts
- Grid Dissipation (Max.) . . . . . 500 watts
- Frequency for Max. Ratings (CW) . . . . . 100 MHz
- Cooling . . . . . Forced Air
- Filament . . . . . Thoriated tungsten
- Voltage . . . . . 6.3 volts
- Current . . . . . 160 amperes
- Capacitances (Gnd. Cath. Connection):
- Input . . . . . 55.0 pF
- Output . . . . . 1.4 pF
- Feed-through . . . . . 34.0 pF
- Capacitances (Gnd. Grid Connection):
- Input . . . . . 55.0 pF
- Output . . . . . 34.0 pF
- Feed-through . . . . . 1.4 pF
- Amplification Factor . . . . . 20
- Base . . . . . Coaxial
- Recommended Air-System Socket . . . . . SK-1300
- Recommended Air Chimney . . . . . SK-1306
- Maximum Seal & Anode Core Temperature . . . . . 250°C
- Maximum Length . . . . . 8.75 in; 222.30 mm
- Maximum Diameter . . . . . 7.05 in; 179.10 mm
- Weight (approximate) . . . . . 12.0 lb; 5.5 kg
- Operating Position . . . . . Vertical, base up or down

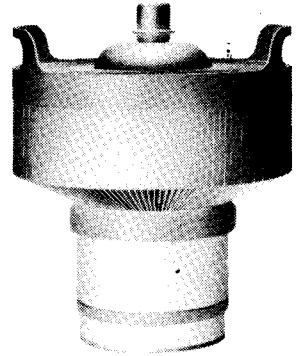

Class of Operation	Type of Service	MAXIMUM RATINGS		TYPICAL OPERATION				
		Plate Voltage (volts)	Plate Current (amps)	Driven Element	Plate Voltage (volts)	Plate Current (amps)	Drive Power (watts)	Output Power (watts)
C	RF Power Amplifier	8000	6.0	Grid	8000	5.9	740	34,000
C	RF Power Amplifier Plate Modulated	6500	5.0	Grid	5000	3.9	490	18,000
B or AB	RF Linear Amplifier	8000	6.0	Grid	7000	4.8	215	23,000

The 3CX15,000A7 ceramic/metal power triode is intended for use as a zero-bias Class B RF amplifier or Class C power amplifier or oscillator. It is also recommended for use as a grounded grid FM amplifier. Class B operation with zero bias offers circuit simplicity by eliminating the bias supply. In addition, grounded-grid operation is attractive since a power gain as high as twenty times can be obtained.

**CHARACTERISTICS**

- Plate Dissipation (Max.) . . . . . 15,000 watts
- Grid Dissipation (Max.) . . . . . 500 watts
- Frequency for Max. Ratings (CW) . . . . . 110 MHz
- Cooling . . . . . Forced Air
- Filament . . . . . Thoriated tungsten
- Voltage . . . . . 6.3 volts
- Current . . . . . 160 amperes
- Capacitances (Gnd. Cath. Connection):
- Input . . . . . 61.0 pF
- Output . . . . . 0.2 pF
- Feed-through . . . . . 36.0 pF
- Capacitances (Gnd. Grid Connection):
- Input . . . . . 61.0 pF
- Output . . . . . 36.0 pF
- Feed-through . . . . . 0.2 pF
- Amplification Factor . . . . . 200
- Base . . . . . Coaxial
- Recommended Air-System Socket . . . . . SK-1300  
or SK-1320
- Recommended Air Chimney . . . . . SK-1306
- Maximum Seal & Anode Core Temperature . . . . . 250°C
- Maximum Length . . . . . 8.75 in; 222.30 mm
- Maximum Diameter . . . . . 7.05 in; 179.10 mm
- Weight (approximate) . . . . . 12.0 lb; 5.5 kg
- Operating Position . . . . . Vertical, base up or down

**3CX15,000A7**

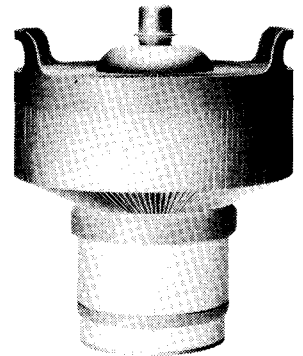

Class of Operation	Type of Service	MAXIMUM RATINGS		TYPICAL OPERATION				
		Plate Voltage (volts)	Plate Current (amps)	Driven Element	Plate Voltage (volts)	Plate Current (amps)	Drive Power (watts)	Output Power (watts)
C	RF Power Amplifier	8000	5.0	Grid	7000	4.0	430	21,300
AB	RF Linear Amplifier	8000	6.0	Cath.	7000	5.9	1750	29,600

## External Anode, Forced Air Cooled Triodes 3CX15,000H3

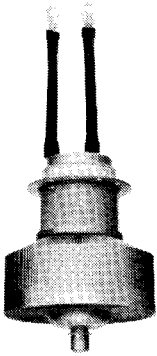

The 3CX15,000H3 is an air-cooled, ceramic/metal power triode designed primarily for use in industrial radio-frequency heating services. Its air-cooled anode is rated at 15 kW of plate dissipation.

Full ratings apply up to 90 MHz. Plentiful reserve emission is available from its one kilowatt filament. The grid structure is rated at 500 watts making this tube an excellent choice for severe application.

### CHARACTERISTICS

Plate Dissipation (Max.)	15,000 watts
Grid Dissipation (Max.)	500 watts
Frequency for Max. Ratings (CW)	90 MHz
Cooling	Forced Air
Filament	Thoriated tungsten
Voltage	6.3 volts
Current	160 amperes
Capacitances (Gnd. Cath. Connection):	
Input	55.0 pF
Output	1.4 pF
Feed-through	34.0 pF
Amplification Factor	20
Base	Flexible filament leads
Recommended Air Chimney	SK-1306
Maximum Seal & Anode Core Temperature	250°C
Maximum Length	17.75 in; 450.80 mm
Maximum Diameter	7.05 in; 179.10 mm
Weight (approximate)	13.0 lb; 5.9 kg
Operating Position	Vertical, base up or down

Class of Operation	Type of Service	MAXIMUM RATINGS		TYPICAL OPERATION				
		Plate Voltage (volts)	Plate Current (amps)	Driven Element	Plate Voltage (volts)	Plate Current (amps)	Drive Power (watts)	Output Power (watts)
C	RF Industrial Oscillator	12,000	6.0	—	10,000	5.0	650	41,200

## 3CX20,000A3

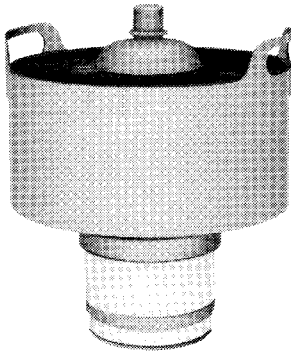

The 3CX20,000A3 is a ceramic/metal power triode for industrial oscillator or general communications service. It is recommended for Class C amplifier service, or Class B radio frequency and audio frequency amplifier use.

### CHARACTERISTICS

Plate Dissipation (Max.)	20,000 watts
Grid Dissipation (Max.)	750 watts
Frequency for Max. Ratings (CW)	90 MHz
Cooling	Forced Air
Filament	Thoriated tungsten
Voltage	10.0 volts
Current	160 amperes
Capacitances (Gnd. Cath. Connection):	
Input	70.0 pF
Output	2.3 pF
Feed-through	43.0 pF
Base	Coaxial
Recommended Air-System Socket	SK-1300
Maximum Seal & Anode Core Temperature	250°C
Maximum Length	10.00 in; 254.0 mm
Maximum Diameter	8.00 in; 203.0 mm
Weight (approximate)	19.5 lb; 8.8 kg
Operating Position	Vertical, base up or down

Class of Operation	Type of Service	MAXIMUM RATINGS		TYPICAL OPERATION				
		Plate Voltage (volts)	Plate Current (amps)	Driven Element	Plate Voltage (volts)	Plate Current (amps)	Drive Power (watts)	Output Power (watts)
C	RF Power Amplifier	12,000	8.0	Grid	10,000	7.9	960	64,000
C	RF Power Amplifier Plate Modulated	6500	5.5	Grid	6500	5.0	1500	27,500
B or AB	RF Linear Amplifier	8000	8.0	Grid	7500	7.4	400	40,000
AB	AF Amplifier or Modulator	8000	8.0	Grid	7500	14.8*	800	80,000*

\*Two tubes.

External Anode, Forced Air Cooled Triodes  
**3CX20,000A7**

The 3CX20,000A7 is a ceramic/metal power triode intended for use as a zero-bias Class B RF amplifier or Class C power amplifier or oscillator. Class B operation with zero grid bias offers circuit simplicity by eliminating the bias supply. In addition, grounded-grid operation is attractive since a power gain as high as twenty times can be obtained.

**CHARACTERISTICS**

Plate Dissipation (Max.) . . . . . 20,000 watts  
 Grid Dissipation (Max.) . . . . . 500 watts  
 Frequency for Max. Ratings (CW) . . . . . 110 MHz  
 Cooling . . . . . Forced Air  
 Filament . . . . . Thoriated tungsten  
   Voltage . . . . . 6.3 volts  
   Current . . . . . 160 amperes  
 Capacitances (Gnd. Cath. Connection):  
   Input . . . . . 61.0 pF  
   Output . . . . . 0.2 pF  
   Feed-through . . . . . 36.0 pF  
 Capacitances (Gnd. Grid Connection):  
   Input . . . . . 61.0 pF  
   Output . . . . . 36.0 pF  
   Feed-through . . . . . 0.2 pF  
 Amplification Factor . . . . . 200  
 Base . . . . . Coaxial  
 Recommended Air-System Socket . . . . . SK-1300 or SK-1320  
 Maximum Seal & Anode Core Temperature . . . . . 250°C  
 Maximum Length . . . . . 8.75 in; 222.20 mm  
 Maximum Diameter . . . . . 8.31 in; 211.10 mm  
 Weight (approximate) . . . . . 13.5 lb; 6.15 kg  
 Operating Position . . . . . Vertical, base up or down

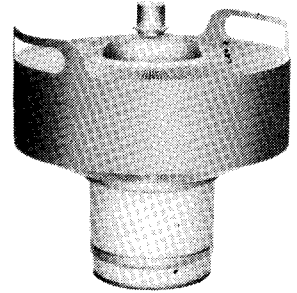

Class of Operation	Type of Service	MAXIMUM RATINGS		TYPICAL OPERATION					
		Plate Voltage (volts)	Plate Current (amps)	Freq. (MHz)	Driven Element	Plate Voltage (volts)	Plate Current (amps)	Drive Power (watts)	Output Power (watts)
C	RF Power Amplifier	8000	5.0	110	Grid	7000	4.0	430	21,300
C	RF Power Amplifier	8000	5.0	110	Cath.	7800	4.2	2300	27,500
B	RF Power Amplifier TV Servicet	8000	6.0	216	Cath.	7200	5.8	1700	27,500
AB	RF Linear Amplifier	8000	6.0	110	Cath.	7000	5.0	1540	24,200

†Peak Sync. Level

**3CX20,000H3**

The 3CX20,000H3 is a ceramic/metal medium- $\mu$  power triode with terminals arranged for direct mounting in industrial heating equipment without the use of a socket. The 3CX20,000H3 is recommended for use as an industrial oscillator in the LF to lower VHF range (30 kHz to 90 MHz). This triode is also recommended for AM broadcast service as a modulator, modulated RF stage, or as a linear amplifier.

**CHARACTERISTICS**

Plate Dissipation (Max.) . . . . . 20,000 watts  
 Grid Dissipation (Max.) . . . . . 750 watts  
 Frequency for Max. Ratings (CW) . . . . . 90 MHz  
 Cooling . . . . . Forced Air  
 Filament . . . . . Thoriated tungsten  
   Voltage . . . . . 10.0 volts  
   Current . . . . . 160 amperes  
 Capacitances (Gnd. Cath. Connection):  
   Input . . . . . 70.0 pF  
   Output . . . . . 2.3 pF  
   Feed-through . . . . . 43.0 pF  
 Base . . . . . Flexible filament leads  
 Maximum Seal & Anode Core Temperature . . . . . 250°C  
 Maximum Length . . . . . 19.00 in; 482.60 mm  
 Maximum Diameter . . . . . 8.00 in; 203.20 mm  
 Weight (approximate) . . . . . 20.0 lb; 9.1 kg  
 Operating Position . . . . . Vertical, anode up or down

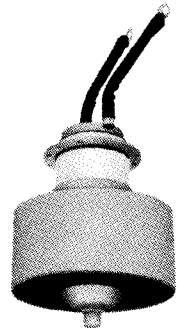

Class of Operation	Type of Service	MAXIMUM RATINGS		TYPICAL OPERATION				
		Plate Voltage (volts)	Plate Current (amps)	Driven Element	Plate Voltage (volts)	Plate Current (amps)	Drive Power (watts)	Output Power (watts)
C	RF Power Amplifier	12,000	8.0	Grid	10,000	7.9	960	64,000
C	RF Power Amplifier Plate Modulated	6500	5.5	Grid	6500	5.0	1500	27,500
AB	AF Amplifier or Modulator	8000	8.0	Grid	7500	14.8*	800	80,000*

\*Two tubes.

External Anode, Forced Air Cooled Triodes

**6697A**



The 6697A is a forced-air cooled ceramic/metal power triode designed for AM broadcast and communications amplifiers and for industrial heating service.

Low-loss ceramic and metal construction permits operation at full ratings at frequencies up to 30 MHz. Useful power output can be obtained at frequencies up to 60 MHz at reduced plate voltage.

The 6697A anode is capable of dissipating 35 kW. A water cooled version of this tube, type 6696A, and a vapor cooled version, type 7480, are also available.

**CHARACTERISTICS**

- Plate Dissipation (Max.) . . . . . 35,000 watts
- Grid Dissipation (Max.) . . . . . 1000 watts
- Frequency for Max. Ratings (CW) . . . . . 30 MHz
- Cooling . . . . . Forced Air
- Filament . . . . . Thoriated tungsten
- Voltage . . . . . 13.0 volts
- Current . . . . . 200 amperes
- Capacitances (Gnd. Cath. Connection):
  - Input . . . . . 75.0 pF
  - Output . . . . . 2.6 pF
  - Feed-through . . . . . 52.0 pF
- Amplification Factor . . . . . 20
- Base . . . . . Coaxial
- Maximum Seal & Envelope Temperature . . . . . 200°C
- Maximum Length . . . . . 19.87 in; 504.80 mm
- Maximum Diameter . . . . . 5.28 in; 134.10 mm
- Weight (approximate) . . . . . 43.0 lb; 19.5 kg
- Operating Position . . . . . Vertical, base up

Class of Operation	Type of Service	MAXIMUM RATINGS		TYPICAL OPERATION				
		Plate Voltage (volts)	Plate Current (amps)	Driven Element	Plate Voltage (volts)	Plate Current (amps)	Drive Power (watts)	Output Power (watts)
C	RF Power Amplifier	16,000	11.0	Grid	15,000	7.0	600	80,000
C	RF Power Amplifier Plate Modulated	10,000	8.5	Grid	9500	8.4	2000	60,000
AB	RF Linear Amplifier	16,000	11.0	Cath.	12,000	5.2	3500	43,000
AB	RF Linear Amplifier AM Service	16,000	9.0	Grid	12,000	4.3	450	18,000
AB	AF Amplifier or Modulator	16,000	11.0	Grid	10,000	17.4*	550	110,000*

\*Two tubes.

**8158** see 3CX10,000A1

**8159** see 3CX10,000A3

**8160** see 3CX10,000A7

**8161** see 3CX2500A3

**8162** see 3CX3000F7

**8238** see 3CX3000A1

**8239** see 3CX3000F1

**8251** see 3CX2500F3

**8283** see 3CX1000A7



External Anode, Forced Air Cooled Triodes  
**8874, 8875**

**CHARACTERISTICS**

These are compact external-anode, ceramic/metal triodes intended for use in zero-bias Class B amplifiers in audio or RF applications. The two types differ only in method of cooling and anode dissipation: the 8874 requires axial-flow forced-air cooling and is rated for 400 watts; and the 8875 has a transverse cooler for forced-air cooling and is rated for 300 watts.

Operation with zero grid bias simplifies circuitry by eliminating the normal bias supply. In addition, grounded-grid operation is attractive since a power gain as high as twenty times can be obtained with these types in a cathode-driven circuit.

- Plate Dissipation (Max.): (8874) . . . . . 400 watts  
 (8875) . . . . . 300 watts
- Grid Dissipation (Max.) . . . . . 5 watts
- Frequency for Max. Ratings (CW) . . . . . 500 MHz
- Cooling . . . . . Forced Air
- Cathode: . . . . . Oxide-coated Unipotential
- Voltage . . . . . 6.3 volts
- Current . . . . . 3.0 amperes
- Capacitances (Gnd. Cath. Connection):
- Input . . . . . 20.5 pF
- Output . . . . . 0.03 pF
- Feed-through . . . . . 6.0 pF
- Capacitances (Gnd. Grid Connection):
- Input . . . . . 20.5 pF
- Output . . . . . 6.0 pF
- Feed-through . . . . . 0.03 pF
- Cathode-Heater . . . . . 6.0 pF
- Amplification Factor . . . . . 240
- Transconductance† . . . . . 29,000  $\mu$ mhos
- Base . . . . . Large Wafer Elevenar 11-pin with Ring  
 (JEDEC No. E11-81)
- Maximum Seal & Anode Core Temperature . . . . . 250°C
- Maximum Length: (8874) . . . . . 2.14 in; 54.40 mm  
 (8875) . . . . . 2.18 in; 55.50 mm
- Maximum Diameter: (8874) . . . . . 1.64 in; 41.70 mm  
 (8875) . . . . . 2.52 in; 64.00 mm
- Weight (approximate): (8874) . . . . . 4.3 oz; 122 gm  
 (8875) . . . . . 8.6 oz; 244 gm
- Operating Position . . . . . Any

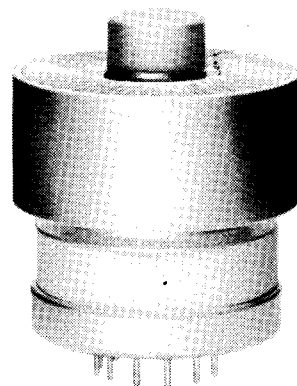

Class of Operation	Type of Service	MAXIMUM RATINGS		TYPICAL OPERATION					
		Plate Voltage (volts)	Plate Current (amps)	Freq. (MHz)	Driven Element	Plate Voltage (volts)	Plate Current (amps)	Drive Power (watts)	Output Power (watts)
C	RF Power Amplifier	2200	0.35	110	Grid	2000	0.25	9.0	305*
AB <sub>2</sub>	RF Linear Amplifier	2200	0.35	30	Cath.	2000	0.50‡	26	587*
AB <sub>2</sub>	RF Linear Amplifier	2200	0.35	432	Cath.	2000	0.50‡	27	505*

\*Useful Power Output.

† At  $I_b = 250$  mA

‡ Single-tone Intermittent Voice Service value.

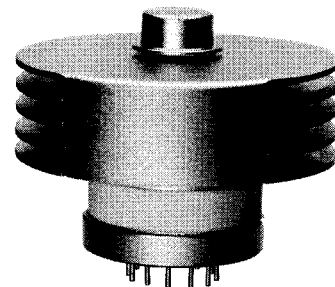

8875

**8877** see 3CX1500A7

## External Anode, Forced Air Cooled Triodes 8938

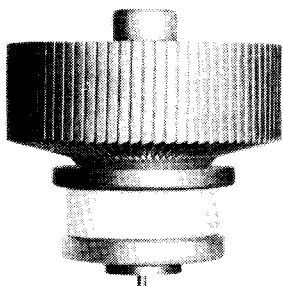

The 8938 is a rugged coaxial-base ceramic/metal power triode designed for use as a cathode driven Class AB<sub>2</sub> or Class C amplifier.

It is recommended for VHF or UHF service as a linear amplifier, power amplifier, or pulse amplifier. Linearity and power gain are both excellent due to the low ratio of grid to plate current, and the relatively high amplification factor. Low grid interception of available emission current is due to the beam forming geometry of the special grid and cathode design.

The 8938 is a practical size for use in ground based or mobile equipment in CW or PEP power levels of 1 to 2.5 kW. It is useful at frequencies higher than the upper frequency of maximum ratings, 500 MHz.

### CHARACTERISTICS

Plate Dissipation (Max.)	1500 watts
Grid Dissipation (Max.)	.20 watts
Frequency for Max. Ratings (CW)	500 MHz
Cooling	Forced Air
Cathode	Oxide-coated Unipotential
Voltage	5.0 volts
Current	10.5 amperes
Capacitances (Gnd. Grid Connection):	
Input	35.5 pF
Output	12.4 pF
Feed-through	0.14 pF
Amplification Factor	125
Transconductance	55,000 $\mu$ mhos
Base	Coaxial
Recommended Air-System Socket†	SK-2220
Maximum Seal & Anode Core Temperature	250°C
Maximum Length	3.68 in; 93.40 mm
Maximum Diameter	3.38 in; 85.80 mm
Weight (approximate)	25 oz; 709 gm
Operating Position	Any

Class of Operation	Type of Service	MAXIMUM RATINGS		TYPICAL OPERATION					
		Plate Voltage (volts)	Plate Current (amps)	Freq. (MHz)	Driven Element	Plate Voltage (volts)	Plate Current (amps)	Drive Power (watts)	Output Power (watts)
C	RF Power Amplifier	4000	1.0	400	Cath.	3000	1.0	83	1570†
AB <sub>2</sub>	RF Linear Amplifier	4000	1.0	30	Cath.	3500	0.97	50	2030†

† Useful Power Output.

‡ Collets available—see 8962.

## 8961 see 3CX400U7

## 8962

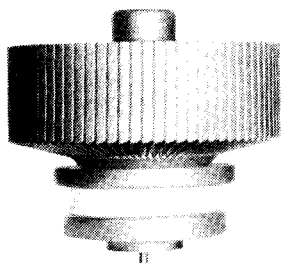

The 8962 is a high- $\mu$  triode designed with beam-forming cathode and control grid geometry, with a forced-air cooled external anode rated at 1500 watts dissipation, and coaxial base terminals. This focused-triode design makes possible the simplicity and circuit advantages of a triode combined with the gain of a tetrode.

The tube is intended for use above 200 MHz, with good gain in cathode driven (grounded grid) circuitry, and is especially useful in the 806 to 950 MHz band allocated to land mobile services, where typical gain of 10 dB may be obtained in a suitable amplifier.

### CHARACTERISTICS

Plate Dissipation (Max.)	1500 watts
Grid Dissipation (Max.)	30 watts
Frequency for Max. Ratings (CW)	1000 MHz
Cooling	Forced Air
Cathode	Oxide-coated Unipotential
Voltage	4.5 volts
Current	11 amperes
Capacitances (Gnd. Grid Connection):	
Input	28.0 pF
Output	13.0 pF
Feed-through	0.04 pF
Amplification Factor	300
Transconductance	50,000 $\mu$ mhos
Base	Special, Coaxial
Available Contact Collets:	
Anode	Part No. 135304
Grid	135305
Cathode	135306
Heater	135307
Heater (center pin)	135310
Maximum Seal & Anode Core Temperature	250°C
Maximum Length	3.50 in; 89.00 mm
Maximum Diameter	3.40 in; 86.00 mm
Weight (approximate)	25 oz; 709 gm
Operating Position	Any

Class of Operation	Type of Service	MAXIMUM RATINGS		TYPICAL OPERATION					
		Plate Voltage (volts)	Plate Current (amps)	Freq. (MHz)	Driven Element	Plate Voltage (volts)	Plate Current (amps)	Drive Power (watts)	Output Power (watts)
B	RF Linear Amplifier	2000	1.0	850	Cath.	2000	1.0	68	680*

\* Useful, measured at the load.

CHARACTERISTICS

The 8963 is a coaxial-base ceramic/metal high- $\mu$  focused triode designed for VHF amplifier service. The beam-forming cathode and control-grid geometry allows high gain, with low grid interception and zero bias operation in linear amplifier applications.

The anode is designed for minimum output capacitance and has air cooling fins of an improved design.

- Plate Dissipation (Max.) . . . . . 20,000 watts
- Grid Dissipation (Max.) . . . . . 100 watts
- Frequency for Max. Ratings (CW) . . . . . 250 MHz
- Cooling . . . . . Forced Air
- Cathode . . . . . Oxide-coated Unipotential
- Voltage . . . . . 18.0 volts
- Current . . . . . 11 amperes
- Capacitances (Gnd. Grid Connection):
  - Input . . . . . 82.0 pF
  - Output . . . . . 21.0 pF
  - Plate-Cathode . . . . . 0.1 pF
- Amplification Factor . . . . . 260
- Transconductance . . . . . 90,000  $\mu$ mhos
- Base . . . . . Special, Coaxial
- Maximum Seal & Anode Core Temperature . . . . . 250° C
- Maximum Length . . . . . 6.70 in; 170.00 mm
- Maximum Diameter . . . . . 9.18 in; 233.00 mm
- Weight (approximate) . . . . . 21.5 lb; 9.7 kg
- Operating Position . . . . . Any

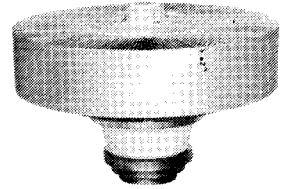

Class of Operation	Type of Service	MAXIMUM RATINGS		TYPICAL OPERATION				
		Plate Voltage (volts)	Plate Current (amps)	Driven Element	Plate Voltage (volts)	Plate Current (amps)	Drive Power (watts)	Output Power (watts)
B	RF Amplifier Television	10,000	5.0	Cath.	8350	3.6* 4.7†	280* 480†	16,500* 27,500†

\*Blanking level. †Sync level.

## External Anode, Vapor Cooled Triodes 3CV30,000A3

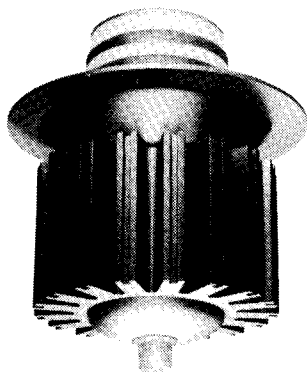

The 3CV30,000A3 is a vapor-cooled, ceramic/metal power triode designed primarily for use in industrial radio-frequency heating service. Its vapor-cooled anode is conservatively rated at 30 kW of plate dissipation when mounted in a BR-200 boiler.

Full input of 60 kW is permissible up to 100 MHz. Large reserve emission is available from its one kilowatt filament and the grid structure is rated at one ampere making this tube an excellent choice for severe applications.

It is also recommended as a grounded grid FM amplifier, a conventional plate-modulated amplifier or as a linear amplifier in new equipment designs.

### CHARACTERISTICS

Plate Dissipation (Max.)	30,000 watts
Grid Dissipation (Max.)	500 watts
Frequency for Max. Ratings (CW)	100 MHz
Cooling	Vapor and Forced Air
Filament	Thoriated tungsten
Voltage	6.3 volts
Current	160 amperes
Capacitances (Gnd. Cath. Connection):	
Input	55.0 pF
Output	1.4 pF
Feed-through	34.0 pF
Amplification Factor	20
Base	Coaxial
Recommended Air-System Socket	SK-1310
Recommended Boiler	BR-200
Maximum Seal Temperature	250°C
Maximum Length	8.62 in; 218.90 mm
Maximum Diameter	7.75 in; 196.80 mm
Weight (approximate)	18.0 lb; 8.2 kg
Operating Position	Vertical, base up

Class of Operation	Type of Service	MAXIMUM RATINGS		TYPICAL OPERATION				
		Plate Voltage (volts)	Plate Current (amps)	Driven Element	Plate Voltage (volts)	Plate Current (amps)	Drive Power (watts)	Output Power (watts)
C	RF Power Amplifier Plate Modulated	7000	5.0	Grid	7000	5.0	750	27,500
C	RF Industrial Oscillator	10,000	6.0	—	10,000	6.0	365	42,000
AB <sub>2</sub>	RF Linear Amplifier	10,000	6.0	Grid	10,000	6.0	240	41,000

## 3CV30,000H3

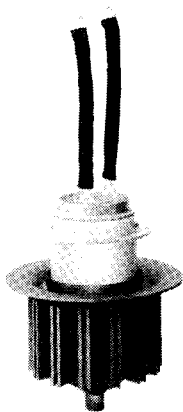

The 3CV30,000H3 is a vapor-cooled, ceramic/metal power triode designed primarily for use in industrial radio-frequency heating service. Its vapor-cooled anode is conservatively rated at 30 kW of plate dissipation when mounted in a BR-200 boiler.

Full input of 60 kW is permissible up to 100 MHz. Large reserve emission is available from its one kilowatt filament and the grid structure is rated at one ampere making this tube an excellent choice for severe applications.

It is also recommended as an audio amplifier, a conventional plate-modulated amplifier or as a linear amplifier in new equipment designs.

### CHARACTERISTICS

Plate Dissipation (Max.)	30,000 watts
Grid Dissipation (Max.)	500 watts
Frequency for Max. Ratings (CW)	100 MHz
Cooling	Vapor and Forced Air
Filament	Thoriated tungsten
Voltage	6.3 volts
Current	160 amperes
Capacitances (Gnd. Cath. Connection):	
Input	55.0 pF
Output	1.4 pF
Feed-through	34.0 pF
Amplification Factor	20
Base	Flexible filament leads
Recommended Boiler	BR-200
Maximum Seal Temperature	250°C
Maximum Length	17.63 in; 447.80 mm
Maximum Diameter	7.75 in; 196.80 mm
Weight (approximate)	18.0 lb; 8.2 kg
Operating Position	Vertical, base up

Class of Operation	Type of Service	MAXIMUM RATINGS		TYPICAL OPERATION				
		Plate Voltage (volts)	Plate Current (amps)	Driven Element	Plate Voltage (volts)	Plate Current (amps)	Drive Power (watts)	Output Power (watts)
C	RF Power Amplifier Plate Modulated	7000	5.0	Grid	7000	5.0	750	27,500
C	RF Industrial Oscillator	10,000	6.0	—	10,000	6.0	365	42,000
AB <sub>2</sub>	AF Amplifier or Modulator	10,000	6.0	Grid	9600	6.2*	50	36,000*

\*Two tubes.

CHARACTERISTICS

The 7480 is a vapor-cooled ceramic/metal triode designed for AM broadcast and communications amplifiers and for industrial heating service.

Low-loss ceramic and metal construction permits operation at full ratings at frequencies up to 30 MHz. Useful power output can be obtained at frequencies up to 60 MHz at reduced plate voltage.

The 7480 anode is capable of dissipating 80 kW continuously, and higher power during intermittent operation or momentary overloads. A water cooled version of this tube, type 6696A, and a forced-air cooled version, type 6697A, are also available.

- Plate Dissipation (Max.) . . . . . 80,000 watts
- Grid Dissipation (Max.) . . . . . 1000 watts
- Frequency for Max. Ratings (CW) . . . . . 30 MHz
- Cooling . . . . . Vapor and Forced Air
- Filament . . . . . Thoriated tungsten
- Voltage . . . . . 13 volts
- Current . . . . . 200 amperes
- Capacitances (Gnd. Cath. Connection):
- Input . . . . . 75.0 pF
- Output . . . . . 2.6 pF
- Feed-through . . . . . 52.0 pF
- Amplification Factor . . . . . 20
- Base . . . . . Coaxial
- Recommended Terminal Connectors . . SK-1600 Series
- Recommended Boiler . . . . . BR-400 Series
- Maximum Seal & Envelope Temperature . . . 200°C
- Maximum Length . . . . . 20.13 in; 511.30 mm
- Maximum Diameter . . . . . 7.12 in; 180.80 mm
- Weight (approximate) . . . . . 50.0 lb; 22.7 kg
- Operating Position . . . . . Vertical, base up



Class of Operation	Type of Service	MAXIMUM RATINGS		TYPICAL OPERATION				
		Plate Voltage (volts)	Plate Current (amps)	Driven Element	Plate Voltage (volts)	Plate Current (amps)	Drive Power (watts)	Output Power (watts)
C	RF Power Amplifier	16,000	11.0	Grid	15,000	7.0	600	80,000
C	RF Power Amplifier Plate Modulated	10,000	8.5	Grid	9500	8.4	2000	60,000
AB	RF Linear Amplifier	16,000	11.0	Cath.	12,000	9.8	8200	83,000
AB	RF Linear Amplifier (AM Service)	16,000	9.0	Grid	12,000	6.8	1500	28,000
AB	AF Amplifier or Modulator	16,000	11.0	Grid	12,000	20.0*	600	152,000*

\*Two tubes.

External Anode, Water Cooled Triodes

**3CW5000A1/8240**

**3CW5000F1/8241**

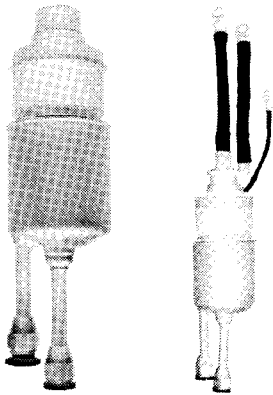

The 3CW5000A1/8240 and 3CW5000F1/8241 are low- $\mu$  water-cooled power triodes intended for use as audio amplifiers or modulators. Their maximum rated plate dissipation is 5000 watts. The two types are identical except for the addition of flexible leads for the grid and filament terminals on the 3CW5000F1/8241.

Two of these tubes, in Class AB<sub>1</sub> audio service, will deliver more than 10 kW maximum-signal plate output power at 6000 plate volts without drawing grid current.

These two types are electrically identical to the air-cooled 3CX3000A1/8238 except for the plate dissipation rating.

**CHARACTERISTICS**

Plate Dissipation (Max.)	5000 watts
Grid Dissipation (Max.)	50 watts
Cooling	Water and Forced Air
Filament	Thoriated tungsten
Voltage	7.5 volts
Current (3CW5000A1)	51.5 amperes
(3CW5000F1)	50.5 amperes
Amplification Factor	4.9
Transconductance†	11,000 $\mu$ mhos
Base (3CW5000A1)	Coaxial
(3CW5000F1)	Flexible filament leads
Maximum Seal Temperature	250°C
Maximum Flexible Lead Temperature	175°C
Maximum Length (3CW5000A1)	12.62 in; 320.50 mm
(3CW5000F1)	22.06 in; 560.30 mm
Maximum Diameter (both types)	3.63 in; 92.10 mm
Weight (approximate) (3CW5000A1)	4.8 lb; 2.2 kg
(3CW5000F1)	6.0 lb; 2.7 kg
Operating Position	Vertical, base up or down

Class of Operation	Type of Service	MAXIMUM RATINGS		TYPICAL OPERATION				
		Plate Voltage (volts)	Plate Current (amps)	Driven Element	Plate Voltage (volts)	Plate Current (amps)	Drive Power (watts)	Output Power (watts)
AB <sub>1</sub>	AF Amplifier or Modulator	6000	2.5	Grid	6000	2.7*	0	10,000*

\*Two tubes.

†At I<sub>b</sub> = 10 A

**3CW5000A3/8242**

**3CW5000F3/8243**

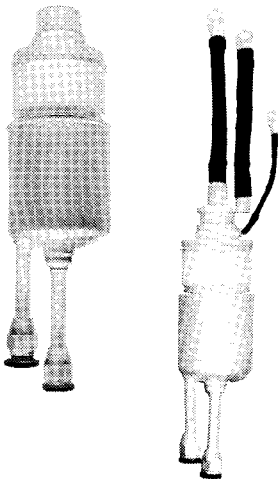

The 3CW5000A3 and 3CW5000F3 are medium- $\mu$  water-cooled power triodes intended for use in amplifier, oscillator, or modulator service. Their maximum rated anode dissipation is 5000 watts. The two types are identical except for the addition of flexible leads for the grid and filament terminals of the 3CW5000F3/8243.

These tubes are water-cooled versions of the air-cooled 3CX2500A3/8161 and 3CX2500F3/8251.

The water-cooled tubes are recommended for industrial applications or installations where reserve anode dissipation is required.

**CHARACTERISTICS**

Plate Dissipation (Max.)	5000 watts
Grid Dissipation (Max.)	150 watts
Frequency for Max. Ratings (CW)	75 MHz
Cooling	Water and Forced Air
Filament	Thoriated tungsten
Voltage	7.5 volts
Current (3CW5000A3)	51.5 amperes
(3CW5000F3)	50.5 amperes
Capacitances (Gnd. Cath. Connection):	
Input	35.0 pF
Output	0.9 pF
Feed-through	20.0 pF
Amplification Factor	20
Transconductance†	20,000 $\mu$ mhos
Base (3CW5000A3)	Coaxial
(3CW5000F3)	Flexible filament leads
Maximum Seal Temperature	250°C
Maximum Flexible Lead Temperature	175°C
Maximum Length (3CW5000A3)	12.62 in; 320.50 mm
(3CW5000F3)	22.06 in; 560.30 mm
Maximum Diameter (both types)	3.63 in; 92.10 mm
Weight (approximate) (3CW5000A3)	4.8 lb; 2.2 kg
(3CW5000F3)	6.0 lb; 2.7 kg
Operating Position	Vertical, base up or down

Class of Operation	Type of Service	MAXIMUM RATINGS		TYPICAL OPERATION				
		Plate Voltage (volts)	Plate Current (amps)	Driven Element	Plate Voltage (volts)	Plate Current (amps)	Drive Power (watts)	Output Power (watts)
C	RF Power Amplifier	6000	2.5	Grid	6000	2.1	136	10,000
C	RF Power Amplifier Plate Modulated	5000	2.0	Grid	5000	1.5	76	5580
AB <sub>2</sub>	AF Amplifier or Modulator	6000	2.5	Grid	6000	3.0*	113	13,000*
AB <sub>2</sub>	AF Amplifier or Modulator	6000	2.5	Grid	5000	2.3*	59	8000*

\*Two tubes.

†At I<sub>b</sub> = 10 A

External Anode, Water Cooled Triodes  
**3CW5000H3**

**CHARACTERISTICS**

The 3CW5000H3 is a water-cooled, ceramic/metal power triode designed primarily for use in industrial radio-frequency heating services. Its water-cooled anode is conservatively rated at 5 kW of plate dissipation with low water flow and pressure drop.

Input of 12.5 kW is permissible up to 75 MHz. Plentiful reserve emission is available from its 375 watt filament. The grid structure is rated at 150 watts making this tube an excellent choice for severe applications.

- Plate Dissipation (Max.) . . . . . 5000 watts
- Grid Dissipation (Max.) . . . . . 150 watts
- Frequency for Max. Ratings (CW) . . . . . 75 MHz
- Cooling . . . . . Water and Forced Air
- Filament . . . . . Thoriated tungsten
- Voltage . . . . . 7.5 volts
- Current . . . . . 50.5 amperes
- Capacitances (Gnd. Cath. Connection):
- Input . . . . . 35.0 pF
- Output . . . . . 0.9 pF
- Feed-through . . . . . 20.0 pF
- Amplification Factor . . . . . 20
- Transconductance† . . . . . 20,000  $\mu$ mhos
- Base . . . . . Flexible filament leads
- Maximum Seal Temperature . . . . . 250°C
- Maximum Flexible Lead Temperature . . . . . 175°C
- Maximum Length . . . . . 18.56 in; 471.40 mm
- Maximum Diameter . . . . . 5.42 in; 137.70 mm
- Weight (approximate) . . . . . 7.5 lb; 3.4 kg
- Operating Position . . . . . Vertical, base up or down

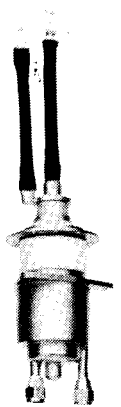

Class of Operation	Type of Service	MAXIMUM RATINGS		TYPICAL OPERATION			
		Plate Voltage (volts)	Plate Current (amps)	Plate Voltage (volts)	Plate Current (amps)	Drive Power (watts)	Output Power (watts)
C	RF Industrial Oscillator	6000	2.5	6000	2.1	136	10,000

†At  $I_b - 0.83 A$

**3CW10,000H3**

**CHARACTERISTICS**

The 3CW10,000H3 is a water-cooled, ceramic/metal power triode designed primarily for use in industrial radio-frequency heating services. Its water-cooled anode is conservatively rated at 10 kW of plate dissipation with low water flow and pressure drop.

Input of 30 kW is permissible up to 90 MHz. Plentiful reserve emission is available from its 560 watt filament. The grid structure is rated at 150 watts making this tube an excellent choice for severe applications.

- Plate Dissipation (Max.) . . . . . 10,000 watts
- Grid Dissipation (Max.) . . . . . 100 watts
- Frequency for Max. Ratings (CW) . . . . . 90 MHz
- Cooling . . . . . Water and Forced Air
- Filament . . . . . Thoriated tungsten
- Voltage . . . . . 7.5 volts
- Current . . . . . 75.0 amperes
- Capacitances (Gnd. Cath. Connection):
- Input . . . . . 51.0 pF
- Output . . . . . 1.5 pF
- Feed-through . . . . . 25.0 pF
- Amplification Factor . . . . . 20
- Base . . . . . Flexible filament leads
- Maximum Seal Temperature . . . . . 250°C
- Maximum Flexible Lead Temperature . . . . . 175°C
- Maximum Length . . . . . 18.75 in; 476.20 mm
- Maximum Diameter . . . . . 6.80 in; 172.70 mm
- Weight (approximate) . . . . . 10 lb; 4.54 kg
- Operating Position . . . . . Vertical, base up or down

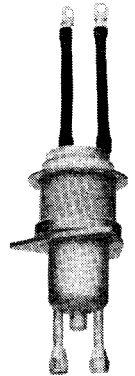

Class of Operation	Type of Service	MAXIMUM RATINGS		TYPICAL OPERATION			
		Plate Voltage (volts)	Plate Current (amps)	Plate Voltage (volts)	Plate Current (amps)	Drive Power (watts)	Output Power (watts)
C	RF Industrial Oscillator	10,000	3.0	9000	2.9	—	20,600

External Anode, Water Cooled Triodes  
**3CW20,000A1**



The 3CW20,000A1 is a ceramic/metal power triode intended primarily for use as an audio amplifier or modulator. This tube is also recommended for voltage-regulator applications where high current capability and low tube drop are important. Up to 20 kW of plate power can be dissipated on its water-cooled anode. Except for plate dissipation, the tube is electrically identical to the 3CX10,000A1/8158.

**CHARACTERISTICS**

Plate Dissipation (Max.) . . . . . 20,000 watts  
 Grid Dissipation (Max.) . . . . . 100 watts  
 Frequency for Max. Ratings (CW) . . . . . 110 MHz  
 Cooling . . . . . Water and Forced Air  
 Filament . . . . . Thoriated tungsten  
 Voltage . . . . . 7.5 volts  
 Current . . . . . 99.0 amperes  
 Capacitances (Gnd. Cath. Connection):  
 Input . . . . . 51.0 pF  
 Output . . . . . 4.0 pF  
 Feed-through . . . . . 29.0 pF  
 Amplification Factor . . . . . 6.0  
 Transconductance . . . . . 20,000  $\mu$ mhos  
 Base . . . . . Coaxial  
 Recommended Air-System Socket . . . . . SK-300  
 Maximum Seal Temperature . . . . . 250°C  
 Maximum Length . . . . . 11.22 in; 284.90 mm  
 Maximum Diameter . . . . . 4.65 in; 118.10 mm  
 Weight (approximate) . . . . . 11.5 lb; 5.2 kg  
 Operating Position . . . . . Vertical, base up or down

Class of Operation	Type of Service	MAXIMUM RATINGS		TYPICAL OPERATION				
		Plate Voltage (volts)	Plate Current (amps)	Driven Element	Plate Voltage (volts)	Plate Current (amps)	Drive Power (watts)	Output Power (watts)
C	RF Industrial Oscillator	5000	4.0	—	5000	2.8	385	11,000
AB <sub>1</sub>	AF Amplifier or Modulator	7000	5.0	Grid	7000	7.0*	0	29,100*
A	AF Amplifier or Modulator	7000	5.0	Grid	2500	4.0	0	1800
A	Voltage Regulator	10,000	5.0	Grid	5000	2.0	—	—

\*Two tubes.

†At  $I_b = 2.0$  A

**3CW20,000A3**

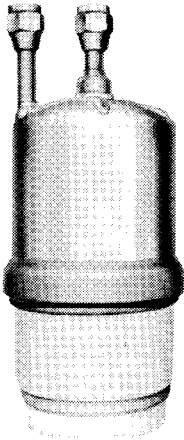

The 3CW20,000A3 is a ceramic/metal power triode intended primarily for use as a power oscillator in industrial-heating applications. It is also recommended for use as a grounded-grid FM amplifier, as a conventional plate-modulated amplifier, or as a linear amplifier.

**CHARACTERISTICS**

Plate Dissipation (Max.) . . . . . 20,000 watts  
 Grid Dissipation (Max.) . . . . . 250 watts  
 Frequency for Max. Ratings (CW) . . . . . 110 MHz  
 Cooling . . . . . Water and Forced Air  
 Filament . . . . . Thoriated tungsten  
 Voltage . . . . . 7.5 volts  
 Current . . . . . 99.0 amperes  
 Capacitances (Gnd. Cath. Connection):  
 Input . . . . . 53.0 pF  
 Output . . . . . 1.4 pF  
 Feed-through . . . . . 34.0 pF  
 Capacitances (Gnd. Grid Connection):  
 Input . . . . . 53.0 pF  
 Output . . . . . 34.0 pF  
 Feed-through . . . . . 1.4 pF  
 Amplification Factor . . . . . 20  
 Base . . . . . Coaxial  
 Recommended Air-System Socket . . . . . SK-1300  
 Maximum Seal Temperature . . . . . 250°C  
 Maximum Length . . . . . 11.22 in; 285.00 mm  
 Maximum Diameter . . . . . 4.65 in; 118.10 mm  
 Weight (approximate) . . . . . 11.5 lb; 5.2 kg  
 Operating Position . . . . . Vertical, base up or down

Class of Operation	Type of Service	MAXIMUM RATINGS		TYPICAL OPERATION				
		Plate Voltage (volts)	Plate Current (amps)	Driven Element	Plate Voltage (volts)	Plate Current (amps)	Drive Power (watts)	Output Power (watts)
C	RF Power Amplifier	7000	4.0	Cath.	7000	4.0	4100	24,500
C	RF Power Amplifier Plate Modulated	5500	3.0	Grid	5000	3.0	515	12,400
C	RF Industrial Oscillator	7000	4.0	—	7000	4.0	—	22,400
AB <sub>2</sub>	RF Linear Amplifier	7000	5.0	Cath.	7000	4.0	2050	20,000



External Anode, Water Cooled Triodes  
**3CW20,000A7**

**CHARACTERISTICS**

The 3CW20,000A7 is a ceramic/metal power triode intended to be used as a zero-bias Class-B amplifier in audio or radio-frequency applications. Operation with zero grid bias offers circuit simplicity by eliminating the bias supply. In addition, grounded-grid operation is attractive since a power gain as high as twenty times can be obtained.

The 3CW20,000A7 is electrically identical to the air-cooled 3CX10,000A7 except for its 20kW plate dissipation rating.

- Plate Dissipation (Max.) . . . . . 20,000 watts
- Grid Dissipation (Max.) . . . . . 500 watts
- Frequency for Max. Ratings (CW) . . . . . 110 MHz
- Cooling . . . . . Water and Forced Air
- Filament . . . . . Thoriated tungsten
- Voltage . . . . . 7.5 volts
- Current . . . . . 99.0 amperes
- Capacitances (Gnd. Cath. Connection):
- Input . . . . . 59.0 pF
- Output . . . . . 0.2 pF
- Feed-through . . . . . 36.0 pF
- Capacitances (Gnd. Grid Connection)
- Input . . . . . 59.0 pF
- Output . . . . . 36.0 pF
- Feed-through . . . . . 0.2 pF
- Amplification Factor . . . . . 200
- Base . . . . . Coaxial
- Recommended Air-System Socket . . . . . SK-1300
- Maximum Seal Temperature . . . . . 250°C
- Maximum Length . . . . . 11.22 in; 285.00 mm
- Maximum Diameter . . . . . 4.65 in; 118.10 mm
- Weight (approximate) . . . . . 11.5 lb; 5.2 kg
- Operating Position . . . . . Vertical, base up or down

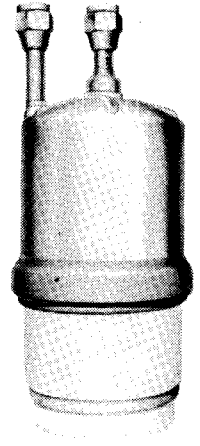

Class of Operation	Type of Service	MAXIMUM RATINGS		TYPICAL OPERATION				
		Plate Voltage (volts)	Plate Current (amps)	Driven Element	Plate Voltage (volts)	Plate Current (amps)	Drive Power (watts)	Output Power (watts)
C	RF Power Amplifier	7000	4.0	Grid	7000	4.0	530	21,300
C	RF Power Amplifier Plate Modulated	5500	3.0	Grid	5000	3.0	380	11,900
B	RF Linear Amplifier	7000	5.0	Cath.	7000	5.0	1540	24,200
B	RF Linear Amplifier (AM Service)	7000	5.0	Cath.	7000	2.4	330	5650†
B	AF Amplifier or Modulator	7000	5.0	Grid	7000	10.0*	560	47,700*

\*Two tubes.

†Carrier Power.

**3CW20,000H3**

**CHARACTERISTICS**

The 3CW20,000H3 is a water-cooled, ceramic/metal power triode designed primarily for use in industrial radio-frequency heating services. Its water-cooled anode is conservatively rated at 20 kW of plate dissipation with low water flow and pressure drop.

Input of 40 kilowatts is permissible up to 90 MHz. Plentiful reserve emission is available from its 750 watt filament. The grid structure is rated at 250 watts, making this tube an excellent choice for severe applications.

- Plate Dissipation (Max.) . . . . . 20,000 watts
- Grid Dissipation (Max.) . . . . . 250 watts
- Frequency for Max. Ratings (CW) . . . . . 90 MHz
- Cooling . . . . . Water and Forced Air
- Filament . . . . . Thoriated tungsten
- Voltage . . . . . 7.5 volts
- Current . . . . . 99.0 amperes
- Capacitances (Gnd. Cath. Connection):
- Input . . . . . 53.0 pF
- Output . . . . . 1.4 pF
- Feed-through . . . . . 34.0 pF
- Amplification Factor . . . . . 20
- Base . . . . . Flexible filament leads
- Maximum Seal Temperature . . . . . 250°C
- Maximum Flexible Lead Temperature . . . . . 175°C
- Maximum Length . . . . . 18.25 in; 463.50 mm
- Maximum Diameter . . . . . 6.75 in; 171.40 mm
- Weight (approximate) . . . . . 12 lb; 5.5 kg
- Operating Position . . . . . Vertical, base up or down

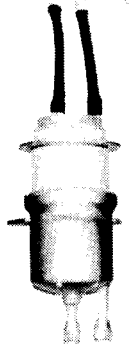

Class of Operation	Type of Service	MAXIMUM RATINGS		TYPICAL OPERATION			
		Plate Voltage (volts)	Plate Current (amps)	Plate Voltage (volts)	Plate Current (amps)	Drive Power (watts)	Output Power (watts)
C	RF Industrial Oscillator	12,000	4.0	10,000	4.0	340	28,000

**External Anode, Water Cooled Triodes**  
**3CW20,000H7**

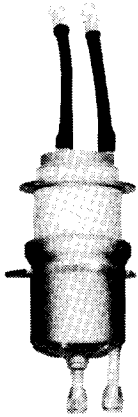

The 3CW20,000H7 is a ceramic/metal power triode intended for use as a dc voltage or current regulator, or in high-voltage switch tube or pulsed regulator service.

In addition, since the tube is identical to the 3CW20,000A7 except for the anode and grid flanges and the addition of the filament flying leads, the tube is useful as a zero-bias Class B amplifier in audio or RF applications. Operation with zero grid bias offers circuit simplicity by eliminating the bias supply. In addition, grounded-grid operation is attractive since a power gain as high as twenty times can be obtained.

The anode dissipation rating is 20 kW with water cooling.

**CHARACTERISTICS**

- Plate Dissipation (Max.) . . . . . 20,000 watts
- Grid Dissipation (Max.) . . . . . 500 watts
- Frequency for Max. Ratings (CW) . . . . . 110 MHz
- Cooling . . . . . Water and Forced Air
- Filament . . . . . Thoriated tungsten
- Voltage . . . . . 7.5 volts
- Current . . . . . 100 amperes
- Capacitances (Gnd. Cath. Connection):
- Input . . . . . 59.0 pF
- Output . . . . . 0.2 pF
- Feed-through . . . . . 36.0 pF
- Amplification Factor . . . . . 200
- Base . . . . . Flexible filament leads
- Maximum Seal Temperature . . . . . 250°C
- Maximum Flexible Lead Temperature . . . . . 175°C
- Maximum Length . . . . . 20.70 in; 525.80 mm
- Maximum Diameter . . . . . 6.75 in; 171.40 mm
- Weight (approximate) . . . . . 12 lb; 5.5 kg
- Operating Position . . . . . Vertical, base up or down

Class of Operation	Type of Service	MAXIMUM RATINGS		TYPICAL OPERATION				
		Plate Voltage (volts)	Plate Current (amps)	Driven Element	Plate Voltage (volts)	Plate Current (amps)	Drive Power (watts)	Output Power (watts)
B	RF Amplifier	7000	5.0	Cath.	7000	5.0	1540	24,200
B	RF Linear Amplifier (AM Service)	7000	5.0	Cath.	7000	2.4	330	5650†
B	AF Amplifier or Modulator	7000	5.0	Grid	7000	10.0*	560	47,700*

\*Two tubes.

†Carrier Power.

**3CW30,000H3**

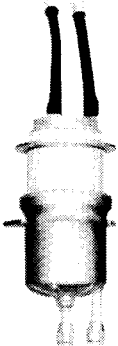

The 3CW30,000H3 is a water-cooled, ceramic/metal power triode designed primarily for use in industrial radio-frequency heating services. Its water-cooled anode is conservatively rated at 30 kW of plate dissipation with low water flow and pressure drop.

Input of 60 kW is permissible from its one kilowatt filament. The grid structure is rated at 500 watts making this tube an excellent choice for severe applications.

**CHARACTERISTICS**

- Plate Dissipation (Max.) . . . . . 30,000 watts
- Grid Dissipation (Max.) . . . . . 500 watts
- Frequency for Max. Ratings (CW) . . . . . 90 MHz
- Cooling . . . . . Water and Forced Air
- Filament . . . . . Thoriated tungsten
- Voltage . . . . . 6.3 volts
- Current . . . . . 160 amperes
- Capacitances (Gnd. Cath. Connection):
- Input . . . . . 53.0 pF
- Output . . . . . 1.4 pF
- Feed-through . . . . . 34.0 pF
- Amplification Factor . . . . . 20
- Base . . . . . Flexible filament leads
- Maximum Seal Temperature . . . . . 250°C
- Maximum Flexible Lead Temperature . . . . . 175°C
- Maximum Length . . . . . 18.50 in; 469.90 mm
- Maximum Diameter . . . . . 6.75 in; 171.40 mm
- Weight (approximate) . . . . . 12 lb; 5.5 kg
- Operating Position . . . . . Vertical, base up or down

Class of Operation	Type of Service	MAXIMUM RATINGS		TYPICAL OPERATION			
		Plate Voltage (volts)	Plate Current (amps)	Plate Voltage (volts)	Plate Current (amps)	Drive Power (watts)	Output Power (watts)
C	RF Industrial Oscillator	12,000	6.0	10,000	6.0	365	42,000

External Anode, Water Cooled Triodes  
**3CW30,000H7**

**CHARACTERISTICS**

The 3CW30,000H7 is a water-cooled, ceramic/metal power triode designed for use as a zero-bias Class B RF amplifier, Class C power amplifier or oscillator, or for voltage regulator service. Its water-cooled anode is conservatively rated at 30 kW of dissipation capability with low water flow and pressure drop.

Input of 48 kW is permissible up to 110 MHz. Plentiful reserve emission is available from its one kilowatt filament.

Class B operation with zero grid bias offers circuit simplification by eliminating the bias supply. In addition, grounded grid operation is attractive since a power gain as high as twenty times can be obtained.

- Plate Dissipation (Max.) . . . . . 30,000 watts
- Grid Dissipation (Max.) . . . . . 500 watts
- Frequency for Max. Ratings (CW) . . . . . 110 MHz
- Cooling . . . . . Water and Forced Air
- Filament . . . . . Thoriated tungsten
- Voltage . . . . . 6.3 volts
- Current . . . . . 160 amperes
- Capacitances (Gnd. Cath. Connection)
- Input . . . . . 56.0 pF
- Output . . . . . 0.2 pF
- Feed-through . . . . . 36.0 pF
- Capacitances (Gnd. Grid Connection):
- Input . . . . . 56.0 pF
- Output . . . . . 36.0 pF
- Feed-through . . . . . 0.2 pF
- Amplification Factor . . . . . 200
- Base . . . . . Flexible filament leads
- Maximum Seal Temperature . . . . . 250°C
- Maximum Flexible Lead Temperature . . . . . 175°C
- Maximum Length . . . . . 18.50 in; 469.90 mm
- Maximum Diameter . . . . . 6.75 in; 171.40 mm
- Weight (approximate) . . . . . 12 lb; 5.5 kg
- Operating Position . . . . . Vertical, base up or down



Class of Operation	Type of Service	MAXIMUM RATINGS		TYPICAL OPERATION				
		Plate Voltage (volts)	Plate Current (amps)	Driven Element	Plate Voltage (volts)	Plate Current (amps)	Drive Power (watts)	Output Power (watts)
C	RF Power Amplifier	8000	5.0	Grid	7000	4.0	430	21,300
AB	RF Linear Amplifier	8000	6.0	Cath.	7000	5.0	1540	24,200
A	Voltage Regulator	28,000	6.0	Grid	—	—	—	—

**3CW40,000H3**

**CHARACTERISTICS**

The 3CW40,000H3 is a water-cooled, ceramic/metal power triode designed primarily for use in industrial radio-frequency heating services. Its water-cooled anode is conservatively rated at 40 kW of plate dissipation with low waterflow and pressure drop.

Input of 80 kW is permissible up to 90 MHz. Plentiful reserve emission is available from its 1500 watt filament. The grid structure is rated at 750 watts, making this tube an excellent choice for severe applications.

- Plate Dissipation (Max.) . . . . . 40,000 watts
- Grid Dissipation (Max.) . . . . . 750 watts
- Frequency for Max. Ratings (CW) . . . . . 90 MHz
- Cooling . . . . . Water and Forced Air
- Filament . . . . . Thoriated tungsten
- Voltage . . . . . 10.0 volts
- Current . . . . . 160 amperes
- Capacitances (Gnd. Cath. Connection):
- Input . . . . . 70.0 pF
- Output . . . . . 2.3 pF
- Feed-through . . . . . 43.0 pF
- Amplification Factor . . . . . 20
- Base . . . . . Flexible filament leads
- Maximum Seal Temperature . . . . . 250°C
- Maximum Flexible Lead Temperature . . . . . 175°C
- Maximum Length . . . . . 21.23 in; 539.20 mm
- Maximum Diameter . . . . . 6.75 in; 171.40 mm
- Weight (approximate) . . . . . 14 lb; 6.4 kg
- Operating Position . . . . . Vertical, base up or down

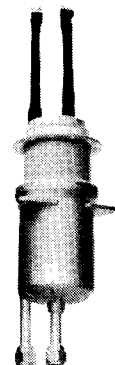

Class of Operation	Type of Service	MAXIMUM RATINGS		TYPICAL OPERATION			
		Plate Voltage (volts)	Plate Current (amps)	Plate Voltage (volts)	Plate Current (amps)	Drive Power (watts)	Output Power (watts)
C	RF Industrial Oscillator	12,000	9.0	10,000	9.0	1040	70,000

External Anode, Water Cooled Triodes

**6696A**



The 6696A is a water-cooled, ceramic/metal triode designed for industrial heating service. It is recommended also for use in broadcast and communications amplifiers.

Low-loss ceramic and metal construction permits operation at full ratings at frequencies up to 30 MHz. Useful power output can be obtained at frequencies up to 60 MHz at reduced plate voltage.

The 6696A anode is capable of dissipating 60 kW at a moderate rate of water flow. A forced-air cooled version of this tube, type 6697A, and a vapor cooled version, type 7480, are also available.

**CHARACTERISTICS**

- Plate Dissipation (Max.) . . . . . 60,000 watts
- Grid Dissipation (Max.) . . . . . 1,000 watts
- Frequency for Max. Ratings (CW) . . . . . 30 MHz
- Cooling . . . . . Water and Forced Air
- Filament . . . . . Thoriated tungsten
- Voltage . . . . . 13.0 volts
- Current . . . . . 200 amperes
- Capacitances (Gnd. Cath. Connection):
- Input . . . . . 75.0 pF
- Output . . . . . 2.6 pF
- Feed-through . . . . . 52.0 pF
- Amplification Factor . . . . . 20
- Base . . . . . Coaxial
- Maximum Seal & Envelope Temperature . . . . . 200°C
- Maximum Length . . . . . 19.87 in; 504.80 mm
- Maximum Diameter . . . . . 5.28 in; 134.10 mm
- Weight (approximate) . . . . . 17 lb; 7.7 kg
- Operating Position . . . . . Vertical, base up

Class of Operation	Type of Service	MAXIMUM RATINGS		TYPICAL OPERATION				
		Plate Voltage (volts)	Plate Current (amps)	Driven Element	Plate Voltage (volts)	Plate Current (amps)	Drive Power (watts)	Output Power (watts)
C	RF Power Amplifier	16,000	11.0	Grid	15,000	7.0	600	80,000
C	RF Power Amplifier Plate Modulated	10,000	8.5	Grid	9500	8.4	2000	60,000
AB	RF Linear Amplifier	16,000	11.0	Cath.	12,000	9.8	8200	83,000
AB	RF Linear Amplifier (AM Service)	16,000	9.0	Grid	12,000	6.8	1500	28,000
AB	AF Amplifier or Modulator	16,000	11.0	Grid	12,000	20.0*	600	152,000*

\*Two tubes.

**8240** see 3CW5000A1

**8241** see 3CW5000F1

**8242** see 3CW5000A3

**8243** see 3CW5000F3

External Anode, Water Cooled Triodes  
**X-2176**

The X-2176 industrial triode is designed for very high power industrial heating service in the megawatt power range.

The X-2176 has a two-section thoriated-tungsten cathode mounted on water-cooled supports. The two sections may be fed in quadrature, series, or parallel. The maximum anode dissipation of the tube is 1,250,000 watts steady-state.

Provision is made for large-diameter coaxial terminals to the grid and the three RF cathode terminals. Filament power and filament support cooling water connections are made through three special couplings with knurled and threaded clamping rings.

**TENTATIVE CHARACTERISTICS\***

- Plate Dissipation (Max.) . . . . . 1,250,000 watts
- Grid Dissipation (Max.) . . . . . 12,000 watts
- Frequency for Max. Ratings (CW) . . . . . 30 MHz
- Cooling . . . . . Water and Forced Air
- Filament . . . . . Two section, Thoriated tungsten
- Voltage/section . . . . . 18.5 volts
- Current/section . . . . . 700 amperes
- Capacitances (Gnd. Cath. Connection):
- Input . . . . . 900 pF
- Output . . . . . 25.0 pF
- Feed-through . . . . . 350 pF
- Amplification Factor . . . . . 20
- Base . . . . . Special
- Recommended Cooling Water/Filament
- Power Connector (3 required) . . . Eimac SK-2310
- Recommended RF Return Connector,
- Filament to Ground (1 required) . Eimac SK-2315
- Maximum Seal & Anode Core Temperature . . . 200°C
- Maximum Length . . . . . 25.31 in; 642.90 mm
- Maximum Diameter . . . . . 17.03 in; 432.60 mm
- Weight (approximate) . . . . . 170 lb; 77 kg
- Operation Position . . . . . Vertical, base down

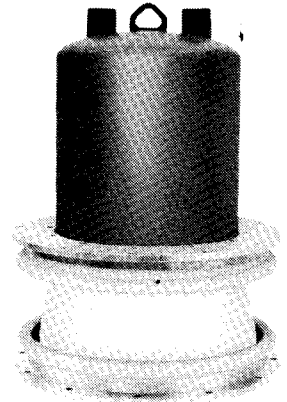

Class of Operation	Type of Service	MAXIMUM RATINGS		TYPICAL OPERATION					
		Plate Voltage (volts)	Plate Current (amps)	Freq. (MHz)	Driven Element	Plate Voltage (volts)	Plate Current (amps)	Drive Power (watts)	Output Power (kilowatts)
C	RF Power Amplifier	20,000	125	30	—	20,000	123	—	2090

\*The design of this tube is subject to change, and this data is supplied for guidance only. Before establishing any equipment design for this tube contact: Product Manager, EIMAC Div. of Varian.

†Cathode current maximum.

**X-2177**

The X-2177 industrial triode is designed for very high power industrial heating service in the half-megawatt power range.

The X-2177 has a thoriated-tungsten cathode mounted on water-cooled supports. The maximum anode dissipation of the tube is 650,000 watts steady-state.

Provision is made for large-diameter coaxial terminals to the grid and the two RF cathode terminals. Filament power and filament support cooling-water connections are made through two special couplings with knurled and threaded clamping rings.

**TENTATIVE CHARACTERISTICS\***

- Plate Dissipation (Max.) . . . . . 625,000 watts
- Grid Dissipation (Max.) . . . . . 6000 watts
- Frequency for Max. Ratings (CW) . . . . . 30 MHz
- Cooling . . . . . Water and Forced Air
- Filament . . . . . Thoriated tungsten
- Voltage . . . . . 18.5 volts
- Current . . . . . 700 amperes
- Capacitances (Gnd. Cath. Connection):
- Input . . . . . 350 pF
- Output . . . . . 15.0 pF
- Feed-through . . . . . 210 pF
- Base . . . . . Special
- Recommended Cooling Water/Filament
- Power Connector (2 required) . . . Eimac SK-2310
- Recommended RF Return Connector,
- Filament to Ground (1 required) . Eimac SK-2315
- Maximum Seal & Anode Core Temperature . . . 200°C
- Maximum Length . . . . . 16.85 in; 428.00 mm
- Maximum Diameter . . . . . 17.03 in; 432.60 mm
- Weight (approximate) . . . . . 100 lb; 45 kg
- Operating Position . . . . . Vertical, base down

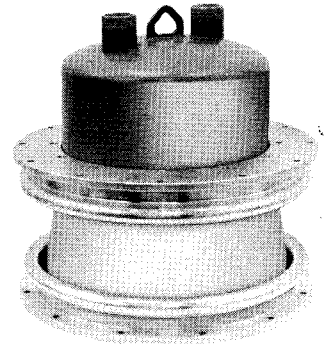

Class of Operation	Type of Service	MAXIMUM RATINGS		TYPICAL OPERATION					
		Plate Voltage (volts)	Plate Current (amps)	Freq. (MHz)	Driven Element	Plate Voltage (volts)	Plate Current (amps)	Drive Power (watts)	Output Power (kilowatts)
C	RF Power Amplifier	20,000	65	30	—	20,000	60	—	1050

\*The design of this tube is subject to change, and this data is supplied for guidance only. Before establishing any equipment design for this tube contact: Product Manager, EIMAC Div. of Varian.

†Cathode current maximum.

Internal Anode, Radiation Cooled Triodes

# 3-400Z/8163

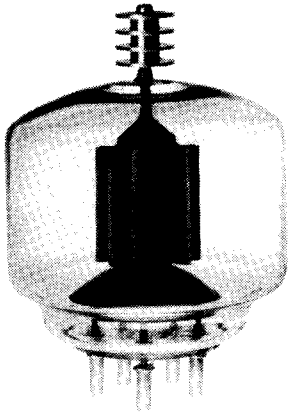

The 3-400Z/8163 is intended for use as a zero-bias Class B amplifier, in audio or radio-frequency applications, or in Class C service.

Operation with zero grid bias simplifies associated circuitry by eliminating the bias supply, and grounded grid operation is attractive since a power gain as high as twenty times can be obtained with this tube in a cathode-driven circuit.

## CHARACTERISTICS

- Plate Dissipation (Max.) . . . . . 400 watts
- Grid Dissipation (Max.) . . . . . 20 watts
- Frequency for Max. Ratings (CW) . . . . . 110 MHz
- Cooling . . . . . Radiation and Forced Air
- Filament . . . . . Thoriated tungsten
- Voltage . . . . . 5.0 volts
- Current . . . . . 14.1 amperes
- Capacitances (Gnd. Grid Connection):
- Input . . . . . 7.5 pF
- Output . . . . . 4.1 pF
- Feed-through . . . . . 0.10 pF
- Amplification Factor . . . . . 200
- Base . . . . . 5 Pin Special
- Recommended Air-System Socket . . . . . SK-410
- Recommended Air Chimney . . . . . SK-416
- Maximum Seal Temperature . . . . . 200°C
- Maximum Length . . . . . 5.37 in; 136.40 mm
- Maximum Diameter . . . . . 3.56 in; 90.40 mm
- Weight (approximate) . . . . . 7.0 oz; 198.0 gm
- Operating Position . . . . . Vertical, base up or down

Class of Operation	Type of Service	MAXIMUM RATINGS		TYPICAL OPERATION				
		Plate Voltage (volts)	Plate Current (amps)	Driven Element	Plate Voltage (volts)	Plate Current (amps)	Drive Power (watts)	Output Power (watts)
C	RF Power Amplifier	4000	0.35	Grid	3000	0.33	25	730
C	RF Power Amplifier Plate Modulated	3000	0.27	Grid	3000	0.24	18	550
B	RF Linear Amplifier	4000	0.40	Cath.	2500	0.27	44	560
B	AF Amplifier or Modulator	4000	0.40	Grid	3000	0.66*	26	1310*

\*Two tubes

# 3-500Z

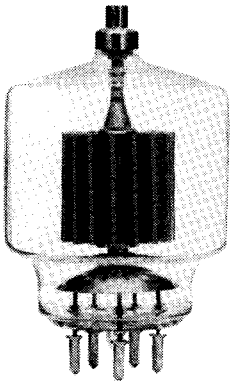

The 3-500Z is intended for use as a zero-bias Class B amplifier in audio or radio frequency applications, or in Class C service.

Operation with zero grid bias simplifies associated circuitry by eliminating the bias supply and grounded grid operation is attractive since a power gain as high as twenty times can be obtained with this tube in a cathode-driven circuit.

## CHARACTERISTICS

- Plate Dissipation (Max.) . . . . . 500 watts
- Grid Dissipation (Max.) . . . . . 20 watts
- Frequency for Max. Ratings (CW) . . . . . 110 MHz
- Cooling . . . . . Radiation and Forced Air
- Filament . . . . . Thoriated tungsten
- Voltage . . . . . 5.0 volts
- Current . . . . . 14.1 amperes
- Capacitances (Gnd. Grid Connection):
- Input . . . . . 8.3 pF
- Output . . . . . 4.7 pF
- Feed-through . . . . . 0.1 pF
- Amplification Factor . . . . . 130
- Base . . . . . 5 Pin Special
- Recommended Air-System Socket . . . . . SK-410
- Recommended Air Chimney . . . . . SK-406
- Recommended Heat Dissipating Connector . . . . . HR-6
- Maximum Plate Seal Temperature . . . . . 225°C
- Maximum Base Seal Temperature . . . . . 200°C
- Maximum Length . . . . . 6.00 in; 152.40 mm
- Maximum Diameter . . . . . 3.44 in; 87.40 mm
- Weight (approximate) . . . . . 7.0 oz; 198.0 gm
- Operating Position . . . . . Vertical, base up or down

Class of Operation	Type of Service	MAXIMUM RATINGS		TYPICAL OPERATION				
		Plate Voltage (volts)	Plate Current (amps)	Driven Element	Plate Voltage (volts)	Plate Current (amps)	Drive Power (watts)	Output Power (watts)
C	RF Power Amplifier	3000	0.27	Grid	3000	0.27	25	640
C	RF Power Amplifier Plate Modulated	4000	0.35	Grid	3000	0.35	30	720†
AB <sub>2</sub>	RF Linear Amplifier	4000	0.40	Cath.	3000	0.33	87	750†
AB <sub>2</sub>	AF Amplifier or Modulator	4000	0.40	Cath.	3000	0.40	—	740†
				Grid	3000	0.77*	25	1420*

\*Two tubes.

†Useful, delivered to the load.

Internal Anode, Radiation Cooled Triodes  
**3-1000Z/8164**

**CHARACTERISTICS**

The 3-1000Z/8164 is intended for use as a Class B amplifier in either the grid or cathode driven connection, for Class C amplifier service, or as Class B audio amplifiers or modulators. At a plate voltage of 3000 volts, 2 kW PEP input can be run with a single 3-1000Z, providing a power gain of over 20 in a cathode-driven circuit.

- Plate Dissipation (Max.) . . . . . 1000 watts
- Grid Dissipation (Max.) . . . . . 50 watts
- Frequency for Max. Ratings (CW) . . . . . 110 MHz
- Cooling . . . . . Radiation and Forced Air
- Filament . . . . . Thoriated tungsten
- Voltage . . . . . 7.5 volts
- Current . . . . . 21.4 amperes
- Capacitances (Gnd. Cath. Connection):
- Input . . . . . 17.0 pF
- Output . . . . . 0.2 pF
- Feed-through . . . . . 7.5 pF
- Capacitances (Gnd. Grid Connection):
- Input . . . . . 17.0 pF
- Output . . . . . 7.5 pF
- Feed-through . . . . . 0.2 pF
- Amplification Factor . . . . . 200
- Base . . . . . 5 Pin Special
- Recommended Air-System Socket . . . . . SK-510
- Recommended Air Chimney . . . . . SK-516
- Recommended Heat Dissipating Connector . . . . . HR-8
- Maximum Plate Seal Temperature . . . . . 225°C
- Maximum Base Seal Temperature . . . . . 200°C
- Maximum Length . . . . . 7.88 in; 200.20 mm
- Maximum Diameter . . . . . 5.25 in; 133.40 mm
- Weight (approximate) . . . . . 1.2 lb; 0.54 kg
- Operating Position . . . . . Vertical, base up or down

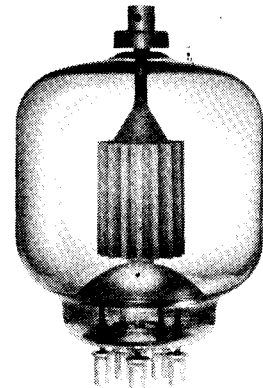

Class of Operation	Type of Service	MAXIMUM RATINGS		TYPICAL OPERATION				
		Plate Voltage (volts)	Plate Current (amps)	Driven Element	Plate Voltage (volts)	Plate Current (amps)	Drive Power (watts)	Output Power (watts)
C	RF Power Amplifier	6000	0.70	Grid	6000	0.70	57	3200
C	RF Power Amplifier Plate Modulated	4500	0.55	Grid	4500	0.50	35	1765
B	RF Linear Amplifier	6000	0.80	Cath.	3000	0.67	47	1080
B	AF Amplifier or Modulator	6000	0.80	Grid	5000	1.0*	28	3560*

\*Two tubes.

**8163** see 3-400Z  
**8164** see 3-1000Z

External Anode, Conduction-Cooled Triode

**8873**

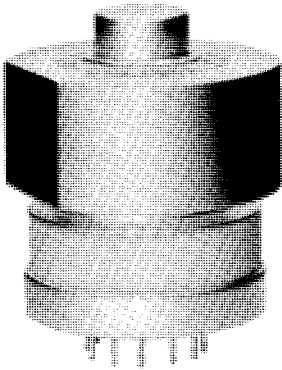

This compact external-anode, ceramic/metal high-mu triode is intended for use in zero-bias Class-B or AB amplifiers in audio or radio-frequency applications, but may also be used in Class-C service or as a pulse modulator or regulator.

The 8873 is designed for conduction cooling and is nominally rated for 200 watts of anode dissipation. A beryllium-oxide thermal link is available to insulate the anode from the heat sink while allowing for heat conduction from the anode to the sink.

Operation with zero bias simplifies associated circuitry by eliminating the bias supply. In addition, grounded-grid operation is attractive since a power gain as high as twenty times can be obtained with an 8873 in a cathode-driven circuit.

**CHARACTERISTICS**

- Plate Dissipation<sup>1</sup> (Max.) . . . . . 200 watts
- Grid Dissipation (Max.) . . . . . 5 watts
- Frequency for Max. Ratings (CW) . . . . . 500 MHz
- Cooling . . . . . Conduction
- Cathode . . . . . Oxide-coated Unipotential
- Voltage . . . . . 6.3 volts
- Current . . . . . 3.0 amperes
- Capacitances (Gnd. Cath. Connection)
  - Input . . . . . 20.5 pF
  - Output . . . . . 0.03 pF
  - Feed-through . . . . . 6.0 pF
- Capacitances (Gnd. Grid Connection)
  - Input . . . . . 20.5 pF
  - Output . . . . . 6.0 pF
  - Feed-through . . . . . 0.03 pF
  - Cathode to heater . . . . . 6.0 pF
- Transconductance†† . . . . . 29,000 μmhos
- Base . . . . . Large Wafer Elevenar 11-Pin with ring (JEDEC No. E11-81)
- Recommended BeO Thermal Link . . . . . EIMAC SK-1920
- Maximum Seal & Anode Core Temperature . . . . . 250°C
- Maximum Length . . . . . 2.14 in; 54.41 mm
- Maximum Diameter . . . . . 1.64 in; 41.66 mm
- Weight (approximate) . . . . . 8.5 oz; 241 gm
- Operating Position . . . . . Any

<sup>1</sup>Dissipation capability is dependent on cooling technique.

Class of Operation	Type of Service	MAXIMUM RATINGS		TYPICAL OPERATION					
		Plate Voltage (volts)	Plate Current (amps)	Freq. (MHz)	Driven Element	Plate Voltage (volts)	Plate Current (amps)	Drive Power (watts)	Output Power (watts)
AB <sub>2</sub>	RF Linear Amplifier	2200	0.35	30	Cath.	2000	0.50* 0.31**	26	587†
AB <sub>2</sub>	RF Linear Amplifier	2200	0.35	150	Cath.	2000	0.40* 0.245*	17.5	526†
AB <sub>2</sub>	RF Linear Amplifier	2200	0.35	432	Cath.	2000	0.50* 0.30**	27	505†
C	RF Power Amplifier	2200	0.35	110	Grid	2000	0.250	9.0	305†
—	Pulse Modulator or Regulator	4500	6.0						

\*Single-tone Intermittent Voice Service value  
 \*\*Two-tone plate current  
 †Useful power output  
 ††At I<sub>b</sub> = 250 mA



# 4CPX250K/8590

## CHARACTERISTICS

The 4CPX250K/8590 is a compact forced-air cooled, external anode radial-beam tetrode, intended for wideband grid-pulsed radio frequency amplifier and pulse modulator service.

The 4CPX250K/8590 has a maximum anode dissipation of 250 watts and is capable of delivering pulse output power in excess of 10 kW with 10 dB gain when cathode driven at 450 MHz.

The tube is of coaxial construction and especially designed for cavity operation.

- Plate Dissipation (Max.) . . . . . 250 watts
- Screen Dissipation (Max.) . . . . . 12 watts
- Grid Dissipation (Max.) . . . . . 2 watts
- Frequency for Max. Ratings (CW) . . . . . 500 MHz
- (Pulsed) . . . . . 500 MHz
- Cooling . . . . . Forced Air
- Cathode . . . . . Oxide-coated Unipotential
- Voltage . . . . . 6.0 volts
- Current . . . . . 2.7 amperes
- Capacitances (Gnd. Grid Connection):
- Input . . . . . 14.0 pF
- Output . . . . . 4.1 pF
- Feed-through . . . . . 0.006 pF
- Amplification Factor (g<sub>1</sub>-g<sub>2</sub>) . . . . . 5
- Base . . . . . Coaxial
- Maximum Seal & Anode Core Temperature . . . . . 250°C
- Maximum Length . . . . . 2.81 in; 71.40 mm
- Maximum Diameter . . . . . 1.64 in; 41.60 mm
- Weight (approximate) . . . . . 4 oz; 114 gm
- Operating Position . . . . . Any

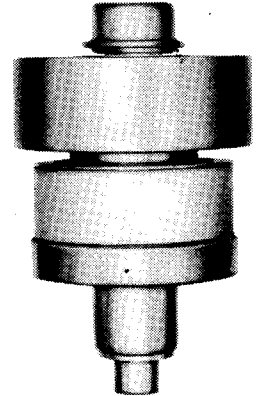

Class of Operation	Type of Service	MAXIMUM RATINGS		TYPICAL OPERATION					
		Plate Voltage (volts)	Plate Current (amps)	Freq. (MHz)	Plate Voltage (volts)	Screen Voltage (volts)	Plate Current (amps)	Drive Power (watts)	Output Power (watts)
C	RF Power Amplifier	2500	0.25	—	2500	250	0.25	2.8	500
C or B	RF Power Amplifier Grid & Screen Pulsed	5500	6.0†	500	5500	1000†	—	1000†	10,000‡
—	Switch Tube or Pulse Modulator	7000	6.0†	—	6000	750	3.5†	—	17,500†

†Pulse value

‡Useful Power Output

External Anode, Forced Air Cooled Tetrodes

**4CX250B/7203**  
**4CX250FG/8621**

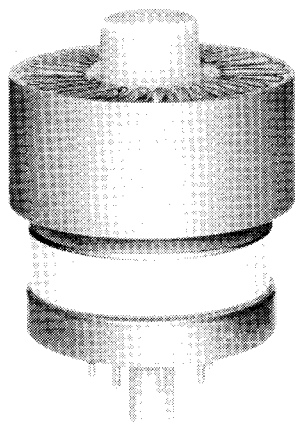

The 4CX250B/7203 and 4CX250FG/8621 are ceramic/metal forced-air cooled, external-anode radial-beam tetrodes with a maximum radial-plate dissipation rating of 250 watts and a maximum input-power rating of 500 watts. The 4CX250B/7203 is designed to operate with a heater voltage of 6.0 volts, while the 4CX250FG/8621 is designed for operation at a heater voltage of 26.5 volts. Otherwise, the two tube types have identical characteristics.

**CHARACTERISTICS**

- Plate Dissipation (Max.) . . . . . 250 watts
- Screen Dissipation (Max.) . . . . . 12 watts
- Grid Dissipation (Max.) . . . . . 2 watts
- Frequency for Max. Ratings (CW) . . . . . 500 MHz
- Cooling . . . . . Forced Air
- Cathode . . . . . Oxide-coated Unipotential
- Voltage (4CX250B) . . . . . 6.0 volts
- (4CX250FG) . . . . . 26.5 volts
- Current (4CX250B) . . . . . 2.6 amperes
- (4CX250FG) . . . . . 0.54 amperes
- Capacitances (Gnd. Cath. Connection):
- Input . . . . . 15.7 pF
- Output . . . . . 4.5 pF
- Feed-through . . . . . 0.04 pF
- Capacitances (Gnd. Grid Connection):
- Input . . . . . 13.0 pF
- Output . . . . . 4.5 pF
- Feed-through . . . . . 0.01 pF
- Amplification Factor (g<sub>1</sub>-g<sub>2</sub>) . . . . . 5
- Base . . . . . 9-Pin Special
- Recommended Air-System Socket . . . . . SK-600 Series
- Recommended Air Chimney . . . . . SK-606 Series
- Maximum Seal & Anode Core Temperature . . . . . 250°C
- Maximum Length . . . . . 2.46 in; 62.50 mm
- Maximum Diameter . . . . . 1.64 in; 41.70 mm
- Weight (approximate) . . . . . 4 oz; 113 gm
- Operating Position . . . . . Any

Class of Operation	Type of Service	MAXIMUM RATINGS		TYPICAL OPERATION					
		Plate Voltage (volts)	Plate Current (amps)	Freq. (MHz)	Plate Voltage (volts)	Screen Voltage (volts)	Plate Current (amps)	Drive Power (watts)	Output Power (watts)
C	RF Power Amplifier	2000	0.25	175	2000	300	0.25	2.9	390
C	RF Power Amplifier Plate Modulated	1500	0.20	175	1500	250	0.20	1.7	235
AB <sub>1</sub>	RF Linear Amplifier	2000	0.25	175	2000	350	0.25	—	300
AB <sub>1</sub>	RF Linear Amplifier (AM Service)	2000	0.25	175	2000	350	0.15	—	65†
AB <sub>1</sub>	AF Amplifier or Modulator	2000	0.25	—	2000	350	0.50*	—	600*

\*Two tubes

†Carrier Power

External Anode, Forced Air Cooled Tetrodes  
**4CX250BC/8957**

**CHARACTERISTICS**

The 4CX250BC/8957 is a ceramic/metal, forced-air cooled, external-anode radial-beam tetrode with a maximum plate dissipation rating of 250 watts and a maximum input power rating of 500 watts. It is intended for use as an oscillator, amplifier, or modulator.

The 4CX250BC/8957 is especially recommended as a premium-quality replacement for the 4CX250B/7203, in applications where long life and consistent performance are of prime concern and the closer heater voltage tolerance and increased cathode warmup time are acceptable.

- Plate Dissipation (Max.) . . . . . 250 watts
- Screen Dissipation (Max.) . . . . . 12 watts
- Grid Dissipation (Max.) . . . . . 2 watts
- Frequency for Max. Ratings (CW) . . . . . 500 MHz
- Cooling . . . . . Forced Air
- Cathode . . . . . Oxide-coated Unipotential
- Voltage . . . . . 6.0 volts
- Current . . . . . 2.4 amperes
- Capacitances (Gnd. Cath. Connection):
- Input . . . . . 15.7 pF
- Output . . . . . 4.5 pF
- Feed-through . . . . . 0.04 pF
- Capacitances (Gnd. Grid Connection):
- Input . . . . . 13.0 pF
- Output . . . . . 4.5 pF
- Feed-through . . . . . 0.01 pF
- Amplification Factor ( $g_1$ - $g_2$ ) . . . . . 5
- Base . . . . . 9-Pin Special
- Recommended Air-System Socket . . . . . SK-600 Series
- Recommended Air Chimney . . . . . SK-606 Series
- Maximum Seal & Anode Core Temperature . . . . . 250°C
- Maximum Length . . . . . 2.46 in; 62.50 mm
- Maximum Diameter . . . . . 1.64 in; 41.70 mm
- Weight (approximate) . . . . . 4 oz; 113 gm
- Operating Position . . . . . Any

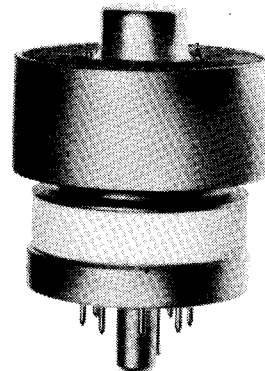

Class of Operation	Type of Service	MAXIMUM RATINGS		TYPICAL OPERATION					
		Plate Voltage (volts)	Plate Current (amps)	Freq. (MHz)	Plate Voltage (volts)	Screen Voltage (volts)	Plate Current (amps)	Drive Power (watts)	Output Power (watts)
C	RF Power Amplifier	2000	0.25	175	2000	300	0.25	2.9	390
C	RF Power Amplifier Plate Modulated	1500	0.20	175	1500	250	0.20	1.7	235
AB <sub>1</sub>	RF Linear Amplifier	2000	0.25	175	2000	350	0.25	—	300
AB <sub>1</sub>	RF Linear Amplifier (AM Service)	2000	0.25	175	2000	350	0.15	—	65†
AB <sub>1</sub>	AF Amplifier or Modulator	2000	0.25	—	2000	350	0.50*	—	600*

\*Two tubes

†Carrier Power

# External Anode, Forced Air Cooled Tetrodes 4CX250K/8245, 4CX250M/8246

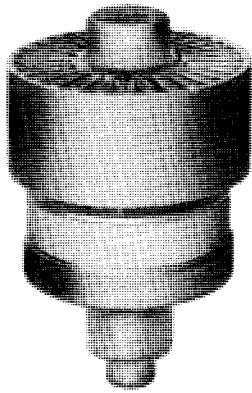

The 4CX250K/8245 is a compact, forced-air cooled, external-anode radial-beam tetrode with a maximum plate dissipation rating of 250 watts and a maximum input-power rating of 500 watts.

The tube has a 6.0 volt heater and all element terminals are coaxial so the tube lends itself to cavity designs for VHF and UHF service.

The 4CX250M/8246 is identical except it is designed for a heater voltage of 26.5 volts at a current of 0.50 amperes.

## CHARACTERISTICS

Plate Dissipation (Max.)	250 watts
Screen Dissipation (Max.)	.12 watts
Grid Dissipation (Max.)	.2 watts
Frequency for Max. Ratings (CW)	500 MHz
(Pulsed)	1500 MHz
Cooling	Forced Air
Cathode	Oxide-coated Unipotential
Voltage	6.0 volts
Current	2.7 amperes
Capacitances (Gnd. Cath. Connection):	
Input	27.0 pF
Output	4.7 pF
Feed-through	0.04 pF
Capacitances (Gnd. Grid Connection):	
Input	17.0 pF
Output	4.7 pF
Feed-through	0.01 pF
Amplification Factor (g <sub>1</sub> -g <sub>2</sub> )	5
Base	Special, Coaxial
Maximum Seal & Anode Core Temperature	250°C
Maximum Length	2.81 in; 71.40 mm
Maximum Diameter	1.64 in; 41.70 mm
Weight (approximate)	4 oz; 113 gm
Operating Position	Any

Class of Operation	Type of Service	MAXIMUM RATINGS		TYPICAL OPERATION					
		Plate Voltage (volts)	Plate Current (amps)	Freq. (MHz)	Plate Voltage (volts)	Screen Voltage (volts)	Plate Current (amps)	Drive Power (watts)	Output Power (watts)
C	RF Power Amplifier	2000	0.25	500	2000	300	0.25	—	225*
C	RF Power Amplifier Plate Modulated	1500	0.20	175	1500	250	0.20	1.7	300
C	RF Amplifier Plate & Screen Pulsed	7000	7.0†	1200	7000‡	1200‡	6.0	—	17,000§
B	RF Linear Amplifier TV Service	2000	0.25	216	2000	350	0.25	5.5	250
AB <sub>1</sub>	RF Linear Amplifier	2000	0.25	175	2000	350	0.25	—	300

\*Useful Power Output

†Cathode Current, pulse

‡Pulse Voltage Values

§Pulse Power

# 4CX250R/7580W

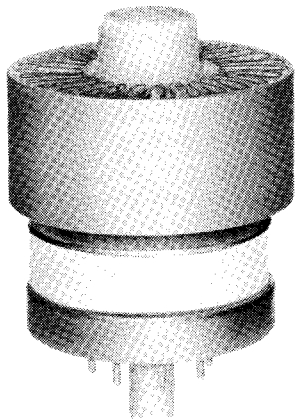

The 4CX250R/7580W is a compact, high-perveance radial-beam tetrode designed specifically for use in Class AB<sub>1</sub> linear amplifiers where shock and/or vibration preclude the use of non-ruggedized tube types. The 4CX250R will replace the 4CX250B in equipments where the range of bias adjustment will tolerate this higher perveance tube and where tuning range can compensate for the small differences in input and output capacitances.

The 4CX250R/7580W will deliver more output power in most linear amplifiers which presently employ the 4CX250B and it will operate with maximum rated plate and screen voltages applied in equipments where shock and/or vibration is experienced.

## CHARACTERISTICS

Plate Dissipation (Max.)	250 watts
Screen Dissipation (Max.)	.12 watts
Grid Dissipation (Max.)	.2 watts
Frequency for Max. Ratings (CW)	500 MHz
Cooling	Forced Air
Cathode	Oxide-coated Unipotential
Voltage	6.0 volts
Current	2.6 amperes
Capacitances (Gnd. Cath. Connection):	
Input	17.5 pF
Output	4.8 pF
Feed-through	0.04 pF
Amplification Factor (g <sub>1</sub> -g <sub>2</sub> )	5
Base	9-Pin Special
Recommended Air-System Socket	SK-600 Series
Recommended Air Chimney	SK-606 Series
Maximum Seal & Anode Core Temperature	250°C
Maximum Length	2.46 in; 62.50 mm
Maximum Diameter	1.64 in; 41.70 mm
Weight (approximate)	4 oz; 113 gm
Operating Position	Any

Class of Operation	Type of Service	MAXIMUM RATINGS		TYPICAL OPERATION				
		Plate Voltage (volts)	Plate Current (amps)	Plate Voltage (volts)	Screen Voltage (volts)	Plate Current (amps)	Drive Power (watts)	Output Power (watts)
AB <sub>1</sub>	RF Linear Amplifier	2000	0.25	2000	400	0.25	—	300
AB <sub>1</sub>	RF Linear Amplifier AM Service	2000	0.25	2000	400	0.17	—	100†
AB <sub>1</sub>	RF Amplifier or Modulator	2000	0.25	2000	350	0.50*	—	595*

\*Two tubes

†Carrier Power

External Anode, Forced Air Cooled Tetrodes  
**4CX300A/8167**

**CHARACTERISTICS**

The 4CX300A/8167 is a compact integral-finned external-anode power tetrode having a maximum plate-dissipation rating of 300 watts. It may be operated at frequencies up to 500 MHz.

The ceramic/metal construction and the internally-unitized electrode structure combine to make the 4CX300A/8167 especially durable and free from mechanically-induced noise under conditions of severe acceleration caused by shock or vibration.

- Plate Dissipation (Max.) . . . . . 300 watts
- Screen Dissipation (Max.) . . . . . 12 watts
- Grid Dissipation (Max.) . . . . . 2 watts
- Frequency for Max. Ratings (CW) . . . . . 500 MHz
- Cooling . . . . . Forced Air
- Cathode . . . . . Oxide-coated Unipotential
- Voltage . . . . . 6.0 volts
- Current . . . . . 2.9 amperes
- Capacitances (Gnd. Cath. Connection):
- Input . . . . . 29.0 pF
- Output . . . . . 4.0 pF
- Feed-through . . . . . 0.04 pF
- Amplification Factor (9<sub>1</sub>-9<sub>2</sub>) . . . . . 4.8
- Transconductance† . . . . . 12,000 μmhos
- Base . . . . . Special, Breechblock
- Recommended Air-System Socket . . . . . SK-700 Series
- Recommended Air Chimney . . . . . SK-606
- Maximum Seal & Anode Core Temperature . . . . . 250°C
- Maximum Length . . . . . 2.50 in; 63.50 mm
- Maximum Diameter . . . . . 1.64 in; 41.60 mm
- Weight (approximate) . . . . . 4 oz; 113 gm
- Operating Position . . . . . Any

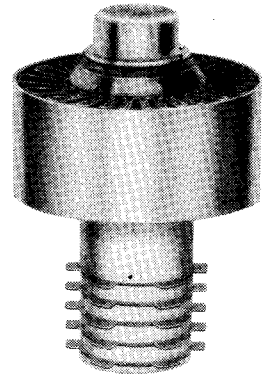

Class of Operation	Type of Service	MAXIMUM RATINGS		TYPICAL OPERATION					
		Plate Voltage (volts)	Plate Current (amps)	Freq. (MHz)	Plate Voltage (volts)	Screen Voltage (volts)	Plate Current (amps)	Drive Power (watts)	Output Power (watts)
C	RF Power Amplifier	2000	0.25	30	2000	250	0.25	2.9	390
C	RF Power Amplifier	2000	0.25	500	2000	250	0.25	—	225‡
C	RF Power Amplifier Plate Modulated	1500	0.20	30	1500	250	0.20	1.7	235
AB <sub>1</sub>	RF Linear Amplifier	2500	0.25	30	2500	350	0.25	—	400
AB <sub>1</sub>	RF Linear Amplifier AM Service	2500	0.25	30	2500	350	0.15	—	85
AB <sub>1</sub>	AF Amplifier or Modulator	2500	0.25	—	2500	350	0.50*	—	800*

\*Two tubes

†At I<sub>b</sub> = 200 mA

‡ Useful Power Output

**4CX300Y/8561**

**CHARACTERISTICS**

The 4CX300Y/8561 is a compact integral-finned external-anode power tetrode having a maximum plate-dissipation rating of 400 watts. It may be operated at maximum ratings to 110 MHz.

The ceramic/metal construction and the internally-unitized electrode structure combine to make the 4CX300Y/8561 especially durable and free from mechanically-induced noise under conditions of severe acceleration caused by shock or vibration.

- Plate Dissipation (Max.) . . . . . 400 watts
- Screen Dissipation (Max.) . . . . . 8 watts
- Grid Dissipation (Max.) . . . . . 1 watt
- Frequency for Max. Ratings (CW) . . . . . 110 MHz
- Cooling . . . . . Forced Air
- Cathode . . . . . Oxide-coated Unipotential
- Voltage . . . . . 6.0 volts
- Current . . . . . 3.5 amperes
- Capacitances (Gnd. Cath. Connection):
- Input . . . . . 34.0 pF
- Output . . . . . 4.5 pF
- Feed-through . . . . . 0.04 pF
- Amplification Factor (9<sub>1</sub>-9<sub>2</sub>) . . . . . 5.6
- Transconductance† . . . . . 15,400 μmhos
- Base . . . . . Special, Breechblock
- Recommended Air-System Socket . . . . . SK-700 Series
- Recommended Air Chimney . . . . . SK-606
- Maximum Seal & Anode Core Temperature . . . . . 250°C
- Maximum Length . . . . . 2.50 in; 63.50 mm
- Maximum Diameter . . . . . 1.64 in; 41.60 mm
- Weight (approximate) . . . . . 4 oz; 113 gm
- Operating Position . . . . . Any

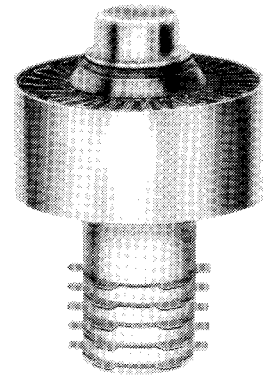

Class of Operation	Type of Service	MAXIMUM RATINGS		TYPICAL OPERATION				
		Plate Voltage (volts)	Plate Current (amps)	Plate Voltage (volts)	Screen Voltage (volts)	Plate Current (amps)	Drive Power (watts)	Output Power (watts)
C	RF Power Amplifier	2000	0.40	2000	250	0.40	3.8	600
C	RF Power Amplifier Plate Modulated	1500	0.30	1500	250	0.30	1.7	300
AB <sub>1</sub>	RF Linear Amplifier	2000	0.40	2000	400	0.38	—	415
AB <sub>1</sub>	RF Linear Amplifier AM Service	2000	0.40	2000	400	0.20	—	115‡
AB <sub>1</sub>	AF Amplifier or Modulator	2000	0.40	2000	400	0.75*	—	890*

\*Two tubes

†At I<sub>b</sub> = 200 mA

‡ Carrier output

External Anode, Forced Air Cooled Tetrodes  
**4CX350A/8321, 4CX350F/8322**

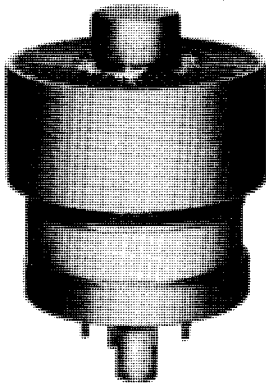

The 4CX350A/8321 is a compact radial-beam tetrode with a maximum plate dissipation of 350 watts and is intended for Class AB audio or RF amplifier service. The tube is externally identical to the 4CX250B but contains rugged internal construction features. Amplification factor and cathode area have been increased over the basic 4CX250B to give higher transconductance and figure of merit. The tube is of ceramic/metal construction.

The 4CX350F/8322 is identical except it is designed for a heater voltage of 26.5 volts at a current of 0.73 amperes.

**CHARACTERISTICS**

- Plate Dissipation (Max.) . . . . . 350 watts
- Screen Dissipation (Max.) . . . . . 8 watts
- Grid Dissipation (Max.) . . . . . 0 watts
- Frequency for Max. Ratings (CW) . . . . . 110 MHz
- Cooling . . . . . Forced Air
- Cathode . . . . . Oxide-coated Unipotential
- Voltage . . . . . 6.0 volts
- Current . . . . . 0.29 amperes
- Capacitances (Gnd. Cath. Connection):
- Input . . . . . 23.6 pF
- Output . . . . . 5.6 pF
- Feed-through . . . . . 0.03 pF
- Amplification Factor (g<sub>1-92</sub>) . . . . . 13
- Transconductance† . . . . . 22,000 μmhos
- Base . . . . . 9-Pin Special
- Recommended Air-System Socket . . . . . SK-600 Series
- Recommended Air Chimney . . . . . SK-606 Series
- Maximum Seal & Anode Core Temperature . . . . . 250°C
- Maximum Length . . . . . 2.47 in; 62.60 mm
- Maximum Diameter . . . . . 1.64 in; 41.60 mm
- Weight (approximate) . . . . . 4 oz; 113 gm
- Operating Position . . . . . Any

Class of Operation	Type of Service	MAXIMUM RATINGS		TYPICAL OPERATION				
		Plate Voltage (volts)	Plate Current (amps)	Plate Voltage (volts)	Screen Voltage (volts)	Plate Current (amps)	Drive Power (watts)	Output Power (watts)
AB <sub>1</sub>	RF Linear Amplifier	2500	0.30	2200	400	0.29	—	385
AB <sub>1</sub>	AF Amplifier or Modulator	2500	0.30	2200	400	0.58*	—	770*

\*Two tubes

†At I<sub>b</sub> = 150 mA

**4CX350FJ/8904**

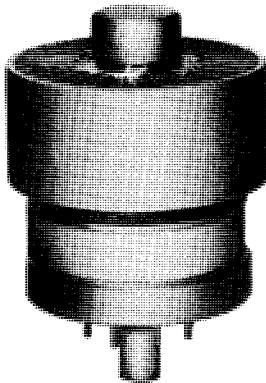

The 4CX350FJ/8904 is a compact radial-beam tetrode with a maximum plate dissipation of 350 watts, intended for Class AB linear RF amplifier service. The tube has rugged internal construction features.

The 4CX350FJ/8904 may be used as an exact replacement for the 4CX350F/8322 in most applications, requiring only minor circuit adjustment and retuning. The tube has improved intermodulation distortion characteristics. It contains a 26.5 volt heater, and is recommended for new equipment designs.

**CHARACTERISTICS**

- Plate Dissipation (Max.) . . . . . 350 watts
- Screen Dissipation (Max.) . . . . . 8.0 watts
- Grid Dissipation (Max.) . . . . . 0 watts
- Frequency for Max. Ratings (CW) . . . . . 110 MHz
- Cooling . . . . . Forced Air
- Cathode . . . . . Oxide-coated Unipotential
- Voltage . . . . . 26.5 volts
- Current . . . . . 0.65 amperes
- Capacitances (Gnd. Cath. Connection):
- Input . . . . . 22.0 pF
- Output . . . . . 5.9 pF
- Feed-through . . . . . 0.033 pF
- Amplification Factor (g<sub>1-92</sub>) . . . . . 17
- Transconductance† . . . . . 22,000 μmhos
- Base . . . . . 9-Pin Special
- Recommended Air-System Socket . . . . . SK-600 Series
- Recommended Air Chimney . . . . . SK-606 Series
- Maximum Seal & Anode Core Temperature . . . . . 250°C
- Maximum Length . . . . . 2.46 in; 62.60 mm
- Maximum Diameter . . . . . 1.64 in; 41.60 mm
- Weight (approximate) . . . . . 4 oz; 113 gm
- Operating Position . . . . . Any

Class of Operation	Type of Service	MAXIMUM RATINGS		TYPICAL OPERATION					
		Plate Voltage (volts)	Plate Current (amps)	Freq. (MHz)	Plate Voltage (volts)	Screen Voltage (volts)	Plate Current (amps)	Drive Power (watts)	Output Power (watts)
AB <sub>1</sub>	RF Linear Amplifier	2500	0.30	30	2200	400	0.23	—	250*

\*Useful Power Output

†At I<sub>b</sub> = 150 mA

External Anode, Forced Air Cooled Tetrodes  
**4CX600B, 4CX600F**

**CHARACTERISTICS**

The 4CX600B and 4CX600F are ceramic/metal, air cooled radial-beam tetrodes designed for use in wideband amplifiers, particularly distributed amplifiers.

The mechanical and electrical features of these tubes are compatible with wideband amplifier circuit requirements; i.e., low lead inductance, low input and output capacitances, small size and high transconductance.

Rugged construction consisting of a unitized electrode structure and direct mounting to the chassis combine to make the 4CX600B and 4CX600F suitable for environments of severe shock and vibration.

The maximum rated plate dissipation of either type is 600 watts.

Plate Dissipation (Max.)	600 watts
Screen Dissipation (Max.)	15 watts
Grid Dissipation (Max.)	3 watts
Frequency for Max. Ratings (CW)	500 MHz
Cooling	Forced Air
Cathode	Oxide-coated Unipotential
Voltage (4CX600B)	.60 volts
(4CX600F)	26.5 volts
Current (4CX600B)	.43 amperes
(4CX600F)	1.05 amperes
Capacitances (Gnd. Cath. Connection):	
Input	45.0 pF
Output	5.8 pF
Feed-through	0.15 pF
Input Conductance	
(I <sub>b</sub> = 0.6 Adc, F = 30 MHz):	0.1 × 10 <sup>-3</sup> mhos
Transconductance	
(I <sub>b</sub> = 0.6 Adc)	41,000 μmhos
Base	Special
Recommended Screen Bypass Capacitor	SK-680
Maximum Seal & Anode Core Temperature	250°C
Maximum Length	2.45 in; 62.20 mm
Maximum Diameter	2.08 in; 52.80 mm
Weight (approximate)	7 oz; 198 gm
Operating Position	Any

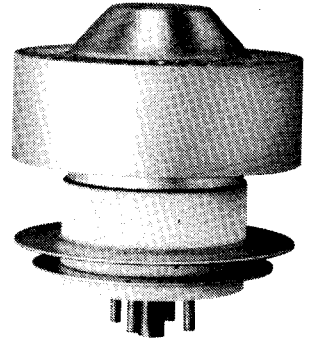

Class of Operation	Type of Service	MAXIMUM RATINGS		TYPICAL OPERATION					
		Plate Voltage (volts)	Plate Current (amps)	Freq. (MHz)	Plate Voltage (volts)	Screen Voltage (volts)	Plate Current (amps)	Drive Power (watts)	Output Power (watts)
B	RF Power Amplifier TV Service	2500	0.60	865	2000	300	0.60‡	52‡	585‡†
AB	RF Power Amplifier	2500	0.60	432	1830	300	0.60	25	700†
AB	RF Power Amplifier	2500	0.60	865	2000	300	0.60	52	585†
AB	RF Linear Amplifier Broadband Service	3000	0.60	—	2500	275	0.59	—	1000

†Useful Power Output

‡Sync. level

External Anode, Forced Air Cooled Tetrodes

**4CX600J/8809**  
**4CX600JA/8921**

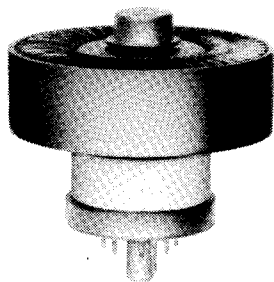

The 4CX600J/8809 is a ceramic/metal, forced-air cooled, radial beam tetrode with a rated maximum plate dissipation of 600 watts. It is a low-voltage, high-current tube specifically designed for exceptionally low intermodulation distortion and low grid interception. The low distortion characteristics make the 4CX600J/8809 especially suitable for radio-frequency and audio-frequency linear amplifier service.

The 4CX600JA/8921 has a larger anode-cooler for reduced cooling air pressure-drop. It is electrically identical to the 4CX600J.

**CHARACTERISTICS**

Plate Dissipation (Max.)	600 watts
Screen Dissipation (Max.)	.15 watts
Grid Dissipation (Max.)	.1 watt
Frequency for Max. Ratings (CW)	110 MHz
Cooling	Forced Air
Cathode	Oxide-coated Unipotential
Voltage	6.0 volts
Current	.54 amperes
Capacitances (Gnd. Cath. Connection):	
Input	50.0 pF
Output	6.3 pF
Feed-through	0.13 pF
Transconductance	
( $I_b = 0.3$ A dc, $E_{c2} = 350$ V dc)	27,000 $\mu$ mhos
Base	9-Pin Special
Recommended Air-System Socket	SK-607
Recommended Air Chimney (4CX600J)	SK-646
(4CX600JA)	SK-656
Maximum Seal & Anode Core Temperature	250°C
Maximum Length (both types)	2.71 in; 68.80 mm
Maximum Diameter (4CX600J)	2.08 in; 52.80 mm
(4CX600JA)	2.52 in; 64.00 mm
Weight (approximate) (4CX600J)	7.7 oz; 218 gm
(4CX600JA)	9.0 oz; 255 gm
Operating Position	Any

Class of Operation	Type of Service	MAXIMUM RATINGS		TYPICAL OPERATION					
		Plate Voltage (volts)	Plate Current (amps)	Freq. (MHz)	Plate Voltage (volts)	Screen Voltage (volts)	Plate Current (amps)	Drive Power (watts)	Output Power (watts)
AB	RF Linear Amplifier	3000	0.60	30	2500	350	0.68†	—	1100†
AB	AF Amplifier or Modulator	3000	0.60	—	2800	350	1.1*	—	1985*

\*Two tubes  
†1-tone value; 2-tone  $I_b \approx 0.475$  A

†Useful power output; intermodulation distortion products  $\approx -40$  dB in circuit with  $11 \Omega$  unbypassed cathode resistor.

**4CX1000A/8168**

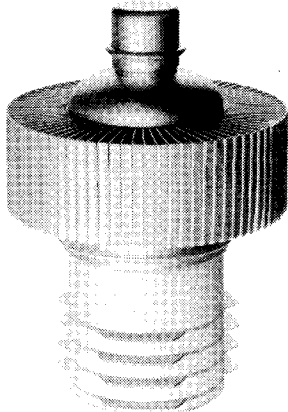

The 4CX1000A/8168 is a ceramic/metal, forced-air cooled, radial-beam tetrode with a rated maximum plate dissipation of 1000 watts. It is a low-voltage, high-current tube specifically designed for Class AB<sub>1</sub> RF linear-amplifier or audio-amplifier applications where its high gain may be used to advantage. At its rated maximum plate voltage of 3000 volts, it is capable of producing 1630 watts of peak-envelope output power. Two 4CX1000A/8168s operating in Class AB<sub>1</sub> will produce 3260 watts of audio power.

**CHARACTERISTICS**

Plate Dissipation (Max.)	1000 watts
Screen Dissipation (Max.)	.12 watts
Grid Dissipation (Max.)	0 watts
Frequency for Max. Ratings (CW)	110 MHz
Cooling	Forced Air
Cathode	Oxide-coated Unipotential
Voltage	6.0 volts
Current	.90 amperes
Capacitances (Gnd. Cath. Connection):	
Input	81.0 pF
Output	11.8 pF
Feed-through	0.015 pF
Capacitances (Gnd. Grid Connection):	
Input	35.5 pF
Output	12.0 pF
Feed-through	0.004 pF
Transconductance†	37,000 $\mu$ mhos
Base	Special, Breechblock
Recommended Air-System Socket	SK-800 Series
Recommended Air Chimney	SK-806
Maximum Seal & Anode Core Temperature	250°C
Maximum Length	4.80 in; 122.00 mm
Maximum Diameter	3.37 in; 85.50 mm
Weight (approximate)	27 oz; 0.77 kg
Operating Position	Any

Class of Operation	Type of Service	MAXIMUM RATINGS		TYPICAL OPERATION					
		Plate Voltage (volts)	Plate Current (amps)	Freq. (MHz)	Plate Voltage (volts)	Screen Voltage (volts)	Plate Current (amps)	Drive Power (watts)	Output Power (watts)
AB <sub>1</sub>	RF Linear Amplifier	3000	1.0	30	3000	325	0.88	—	1630
AB <sub>1</sub>	AF Amplifier or Modulator	3000	1.0	—	3000	325	1.8*	—	3260*

\*Two tubes      †At  $I_b = 1.0$  A



External Anode, Forced Air Cooled Tetrodes  
**4CX1000K/8352**

The 4CX1000K/8352 is a ceramic/metal forced-air cooled, radial-beam tetrode with a rated maximum plate dissipation of 1000 watts. It is a low-voltage, high-current tube specifically designed for Class AB<sub>1</sub> RF linear-amplifier applications where its high gain and low distortion characteristics may be used to advantage. The 4CX1000K/8352 is similar to the 4CX1000A/8168 but contains a solid screen ring that improves isolation between input and output circuits and permits use of the tube in UHF service.

**CHARACTERISTICS**

- Plate Dissipation (Max.) . . . . . 1000 watts
- Screen Dissipation (Max.) . . . . . .12 watts
- Grid Dissipation (Max.) . . . . . . 0 watts
- Frequency for Max. Ratings (CW) . . . . . 110 MHz
- Cooling . . . . . Forced Air
- Cathode . . . . . Oxide-coated Unipotential
- Voltage . . . . . .6.0 volts
- Current . . . . . .9.0 amperes
- Capacitances (Gnd. Cath. Connection):
  - Input . . . . . .84.0 pF
  - Output . . . . . .13.3 pF
  - Feed-through . . . . . .0.015 pF
- Capacitances (Gnd. Grid Connection):
  - Input . . . . . .35.0 pF
  - Output . . . . . .13.3 pF
  - Feed-through . . . . . .0.003 pF
- Transconductance† . . . . . 37,000 μmhos
- Base . . . . . Special, Breechblock
- Recommended Air-System Socket .SK-820 or SK-830
- Recommended Air Chimney . . . . . SK-806
- Maximum Seal & Anode Core Temperature . .250°C
- Maximum Length . . . . . 4.80 in; 122.00 mm
- Maximum Diameter . . . . . 3.37 in; 85.50 mm
- Weight (approximate) . . . . . 27 oz; 0.77 kg
- Operating Position . . . . . Any

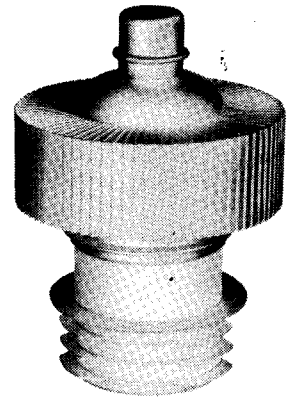

Class of Operation	Type of Service	MAXIMUM RATINGS		TYPICAL OPERATION				
		Plate Voltage (volts)	Plate Current (amps)	Plate Voltage (volts)	Screen Voltage (volts)	Plate Current (amps)	Drive Power (watts)	Output Power (watts)
AB <sub>1</sub>	RF Linear Amplifier	3000	1.0	3000	325	0.88	—	1630
AB <sub>1</sub>	AF Amplifier or Modulator	3000	1.0	3000	325	1.8*	—	3260*

\*Two tubes †At I<sub>b</sub> = 1.0 A

The 4CX1500A is a general purpose tetrode for use up to and through VHF. Insulation is ceramic and the thoriated tungsten filament is a rugged mesh design. The screen terminal is a continuous ring which allows good isolation between the plate circuit and the control grid circuit.

The 4CX1500A is recommended for use as a Class C power amplifier, Class B, or Class AB<sub>1</sub> linear amplifier, as a regulator, and in pulse modulator service.

**CHARACTERISTICS**

- Plate Dissipation (Max.) . . . . . 1500 watts
- Screen Dissipation (Max.) . . . . . .75 watts
- Grid Dissipation (Max.) . . . . . .25 watts
- Frequency for Max. Ratings (CW) . . . . . 150 MHz
- Cooling . . . . . Forced Air
- Filament . . . . . Thoriated tungsten mesh
- Voltage . . . . . .5.0 volts
- Current . . . . . .38.5 amperes
- Capacitances (Gnd. Cath. Connection):
  - Input . . . . . .78.0 pF
  - Output . . . . . .10.5 pF
  - Feed-through . . . . . .0.25 pF
- Amplification Factor (g<sub>1</sub>-g<sub>2</sub>) . . . . . .5
- Transconductance† . . . . . 26,000 μmhos
- Base . . . . . Special, Breechblock
- Recommended Air-System Socket . . . . . SK-831
- Recommended Air Chimney . . . . . SK-806
- Maximum Seal & Anode Core Temperature . .250°C
- Maximum Length . . . . . 4.90 in; 124.50 mm
- Maximum Diameter . . . . . 3.37 in; 85.60 mm
- Weight (approximate) . . . . . 30 oz; 850 gm
- Operating Position . . . . . Vertical

**4CX1500A**

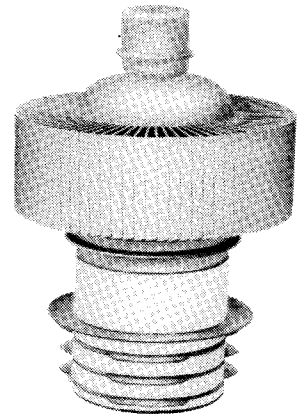

Class of Operation	Type of Service	MAXIMUM RATINGS		TYPICAL OPERATION					
		Plate Voltage (volts)	Plate Current (amps)	Freq. (MHz)	Plate Voltage (volts)	Screen Voltage (volts)	Plate Current (amps)	Drive Power (watts)	Output Power (watts)
C	RF Power Amplifier	5000	1.0	30	4000	500	0.80	3.6	2500
C	RF Power Amplifier	5000	1.0	220	3000	500	1.0	31.5	1500‡
C	RF Power Amplifier Plate Modulated	3500	0.8	30	3400	500	0.90	10	2320
AB	RF Linear Amplifier	4000	1.0	30	3900	600	0.75	—	1850
AB	AF Amplifier or Modulator	4000	1.0	—	3900	600	1.5*	—	3700*

\*Two tubes †At I<sub>b</sub> = 1.0 A ‡Useful power output

External Anode, Forced Air Cooled Tetrodes  
**4CX1500B/8660**

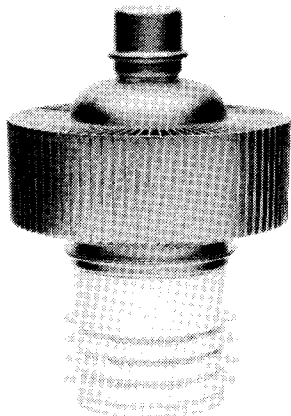

The 4CX1500B/8660 is a ceramic/metal, forced-air cooled, radial-beam tetrode with a rated maximum plate dissipation of 1500 watts. It is a low-voltage, high-current tube specifically designed for exceptionally low intermodulation distortion and low grid interception. The low distortion characteristics make the 4CX1500B/8660 especially suitable for radio-frequency and audio-frequency linear amplifier service.

**CHARACTERISTICS**

- Plate Dissipation (Max.) . . . . . 1500 watts
- Screen Dissipation (Max.) . . . . . 12 watts
- Grid Dissipation (Max.) . . . . . 1 watt
- Frequency for Max. Ratings (CW) . . . . . 110 MHz
- Cooling . . . . . Forced Air
- Cathode . . . . . Oxide-coated Unipotential
- Voltage . . . . . 6.0 volts
- Current . . . . . 10.0 amperes
- Capacitances (Gnd. Cath. Connection):
- Input . . . . . 81.5 pF
- Output . . . . . 11.8 pF
- Feed-through . . . . . 0.02 pF
- Transconductance† . . . . . 30,000  $\mu$ hos
- Base . . . . . Special, Breechblock
- Recommended Air-System Socket . . . . . SK-800B
- Recommended Air Chimney . . . . . SK-806
- Maximum Seal & Anode Core Temperature . . . . . 250°C
- Maximum Length . . . . . 4.80 in; 121.90 mm
- Maximum Diameter . . . . . 3.37 in; 85.60 mm
- Weight (approximate) . . . . . 27 oz; 0.77 kg
- Operating Position . . . . . Any

Class of Operation	Type of Service	MAXIMUM RATINGS		TYPICAL OPERATION				
		Plate Voltage (volts)	Plate Current (amps)	Plate Voltage (volts)	Screen Voltage (volts)	Plate Current (amps)	Drive Power (watts)	Output Power (watts)
AB	RF Linear Amplifier	3000	0.90	2900	225	0.71	—	1100‡
AB <sub>1</sub>	AF Amplifier or Modulator	3000	0.90	2900	325	1.7*	—	2774*

\*Two tubes      †At  $I_b = 0.5$  A      ‡Useful power output

**4CX3000A/8169**

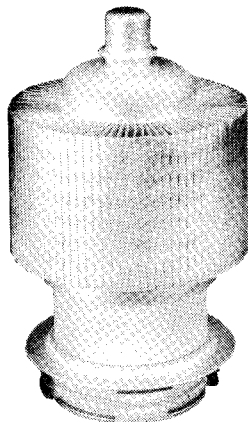

The 4CX3000A/8169 is a ceramic/metal power tetrode designed to be used as a Class AB<sub>1</sub> linear amplifier in audio or radio-frequency applications. Its characteristics of low intermodulation distortion make it especially suitable for single sideband service.

This tube is unique in that a production test is included to insure minimum distortion products. The 4CX3000A/8169 must produce a minimum of 5300 watts in Class AB<sub>1</sub> service with 1M distortion at least 32 dB down, 3rd order.

The tube is also recommended for use as a Class C radio-frequency power amplifier and plate-modulated radio-frequency power amplifier.

**CHARACTERISTICS**

- Plate Dissipation (Max.) . . . . . 3500 watts
- Screen Dissipation (Max.) . . . . . 175 watts
- Grid Dissipation (Max.) . . . . . 50 watts
- Frequency for Max. Ratings (CW) . . . . . 150 MHz
- Cooling . . . . . Forced Air
- Filament . . . . . Thoriated tungsten
- Voltage . . . . . 9.0 volts
- Current . . . . . 41.5 amperes
- Capacitances (Gnd. Cath. Connection):
- Input . . . . . 130 pF
- Output . . . . . 12.5 pF
- Feed-through . . . . . 1.0 pF
- Capacitances (Gnd. Grid Connection):
- Input . . . . . 61.0 pF
- Output . . . . . 12.5 pF
- Feed-through . . . . . 0.1 pF
- Amplification Factor ( $g_{1-92}$ ) . . . . . 5.5
- Base . . . . . Special, Breechblock
- Recommended Air-System Socket . . . . . SK-1400
- Recommended Air Chimney . . . . . SK-1406
- Maximum Seal & Anode Core Temperature . . . . . 250°C
- Maximum Length . . . . . 7.90 in; 200.70 mm
- Maximum Diameter . . . . . 4.63 in; 117.60 mm
- Weight (approximate) . . . . . 5.5 lb; 2.5 kg
- Operating Position . . . . . Vertical

Class of Operation	Type of Service	MAXIMUM RATINGS		TYPICAL OPERATION				
		Plate Voltage (volts)	Plate Current (amps)	Plate Voltage (volts)	Screen Voltage (volts)	Plate Current (amps)	Drive Power (watts)	Output Power (watts)
C	RF Power Amplifier	7000	2.0	7000	500	1.9	41	11,000
C	RF Power Amplifier Plate Modulated	5000	1.4	5000	500	1.4	31	5750
AB	RF Linear Amplifier	7000	2.0	5000	850	1.7	—	5300†
AB	AF Amplifier or Modulator	6000	2.0	6000	850	3.1*	—	12,400*

\*Two tubes      †Useful output power

External Anode, Forced Air Cooled Tetrodes  
**4CX5000A/8170**

The 4CX5000A/8170 is a compact high-power ceramic/metal tetrode cooled by forced air. It is useful as an oscillator, amplifier, or modulator at frequencies up to 220 MHz and is particularly suited for use as a linear single-sideband amplified, Class AB<sub>1</sub> audio amplifier, or as a screen-modulated radio-frequency amplifier.

A pair of these tubes will deliver 17.5 kW of audio-frequency or radio-frequency power with zero driving power. The rated plate dissipation is 5 kW for most classes of services and 6 kW for Class AB operation.

**CHARACTERISTICS**

Plate Dissipation (Max.)	5000 watts
Screen Dissipation (Max.)	250 watts
Grid Dissipation (Max.)	.75 watts
Frequency for Max. Ratings (CW)	100 MHz
Cooling	Forced Air
Filament	Thoriated tungsten
Voltage	.75 volts
Current	.75.0 amperes
Capacitances (Gnd. Cath. Connection):	
Input	115 pF
Output	20.5 pF
Feed-through	.07 pF
Capacitances (Gnd. Grid Connection):	
Input	53.0 pF
Output	20.5 pF
Feed-through	.01 pF
Amplification Factor (g <sub>1</sub> -g <sub>2</sub> )	4.5
Base	Special, Coaxial
Recommended Air-System Socket	SK-300 Series
Recommended Air Chimney	SK-306
Maximum Seal & Anode Core Temperature	250°C
Maximum Length	9.13 in; 231.80 mm
Maximum Diameter	4.94 in; 125.40 mm
Weight (approximate)	9.5 lb; 4.31 kg
Operating Position	Vertical

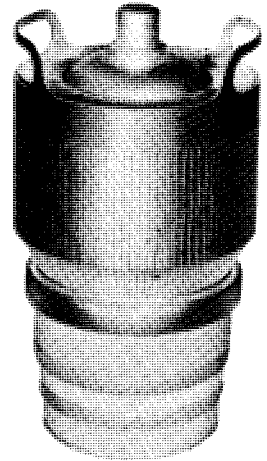

Class of Operation	Type of Service	MAXIMUM RATINGS		TYPICAL OPERATION					
		Plate Voltage (volts)	Plate Current (amps)	Freq. (MHz)	Plate Voltage (volts)	Screen Voltage (volts)	Plate Current (amps)	Drive Power (watts)	Output Power (watts)
C	RF Power Amplifier	7500‡	3.0‡	30	7500	500	2.8	150	16,000
C	RF Power Amplifier Plate Modulated	5500	2.5	30	5000	500	1.4	25	5800
C	RF Power Amplifier Screen Modulated	7500	3.0	30	7500	350	1.1	11	3550
AB <sub>1</sub>	RF Linear Amplifier	7500	4.0	30	7500	1250	1.9	—	10,000
AB <sub>1</sub>	AF Amplifier or Modulator	7500	4.0	—	7000	1250	3.7*	—	17,500*

\*Two tubes

‡Derated values apply above 30 MHz, to 220 MHz.

**4CX5000J/8909**

The 4CX5000J/8909 is a compact, high-power, ceramic/metal, forced-air cooled tetrode with a rated maximum plate dissipation of 6000 watts. It incorporates rugged internal construction features, including a mesh filament/cathode.

The 4CX5000J/8909 is specifically designed for exceptionally low intermodulation distortion in radio-frequency linear amplifier service.

**CHARACTERISTICS**

Plate Dissipation (Max.)	6000 watts
Screen Dissipation (Max.)	250 watts
Grid Dissipation (Max.)	.75 watts
Frequency for Max. Ratings (CW)	100 MHz
Cooling	Forced Air
Filament	Thoriated tungsten mesh
Voltage	.75 volts
Current	103 amperes
Capacitances (Gnd. Cath. Connection):	
Input	120.0 pF
Output	20.5 pF
Feed-through	.07 pF
Capacitances (Gnd. Grid Connection):	
Input	56.0 pF
Output	21.5 pF
Feed-through	0.10 pF
Amplification Factor (g <sub>1</sub> -g <sub>2</sub> )	4.5
Base	Special, Coaxial
Recommended Air-System Socket	SK-300 Series
Recommended Air Chimney	SK-306
Maximum Seal & Anode Core Temperature	250°C
Maximum Length	9.13 in; 231.80 mm
Maximum Diameter	4.94 in; 125.40 mm
Weight (approximate)	9.5 lb; 4.31 kg
Operating Position	Vertical

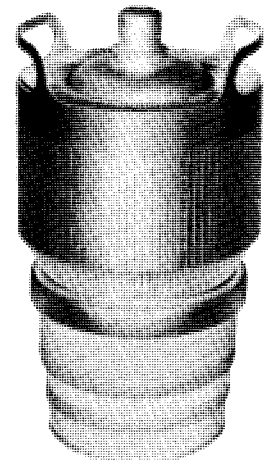

Class of Operation	Type of Service	MAXIMUM RATINGS		TYPICAL OPERATION				
		Plate Voltage (volts)	Plate Current (amps)	Plate Voltage (volts)	Screen Voltage (volts)	Plate Current (amps)	Drive Power (watts)	Output Power (watts)
AB <sub>1</sub>	RF Linear Amplifier	7500	4.0	4050	800	1.7	—	3150†

†Useful power output; intermodulation distortion products ≈ 40 dB.

External Anode, Forced Air Cooled Tetrodes

# 4CX5000R/8170W

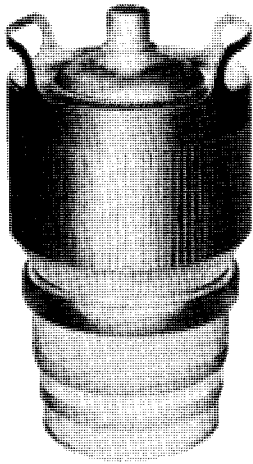

The 4CX5000R/8170W is a compact, high-power, ceramic/metal tetrode. It is directly interchangeable with the 4CX5000A/8170 but incorporates more rugged internal construction features, including a sturdy mesh cathode, which allows it to meet demanding vibration and shock specifications.

The 4CX5000R/8170W is useful up to 110 MHz and is recommended for use as a radio-frequency linear amplifier, a Class AB audio amplifier, or a Class C power amplifier or plate-modulated amplifier.

## CHARACTERISTICS

- Plate Dissipation (Max.) . . . . . 5000 watts
- Screen Dissipation (Max.) . . . . . 250 watts
- Grid Dissipation (Max.) . . . . . 75 watts
- Frequency for Max. Ratings (CW) . . . . . 100 MHz
- Cooling . . . . . Forced Air
- Filament . . . . . Thoriated tungsten
- Voltage . . . . . 7.5 volts
- Current . . . . . 75.0 amperes
- Capacitances (Gnd. Cath. Connection):
- Input . . . . . 115 pF
- Output . . . . . 20.5 pF
- Feed-through . . . . . 0.7 pF
- Capacitances (Gnd. Grid Connection):
- Input . . . . . 53.0 pF
- Output . . . . . 21.5 pF
- Feed-through . . . . . 0.1 pF
- Amplification Factor (g<sub>1</sub>-g<sub>2</sub>) . . . . . 4.5
- Base . . . . . Special, Coaxial
- Recommended Air-System Socket . . . . . SK-300 Series
- Recommended Air Chimney . . . . . SK-306
- Maximum Seal & Anode Core Temperature . . . . . 250°C
- Maximum Length . . . . . 9.13 in; 232.00 mm
- Maximum Diameter . . . . . 4.94 in; 125.00 mm
- Weight (approximate) . . . . . 9.5 lb; 4.31 kg
- Operating Position . . . . . Vertical

Class of Operation	Type of Service	MAXIMUM RATINGS		TYPICAL OPERATION				
		Plate Voltage (volts)	Plate Current (amps)	Plate Voltage (volts)	Screen Voltage (volts)	Plate Current (amps)	Drive Power (watts)	Output Power (watts)
C	RF Power Amplifier	7500	3.0	6500	750	2.3	100	10,000†
C	RF Power Amplifier Plate Modulated	5000	2.5	5000	500	1.4	25	5800
AB <sub>1</sub>	RF Linear Amplifier	7500	4.0	7500	1250	1.9	—	10,000
AB <sub>1</sub>	AF Amplifier or Modulator	7500	4.0	7000	1250	3.7*	—	17,500*

\*Two tubes

†Useful output power

# 4CX10,000D/8171

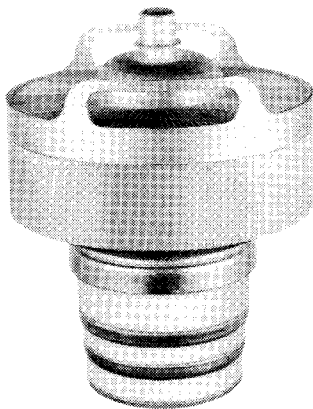

The 4CX10,000D/8171 is a ceramic/metal tetrode which is identical electrically to the 4CX5000A/8170 except for its rated plate dissipation. Its increased dissipation capability, resulting from a larger cooler, is most useful in linear applications where plate dissipation is generally the limiting factor.

The larger cooler also allows the 4CX10,000D/8171 to be used in place of the 4CX5000A/8170 with less cooling for any given plate dissipation, or results in cooler operation at any given air-flow rate.

The 4CX10,000D/8171 is useful as an oscillator, amplifier, or modulator at frequencies up to 110 megahertz and is particularly suited for use as a linear RF amplifier or Class AB<sub>1</sub> audio amplifier.

## CHARACTERISTICS

- Plate Dissipation (Max.) . . . . . 10,000 watts
- Screen Dissipation (Max.) . . . . . 250 watts
- Grid Dissipation (Max.) . . . . . 75 watts
- Frequency for Max. Ratings (CW) . . . . . 100 MHz
- Cooling . . . . . Forced Air
- Filament . . . . . Thoriated tungsten
- Voltage . . . . . 7.5 volts
- Current . . . . . 75.0 amperes
- Capacitances (Gnd. Cath. Connection):
- Input . . . . . 115 pF
- Output . . . . . 20.5 pF
- Feed-through . . . . . 0.7 pF
- Capacitances (Gnd. Grid Connection):
- Input . . . . . 53.0 pF
- Output . . . . . 20.5 pF
- Feed-through . . . . . 0.1 pF
- Amplification Factor (g<sub>1</sub>-g<sub>2</sub>) . . . . . 4.5
- Base . . . . . Special, Coaxial
- Recommended Air-System Socket . . . . . SK-300A
- Recommended Air Chimney . . . . . SK-1306
- Maximum Seal & Anode Core Temperature . . . . . 250°C
- Maximum Length . . . . . 9.13 in; 232.00 mm
- Maximum Diameter . . . . . 7.05 in; 179.00 mm
- Weight (approximate) . . . . . 12.0 lb; 5.50 kg
- Operating Position . . . . . Vertical

Class of Operation	Type of Service	MAXIMUM RATINGS		TYPICAL OPERATION					
		Plate Voltage (volts)	Plate Current (amps)	Freq. (MHz)	Plate Voltage (volts)	Screen Voltage (volts)	Plate Current (amps)	Drive Power (watts)	Output Power (watts)
C	RF Power Amplifier	7500‡	3.0‡	30	7500	500	2.8	150	16,000
C	RF Power Amplifier Plate Modulated	5000	2.5	30	5000	500	1.4	25	5800
AB <sub>1</sub>	RF Linear Amplifier	7500	4.0	30	7500	1500	3.3	—	15,950
AB <sub>1</sub>	AF Amplifier or Modulator	7500	4.0	30	7500	1500	6.7*	—	31,900*

\*Two tubes

‡Deredated values apply above 30 MHz.

External Anode, Forced-Air Cooled Tetrodes  
**4CX10,000J**

The 4CX10,000J is a compact, high-power, ceramic/metal, forced-air cooled tetrode with a rated maximum plate dissipation of 12 kW. It incorporates rugged internal construction features, including a mesh filament.

The 4CX10,000J is specifically designed for exceptionally low intermodulation distortion in radio-frequency linear amplifier service.

**CHARACTERISTICS**

Plate Dissipation (Max.) . . . . . 12,000 watts  
 Screen Dissipation (Max.) . . . . . 250 watts  
 Grid Dissipation (Max.) . . . . . 75 watts  
 Frequency for Max. Ratings (CW) . . . . . 100 MHz  
 Cooling . . . . . Forced Air  
 Filament . . . . . Thoriated tungsten mesh  
 Voltage . . . . . 7.5 volts  
 Current . . . . . 103 amperes  
 Capacitances (Gnd. Cath. Connection):  
 Input . . . . . 120 pF  
 Output . . . . . 20.5 pF  
 Feed-through . . . . . 0.7 pF  
 Capacitances (Gnd. Grid Connection):  
 Input . . . . . 56.0 pF  
 Output . . . . . 21.5 pF  
 Feed-through . . . . . 0.10 pF  
 Amplification Factor ( $g_{1-92}$ ) . . . . . 4.5  
 Base . . . . . Special, Coaxial  
 Recommended Air-System Socket . . . . . SK-300A  
 Recommended Air Chimney . . . . . SK-1306  
 Maximum Seal & Anode Core Temperature . . . . . 250°C  
 Maximum Length . . . . . 9.13 in; 232.00 mm  
 Maximum Diameter . . . . . 7.05 in; 179.00 mm  
 Weight (approximate) . . . . . 12.2 lb; 5.50 kg  
 Operating Position . . . . . Vertical

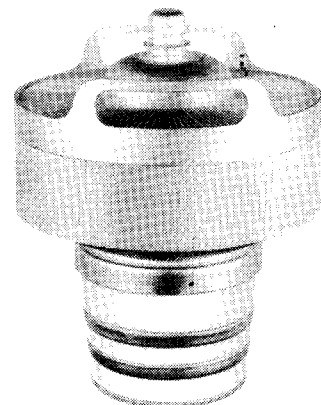

Class of Operation	Type of Service	MAXIMUM RATINGS		TYPICAL OPERATION				
		Plate Voltage (volts)	Plate Current (amps)	Plate Voltage (volts)	Screen Voltage (volts)	Plate Current (amps)	Drive Power (watts)	Output Power (watts)
AB <sub>1</sub>	RF Linear Amplifier	7500	4.0	7500	1600	2.2	—	10,000†

†Useful output power

**4CX15,000A/8281**

The 4CX15,000A/8281 is a ceramic/metal power tetrode intended for use in audio or radio frequency applications. It features a new type of internal mechanical structure which results in higher RF operating efficiency. Low RF losses in this mechanical structure permit operation of the 4CX15,000A/8281 at full ratings up to 110 MHz, and at reduced ratings, to 225 MHz.

The 4CX15,000A/8281 is also recommended for radio-frequency linear power amplifier service, and for television linear amplifier service.

**CHARACTERISTICS**

Plate Dissipation (Max.) . . . . . 15,000 watts  
 Screen Dissipation (Max.) . . . . . 450 watts  
 Grid Dissipation (Max.) . . . . . 200 watts  
 Frequency for Max. Ratings (CW) . . . . . 110 MHz  
 Cooling . . . . . Forced Air  
 Filament . . . . . Thoriated tungsten  
 Voltage . . . . . 7.5 volts  
 Current . . . . . 160 amperes  
 Capacitances (Gnd. Cath. Connection):  
 Input . . . . . 160.5 pF  
 Output . . . . . 24.5 pF  
 Feed-through . . . . . 1.5 pF  
 Capacitances (Gnd. Grid Connection):  
 Input . . . . . 67.0 pF  
 Output . . . . . 25.5 pF  
 Feed-through . . . . . 0.2 pF  
 Amplification Factor ( $g_{1-92}$ ) . . . . . 4.5  
 Base . . . . . Special, Coaxial  
 Recommended Air-System Socket . . . . . SK-300A  
 Recommended Air Chimney . . . . . SK-316  
 Maximum Seal & Anode Core Temperature . . . . . 250°C  
 Maximum Length . . . . . 9.38 in; 238.00 mm  
 Maximum Diameter . . . . . 7.58 in; 193.0 mm  
 Weight (approximate) . . . . . 12.8 lb; 5.80 kg  
 Operating Position . . . . . Vertical

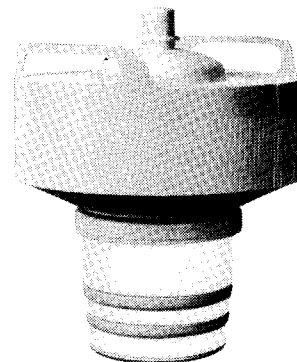

Class of Operation	Type of Service	MAXIMUM RATINGS		TYPICAL OPERATION				
		Plate Voltage (volts)	Plate Current (amps)	Plate Voltage (volts)	Screen Voltage (volts)	Plate Current (amps)	Drive Power (watts)	Output Power (watts)
C	RF Power Amplifier	10,000	6.0	10,000	750	4.6	220	36,500
C	RF Power Amplifier Plate Modulated	8000	4.0	8000	750	3.7	150	23,500
AB <sub>1</sub>	RF Linear Amplifier	10,000	6.0	10,000	1500	4.3	—	28,500
AB <sub>1</sub>	AF Amplifier or Modulator	10,000	6.0	10,000	1500	8.5*	—	57,000*

\*Two tubes

## External Anode, Forced Air Cooled Tetrodes 4CX15,000J/8910

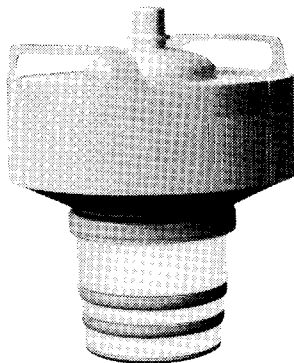

The 4CX15,000J/8910 is a ceramic/metal, forced-air cooled power tetrode intended for use in audio or radio frequency applications. The internal structure features a mesh filament and a mechanical design which assures good strength and high RF operating efficiency.

Full ratings on the 4CX15,000J/8910 apply to 110 MHz, and it is especially recommended for radio frequency linear amplifier service.

### CHARACTERISTICS

Plate Dissipation (Max.)	15,000 watts
Screen Dissipation (Max.)	450 watts
Grid Dissipation (Max.)	200 watts
Frequency for Max. Ratings (CW)	110 MHz
Cooling	Forced Air
Filament	Thoriated tungsten mesh
Voltage	7.5 volts
Current	158 amperes
Capacitances (Gnd. Cath. Connection):	
Input	160.5 pF
Output	26.5 pF
Feed-through	1.5 pF
Capacitances (Gnd. Grid Connection):	
Input	67.0 pF
Output	27.5 pF
Feed-through	0.2 pF
Amplification Factor (g <sub>1</sub> -g <sub>2</sub> )	4.5
Base	Special, Coaxial
Recommended Air-System Socket	SK-300A
Recommended Air Chimney	SK-316
Maximum Seal & Anode Core Temperature	250°C
Maximum Length	9.38 in; 238.0 mm
Maximum Diameter	7.58 in; 193.00 mm
Weight (approximate)	12.8 lb; 5.80 kg
Operating Position	Axis Vertical

Class of Operation	Type of Service	MAXIMUM RATINGS		TYPICAL OPERATION				
		Plate Voltage (volts)	Plate Current (amps)	Plate Voltage (volts)	Screen Voltage (volts)	Plate Current (amps)	Drive Power (watts)	Output Power (watts)
C	RF Power Amplifier	10,000	5.0	10,000	750	4.6	220	36,500
C	RF Power Amplifier Plate Modulated	8000	4.0	8000	750	3.7	150	23,500
AB <sub>1</sub>	RF Linear Amplifier	10,000	6.0	7500	1250	2.9	—	12,000†
AB <sub>1</sub>	AF Amplifier or Modulator	10,000	6.0	10,000	1500	8.5*	—	57,000*

\*Two tubes

†Useful output power, -39 dB-3rd; -39 dB-5th order products

## 4CX35,000C/8349

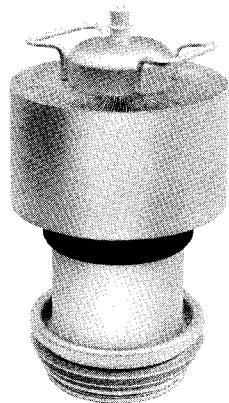

The 4CX35,000C/8349 is a ceramic/metal, forced-air cooled power tetrode intended for use at the 50 to 150 kW output power level. It is recommended for use as a Class C RF amplifier or oscillator, a Class AB RF linear amplifier, or a Class AB push-pull AF amplifier or modulator. The 4CX35,000C/8349 is also useful as a plate and screen modulated Class C RF amplifier.

### CHARACTERISTICS

Plate Dissipation (Max.)	35,000 watts
Screen Dissipation (Max.)	1750 watts
Grid Dissipation (Max.)	500 watts
Frequency for Max. Ratings (CW)	30 MHz
Cooling	Forced Air
Filament	Thoriated tungsten
Voltage	10.0 volts
Current	295 amperes
Capacitances (Gnd. Cath. Connection):	
Input	440 pF
Output	55.0 pF
Feed-through	2.30 pF
Capacitances (Gnd. Grid Connection):	
Input	175 pF
Output	57.0 pF
Feed-through	0.4 pF
Amplification Factor (g <sub>1</sub> -g <sub>2</sub> )	4.5
Base	Special, graduated rings
Recommended Air-System Socket	SK-1500 Series
Maximum Seal & Anode Core Temperature	250°C
Maximum Length	17.34 in; 440.00 mm
Maximum Diameter	9.75 in; 248.00 mm
Weight (approximate)	50 lb; 22.70 kg
Operating Position	Vertical

Class of Operation	Type of Service	MAXIMUM RATINGS		TYPICAL OPERATION				
		Plate Voltage (volts)	Plate Current (amps)	Plate Voltage (volts)	Screen Voltage (volts)	Plate Current (amps)	Drive Power (watts)	Output Power (watts)
C	RF Power Amplifier	20,000	15.0	19,000	750	7.0	258	110
C	RF Power Amplifier Plate Modulated	14,000	15.0	12,000	750	5.4	125	55
AB <sub>1</sub>	RF Linear Amplifier	20,000	15.0	15,000	1500	5.7	—	55
AB <sub>1</sub>	AF Amplifier or Modulator	20,000	15.0	12,000	1500	9.2*	—	70*

\*Two tubes

External Anode, Forced Air Cooled Tetrodes  
**4X150A/7034, 7609**

The 4X150A/7034 and 7609 are forced-air cooled, external-anode radial-beam tetrodes with a maximum plate dissipation rating of 250 watts and a maximum input-power rating of 500 watts up to 150 MHz, with reduced ratings applicable to 500 MHz. The 4X150A/7034 is designed to operate with a heater voltage of 6.0 volts, while the 7609 is designed for operation at a heater voltage of 26.5 volts. Otherwise, the two tube types have identical characteristics.

**CHARACTERISTICS**

- Plate Dissipation (Max.) . . . . . 250 watts
- Screen Dissipation (Max.) . . . . . 12 watts
- Grid Dissipation (Max.) . . . . . 2 watts
- Frequency for Max. Ratings (CW) . . . . . 150 MHz
- Cooling . . . . . Forced Air
- Cathode . . . . . Oxide-coated Unipotential
- Voltage (4X150A) . . . . . 6.0 volts
- (7609) . . . . . 26.5 volts
- Current (4X150A) . . . . . 2.6 amperes
- (7609) . . . . . 0.51 ampere
- Capacitances (Gnd. Cath. Connection):
- Input . . . . . 15.7 pF
- Output . . . . . 4.4 pF
- Feed-through . . . . . 0.03 pF
- Amplification Factor (g<sub>1</sub>-g<sub>2</sub>) . . . . . 5
- Base . . . . . 9-Pin Special
- Recommended Air-System Socket . . . . . SK-600 Series
- Recommended Air Chimney . . . . . SK-606 Series
- Maximum Ceramic Seal &
- Anode Core Temperature . . . . . 250° C
- Maximum Glass Seal Temperature . . . . . 200° C
- Maximum Length . . . . . 2.42 in; 61.30 mm
- Maximum Diameter . . . . . 1.64 in; 41.70 mm
- Weight (approximate) . . . . . 4 oz; 113 gm
- Operating Position . . . . . Any

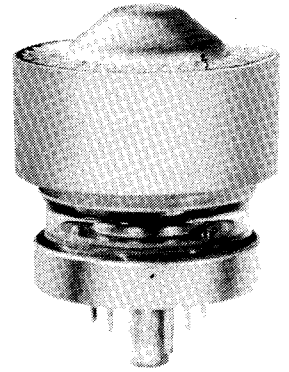

Class of Operation	Type of Service	MAXIMUM RATINGS		TYPICAL OPERATION				
		Plate Voltage (volts)	Plate Current (amps)	Plate Voltage (volts)	Screen Voltage (volts)	Plate Current (amps)	Drive Power (watts)	Output Power (watts)
C	RF Power Amplifier	2000	0.25	2000	250	0.25	2.9	390
C	RF Power Amplifier Plate Modulated	1600	0.20	1600	250	0.20	3.6	250
AB <sub>1</sub>	RF Linear Amplifier	2000	0.25	2000	350	0.25	—	300
AB <sub>1</sub>	AF Amplifier or Modulator	2000	0.25	2000	350	0.50*	—	600*

\*Two tubes

**External Anode, Forced Air Cooled Tetrodes**  
**6816, 6884**

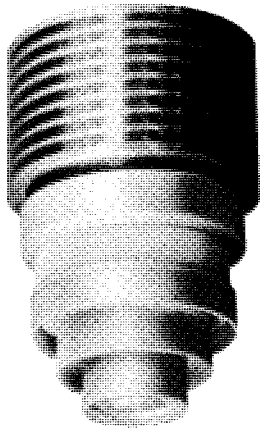

The 6816 and 6884 are compact external-anode ceramic/metal radial-beam tetrodes for use in RF power amplifier service, RF linear power amplifier applications, and as audio frequency amplifiers or modulators. The 6816 has a 6.3 volt heater, while the 6884 has a 26.5 volt heater. Both are otherwise identical, and they are designed for transverse-flow forced air cooling.

The tubes have an  $F_1$  rating of 1215 MHz for full-rated power input and are tested to show a useful power output of 80 watts at 400 MHz and 40 watts at 1200 MHz.

**CHARACTERISTICS**

- Plate Dissipation (Max.) . . . . . 115 watts
- Screen Dissipation (Max.) . . . . . 4.5 watts
- Grid Dissipation (Max.) . . . . . 1.0 watts
- Frequency for Max. Ratings (CW) . . . . . 1215 MHz
- Cooling . . . . . Forced Air
- Cathode . . . . . Oxide-coated Unipotential
- Voltage (6816) . . . . . 6.3 volts
- (6884) . . . . . 26.5 volts
- Current (6816) . . . . . 2.0 amperes
- (6884) . . . . . 0.53 amperes
- Capacitances (Gnd. Cath. Connection):
- Input . . . . . 30.5 pF
- Output . . . . . 4.7 pF
- Feed-through . . . . . 0.05 pF
- Capacitances (Gnd. Grid Connection):
- Input . . . . . 13.0 pF
- Output . . . . . 4.7 pF
- Feed-through . . . . . 0.01 pF
- Amplification Factor ( $g_1$ - $g_2$ ) . . . . . 18
- Base . . . . . Special, Coaxial
- Maximum Seal & Anode Core Temperature . . . . . 250°C
- Maximum Length . . . . . 1.93 in; 49.00 mm
- Maximum Diameter . . . . . 1.27 in; 32.50 mm
- Weight (approximate) . . . . . 2.0 oz; 57 gm
- Operating Position . . . . . Any

Class of Operation	Type of Service	MAXIMUM RATINGS		TYPICAL OPERATION					
		Plate Voltage (volts)	Plate Current (amps)	Freq. (MHz)	Plate Voltage (volts)	Screen Voltage (volts)	Plate Current (amps)	Drive Power (watts)	Output Power (watts)
C	RF Power Amplifier	1000	0.18	400	900	300	0.17	3	80†
C	RF Power Amplifier	1000	0.18	1200	900	300	0.17	5	40†
C	RF Power Amplifier Plate Modulated	800	0.15	400	700	250	0.13	3	45†
AB <sub>1</sub>	RF Linear Amplifier	1000	0.18	30	850	300	0.10	—	40†
AB <sub>1</sub>	AF Amplifier or Modulator	1000	0.18	—	850	300	0.20*	—	80
AB <sub>2</sub>	AF Amplifier or Modulator	1000	0.18	—	850	300	0.35*	—	140

\*Two tubes

†Useful output power



External Anode, Forced Air Cooled Tetrodes  
**8930**

The 8930 is a compact, high-perveance tetrode with a maximum plate dissipation of 350 watts. It is electrically identical to the 4CX250R/7580W but the larger anode radiator assembly allows higher dissipation with low air flow and pressure drop characteristics.

The tube has rugged internal construction features for reliable operation under heavy shock or vibration conditions.

**CHARACTERISTICS**

- Plate Dissipation (Max.) . . . . . 350 watts
- Screen Dissipation (Max.) . . . . . 12 watts
- Grid Dissipation (Max.) . . . . . 2 watts
- Frequency for Max. Ratings (CW) . . . . . 500 MHz
- Cooling . . . . . Forced Air
- Cathode . . . . . Oxide-coated Unipotential
- Voltage . . . . . 6.0 volts
- Current . . . . . 2.6 amperes
- Capacitances (Gnd. Cath. Connection):
- Input . . . . . 17.5 pF
- Output . . . . . 4.9 pF
- Feed-through . . . . . 0.03 pF
- Amplification Factor (g<sub>1</sub>-g<sub>2</sub>) . . . . . 5
- Base . . . . . 9-Pin Special
- Recommended Air-System Socket . . . . . SK-600 Series
- Recommended Air Chimney . . . . . SK-646
- Maximum Seal & Anode Core Temperature . . . . . 250°C
- Maximum Length . . . . . 2.46 in; 62.60 mm
- Maximum Diameter . . . . . 2.08 in; 52.80 mm
- Weight (approximate) . . . . . 5.5 oz; 156 gm
- Operating Position . . . . . Any

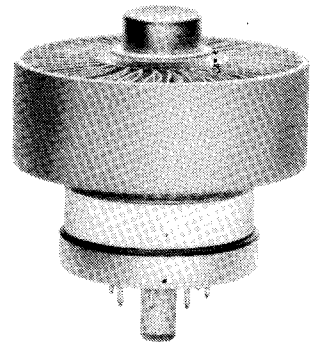

Class of Operation	Type of Service	MAXIMUM RATINGS		TYPICAL OPERATION					
		Plate Voltage (volts)	Plate Current (amps)	Freq. (MHz)	Plate Voltage (volts)	Screen Voltage (volts)	Plate Current (amps)	Drive Power (watts)	Output Power (watts)
C	RF Power Amplifier	2400	0.25	—	—	—	—	—	—
C	RF Power Amplifier Plate Modulated	1800	0.20	—	—	—	—	—	—
AB <sub>1</sub>	RF Linear Amplifier	2400	0.25	—	2000	350	0.29‡	—	350†
AB <sub>1</sub>	RF Linear Amplifier AM Service	2400	0.25	400	2000	400	0.17§	4	65
AB <sub>1</sub>	AF Amplifier or Modulator	2400	0.25	—	2000	350	0.50*	—	595*

\*Two tubes

‡1-tone value; 2 tone I<sub>b</sub> ≈ 0.20A

§ Carrier value; I<sub>b</sub> = 0.20A with 90% modulation.

External Anode, Vapor Cooled Tetrodes

# 4CV8000A

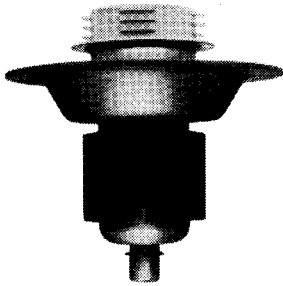

The 4CV8000A is a ceramic/metal vapor-cooled power tetrode designed to be used as a Class AB<sub>1</sub> linear amplifier in audio or radio-frequency applications. Its characteristic of low intermodulation distortion makes it specially suitable for single-sideband service. The vapor-cooled anode has a dissipation rating of 8 kW when mounted in an EIMAC BR-101 boiler.

The 4CV8000A is also recommended for Class C radio-frequency power amplifier and plate-modulated radio-frequency power amplifier service.

## CHARACTERISTICS

Plate Dissipation (Max.)	. . . . .	8,000 watts
Screen Dissipation (Max.)	. . . . .	175 watts
Grid Dissipation (Max.)	. . . . .	50 watts
Frequency for Max. Ratings (CW)	. . . . .	150 MHz
Cooling	. . . . .	Vapor and Forced Air
Filament	. . . . .	Thoriated tungsten
Voltage	. . . . .	9.0 volts
Current	. . . . .	41.5 amperes
Capacitances (Gnd. Cath. Connection):		
Input	. . . . .	130 pF
Output	. . . . .	12.5 pF
Feed-through	. . . . .	0.8 pF
Amplification Factor (g <sub>1</sub> -g <sub>2</sub> )	. . . . .	5.5
Base	. . . . .	Special Ring and Breachblock Terminal Surfaces
Recommended Air-System Socket	. . . . .	SK-1490 Series
Recommended Boiler	. . . . .	BR-101
Maximum Seal Temperature	. . . . .	250°C
Maximum Anode Flange Temperature	. . . . .	110°C
Maximum Length (less Boiler)	. . . . .	7.98 in; 202.70 mm
Maximum Diameter (less Boiler)	. . . . .	7.87 in; 199.90 mm
Weight (approximate) (less Boiler)	. . . . .	7.0 lb; 3.2 kg
Operating Position	. . . . .	Axis Vertical, base up

Class of Operation	Type of Service	MAXIMUM RATINGS		TYPICAL OPERATION					
		Plate Voltage (volts)	Plate Current (amps)	Freq. (MHz)	Plate Voltage (volts)	Screen Voltage (volts)	Plate Current (amps)	Drive Power (watts)	Output Power (watts)
C	RF Power Amplifier	7000	2.0	30	7000	500	1.9	47	11,000
C	RF Power Amplifier Plate Modulated	5000	1.4	30	5000	400	1.3	42	5500
AB <sub>1</sub>	RF Linear Amplifier	7000	2.0	30	6000	850	2.0	—	7250
AB <sub>1</sub>	AF Amplifier or Modulator	7000	2.0	—	6000	850	4.0*	—	14,500*

\*Two tubes

# 4CV35,000A

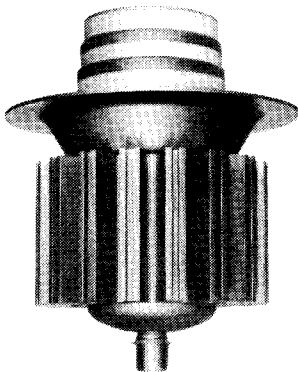

The 4CV35,000A is a ceramic/metal power tetrode intended for use as a Class C amplifier in radio-frequency applications. It features a new type of internal mechanical structure which results in higher RF operating efficiency. Low RF losses in this mechanical structure permit operation of the 4CV35,000A at full ratings up to 110 MHz. The 4CV35,000A is also recommended for Class AB audio-frequency and radio-frequency linear power amplifier service. The vapor-cooled anode is rated at 35 kW of plate dissipation, making the tube attractive for low efficiency applications.

## CHARACTERISTICS

Plate Dissipation (Max.)	. . . . .	35,000 watts
Screen Dissipation (Max.)	. . . . .	450 watts
Grid Dissipation (Max.)	. . . . .	200 watts
Frequency for Max. Ratings (CW)	. . . . .	110 MHz
Cooling	. . . . .	Vapor and Forced Air
Filament	. . . . .	Thoriated tungsten
Voltage	. . . . .	6.3 volts
Current	. . . . .	160 amperes
Capacitances (Gnd. Cath. Connection):		
Input	. . . . .	161 pF
Output	. . . . .	24.5 pF
Feed-through	. . . . .	1.5 pF
Amplification Factor (g <sub>1</sub> -g <sub>2</sub> )	. . . . .	4.5
Base	. . . . .	Special, Coaxial
Recommended Air-System Socket	. . . . .	SK-310 Series
Recommended Boiler	. . . . .	BR-200
Maximum Seal Temperature	. . . . .	250°C
Maximum Flange Temperature	. . . . .	110°C
Maximum Length (less Boiler)	. . . . .	9.50 in; 241.30 mm
Maximum Diameter (less Boiler)	. . . . .	7.75 in; 196.80 mm
Weight (approximate) (less Boiler)	. . . . .	20 lb; 9.1 kg
Operating Position	. . . . .	Axis Vertical, base down

Class of Operation	Type of Service	MAXIMUM RATINGS		TYPICAL OPERATION					
		Plate Voltage (volts)	Plate Current (amps)	Plate Voltage (volts)	Screen Voltage (volts)	Plate Current (amps)	Drive Power (watts)	Output Power (watts)	
C	RF Power Amplifier	10,000	5.0	10,000	750	4.8	225	38,000	
C	RF Power Amplifier Plate Modulated	8000	4.0	8000	750	3.6	150	23,500	
AB <sub>1</sub>	RF Linear Amplifier	10,000	6.0	10,000	1500	5.3	—	33,000	
AB <sub>1</sub>	AF Amplifier or Modulator	10,000	6.0	10,000	1500	10.7*	—	66,000*	

\*Two tubes

## External Anode, Vapor Cooled Tetrodes **4CV50,000E**

The 4CV50,000E is a ceramic/metal, vapor-cooled power tetrode intended for use at the 50 to 100 kW output power level. This tube is characterized by low input and feedback capacitances and low internal lead inductances. A rugged mesh thoriated tungsten filament provides adequate emission over the long operating life. It is recommended for use as a Class C RF amplifier or oscillator, a Class AB RF linear amplifier or a Class AB push-pull AF amplifier or modulator. The 4CV50,000E is also useful as a plate and screen modulated Class C RF amplifier. The vapor cooled anode is rated at 50 kW dissipation.

### CHARACTERISTICS

Plate Dissipation (Max.) . . . . .	50,000 watts
Screen Dissipation (Max.) . . . . .	1,500 watts
Grid Dissipation (Max.) . . . . .	.400 watts
Frequency for Max. Ratings (CW) . . . . .	110 MHz
Cooling . . . . .	Vapor and Forced Air
Filament . . . . .	Thoriated tungsten mesh
Voltage . . . . .	12.0 volts
Current . . . . .	215 amperes
Capacitances (Gnd. Cath. Connection):	
Input . . . . .	310.0 pF
Output . . . . .	52.0 pF
Feed-through . . . . .	0.7 pF
Capacitances (Gnd. Grid Connection):	
Input . . . . .	140 pF
Output . . . . .	52.0 pF
Feed-through . . . . .	0.4 pF
Amplification Factor (g <sub>1</sub> -g <sub>2</sub> ) . . . . .	4.5
Base . . . . .	Special
Recommended Air-System Socket . . . . .	SK-2000 Series
Recommended Boiler . . . . .	BR-700 Series
Maximum Seal & Envelope Temperature . . . . .	250°C
Maximum Length (less Boiler) . . . . .	11.50 in; 292.10 mm
Maximum Diameter (less Boiler) . . . . .	9.53 in; 242.00 mm
Weight (approximate) (less Boiler) . . . . .	31.5 lb; 14.3 kg
Operating Position . . . . .	Vertical, base down

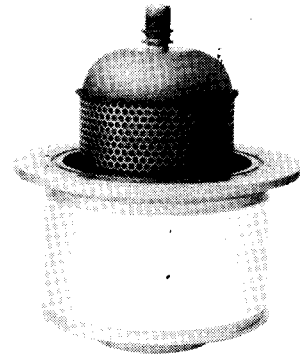

Class of Operation	Type of Service	MAXIMUM RATINGS		TYPICAL OPERATION				
		Plate Voltage (volts)	Plate Current (amps)	Plate Voltage (volts)	Screen Voltage (volts)	Plate Current (amps)	Drive Power (watts)	Output Power (watts)
C	RF Power Amplifier	17,500	12.0	15,000	1500	11.5	150	137,000
C	RF Power Amplifier Plate Modulated	15,000	12.0	14,000	750	9.25	685	110,000
AB <sub>1</sub>	RF Linear Amplifier	17,500	12.0	10,000	1800	9.14	—	57,000
AB <sub>1</sub>	AF Amplifier or Modulator	17,500	12.0	15,000	1250	18.6*	—	195,000*

\*Two tubes

## 4CV50,000J

The 4CV50,000J is a ceramic/metal, vapor-cooled power tetrode intended for use at the 50 to 100 kW output power level. This tube is characterized by low input and feedback capacitances and low internal lead inductances. A rugged mesh thoriated tungsten filament provides adequate emission over the long operating life. It is recommended for use as a class AB<sub>1</sub> RF linear amplifier. The vapor cooled anode is rated at 50 kW dissipation.

### CHARACTERISTICS

Plate Dissipation (Max.) . . . . .	50,000 watts
Screen Dissipation (Max.) . . . . .	1,500 watts
Grid Dissipation (Max.) . . . . .	.400 watts
Frequency for Max. Ratings (CW) . . . . .	110 MHz
Cooling . . . . .	Vapor and Forced Air
Filament . . . . .	Thoriated tungsten mesh
Voltage . . . . .	12.0 volts
Current . . . . .	215 amperes
Capacitances (Gnd. Cath. Connection):	
Input . . . . .	320.0 pF
Output . . . . .	48.0 pF
Feed-through . . . . .	1.0 pF
Capacitances (Gnd. Grid Connection):	
Input . . . . .	125 pF
Output . . . . .	50.0 pF
Feed-through . . . . .	0.3 pF
Amplification Factor (g <sub>1</sub> -g <sub>2</sub> ) . . . . .	4.5
Base . . . . .	Special
Recommended Air-System Socket . . . . .	SK-2000 Series
Recommended Boiler . . . . .	BR-710, 720
Maximum Seal & Envelope Temperature . . . . .	250°C
Maximum Length (less Boiler) . . . . .	11.50 in; 292.10 mm
Maximum Diameter (less Boiler) . . . . .	9.53 in; 242.00 mm
Weight (approximate) (less Boiler) . . . . .	31.5 lb; 14.3 kg
Operating Position . . . . .	Vertical, base down

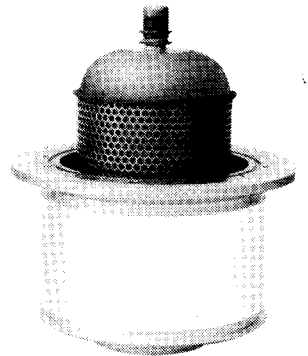

Class of Operation	Type of Service	MAXIMUM RATINGS		TYPICAL OPERATION				
		Plate Voltage (volts)	Plate Current (amps)	Plate Voltage (volts)	Screen Voltage (volts)	Plate Current (amps)	Drive Power (watts)	Output Power (watts)
AB <sub>1</sub>	RF Linear Amplifier	17,500	12.0	8300	1500	9.8	—	45,000

# External Anode, Vapor Cooled Tetrodes 4CV100,000C/8351

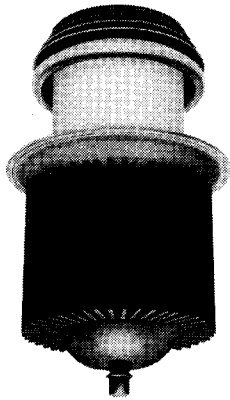

The 4CV100,000C/8351 is a ceramic/metal vapor-cooled power tetrode intended for use at the 100 to 200 kW output power level. It is recommended for use as a Class C RF amplifier or oscillator, a Class AB<sub>1</sub> RF linear amplifier or a Class AB, push-pull AF amplifier or modulator. The 4CV100,000C/8351 is also useful as a plate and screen modulated Class C RF amplifier.

The vapor-cooled anode is rated at 100 kW of plate dissipation when mounted in the EIMAC BR-300 series boiler.

## CHARACTERISTICS

Plate Dissipation (Max.)	100,000 watts
Screen Dissipation (Max.)	1,750 watts
Grid Dissipation (Max.)	500 watts
Frequency for Max. Ratings (CW)	30 MHz
Cooling	Vapor and Forced Air
Filament	Thoriated tungsten
Voltage	10.0 volts
Current	300 amperes
Capacitances (Gnd. Cath. Connection):	
Input	440 pF
Output	55.0 pF
Feed-through	2.3 pF
Capacitances (Gnd. Grid Connection):	
Input	175 pF
Output	57.0 pF
Feed-through	0.4 pF
Amplification Factor (g <sub>1</sub> -g <sub>2</sub> )	4.5
Base	Special, Graduated-Rings
Recommended Air-System Socket	SK-1500 Series
Recommended Boiler	BR-300 Series
Maximum Seal & Envelope Temperature	250°C
Maximum Length (less Boiler)	17.24 in; 437.90 mm
Maximum Diameter (less Boiler)	10.07 in; 255.80 mm
Weight (approximate)(less Boiler)	95 lb; 43.2 kg
Operating Position	Vertical, base up

Class of Operation	Type of Service	MAXIMUM RATINGS		TYPICAL OPERATION				
		Plate Voltage (volts)	Plate Current (amps)	Plate Voltage (volts)	Screen Voltage (volts)	Plate Current (amps)	Drive Power (watts)	Output Power (watts)
C	RF Power Amplifier	20,000	15.0	17,500	1500	11.8	125	168,000
C	RF Power Amplifier Plate Modulated (Grid Driven)	17,500	15.0	16,000	750	12.0	1260	138,500
C	RF Power Amplifier Plate Modulated (Cathode Driven)	17,500	15.0	15,000	900	11.6	8100	141,000
AB <sub>1</sub>	RF Linear Amplifier	20,000	15.0	18,000	1500	10.0	—	123,200
AB <sub>1</sub>	AF Amplifier or Modulator	20,000	15.0	18,000	1500	20.0*	—	246,400*

\*Two tubes

External Anode, Vapor Cooled Tetrodes  
**4CV250,000A**

**CHARACTERISTICS**

The 4CV250,000A is a ceramic/metal, vapor-cooled power tetrode intended for use at the 250 to 500 kW output power level. It is recommended for use as a Class C RF amplifier or oscillator, a Class AB RF linear amplifier, a Class AB push-pull AF amplifier or modulator. The 4CV250,000A is also useful as a plate and screen modulated Class C RF amplifier.

The vapor cooled anode is rated at 250 kW maximum dissipation when used with the EIMAC BR-610 boiler.

- Plate Dissipation (Max.) . . . . . 250,000 watts
- Screen Dissipation (Max.) . . . . . 3,500 watts
- Grid Dissipation (Max.) . . . . . 1,500 watts
- Frequency for Max. Ratings (CW) . . . . . 30 MHz
- Cooling . . . . . Vapor and Water
- Filament . . . . . Thoriated tungsten
  - Voltage . . . . . 12.0 volts
  - Current . . . . . 660 amperes
- Capacitances (Gnd. Cath. Connection):
  - Input . . . . . 74.5 pF
  - Output . . . . . 124 pF
  - Feed-through . . . . . 6.0 pF
- Capacitances (Gnd. Grid Connection):
  - Input . . . . . 324 pF
  - Output . . . . . 128 pF
  - Feed-through . . . . . 1.2 pF
- Amplification Factor (g<sub>1</sub>-g<sub>2</sub>) . . . . . 4.5
- Base . . . . . Special
- Recommended Base Contact
  - Accessories . . . . . SK-1700 Series
  - Recommended Boiler . . . . . BR610
  - Maximum Seal & Envelope Temperature . . . . . 200°C
  - Maximum Length (less Boiler) . . . . . 28.02 in; 17.17 cm
  - Maximum Diameter (less Boiler) . . . . . 15.06 in; 38.26 cm
  - Weight (approximate) (less Boiler) . . . . . 180 lb; 82 kg
  - Operating Position . . . . . Vertical, base up

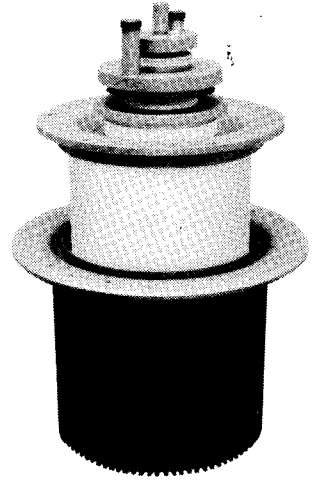

Class of Operation	Type of Service	MAXIMUM RATINGS		TYPICAL OPERATION				
		Plate Voltage (volts)	Plate Current (amps)	Plate Voltage (volts)	Screen Voltage (volts)	Plate Current (amps)	Drive Power (watts)	Output Power (watts)
C	RF Power Amplifier	20,000	40.0	19,000	800	32.5	3000	460,000
C	RF Power Amplifier Plate Modulated	17,500	30.0	15,000	800	22.8	1630	280,000
AB <sub>1</sub>	RF Linear Amplifier	20,000	40.0	20,000	1800	23.0	—	330,000
AB <sub>1</sub>	AF Amplifier or Modulator	20,000	40.0	20,000	1800	46.0*	—	660,000*

\*Two tubes

## External Anode, Water Cooled Tetrodes 4CW800B, 4CW800F

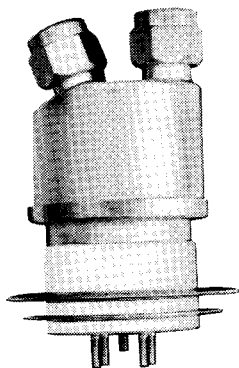

The 4CW800B and 4CW800F are ceramic/metal, liquid cooled radial-beam tetrodes designed for use in distributed amplifiers and VHF/UHF power amplifiers.

The mechanical and electrical features of these tubes are compatible with distributed amplifier circuit requirements, i.e., low lead inductance, low input and output capacitance and small size.

Ruggedized construction consisting of a unitized electrode structure and direct mounting to the chassis, combine to make the 4CW800B and 4CW800F suitable for environments of severe shock and vibration.

The maximum rated plate dissipation is 800 watts for both types.

### CHARACTERISTICS

Plate Dissipation (Max.)	800 watts
Screen Dissipation (Max.)	.15 watts
Grid Dissipation (Max.)	.3 watts
Frequency for Max. Ratings (CW)	500 MHz
Cooling	Liquid
Cathode	Oxide-coated Unipotential
Voltage (4CW800B)	6.0 volts
(4CW800F)	26.5 volts
Current (4CW800B)	4.4 amperes
(4CW800F)	1.1 amperes
Capacitances (Gnd. Cath. Connection):	
Input	45.0 pF
Output	5.8 pF
Feed-through	0.15 pF
Input Conductance	
(I <sub>b</sub> = 600 mAdc)	0:1 x 10 <sup>-3</sup> mhos
Transconductance	
(I <sub>b</sub> = 600 mAdc)	40,000 μmhos
Base	Special
Recommended screen bypass capacitor	SK-680
Maximum Seal & Envelope Temperature	250°C
Maximum Length	3.00 in; 76.20 mm
Maximum Diameter	2.03 in; 51.60 mm
Weight (approximate)	7 oz; 198.0 gm
Operating Position	Any

Class of Operation	Type of Service	MAXIMUM RATINGS		TYPICAL OPERATION					
		Plate Voltage (volts)	Plate Current (amps)	Freq. (MHz)	Plate Voltage (volts)	Screen Voltage (volts)	Plate Current (amps)	Drive Power (watts)	Output Power (watts)
B	RF Linear Amplifier	3000	0.6	140-250	2500	300	0.60	—	820†
B	RF Linear Amplifier	3000	0.6	432	2000	300	0.60	‡	770†
B	RF Linear Amplifier	3000	0.6	865	2000	300	0.60	§	550†
AB	RF Linear Amplifier Broadband Service	3000	0.6	—	2500	275	0.58	—	1000

† Useful Output Power

‡ Power Gain approx. 15.3 dB

§ Power Gain approx. 9 dB

## 4CW2000A/8244

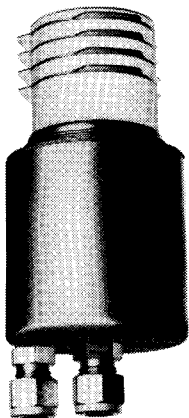

The 4CW2000A/8244 is a ceramic/metal water-cooled radial-beam tetrode with a rated maximum plate dissipation of 2000 watts. It is a low-voltage high current tube designed for Class AB<sub>1</sub> RF linear amplifier or audio amplifier applications where its high gain may be used to advantage. It is also recommended for voltage or current regulator service. As a regulator, the maximum dc plate voltage rating is 6000 volts. The 4CW2000A/8244 is the water-cooled version of the 4CX1000A/8168.

### CHARACTERISTICS

Plate Dissipation (Max.)	2000 watts
Screen Dissipation (Max.)	.12 watts
Grid Dissipation (Max.)	0 watts
Frequency for Max. Ratings (CW)	110 MHz
Cooling	Water
Cathode	Oxide-coated Unipotential
Voltage	6.0 volts
Current	9.0 amperes
Capacitances (Gnd. Cath. Connection):	
Input	81.5 pF
Output	11.8 pF
Feed-through	0.015 pF
Amplification Factor (g <sub>1-92</sub> )	3.8
Transconductance†	37,000 μmhos
Base	Special, Breechblock
Recommended Air-System Socket	SK-800 Series
Maximum Seal & Envelope Temperature	250°C
Maximum Length	5.69 in; 144.50 mm
Maximum Diameter	2.66 in; 67.60 mm
Weight (approximate)	27 oz; 766 gm
Operating Position	Vertical, base up or down

Class of Operation	Type of Service	MAXIMUM RATINGS		TYPICAL OPERATION					
		Plate Voltage (volts)	Plate Current (amps)	Freq. (MHz)	Plate Voltage (volts)	Screen Voltage (volts)	Plate Current (amps)	Drive Power (watts)	Output Power (watts)
B or AB <sub>1</sub>	RF Linear Amplifier (Grid Driven)	3000	1.0	30	3000	325	0.87	0	1630
AB	AF Amplifier or Modulator	3000	1.0	—	3000	325	1.7*	—	3260*

\*Two tubes

† At I<sub>b</sub> = 1.0 A

External Anode, Water Cooled Tetrodes  
**4CW10,000A/8661**

**CHARACTERISTICS**

The 4CW10,000A is a water-cooled, ceramic/metal power tetrode which is electrically identical to the 4CX10,000D/8171 (and 4CX5000A/8170, except for plate dissipation). The water-cooled anode is equipped with an integral water jacket and is rated at 12 kW dissipation.

The 4CW10,000A is useful as an oscillator, amplifier or modulator at frequencies up to 110 MHz, and is particularly suited for use as a linear RF amplifier or Class AB audio amplifier.

A pair of these tubes operating Class AB will deliver more than 30 kW of audio-frequency or radio-frequency plate output power.

- Plate Dissipation (Max.) . . . . . 12,000 watts
- Screen Dissipation (Max.) . . . . . 250 watts
- Grid Dissipation (Max.) . . . . . 75 watts
- Frequency for Max. Ratings (CW) . . . . . 110 MHz
- Cooling . . . . . Water and Forced Air
- Filament . . . . . Thoriated tungsten
- Voltage . . . . . 7.5 volts
- Current . . . . . 75.0 amperes
- Capacitances (Gnd. Cath. Connection):
- Input . . . . . 115 pF
- Output . . . . . 20.5 pF
- Feed-through . . . . . 0.7 pF
- Capacitances (Gnd. Grid Connection):
- Input . . . . . 53.0 pF
- Output . . . . . 20.5 pF
- Feed-through . . . . . 0.10 pF
- Amplification Factor ( $g_{1-2}$ ) . . . . . 4.5
- Base . . . . . Special, Coaxial
- Recommended Air-System Socket . . . . . SK-300A Series
- Maximum Seal & Envelope Temperature . . . . . 250°C
- Maximum Length . . . . . 10.81 in; 274.60 mm
- Maximum Diameter . . . . . 4.66 in; 118.40 mm
- Weight (approximate) . . . . . 7.5 lbs; 3.4 kg
- Operating Position . . . . . Vertical, base up or down

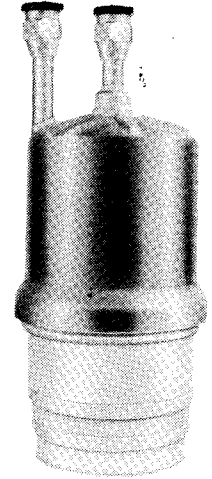

Class of Operation	Type of Service	MAXIMUM RATINGS		TYPICAL OPERATION					
		Plate Voltage (volts)	Plate Current (amps)	Freq. (MHz)	Plate Voltage (volts)	Screen Voltage (volts)	Plate Current (amps)	Drive Power (watts)	Output Power (watts)
C	RF Power Amplifier	7500	3.0‡	30	7500	500	2.8	150	16,000
C	RF Power Amplifier Plate Modulated	5000	2.5	30	5000	500	2.4	120	8500
AB <sub>1</sub>	RF Linear Amplifier	7500	4.0	30	7500	1500	3.3	—	15,950
AB <sub>1</sub>	AF Amplifier or Modulator	7500	4.0	—	7500	1500	6.6*	—	31,900*

\*Two tubes

**4CW25,000A**

**CHARACTERISTICS**

The 4CW25,000A is a ceramic/metal power tetrode intended for use in audio or radio frequency applications. It features a new type of internal mechanical structure which results in higher RF operating efficiency. Low RF losses in this mechanical structure permit operation of the 4CW25,000A at full ratings up to 110 MHz, and at reduced ratings, to 225 MHz.

The 4CW25,000A is recommended for RF linear power amplifier service, for television linear amplifier service, and as a switch tube for pulsed regulator service.

- Plate Dissipation (Max.) . . . . . 25,000 watts
- Screen Dissipation (Max.) . . . . . 450 watts
- Grid Dissipation (Max.) . . . . . 200 watts
- Frequency for Max. Ratings (CW) . . . . . 110 MHz
- Cooling . . . . . Water and Forced Air
- Filament . . . . . Thoriated tungsten
- Voltage . . . . . 6.3 volts
- Current . . . . . 160 amperes
- Capacitances (Gnd. Cath. Connection):
- Input . . . . . 160 pF
- Output . . . . . 24.5 pF
- Feed-through . . . . . 1.5 pF
- Capacitances (Gnd. Grid Connection):
- Input . . . . . 67.0 pF
- Output . . . . . 25.5 pF
- Feed-through . . . . . 0.2 pF
- Amplification Factor ( $g_{1-2}$ ) . . . . . 4.5
- Base . . . . . Special, Coaxial
- Recommended Air-System Socket . . . . . SK-300A Series
- Maximum Seal & Envelope Temperature . . . . . 250°C
- Maximum Length . . . . . 12.69 in; 322.00 mm
- Maximum Diameter . . . . . 4.75 in; 121.00 mm
- Weight (approximate) . . . . . 13.5 lb; 6.1 kg
- Operating Position . . . . . Vertical, base up or down

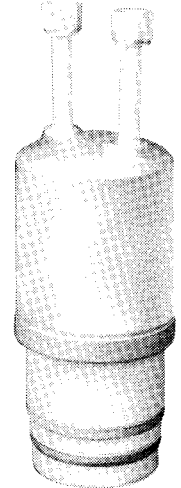

Class of Operation	Type of Service	MAXIMUM RATINGS		TYPICAL OPERATION					
		Plate Voltage (volts)	Plate Current (amps)	Plate Voltage (volts)	Screen Voltage (volts)	Plate Current (amps)	Drive Power (watts)	Output Power (watts)	
C	RF Power Amplifier	10,000	5.0	10,000	750	4.5	220	36,500	
C	RF Power Amplifier Plate Modulated	8,000	4.0	8,000	750	3.6	150	23,500	
AB <sub>1</sub>	RF Linear Amplifier	10,000	6.0	10,000	1500	4.2	—	28,500	
AB <sub>1</sub>	AF Amplifier or Modulator	10,000	6.0	10,000	1500	8.5*	—	57,000*	

\*Two tubes

External Anode, Water Cooled Tetrodes

# 4CW50,000E

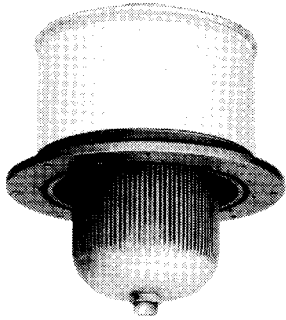

The 4CW50,000E is a ceramic/metal, water-cooled power tetrode intended for use at the 50 to 100 kW output power level. This tube is characterized by low input and feedback capacitances and low internal lead inductances. A rugged mesh thoriated tungsten filament provides adequate emission over the long operating life. It is recommended for use as a Class C RF amplifier or oscillator, a Class AB RF linear amplifier or a Class AB push-pull AF amplifier or modulator. The 4CW50,000E is also useful as a plate and screen modulated Class C RF amplifier. The water-cooled anode is rated at 50 kW plate dissipation.

## CHARACTERISTICS

- Plate Dissipation (Max.) . . . . . 50,000 watts
- Screen Dissipation (Max.) . . . . . 1,500 watts
- Grid Dissipation (Max.) . . . . . 400 watts
- Frequency for Max. Ratings (CW) . . . . . 110 MHz
- Cooling . . . . . Water and Forced Air
- Filament . . . . . Thoriated tungsten mesh
- Voltage . . . . . 12.0 volts
- Current . . . . . 215 amperes
- Capacitances (Gnd. Cath. Connection):
- Input . . . . . 310 pF
- Output . . . . . 52.0 pF
- Feed-through . . . . . 0.7 pF
- Capacitances (Gnd. Grid Connection):
- Input . . . . . 140 pF
- Output . . . . . 52.0 pF
- Feed-through . . . . . 0.3 pF
- Amplification Factor ( $g_1$ - $g_2$ ) . . . . . 4.5
- Base . . . . . Special, Coaxial
- Recommended Air-System Socket . . . . . SK-2000 Series
- Recommended Water Jacket . . . . . SK-2050
- Maximum Seal & Envelope Temperature . . . . . 250°C
- Maximum Length . . . . . 11.50 in; 292.00 mm
- Maximum Diameter . . . . . 9.53 in; 242.00 mm
- Weight (approximate) . . . . . 35.0 lb; 15.9 kg
- Operating Position . . . . . Vertical, base up or down

Class of Operation	Type of Service	MAXIMUM RATINGS		TYPICAL OPERATION				
		Plate Voltage (volts)	Plate Current (amps)	Plate Voltage (volts)	Screen Voltage (volts)	Plate Current (amps)	Drive Power (watts)	Output Power (watts)
C	RF Power Amplifier	17,500	12.0	15,000	1500	11.5	150	137,000
C	RF Power Amplifier Plate Modulated	15,000	12.0	14,000	750	9.2	685	110,000
AB <sub>1</sub>	RF Linear Amplifier	17,500	12.0	10,000	1800	9.1	—	57,000
AB <sub>1</sub>	AF Amplifier or Modulator	17,500	12.0	15,000	1250	18.6*	—	195,000*

\*Two tubes

# 4CW50,000J

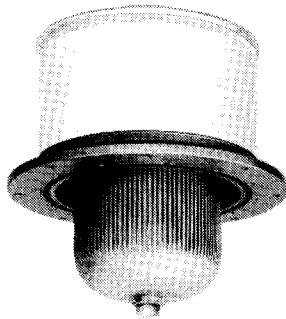

The 4CW50,000J is a ceramic/metal, water-cooled power tetrode intended for use at the 50 to 100 kW output power level. This tube is characterized by low input and feedback capacitances and low internal lead inductances. A rugged mesh thoriated tungsten filament provides adequate emission over the long operating life. It is recommended for use as a Class AB<sub>1</sub> RF linear amplifier. The water-cooled anode is rated at 50 kW plate dissipation.

## CHARACTERISTICS

- Plate Dissipation (Max.) . . . . . 50,000 watts
- Screen Dissipation (Max.) . . . . . 1,500 watts
- Grid Dissipation (Max.) . . . . . 300 watts
- Frequency for Max. Ratings (CW) . . . . . 110 MHz
- Cooling . . . . . Water and Forced Air
- Filament . . . . . Thoriated tungsten mesh
- Voltage . . . . . 12.0 volts
- Current . . . . . 215 amperes
- Capacitances (Gnd. Cath. Connection):
- Input . . . . . 310 pF
- Output . . . . . 48.0 pF
- Feed-through . . . . . 1.0 pF
- Capacitances (Gnd. Grid Connection):
- Input . . . . . 123 pF
- Output . . . . . 50.0 pF
- Feed-through . . . . . 0.3 pF
- Amplification Factor ( $g_1$ - $g_2$ ) . . . . . 4.5
- Base . . . . . Special, Coaxial
- Recommended Air-System Socket . . . . . SK-2000 Series
- Recommended Water Jacket . . . . . SK-2050
- Maximum Seal & Envelope Temperature . . . . . 250°C
- Maximum Length . . . . . 11.50 in; 292.00 mm
- Maximum Diameter . . . . . 9.53 in; 242.00 mm
- Weight (approximate) . . . . . 35 lb; 15.9 kg
- Operating Position . . . . . Vertical, base up or down

Class of Operation	Type of Service	MAXIMUM RATINGS		TYPICAL OPERATION				
		Plate Voltage (volts)	Plate Current (amps)	Plate Voltage (volts)	Screen Voltage (volts)	Plate Current (amps)	Drive Power (watts)	Output Power (watts)
AB	RF Linear Amplifier	17,500	12.0	8300	1500	9.8	—	45,000



External Anode, Water Cooled Tetrodes  
**4CW100.000D**

The 4CW100,000D is a ceramic/metal, water-cooled power tetrode intended for use at the 100 to 200 kW output power level. It is recommended for use as a Class C RF amplifier or oscillator, a Class AB, RF linear amplifier or a Class AB, push-pull AF amplifier or modulator. The 4CW100,000D is also useful as a plate and screen modulated Class C RF amplifier, and in pulse modulator-regulator service.

The water-cooled anode is rated at 100 kW maximum plate dissipation.

**CHARACTERISTICS**

- Plate Dissipation (Max.) . . . . . 100,000 watts
- Screen Dissipation (Max.) . . . . . 1,750 watts
- Grid Dissipation (Max.) . . . . . 500 watts
- Frequency for Max. Ratings (CW) . . . . . 30 MHz
- Cooling . . . . . Water and Forced Air
- Filament . . . . . Thoriated tungsten
- Voltage . . . . . 10.0 volts
- Current . . . . . 295 amperes
- Capacitances (Gnd. Cath. Connection):
- Input . . . . . 440 pF
- Output . . . . . 55.0 pF
- Feed-through . . . . . 2.3 pF
- Capacitances (Gnd. Grid Connection):
- Input . . . . . 175 pF
- Output . . . . . 57.0 pF
- Feed-through . . . . . 0.4 pF
- Amplification Factor (g<sub>1</sub>-g<sub>2</sub>) . . . . . 4.5
- Base . . . . . Special Graduated Rings
- Recommended Air-System Socket . . . . . SK-1500 Series
- Maximum Seal & Envelope Temperature . . . . . 250°C
- Maximum Length . . . . . 18.00 in; 457.00 mm
- Maximum Diameter . . . . . 8.00 in; 203.00 mm
- Weight (approximate) . . . . . 60.0 lb; 27.2 kg
- Operating Position . . . . . Vertical, base up or down

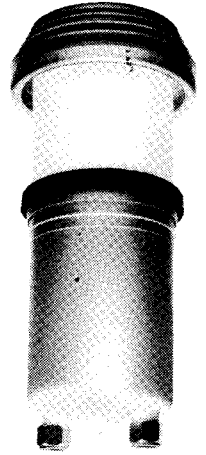

Class of Operation	Type of Service	MAXIMUM RATINGS		TYPICAL OPERATION				
		Plate Voltage (volts)	Plate Current (amps)	Plate Voltage (volts)	Screen Voltage (volts)	Plate Current (amps)	Drive Power (watts)	Output Power (kilowatts)
C	RF Power Amplifier	20,000	15.0	19,000	750	10.6	1165	165
C	RF Power Amplifier Plate Modulated	17,500	15.0	16,000	750	10.0	870	138
AB <sub>1</sub>	RF Linear Amplifier	20,000	15.0	18,000	1500	10.0	—	123
AB <sub>1</sub>	AF Amplifier or Modulator	20,000	15.0	18,000	1500	20.0*	—	246*
	Switch Tube or Pulse Modulator	40,000	200‡	38,000	1500	112†	16,800†	3600†

\*Two tubes

‡Pulse cathode current

†Pulse value

**External Anode, Water Cooled Tetrodes**  
**4CW100,000E**

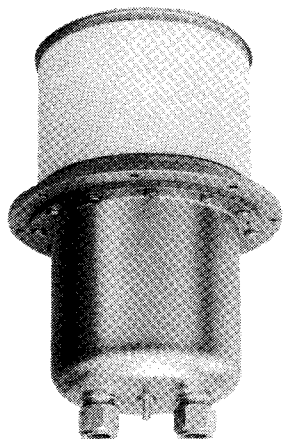

The 4CW100,000E is a ceramic/metal, high-power tetrode for applications requiring tube outputs from 100 to 250 kW. It is ideal for use as a Class C RF amplifier or oscillator, a Class AB RF linear amplifier, or a Class AB push-pull AF amplifier or modulator as well as a plate- and screen-modulated Class C RF amplifier. In pulse-modulator service, it can deliver a peak output of 4 megawatts. The tube is characterized by low input and feedback capacitances and low internal lead inductances. Its rugged mesh thoriated-tungsten filament provides ample emission for long operating life. The water-cooled anode dissipates 100 kW when used with the EIMAC SK-2100 water jacket.

**CHARACTERISTICS**

- Plate Dissipation (Max.) . . . . . 100,000 watts
- Screen Dissipation (Max.) . . . . . 1,750 watts
- Grid Dissipation (Max.) . . . . . 500 watts
- Frequency for Max. Ratings (CW) . . . . . 108 MHz
- Cooling . . . . . Water and Forced Air
- Filament . . . . . Thoriated tungsten
- Voltage . . . . . 15.5 volts
- Current . . . . . 215 amperes
- Capacitances (Gnd. Cath. Connection):
- Input . . . . . 370 pF
- Output . . . . . 60.0 pF
- Feed-through . . . . . 1.0 pF
- Capacitances (Gnd. Grid Connection):
- Input . . . . . 175 pF
- Output . . . . . 60.0 pF
- Feed-through . . . . . 0.35 pF
- Base . . . . . Special, Coaxial
- Recommended Air-System Socket . . . . . SK-2000 Series
- Recommended Water Jacket . . . . . SK-2100
- Maximum Seal & Envelope Temperature . . . . . 250°C
- Maximum Length . . . . . 12.82 in; 325.60 mm
- Maximum Diameter . . . . . 9.53 in; 242.10 mm
- Weight (approximate)
- (tube only) . . . . . 38.5 lb; 17.5 kg
- Operating Position . . . . . Vertical, base up or down

Class of Operation	Type of Service	MAXIMUM RATINGS		TYPICAL OPERATION				
		Plate Voltage (volts)	Plate Current (amps)	Plate Voltage (volts)	Screen Voltage (volts)	Plate Current (amps)	Drive Power (watts)	Output Power (kilowatts)
C	RF Power Amplifier	20,000	16.0	20,000	1500	15.2	120	220
C	RF Power Amplifier Plate Modulated	17,500	16.0	15,000	750	11.7	530	140
AB <sub>1</sub>	RF Linear Amplifier	20,000	16.0	18,000	1500	13.5	—	168
AB <sub>1</sub>	AF Amplifier or Modulator	20,000	16.0	15,000	1500	19.5*	—	200*

\*Two tubes

External Anode, Water Cooled Tetrodes  
**4CW250,000A**

The 4CW250,000A is a ceramic/metal, water-cooled, power tetrode intended for use at the 250 to 500 kW output power level. It is recommended as a Class C amplifier or oscillator; a Class AB RF linear amplifier; a Class AB push-pull AF amplifier or modulator; a plate or screen modulated Class C RF amplifier; or for pulse modulator or regulator service.

**CHARACTERISTICS**

- Plate Dissipation (Max.) . . . . . 250,000 watts
- Screen Dissipation (Max.) . . . . . 3,500 watts
- Grid Dissipation (Max.) . . . . . 1,500 watts
- Frequency for Max. Ratings (CW) . . . . . 50 MHz
- Cooling . . . . . Water and Forced Air
- Filament . . . . . Thoriated tungsten
  - Voltage . . . . . 12.0 volts
  - Current . . . . . 660 amperes
- Capacitances (Gnd. Cath. Connection):
  - Input . . . . . 745 pF
  - Output . . . . . 124 pF
  - Feed-through . . . . . 6.0 pF
- Capacitances (Gnd. Grid Connection):
  - Input . . . . . 324 pF
  - Output . . . . . 128 pF
  - Feed-through . . . . . 1.2 pF
- Amplification Factor ( $g_1$ - $g_2$ ) . . . . . 4.5
- Base . . . . . Special
- Recommended Base Contact
  - Accessories . . . . . SK-1700 Series
  - Recommended Anode Water Jacket . . . . . SK-1720
- Maximum Seal & Envelope Temperature . . . . . 200°C
- Maximum Length . . . . . 27.65 in; 70.23 cm
- Maximum Diameter . . . . . 13.06 in; 33.17 cm
- Weight (approximate) . . . . . 98.0 lb; 44.5 kg
- Operating Position . . . . . Vertical, base up or down

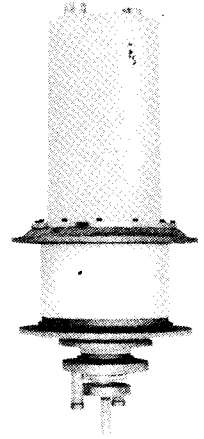

Class of Operation	Type of Service	MAXIMUM RATINGS		TYPICAL OPERATION				
		Plate Voltage (volts)	Plate Current (amps)	Plate Voltage (volts)	Screen Voltage (volts)	Plate Current (amps)	Drive Power (watts)	Output Power (kilowatts)
C	RF Power Amplifier	20,000	40.0	19,000	800	32.5	3000	460
C	RF Power Amplifier Plate Modulated	17,500	30.0	14,000	800	29.0	2320	285
AB <sub>1</sub>	RF Linear Amplifier	20,000	40.0	20,000	1800	23.0	—	330
AB <sub>1</sub>	AF Amplifier or Modulator	20,000	40.0	20,000	1800	46.0*	—	660*

\*Two tubes

## External Anode, Water Cooled Tetrodes X-2159

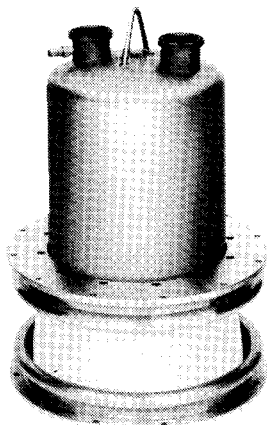

The X-2159 is a ceramic/metal, water-cooled power tetrode designed for very-high-powered medium-frequency or high-frequency broadcast service and very-low-frequency communication in the megawatt power range.

The X-2159 has a two-section thoriated-tungsten filament mounted on water-cooled supports. The two sections may be fed in quadrature to reduce hum contributed by an ac power source. The maximum anode dissipation rating is 1250 kW steady state.

Large-diameter coaxial terminals are used for the control grid and the RF filament terminals. Filament power and filament support cooling-water connections are made through three special couplings with threaded clamping rings.

### CHARACTERISTICS

Plate Dissipation (Max.)	1,250 kilowatts
Screen Dissipation (Max.)	15 kilowatts
Grid Dissipation (Max.)	4.0 kilowatts
Frequency for Max. Ratings (CW)	30 MHz
Cooling	Water and Forced Air
Filament	Thoriated tungsten, two-section
Voltage/section	18.5 volts
Current/section	700 amperes
Capacitances (Gnd. Cath. Connection):	
Input	1650 pF
Output	260 pF
Feed-through	10.0 pF
Capacitances (Gnd. Grid Connection):	
Input	675 pF
Output	260 pF
Feed-through	1.0 pF
Amplification Factor ( $g_{1-2}$ )	4.5
Base Terminals	Special, Coaxial
Recommended Filament Power/Water	
Connectors (3 required)	SK-2310
Recommended Filament RF	
Connector (1 required)	SK-2315
Recommended Anode Water	
Connectors (2 required)	SK-2320 or SK-2321
Maximum Seal & Envelope Temperature	200°C
Maximum Length	23.75 in; 60.30 cm
Maximum Diameter	17.03 in; 43.30 cm
Weight (approximate)	175.0 lb; 80.0 kg
Operating Position	Vertical, base down

Class of Operation	Type of Service	MAXIMUM RATINGS		TYPICAL OPERATION				
		Plate Voltage (volts)	Plate Current (amps)	Plate Voltage (volts)	Screen Voltage (volts)	Plate Current (amps)	Drive Power (watts)	Output Power (kilowatts)
C	RF Power Amplifier	22,500	125	21,500	1000	125	7000	2158
C	RF Power Amplifier Plate Modulated	17,500	100	17,500	1000	95.0	6465	1384
AB <sub>1</sub>	RF Linear Amplifier	22,500	125	20,000	1500	86.5	—	1225
AB <sub>1</sub>	AF Amplifier or Modulator	22,500	125	17,500	1500	146*	—	1384*

\*Two tubes

## X-2170

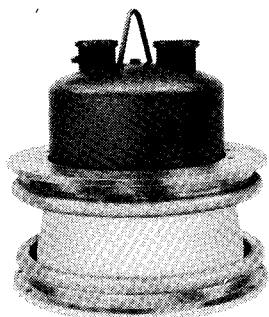

The X-2170 is a ceramic/metal, water-cooled power tetrode designed for very-high-powered medium-frequency or high-frequency broadcast service and very-low-frequency communication in the half-megawatt power range.

The X-2170 has a thoriated-tungsten filament mounted on water-cooled supports.

The maximum anode dissipation rating is 650 kW steady state.

Large-diameter coaxial terminals are used for the control grid and the RF filament terminals. Filament power and filament support cooling-water connections are made through special couplings with threaded clamping rings.

### CHARACTERISTICS

Plate Dissipation (Max.)	650,000 watts
Screen Dissipation (Max.)	7,500 watts
Grid Dissipation (Max.)	2,000 watts
Frequency for Max. Ratings (CW)	70 MHz
Cooling	Water and Forced Air
Filament	Thoriated tungsten
Voltage	18.5 volts
Current	700 amperes
Capacitances (Gnd. Cath. Connection):	
Input	1000 pF
Output	165 pF
Feed-through	5.0 pF
Amplification Factor ( $g_{1-2}$ )	4.5
Base	Special, Coaxial
Recommended Filament Power/Water	
Connectors (2 required)	SK-2310
Recommended Filament RF	
Connector (1 required)	SK-2315
Recommended Anode Water	
Connectors (2 required)	SK-2320 or SK-2321
Maximum Seal & Envelope Temperature	200°C
Maximum Length	18.75 in; 476.20 mm
Maximum Diameter	17.03 in; 432.60 mm
Weight (approximate)	153.0 lb; 69.5 kg
Operating Position	Vertical, base down

Class of Operation	Type of Service	MAXIMUM RATINGS		TYPICAL OPERATION				
		Plate Voltage (volts)	Plate Current (amps)	Plate Voltage (volts)	Screen Voltage (volts)	Plate Current (amps)	Drive Power (watts)	Output Power (kilowatts)
C	RF Power Amplifier	22,500	65.0	21,000	2500	63.0	3500	1050
C	RF Power Amplifier Plate Modulated	17,500	50.0	17,500	800	50.0	800	700
AB <sub>1</sub>	RF Linear Amplifier	22,500	65.0	20,000	1500	45.0	—	610
AB <sub>1</sub>	AF Amplifier or Modulator	22,500	65.0	17,500	1500	78.0*	—	950*

\*Two tubes

External Anode, Water Cooled Tetrodes  
**8959**

**CHARACTERISTICS**

The 8959 is a ceramic/metal high power tetrode for applications requiring tube outputs from 100 to 250 kW. It is ideal for use as a Class C RF amplifier or oscillator, a Class AB RF linear amplifier, or a Class AB push-pull audio amplifier or modulator, as well as a plate and screen modulated Class C RF amplifier.

In pulse modulator service it can deliver a peak output of 4 megawatts.

The tube is characterized by low input and feedback capacitances and low internal lead inductances. Its rugged mesh thoriated tungsten filament provides ample emission for long operating life.

The water-cooled anode dissipates 100 kW when used with an EIMAC SK-2100 Series water jacket.

- Plate Dissipation (Max.) . . . . . 100,000 watts
- Screen Dissipation (Max.) . . . . . 1,750 watts
- Grid Dissipation (Max.) . . . . . 500 watts
- Frequency for Max. Ratings (CW) . . . . . 108 MHz
- Cooling . . . . . Water and Forced Air
- Filament . . . . . Thoriated tungsten
- Voltage . . . . . 15.5 volts
- Current . . . . . 215 amperes
- Capacitances (Gnd. Cath. Connection):
  - Input . . . . . 370 pF
  - Output . . . . . 60.0 pF
  - Feed-through . . . . . 1.0 pF
- Capacitances (Gnd. Grid Connection):
  - Input . . . . . 175 pF
  - Output . . . . . 60.0 pF
  - Feed-through . . . . . 0.35 pF
- Base . . . . . Special, Coaxial
- Recommended Air-System Socket . . . . . SK-2000 Series
- Maximum Seal & Envelope Temperature . . . . . 250°C
- Maximum Length . . . . . 12.57 in; 319.30 mm
- Maximum Diameter . . . . . 8.26 in; 209.80 mm
- Weight (approximate) (tube only) . . . . . 38.5 lb; 17.5 kg
- Operating Position . . . . . Vertical, base up or down

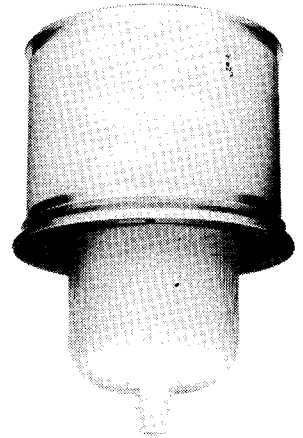

Class of Operation	Type of Service	MAXIMUM RATINGS		TYPICAL OPERATION				
		Plate Voltage (volts)	Plate Current (amps)	Plate Voltage (volts)	Screen Voltage (volts)	Plate Current (amps)	Drive Power (watts)	Output Power (kilowatts)
C	RF Power Amplifier	20,000	16.0	20,000	1500	15.2	120	220
C	RF Power Amplifier Plate Modulated	17,500	16.0	15,000	750	11.7	530	140
AB <sub>1</sub>	RF Linear Amplifier	20,000	16.0	18,000	1500	13.5	—	168
AB <sub>1</sub>	AF Amplifier or Modulator	20,000	16.0	15,000	1500	19.5*	—	200*
	Switch Tube or Pulse Modulator	40,000	200†	40,000	2500	110	—	4100

\*Two tubes

†Cathode current, pulse

## Internal Anode, Radiation Cooled Tetrodes 4-65A/8165



The 4-65A/8165 is a small radial-beam tetrode with a maximum plate-dissipation rating of 65 watts. In most applications, no forced air is required, normal radiation and convection cooling being adequate.

Short, heavy leads and low interelectrode capacities assure stable, efficient operation at high frequencies and permit its use at maximum ratings through 150 MHz. The 4-65A/8165 is equally useful in audio amplifier or modulator service.

### CHARACTERISTICS

Plate Dissipation (Max.)	.65 watts
Screen Dissipation (Max.)	.10 watts
Grid Dissipation (Max.)	.5 watts
Frequency for Max. Ratings (CW)	150 MHz
Cooling	Convection & Radiation
Filament	Thoriated tungsten
Voltage	.6.0 volts
Current	.3.5 amperes
Capacitances (Gnd. Cath. Connection):	
Input	.7.1 pF
Output	.2.3 pF
Feed-through	.0.1 pF
Amplification Factor (g <sub>1</sub> -g <sub>2</sub> )	.6
Base	5-Pin Special
Recommended Heat Dissipating Connector	HR-6
Maximum Seal Temperature	200°C
Maximum Envelope Temperature	225°C
Maximum Length	4.37 in; 111.00 mm
Maximum Diameter	2.38 in; 60.40 mm
Weight (approximate)	.3 oz; 85.0 gm
Operating Position	Vertical, base up or down

Class of Operation	Type of Service	MAXIMUM RATINGS		TYPICAL OPERATION				
		Plate Voltage (volts)	Plate Current (amps)	Plate Voltage (volts)	Screen Voltage (volts)	Plate Current (amps)	Drive Power (watts)	Output Power (watts)
C	RF Power Amplifier	3000	0.15	3000	250	0.11	1.6	270
C	RF Power Amplifier Plate Modulated	2500	0.12	2500	250	0.10	3.1	210
AB <sub>1</sub>	RF Linear Amplifier	3000	0.15	3000	400	0.06	—	120
AB <sub>1</sub>	AF Amplifier or Modulator	3000	0.15	3000	400	0.12*	—	240*

\*Two tubes

## 4-125A/4D21

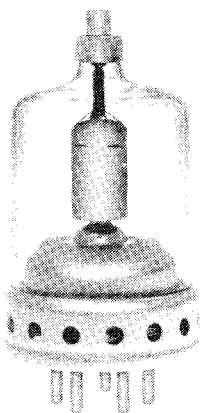

The 4-125A/4D21 is a radial-beam tetrode intended for use as an amplifier, oscillator, or modulator. It has a maximum plate-dissipation rating of 125 watts and a maximum plate-voltage rating of 3 kV at frequencies up to 120 MHz.

The low grid-plate capacitance of this tetrode together with its low driving-power requirement allows considerable simplification of the associated circuit and driver stage.

### CHARACTERISTICS

Plate Dissipation (Max.)	.125 watts
Screen Dissipation (Max.)	.20 watts
Grid Dissipation (Max.)	.5 watts
Frequency for Max. Ratings (CW)	120 MHz
Cooling	Radiation & Forced Air
Filament	Thoriated tungsten
Voltage	.5.0 volts
Current	.6.5 amperes
Capacitances (Gnd. Cath. Connection):	
Input	.10.8 pF
Output	.3.0 pF
Feed-through	.0.05 pF
Amplification Factor (g <sub>1</sub> -g <sub>2</sub> )	.5.9
Base	5-Pin Special
Recommended Heat Dissipating Connector	HR-6
Maximum Seal Temperature	200°C
Maximum Envelope Temperature	225°C
Maximum Length	5.69 in; 144.50 mm
Maximum Diameter	2.81 in; 71.40 mm
Weight (approximate)	.6.5 oz; 184.0 gm
Operating Position	Vertical, base up or down

Class of Operation	Type of Service	MAXIMUM RATINGS		TYPICAL OPERATION				
		Plate Voltage (volts)	Plate Current (amps)	Plate Voltage (volts)	Screen Voltage (volts)	Plate Current (amps)	Drive Power (watts)	Output Power (watts)
C	RF Power Amplifier	3000	0.22	3000	350	0.17	2.5	375
C	RF Power Amplifier Plate Modulated	2500	0.20	2500	350	0.15	3.3	300
AB <sub>1</sub>	AF Amplifier or Modulator	3000	0.22	2500	600	0.23*	—	330*
AB <sub>2</sub>	AF Amplifier or Modulator	3000	0.22	2500	350	0.26*	2.4	400*

\*Two tubes

Internal Anode, Radiation Cooled Tetrodes  
**4-250A/5D22**

The 4-250A/5D22 is a compact, ruggedly constructed power tetrode having a maximum plate dissipation rating of 250 watts. It is intended for use as an amplifier, oscillator or modulator. The low grid-plate capacitance of this tetrode coupled with its low driving-power requirement allows considerable simplification of the associated circuit and driver stage.

The 4-250A/5D22 is cooled by radiation from the plate and by circulation of forced-air through the base, around the envelope, and over the plate seal.

**CHARACTERISTICS**

- Plate Dissipation (Max.) . . . . . 250 watts
- Screen Dissipation (Max.) . . . . . 35 watts
- Grid Dissipation (Max.) . . . . . 10 watts
- Frequency for Max. Ratings (CW) . . . . . 110 MHz
- Cooling . . . . . Radiation & Forced Air
- Filament . . . . . Thoriated tungsten
- Voltage . . . . . 5.0 volts
- Current . . . . . 14.5 amperes
- Capacitances (Gnd. Cath. Connection):
- Input . . . . . 12.7 pF
- Output . . . . . 4.5 pF
- Feed-through . . . . . 0.12 pF
- Amplification Factor ( $g_{1-92}$ ) . . . . . 5.1
- Transconductance† . . . . . 4000  $\mu$ mhos
- Base . . . . . 5-Pin Special
- Recommended Air-System Socket . . . . . SK-400 Series
- Recommended Air Chimney . . . . . SK-406
- Recommended Heat Dissipating Connector . . . . . HR-6
- Maximum Plate Seal Temperature . . . . . 200°C
- Maximum Base Seal Temperature . . . . . 170°C
- Maximum Length . . . . . 6.38 in; 162.00 mm
- Maximum Diameter . . . . . 3.56 in; 90.40 mm
- Weight (approximate) . . . . . 8 oz; 227 gm
- Operating Position . . . . . Vertical, base up or down

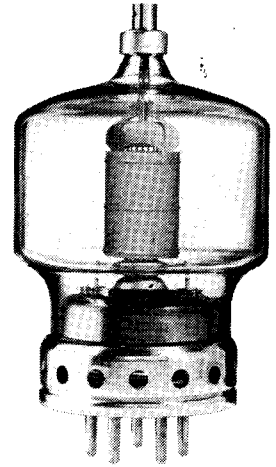

Class of Operation	Type of Service	MAXIMUM RATINGS		TYPICAL OPERATION				
		Plate Voltage (volts)	Plate Current (amps)	Plate Voltage (volts)	Screen Voltage (volts)	Plate Current (amps)	Drive Power (watts)	Output Power (watts)
C	RF Power Amplifier	4000	0.35	4000	500	0.31	2.5	1000
C	RF Power Amplifier Plate Modulated	3200	0.27	3000	400	0.23	3.2	510
AB <sub>1</sub>	RF Linear Amplifier	4000	0.35	3000	600	0.20	—	350
AB <sub>1</sub>	AF Amplifier or Modulator	4000	0.35	3000	600	0.42*	—	750*
AB <sub>2</sub>	AF Amplifier or Modulator	4000	0.35	3000	300	0.47*	4.6	1040*

\*Two tubes                    †At  $I_b = 100$  mA

**Internal Anode, Radiation Cooled Tetrodes**  
**4-400C/6775**

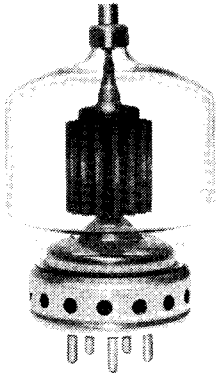

The 4-400C/6775 is a compact, ruggedly constructed, broadcast-quality tetrode having a maximum plate dissipation rating of 400 watts. It is intended for use as an amplifier, oscillator, or modulator. The low grid-plate capacitance of this tetrode coupled with its low driving-power requirement allows considerable simplification of the associated circuit and driver stage.

The 4-400C/6775 is cooled by radiation from the plate and by circulation of forced-air through the base, around the envelope, and over the plate seal. Cooling can be greatly simplified by using an EIMAC SK-400 Series Air-System Socket, and its accompanying glass chimney.

The 4-400C/6775 is especially recommended for applications where long life and consistent performance are of prime consideration.

**CHARACTERISTICS**

- Plate Dissipation (Max.) . . . . . 400 watts
- Screen Dissipation (Max.) . . . . . 35 watts
- Grid Dissipation (Max.) . . . . . 10 watts
- Frequency for Max. Ratings (CW) . . . . . 110 MHz
- Cooling . . . . . Radiation & Forced Air
- Filament . . . . . Thoriated tungsten
- Voltage . . . . . 5.0 volts
- Current . . . . . 14.7 amperes
- Capacitances (Gnd. Cath. Connection):
- Input . . . . . 12.5 pF
- Output . . . . . 4.7 pF
- Feed-through . . . . . 0.12 pF
- Amplification Factor ( $g_{1-92}$ ) . . . . . 5.1
- Transconductance $\ddagger$  . . . . . 4000  $\mu$ mhos
- Base . . . . . 5-Pin Special
- Recommended Air-System Socket . . . . . SK-400 Series
- Recommended Air Chimney . . . . . SK-406
- Recommended Heat Dissipating Connector . . . . . HR-6
- Maximum Plate Seal Temperature . . . . . 225°C
- Maximum Base Seal Temperature . . . . . 200°C
- Maximum Length . . . . . 6.38 in; 162.00 mm
- Maximum Diameter . . . . . 3.56 in; 90.40 mm
- Weight (approximate) . . . . . 9.0 oz; 255 gm
- Operating Position . . . . . Any

Class of Operation	Type of Service	MAXIMUM RATINGS		TYPICAL OPERATION					
		Plate Voltage (volts)	Plate Current (amps)	Freq. (MHz)	Plate Voltage (volts)	Screen Voltage (volts)	Plate Current (amps)	Drive Power (watts)	Output Power (watts)
C	RF Power Amplifier	4000	0.35	75	4000	500	0.35	5.8	1100
C	RF Power Amplifier	4000	0.35	110	4000	500	0.54*	20	1440†
C	RF Power Amplifier Plate Modulated	3200	0.27	75	3000	500	0.27	3.5	630
AB <sub>1</sub>	RF Linear Amplifier	4000	0.35	75	3000	750	0.29	—	470†
AB <sub>1</sub>	AF Amplifier or Modulator	4000	0.35	—	4000	750	0.59*	—	1540*
AB <sub>2</sub>	AF Amplifier or Modulator	4000	0.35	—	4000	500	0.64*	7.0	1750†

\*Two tubes

†Useful Output Power

‡ At  $I_b = 100$ mA



## Internal Anode, Radiation Cooled Tetrodes 4-500A

### CHARACTERISTICS

The 4-500A is a compact, ruggedly constructed, broadcast-quality tetrode having a maximum plate dissipation rating of 500 watts. It is intended for use as an amplifier, oscillator, or modulator. The low grid-plate capacitance of this tetrode coupled with its low driving-power requirement allows considerable simplification of the associated circuit and driver stage.

The 4-500A is cooled by radiation from the plate and by circulation of forced-air through the base, around the envelope, and over the plate seal. Cooling can be greatly simplified by using an EIMAC SK-400 Series Air-System Socket, and its accompanying glass chimney.

The 4-500A is especially recommended for applications where long life and consistent performance are of prime consideration.

- Plate Dissipation (Max.) . . . . . 500 watts
- Screen Dissipation (Max.) . . . . . 35 watts
- Grid Dissipation (Max.) . . . . . 12 watts
- Frequency for Max. Ratings (CW) . . . . . 110 MHz
- Cooling . . . . . Radiation & Forced Air
- Filament . . . . . Thoriated tungsten
- Voltage . . . . . 10.0 volts
- Current . . . . . 10.2 amperes
- Capacitances (Gnd. Cath. Connection):
- Input . . . . . 15.0 pF
- Output . . . . . 5.0 pF
- Feed-through . . . . . 0.15 pF
- Amplification Factor ( $g_{1-92}$ ) . . . . . 5.5
- Base . . . . . 5-Pin Special
- Recommended Air-System Socket . . . . . SK-410 Series
- Recommended Air Chimney . . . . . SK-426
- Recommended Heat Dissipating Connector . . . . . HR-6
- Maximum Base Seal Temperature . . . . . 200°C
- Maximum Plate Seal Temperature . . . . . 225°C
- Maximum Length . . . . . 7.00 in; 177.80 mm
- Maximum Diameter . . . . . 3.56 in; 90.40 mm
- Weight (approximate) . . . . . 8.7 oz; 245 gm
- Operating Position . . . . . Vertical, base up or down

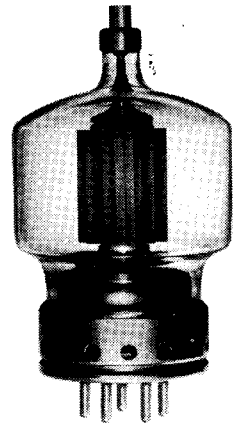

Class of Operation		MAXIMUM RATINGS		TYPICAL OPERATION					
		Plate Voltage (volts)	Plate Current (amps)	Freq. (MHz)	Plate Voltage (volts)	Screen Voltage (volts)	Plate Current (amps)	Drive Power (watts)	Output Power (watts)
C	RF Power Amplifier	4000	0.45	75	3800	500	0.45	9.0	1265
C	RF Power Amplifier Plate Modulated	3200	0.35	30	3200	500	0.34	5.8	830
AB <sub>1</sub>	RF Linear Amplifier	4000	0.45	30	4000	750	0.32	—	773
AB <sub>1</sub>	AF Amplifier or Modulator	4000	0.45	—	3800	750	0.72*	—	1720*

\*Two tubes

The 4-1000A/8166 is a radial-beam tetrode with a maximum plate dissipation rating of 1000 watts. Intended for use as an amplifier, oscillator, or modulator, the 4-1000A/8166 is capable of efficient operation well into the VHF range.

In FM broadcast service on 110 MHz, two 4-1000A/8166 tetrodes will deliver a useful output power of over 5 kW.

In class AB<sub>1</sub>, a pair of 4-1000A/8166 tetrodes will deliver 3800 watts of output power.

Cooling of the tube is accomplished by radiation from the plate and by circulation of forced-air through the base and around the envelope. Cooling can be simplified through the use of an EIMAC SK-500 Series Air-System Socket and its accompanying glass chimney.

### CHARACTERISTICS

- Plate Dissipation (Max.) . . . . . 1000 watts
- Screen Dissipation (Max.) . . . . . 75 watts
- Grid Dissipation (Max.) . . . . . 25 watts
- Frequency for Max. Ratings (CW) . . . . . 110 MHz
- Cooling . . . . . Radiation & Forced Air
- Filament . . . . . Thoriated tungsten
- Voltage . . . . . 7.5 volts
- Current . . . . . 21.3 amperes
- Capacitances (Gnd. Cath. Connection):
- Input . . . . . 28.1 pF
- Output . . . . . 8.1 pF
- Feed-through . . . . . 0.3 pF
- Amplification Factor ( $g_{1-92}$ ) . . . . . 6.9
- Transconductance . . . . . 10,000  $\mu$ mhos
- Base . . . . . 5-Pin Special
- Recommended Air-System Socket . . . . . SK-500 Series
- Recommended Air Chimney . . . . . SK-506
- Recommended Heat Dissipating Connector . . . . . HR-8
- Maximum Seal Temperature . . . . . 200°C
- Maximum Envelope Temperature . . . . . 225°C
- Maximum Length . . . . . 9.63 in; 244.60 mm
- Maximum Diameter . . . . . 5.25 in; 133.30 mm
- Weight (approximate) . . . . . 1.5 lb; 0.68 kg
- Operating Position . . . . . Vertical, base up or down

## 4-1000A/8166

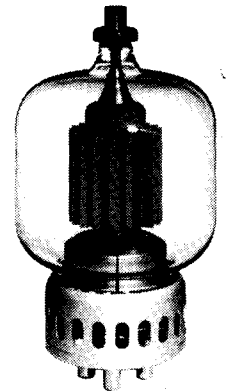

Class of Operation		MAXIMUM RATINGS		TYPICAL OPERATION					
		Plate Voltage (volts)	Plate Current (amps)	Freq. (MHz)	Plate Voltage (volts)	Screen Voltage (volts)	Plate Current (amps)	Drive Power (watts)	Output Power (watts)
C	RF Power Amplifier	6000	0.70	30	6000	500	0.70	15	3400
C	RF Power Amplifier	6000	0.70	110	6000	500	1.25*	400	5200*†
C	RF Power Amplifier Plate Modulated	5000	0.60	30	5000	500	0.60	11	2440†
AB <sub>1</sub>	AF Amplifier or Modulator	6000	0.70	—	6000	1000	0.95*	—	3840*
AB <sub>2</sub>	AF Amplifier or Modulator	6000	0.70	—	6000	500	0.95*	9.4	3900*

\*Two tubes

†Useful Output Power

Internal Anode, Radiation Cooled Tetrodes

# 4PR60C/8252W

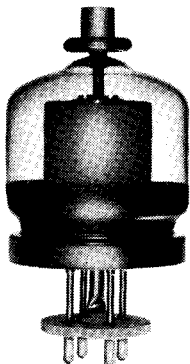

The 4PR60C/8252W is a high-vacuum tetrode intended for pulse-modulator service in circuits employing inductive or resistive loads. This tube unilaterally replaces the 715C and the 5D21 and supersedes the 4PR60B/8252. The internal structure of the tube has been strengthened to minimize the effects of shock and vibration.

The 4PR60C/8252W has a maximum plate dissipation rating of 60 watts, is cooled by radiation and convection, and delivers pulse output power in the region of 300 kW with less than one kW of pulse driving power.

## CHARACTERISTICS

Plate Dissipation (Max.)	60 watts
Screen Dissipation (Max.)	8 watts
Grid Dissipation (Max.)	1 watt
Cooling	Radiation or Forced Air
Cathode	Oxide-coated Unipotential
Voltage	26.0 volts
Current	2.1 amperes
Capacitances (Gnd. Cath. Connection):	
Input	43.0 pF
Output	8.5 pF
Feed-through	1.5 pF
Base	4-Pin Special
Recommended Heat Dissipating Connector	HR-8
Maximum Seal & Envelope Temperature	200°C
Maximum Length	6.00 in; 152.40 mm
Maximum Diameter	3.06 in; 77.90 mm
Weight (approximate)	12 oz; 0.34 kg
Operating Position	Any

Class of Operation	Type of Service	MAXIMUM RATINGS		TYPICAL OPERATION				
		Plate Voltage (volts)	Plate Current (amps)	Plate Voltage (volts)	Screen Voltage (volts)	Plate Current (amps)	Drive Power (watts)	Output Power (watts)
—	Switch Tube or Pulse Modulator	20,000	18.0†	20,000	1250	18.0	—	337,000†

† During the pulse

# 4PR250C/8248

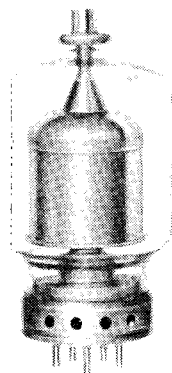

The 4PR250C/8248 is a pulse tetrode intended for use in pulse-modulator, switch tube, pulsed-amplifier, and pulsed-oscillator service. This compact, high vacuum, radial-beam tetrode, incorporating a tantalum plate and non-emitting grids, is recommended for use in new equipments where voltages to 50 kV are required.

Cooling of the tube is accomplished by radiation from the plate and by circulation of forced-air through the base and around the envelope. Cooling can be simplified by the use of the EIMAC SK-410 Air-System Socket.

## CHARACTERISTICS

Plate Dissipation (Max.)	250 watts
Screen Dissipation (Max.)	25 watts
Grid Dissipation (Max.)	5 watts
Frequency for Max. Ratings (Pulsed)	100 MHz
Cooling	Forced Air
Filament	Thoriated tungsten
Voltage	5.0 volts
Current	14.7 amperes
Capacitances (Gnd. Cath. Connection):	
Input	12.5 pF
Output	3.3 pF
Feed-through	0.12 pF
Amplification Factor (g <sub>1</sub> -g <sub>2</sub> )	5.1
Base	5-Pin Special
Recommended Air-System Socket	SK-400 Series
Recommended Heat Dissipating Connector	HR-8
Maximum Seal & Envelope Temperature	200°C
Maximum Length	7.63 in; 193.70 mm
Maximum Diameter	3.59 in; 91.30 mm
Weight (approximate)	12.5 oz; 355 gm
Operating Position	Vertical, base up or down

Class of Operation	Type of Service	MAXIMUM RATINGS		TYPICAL OPERATION				
		Plate Voltage (volts)	Plate Current (amps)	Plate Voltage (volts)	Screen Voltage (volts)	Plate Current (amps)	Drive Power (watts)	Output Power (watts)
C	RF Power Amplifier Plate & Screen Pulsed	35,000	5.5*	35,000†	1500†	0.9†	4.5‡	26,500†
C	RF Power Amplifier Grid Pulsed	25,000	5.5*	25,000	1500	0.94†	4.7†	19,000†
—	Switch Tube or Pulse Modulator	50,000	4.0	50,000	1500	4.0†	25†	192,000†

\*Cathode peak current  
† Pulse values

‡ When used as a plate and screen pulsed amplifier, the grid drive must also be pulsed to avoid overheating the grid.

Internal Anode, Radiation Cooled Tetrodes  
**4PR400A/8188**

**CHARACTERISTICS**

The 4PR400A/8188 is a pulse tetrode intended for use in pulse-modulator, pulsed-amplifier, and pulsed-oscillator service. This compact, high vacuum, radial-beam tetrode is recommended for use in new equipments where high voltage, high current, or high duty factor is encountered.

Cooling of the tube is accomplished by radiation from the plate and by circulation of forced-air through the base and around the envelope. Cooling can be simplified by the use of the EIMAC SK-410 Air-System Socket and the SK-406 Air Chimney.

- Plate Dissipation (Max.) . . . . . 400 watts
- Screen Dissipation (Max.) . . . . . 35 watts
- Grid Dissipation (Max.) . . . . . 10 watts
- Frequency for Max. Ratings (Pulsed) . . . . 110 MHz
- Cooling . . . . . Forced Air
- Filament . . . . . Thoriated tungsten
  - Voltage . . . . . 5.0 volts
  - Current . . . . . 14.7 amperes
- Capacitances (Gnd. Cath. Connection):
  - Input . . . . . 12.5 pF
  - Output . . . . . 4.7 pF
  - Feed-through . . . . . 0.12 pF
- Amplification Factor (g<sub>1</sub>-g<sub>2</sub>) . . . . . 5.1
- Base . . . . . 5-Pin Special
- Recommended Air-System Socket . . . . SK-400 Series
- Recommended Air Chimney . . . . . SK-406
- Recommended Heat Dissipating Connector . . HR-6
- Maximum Seal & Envelope Temperature . . . 200°C
- Maximum Length . . . . . 6.37 in; 161.90 mm
- Maximum Diameter . . . . . 3.56 in; 90.50 mm
- Weight (approximate) . . . . . 9.0 oz; 255.0 gm
- Operating Position . . . . . Vertical, base up or down

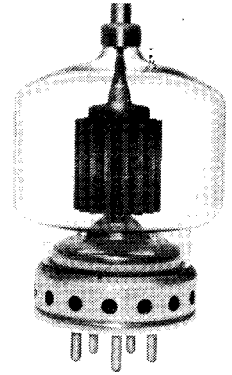

Class of Operation	Type of Service	MAXIMUM RATINGS		TYPICAL OPERATION				
		Plate Voltage (volts)	Plate Current (amps)	Plate Voltage (volts)	Screen Voltage (volts)	Plate Current (amps)	Drive Power (watts)	Output Power (watts)
C	RF Power Amplifier Plate & Screen Pulsed	15,000	5.4*	15,000†	1500†	0.87†	9.0‡	10,500†
C	RF Power Amplifier Grid Pulsed	10,000	5.4*	10,000	1500	0.87†	8.5†	6,600†
—	Switch Tube or Pulse Modulator	20,000	4.0	20,000	1500	3.5†	35†	64,000†

\*Cathode peak current  
 †Pulse Value

‡ When used as a plate and screen pulsed amplifier, the grid drive must also be pulsed to avoid overheating the grid.

**4PR1000A/8189\*\***

**CHARACTERISTICS**

The 4PR1000A/8189 is a pulse tetrode intended for use in pulse-modulator, pulsed-amplifier, and pulsed-oscillator service. This compact, high vacuum, radial-beam tetrode is recommended for use in new equipments where high voltage, high current, or high duty factor is encountered.

Cooling of the tube is accomplished by radiation from the plate and by circulation of forced-air through the base and around the envelope. Cooling can be simplified by the use of the EIMAC SK-510 Air-System Socket and the SK-506 Air Chimney.

- Plate Dissipation (Max.) . . . . . 1000 watts
- Screen Dissipation (Max.) . . . . . 75 watts
- Grid Dissipation (Max.) . . . . . 25 watts
- Frequency for Max. Ratings (Pulsed) . . . . 110 MHz
- Cooling . . . . . Forced Air
- Filament . . . . . Thoriated tungsten
  - Voltage . . . . . 7.5 volts
  - Current . . . . . 21.3 amperes
- Capacitances (Gnd. Cath. Connection):
  - Input . . . . . 28.1 pF
  - Output . . . . . 8.1 pF
  - Feed-through . . . . . 0.25 pF
- Base . . . . . 5-Pin Special
- Recommended Air-System Socket . . . . SK-500 Series
- Recommended Air Chimney . . . . . SK-506
- Recommended Heat Dissipating Connector . . HR-8
- Maximum Seal & Envelope Temperature . . . 200°C
- Maximum Length . . . . . 9.62 in; 244.50 mm
- Maximum Diameter . . . . . 5.25 in; 133.30 mm
- Weight (approximate) . . . . . 1.5 lb; 0.68 kg
- Operating Position . . . . . Vertical, base up or down

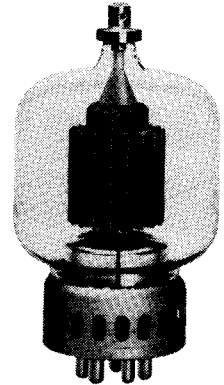

Class of Operation	Type of Service	MAXIMUM RATINGS		TYPICAL OPERATION				
		Plate Voltage (volts)	Plate Current (amps)	Plate Voltage (volts)	Screen Voltage (volts)	Plate Current (amps)	Drive Power (watts)	Output Power (watts)
C	RF Power Amplifier Plate & Screen Pulsed	20,000	12.0*	20,000†	1500†	1.95†	15.7‡	31,500†
C	RF Power Amplifier Grid Pulsed	15,000	12.0*	15,000	1500	1.95†	15.2†	23,000†
—	Switch Tube or Pulse Modulator	30,000	8.0	30,000	1500	8.0†	116†	220,000†

\*Cathode peak current  
 †Pulse Value

‡ When used as a plate and screen pulsed amplifier, the grid drive must also be pulsed to avoid overheating the grid.

\*\*For operation at 50 kV use type 8960, similar in all respects to 4PR1000A/8189

**8960**

## External Anode, Conduction Cooled Tetrodes 4CS250R

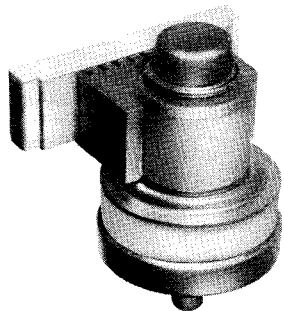

The 4CS250R is a compact, conduction cooled, high pervance radial beam tetrode. It is electrically identical to the 4CX250R except that the maximum dissipation of the 4CS250R is limited only by the maximum allowable anode and ceramic/metal seal temperatures. A beryllium oxide (BeO) thermal link is brazed to the anode providing an electrically isolated, low thermal resistance path between the anode and the heat sink. Ruggedized construction allows the 4CS250R to be operated in applications where shock and/or vibration is experienced.

### CHARACTERISTICS

Plate Dissipation (Max.)	Dependent on Cooling Technique
Screen Dissipation (Max.)	12 watts
Grid Dissipation (Max.)	2 watts
Frequency for Max. Ratings (CW)	500 MHz
Cooling	Conduction
Cathode	Oxide-coated Unipotential
Voltage	6.0 volts
Current	2.6 amperes
Capacitances (Gnd. Cath. Connection):	
Input	17.0 pF
Output	4.7 pF
Feed-through	0.04 pF
Base	9-Pin Special
Recommended Air-System Socket	SK-660, SK-661 Series
Maximum Seal & Anode Core Temperature	250°C
Maximum Length	2.46 in; 62.60 mm
Maximum Diameter	1.76 in; 44.90 mm
Weight (approximate)	5 oz; 141.7 gm
Operating Position	Any

Class of Operation	Type of Service	MAXIMUM RATINGS		TYPICAL OPERATION					
		Plate Voltage (volts)	Plate Current (amps)	Freq. (MHz)	Plate Voltage (volts)	Screen Voltage (volts)	Plate Current (amps)	Drive Power (watts)	Output Power (watts)
C	RF Power Amplifier	2000	0.25	175	2000	250	0.24	1.1	379
C	RF Power Amplifier Plate Modulated	1500	0.20	—	1500	250	0.20	1.7	235
AB <sub>1</sub>	RF Linear Amplifier	2000	0.25	—	2000	400	0.24	—	470‡
AB <sub>1</sub>	AF Amplifier or Modulator	2000	0.25	—	2000	350	0.50*	—	595*

\*Two tubes

‡Useful PEP Output Power

## 7843

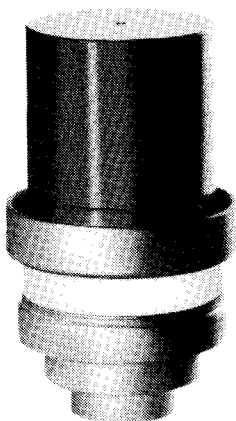

The 7843 is a compact external anode radial-beam tetrode for use in RF power amplifier service, RF linear power amplifier applications, and as an audio frequency amplifier or modulator. The tube is designed to be conduction cooled and has a 26.5 volt heater.

The 7843 has an F<sub>1</sub> rating of 1215 MHz for full-rated power input and is tested to show a useful power output of 80 watts at 400 MHz.

The 7843 is identical to the Type 6884 except for the anode configuration and cooling technique required.

### CHARACTERISTICS

Plate Dissipation (Max.)	115 watts
Screen Dissipation (Max.)	4.5 watts
Grid Dissipation (Max.)	1.0 watts
Frequency for Max. Ratings (CW)	1215 MHz
Cooling	Conduction
Cathode	Oxide-coated Unipotential
Voltage	26.5 volts
Current	0.53 amperes
Capacitances (Gnd. Cath. Connection):	
Input	30.5 pF
Output	4.7 pF
Feed-through	0.05 pF
Capacitances (Gnd. Grid Connection):	
Input	13.0 pF
Output	4.7 pF
Feed-through	0.01 pF
Amplification Factor (g <sub>1</sub> -g <sub>2</sub> )	18
Base	Special, Coaxial
Maximum Seal & Anode Core Temperature	250°C
Maximum Length	1.95 in; 49.60 mm
Maximum Diameter	1.12 in; 28.40 mm
Weight (approximate)	1.7 oz; 48.2 gm
Operating Position	Any

Class of Operation	Type of Service	MAXIMUM RATINGS		TYPICAL OPERATION					
		Plate Voltage (volts)	Plate Current (amps)	Freq. (MHz)	Plate Voltage (volts)	Screen Voltage (volts)	Plate Current (amps)	Drive Power (watts)	Output Power (watts)
C	RF Power Amplifier	1000	0.18	400	900	300	0.17	3	80†
C	RF Power Amplifier Plate Modulated	800	0.15	400	700	250	0.13	3	45†
AB <sub>1</sub>	RF Linear Amplifier	1000	0.18	30	850	300	0.10	—	40†
AB <sub>1</sub>	AF Amplifier or Modulator	1000	0.18	—	850	300	0.20*	—	80
AB <sub>2</sub>	AF Amplifier or Modulator	1000	0.18	—	850	300	0.35*	—	140

\*Two tubes

†Useful output power

**CHARACTERISTICS**

The 8954 is designed for switch-tube (or modulator) and voltage regulator service, with anode current up to 8 amperes with short pulses (to 2 micro-seconds) and derated values of anode current at longer pulse lengths.

The tube has an oxide cathode and all electrical connections are made to solder tabs which are integral to the tube elements.

The 8954 is supplied bare-anode and is intended to be cooled by heat sink, or liquid immersion, or a combination, and is nominally rated for 600 watts of anode dissipation.

The tube is rated to operate at 5.5 kVdc in air, at sea level, or 7.5 kVdc in an insulating oil environment. The tube is designed to withstand brief fault conditions which may raise the instantaneous anode voltage to 12 kV.

- Plate Dissipation (Max.) . . . . . 600 watts
- Screen Dissipation (Max.) . . . . . .15 watts
- Grid Dissipation (Max.) . . . . . . . 4 watts
- Cooling . . . . . Conduction or Liquid Immersion
- Cathode . . . . . Oxide-coated Unipotential
- Voltage . . . . . .6.0 volts
- Current . . . . . .5.6 amperes
- Capacitances (Gnd. Cath. Connection):
- Input . . . . . . . 50.0 pF
- Output . . . . . . . .6.2 pF
- Feed-through . . . . . . . .0.14 pF
- Base . . . . . Special, Solder-tab Terminals
- Maximum Seal & Anode Core Temperature . . 250°C
- Maximum Length . . . . . .2.52 in; 64.01 mm
- Maximum Diameter . . . . . .1.77 in; 44.96 mm
- Weight (approximate) . . . . . .6.0 oz; 170 gm
- Operating Position . . . . . . . . . . Any

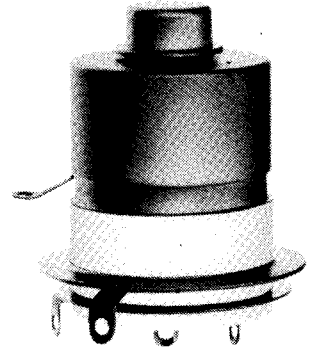

Class of Operation	Type of Service	MAXIMUM RATINGS		TYPICAL OPERATION				
		Plate Voltage (volts)	Plate Current (amps)	Plate Voltage (volts)	Screen Voltage (volts)	Plate Current (amps)	Drive Power (watts)	Output Power (watts)
—	Switch Tube or Pulse Modulator (Air Operation)	5500	8.0	—	—	—	—	—
—	Switch Tube or Pulse Modulator (Oil Immersed)	7500	8.0	—	—	—	—	—

Internal anode, Radiation Cooled Pentodes

# 5-500A

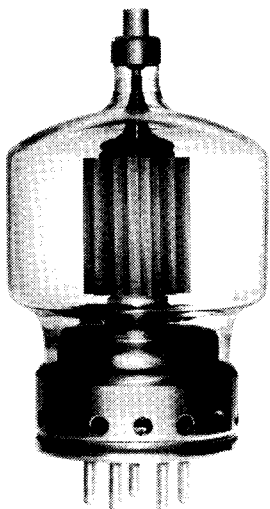

The 5-500A is a compact, ruggedly constructed radial-beam power pentode having a maximum plate dissipation rating of 500 watts. It is intended for use as an amplifier, oscillator or modulator. The high plate current rating, low grid-plate capacitance and low driving power requirements permit maximum power capability to be combined with circuit simplicity and economic driver requirements.

The 5-500A is cooled by radiation from the plate and by circulation of forced-air through the base, around the envelope and over the plate seal. Cooling may be greatly simplified by the use of the EIMAC SK-400 or SK-410 Air System Socket and the accompanying EIMAC SK-426 glass chimney.

The suppressor element of the 5-500A terminates at the tube base shell, and is designed to be operated at ground (zero) potential. The base shell must be grounded by means of suitable spring clips.

## CHARACTERISTICS

Plate Dissipation (Max.)	500 watts
Screen Dissipation (Max.)	35 watts
Grid Dissipation (Max.)	12 watts
Cooling	Forced Air
Filament	Thoriated tungsten
Voltage	10.0 volts
Current	10.2 amperes
Capacitances (Gnd. Cath. Connection):	
Input	17.0 pF
Output	10.8 pF
Feed-through	0.1 pF
Base	5-Pin Special
Recommended Air-System Socket	SK-400 Series
Recommended Air Chimney	SK-426
Recommended Heat Dissipating Connector	HR-6
Maximum Seal & Envelope Temperature	200°C
Maximum Length	7.00 in; 177.80 mm
Maximum Diameter	3.56 in; 90.40 mm
Weight (approximate)	11 oz; 312 gm
Operating Position	Vertical, base up or down

Class of Operation	Type of Service	MAXIMUM RATINGS		TYPICAL OPERATION				
		Plate Voltage (volts)	Plate Current (amps)	Plate Voltage (volts)	Screen Voltage (volts)	Plate Current (amps)	Drive Power (watts)	Output Power (watts)
C	RF Power Amplifier	4000	0.45	4000	500	0.45	14	1300
C	RF Power Amplifier Plate Modulated	3200	0.35	3100	470	0.26	6	580
AB <sub>1</sub>	RF Linear Amplifier	4000	0.45	4000	750	0.32	—	832
AB <sub>1</sub>	AF Amplifier or Modulator	4000	0.45	4000	750	0.65*	—	1664*

\*Two tubes

## External Anode, Forced Air Cooled Pentodes 5CX1500A

### CHARACTERISTICS

The 5CX1500A is a ceramic/metal power pentode designed for use as a Class AB<sub>1</sub> linear amplifier in audio or radio frequency applications. Its characteristic low intermodulation distortion makes it especially suitable for single sideband service. The filament is a rugged mesh type.

The tube is also recommended for use as a Class C RF power amplifier in CW, FM and AM service.

- Plate Dissipation (Max.) . . . . . 1500 watts
- Suppressor Dissipation (Max.) . . . . . .25 watts
- Screen Dissipation (Max.) . . . . . .75 watts
- Grid Dissipation (Max.) . . . . . .25 watts
- Frequency for Max. Ratings (CW) . . . . . 110 MHz
- Cooling . . . . . Forced Air
- Filament . . . . . Thoriated tungsten mesh
- Voltage . . . . . .5.0 volts
- Current . . . . . 40 amperes
- Capacitances (Gnd. Cath. Connection):
- Input . . . . . 75.0 pF
- Output . . . . . 16.5 pF
- Feed-through . . . . . .0.2 pF
- Capacitances (Gnd. Grid Connection):
- Input . . . . . 34.5 pF
- Output . . . . . 16.5 pF
- Feed-through . . . . . 0.05 pF
- Amplification Factor ( $g_{1-92}$ ) . . . . . .5
- Transconductance† . . . . . .24,000 $\mu$ mhos
- Base . . . . . Special Ring and Breechblock
- Recommended Air-System Socket . . . . . SK-840 Series
- Recommended Air Chimney . . . . . SK-806
- Maximum Seal & Anode Core Temperature . . . . . 250°C
- Maximum Length . . . . . 4.95 in; 125.70 mm
- Maximum Diameter . . . . . 3.37 in; 85.60 mm
- Weight (approximate) . . . . . 30 oz; 850 gm
- Operating Position . . . . . Vertical, base up or down

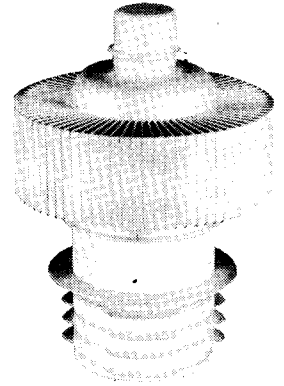

Class of Operation	Type of Service	MAXIMUM RATINGS		TYPICAL OPERATION				
		Plate Voltage (volts)	Plate Current (amps)	Plate Voltage (volts)	Screen Voltage (volts)	Plate Current (amps)	Drive Power (watts)	Output Power (watts)
C	RF Power Amplifier	5000	1.0	4500	500	0.90	9.0	3180
C	RF Power Amplifier Plate Modulated	3500	0.8	3200	500	0.80	10	1958
AB <sub>1</sub>	RF Linear Amplifier	4000	1.0	4000	500	0.7	—	1785
AB <sub>1</sub>	AF Amplifier or Modulator	4000	1.0	3800	500	1.3*	—	3220*

\*Two tubes      †  $A + I_b = 1.0 A$

## 5CX3000A

### CHARACTERISTICS

The 5CX3000A is a ceramic/metal power pentode designed for use as a Class AB<sub>1</sub> linear amplifier in audio or radio-frequency applications. Its characteristics of low intermodulation distortion make it especially suitable for single side-band service.

- Plate Dissipation (Max.) . . . . . 4000 watts
- Suppressor Dissipation (Max.) . . . . . .100 watts
- Screen Dissipation (Max.) . . . . . .175 watts
- Grid Dissipation (Max.) . . . . . .50 watts
- Frequency for Max. Ratings (CW) . . . . . 150 MHz
- Cooling . . . . . Forced Air
- Filament . . . . . Thoriated tungsten
- Voltage . . . . . .9.0 volts
- Current . . . . . 41.5 amperes
- Capacitances (Gnd. Cath. Connection):
- Input . . . . . 135 pF
- Output . . . . . 21.0 pF
- Feed-through . . . . . .0.4 pF
- Capacitances (Gnd. Grid Connection):
- Input . . . . . 61.0 pF
- Output . . . . . 21.0 pF
- Amplification Factor ( $g_{1-92}$ ) . . . . . .5
- Base . . . . . Special Ring & Breechblock
- Recommended Air-System Socket . . . . . SK-1420 Series
- Recommended Air Chimney . . . . . SK-1426
- Maximum Seal & Anode Core Temperature . . . . . 250°C
- Maximum Length . . . . . 6.84 in; 173.70 mm
- Maximum Diameter . . . . . 4.63 in; 117.60 mm
- Weight (approximate) . . . . . 5.5 lb; 2.5 kg
- Operating Position . . . . . Vertical, base up or down

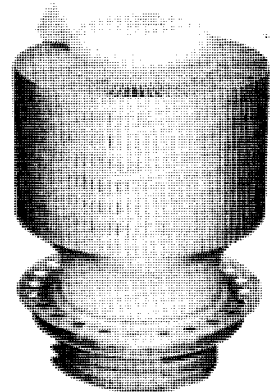

Class of Operation	Type of Service	MAXIMUM RATINGS		TYPICAL OPERATION				
		Plate Voltage (volts)	Plate Current (amps)	Plate Voltage (volts)	Screen Voltage (volts)	Plate Current (amps)	Drive Power (watts)	Output Power (watts)
C	RF Power Amplifier	7000	2.0	6800	500	1.6	52	8500
AB <sub>1</sub>	RF Linear Amplifier	7000	2.0	6000	850	1.4	—	5500
AB <sub>1</sub>	AF Amplifier or Modulator	7000	2.0	6000	850	2.9*	—	11,000*

\*Two tubes

External Anode, Forced Air Tetropdes

**8295A**

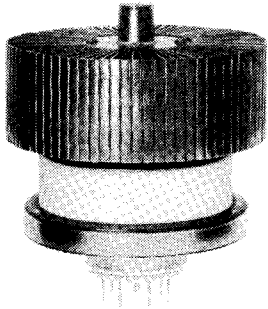

The 8295A is a ceramic/metal, forced-air cooled, radial beam pentode with a rated maximum plate dissipation of 1000 watts. It is capable of high power gain and excellent efficiency at relatively low plate voltage. The 8295A is a direct replacement for the 8295.

This external-anode tube is especially suited for Class AB<sub>1</sub> linear RF amplifier service, but will also provide excellent performance in Class AB<sub>2</sub>, Class B, and Class C service.

**CHARACTERISTICS**

- Plate Dissipation (Max.) . . . . . 1000 watts
- Screen Dissipation (Max.) . . . . . 30 watts
- Frequency for Max. Ratings (CW) . . . . . 30 MHz
- Cooling . . . . . Forced Air
- Cathode . . . . . Oxide-coated Unipotential
- Voltage . . . . . 6.0 volts
- Current . . . . . 8.2 amperes
- Capacitances (Gnd. Cath. Connection):
  - Input . . . . . 40.0 pF
  - Output . . . . . 18.5 pF
  - Feed-through . . . . . 0.09 pF
- Amplification Factor (g<sub>1</sub>-g<sub>2</sub>) . . . . . 3.4
- Base . . . . . 7-Pin Special Recommended Air-System Socket (includes integral chimney) . . SK-184 or SK-184A
- Maximum Seal & Anode Core Temperature . . 250°C
- Maximum Length . . . . . 5.05 in; 128.00 mm
- Maximum Diameter . . . . . 4.03 in; 102.00 mm
- Weight (approximate) . . . . . 2.8 lb; 1.27 kg
- Operating Position . . . . . Any

Class of Operation	Type of Service	MAXIMUM RATINGS		TYPICAL OPERATION				
		Plate Voltage (volts)	Plate Current (amps)	Plate Voltage (volts)	Screen Voltage (volts)	Plate Current (amps)	Drive Power (watts)	Output Power (watts)
C	RF Power Amplifier	3000	1.0	3000	500*	0.82	2.1	1770†
AB <sub>1</sub>	RF Linear Amplifier	3000	0.8	3000	500*	0.80	—	1700†

\*Suppressor grid voltage = +35 Vdc

†Useful Power Output



# RECOMMENDED REPLACEMENT TYPES

The following EIMAC types, currently in production, are for renewal use and are not suggested for new equipment design. Data on these tubes may

be obtained from the Power Grid Tube Division of EIMAC.

2X1000A	4CV20,000A	4X500A	152TH	284	826	7815BAL
2-01C	4CX125C	4-400A/8438	152TL	290	1000T	7815XAL
2-25A	4CX125F	4-400B/7527	175A	290A	1500T	7855K
2-50A	4D21A	6C21	177WA	304TH	2000T	8020/100R
2-150D	4E27A/5-125B	25T	250R	304TL	5867A	8560A
2-2000A	4PR65A/8187	35T	250TH	322	6155	8560AS
3C24	4PR125A/8247	75TH	250TL	450TH	6156	8756
3CV1500A7	4PR1000B	75TL	253	450TL	6569	8906XAL
3-200A3/592	4W300B/8249	100TH	254W	592/3-200A3	6580	8944
4CN15A	4W20,000A/8173	100TL	264/8576	750TL	7457	
4CV1500B	4X150G/8172					

# FIMAC EQUIVALENT LIST

This index lists tubes of other manufacturers for which EIMAC types are suggested as equivalents. The data sheet for the particular EIMAC type should

be consulted before direct replacement is made because of possible mechanical or electrical differences.

TUBE TYPE	EIMAC EQUIV.	TUBE TYPE	EIMAC EQUIV.	TUBE TYPE	EIMAC EQUIV.
AC55	4CX5000A/8170	ITW-10-1	3CW10,000H3	3H/151J	7289
AY3-65	4-65A/8165	Q 160-1	4-125A	3HC/151JYY	3CX100A5
B1109	3C24	Q 400-1	4-400A/8438	3SO35T	5867A
B1135	100TH	QB3-200	4-65A/8165	4F15R	4X150A/7034
BW194	6696A	QB3-300	6155	4F17R	4X150G/8172
C112	6156	QB3-300A	4-125A	4F20R	7609
C1108	4-125A	QB3.5-750	6156	4F21	4-125A
C1112	4-250A/5D22	QB3.5-750GH	4-250A/5D22	4F84	7843
C1136	4-400A/8438	QB4-250B	4-250A/5D22	4H135M	4X150A/7034
CV-427	4PR60C/8252W	QB4-1100GA	4-400A/8438	4H160M	4CX250B/7203
CV-668	35T	QBL4/800	4X500A	4HC/160M	4CX250B/7203
CV-789	3C24	QE61/250	4CX250B/7203	4K84	2-450A
CV-824	4-125A	QEL1/150	4X150A/7034	4SO16-T	4-125A
CV-998	2000T	QEL1/150H	7609	4SO40T	4-250A/5D22
CV-1102	4-250A/5D22	QEL2/200	7580	4T10R	7289
CV-1350	5867A	QEL2/275	4CX250B/7203	4T16	100TL
CV-1905	4-65A/8165	QV1-150	4X150A/7304	4T17	100TH
CV-2130	6155	QV1-150D	7609	4T25R	4X150G/8172
CV-2131	6156	QV1-150G	4X150G/8172	5F15R	4X150A/7034
CV-2159	4X150A/7034	QV2-250G	4CX250B/7203	5F16R	7609
CV-2416	4PR60C/8252W	QY3-65A	4-65/8165	5F17R	4X150G/8172
CV-2487	4CX250B/7203	QY3-125	6155	5F20RA	4CX250B/7203
CV-2516	7289	QY3-125B	4-125A	5F22	4-250A/5D22
CV-2519	4X150A/7304	QY4-250	6156	5F22A	6156
CV-2552	100TH	QY4-250B	4-250A/5D22	5F23	4-400A/8438
CV-2572	450TH	QY4-400	4-400B/7527	5F23A	7527/4-400B
CV-2589	250TH	QY4-400VB	4-400A/8438	5F25R	4CX250FG
CV-2611	304TH	QY4-500A	4X500A	5F35R	4CX350A/8321
CV-2711	1500T	RS-630	100TH	5T20	250TL
CV-2752	4PR60C/8252W	RS-685	4-125A	5T21	250TH
CV-2963	4-125A	RS-1002A	4-250A/5D22	5T30	450TL
CV-2964	4-250A/5D22	RS-1007	4-125A	5T31	450TH
CV-2967	8020/100R	RS-1026	5867A	5T34	304TL
CV-3879	4-400A/8438	RS-2016	4CX5000A/8170	5T35	304TH
CV-3880	4-1000A/8166	RS-2793	4CX5000A/8170	6F50R	4X500A
CV-3893	4X150G/8172	RS-4791	4CX1000A/8168	6F50RA	4X500A
CV-3991	7609	RY-12-100	8020/100R	6T35	750TL
CV-5176	2-01C	T-130-1	100TH	7F25	4-1000A/8166
CV-5430	7289	T-150-1	250TL	7F25A	4-1000A/8166
CV-5959	4-400B/7527	T-300-1	450TH	7T40	1000T
CV-6122	4-65A/8165	T-380-1	3-400Z/8163	7T45	1500T
CV-6131	4PR60C/8252W	T-1000-1	3-1000Z/8164	8F10R	4CX5000A/8170
CV-6137	4CX250B/7203	TAW12-35	6696A	8F11R	4CX10,000D/8171
CV-6184	4CX10,000D/8171	TB-3/350	100TH	9T69	6696A
CV-8295	4CX5000A/8170	TB-4/800	250TH	35R	2-50A
CV-8698	4CX350A/8321	TB-750	5867A	381	7289
CV-11106	5CX1500A	TD-1-100A	7289	152RA	2-150D
CV-11107	4CX35,000C/8349	TH-4327	4E27A/5-125B	451	8020/100R
DET-18	35T	TT-16	4-125A	2100	8020/100R
E-250A	6156	TT-16D	6155	2000R	2-2000A
E-900	250TH	2T24	3C24	3861B	4X150A/7034
E-3033	4CX10,000D/8171	3C200	250TH	7525	4-1000A/8166
ET-1000	250TH	3F65	4-65A/8165		

# EIMAC/JEDEC CROSS-REFERENCE LIST

## EIMAC to JEDEC

EIMAC No.	JEDEC No.	EIMAC No.	JEDEC No.	EIMAC No.	JEDEC No.	EIMAC No.	JEDEC No.
2-01C	—	3CX20,000H3	—	4PR60B	8252	6884	6884
2-25A	—	4-65A	8165	4PR60C	8252W	6894	6894
2-50A	—	4-125A	4D21	4PR65A	8187	6895	6895
2-150D	—	4-250A	5D22	4PR125A	8247	7211	7211
2-240A	—	4-400A	8438	4PR250C	8248	7457	7457
2-2000A	—	4-400B	7527	4PR400A	8188	7480	7480
2C39A	2C39A	4-400C	6775	4PR1000A	8189	7609	7609
2C39WA	2C39WA	4-500A	—	4PR1000B	—	7698	7698
2X1000A	—	4-1000A	8166	4W300B	8249	7815AL	7815AL
2X3000F	—	4CN15A	—	4X150A	7034	7815RAL	7815RAL
3C24	3C24	4CPX250K	8590	4X150G	8172	7815X	7815X
3-200A3	592	4CS250R	—	4X500A	—	7815XAL	7815XAL
3-400Z	8163	4CV1500B	—	5-125B	4E27A	7843	7843
3-500Z	—	4CV8000A	—	5-500A	—	7855	7855
3-1000Z	8164	4CV20,000A	—	5CX1500A	—	7855AL	7855AL
3CPN10A5	7815	4CV35,000A	—	5CX3000A	—	7855K	7855K
3CPX100A5	7815R	4CV50,000E	—	6C21	6C21	7855KAL	7855KAL
3CPX1500A7	—	4CV50,000J	—	25T	25T	8295A	8295A
3CV1500A7	—	4CV100,000C	8351	35T	35T	8403	8403
3CV30,000A1	—	4CV250,000A	—	35TG	35TG	8432	8432
3CV30,000A3	—	4CW800B	—	75TH	75TH	8533W	8533W
3CV30,000H3	—	4CW800F	—	75TL	75TL	8560A	8560A
3CV50,000A7	—	4CW2000A	8244	100R	8020	8560AS	8560AS
3CW5000A1	8240	4CW10,000A	8661	100TH	100TH	8745	8745
3CW5000A3	8242	4CW25,000A	—	100TL	100TL	8755	8755
3CW5000F1	8241	4CW50,000E	—	152TH	152TH	8755A	8755A
3CW5000F3	8243	4CW50,000J	—	152TL	152TL	8756	8756
3CW5000H3	—	4CW100,000D	—	175A	—	8757	8757
3CW10,000A3	—	4CW100,000E	—	177A	—	8847	8847
3CW10,000H3	—	4CW250,000A	—	177WA	6549W	8847A	8847A
3CW20,000A1	—	4CX125C	—	250R	—	8873	8873
3CW20,000A3	—	4CX125F	—	250TH	250TH	8874	8874
3CW20,000A7	—	4CX250B	7203	250TL	250TL	8875	8875
3CW20,000H3	—	4CX250BC	8957	253	253	8876	8876
3CW20,000H7	—	4CX250FG	8621	254W	—	8892	8892
3CW30,000H3	—	4CX250K	8245	264	8576	8893	8893
3CW30,000H7	—	4CX250M	8246	279	—	8906	8906
3CW40,000H3	—	4CX250R	7580W	284	—	8906AL	8906AL
3CX100A5	7289	4CX300A	8167	290	—	8906BAL	8906BAL
3CX100F5	8250	4CX300Y	8561	294	—	8906X	8906X
3CX400U7	8961	4CX350A	8321	304TH	304TH	8906XAL	8906XAL
3CX1000A7	8283	4CX350F	8322	304TL	304TL	8907	8907
3CX1500A7	8877	4CX350FJ	8904	322	—	8911	8911
3CX2500A3	8161	4CX600B	—	450TH	450TH	8912	8912
3CX2500F3	8251	4CX600F	—	450TL	450TL	8930	8930
3CX2500H3	—	4CX600J	8809	750TL	750TL	8933	8933
3CX3000A1	8238	4CX600JA	8921	826	826	8938	8938
3CX3000A7	—	4CX1000A	8168	1000T	1000T	8940	8940
3CX3000F1	8239	4CX1000K	8352	1500T	1500T	8941	8941
3CX3000F7	8162	4CX1500A	—	2000T	2000T	8942	8942
3CX5000A3	—	4CX1500B	8660	5867A	5867A	8944	8944
3CX5000H3	—	4CX3000A	8169	6155	6155	8954	8954
3CX10,000A1	8158	4CX5000A	8170	6156	6156	8959	8959
3CX10,000A3	8159	4CX5000J	8909	6549	6549	8960	8960
3CX10,000A7	8160	4CX5000R	8170W	6569	6569	8962	8962
3CX10,000H3	—	4CX10,000D	8171	6580	6580	8963	8963
3CX15,000A3	—	4CX10,000J	—	6696A	6696A	8964	8964
3CX15,000A7	—	4CX15,000A	8281	6697A	6697A	8965	8965
3CX15,000H3	—	4CX15,000J	8910	6775	6775		
3CX20,000A3	—	4CX35,000C	8349	6816	6816		
3CX20,000A7	—	4D21A	4D21A				

# JEDEC/EIMAC CROSS-REFERENCE LIST

## JEDEC to EIMAC

JEDEC No.	EIMAC No.	JEDEC No.	EIMAC No.	JEDEC No.	EIMAC No.
2C39A	2C39A	7843	7843	8661	4CW10,000A
2C39WA	2C39WA	7855	7855	8745	8745
3C24	3C24	7855AL	7855AL	8755	8755
4D21	4-125A	7855K	7855K	8755A	8755A
4D21A	4D21A	7855KAL	7855KAL	8756	8756
4E27A	5-125B	8020	100R	8757	8757
5D22	4-250A	8158	3CX10,000A1	8809	4CX600J
6C21	6C21	8159	3CX10,000A3	8847	8847
25T	25T	8160	3CX10,000A7	8847A	8847A
35T	35T	8161	3CX2500A3	8873	8873
35TG	35TG	8162	3CX3000F7	8874	8874
75TH	75TH	8163	3-400Z	8875	8875
75TL	75TL	8164	3-1000Z	8877	3CX1500A7
100TH	100TH	8165	4-65A	8892	8892
100TL	100TL	8166	4-1000A	8893	8893
152TH	152TH	8167	4CX300A	8904	4CX350FJ
152TL	152TL	8168	4CX1000A	8906	8906
250TH	250TH	8169	4CX3000A	8906AL	8906AL
250TL	250TL	8170	4CX5000A	8906BAL	8906BAL
253	253	8170W	4CX5000R	8906X	8906X
304TH	304TH	8171	4CX10,000D	8906XAL	8906XAL
304TL	304TL	8172	4X150G	8907	8907
450TH	450TH	8187	4PR65A	8909	4CX5000J
450TL	450TL	8188	4PR400A	8910	4CX15,000J
592	3-200A3	8189	4PR1000A	8911	8911
750TL	750TL	8238	3CX3000A1	8912	8912
826	826	8239	3CX3000F1	8921	4CX600JA
1000T	1000T	8240	3CW5000A1	8930	8930
1500T	1500T	8241	3CW5000F1	8933	8933
2000T	2000T	8242	3CW5000A3	8938	8938
5867A	5867A	8243	3CW5000F3	8940	8940
6155	6155	8244	4CW2000A	8941	8941
6156	6156	8245	4CX250K	8942	8942
6549W	177WA	8246	4CX250M	8944	8944
6569	6569	8247	4PR125A	8954	8954
6580	6580	8248	4PR250C	8957	4CX250BC
6696A	6696A	8249	4W300B	8959	8959
6697A	6697A	8250	3CX100F5	8960	8960
6775	4-400C	8251	3CX2500F3	8961	3CX400U7
6816	6816	8252	4PR60B	8962	8962
6884	6884	8252W	4PR60C	8963	8963
6894	6894	8281	4CX15,000A	8964	8964
6895	6895	8283	3CX1000A7	8965	8965
7034	4X150A	8295A	8295A		
7203	4CX250B	8321	4CX350A		
7211	7211	8322	4CX350F		
7289	3CX100A5	8349	4CX35,000C		
7457	7457	8351	4CV100,000C		
7480	7480	8352	4CX1000K		
7527	4-400B	8403	8403		
7580W	4CX250R	8432	8432		
7609	7609	8438	4-400A		
7698	7698	8533W	8533W		
7815	3CPN10A5	8560A	8560A		
7815AL	7815AL	8560AS	8560AS		
7815R	3CPX100A5	8561	4CX300Y		
7815RAL	7815RAL	8576	264		
7815X	7815X	8590	4CPX250K		
7815XAL	7815XAL	8621	4CX250FG		
		8660	4CX1500B		

# SOCKETS

These sockets and accessories are specifically designed for use with EIMAC tubes. Choice of the proper socket insures longer tube life and better performance. All sockets incorporate low loss insulating materials. All metal parts are plated for corrosion protection. Tube contact surfaces are non-ferrous spring alloy, silver plated for good RF conductivity and heat treated for positive contact and long life. Open construction permits adequate air flow for tube cooling.

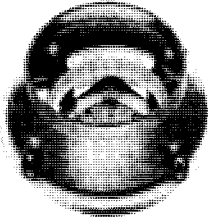

**SK-184**

SK-184A, SK-209B, SK-265A and SK-291A resemble SK-184 in general appearance

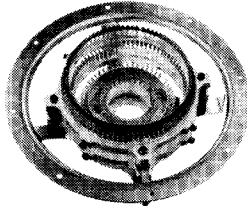

**SK-300A**

SK-300 and SK-310 resemble SK-300A in general appearance

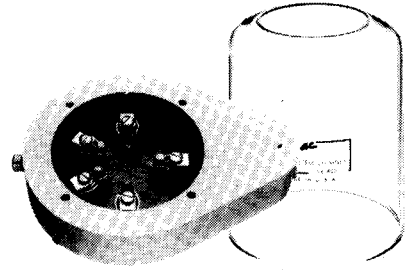

**SK-400 SK-406**

SK-500 resembles SK-400 in general appearance  
SK-416, SK-506, and SK-516 resemble SK-406

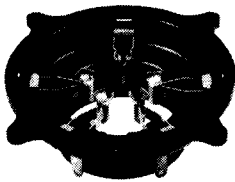

**SK-410**

SK-510 resembles SK-410 in general appearance

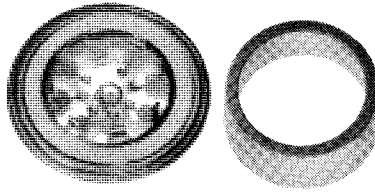

**SK-600 SK-606**

SK-600A, SK-602, SK-602A, SK-607, SK-610, SK-610A, SK-611 and SK-611A resemble SK-600 in general appearance

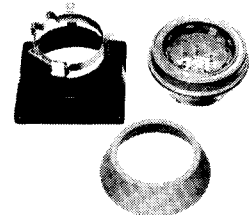

**SK-620 SK-626 SK-636B**

SK-620A, SK-630 and SK-630A resemble SK-620



**SK-640**

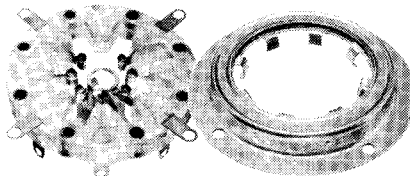

**SK-650 SK-655**

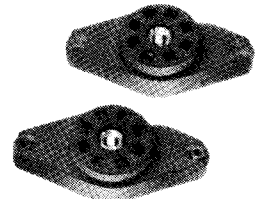

**SK-660 SK-660A**

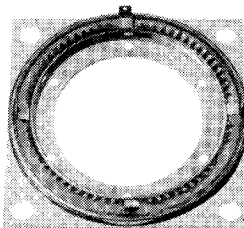

**SK-680**

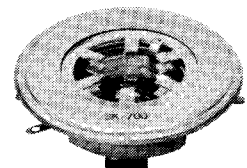

**SK-700**

SK-710, SK-711A, and SK-712A resemble SK-700 in appearance

# CUSTOM SOCKET DESIGN

For special applications which require features different from these standard sockets, custom designed sockets are offered. These may be modifications of the standard sockets or completely new designs, manufactured to customer drawings or EIMAC design. Common modifications include: contact spacing, mounting features, encapsulation of components, grounded contacts, by-pass capacitors; insulating materials, contact materials, and plating.

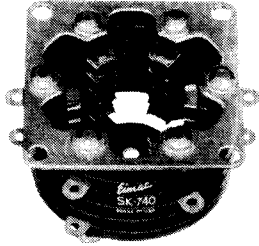

SK-740

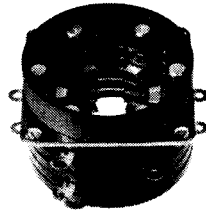

SK-760

SK-761 and SK-770 resemble SK-760

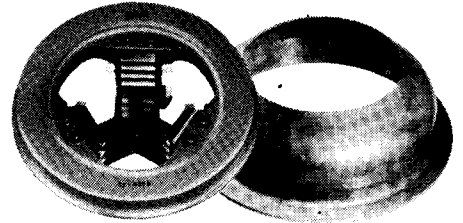

SK-800B SK-806

SK-810B and SK-890 resemble SK-800B

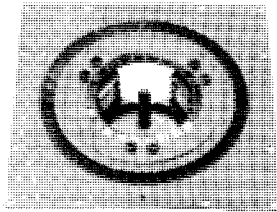

SK-820

SK-830A, SK-831, SK-840, SK-860, SK-861 and SK-871 resembles SK-820

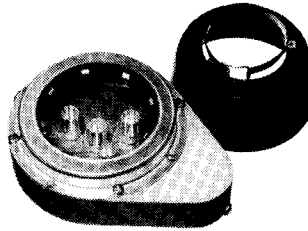

SK-900 SK-906

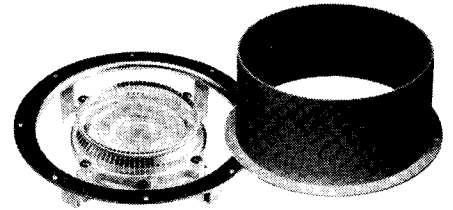

SK-1300 SK-1306

SK-1310 and SK-1320 resemble SK-1300

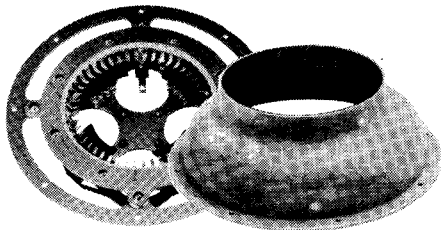

SK-1400 SK-1406

SK-1420, SK-1470, and SK-1490 resemble SK-1400

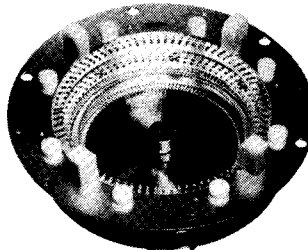

SK-1500

SK-1510 resembles SK-1500

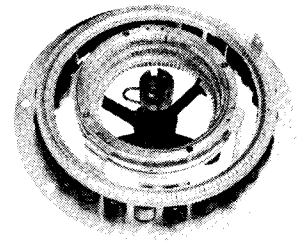

SK-2000

SK-2001 and SK-2011 resemble SK-2000

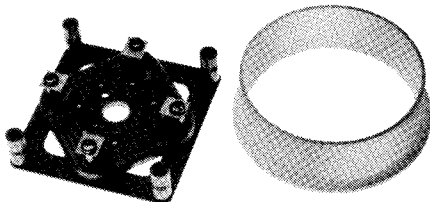

SK-2200 SK-2216

SK-2210 resembles SK-2200

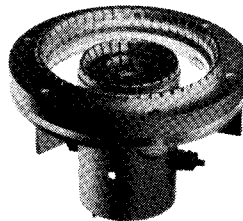

SK-2220

## SOCKETS AND CHIMNEYS

Air-System Socket	Tube	Bypass Capacitor			Grounded Contacts	Chimney
		PF	Voltage DCWV	Element Bypassed		
SK-184	8295A	2000	1000	screen	none	C-184 included
		2500	500	suppressor		
SK-184A	8295A	2000	1000	screen	suppressor	C-184 included
SK-209B	8432	2000	1000	screen	suppressor	C-209 included
SK-265A	8576/264	2000	1000	screen	suppressor	C-265 included
SK-291A	290/290A	2000	1000	screen	suppressor	C-291 included
SK-300A*	<u>4CX5000A</u> 8170	none	—	—	none	SK-306
	<u>4CX5000R</u> 8170W					
	4CX5000J					none required
	4CW10,000A 4CW25,000A					
	<u>4CX10,000D</u> 8171	none	—	—	none	SK-1306
	4CX10,000J					
	<u>4CX15,000A</u> 8181	none	—	—	none	SK-316
	<u>4CX15,000J</u> 8910					
SK-310	4CV20,000A 4CV35,000A	none	—	—	none	none required

\*Low air pressure drop.

## SOCKETS AND CHIMNEYS

Air-System Socket	Tube	Bypass Capacitor			Grounded Contacts	Chimney
		PF	Voltage DCWV	Element Bypassed		
SK-400	<u>4-125A</u> 4D21				none	none required
	4D21A					
	<u>4PR125A</u> 8247					
	<u>4PR250C</u> 8248					
SK-400	<u>4-250A</u> 5D22				none	SK-406
	<u>4-400A</u> 8438	—	—	—		
	<u>4-400C</u> 6775					
	<u>4PR400A</u> 8188					
SK-410	4-500A 5-500A				none	SK-426
	same as SK-400 plus: 6155					
	3-500Z					
	<u>4-400B</u> 7627	—	—	—		
SK-410	5867A 6156				none	SK-406
	<u>3-400Z</u> 8163					
SK-500	<u>4-1000A</u> 8166				none	SK-506
	<u>4PR1000A</u> 8189	—	—	—		
	4PR1000B 279 284 8960					

## SOCKETS AND CHIMNEYS

Air-System Socket	Tube	Bypass Capacitor			Grounded Contacts	Chimney
		PF	Voltage DCWV	Element Bypassed		
SK-510	same as SK-500	—	—	—	none	SK-506
	plus: <u>3-1000Z</u> 8164					SK-516
SK-600 SK-602**	<u>4CX250B</u> 7203	2700	400	screen	none	SK-606
	<u>4CX250BC</u> 8957					
SK-600A* SK-602A† SK-611‡	<u>4CX250FG</u> 8621	2700	1000	screen	none	SK-646  none required
	<u>4CX250R</u> 7850W					
	<u>4CX350A</u> 8321					
	<u>4CX350F</u> 8322					
	<u>4CX350FJ</u> 8904					
	<u>4X150A</u> 7034  7609					
8930						
	<u>4W300B</u> 8249					

\*Same as SK-600 with encapsulated bypass capacitor.

\*\*Modified SK-600. Cutout machined in base shield.

†Same as SK-602 with encapsulated bypass capacitor.

‡SK-600 body with contacts and Kel-F retainer ring furnished separately; no bypass capacitor.

SK-607	<u>4CX600J</u> 8809	2700	1000	screen	none	SK-646
	<u>4CX600JA</u> 8921					SK-656
SK-610	same as SK-600	2700	400	screen	cathode	see SK-600 listing
SK-610A*			1000			

\*Same as SK-610 with encapsulated bypass capacitor.



## SOCKETS AND CHIMNEYS

Air-System Socket	Tube	Bypass Capacitor			Grounded Contacts	Chimney
		PF	Voltage DCWV	Element Bypassed		
SK-612	same as SK-600	2700	400	screen	cathode, one heater	see SK-600 listing
SK-620 SK-620A*	same as SK-600	1100	1000	screen	none	SK-626 or SK-636B†

\*Same as SK-620 with encapsulated bypass capacitor.

†Chimney includes anode connector, clamp and socket hold-down provision.

SK-621	same as SK-600	525	500	cathode	screen	SK-626 or SK-636B†
--------	----------------	-----	-----	---------	--------	--------------------

†Chimney includes anode connector, clamp and socket hold-down provision.

SK-630 SK-630A*	same as SK-600	1100	1000	screen	cathode	SK-626 or SK-636B†
--------------------	----------------	------	------	--------	---------	--------------------

\*Same as SK-630 with encapsulated bypass capacitor.

†Chimney includes anode connector, clamp and socket hold-down provision.

SK-640	same as SK-600	—	—	—	none	see SK-600 listing
SK-650 SK-655*	same as SK-600	1100	1000	screen	none	SK-626

\*SK-650 is a lightweight, simplified socket. SK-655 is matching bypass capacitor. It can also be used with coaxial-based tubes in family (e.g., 4CPX250K).

SK-660* SK-660A*† SK-661‡	same as SK-600 plus: 4CS250R	—	—	—	none	none required for 4CS250R see SK-600 listing.
---------------------------------	------------------------------------	---	---	---	------	---

\*High alumina ceramic body for heat-sink application; with threaded inserts.

†Same as SK-660, threaded inserts deleted.

‡BeO body for heat-sink application.

SK-680*	4CW800B 4CW800F	6000	500	screen	none	none required
	4CX600B 4CX600F					none available

\*SK-680 is a screen bypass unit and fastens directly to tube.

SK-700	4CX125C 4CX125F	1100	400	screen	one heater	none required
	<u>4CX300A</u> 8167					SK-606
	<u>4CX300Y</u> 8561					

## SOCKETS AND CHIMNEYS

Air-System Socket	Tube	Bypass Capacitor			Grounded Contacts	Chimney
		PF	Voltage DCWV	Element Bypassed		
SK-710 SK-711A*	same as SK-700	1100	400	screen	cathode one heater	SK-606
SK-712A*					one heater	

\*Same as SK-710 with encapsulated bypass capacitor.

SK-740	same as SK-700 plus: 4CN15A	—	—	—	none	none available
SK-760 SK-761*	same as SK-700 plus: 4CN15A	—	—	—	none	integral
SK-770					screen	

\*SK-761 is a low capacitance version of the SK-760

SK-800B	4CV1500B	1500	400	screen	none	none required
	4CX1000A 8168					SK-806
SK-810B SK-890B*	4CX1500B 8660				cathode one heater	
	4CW2000A 8244				none required	

\*Same as SK-800B with screen bypass capacitor isolated from screen contacts.

SK-820	<u>4CX1000K</u> 8352	500	400	cathode	screen	SK-806
SK-830A	<u>4CX1000K</u> 8352	2500	1000	screen	cathode	SK-806
SK-831	4CX1500A	2500	1000	screen	none	SK-806
	<u>4CX1000K</u> 8352					
SK-840	5CX1500A	2500	1000	screen	suppressor	SK-806
SK-860	<u>3CX1000A7</u> 8283	—	—	—	none	SK-816
SK-861	3CV1500A7	—	—	—	none	none required
SK-870	<u>3CX1000A7</u> 8283	—	—	—	grid	SK-816
SK-871	3CV1500A7	—	—	—	grid	none required

## SOCKETS AND CHIMNEYS

Air-System Socket	Tube	Bypass Capacitor			Grounded Contacts	Chimney
		PF	Voltage DCWV	Element Bypassed		
SK-900	4X500A	650	700	screen	none	SK-906
SK-1300	3CW10,000A3 3CW20,000A1 3CW20,000A3 3CW20,000A7	—	—	—	none	none required
	3CX5000A3					Y-463
	<u>3CX10,000A1</u> 8158					SK-1306
	<u>3CX10,000A3</u> 8159					
	<u>3CX10,000A7</u> 8160					
3CX15,000A3 3CX15,000A7	none available					
3CX20,000A3 3CX20,000A7						
SK-1310	3CV30,000A1 3CV30,000A3	—	—	—	—	none required
SK-1320	3CX5000A3	—	—	—	grid	Y-463
	same as SK-1300					see SK-1300 listing
SK-1400A	<u>4CX3000A</u> 8169	1800	1000	screen	none	SK-1406
SK-1420	5CX3000A	1800	1000	screen	suppressor	SK-1426
SK-1470A	<u>4CX3000A</u> 8169	—	—	—	screen	SK-1406
SK-1490	4CV8000A	—	—	—	—	none required
SK-1500* SK-1510†	<u>4CX35,000C</u> 8349	—	—	—	—	none available
	4CV100,000C 4CW100,000D					none required

\*Special assembly for stem cooling and mounting flanges. Bypass capacitors available.  
 †Modified SK-1500. Tube seating device added.

SK-1710 SK-1712	4CV250,000A 4CW250,000A	Filament Connector (2 required) Control Grid Connector	—	—
--------------------	----------------------------	---	---	---

# SOCKETS AND CHIMNEYS

Air-System Socket	Tube	Bypass Capacitor			Grounded Contacts	Chimney
		PF	Voltage DCWV	Element Bypassed		
SK-1920	8873 8560A 8560AS	Anode BeO Thermal Link			—	—
SK-2000*	4CV50,000E 4CV50,000J 4CW50,000E 4CW50,000J 4CW100,000E	7200	4000	screen	filament	none required

\* Recommended for video or pulse regulator applications.

SK-2001*	same as SK-2000	7200	4000	screen	none	none required
SK-2011†	same as SK-2000	11,000	4000	screen	none	none required
SK-2200	<u>3CX1500A7</u> 8877	—	—	—	none	SK-2216
SK-2210	<u>3CX1500A7</u> 8877	—	—	—	grid	SK-2216
SK-2220	8938‡	—	—	—	grid	SK-2216

\* Recommended for video or pulse regulator applications.

‡ Note: Collets are available separately; see collet listing.

† Preferred for radio frequency applications

## TUBE COLLETS

For 3CW5000A1, 3CW5000A3, 3CX2500A3 and 3CX3000A7

Terminal	EIMAC Part Number
Filament (inner)	149575
Filament (outer)	149576

For 3CX400U7

Terminal	EIMAC Part Number
Heater (inner)	008290
Heater (outer)	008291
Cathode	008292
Grid	882931
Anode	154418

For 4X150G, 4CX250K, 4CX250M, 4CPX250K

Terminal	EIMAC Part Number
Heater	008290
Cathode	008291
Grid	008292
Screen	882931
Anode	008294

For 8873, 8874, 8875

Terminal	EIMAC Part Number
Grid	882931
Anode (8874 only)	008294

For 8877/3CX1500A7

Terminal	EIMAC Part Number
Grid	135305
Anode	135304

For 8938, 8962

Terminal	EIMAC Part Number
Heater (inner)	135310
Heater (outer)	135307
Cathode	135306
Grid	135305
Anode	135304

For 8963

Terminal	EIMAC Part Number
Heater (inner)	154373
Heater (outer)	154374
Grid	154375
Anode	154376

For X-2159, X-2170, X-2176, X-2177

Terminal	EIMAC Part Number
Filament power and water connector	SK-2310
X-2159 (3 required)	
X-2170 (2 required)	
X-2176 (3 required)	
X-2177 (2 required)	
Filament RF Connector	SK-2315
X-2159 (1 required)	
X-2170 (1 required)	
X-2176 (1 required)	
X-2177 (1 required)	
Anode Water Connector	SK-2320
X-2159 (2 required)	
X-2170 (2 required)	
Alternate Anode Water Connector	SK-2321
X-2159 (2 required)	
X-2170 (2 required)	

# HEAT DISSIPATING CONNECTORS

EIMAC HR Heat-Dissipating Connectors are used to make electrical connections to the plate and grid terminals of EIMAC Tubes, and at the same time, provide efficient heat transfer from the tube element and glass seal to the air. These connectors are machined from solid dural rod and are supplied with the necessary set screws. For marking per MIL-STD-130B add prefix letter "M" to the part number for connectors HR-4 through HR-10. Note HR-1 through HR-3 are too small to permit marking.

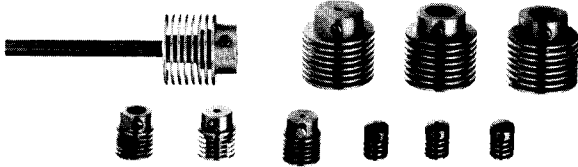

TYPE	Height	Dia.	Hole Dia.
HR-1	11/16"	1/2"	.052"
HR-2	11/16"	1/2"	.062"
HR-3	11/16"	1/2"	.072"
HR-4	7/8"	3/4"	.102"
HR-5	7/8"	3/4"	.127"
HR-6	7/8"	3/4"	.367"
HR-7	1-11/32"	1-3/8"	.127"
HR-8	1-11/32"	1-3/8"	.575"
HR-9	4-11/32"	1-3/8"	.569"
HR-10	1-11/32"	1-3/8"	.510"

## RECOMMENDED CONNECTORS FOR USE WITH EACH EIMAC TUBE TYPE

Tube	Plate Connector	Grid Connector
2-25A	HR-1	—
2-50A	HR-3	—
2-150D	HR-6	—
2-2000A	HR-8	—
3C24	HR-1	HR-1
3-500Z	HR-6	—
3-1000Z/8164	HR-8	—
4-65A	HR-6	—
4-125A/4D21	HR-6	—
4-250A/5D22	HR-6	—
4-400A/8438	HR-6	—
4-400B/7527	HR-6	—
4-400C	HR-6	—
4PR60C/8252W	HR-8	—
4PR65A/8187	HR-6	—
4PR125A/8247	HR-6	—
4PR250C/8248	HR-6	—
4PR1000A/8189	HR-8	—
4-500A	HR-6	—
4-1000A/8189	HR-8	—
5-500A	HR-6	—
6C21	HR-8	HR-8
25T	HR-1	—
35T	HR-3	—
75TH-TL	HR-3	HR-2
100TH-TL	HR-6	HR-2
152TH-TL	HR-5	HR-6
175A	HR-6	—
177WA	HR-6	—
250R	HR-6	—
250TH-TL	HR-6	HR-3
253	HR-8	—
254W	HR-3	HR-3
279	HR-6	—
284	HR-6	—

Tube	Plate Connector	Grid Connector
304TH-TL	HR-7	HR-6
450TH-TL	HR-8	HR-8
592/3-200A3	HR-10	HR-5
750TL	HR-8	HR-8
1000T	HR-9	HR-9
1500T	HR-8	HR-8
2000T	HR-8	HR-8
5867A	HR-6	—
6155	HR-6	—
6156	HR-6	—
6559	HR-6	—
6580	HR-6	—
6775	HR-6	—
7527	HR-6	—
8960	HR-6	—

## TUBE PULLERS

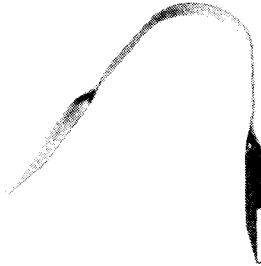

SK-604

This tube puller is designed for use in removing coaxial-base and 9-pin-base tubes from their sockets without damage. The 4X150 series and 4CX250 series tubes may be removed with this puller. SK-604A has a bonderize finish, SK-604B is nickel-plated.

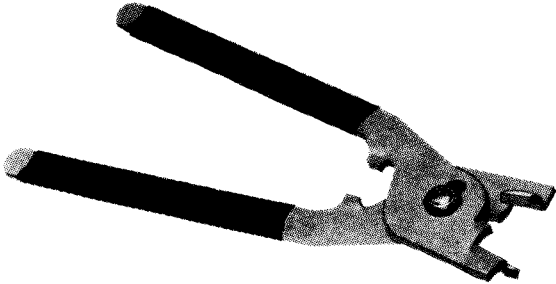

SK-605

These special pliers are designed for use in removing breechblock base tubes from their sockets without damage. The 4CX300 series and 4CX1000 series tubes may be removed with these pliers.

## VACUUM SWITCHES

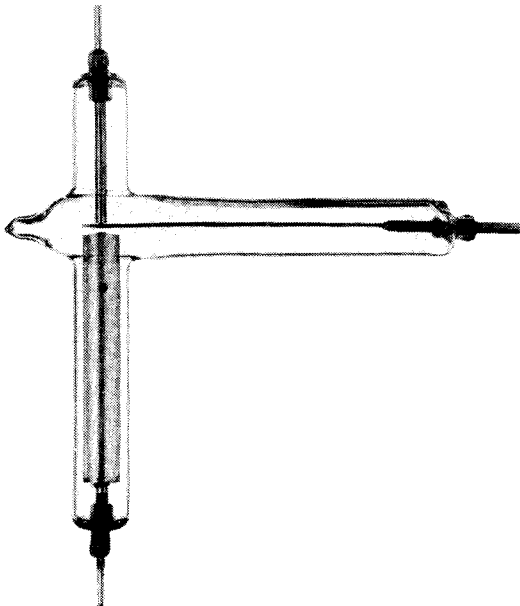

EIMAC Vacuum Switches are designed for pulse service or RF switching. For details inquire EIMAC, Division of Varian.

Type	Intended Service	Insulation	Current	Peak Test Voltage	DC Coil
VS-2	RF	Glass	5a (30 MHz)	20 KV	12 V 24 V
VS-4	RF	Glass	5a (30 MHz)	20 KV	12 V 24 V
VS-6	Pulse	Glass	150a (Pulse)	22 KV	12 V 24 V

12- or 24- volt coils available on order

## PREFORMED CONTACT FINGER STOCK

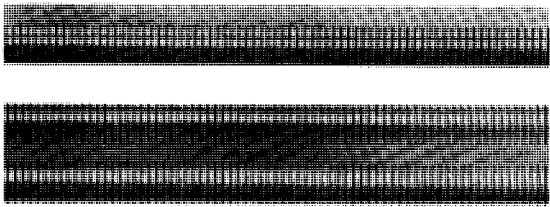

EIMAC Preformed Finger Stock is a prepared strip of spring material slotted and formed into a series of fingers designed to make a sliding contact. It is especially suitable for making connections to tubes with coaxial terminals or to moving parts, such as long-line and cavity circuits or screen-room doors. EIMAC finger stock is available in 9 different shapes and sizes, three of which incorporate "spooned" contact fingers. All sizes come in standard 36 inch lengths. Standard stock is heat treated and silver plated. EIMAC Contact Finger Stock is available on special factory order in the following semi-finished states: Slotted and formed (Not heat treated or plated), Slotted, formed, and heat treated (Not plated) Slotted, formed, and plated (Not heat treated).

Type	Finger Radius (inches)	Finger Width (inches)	Slot Width (inches)	Slot Depth (inches)	Comments
CF-100	1/16	1/8	0.040	9/32	spooned
CF-200	1/16	1/8	0.040	9/32	double-edged
CF-300	13/64	1/8	0.040	19/32	finger tip has reverse radius
CF-400	13/64	1/8	0.040	35/64	double-edged
CF-500	16/32	1/8	0.040	7/8	finger tip has reverse radius
CF-600	15/32	1/8	0.040	29/32	double-edged with reverse tip radii
CF-700	1/16	1/8	0.040	9/32	spooned
CF-800	1/16	1/8	0.040	15/32	spooned and bent
CF-900	0.030	1/16	0.020	15/64	smallest fingers

# VARIAN/EIMAC SALES OFFICE LOCATIONS

## U.S. SALES OFFICES

### Atlanta

6650 Powers Ferry Rd., N.W.  
Suite 100  
Atlanta, Georgia 30339  
TEL: (404) 252-0045

### Clearwater Branch

314 South Missouri  
Suite 205  
Clearwater, Florida 33516  
TEL: (813) 446-8513

### Boston

400 Totten Pond Road  
Bldg. #1  
Waltham, Massachusetts 02154  
TEL: (617) 890-4560

### Chicago

Executive Plaza Office Building  
205 W. Touhy Avenue  
Park Ridge, Illinois 60068  
TEL: (312) 825-6686

### Dallas

Richardson Savings & Loan Bldg.  
P.O. Box 689  
558 S. Central Expressway  
Suite 202  
Richardson, Texas 75080  
TEL: (214) 235-2385

### Dayton

Southmoor Building  
10 Southmoor Circle  
Dayton, Ohio 45429  
TEL: (513) 298-7318

### Los Angeles

2901 Wilshire Blvd.,  
Suite 102  
Santa Monica, Calif. 90403  
TEL: (213) 828-5588

### New York (Metropolitan)

25 Route 22  
Springfield, New Jersey 07081  
TEL: (201) 376-6600

### Philadelphia

306 Fellowship Road  
Mount Laurel, New Jersey  
08057  
TEL: (609) 235-6800

### Phoenix

7117 Third Avenue,  
Suite 106  
Scottsdale, Arizona 85251  
TEL: (602) 947-5461

### San Francisco

4940 El Camino Real  
Los Altos, California 94022  
TEL: (415) 968-7630

### Syracuse

115 Twin Oaks Drive  
Syracuse, New York 13206  
TEL: (315) 437-2568

### Washington, D.C.

4701 Lydell Drive  
Cheverly, Maryland 20781  
TEL: (301) 773-7010

## INTERNATIONAL SALES OFFICES

### Australia

Varian Pty. Ltd.  
P.O. Box 304,  
Crows Nest, N.S.W.  
2065 Australia  
TEL: 411-1277  
  
Varian Pty. Ltd.  
679 Springvale Road  
North Springvale, VICT. 3171  
Australia  
TEL: 560-7133

### Benelux

Varian Benelux N.V.  
Maassluisstraat 100  
P.O. Box 9158  
Amsterdam, Holland  
TEL: (020) 15 94 10

### Brazil

Varian Indústria e Comércio LTDA.  
Avenida DR Cardoso De Melo, 1644  
CEP 04548 Sao Paulo, SP  
TEL: 240-2379, 240-3449,  
241-1537, 61-9344

### Canada

Varian Associates of Canada Ltd.  
45 River Drive  
Georgetown, Ontario, Canada  
TEL: (416) 457-4130

### France

Varian S.A.  
Quartier de Courtaboeuf  
Boite Postale No. 12  
91401 Orsay  
France  
TEL: 907.78.26

### Germany

Varian GmbH  
Allacher Strasse 230E  
D-8 München 50  
Tel: (089) 81 26 093  
Twx: 522523

### Italy

Varian SpA  
Via Fratelli Varian  
1-10040 Leini (Torino)  
Italy  
TEL: (011) 26 80 86

### Japan

Marubun Corporation  
1-1, Nihombashi  
Odemmacho 2-Chome  
Chuo-Ku, Tokyo, 103 Japan  
TEL: (03) 662-8151

### Scandinavia

Varian AB  
Skytteholmsvagen 7D  
P.O. Box 1099  
S-171 22 Solna 1, Sweden  
TEL: (08) 82 00 30

### Switzerland

Varian A.G.  
Grienbachstrasse 17  
Postfach  
6300 Zug, Switzerland  
TEL: (042) 31 66 55

### United Kingdom and Ireland

EMI-Varian Ltd.  
Blyth Road  
Hayes  
Middlesex  
England  
TEL: 01-573-5555