



# **FIVE-STAR TUBES**

## **HIGH-RELIABILITY RECEIVING TYPES**

**for**

**ANY CRITICAL APPLICATION**

---

**Essential Characteristics of entire  
line included in convenient chart form**

---





**Vital Military Communications**



**Radar Installations for Defense**

G-E Five-Star tubes are specially designed, manufactured and tested; they are not "selected" tubes.

The Five-Star high-reliability line includes tubes capable of performing virtually every electronic function required of receiving types in critical applications where operational dependability of tubes is essential to protect life, customer's investment or product reputation.



**Remote Control—Unattended Stations**



**Navigation, Control and Communications**



**Video, Audio, Transmission Control**



**Two-way Emergency Communications**

# G-E FIVE-STAR TUBES

## ORIGIN OF THE RELIABLE TUBE PROGRAM

The concept of the reliable tube program was formulated about five years ago when the domestic airlines decided that standard or commercial receiving tubes were unsuitable for airline communication and navigation applications since the safety of passengers and aircraft was involved. They decided, through their non-profit radio co-ordination group, Aeronautical Radio, Incorporated, to try to interest tube manufacturers in the design of a new line of high-reliability tubes for airline applications. The airlines believed that the additional initial cost of such tubes would be outweighed by significant reductions in expenses resulting from excessive downtime and regular maintenance.

The General Electric Company's response to this challenge in designing and producing the initial line of tubes has been well documented in the various meetings of the IRE and Government symposiums as far back as the Conference on Reliable Components held in Washington, D. C. in May 1950. Briefly, this involved a new philosophy of assembly and test. It incorporated, among numerous minor improvements, the following:

1. redesign for higher heater current on critical types to reduce burn-out
2. use of gold-plated grids for reduced grid emission
3. redesign to withstand shock and vibration
4. setting up of separate factory area for assembly

5. establishment of special pay rates for operators, with no piece-work premium, to encourage careful work
6. use of thyatron welding for critical welds
7. inspection of parts and assemblies by binocular microscope
8. addition of heater cycling test on daily sample
9. fifty-hour aging on all tubes before final test
10. specification of tighter life test end-points and ratings

The principal goal was to eliminate or severely reduce the number of inoperatives and unpredictable types of failure, which cause most of the equipment trouble in spite of the best maintenance procedures. There is ample evidence from the airlines, as well as from many classes of industrial consumers, that significant reductions have been effected in this type of failure—in some cases from 60% per 1000 hours down to less than 2% per 1000 hours.

## TRANSITION TO MILITARY

The objectives of the original ARInc program were directly in line with those of the various military agencies which are continually at work to improve the reliability of electronic components. Therefore, JAN specifications were requested on these high-reliability



The incidence of internal shorts is reduced to an absolute minimum by grid-dimension tests and 100-percent binocular-microscope inspections on every G-E Five-Star tube.

types to enable their purchase by Government procedures. Up until that time, the program had been dynamic to the extent that improvements and changes in procedures and testing were incorporated as they evolved, with a constant selling price set at a relatively high figure to cover all additional expenses. It was feared that fixed Government specifications and competitive bidding would reverse the trend of "sparing no expense", and limit the improvements which could be made by limiting the amount which could be "plowed back" in the form of further tube refinements.

At the same time, the tremendous quantity requirements of the Armed Services dictated such an expansion of facilities that further refinements had to be foregone temporarily while production levels were drastically increased to meet the demand. During this period, JAN specifications on the original eleven high-reliability types were written, incorporating as many of the basic principles as could be reduced to numbers. These included the heater-cycling test, the grid-emission test, the fifty-hour aging requirement (now reduced to forty-six), and the stringent life-test ratings.

#### **DEVELOPMENT PROGRAM RESUMED**

As production began to level off, the dynamic nature

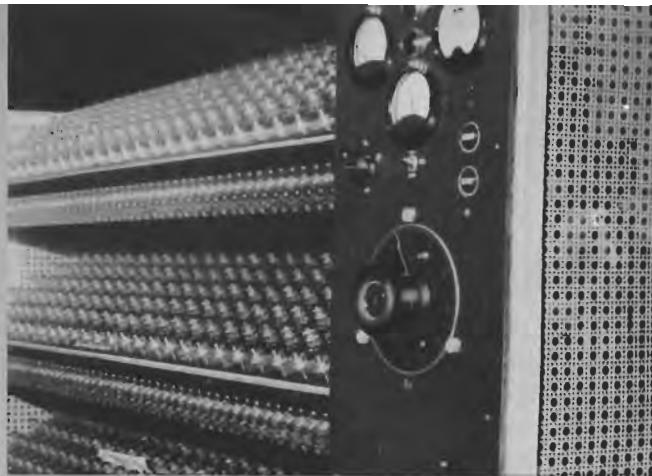

**All G-E Five-Star tubes are operated under class A conditions for a 46-hour burn-in period on the special racks shown above. This stabilizes electrical characteristics and helps minimize early-life failures.**

of the program was resumed. Further refinements in processing and testing procedures allowed further tightening of test limits. In phase with the efforts of various military committees to standardize sample testing procedures, the JAN specifications were revised to incorporate tightened levels of AQL (Average Quality Level) percentages of various defect items in the outgoing product. Also, life test survival ratings were tightened from 90% to 95% minimum at 500 hours, and a 1000-hour test was added. Moreover, a new concept, Inoperative Control, was introduced, in-



**To meet requirements of the Armed Services for high-reliability tubes, General Electric enlarged its factories such as this one in Owensboro, Kentucky. By the middle of 1952, production of G-E Five-Star tubes was increased 5 to 1 over 1951.**

volving a tight limit on the number of inoperatives which can occur during the fifty-hour stabilizing period. As originally specified, the number of inoperatives which could occur during this period was limited to 3%, and any quantity in excess of this figure would require re-stabilization and re-test with limits tightened by 1/2% for each re-stabilization period. The total number of retests was limited to three periods. This may not sound severe, but when it is realized that the specification defines an inoperative as including temporary shorts (a flicker of the short test indicator which occurs only once during the tapping of the tube envelope), it will be recognized as a strict test. This is borne out by subsequent life testing which shows an average failure rate of about 0.6% per 100 hours after these potential failures have been eliminated by the burn-in and testing procedure. This requirement, combined with a "Normal-Stricter" test requiring a 96% minimum survival rate in case of a previous lot failure, guarantees remarkably low rates of early life inoperative defectives in the product.

### OTHER MILITARY SPECIFICATIONS

As improvements were made in manufacturing and quality levels, the specifications were tightened correspondingly. This was accomplished without severely penalizing production levels or creating a waste of strategic materials by requiring inordinately tight limits and the resultant scrapping of all but a small percentage of selected tubes. Concurrent with the G-E program for developing specifications to describe special quality tubes, the efforts of several agencies and other tube manufacturers were directed to the general problem of high-reliability tube specifications.

No attempt is made here to evaluate the relative success of these various efforts since in the end this will be self-evident from the quantities which can be produced and the resulting prices. However, they can be listed in chronological order as follows:

<b>6AK5W</b>	<b>(World War II—Ruggedized)</b>
<b>5654</b>	<b>(ARInc-Navy-GE)</b>
<b>6AK5WA</b>	<b>(Panel on Electron Tubes)</b>
<b>6096CT</b>	<b>(Wright Field "Controlled Test", with many waivers of various test limits)</b>
<b>5654/6AK5W</b>	<b>(MIL-E-1B, latest G-E)</b>

**5840** (Sylvania—Subminiature)  
**5654/6AK5W/6096** (USAF "Military Control Spec.")

The two last named specifications are quite recent and are still being evaluated as to their effect on the quality of the end product, its manufacturability, and price. In other words, the high-reliability program continues to be dynamic.

### NEW HIGH-RELIABILITY TYPES

During the period of expansion of production, other types were developed and introduced, to complete the list of functions as follows:

<b>RETMA No.</b>	<b>Prototype</b>	<b>Military</b>
<b>6072</b>	<b>12AY7</b>	<b>6072</b>
<b>6087</b>	<b>5Y3GT</b>	<b>5Y3GTWB</b>
<b>6134</b>	<b>6AC7</b>	<b>6AC7WA</b>
<b>6135</b>	<b>6C4</b>	<b>6135</b>
<b>6136</b>	<b>6AU6</b>	<b>6AU6WA</b>
<b>6137</b>	<b>6SK7</b>	<b>6SK7WA</b>
<b>6201</b>	<b>12AT7</b>	<b>12AT7WA</b>
<b>6202</b>	<b>6X4 (50ma)</b>	<b>6X4WA</b>
<b>6203</b>	<b>9-pin 6X4</b>	<b>6203</b>

In addition, one other type has been recently announced. This is type 6386, a remote cut-off high-gain R-F amplifier. Tests indicate remarkably good R-F characteristics from the standpoint of low noise, high gain, and most important of all, freedom from cross-modulation, achieved by the essentially square-law transfer function. This type will meet the latest cross-modulation specifications planned by ARInc for airline duplex communication, involving extremely strong adjacent channel signal levels from associated transmitters.

Further extensions of the original work on reliability are going on in connection with development of super-reliable tubes for guided missile and government computer applications. However, production of these is relatively far in the future, and they may never be available in large quantities because of their stringent test limits and consequent high cost.

Another phase of this work worthy of note is the elaborate testing program being undertaken under a

Government contract to determine realistic values for various basic ratings based on life testing under various conditions. Selected levels of heater voltage, plate current, plate dissipation, peak pulse current, duty cycle, and ambient temperature on a number of basic types from several manufacturers should provide a wealth of data on which to base future tube ratings. This is the first large-scale attempt to gather the enormous volume of data necessary to relate ratings and failure rates, and to furnish a mathematical evaluation of what, for instance, a maximum plate dissipation means in terms of probability of survival. Complete results will not be available for some time, and when they are available, they will be only in the form of a final report on the contract. It is expected, however, that the data will be used to evaluate and interpret all military tube specifications in terms of this new factor—survival probability.

## QUALITY CONTROL

With reference to quality control procedures, the original ARInc treatment, plus subsequent improvements, involves the following:

### 1. Incoming Inspection

This calls for a rigid sampling procedure on all purchased parts and materials.

### 2. In-process Quality Control

In addition to visual inspection at various points of assembly, grids are controlled for dimensional tolerances by an hourly check on each machine, with the results recorded on a control chart. Cathode coating weight is checked on a regular sampling basis, and stems and bulbs are checked for strain by a polariscope. Finished tubes are subjected to a hot water test with the pins expanded 5 degrees on a metal cone to detect base and bulb strain, a sample being taken from every exhaust machine on a regular schedule each day.

All welds are examined and a certain percentage of heaters are checked for brittleness by straightening the bends of the finished folded heater.

### 3. Median Control

A system originally instituted on ARInc types, the median control procedure specifies character-



**Heater failures due to excessive intermittent operation are virtually eliminated in G-E Five-Star tubes by the use of heavier heater wire and careful control of coating process. The bends in Five-Star heater wire are specially coated a second time with the help of an electrical charge that deposits material wherever the coating may have cracked off during formation of the heater.**

istic limits between high and low customer end limits and bogey between which the median of the 20-tube sample must fall, or the lot is rejected. The limits are set to take into account the normal day-to-day variations plus the sampling error, but the end result is a product that centers around bogey, with a relatively small percentage out near the customer limits. This is extremely important to the equipment designer, since he can rely on the average of five tubes in an IF strip falling near bogey, for instance, rather than piling up at the high or low customer limit. The latter,

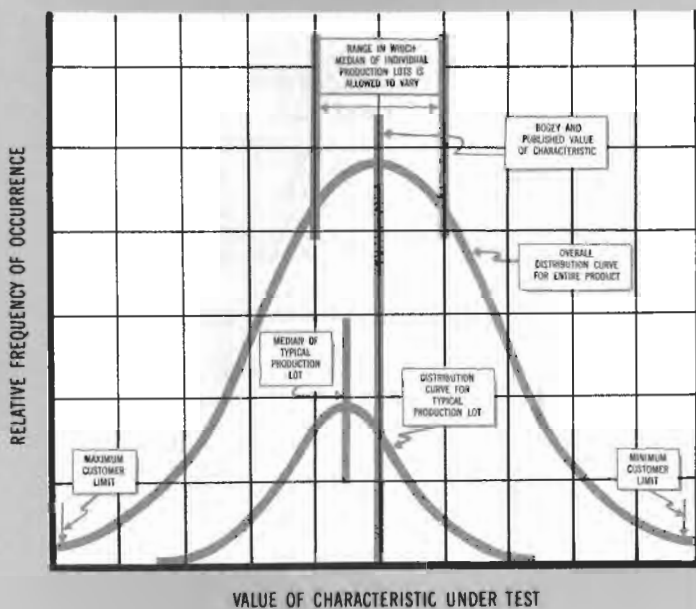

This chart illustrates how G.E. exercises median control over Five-Star tube quality. If the median of a sample lot falls outside the range in which the average of individual production lots is allowed to vary on any specified characteristic, the entire lot is rejected.

of course, could and did happen quite legally under the old JAN specifications and produced wide variations in performance.

#### 4. Inoperative Control

The system of setting a limit on the number of inoperatives which can occur during the stabilizing period has been found to correlate remarkably well with life test survival ratings, and at the same time, acts as an excellent indicator of factory quality. Inoperatives in excess of 3% in 50 hours signals for intense activity by

all factory personnel involved to correct the difficulty. It should be pointed out that the inoperative control concept is not a sampling plan whereby the level of inoperatives in the product is merely noted. Rather, by operating all the tubes under life test or equivalent conditions, the tubes which become inoperative are actually removed from the product.

#### 5. Life Tests

As previously noted, life test survival ratings are very stringent, and over a month's production, result in an average rating of 97.5% or better, compared with the old JAN specification of 80%. This represents the sum of the actual hours of operation divided by the total possible hours. For example, with a 20-tube sample for 500 hours, total possible hours are 10,000. With a rating of 96%, all tubes must go to 480 hours before failure, or one tube could fail at 100 hours if all the rest go the full 500. Note that *no* tube can fail in the first 100 hours, or the lot is rejected.

### G.E. AND THE FUTURE OF THE HIGH-RELIABILITY PROGRAM

The Five-Star high-reliability program continues to make impressive records in airlines and military applications, wherever statistical results have become available. It is the intention of General Electric to continue adding improvements in all steps of design, manufacture and test as techniques are improved and new designs introduced. Wherever it appears that another step can be taken to improve the product, it will be introduced as quickly as possible, even though the existing specifications may allow a looser limit. As an example, a program is under way to reduce the allowable inoperatives control limit to 2% instead of 3% during the first stabilization period. This will undoubtedly be reflected in a correspondingly lower incidence of inoperatives during subsequent operation and, consequently, improved survival on life test.

This is only one example of the continuing dynamic nature of this program, as long as improvements can come naturally as a result of continued effort in engineering and manufacturing, and not as a result of a synthetic "quality" coming from pure selection and tightened end limits. Quality can only be built in, not tested into a product.



Proto-type	Five-Star Type	Specific Differences Between Prototype & Five-Star Type	Applicable MIL-E-1B Specification	Functional Description
6AK5	GL-5654	None	5654/6AK5W 5654/6AK5W/6096	Sharp-cutoff R-F Pentode
2C51	GL-5670	Heater Current: 2C51—0.3 ampere GL-5670—0.35 ampere	5670	High-frequency Medium-mu Twin-triode
None	GL-5686	None	5686	Beam-power Amplifier
6AS6	GL-5725	None	5725/6AS6W	Dual-control Sharp-cutoff R-F Pentode
6AL5	GL-5726	None	5726/6AL5W	Twin-Diode
2D21	GL-5727	None	5727/2D21W	Thyratron
6BA6	GL-5749	None	5749/6BA6W	Remote-cutoff R-F Pentode
6BE6	GL-5750	None	5750/6BE6W	Pentagrid Converter
12AX7	GL-5751	Heater Current: 12AX7 — 0.150 amp. per sect.; GL-5751 — 0.175 amp. per sect.; Amplification Factor: 12AX7 — 100; GL-5751 — 70	5751 5751WA	High-mu Twin-triode
12AU7	GL-5814-A	Heater Current: 12AU7—0.150 amp. per sect. GL-5814-A—0.175 amp. per sect.	5814A 5814WA	Medium-mu Twin-triode
6AQ5	GL-6005	None	6005/6AQ5W 6005/6AQ5W/6095	Beam-power Amplifier
12AY7	GL-6072	Heater Current: 12AY7 — 0.150 amp. per sect. GL-6072 — 0.175 amp. per sect.	6072	Low-noise High-mu Twin-triode

## SYMBOLS

**E<sub>b</sub>** Plate Voltage in Volts  
**E<sub>c1</sub>** Grid Number 1 Voltage in Volts  
**E<sub>c2</sub>** Screen Voltage in Volts  
**E<sub>c3</sub>** Suppressor Voltage in Volts  
**G<sub>c</sub>** Conversion Transconductance in Micromhos

**g<sub>m</sub>** Transconductance in Micromhos  
**I<sub>b</sub>** Plate Current in Milliamperes  
**I<sub>c2</sub>** Screen Current in Milliamperes  
**P<sub>g</sub>** Grid Driving Power in Watts  
**P<sub>p</sub>** Plate Dissipation in Watts  
**P<sub>o</sub>** Maximum-signal Power Output in Watts

**R<sub>k</sub>** Cathode Bias Resistor in Ohms  
**R<sub>L</sub>** Load Resistor in Ohms  
**μ** Amplification Factor  
**†** Class A<sub>1</sub> Amplifier  
**‡** Class C R-F Amplifier  
 Footnote: **#** Maximum Ratings, Absolute Maximum

The ratings and characteristics of all twin-section types are given for each section. Complete interchangeability between a Five-Star tube and its prototype depends on individual applications.



# MINIATURES



Heater		Maximum Ratings Design Center			Average Characteristics	Five- Star Type
Volts	Amperes	E <sub>b</sub> Volts Dc	E <sub>c<sub>2</sub></sub> Volts Dc	P <sub>p</sub> Watts		
6.3	0.175	180	140	1.7	E <sub>b</sub> = 120; E <sub>c<sub>2</sub></sub> = 120; R <sub>k</sub> = 200; G <sub>m</sub> = 5000; I <sub>b</sub> = 7.5; I <sub>c<sub>2</sub></sub> = 2.5	GL-5654
6.3	0.35	300	—	1.5	E <sub>b</sub> = 150; R <sub>k</sub> = 240; G <sub>m</sub> = 5500; μ = 35; I <sub>b</sub> = 8.2	GL-5670
6.3	0.35	250	250	7.5	E <sub>b</sub> = 250; E <sub>c<sub>2</sub></sub> = 250; E <sub>c<sub>1</sub></sub> = -12.5; R <sub>i</sub> = 9000; P <sub>o</sub> = 2.7; I <sub>b</sub> = 27; I <sub>c<sub>2</sub></sub> = 5.0 † E <sub>b</sub> = 250; E <sub>c<sub>2</sub></sub> = 250; E <sub>c<sub>1</sub></sub> = -50; P <sub>g</sub> = 0.15; P <sub>o</sub> = 6.5 ‡	GL-5686
6.3	0.175	180	140	1.7	E <sub>b</sub> = 120; E <sub>c<sub>3</sub></sub> = 0; E <sub>c<sub>2</sub></sub> = 120; E <sub>c<sub>1</sub></sub> = -2; I <sub>b</sub> = 5.2; I <sub>c<sub>2</sub></sub> = 3.5; G <sub>m</sub> = 3200	GL-5725
6.3	0.30	Max. Peak Inverse Voltage = 330 Volts; Max. Peak Current = 54 ma.; Max. D-c Output Current = 9 ma.				GL-5726
6.3	0.60	#Max. Peak Inverse Voltage = 1300 Volts; Max. Peak Current = 0.5 amp.; Max. Average Current = 0.1 amp.				GL-5727
6.3	0.30	300	125	3.0	E <sub>b</sub> = 250; E <sub>c<sub>2</sub></sub> = 100; R <sub>k</sub> = 68; G <sub>m</sub> = 4400; I <sub>b</sub> = 11; I <sub>c<sub>2</sub></sub> = 4.2	GL-5749
6.3	0.30	300	100	1.0	E <sub>b</sub> = 250; G <sub>c</sub> = 475; I <sub>b</sub> = 2.6	GL-5750
6.3/12.6	0.350/0.175	300	—	1.0	E <sub>b</sub> = 250; E <sub>c<sub>1</sub></sub> = -3; G <sub>m</sub> = 1200; μ = 70; I <sub>b</sub> = 1.0	GL-5751
6.3/12.6	0.350/0.175	300	—	2.75	E <sub>b</sub> = 250; E <sub>c<sub>1</sub></sub> = -8.5; μ = 17; G <sub>m</sub> = 2200; I <sub>b</sub> = 10.5	GL-5814-A
6.3	0.45	250	250	12	E <sub>b</sub> = 250; E <sub>c<sub>1</sub></sub> = -12.5; E <sub>c<sub>2</sub></sub> = 250; R <sub>i</sub> = 5000; P <sub>o</sub> = 4.5; I <sub>b</sub> = 45; I <sub>c<sub>2</sub></sub> = 4.5	GL-6005
6.3/12.6	0.350/0.175	300	—	1.5	E <sub>b</sub> = 250; G <sub>m</sub> = 1750; E <sub>c<sub>1</sub></sub> = -4; I <sub>b</sub> = 3.0; μ = 44	GL-6072



GL-5654



GL-5670



GL-5686



GL-5725

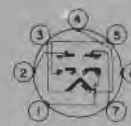

GL-5726



GL-5727



GL-5749



GL-5750



GL-5751



GL-5814-A



GL-6005



GL-6072



# G-E FIVE-STAR

Proto-type	Five-Star Type	Specific Differences Between Prototype & Five-Star Type	Applicable MIL-E-1B Specification	Functional Description
5Y3-GT	GL-6087 Glass	Cathode: 5Y3-GT—Coated filament; GL-6087—Coated unipotential Tube Voltage Drop at I <sub>b</sub> = 125 ma. per Plate: 5Y3-GT—60 volts; GL-6087—50 volts	In process	Full-wave Rectifier
6AC7	GL-6134 Metal	None	In process	Sharp-cutoff R-F Pentode
6C4	GL-6135	Heater Current: 6C4—0.150 ampere GL-6135—0.175 ampere	6135	Medium- $\mu$ Triode
6AU6	GL-6136	None	6AU6WA	Sharp-cutoff R-F Pentode
6SK7	GL-6137 Metal	None	6SK7WA	Remote-cutoff R-F Pentode
12AT7	GL-6201	None	12AT7WA	High-frequency High- $\mu$ Twin-triode
6X4	GL-6202	Max. Peak Current: 6X4—210 ma., GL-6202—200 ma.; Max. D-c output current: 6X4—70 ma., GL-6202—50 ma.; Tube Voltage Drop: 6X4—22 volts at 70 ma. per plate, GL-6202—22 volts at 50 ma. per plate.	In process	Full-wave Rectifier
None	GL-6203	None	In process	Full-wave Rectifier
6BH6	GL-6265	Heater Current: 6BH6—0.15 ampere GL-6265—0.175 ampere	In process	Sharp-cutoff R-F Pentode
GL-5670	GL-6386	Cutoff Characteristics: GL-5670—Sharp GL-6386—Remote	In process	High-frequency Medium- $\mu$ Twin-triode

## SYMBOLS

**E<sub>b</sub>** Plate Voltage in Volts  
**E<sub>c1</sub>** Grid Number 1 Voltage in Volts  
**E<sub>c2</sub>** Screen Voltage in Volts  
**E<sub>c3</sub>** Suppressor Voltage in Volts  
**G<sub>c</sub>** Conversion Transconductance in Micromhos

**G<sub>m</sub>** Transconductance in Micromhos  
**I<sub>b</sub>** Plate Current in Milliamperes  
**I<sub>c1</sub>** Screen Current in Milliamperes  
**P<sub>g</sub>** Grid Driving Power in Watts  
**P<sub>p</sub>** Plate Dissipation in Watts

**P<sub>o</sub>** Maximum-signal Power Output in Watts  
**R<sub>k</sub>** Cathode Bias Resistor in Ohms  
**R<sub>l</sub>** Load Resistor in Ohms  
 **$\mu$**  Amplification Factor  
 Footnote: # Maximum Ratings, Absolute Maximum

The ratings and characteristics of all twin-section types are given for each section. Complete interchangeability between a Five-Star tube and its prototype depends on individual applications.

# MINIATURES ★ ★ ★ ★ ★

Heater		Maximum Ratings Design Center			Average Characteristics	Five- Star Type
Volts	Amperes	E <sub>b</sub> Volts D-c	E <sub>c2</sub> Volts D-c	P <sub>p</sub> Watts		
5.0	2.0	Max. Peak Inverse Voltage = 1400 Volts; Max. Peak Current = 375 ma.; Max. D-c Output Current = 125 ma. (Both Plates)				GL-6087 Glass
6.3	0.45	300	150	3.0	E <sub>b</sub> = 300; E <sub>c1</sub> = 0; E <sub>c2</sub> = 150; R <sub>k</sub> = 160; I <sub>b</sub> = 10; I <sub>c2</sub> = 2.5; G <sub>m</sub> = 9000	GL-6134 Metal
6.3	0.175	300	—	3.5	E <sub>b</sub> = 250; E <sub>c1</sub> = -8.5; I <sub>b</sub> = 10.5; $\mu$ = 17; G <sub>m</sub> = 2200	GL-6135
6.3	0.30	300	150	3.0	E <sub>b</sub> = 250; G <sub>m</sub> = 5200; E <sub>c2</sub> = 150; R <sub>k</sub> = 68; I <sub>b</sub> = 10.6; I <sub>c2</sub> = 4.3	GL-6136
6.3	0.30	300	125	3.0	E <sub>b</sub> = 250; G <sub>m</sub> = 2000; E <sub>c2</sub> = 100; E <sub>c1</sub> = -3; I <sub>b</sub> = 9.2; I <sub>c2</sub> = 2.6	GL-6137 Metal
6.3/12.6	0.300/0.150	300	—	2.5	E <sub>b</sub> = 250; G <sub>m</sub> = 5500; R <sub>k</sub> = 200; $\mu$ = 60; I <sub>b</sub> = 10	GL-6201
6.3	0.60	Max. Peak Inverse Voltage = 1250 Volts; Max. Peak Current = 200 ma.; Max. D-c Output Current = 50 ma. (Both Plates)				GL-6202
6.3	0.90	Max. Peak Inverse Voltage = 1250 Volts; Max. Peak Current = 270 ma.; Max. D-c Output Current = 70 ma. (Both Plates)				GL-6203
6.3	0.175	300	150	2.0	E <sub>b</sub> = 250; E <sub>c1</sub> = -1.0; E <sub>c2</sub> = 150; I <sub>b</sub> = 7.4; I <sub>c2</sub> = 2.9; G <sub>m</sub> = 4600	GL-6265
6.3	0.35	300	—	1.5	E <sub>b</sub> = 100; R <sub>k</sub> = 200; $\mu$ = 17; G <sub>m</sub> = 4000; I <sub>b</sub> = 9.6	GL-6386



GL-6087



GL-6134



GL-6135

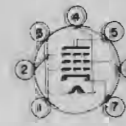

GL-6136

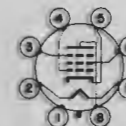

GL-6137



GL-6201

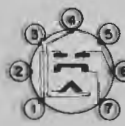

GL-6202



GL-6203

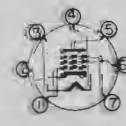

GL-6265



GL-6386

# G-E

## FIVE-STAR



## SUB-

## MINIATURES

Type	Functional Description
GL-5718	Medium-mu Triode
GL-5719	High-mu Triode
GL-5797	Semi-remote Cutoff R-F Pentode
GL-5798	Medium-mu Twin-triode
GL-5840	Sharp-cutoff R-F Pentode
GL-5896	Twin-diode
GL-5899	Semi-remote Cutoff R-F Pentode
GL-5902	Beam-power Amplifier
GL-6021	Medium-mu Twin-triode
GL-6111	Medium-mu Twin-triode
GL-6112	High-mu Twin-triode

### SYMBOLS

**E<sub>b</sub>** Plate Voltage in Volts  
**E<sub>c1</sub>** Grid Number 1 Voltage in Volts  
**E<sub>c</sub>** Screen Voltage in Volts  
**E<sub>s</sub>** Suppressor Voltage in Volts  
**G<sub>c</sub>** Conversion Transconductance in Micromhos

**G<sub>m</sub>** Transconductance in Micromhos  
**I<sub>b</sub>** Plate Current in Milliampères  
**I<sub>c</sub>** Screen Current in Milliampères  
**P<sub>g</sub>** Grid Driving Power in Watts  
**P<sub>p</sub>** Plate Dissipation in Watts

**P<sub>o</sub>** Maximum-signal Power Output in Watts  
**R<sub>k</sub>** Cathode Bias Resistor in Ohms  
**R<sub>L</sub>** Load Resistor in Ohms  
**μ** Amplification Factor  
Footnote: \*Maximum Ratings, Design Center

The ratings and characteristics of all twin-section types are given for each section. Complete interchangeability between a Five-Star tube and its prototype depends on individual applications.

Heater		Maximum Ratings Absolute Maximum			Average Characteristics	Type
Volts	Amperes	Eb Volts D-c	Ec <sub>2</sub> Volts D-c	Pp Watts		
6.3	0.15	165	—	3.3	Eb = 100; Rk = 150; Gm = 5800; $\mu$ = 27; lb = 8.5	GL-5718
6.3	0.15	165	—	0.55	Eb = 100; Rk = 1500; Gm = 1700; $\mu$ = 70; lb = 0.73	GL-5719
26.5	0.045	50*	50*	0.8*	Eb = 26.5; Ec <sub>2</sub> = 26.5; Ec <sub>1</sub> = 0; lb = 2.8; Ic <sub>2</sub> = 0.9; Gm = 3450	GL-5797
26.5	0.09	50*	—	0.2*	Eb = 26.5; Ec <sub>1</sub> = 0; lb = 2.0; Gm = 3400; $\mu$ = 24	GL-5798
6.3	0.15	165	155	1.1	Eb = 100; Ec <sub>2</sub> = 100; Rk = 150; lb = 7.5; Ic <sub>2</sub> = 2.4; Gm = 5000	GL-5840
6.3	0.30	Max. Peak Inverse Voltage = 460 Volts; Max. Peak Current = 60 ma.; Max. D-c Output Current = 10 ma.				GL-5896
6.3	0.15	165	155	1.1	Eb = 100; Ec <sub>2</sub> = 100; Rk = 120; lb = 7.2; Ic <sub>2</sub> = 2.0; Gm = 4500	GL-5899
6.3	0.45	165	155	4.0	Eb = 110; Ec <sub>2</sub> = 110; Rk = 270; lb = 30; Ic <sub>2</sub> = 2.2; R <sub>i</sub> = 3000; Po = 1.0	GL-5902
6.3	0.30	165	—	1.1	Eb = 100; Rk = 150; $\mu$ = 35; Gm = 5400; lb = 6.5	GL-6021
6.3	0.30	165	—	1.1	Eb = 100; Rk = 220; $\mu$ = 20; Gm = 5000; lb = 8.5	GL-6111
6.3	0.30	165	—	0.55	Eb = 100; Rk = 1500; $\mu$ = 70; Gm = 1800; lb = 0.8	GL-6112



GL-5718



GL-5719

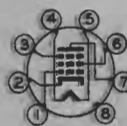

GL-5797

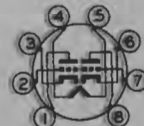

GL-5798

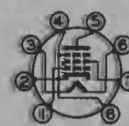

GL-5840



GL-5896



GL-5899



GL-5902

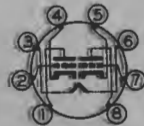

GL-6021

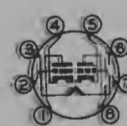

GL-6111

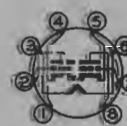

GL-6112

# G - E FIVE - STAR



## TUBE DESIGN



Cutaway of Five-Star type GL-5751, shown approximately three times actual size.

Basic to the General Electric concept of tube reliability is the belief that reliability can not be tested into tubes. The process of testing and special selection, moreover, not only fails to provide a uniform and dependable product, but it is impractical from an economic viewpoint, as well.

To build high reliability into tubes, G-E engineers included in their specifications a number of design features to minimize or overcome the known causes of tube failure.

These design features fall into two general categories; those which counter the effects of shock and vibration, and those which add to the electrical dependability of the tubes.

Of course, not all Five-Star types incorporate every one of these design features since the usual class of service for a given type may make it unnecessary. For instance, type GL-5670 is practically always associated with low-impedance circuits where leakage between elements is of negligible significance. Consequently, this type does not have the anti-leakage slots referred to on page 17.

To demonstrate how G-E Five-Star tubes differ structurally from standard types, micro-photographs of several typical sub-assemblies are shown on the following pages.

Not one, but two mica spacers at both top and bottom brace the internal structure of G-E Five-Star tubes. These extra micas enlarge the surface in contact with the glass envelope, making the tube more resistant to shock and vibration.

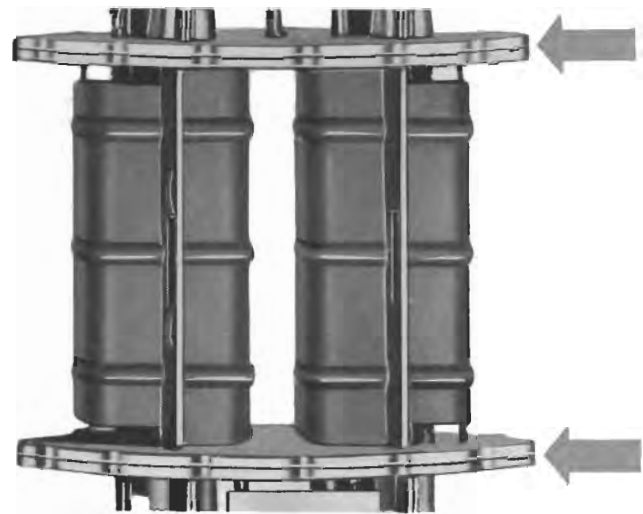

A getter flash shield improves initial leakage characteristics by helping to keep conductive deposits off the mica spacers in tubes where plate-grid leakage must be held to a minimum.

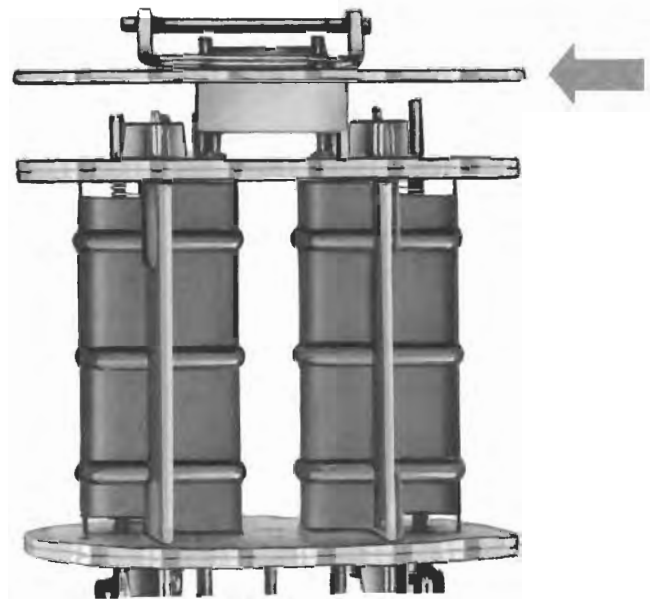

In Five-Star tubes, the bends in the heater wire are specially coated a second time with the help of an electrical charge that deposits insulating material wherever the coating may have cracked or flaked off during formation of the heater coil. This minimizes the danger of heater-cathode shorts, a common cause of tube failure. The photograph shows the heater wire, magnified about 30 times, before and after special insulating treatment.

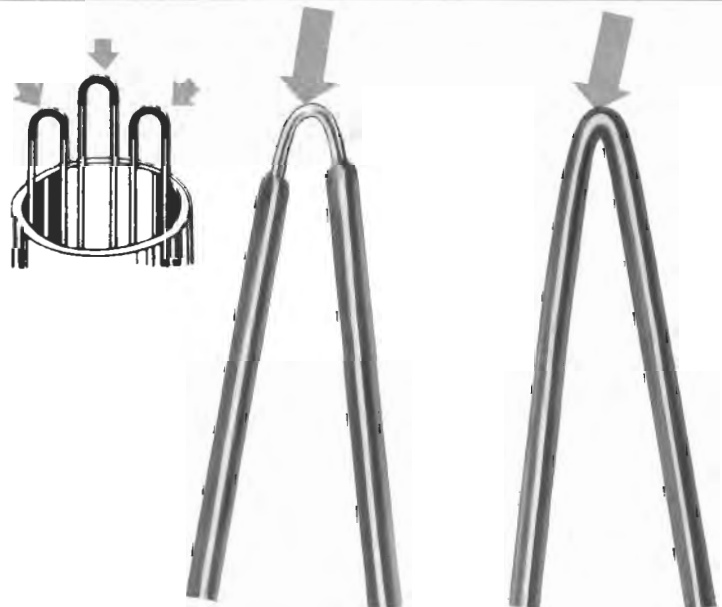

Five-Star tubes are characterized by shorter, sturdier cages. This reduction in mass increases the rigidity of the structure and results in a tube more resistant to shock and vibration. In addition, the larger diameter cathode resists bowing.

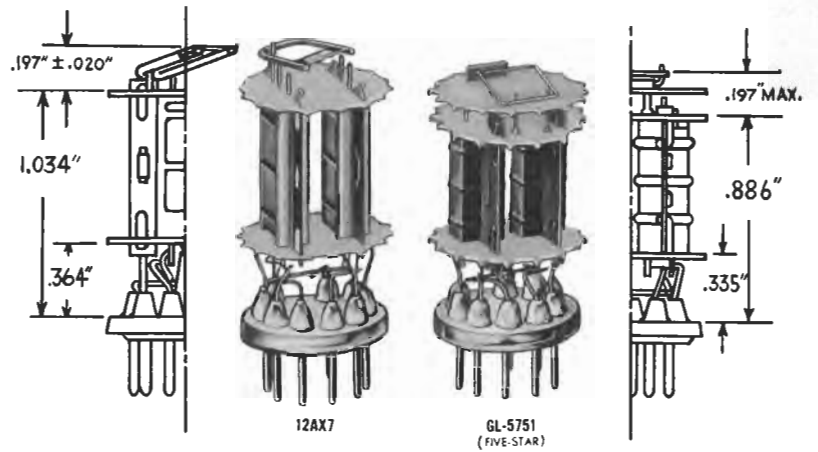

The critical grids of Five-Star tubes are plated with gold or silver. This minimizes grid emission during life.



Double-staking of getter to the mica gives stronger support against shock and vibration.

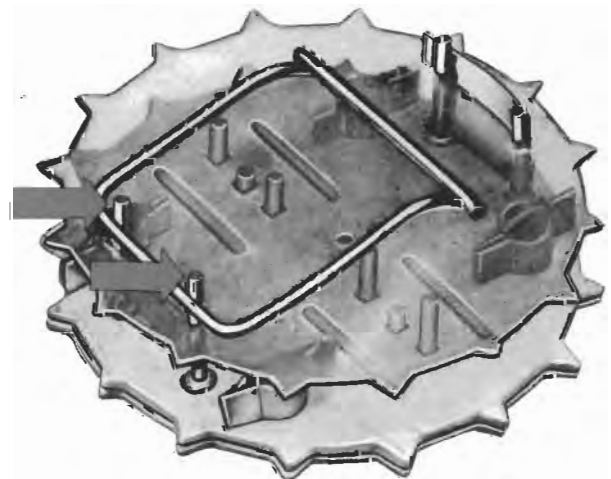



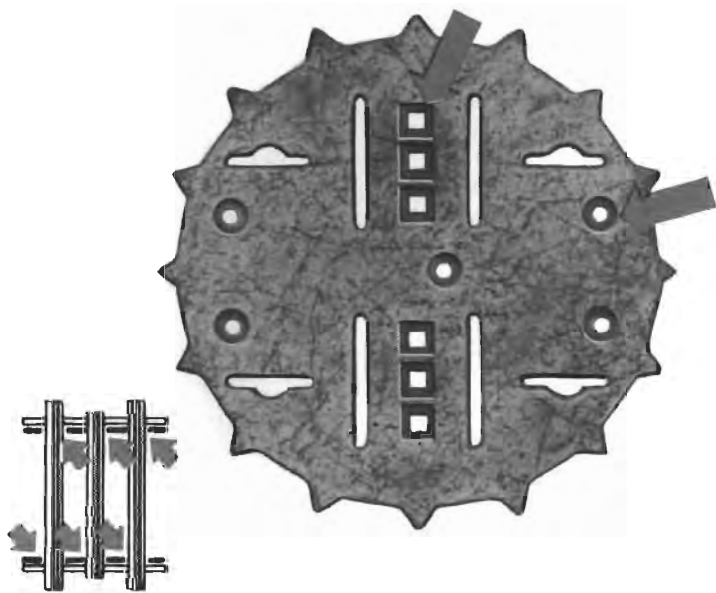

Clearance holes for rods and cathodes in inner mica interrupt leakage paths, reduce heat conduction. The photograph shows the inner mica, backed up by the outer mica. Note the larger clearance holes in the inner mica.

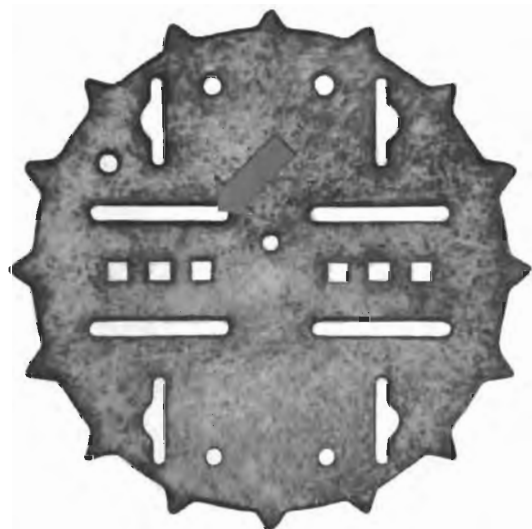

Additional anti-leakage slots in mica spacers in Five-Star tubes lengthen leakage paths between the plate and other elements.

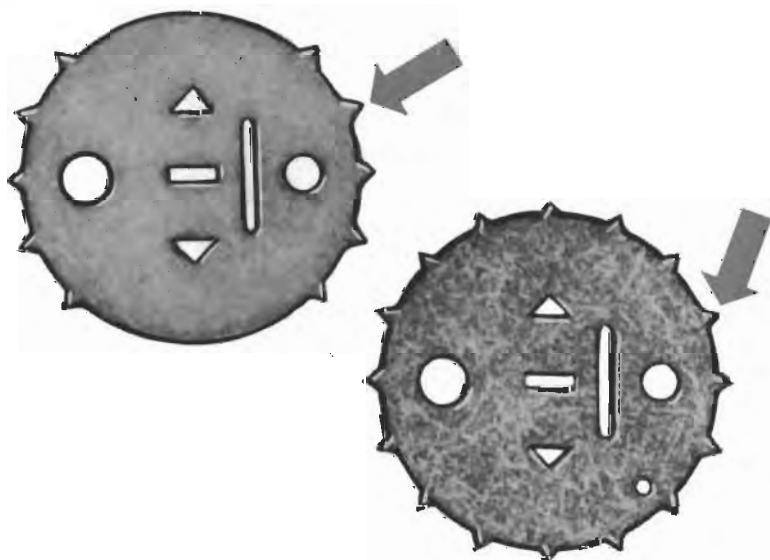

The photograph shows a mica spacer used in one type Five-Star tube (below) and the mica spacer used in the same tube's commercial prototype (above). Five-Star tubes are built with micas having more contact points to give a firmer fit between bulb and mount. This minimizes the effects of shock and vibration.

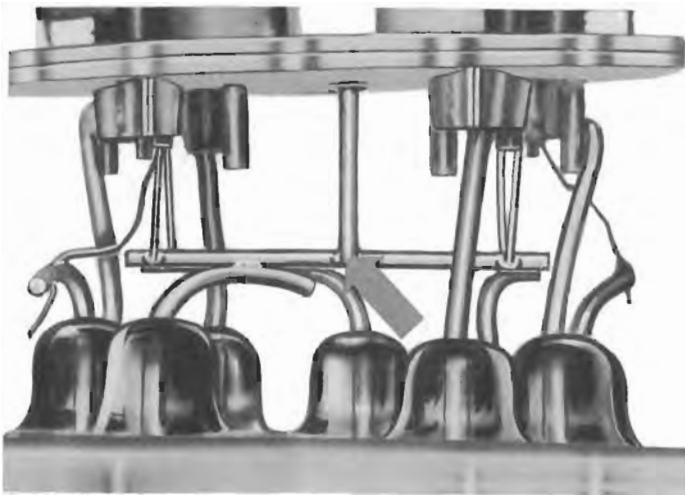

The heater bar in Five-Star tubes is welded to the base lead and firmly staked to the bottom mica spacer to assure good assembly welds and add to structural rigidity.

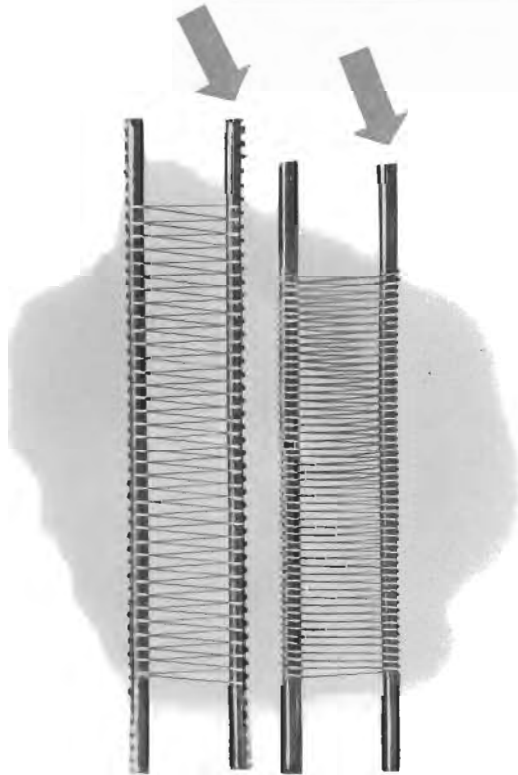

Grid legs are smooth (not nicked) in order to assure a continuing tight fit where the legs pass through the mica spacers. This prevents a "sawing" action on the mica, reducing grid vibration and microphonic noise. The photograph shows a comparison between a Five-Star grid (right) and a standard receiving tube grid (left).



Stops on the vertical support tabs are welded in place to give Five-Star tubes increased structural strength.

Five-Star tubes have certain other mechanical and electrical design features which can not be shown practically by microphotography.

For instance, the size of holes for the grid rods and the spacing between these holes are held to extremely close tolerances to assure firm fit and accurate spacing of the elements.

Heater wire is given a heavier coating so that the assembled heater is held firmly in the cathode. This

extra coating also minimizes heater-cathode shorts.

The higher grade micas used are carefully checked for uniformity in surface and thickness. These micas give greater strength to the tube because they have less tendency to flake or split.

Many Five-Star tubes have higher heater current rating to allow reliable operation within wider heater voltage limits.

---

## **A STATEMENT ABOUT G-E ENGINEERING ASSISTANCE**

To facilitate the design of Five-Star tubes into your equipments, competent G-E engineering assistance is always available to you.

The engineers who design, build and test these tubes have a thorough knowledge of their capabilities. They will welcome an opportunity to discuss your application problems, and to make specific recommendations to you.

Your Tube Department representative, located at the G-E regional office nearest you, will make arrangements to provide this service at your request.

### **EASTERN REGIONAL OFFICE**

General Electric Company  
Tube Department  
200 Main Avenue  
Clifton, New Jersey  
GRegory 3-6387

NOTE: If you call the above  
office from N. Y. City, dial  
direct, using WIsconsin 7-4065

### **CENTRAL REGIONAL OFFICE**

General Electric Company  
Tube Department  
3800 No. Milwaukee Avenue  
Chicago 41, Illinois  
SPring 7-1600

### **WESTERN REGIONAL OFFICE**

General Electric Company  
Tube Department  
11840 West Olympic Boulevard  
Los Angeles, California  
BRadshaw 2-8566  
ARizona 9-7765

*Here's what they say about*

## **G-E FIVE-STAR TUBES**



"Some of these tubes have served 7,500 hours—have been on the job 24 hours a day, 7 days a week, in the two-way radio stations we use to contact our trouble-shooting trucks. Many of the stations are remote-control, which puts a heavy load of responsibility on the tube complement. G-E 5-Star Tubes are everything we could ask for in reliability."

**L. P. WORKS**  
Distribution Engineer,  
Wisconsin Public Service Corp.,  
Green Bay, Wisconsin

"During a six-month carefully controlled comparison service test, FIVE-STAR ARINC TUBES required only one-fourth as many replacements as first quality standard brand tubes."

**FRANK R. WAGNER**  
Supervisor of Radio, Electrical and Instrument  
Engineering, Trans-World Airlines

"We have four VHF Navigation Receivers which have been in service for more than 1000 hours each. Of the 104 FIVE-STAR ARINC TUBES used, we have not had a single failure."

**J. LANE WARE**  
Supervisor of Communications Engineering,  
National Airlines

"The effect of using FIVE-STAR ARINC TUBES in our equipment became immediately apparent. Off-schedule removals of airborne equipment due to tube failures have been materially reduced."

**J. R. CUNNINGHAM**  
Director of Communications,  
United Airlines

"Because of excessive failures in ordinary tubes, we installed about 500 G-E FIVE-STAR TUBES in our police cars. During a two-year period, only five have failed. We now have installed FIVE-STAR TUBES in all other emergency radio units in Miami and Dade County, including two ships, a plane, fire trucks and levee patrol vehicles."

**BEN DEMBY**  
Superintendent, Division of Communications,  
Department of Public Safety,  
Miami, Florida

"We maintain two-way radio equipments, many operating 24 hours a day, on oil drilling rig installations. The equipments are subject to severe vibrations and extreme variations in supply voltages. Because tube failures constitute the major portion of maintenance, we began using FIVE-STAR TUBES for replacement purposes. During the past six months, over 400 FIVE-STAR TUBES have been placed in operation, and we are happy to report that none has failed."

**JERRY S. STOVER**  
Communications Engineering Co.  
Dallas, Texas

---

The above statements are indicative of what FIVE-STAR TUBE users are reporting.

If you are interested in reducing maintenance costs and increasing equipment reliability — specify dependable G-E FIVE-STAR TUBES.

And should you desire further information on the application of reliable G-E FIVE-STAR TUBES, contact your nearest G-E tube representative. He is ready at all times to be of assistance to you.

---

TUBE DEPARTMENT

**GENERAL  ELECTRIC**

Schenectady 5, N. Y.