

Western Electric

301A

301A Vacuum Tube

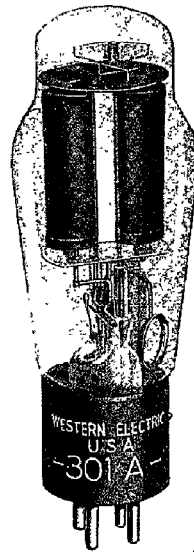

Classification—Full wave, thermionic, mercury vapor rectifier

The 301A vacuum tube is designed to supply direct current from an alternating-current supply.

Dimensions—The dimensions and outline diagrams are given in Figures 1 and 2. The overall dimensions are:

Maximum length.....	.6 $\frac{1}{2}$ "
Maximum diameter.....	.2 $\frac{1}{16}$ "

Mounting—The 301A employs a standard 4-pin thrust type base suitable for use in a Western Electric 143B or similar socket. Base dimensions and the arrangement of electrode connections to the base terminals are shown in Figs. 1 and 2.

The tube should be mounted in a vertical position with the base end down. There should be a free circulation of air around the tube. No object should touch the glass bulb.

Filament Rating

Filament voltage.....	5.0 volts
Nominal filament current.....	3.0 amperes

The filament of this tube is designed to operate on a voltage basis from an alternating-current supply. The voltage should be maintained to within 5% of its rated value (5.0 volts). Operation

FILE: RECTIFIER TUBE SECTION

301A

of the filament at a voltage above the upper limit will definitely reduce the life of the tube while a decrease in voltage below the lower limit may cause immediate failure.

Sufficient time must always be allowed for the filament temperature to reach its normal operating value before the anode potential is applied. If filament circuits with good regulation are used, this time is 30 seconds. If the tube is operated at ambient temperatures below 20° C., a longer period of time is required for the purpose of bringing the mercury vapor pressure to a satisfactory operating value. The minimum filament warming time as a function of ambient temperature is shown in figure 3.

For proper distribution of the mercury a period of 10 to 15 minutes filament warming time should be allowed when the tube is used for the first time or if it has been reinserted in the apparatus after having been removed.

Characteristics and Operating Conditions

Approximate anode-cathode potential drop.....	10 volts
Maximum peak plate current.....	1.0 ampere
Maximum peak potential between electrodes.....	1800 volts
Maximum operating ambient temperature range.....	0 to 50° C
Recommended operating ambient temperature range.....	10 to 40° C

The anode-cathode potential drop is substantially independent of the plate current. The exact value varies from tube to tube and during the life of a given tube. Within the specified ambient temperature range and plate current range, it may vary from 5 to 25 volts.

The anode-cathode drop as a function of temperature is shown on fig. 4 for a typical 301A tube after reaching temperature equilibrium and when passing the rated plate current.

The maximum permissible peak plate current (1.0 ampere) is a limitation on the instantaneous value that the tube can carry safely in the direction in which it is designed to conduct and should not be exceeded. The maximum direct load current is not fixed but will depend upon the wave form required by the load and filter circuit.

The maximum permissible peak potential between electrodes (1800 volts) is a limitation on the instantaneous value that the tube can stand safely. If it is exceeded, an arc-back may result which will injure the tube. The maximum direct potential available is not fixed but will depend upon the type of circuit used.

301A vacuum tubes may be operated in parallel if some provision is made to insure a proper division of the load current. Current dividing reactors or ballasting resistors in series with each anode, may be used for this purpose. The size of the reactors or resistors depends upon the circuit design.

In most cases the termination of the useful life of the 301A tube is due to the loss of filament activity. This causes the tube to fail by arcing between the electrodes. Failures of this kind should be safeguarded by proper fuse protection to prevent injury to other tubes in the circuit and to the auxiliary equipment.

Typical Rectifier Circuits—The 301A vacuum tube may be used in any standard high vacuum rectifier circuit subject to its current, voltage and temperature limitations. Typical circuits are shown below. The approximate direct output current and voltage for each type of rectifier circuit where tubes are operated at maximum permissible plate current and inverse voltage are given in Table 1. The values listed are average values of the pulsating current and voltage for an unfiltered circuit.

Table 1

Circuit Designation	Phase Supply	Number Tubes	Load Potential in Volts	Load Current in Amperes
A	1	1	550	0.6
B	1	2	550	1.2
C	1	2	1100	0.6
D	3	3	800	1.6
E	3	3	700	1.8
F	1	3	1100	0.6

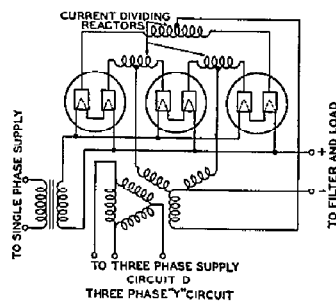
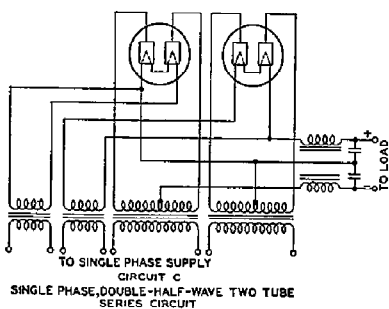
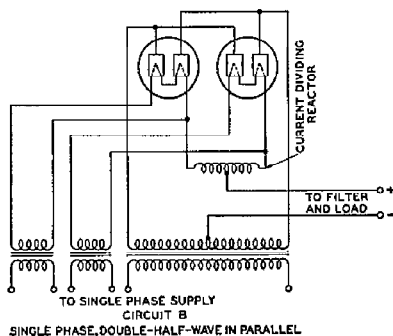
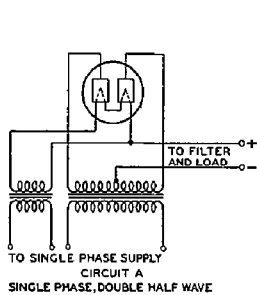

301A

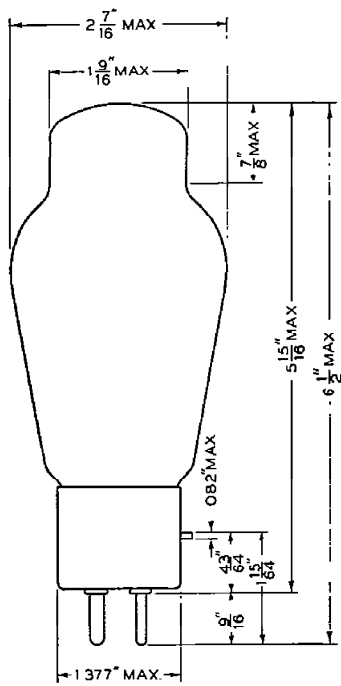
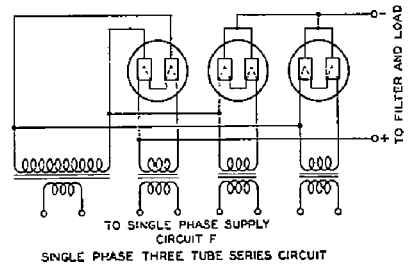
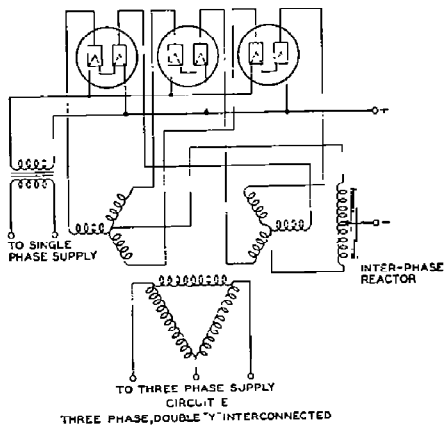

FIG. 1

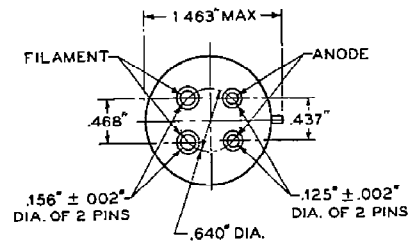

FIG. 2

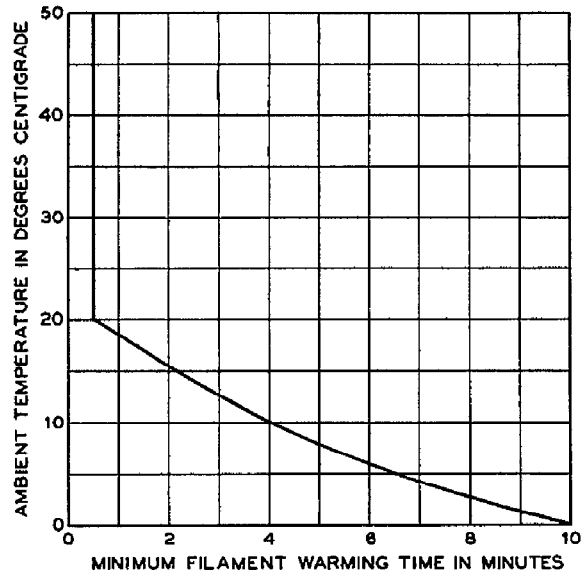

FIG. 3

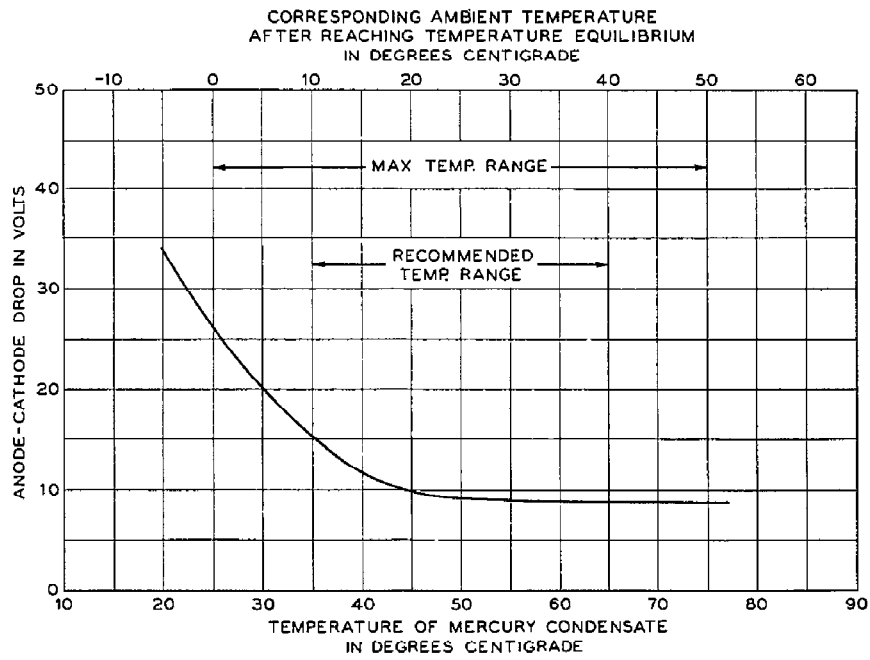

FIG. 4

A. development of Bell Telephone Laboratories, Incorporated,
the research laboratories of the American Telephone and Telegraph Company and the Western Electric Company

308B

Western Electric

308B Vacuum Tube



Classification—Filamentary air-cooled triode

This tube was designed primarily for use as an audio-frequency amplifier or modulator; or as a radio-frequency oscillator or amplifier.

Dimensions—Dimensions and outline diagrams are shown in Figures 1 and 2 and are:

Maximum overall length.....	13 $\frac{5}{8}$ "
Maximum diameter.....	3 $\frac{1}{8}$ "

Copyright 1936 Western Electric Company, Incorporated

Mounting—Large four-pin bayonet base for use in a W. E. 118A or similar socket, for either vertical or horizontal mounting. If mounted horizontally the plane of the filament, which is indicated in Figure 2, should be vertical.

Filament—Thoriated tungsten.

Filament voltage.....	14 volts
Nominal filament current.....	6 amperes
Average thermionic emission.....	4 amperes

Approximate Direct Interelectrode Capacitances

Plate to grid.....	17.4 μmf .
Grid to filament.....	13.6 μmf .
Plate to filament.....	9.3 μmf .

Characteristics—Performance data given below are based upon a typical set of conditions. Variations can be expected with different circuits and tubes.

Figures 3 and 4 give the static characteristics of a typical tube plotted against grid and plate voltages.

Average Characteristics at 1500 volts direct plate potential and minus 150 volts grid bias, $I_b = .167$ ampere.

Amplification factor.....	8
Plate resistance.....	1070 ohms
Grid to plate transconductance.....	7500 micromhos

Operation

Maximum Ratings

Max. direct plate voltage.....	2250 volts
Max. direct plate current.....	325 milliamperes
Max. plate dissipation.....	250 watts
Max. direct grid current.....	75 milliamperes
Max. r-f grid current.....	5 amperes
Max. frequency for the above ratings.....	1.5 megacycles
Max. plate voltage for upper frequency limit of 4.5 Mc.....	750 volts
Max. plate voltage for frequencies between 1.5 and 4.5 Mc in proportion.	

The above are maximum ratings which do not apply simultaneously but depend on the type of service as specified below.

Class A Audio Amplifier or Modulator

Direct plate voltage.....	1500	1000 volts
Grid bias.....	-155	-80 volts
Direct plate current.....	135	210 milliamperes
Plate dissipation.....	200	210 watts
Load impedance.....	13000	3000 ohms
Undistorted output.....	50	35 watts

Class B Audio Amplifier or Modulator—for Balanced 2 Tube Circuit

Direct plate voltage.....	1750	1500 volts
Grid bias.....	-215	-180 volts
Direct plate current per tube		
No drive.....	30	25 milliamperes
Max. drive.....	300	300 milliamperes
Plate dissipation.....	240	210 watts
Load resistance plate-to-plate.....	5200	4280 ohms
Load resistance per tube.....	1300	1070 ohms
Approximate maximum output.....	575	475 watts
Recommended power for driving stage.....	35	35 watts

Class B Radio-Frequency Amplifier

Direct plate voltage.....	1750	1500 volts
Direct plate current.....	215	250 milliamperes
Plate dissipation.....	250	250 watts
Grid bias.....	-230	-200 volts
Approx. carrier watts for use with 100% modulation	125	125 watts

Class C Radio-Frequency Oscillator or Power Amplifier—Unmodulated

Direct plate voltage.....	1750	1500 volts
Direct plate current.....	900	300 milliamperes
Grid bias.....	-345 to -460	-300 to -400 volts
Nominal power output.....	350	300 watts

Class C Radio-Frequency Amplifier—Plate Modulated

Direct plate voltage.....	1250	1000 volts
Direct plate current.....	300	300 milliamperes
Grid bias.....	-320	-260 volts
Max. direct grid current.....	75	75 milliamperes
Nominal carrier power output for use with 100% modulation.....	250	200 watts

Operating Precautions

Mechanical—Figures 1 and 2 show the overall dimensions and basing arrangement for the tube.

The tubes should not be subjected to mechanical shock or excessive vibration. Mechanical vibration may cause breakage of the thoriated tungsten filaments.

A free circulation of air must be provided to insure adequate cooling of the glass during operation.

Electrical—Overload protection should always be provided for the plate circuit. A suitable fuse or circuit breaker should remove the plate voltage if the plate current exceeds 425 milliamperes. Although the tube is sufficiently rugged to withstand momentary overloads, a prolonged overload caused by inefficient adjustment of the circuit, may damage the tube. When adjusting a new circuit, reduced plate voltage or a series resistance of 1000 to 5000 ohms in the plate circuit should be used until it is operating properly.

The filament should always be operated at the rated voltage, measured at the tube terminals. A 5% decrease in filament voltage reduces the thermionic emission approximately 25%. Either direct or alternating current may be used for heating the filament. If direct current is used, the plate and grid circuit returns should be connected to the negative filament terminal. If alternating current is used, the circuit returns should be connected to the center tap of the filament heating transformer winding or to the center tap of a resistor placed between the filament terminals. A resistance of 30 to 40 ohms of ten watt rating is suitable.

In cases where severe and prolonged overload has temporarily impaired the electronic emission of the filament, the activity may be restored by operating the filament, with the plate and grid voltages off, 30% above normal voltage for 10 minutes followed by a longer period at normal voltage.

Audio Amplifier or Modulator

Class A—Peak grid drive equal to or less than the grid bias.

Grid bias may be obtained from the drop across a resistance in the plate current return or from a battery or rectifier supply.

Plate dissipation allowable for this type of service is generally lower than is safe for other uses since the energy is dissipated in the plate in smaller areas due to relatively high voltage drop in the tube.

The plate dissipation is equal to the plate voltage multiplied by the normal plate current. Performance data are based upon the use of a resistance load. Undistorted output is calculated on the basis of 5% second harmonic distortion.

Class B—Grid bias practically at cut-off and grid driving voltage higher than the bias.

Two tubes may be used in a balanced circuit. An adequate driving stage and an input transformer with good regulation must be used so that the grid current drawn during positive grid swings does not produce appreciable distortion. The output transformer must transform the load impedance to the proper value for the tubes used. The power output obtainable will be determined by the quality of the transformer used and the amount of distortion which can be tolerated. The grid bias must be held constant and therefore cannot be obtained by grid leak or series resistor methods. A battery or other source having good regulation is necessary.

The power required of a modulator for complete modulation of a Class C amplifier is one-half the direct power input to the plates of the Class C amplifier.

Radio-Frequency Oscillator or Power Amplifier

Class B—Radio-Frequency Amplifier.

The Class B radio-frequency amplifier is used to amplify a modulated radio-frequency carrier wave without appreciable distortion. It operates similarly to the Class B audio amplifier except that a single tube may be used, the tuned output circuit serving to preserve the wave shape. The push-pull circuit, however, eliminates the even order harmonics and thus increases the efficiency slightly.

Class C—Grid bias below cutoff.

Unmodulated

This type of operation is suitable for telegraphy, or the production of a continuous flow of radio-frequency power for purposes other than communication.

Plate Modulated

This type of operation is for use when the modulating voltage is superimposed on the plate supply voltage and to obtain good quality the output power should vary as the square of the plate voltage. For complete or 100% modulation, the plate voltage varies from zero to twice the applied direct value during a cycle of the audio frequency. With no modulation applied, the plate voltage is, of course, the direct value and the carrier power output is one-fourth of the peak power output under 100% modulation. In this case, since the plate voltage varies with modulation, the direct value must be rated lower than for other types of operation.

High Frequency Ratings

The frequency limits specified under maximum ratings are based on the tube being used as an oscillator. The tube may be used at full rating up to 1.5 megacycles. When operating at higher frequencies, the dielectric losses, charging currents and lead-in heating are increased greatly. The plate voltage and hence plate dissipation must be reduced to values specified for the upper frequency limit and for frequencies between these two limits the plate voltage should be proportionately reduced.

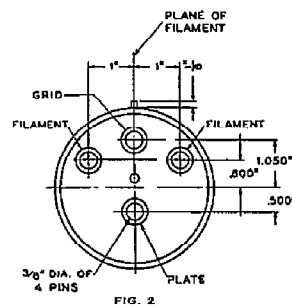
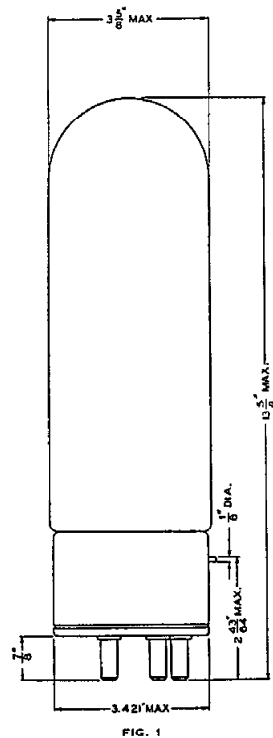

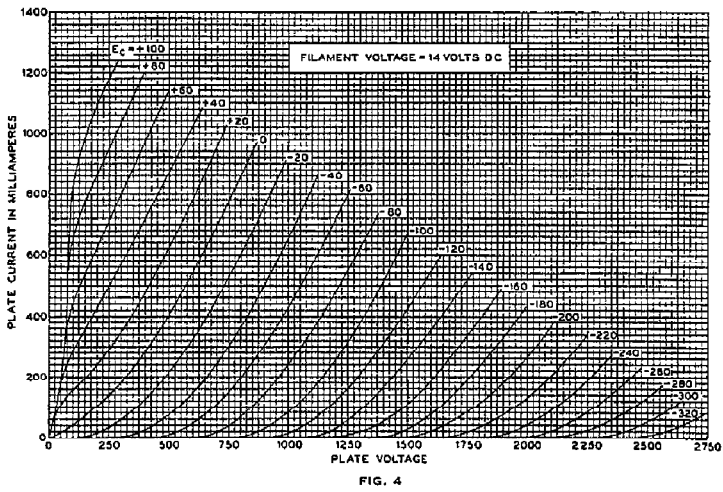
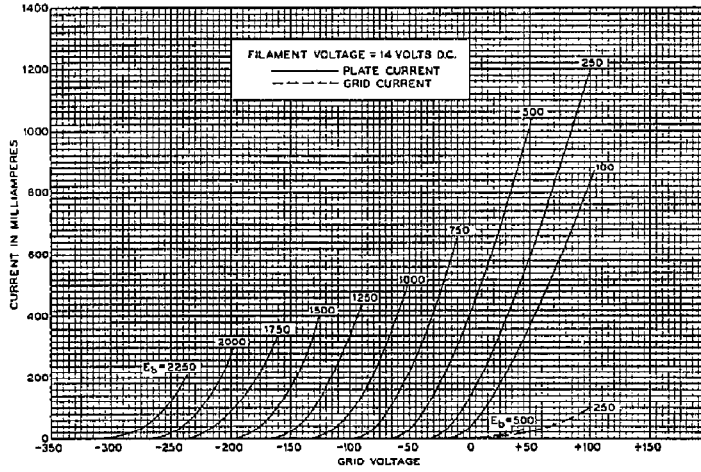

ELECTRON TUBE DATA SHEET
WESTERN ELECTRIC 310A ELECTRON TUBE

310A



DESCRIPTION

The 310A is an indirectly heated cathode type pentode having a separate suppressor grid connection. It is intended for use in audio, carrier and radio-frequency voltage amplifiers, oscillators or modulators.

CHARACTERISTICS

Heater Voltage	*9.0	10.0 volts
Plate Current	5.1	5.5 milliamperes
Transconductance $\left(\begin{array}{l} E_b = 180 \text{ volts; } E_{c2} = 135 \text{ volts;} \\ E_{c1} = -3 \text{ volts; } E_{c3} = 0 \end{array} \right)$	1760	1820 micromhos

*Operation with the heater at 9.0 volts is permissible only when such voltage is regulated to $\pm 1.0\%$ or better.

GENERAL CHARACTERISTICS

ELECTRICAL DATA

Heater Voltage	9.0	10.0 volts
Heater Current	300	320 milliamperes
Direct Interelectrode Capacitances	without external shield	with external shield (RETMA #311)
Grid to Plate (maximum)	0.016	*0.010 μ f
Input: g1 to (h+k+g2+g3+i.s.)	6.0	*7.0 μ f
Output: p to (h+k+g2+g3+i.s.)	13	*13 μ f

MECHANICAL DATA

Cathode	Coated unipotential
Bulb	ST12
Base	Small 6-pin
Mounting Position	Any
Dimensions and pin connections shown in outline drawings on page 5	

MAXIMUM RATINGS, Design-Center Values

Plate Voltage	250 volts
Screen Grid Voltage	180 volts
Plate Dissipation	2.0 watts
Screen Grid Dissipation	0.4 watt
Cathode Current	10 milliamperes
Heater-Cathode Voltage	150 volts

TYPICAL OPERATING CONDITIONS AND CHARACTERISTICS

Heater Voltage	10.0	10.0	10.0 volts
Plate Voltage	135	180	250 volts
Screen Grid Voltage	135	135	135 volts
Control Grid Voltage	-3	-3	-3 volts
Suppressor Grid Voltage	0	0	0 volts
Plate Current	5.40	5.50	5.60 milliamperes
Screen Grid Current	1.20	1.18	1.17 milliamperes
Peak A-F Signal Voltage	3.00	1.50	2.10 volts
Plate Resistance	0.75	0.90	1.15 megohms
Transconductance	1800	1820	1840 micromhos
Load Resistance	20000	100000	100000 ohms
Power Output	250	150	310 milliwatts
Total Harmonic Distortion	8.5	6	6 per cent
Control Grid Voltage, Approximate, for 10 Microamperes Plate Current	-9.5	-9.5	-9.5 volts

*With external shield (RETMA #311) connected to cathode pin.

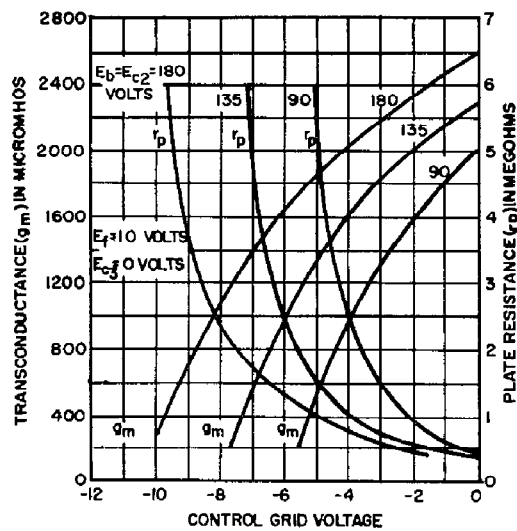
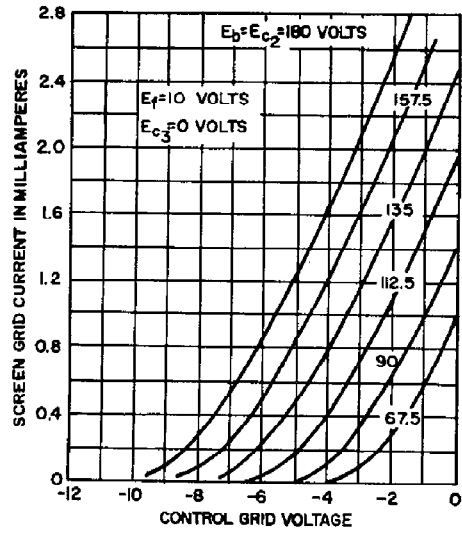
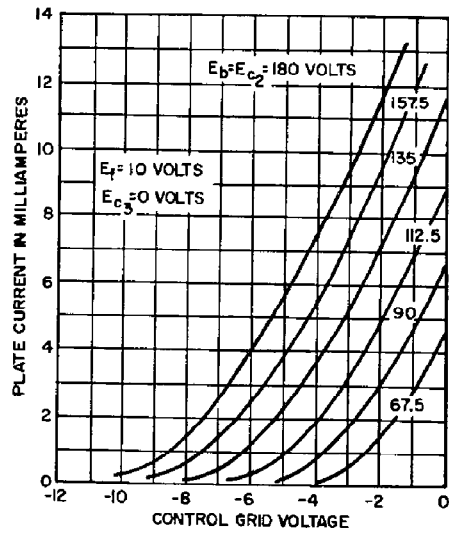

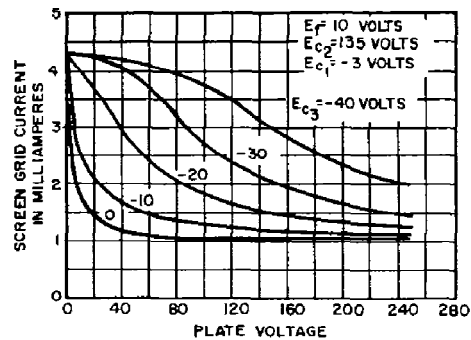
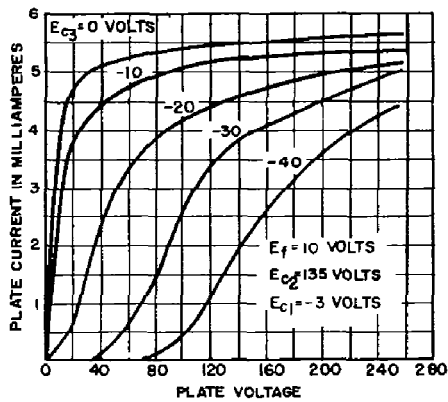
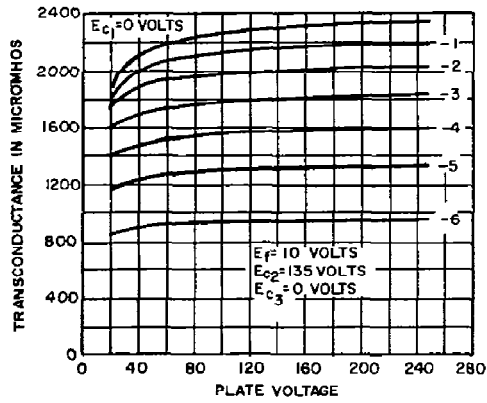
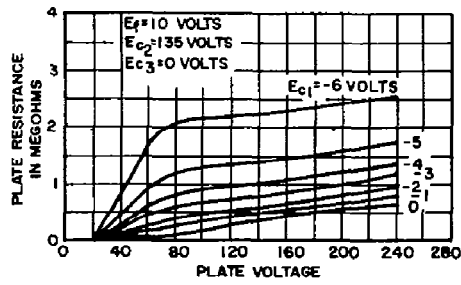
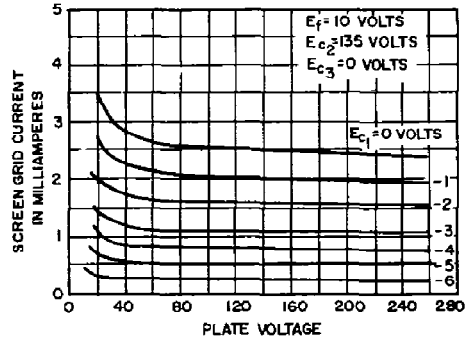
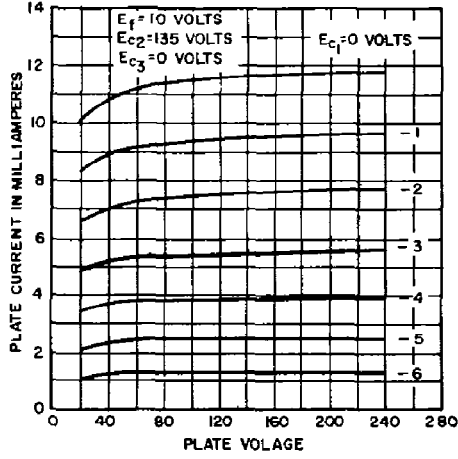

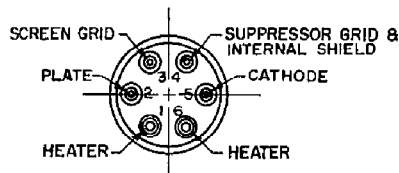
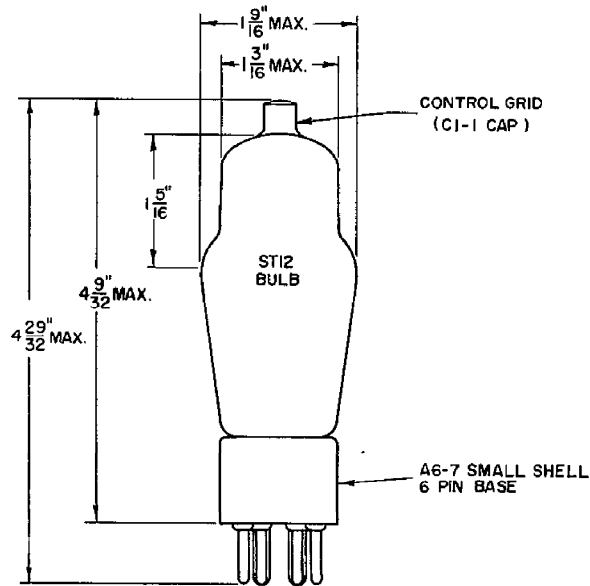
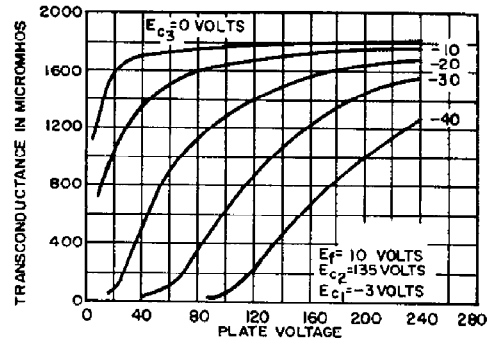
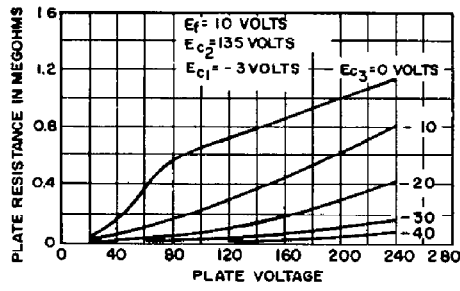

ELECTRON TUBE DATA SHEET
WESTERN ELECTRIC 310B ELECTRON TUBE

310B



DESCRIPTION

The 310B is an indirectly heated cathode type pentode having a separate suppressor grid connection. It is intended for use in audio, carrier and radio-frequency voltage amplifiers, oscillators or modulators. This tube, except for having special design features to minimize microphonic noise and hum and having an appreciably lower maximum heater-cathode voltage rating, is identical to the 310A.

CHARACTERISTICS

Heater Voltage	10.0 volts
Plate Current	5.5 milliamperes
Transconductance	1820 micromhos

($E_b = 180$ volts; $E_{c2} = 135$ volts; $E_{c1} = -3$ volts; $E_{c3} = 0$)

310B

GENERAL CHARACTERISTICS

ELECTRICAL DATA

Heater Voltage		10.0 volts
Heater Current		320 milliamperes
Direct Interelectrode Capacitances	without external shield	with external shield (RETMA #311)
Grid to Plate (maximum)	0.016	*0.010 μ mf
Input: g1 to (h+k+g2+g3+i.s.)	6.0	*7.0 μ mf
Output: p to (h+k+g2+g3+i.s.)	13	*13 μ mf

MECHANICAL DATA

Cathode	Coated unipotential
Bulb	STM2
Base	Small, 6-pin
Mounting Position	Any
Dimensions and pin connections shown in outline drawings on Page 5	

MAXIMUM RATINGS, Design-Center Values

Plate Voltage	250 volts
Screen Grid Voltage	180 volts
Plate Dissipation	2.0 watts
Screen Grid Dissipation	0.4 watt
Cathode Current	10 milliamperes
Heater-Cathode Voltage	30 volts

TYPICAL OPERATING CONDITIONS AND CHARACTERISTICS

Plate Voltage	135	180	250 volts
Screen Grid Voltage	135	135	135 volts
Control Grid Voltage	-3	-3	-3 volts
Suppressor Grid Voltage	0	0	0 volts
Plate Current	5.40	5.50	5.60 milliamperes
Screen Grid Current	1.20	1.18	1.17 milliamperes
Peak A-F Signal Voltage	3.00	1.50	2.10 volts
Plate Resistance	0.75	0.90	1.15 megohms
Transconductance	1800	1820	1840 micromhos
Load Resistance	20000	100000	100000 ohms
Power Output	250	150	310 milliwatts
Total Harmonic Distortion	8.5	6	6 per cent
Control Grid Voltage, Approximate, for Plate Current of 10 Microamperes	-9.5	-9.5	-9.5 volts

*With external shield (RETMA #311) connected to cathode pin.

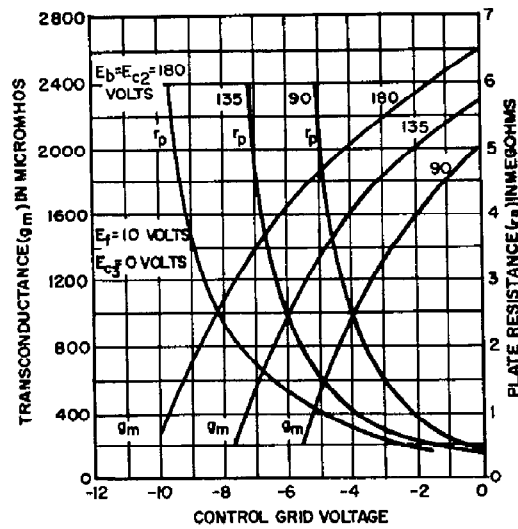
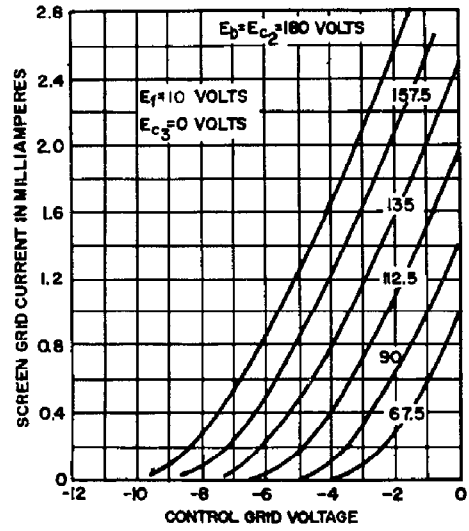
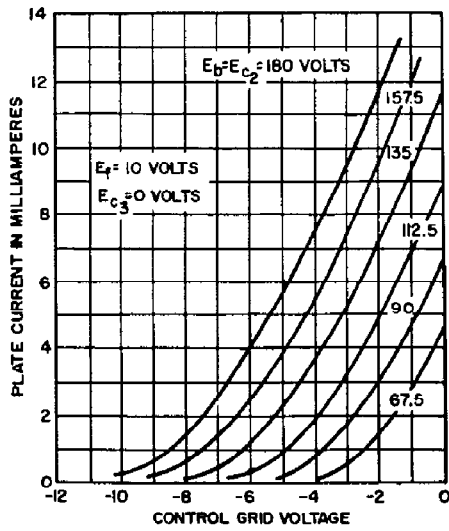

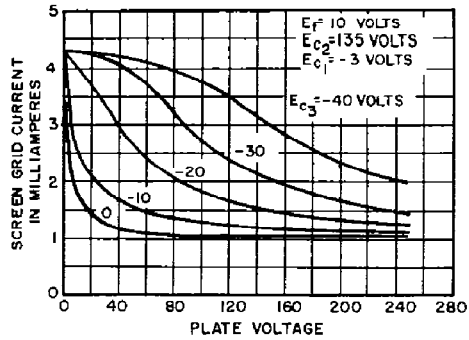
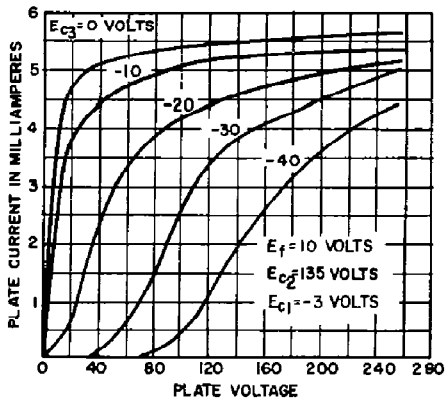
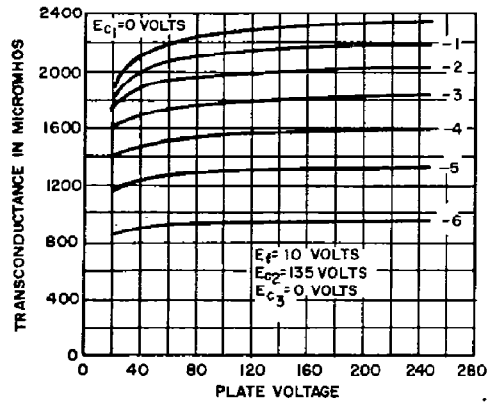
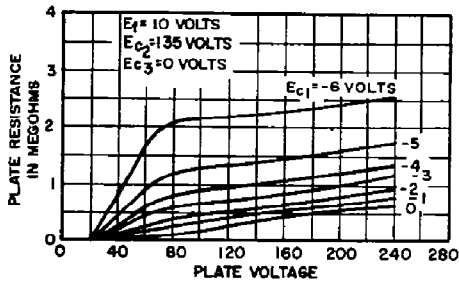
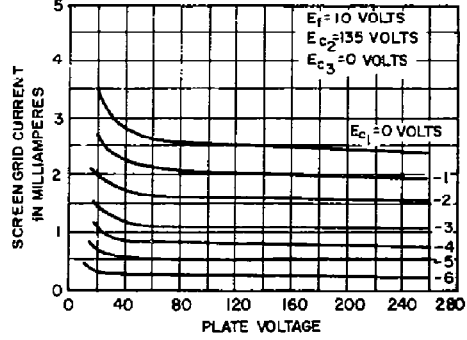
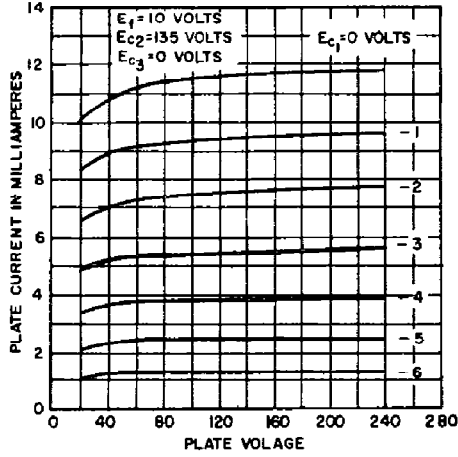

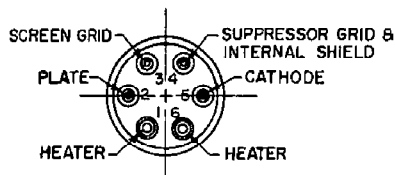
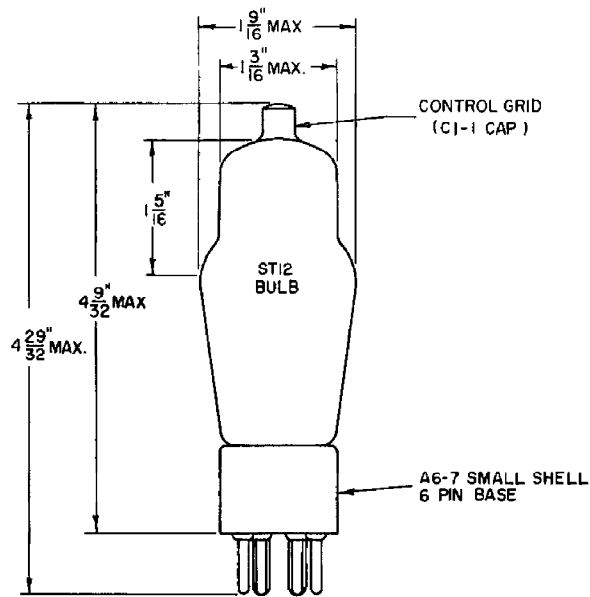
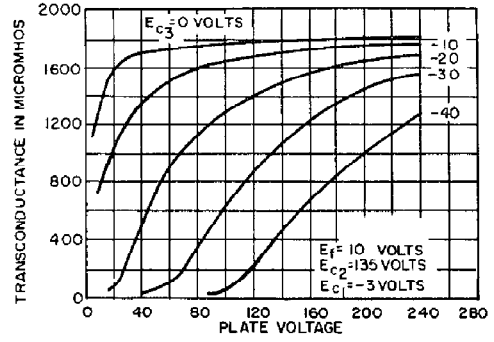
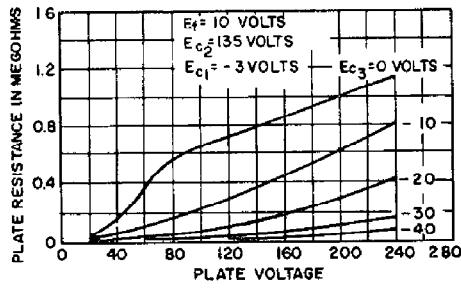

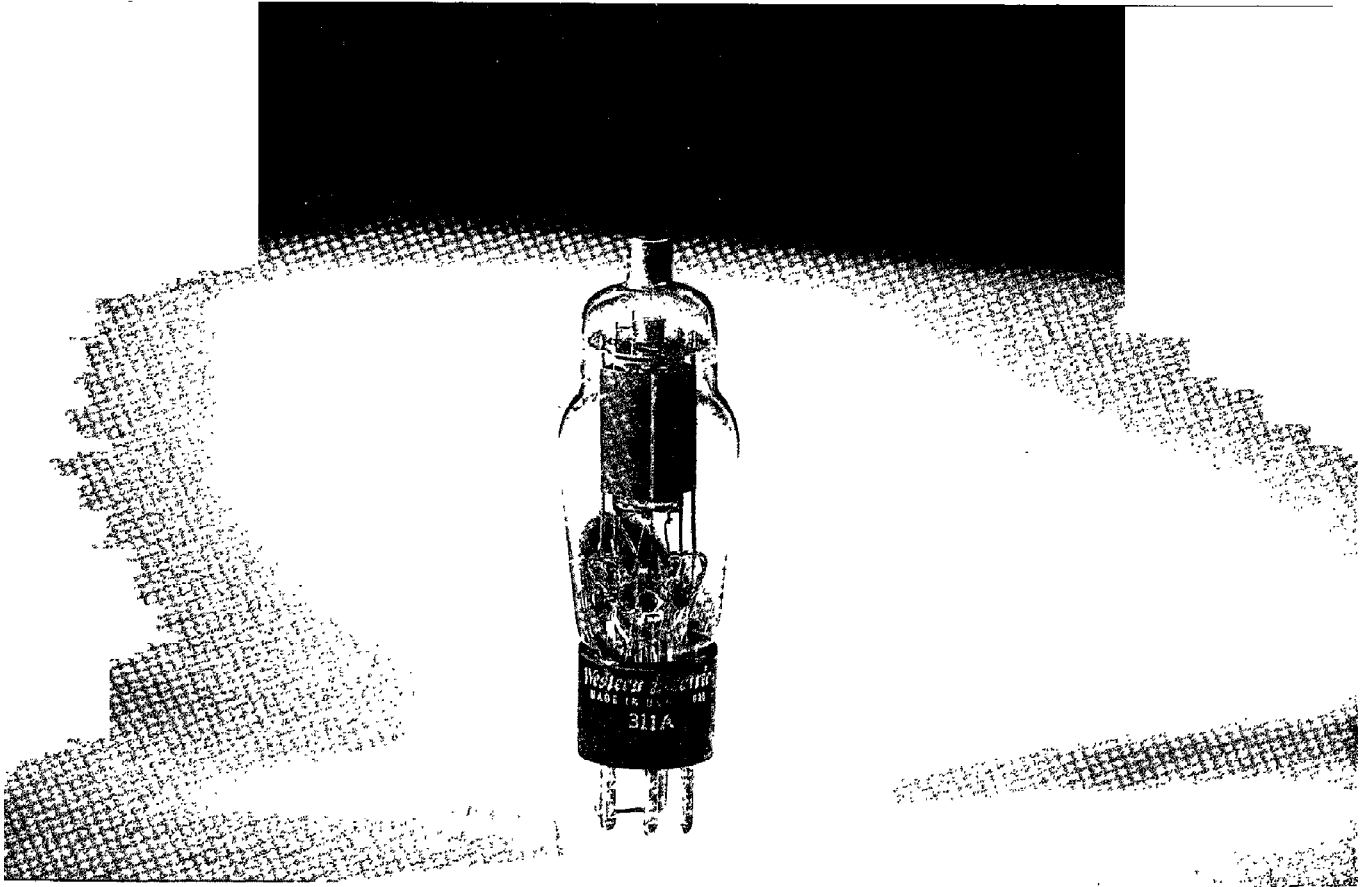

PENTODE

Western Electric

DESCRIPTION

The 311A is a suppressor grid power pentode having an indirectly heated cathode. It is designed for use as an audio, carrier or radio-frequency amplifier.

CHARACTERISTICS

Heater Voltage		10.0 volts
Plate Current	$\left. \begin{array}{l} E_b = 135 \text{ volts;} \\ E_{c2} = 135 \text{ volts;} E_{c1} = -15 \text{ volts} \end{array} \right\}$	33 milliamperes
Transconductance		2900 micromhos
Power Output		2.5 watts



GENERAL CHARACTERISTICS**ELECTRICAL DATA**

Heater Voltage, A-C or D-C		10.0 volts
Heater Current		0.64 ampere
Direct Interelectrode Capacitances		
	without external shield	with external shield (RMA #311)
Grid to Plate	0.32	0.09 uuf
Input	8.0	9.5 uuf
Output	8.5	10.4 uuf

MECHANICAL DATA

Cathode	Coated unipotential
Bulb	ST12
Base	Small, 5-pin
Mounting Position	Any
Dimensions and pin connections shown in outline drawing on Page 6	

MAXIMUM RATINGS, Design-Center Values

Plate Voltage	180 volts
Screen Grid Voltage	150 volts
Plate Dissipation	8 watts
Screen Grid Dissipation	2 watts
Cathode Current	60 milliamperes
Heater-Cathode Voltage	150 volts

TYPICAL OPERATING CONDITIONS AND CHARACTERISTICS**SINGLE TUBE AMPLIFIER—CLASS A₁**

Plate Voltage	135	180 volts
Screen Grid Voltage	135	135 volts
Control Grid Voltage	-15	-15 volts
Peak A-F Grid Voltage	15	15 volts
Zero Signal Plate Current	33	34 milliamperes
Maximum Signal Plate Current	36	38 milliamperes
Zero Signal Screen Grid Current	6.5	6.0 milliamperes
Maximum Signal Screen Grid Current	11.0	10.0 milliamperes
Transconductance	2900	3000 micromhos
Plate Resistance	40000	47000 ohms
Load Resistance	3500	4000 ohms
Maximum Signal Power Output	2.0	2.8 watts
Total Harmonic Distortion	9.0	10.5 per cent

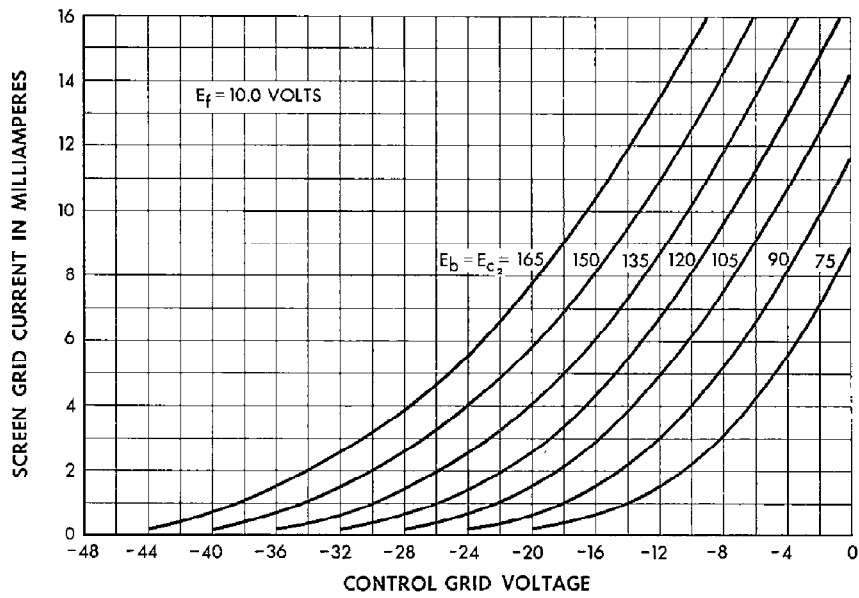
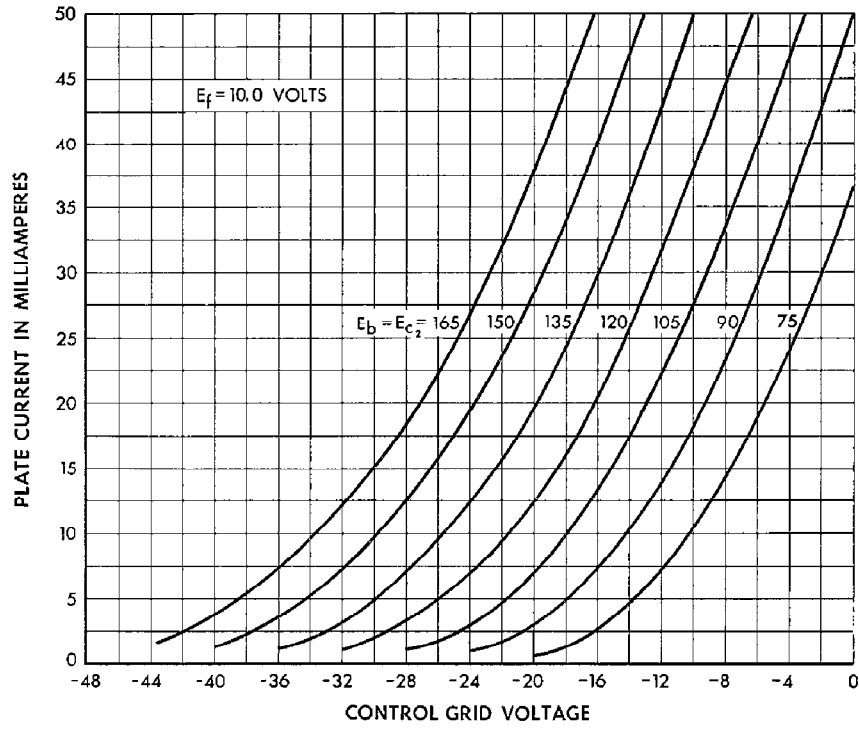

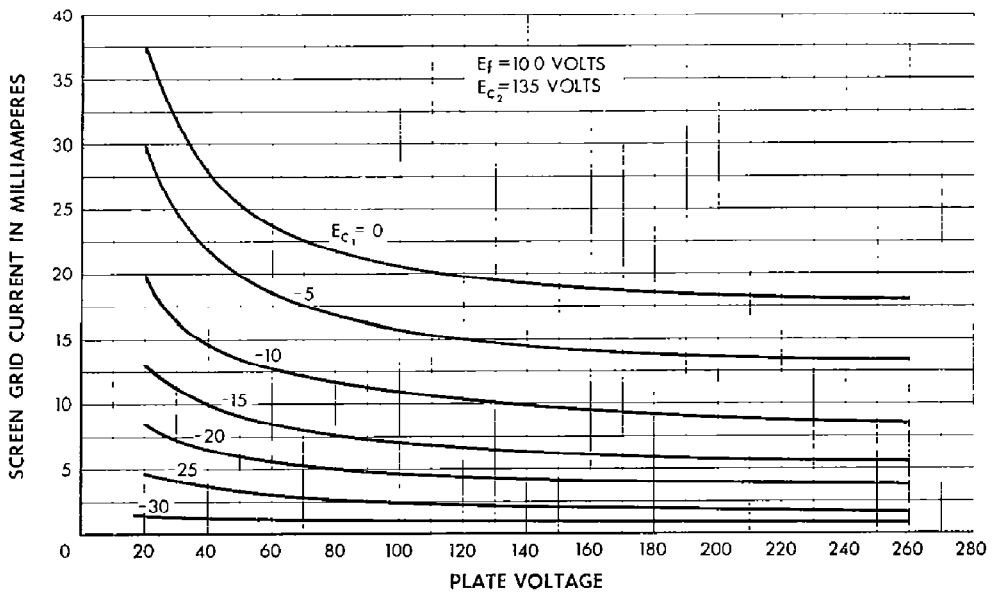
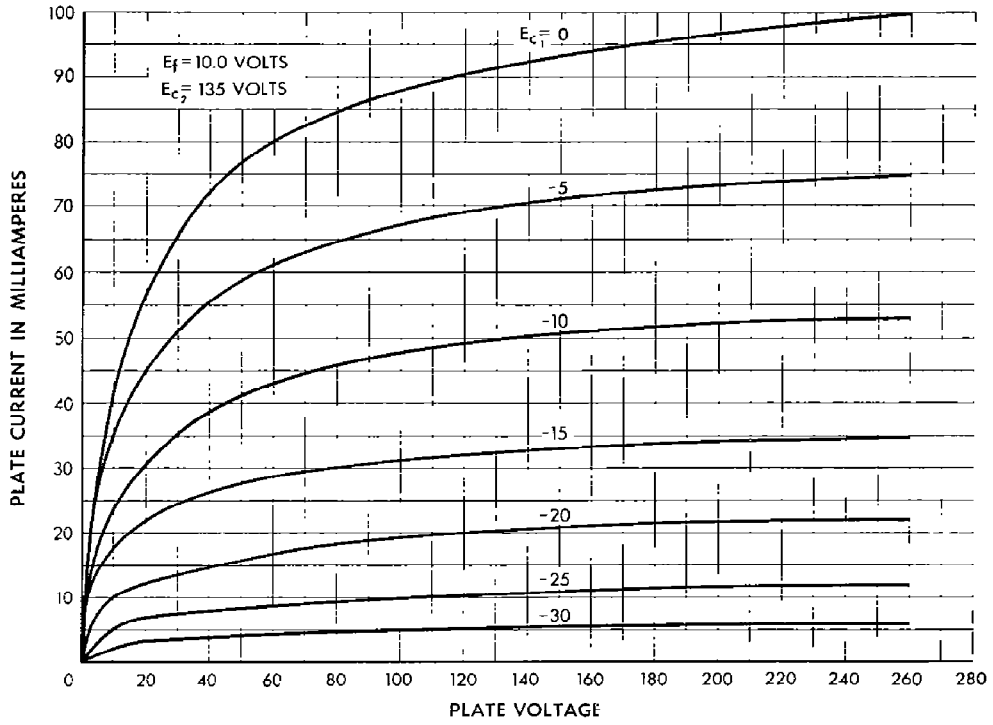

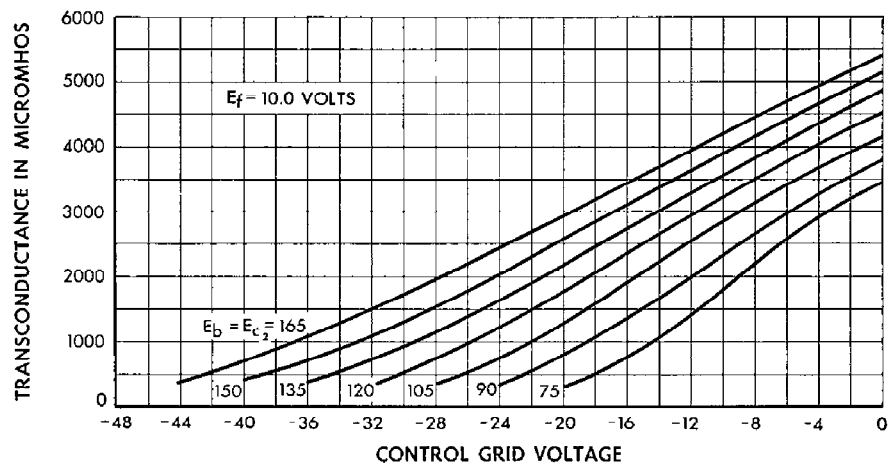
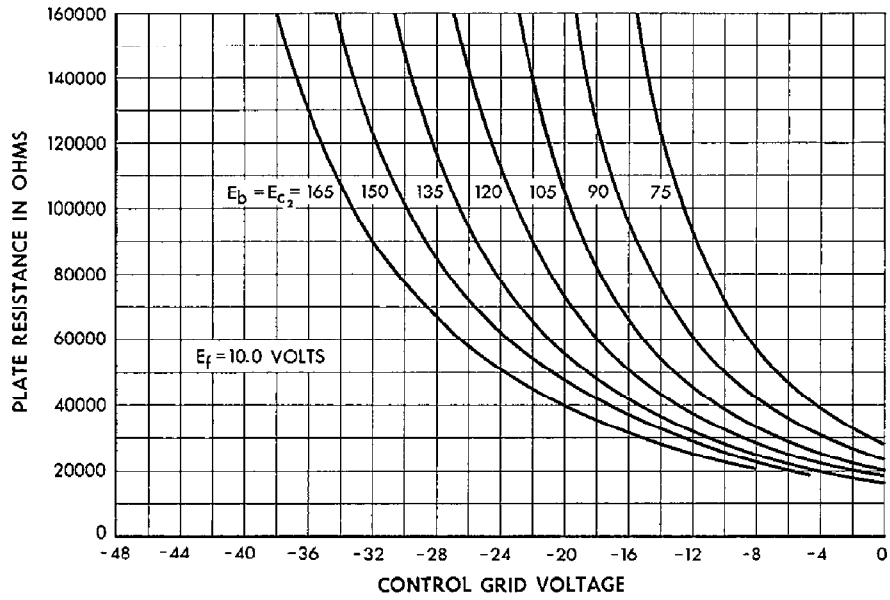

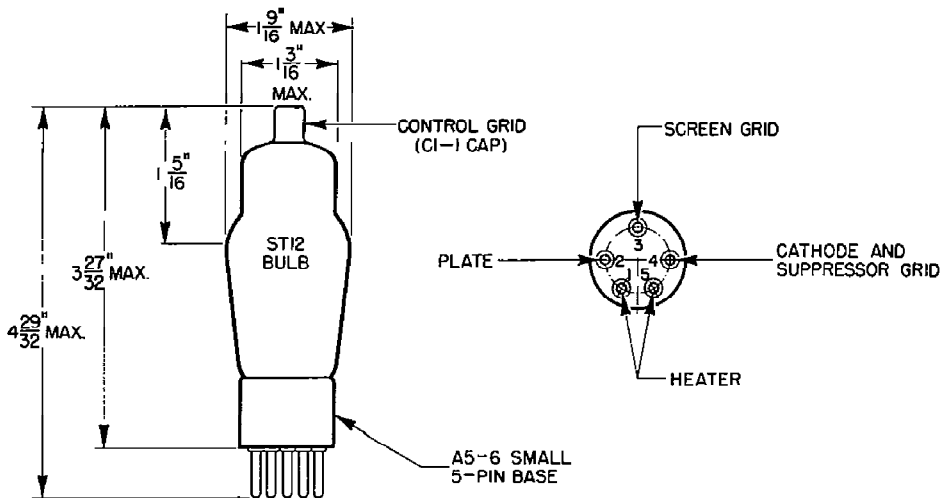
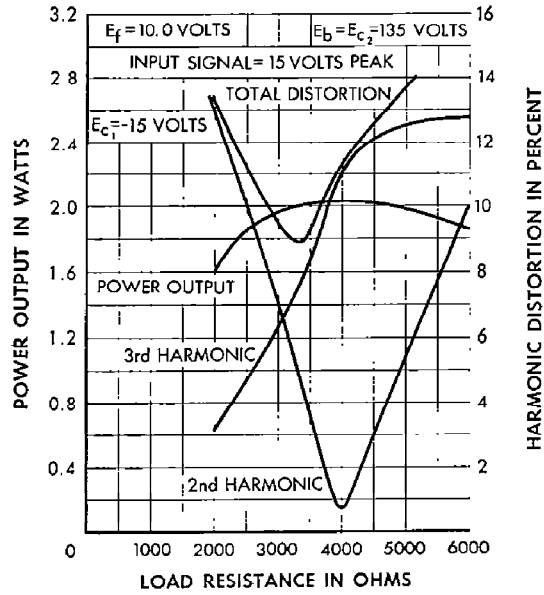

Western Electric

A development of Bell Telephone Laboratories, the research laboratories of the American Telephone and Telegraph Company and the Western Electric Company

ELECTRON TUBE DATA SHEET
WESTERN ELECTRIC 311B ELECTRON TUBE



311B

DESCRIPTION

The 311B is a suppressor grid power pentode having an indirectly heated cathode. It is designed for use as an audio, carrier or radio-frequency amplifier.

CHARACTERISTICS

Heater Voltage	9.0	10.0 volts
Plate Current	30	33 milliamperes
Transconductance	2800	2900 micromhos
Power Output	2.5	2.5 watts

$\left(\begin{array}{l} E_b = E_{c2} = 135 \text{ volts} \\ E_{c1} = -15 \text{ volts} \end{array} \right)$

File: General Purpose Section
Data Sheet Issue 1, 10-60

311B

GENERAL CHARACTERISTICS

Electrical Data

Heater Voltage, A-C or D-C (Note 1)	9.0	10.0 volts
Heater Current	0.60	0.64 ampere
Direct Interelectrode Capacitances	without	with
	external shield	external shield
		(RMA #311)
Grid to Plate	0.32	0.09 μf
Input	8.0	9.5 μf
Output	8.5	10.4 μf

Mechanical Data

Cathode	Coated unipotential
Bulb	ST12
Base	Small, 5 pin
Mounting Position	Any
Dimensions and pin connections shown in outline drawing on Page 4	

Maximum Ratings, Absolute System (Note 2)

Plate Voltage	200 volts
Screen Grid Voltage	150 volts
Plate Dissipation	9.0 watts
Screen Grid Dissipation	1.8 watts
Cathode Current	60 milliamperes
Heater-Cathode Voltage	150 volts

TYPICAL OPERATING CONDITIONS AND CHARACTERISTICS

Single Tube Amplifier - Class A

Heater Voltage	9.0	10.0	10.0 volts
Plate Voltage	135	135	180 volts
Screen Grid Voltage	135	135	135 volts
Control Grid Voltage	-15	-15	-15 volts
Peak A-F Grid Voltage	15	15	15 volts
Zero Signal Plate Current	30	33	34 milliamperes
Maximum Signal Plate Current	33	36	38 milliamperes
Zero Signal Screen Grid Current	6.3	6.5	6.0 milliamperes
Maximum Signal Screen Grid Current	11.5	11.0	10.0 milliamperes
Transconductance	2800	2900	3000 micromhos
Plate Resistance	45000	40000	47000 ohms
Load Resistance	3500	3500	4000 ohms
Maximum Signal Power Output	2.0	2.0	2.8 watts
Total Harmonic Distortion	10.0	9.0	10.5 per cent

Note 1: For optimum tube life, a heater voltage of 9 volts is recommended. However, when 9 volts is used, it must be regulated to $\pm 1\%$.

Note 2: In the "Absolute System" the maximum ratings specified are limiting values above which the serviceability of the device may be impaired from the viewpoint of life and satisfactory performance. Maximum ratings, as such, do not constitute a set of operating conditions and all values may not, therefore, be attained simultaneously.

TYPICAL CHARACTERISTIC CURVES

These curves are representative of the characteristics of typical tubes when 9.0 volts are applied to the heater. However, these characteristics do not differ significantly when 10.0 volts are applied to the heater.

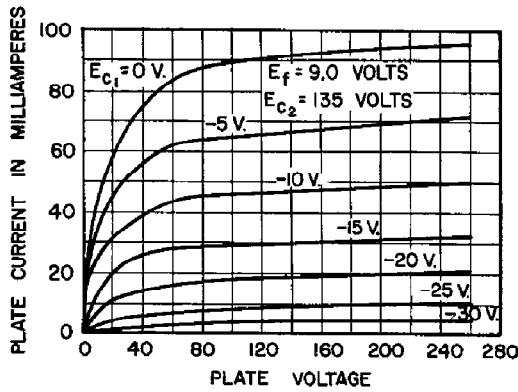

FIG. 1

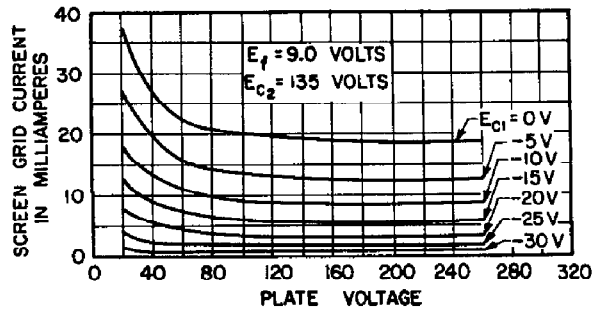

FIG. 2

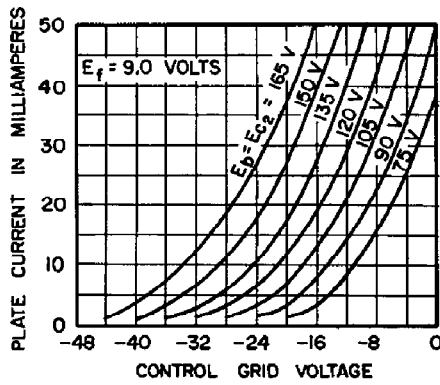

FIG. 3

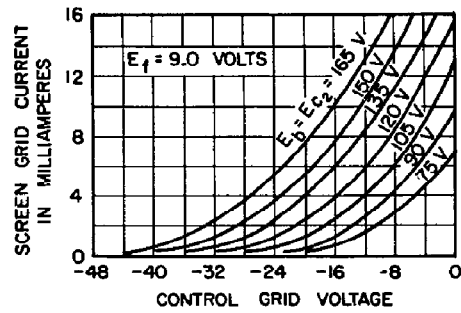

FIG. 4

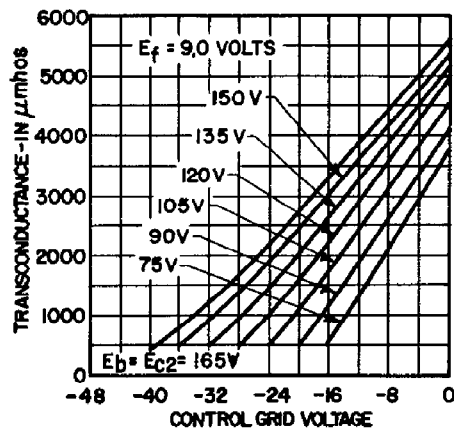

FIG. 5

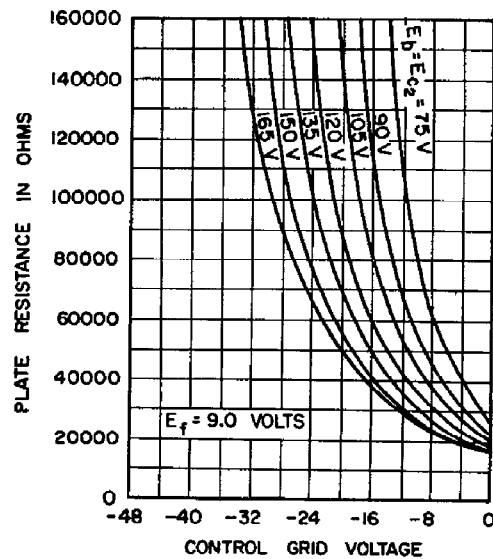

FIG. 6

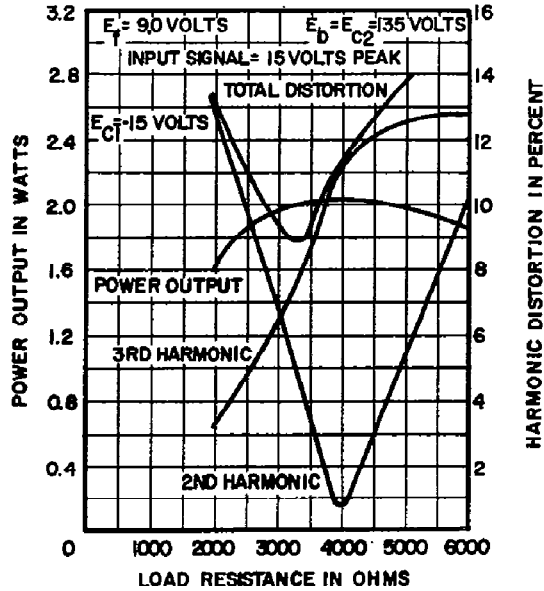
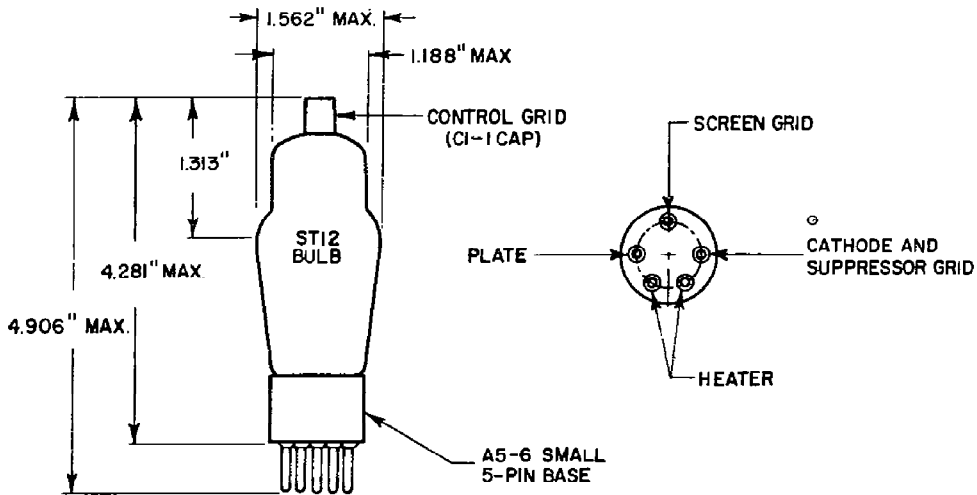
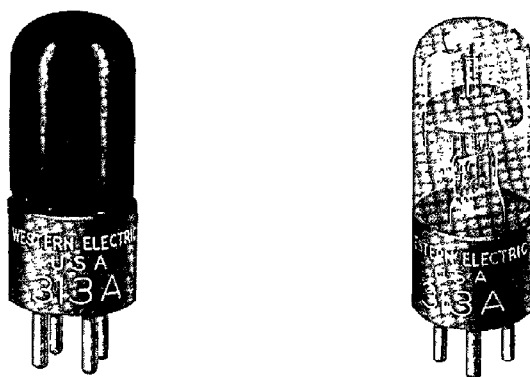

FIG. 7



A development of Bell Telephone Laboratories, the research laboratories of the American Telephone and Telegraph Company and the Western Electric Company.

*Western Electric***313A Vacuum Tube**

Classification—Double gap, cold cathode, gas-filled tube for use as a relay, rectifier or voltage regulator in special circuits.

The elements of the 313A tube consist of two similar control electrodes and one anode. The conduction path between the control electrodes is known as the control gap. The conduction path between either control electrode and the anode is known as the main gap.

The glass bulb has been given an opaque coating so that the discharge is not visible while the tube is operating. In the photograph at the right the coating has been removed to show the tube elements.

Dimensions—The dimensions and outline diagrams are given in Figs. 1 and 2. The overall dimensions are:

Maximum length.....	$3\frac{1}{2}$ "
Maximum diameter.....	$1\frac{3}{16}$ "

Mounting—The 313A vacuum tube employs a standard four-pin thrust base suitable for use in a Western Electric 143B or similar socket. The arrangement of electrode connections to the base terminals is shown in Fig. 2.

It may be mounted in either a vertical or horizontal position.

Ratings

Maximum peak control-electrode current.....	30 milliamperes
Maximum average control-electrode current (averaged over 1 second).....	10 milliamperes
Maximum peak reverse current in main gap.....	5 milliamperes

Characteristics

Nominal control gap breakdown voltage	70 volts
Nominal control gap sustaining voltage	60 volts
Nominal main gap breakdown voltage	175 volts
Nominal main gap sustaining voltage	75 volts
Transfer current	5 microamperes (max.)
Nominal deionization time	
Main gap	10 milliseconds
Control gap	3 milliseconds

The "maximum peak control-electrode current" is the maximum value of current which may be drawn from either control electrode when it is acting as a cathode.

The "maximum average control-electrode current" is the maximum value of current (averaged over 1 second) which may be drawn from either control electrode when it is acting as a cathode.

The "maximum peak reverse current in the main gap" is the maximum value of current which may be drawn from the anode in the reverse direction, that is when it is acting as a cathode. The reverse current rating is intended for use in designing rectifier circuits and is the maximum inverse current which it is permissible to draw from the tube in such circuits.

The "control gap breakdown voltage" is the potential required to initiate ionization, thereby starting conduction in the control gap. Once ionization has occurred the potential across the gap will be reduced to the "control gap sustaining voltage" and will be approximately independent of the current. It is this property of the tube which enables it to be used as a voltage regulator.

The "main gap breakdown voltage" is the potential required to start conduction in the main gap when no ionization is occurring in the control gap. After breakdown, conduction will take place at the "main gap sustaining voltage" and will be practically independent of current.

The "main gap sustaining voltage" is substantially independent of current when the current passes through the tube in the forward direction. When the current passes through the main gap in the reverse direction the sustaining voltage increases rapidly with increasing current. It is this asymmetry in the properties of the main gap of the 313A tube which enable it to be used as a rectifier. The current voltage characteristics of the main gap of a typical 313A tube in both forward and reverse directions as shown in Fig. 3. This curve was obtained with a cathode ray oscillograph.

When the anode potential is maintained at a value intermediate between the "main gap breakdown and sustaining voltages" the passage of a small amount of current in the control gap will produce ionization sufficient to initiate conduction in the main gap. It is this property of the tube which enables it to be used as a relay. The amount of current in the control gap required to initiate conduction in the main gap is known as the transfer current. This quantity varies considerably from tube to tube and during the life of a given tube but will in general be less than 5 microamperes and usually only a few tenths of a microampere.

The deionization time is the time during which the voltage must be removed from the tube in order that the discharge shall not be reestablished when the voltage is restored. This time increases with increasing applied voltage and with increasing current through the tube before the deionization period. This rate of increase of deionization time is such that the tube will not deionize with a 60 cycle sine wave main gap voltage if the load is inductive or if the peak voltage is near the main gap breakdown voltage or the current near the maximum rated value.

The "transfer time" is the time during which the control gap must be energized in order that the discharge may transfer to the main gap. It depends upon the amount of current flowing in the control gap and on the main gap voltage. For a control gap current of 10 microamperes the "transfer time" is approximately 200 microseconds.

Typical Circuits

Circuit A shows a circuit using the control gap of the 313A as a voltage regulator.

Circuit B shows a circuit using the 313A as a relay. The anode voltage should be intermediate between the main gap breakdown and sustaining gap voltages and the control anode may be biased at any desired potential less than the control gap sustaining voltage. The resistance R, in the control anode circuit should be of the order of 100,000 ohms. This circuit possesses a "lock-in" feature, since the anode potential must be removed momentarily to restore the tube to a non-conducting condition. When supplied from alternating current this circuit does not possess a "lock-in" feature unless the frequency of the supply voltage is so high that the tube is not allowed a sufficient interval to deionize.

Circuit C shows a circuit using the 313A as a rectifier. The rectifying properties of the main gap are used but the control gap should be connected into the circuit as indicated through a high resistance. This will cause conduction in the forward direction to begin at a voltage much below the main gap breakdown voltage. It is important to note that as a rectifier the 313A tube possesses a unique property not common to other rectifiers in that its impedance is infinite for voltages below the breakdown voltage. In many applications that is of importance since the tube may be used to pass current at the higher potentials without placing a bridge across the line for signals of lower voltage.

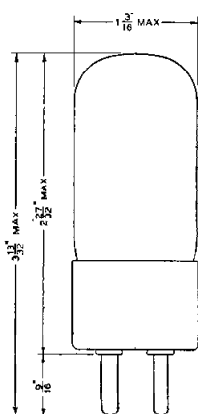
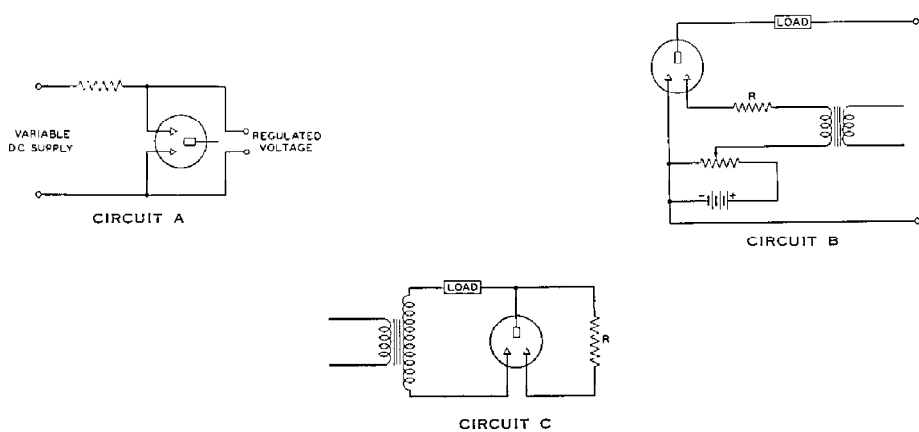

FIG. 1

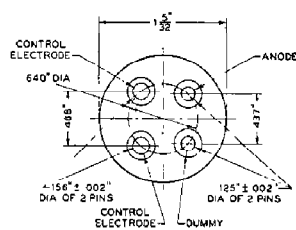

FIG. 2

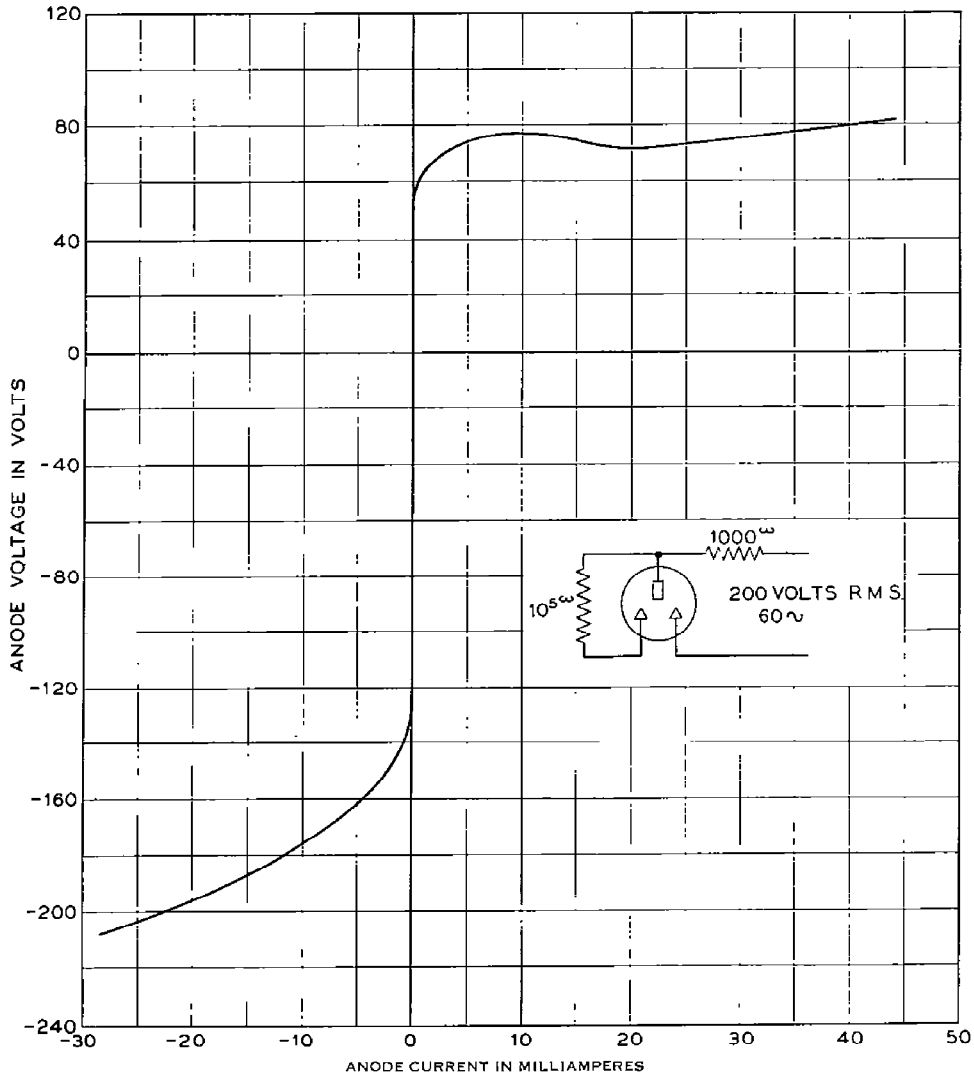
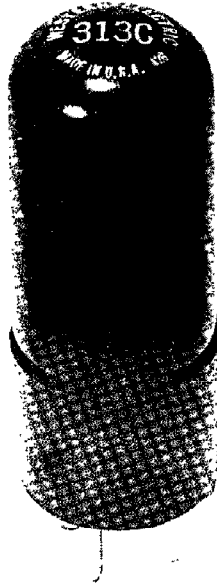

FIG. 3

ELECTRON TUBE DATA SHEET
WESTERN ELECTRIC 313C ELECTRON TUBE



313C

DESCRIPTION

The 313C is a three-electrode, inert-gas-filled, cold cathode tube for use in relay, voltage regulator, or rectifier circuits. This tube is especially suitable for use in control circuits such as in triggering, counting, or switching apparatus.

CHARACTERISTICS

Peak Anode Voltage		185	volts
Average Cathode Current	10	100	milliamperes
Average Life, Approximate	10000	10	hours

File: Cold Cathode Section

MAXIMUM RATINGS, Absolute System (Note 1)

Forward Peak Anode Voltage	185	volts
Forward Cathode Current (Note 2)		
Peak	100	milliamperes
Average	35	milliamperes
Averaging Time	2	seconds
Peak Inverse Anode Current (Note 2)	5	milliamperes
Ambient Temperature Limits	-55 to +85	centigrade

ELECTRICAL DATA, Throughout Life

	<u>Min.</u>	<u>Bogey</u>	<u>Max.</u>	
Starter Breakdown Voltage (Note 3)	62	70	89	volts
Starter Voltage Drop at 20 milliamperes	52	60	74	volts
Anode Voltage Drop at 20 milliamperes	68	75	90	volts
Transfer Current	See Curve - Fig. 1			
Ionization Time - Starter Gap (Note 4)	-	6	-	milliseconds
Deionization Time, Approximate				
Starter Gap	-	3	-	milliseconds
Main Gap	-	10	-	milliseconds
Inverse Current at -120 Volts Anode Potential (Note 5)	-	-	3	milliamperes

MECHANICAL DATA

Mounting Position Any
 Net Weight, Approximate 1 Ounce
 Dimensions and pin connections shown in outline drawing on page 4.

HANDLING

This tube contains a small amount of krypton-85 gas which is a by-product radioactive material. The amount of krypton-85 is less than five microcuries, which is too small an amount to require any special care in use.

Atomic Energy Commission regulations require that the individual tube carton for tubes containing by-product radioactive material be appropriately marked. The marking includes the statement that tube disposal should be in approved manner.

Approved instructions for disposal of tubes containing krypton-85 are as follows:

Tubes to be disposed of should be broken or crushed in a well ventilated place releasing any resulting vapors to the outside atmosphere. The residual broken or crushed tubes should be disposed of in a normal public trash disposal system. Tubes should be disposed of at a rate of not more than 100 each week from any one location. Avoid breathing vapors from broken tubes.

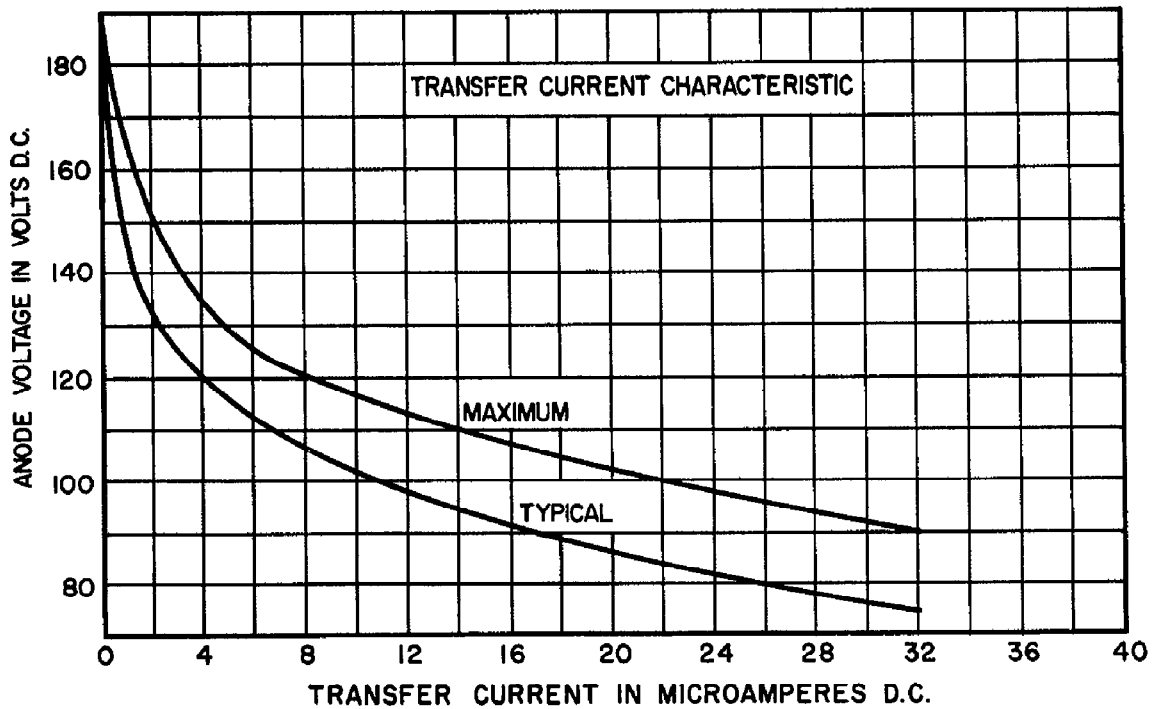

FIG.1

- Note 1: In the "Absolute System" the maximum ratings specified are limiting values above which the serviceability of the device may be impaired from the viewpoint of life and satisfactory performance. Maximum ratings, as such, do not constitute a set of operating conditions and all values may not, therefore, be attained simultaneously.
- Note 2: Sufficient resistance must be used in series with the tube to assure that the electrode currents do not exceed the maximum rated values.
- Note 3: Limits apply immediately after tube has conducted current. If tube has been idle, these values initially may be as much as 3 volts higher or lower.
- Note 4: With 15 volts overvoltage (15 volts above starter breakdown voltage) with tube in total darkness.
- Note 5: Negative anode voltage applied through 8000 ohms. Starter connected to anode through 100,000 ohms.

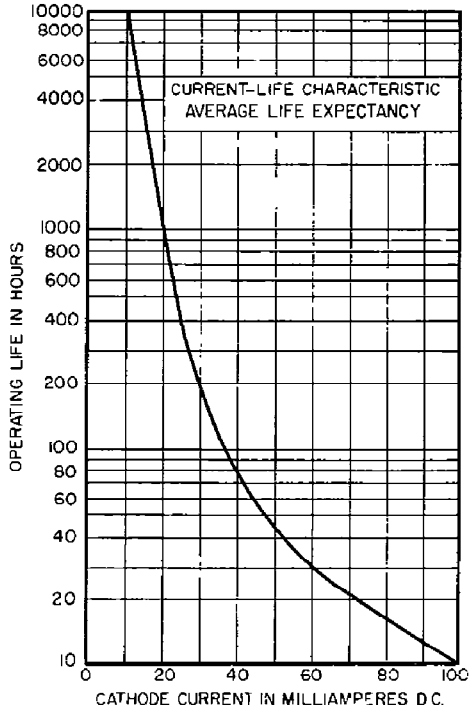

FIG 2

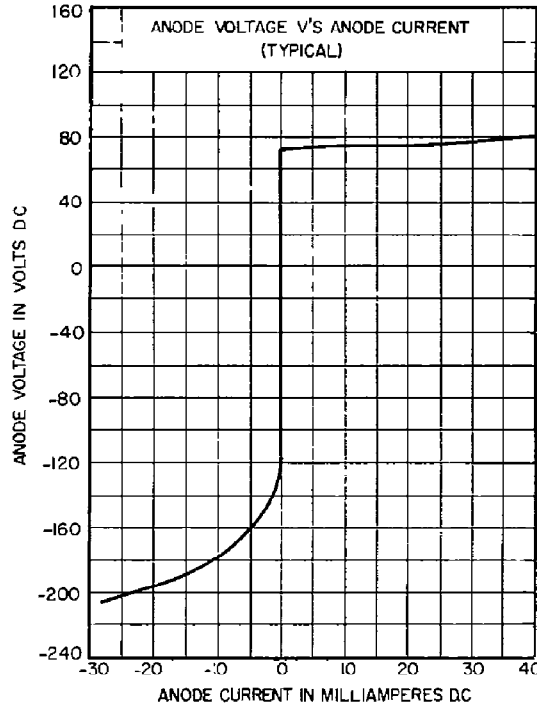
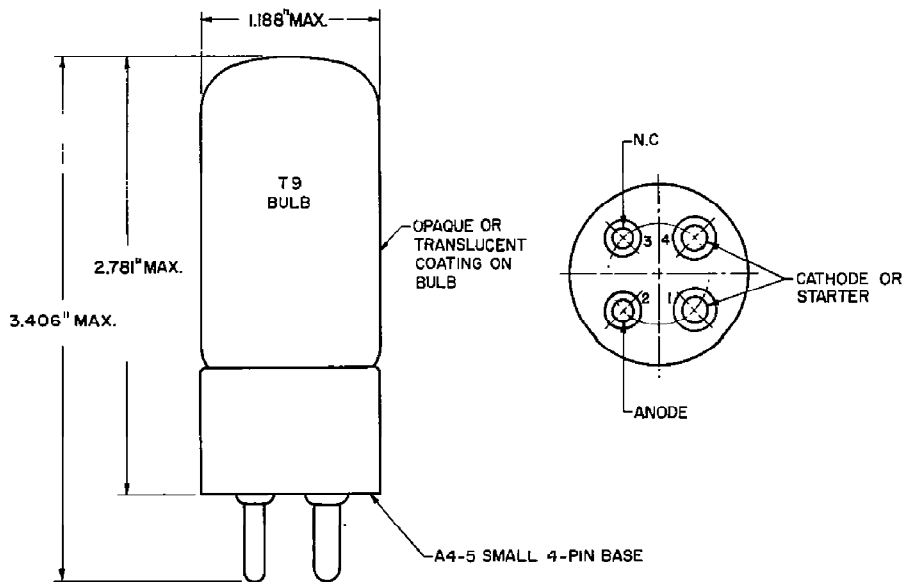

FIG 3



A development of Bell Telephone Laboratories, the research laboratories of the American Telephone and Telegraph Company and the Western Electric Company.

PRINTED IN U.S.A.

ELECTRON TUBE DATA SHEET
WESTERN ELECTRIC 313CA ELECTRON TUBE



313CA

DESCRIPTION

The 313CA is a three-electrode, inert-gas-filled, cold cathode tube for use in relay, voltage regulator, or rectifier circuits. This tube is especially suitable for use in control circuits such as in triggering, counting, or switching apparatus.

CHARACTERISTICS

Peak Anode Voltage	200	volts
Average Cathode Current	7	72 milliamperes
Average Life, Approximate	10000	10 hours

File: Cold Cathode Section

MAXIMUM RATINGS, Absolute System (Note 1)

Forward Peak Anode Voltage	200	volts
Forward Cathode Current (Note 2)		
Peak	72	milliamperes
Average	25	milliamperes
Averaging Time	2	seconds
Peak Inverse Anode Current (Note 2)	5	milliamperes
Ambient Temperature Limits	-55 to +85	centigrade

ELECTRICAL DATA, Throughout Life

	<u>Min.</u>	<u>Bogey</u>	<u>Max.</u>	
Starter Breakdown Voltage (Note 3)	66	72	78	volts
Starter Voltage Drop at 20 milliamperes	52	60	74	volts
Anode Voltage Drop at 20 milliamperes	68	75	88	volts
Transfer Current	See curve - Fig. 1			
Ionization Time - Starter Gap (Note 4)	-	6	-	milliseconds
Deionization Time, Approximate				
Starter Gap	-	3	-	milliseconds
Main Gap	-	10	-	milliseconds
Inverse Current at -120 Volts Anode Potential (Note 5)	-	-	3	milliamperes

MECHANICAL DATA

Mounting Position Any
 Net Weight, Approximate 1 Ounce
 Dimensions and Pin Connections shown in outline drawing on page 4.

HANDLING

This tube contains a small amount of krypton-85 gas which is a by-product radioactive material. The amount of krypton-85 is less than five microcuries, which is too small an amount to require any special care in use.

Atomic Energy Commission regulations require that the individual tube carton for tubes containing by-product radioactive material be appropriately marked. The marking includes the statement that tube disposal should be in approved manner.

Approved instructions for disposal of tubes containing krypton-85 are as follows:

Tubes to be disposed of should be broken or crushed in a well ventilated place releasing any resulting vapors to the outside atmosphere. The residual broken or crushed tubes should be disposed of in a normal public trash disposal system. Tubes should be disposed of at a rate of not more than 100 each week from any one location. Avoid breathing vapors from broken tubes.

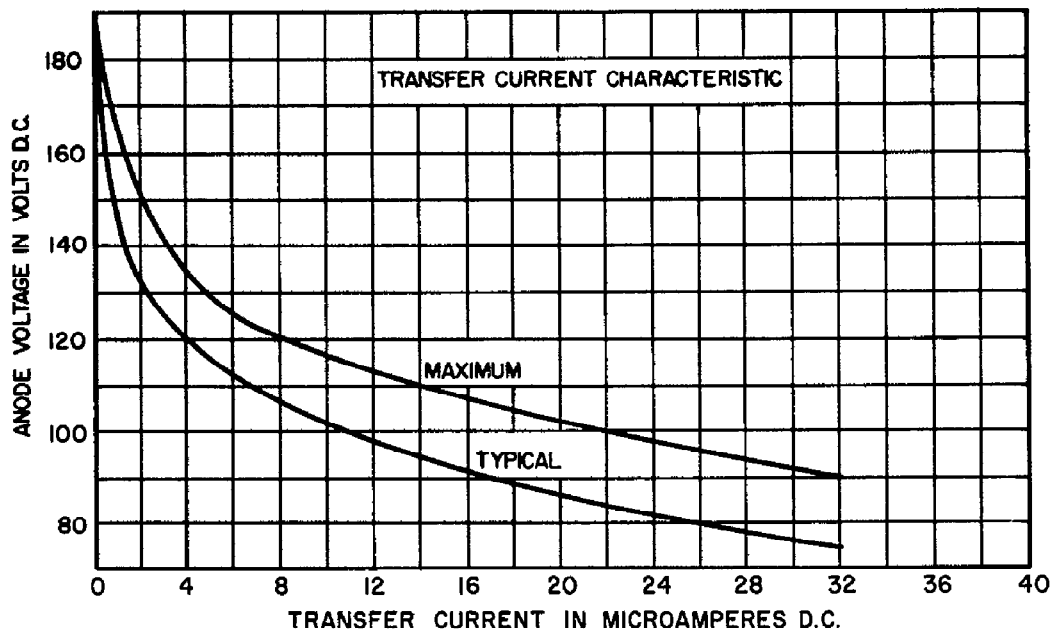
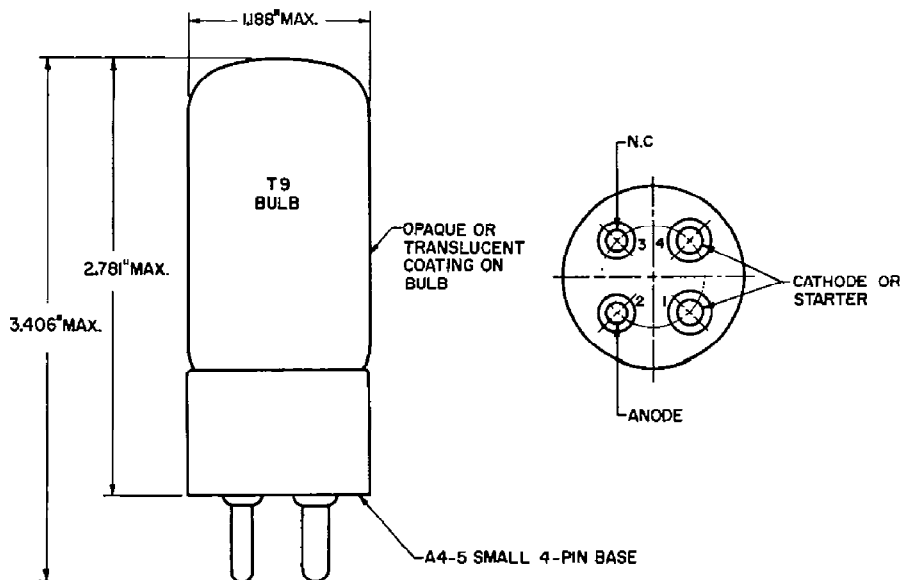
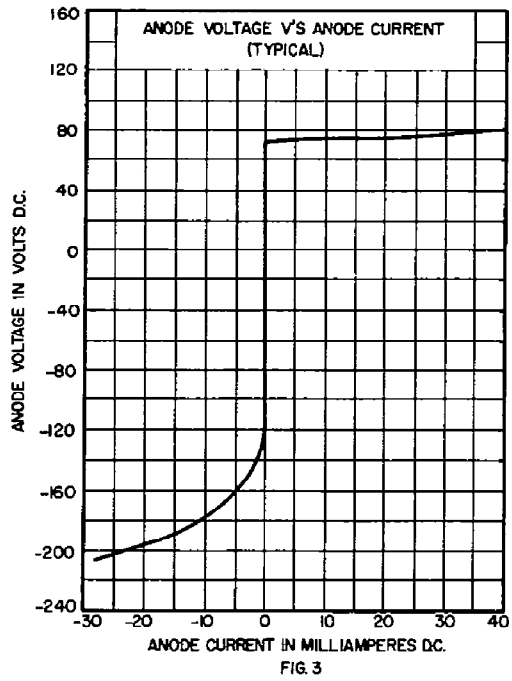
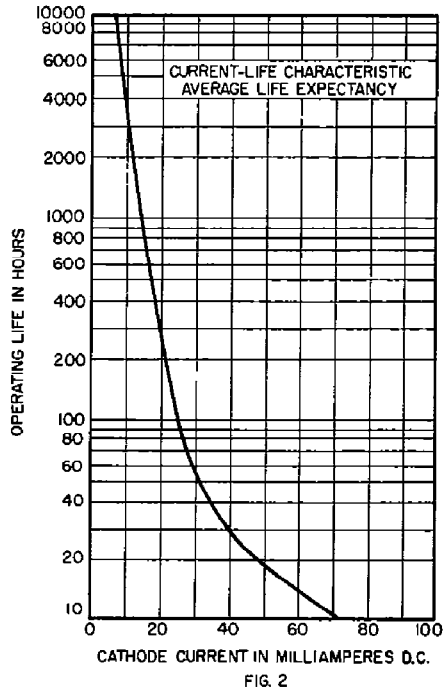

FIG.1

- Note 1: In the "Absolute System" the maximum ratings specified are limiting values above which the serviceability of the device may be impaired from the viewpoint of life and satisfactory performance. Maximum ratings, as such, do not constitute a set of operating conditions and all values may not, therefore, be attained simultaneously.
- Note 2: Sufficient resistance must be used in series with the tube to assure that the electrode currents do not exceed the maximum rated values.
- Note 3: Limits apply immediately after tube has conducted current. If tube has been idle, these values initially may be as much as 3 volts higher or lower.
- Note 4: With 15 volts overvoltage (15 volts above starter breakdown voltage) with tube in total darkness.
- Note 5: Negative anode voltage applied through 8000 ohms. Starter connected to anode through 100,000 ohms.



A development of Bell Telephone Laboratories, the research laboratories of the American Telephone and Telegraph Company and the Western Electric Company.

PRINTED IN U.S.A.

ELECTRON TUBE DATA SHEET
WESTERN ELECTRIC 313CB ELECTRON TUBE

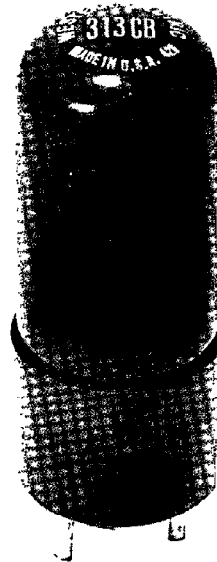

313CB

DESCRIPTION

The 313CB is a three-electrode, inert-gas-filled, cold cathode tube for use in relay, voltage regulator, or rectifier circuits. This tube is especially suitable for use in control circuits such as in triggering, counting, or switching apparatus.

CHARACTERISTICS

Peak Anode Voltage	170	volts
Average Cathode Current	7	72 milliamperes
Average Life, Approximate	10000	10 hours

File: Cold Cathode Section

MAXIMUM RATINGS, Absolute System (Note 1)

Forward Peak Anode Voltage	170	volts
Forward Cathode Current (Note 2)		
Peak	72	milliamperes
Average	25	milliamperes
Averaging Time	2	seconds
Peak Inverse Anode Current (Note 2).	5	milliamperes
Ambient Temperature Limits	-55 to +85	centigrade

ELECTRICAL DATA, Throughout Life

	<u>Min.</u>	<u>Bogey</u>	<u>Max.</u>	
Starter Breakdown Voltage (Note 3)	62	70	89	volts
Starter Voltage Drop at 20 milliamperes	52	60	74	volts
Anode Voltage Drop at 20 milliamperes	71	76	81	volts
Transfer Current	See Curve - Fig. 1			
Ionization Time - Starter Gap (Note 4).	-	6	-	milliseconds
Deionization Time, Approximate				
Starter Gap	-	3	-	milliseconds
Main Gap	-	10	-	milliseconds
Inverse Current at -120 Volts Anode Potential (Note 5)	-	-	2	milliamperes

MECHANICAL DATA

Mounting Position Any
 Net Weight, Approximate 1 Ounce
 Dimensions and pin connections shown in outline drawing on Page 4.

HANDLING

This tube contains a small amount of krypton-85 gas which is a by-product radioactive material. The amount of krypton-85 is less than five microcuries, which is too small an amount to require any special care in use.

Atomic Energy Commission regulations require that the individual tube carton for tubes containing by-product radioactive material be appropriately marked. The marking includes the statement that tube disposal should be in approved manner.

Approved instructions for disposal of tubes containing krypton-85 are as follows;

Tubes to be disposed of should be broken or crushed in a well ventilated place releasing any resulting vapors to the outside atmosphere. The residual broken or crushed tubes should be disposed of in a normal public trash disposal system. Tubes should be disposed of at a rate of not more than 100 each week from any one location. Avoid breathing vapors from broken tubes.

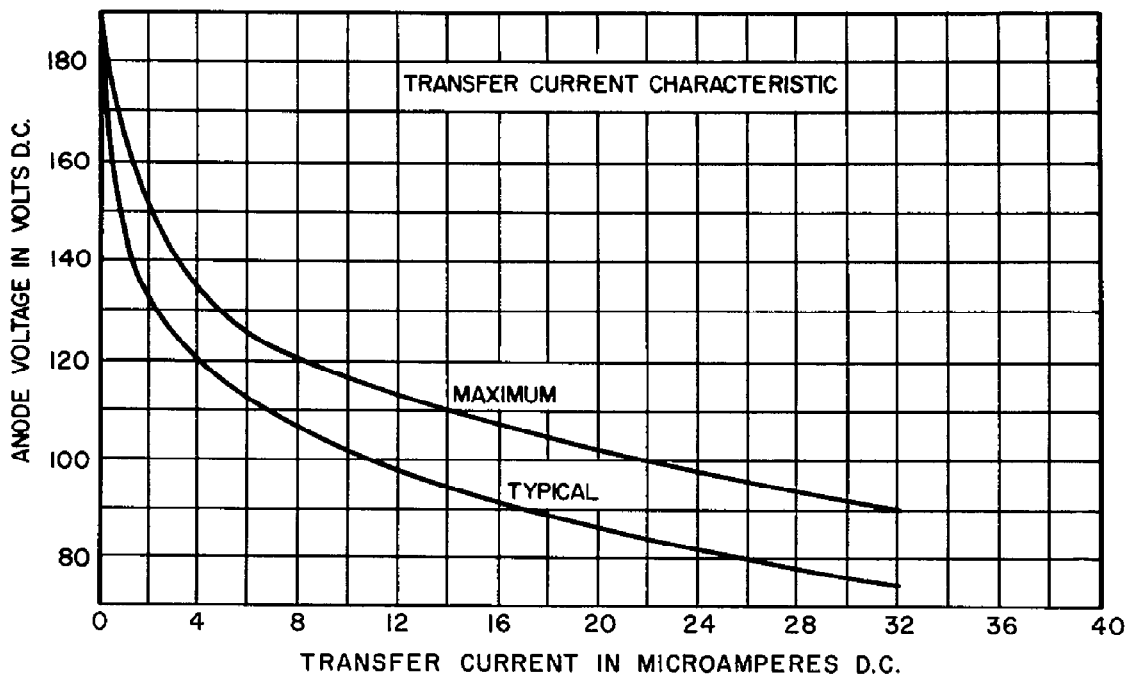
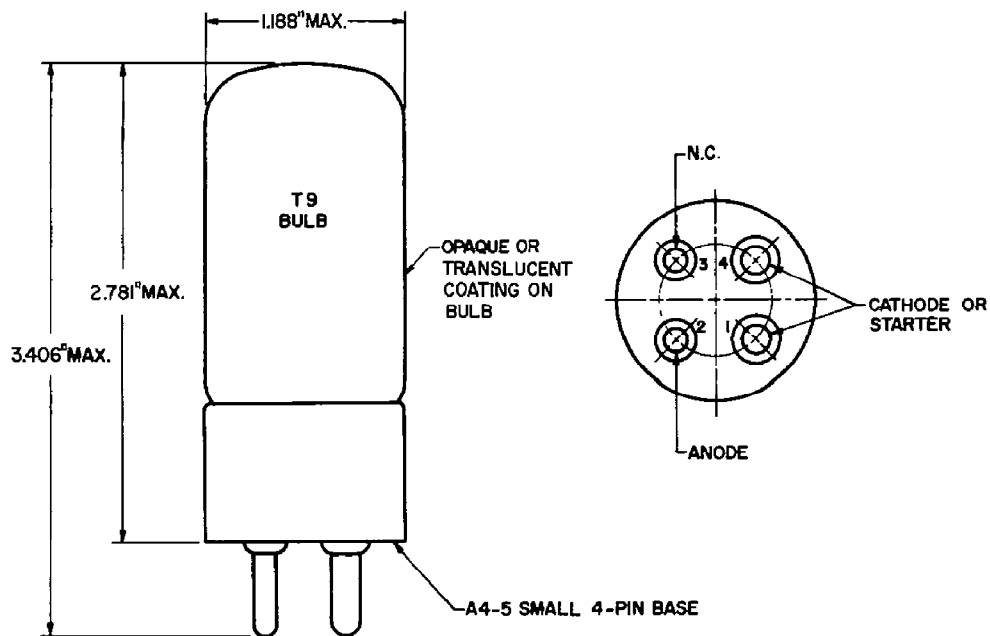
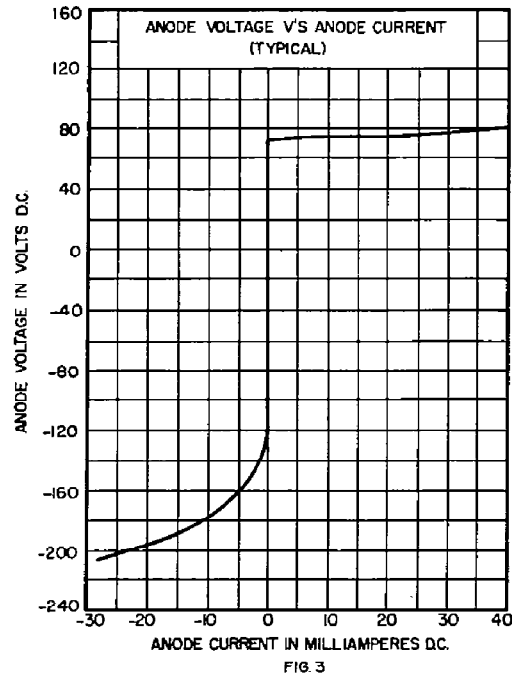
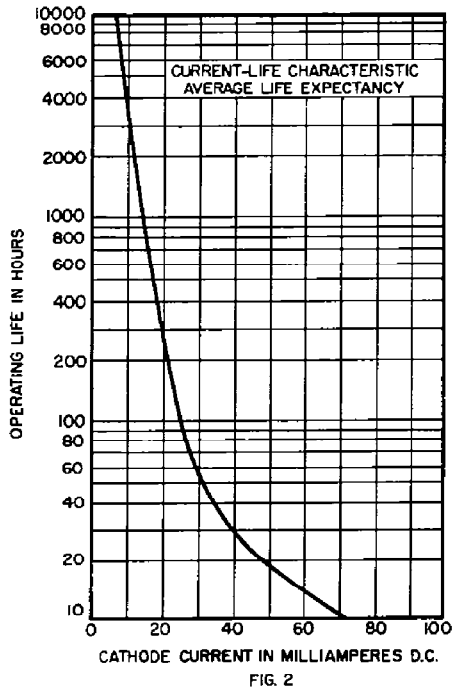

FIG.1

- Note 1: In the "Absolute System" the maximum ratings specified are limiting values above which the serviceability of the device may be impaired from the viewpoint of life and satisfactory performance. Maximum ratings, as such, do not constitute a set of operating conditions and all values may not, therefore, be attained simultaneously.
- Note 2: Sufficient resistance must be used in series with the tube to assure that the electrode currents do not exceed the maximum rated values.
- Note 3: Limits apply immediately after tube has conducted current. If tube has been idle, these values initially may be as much as 3 volts higher or lower.
- Note 4: With 15 volts overvoltage (15 volts above starter breakdown voltage) with tube in total darkness.
- Note 5: Negative anode voltage applied through 8000 ohms. Starter connected to anode through 100,000 ohms.



A development of Bell Telephone Laboratories, the research laboratories of the American Telephone and Telegraph Company and the Western Electric Company.

PRINTED IN U.S.A.

ELECTRON TUBE DATA SHEET
WESTERN ELECTRIC 313CC ELECTRON TUBE

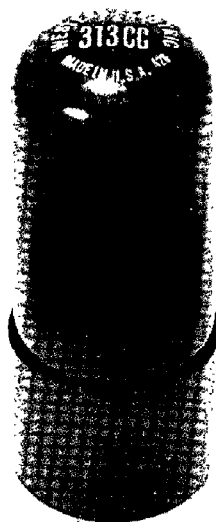

313CC

DESCRIPTION

The 313CC is a three-electrode, inert-gas-filled, cold cathode tube for use in relay, voltage regulator, or rectifier circuits. This tube is especially suitable for use in control circuits such as in triggering, counting, or switching apparatus.

CHARACTERISTICS

Peak Anode Voltage		150	volts
Average Cathode Current	7	72	milliamperes
Average Life, Approximate	10000	10	hours

File: Cold Cathode Section

MAXIMUM RATINGS, Absolute System (Note 1)

Forward Peak Anode Voltage	150	volts
Forward Cathode Current (Note 2)		
Peak	72	milliamperes
Average	25	milliamperes
Averaging Time	2	seconds
Peak Inverse Anode Current (Note 2)	5	milliamperes
Ambient Temperature Limits	-55 to +85	centigrade

ELECTRICAL DATA, Throughout Life

	<u>Min.</u>	<u>Bogey</u>	<u>Max.</u>	
Starter Breakdown Voltage (Note 3)	66	72	78	volts
Starter Voltage Drop at 20 milliamperes	52	60	74	volts
Anode Voltage Drop at 20 milliamperes	68	75	88	volts
Transfer Current	See Curve - Fig. 1			
Ionization Time - Starter Gap (Note 4)	-	6	-	milliseconds
Deionization Time, Approximate				
Starter Gap	-	3	-	milliseconds
Main Gap	-	10	-	milliseconds
Inverse Current at -120 volts Anode Potential (Note 5)	-	-	3	milliamperes

MECHANICAL DATA

Mounting Position Any
 Net Weight, Approximate 1 Ounce
 Dimensions and pin connections shown in outline drawing on Page 4.

HANDLING

This tube contains a small amount of krypton-85 gas which is a by-product radioactive material. The amount of krypton-85 is less than five microcuries, which is too small an amount to require any special care in use.

Atomic Energy Commission regulations require that the individual tube carton for tubes containing by-product radioactive material be appropriately marked. The marking includes the statement that tube disposal should be in approved manner.

Approved instructions for disposal of tubes containing krypton-85 are as follows;

Tubes to be disposed of should be broken or crushed in a well ventilated place releasing any resulting vapors to the outside atmosphere. The residual broken or crushed tubes should be disposed of in a normal public trash disposal system. Tubes should be disposed of at a rate of not more than 100 each week from any one location. Avoid breathing vapors from broken tubes.

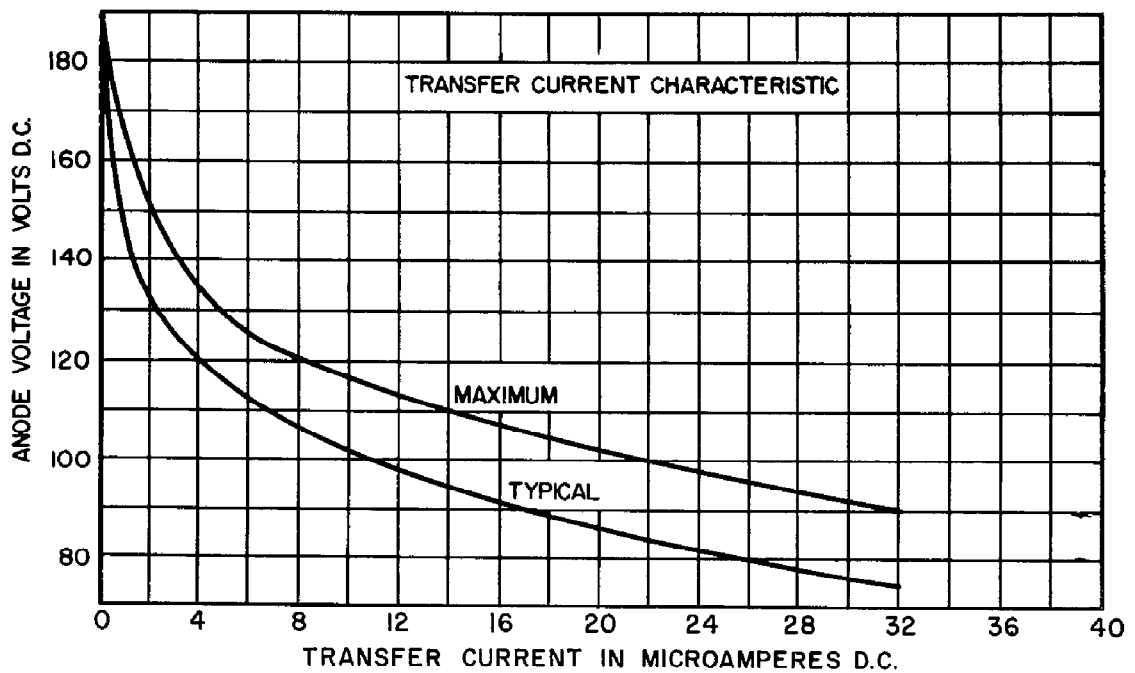

FIG.1

- Note 1: In the "Absolute System" the maximum ratings specified are limiting values above which the serviceability of the device may be impaired from the viewpoint of life and satisfactory performance. Maximum ratings, as such, do not constitute a set of operating conditions and all values may not, therefore, be attained simultaneously.
- Note 2: Sufficient resistance must be used in series with the tube to assure that the electrode currents do not exceed the maximum rated values.
- Note 3: Limits apply immediately after tube has conducted current. If tube has been idle, these values initially may be as much as 3 volts higher or lower.
- Note 4: With 15 volts overvoltage (15 volts above starter breakdown voltage) with tube in total darkness.
- Note 5: Negative anode voltage applied through 8000 ohms. Starter connected to anode through 100,000 ohms.

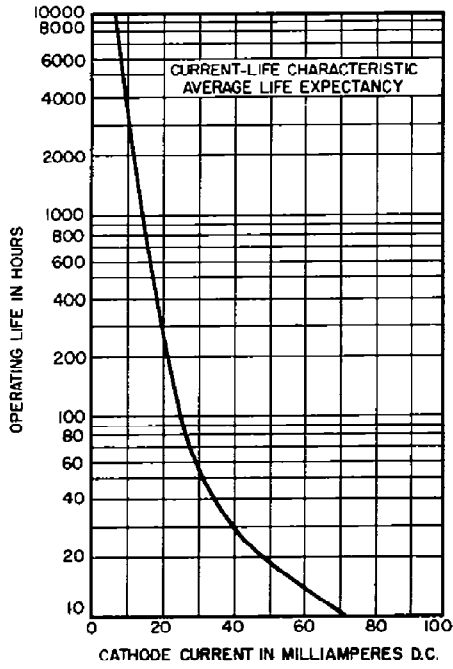

FIG. 2

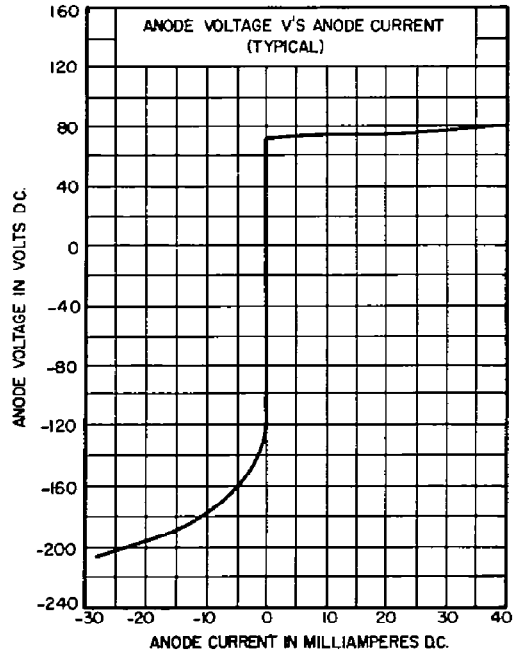
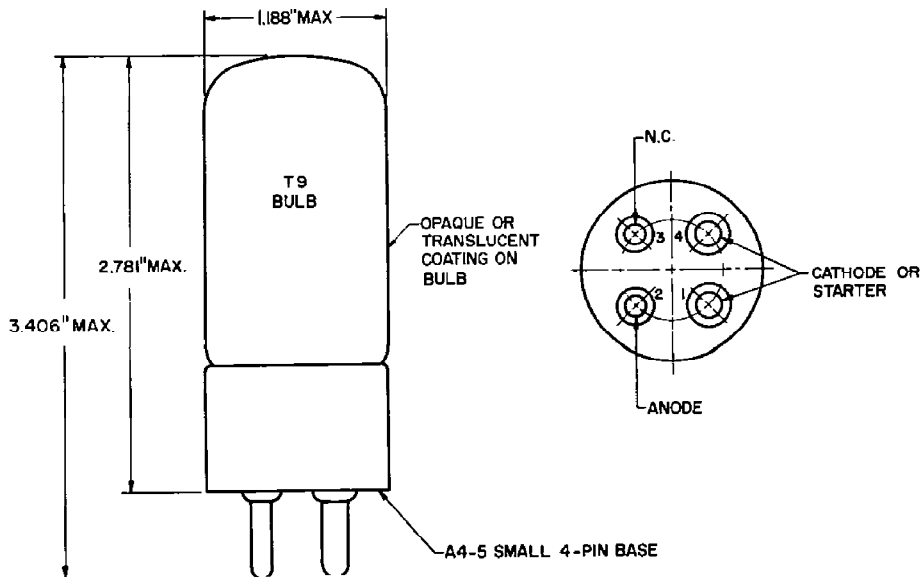
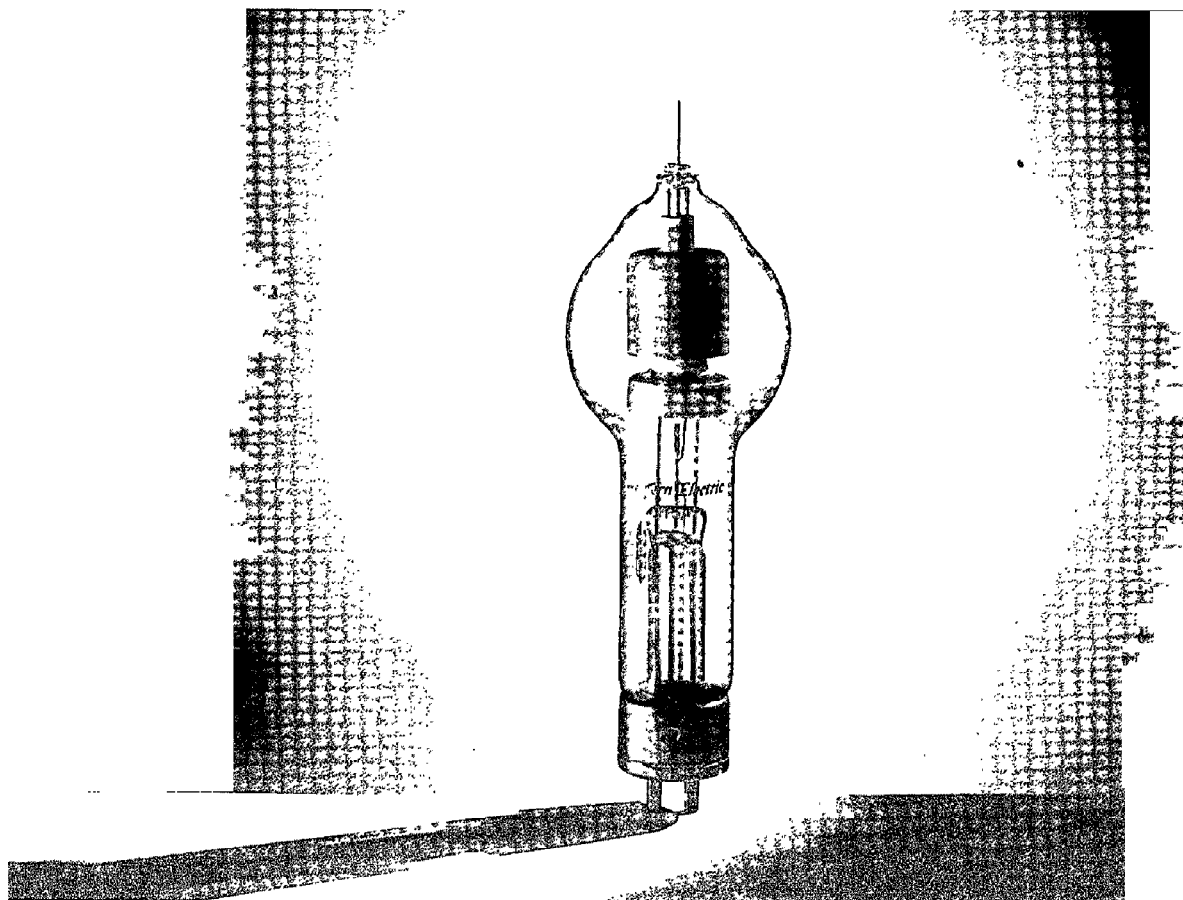

FIG. 3



A development of Bell Telephone Laboratories, the research laboratories of the American Telephone and Telegraph Company and the Western Electric Company.

PRINTED IN U.S.A.



**RECTIFIER
HALF-WAVE, MERCURY-VAPOR**

Western Electric

DESCRIPTION

The 315A is a half-wave, mercury-vapor rectifier tube for use in high-voltage rectifier circuits.

MAXIMUM RATINGS

Peak Inverse Anode Voltage 12500 volts
Average Cathode Current (Quadrature Operation) 2 amperes

MAXIMUM RATINGS, ABSOLUTE VALUES

Peak Inverse Anode Voltage for		
Condensed Mercury Temperature 20 to 55 C	12500 volts	
Condensed Mercury Temperature 20 to 65 C	7500 volts	
Cathode Current		
Peak		
In-phase Operation	4 amperes	
Quadrature Operation.	8 amperes	
Average		
In-phase Operation	1 ampere	
Quadrature Operation.	2 amperes	
Surge (maximum duration 0.1 second)	40 amperes	
Averaging Time	15 seconds	
Frequency	150 cycles/sec.	

ELECTRICAL DATA

	Min.	Bogey	Max.	
Filament Voltage	4.75	5.0	5.25	volts
Filament Current at 5 Volts		10	11.5	amperes
Cathode Heating Time, Required	30			seconds
Anode Voltage Drop		15		volts
Critical Anode Voltage			100	volts

MECHANICAL DATA

Net Weight, Approximate	10 ounces
Equilibrium Condensed Mercury Temperature Rise	
At Full Load, Approximate	18 centigrade
At No Load, Approximate	15 centigrade
Cooling	Convection
Mounting	This tube should be mounted in a vertical position only, with the base end down. Sufficient clearance should be maintained around the tube to insure free air circulation.

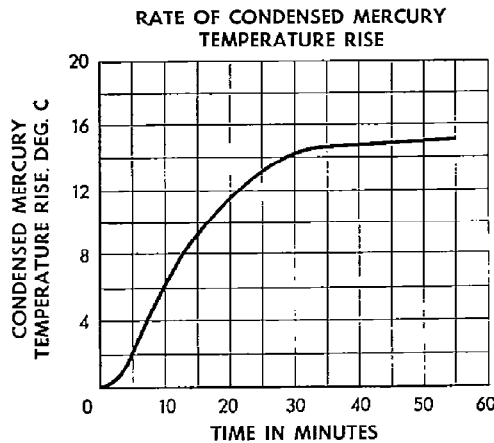

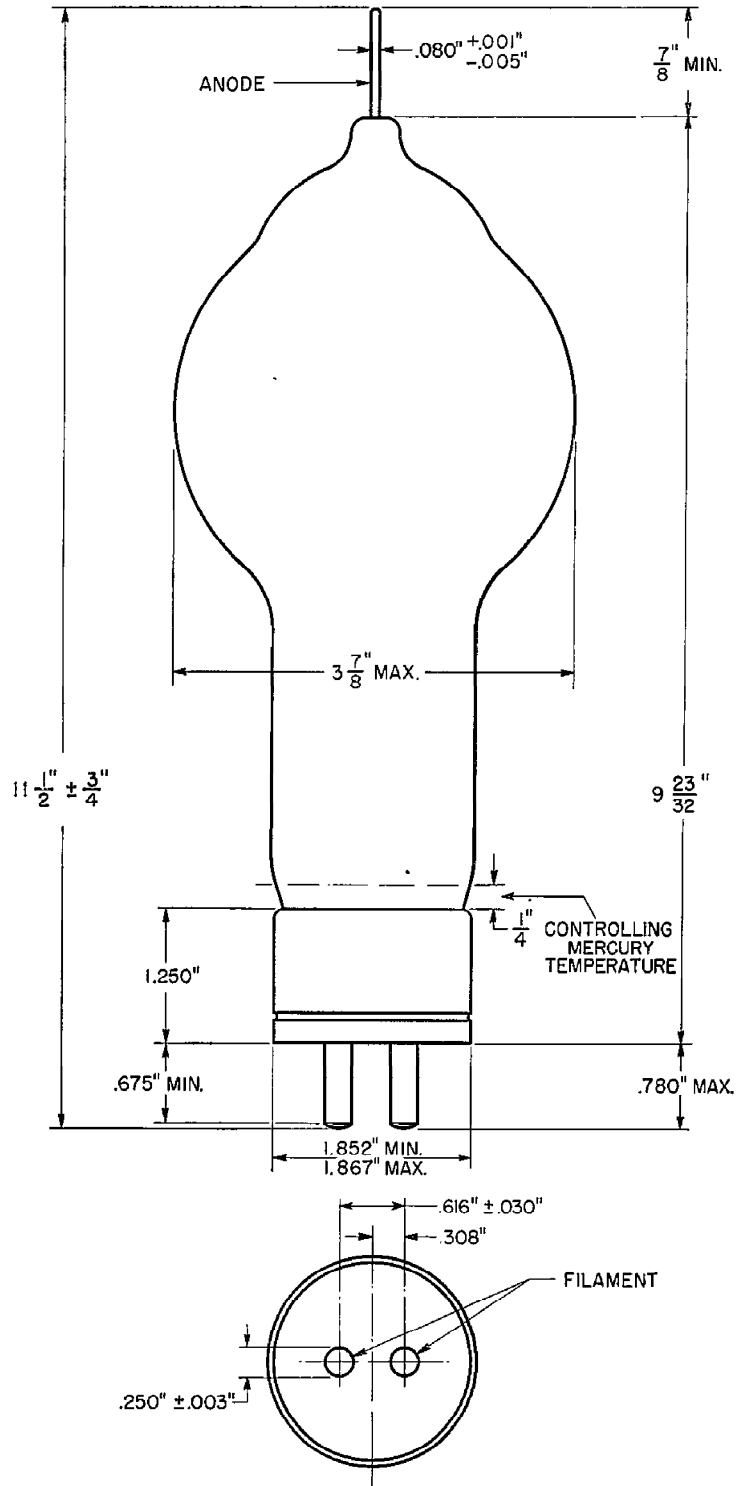

ELECTRON TUBE DATA SHEET
WESTERN ELECTRIC 323B ELECTRON TUBE

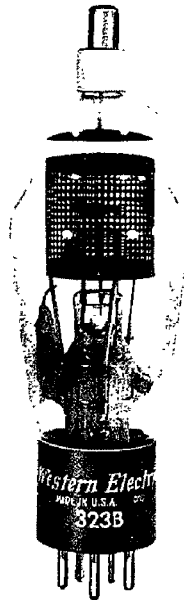

ONLY

323B

DESCRIPTION

The 323B is a three-electrode mercury-vapor and gas-filled thyatron with a negative control characteristic. This tube is designed for use in regulated or controlled rectifiers.

MAXIMUM RATINGS

Peak Anode Voltage	1250 volts
Average Cathode Current	1.5 amperes

FILE: THYRATRON SECTION

MAXIMUM RATINGS, Absolute Values

Peak Anode Voltage	
Inverse	1250 volts
Forward	1250 volts
Cathode Current	
Peak	6 amperes
Average	1.5 amperes
Surge (maximum duration 0.1 second)	120 amperes
Averaging Time	5 seconds
Negative Grid Voltage	
Before Conduction	500 volts
During Conduction	10 volts
Positive Grid Current, Average (averaging time - one cycle)010 amperes
Condensed Mercury Temperature Limits ¹	-55 to + 80 centigrade

ELECTRICAL DATA

	<u>Min.</u>	<u>Bogey</u>	<u>Max.</u>
Filament Voltage	2.37	2.5	2.62 volts
Filament Current at 2.5 Volts	---	7.0	7.75 amperes
Filament Heating Time Required	15	---	--- seconds
Anode to Grid Capacitance	---	1.8	--- uuf
Grid to Filament Capacitance	---	5.0	--- uuf
Deionization Time, Approximate ²			
E _{bb} =1250 volts; T _{Hg} =80C; I _b =6 amperes;			
E _{cc} =-18 volts; R _g =20,000 ohms	---	1200	--- microseconds
Ionization Time, Approximate ³			
E _{bb} =100 volts; T _{Hg} =40C; grid overvoltage=5 volts	---	35	--- microseconds
E _{bb} =100 volts; T _{Hg} =80C; grid overvoltage=25 volts	---	0.5	--- microsecond
Anode Voltage Drop	---	15	--- volts
Critical Grid Current at 220 Anode Volts	---	---	5 microamperes
Change in Critical Grid Voltage at			
500 Anode Volts from +20 to +80T _{Hg}	---	0.2	--- volt

MECHANICAL DATA

Type of Cooling	Convection
Equilibrium Condensed Mercury Temperature	
Rise above Ambient, Approximate	
At Full Load	30 centigrade
At No Load	20 centigrade
Mounting Position	Vertical-base down
Net Weight, Approximate	3 ounces

Dimensions and pin connections shown in outline drawing on Page 4

1. For starting conditions only. Equilibrium operation is limited to +20° minimum condensed mercury temperature.
2. Deionization time decreases with an increase in negative grid voltage or with a decrease in (a) condensed mercury temperature (T_{Hg}), (b) grid resistance or (c) anode current immediately preceding the end of conduction.
3. Ionization time decreases with an increase in (a) anode voltage, (b) condensed mercury temperature (T_{Hg}) or (c) grid overvoltage. Grid overvoltage is defined as the magnitude by which the applied voltage exceeds, in a positive direction, the critical grid voltage value. Critical grid voltage is the instantaneous value of grid voltage at the time when anode current starts to flow.

TYPICAL CONTROL CHARACTERISTICS.
 SHADED AREA SHOWS RANGE OF CHARACTERISTICS, CONDENSED MERCURY TEMPERATURE -55°C . TO $+80^{\circ}\text{C}$.

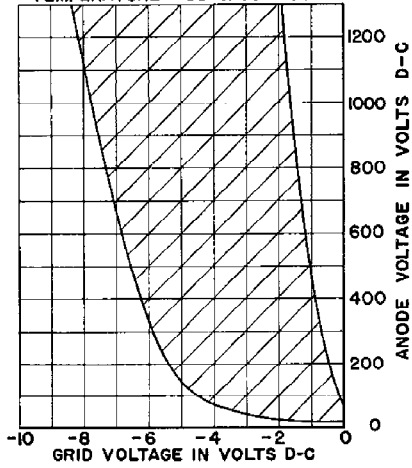

TYPICAL GRID CURRENT CHARACTERISTICS DURING ANODE CONDUCTION

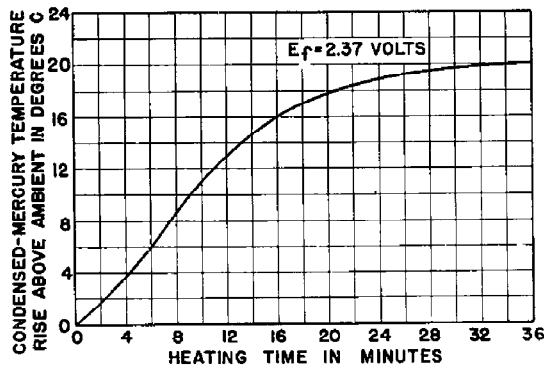
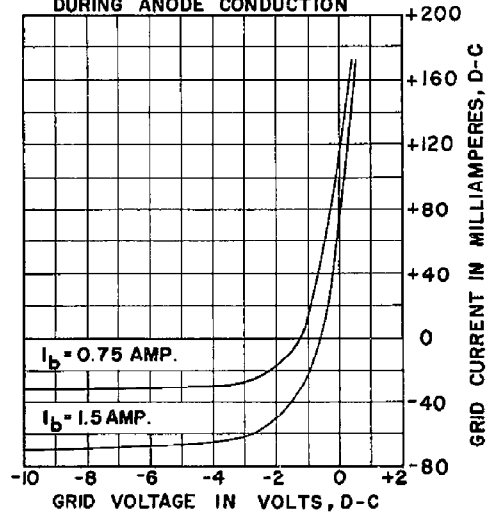

Western Electric

327A Vacuum Tube

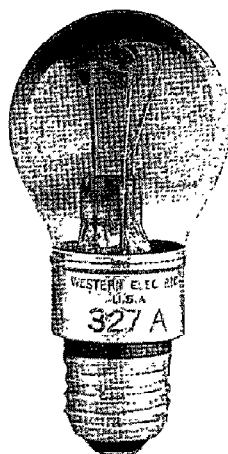

Classification—Half-wave, tungsten filament, argon filled rectifier.

The 327A vacuum tube is designed to supply direct current from an alternating-current supply in power systems for battery charging and for other purposes.

Dimensions—The dimensions and outline diagram are given in Figure 1. The overall dimensions are:

Maximum length.	4 $\frac{7}{16}$ "
Maximum diameter.	2 $\frac{1}{4}$ "

Mounting—This tube employs a 3 connection, skirted medium screw base. Overall dimensions are shown in Figure 1.

The tube may be mounted either in a vertical or a horizontal position. There should be a free circulation of air around the tube. No object should touch the glass bulb.

Filament Rating

Filament voltage	2.0 volts
Nominal filament current.	12 amperes

The filament of this tube is designed to operate on a voltage basis from an alternating-current supply. The voltage should be maintained to within 10% of its rated value (2.0 volts). Operation of the filament outside of these limits may cause the tube to become inoperative. Filament and plate voltage may be applied to the tube simultaneously.

Characteristic and Operating Conditions

Approximate anode-cathode potential drop	8 volts
Ignition voltage at 60 cycles	7-16 volts, r-m-s
Maximum peak plate current	6.0 amperes
Maximum average plate current	2.0 amperes
Maximum peak inverse potential	275 volts

The anode-cathode potential drop is substantially independent of the plate current. The exact value may vary from tube to tube and during the life of a given tube over the range from 5 to 10 volts.

The ignition voltage is the voltage required to start conduction within the tube. In a-c. circuits this is a function of frequency, increasing as the frequency increases. The values are given for 60 cycles since this frequency will be most generally encountered in circuit design.

The maximum permissible peak plate current (6 amperes) is a limitation on the instantaneous value that the tube can carry safely in the direction in which it is designed to conduct and should not be exceeded. The maximum average load current (2 amperes) is the maximum direct output current which may be obtained from a half-wave circuit using one tube. A full-wave circuit using two tubes will supply a maximum of 4 amperes.

The maximum permissible peak inverse potential (275 volts) is a limitation on the instantaneous value that the tube can stand safely. If it is exceeded, an arc-back may result which may injure the tube. All circuits should be adequately fused to prevent injury to the equipment in event of arc-back due to line surges. The maximum output voltage obtainable in either the half-wave or full-wave circuit is approximately 75 volts.

327A vacuum tubes may be operated in parallel if some provision is made to insure a proper division of the load current. Current dividing reactors or ballasting resistors in series with each anode, may be used for this purpose. The size of the reactors or resistors depends upon the circuit design.

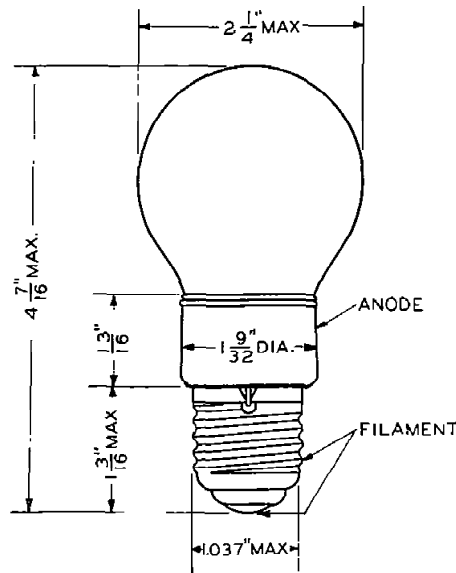

FIG. 1

A development of Bell Telephone Laboratories, Incorporated, the research laboratories of the American Telephone and Telegraph Company and the Western Electric Company

V. T. DATA SHEET 327A
ISSUE 1

PRINTED IN U.S.A.

Western Electric

328A Vacuum Tube

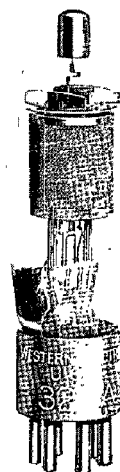

Classification—Voltage-amplifier, suppressor-grid pentode with indirectly heated cathode

The electrical characteristics of the 328A tube are identical with those of the 310A tube except for the heater voltage and current.

This tube is intended primarily for use in audio, carrier and radio-frequency voltage amplifiers, oscillators or modulators. The connection for the suppressor grid has been brought out to an external terminal, thus making the tube more flexible in its applications.

Dimensions—Dimensions, outline diagrams of the tube and base, and the arrangement of the electrode connections to the base terminals are shown in Figures 1 and 2.

Base—Small, six-pin thrust type with pins silver-plated. A small, metal cap control grid terminal is located at the top of the bulb.

Socket—Standard, six-contact type, preferably provided with silver-plated contacts such as the Western Electric 144B socket.

Mounting Positions—This tube may be mounted in any position.

Average Direct Interelectrode Capacitances

	A	B
Control grid to plate	0.025	0.007 $\mu\text{f.}$
Suppressor grid to plate	12.5	12.5 $\mu\text{f.}$
Plate to heater, cathode and screen grid	2.2	3.2 $\mu\text{f.}$
Control grid to suppressor grid	1.8	1.3 $\mu\text{f.}$
Control grid to heater, cathode and screen grid	4.0	6.5 $\mu\text{f.}$
Suppressor grid to heater, cathode and screen grid	7.5	14.5 $\mu\text{f.}$

Column A—Without shield.

Column B—With close-fitting metal shield connected to cathode.

Heater Rating

Heater voltage	7.5 volts, a.c. or d.c.
Nominal heater current	0.425 ampere

The heater element of this tube is designed to operate on a voltage basis and should be operated at as near the rated voltage as is practicable.

Cathode Connection—Preferably direct to the heater. If voltage must be applied between the cathode and heater, it should not exceed 150 volts.

Characteristics—Plate current and screen-grid current characteristics of a typical 328A tube are shown in Figures 3 and 4, respectively, as functions of control-grid voltage for several values of screen-grid and plate voltage and zero suppressor-grid voltage. The screen-grid voltage for these characteristics is equal to the plate voltage. Corresponding amplification factor, plate resistance, and transconductance characteristics are given in Figures 5, 6 and 7. Plate current and screen-grid current characteristics as functions of plate voltage are given in Figures 8 and 9, respectively, for several values of control-grid voltage, a screen-grid voltage of 135 volts, and zero suppressor-grid voltage. Corresponding amplification factor, plate resistance, and transconductance characteristics are shown in Figures 10, 11 and 12. Plate current, screen-grid current, plate resistance, and transconductance characteristics are shown in Figures 13, 14, 15 and 16 as functions of plate voltage for several values of suppressor-grid voltage, a screen-grid voltage of 135 volts, and a control-grid voltage of -3 volts. These last characteristics are of particular interest in modulator applications where separate inputs are applied to the control and suppressor grids.

Limiting Conditions for Safe Operation

Maximum plate voltage	250 volts
Maximum screen-grid voltage	180 volts
Maximum cathode current (screen-grid current plus plate current)	10 milliamperes
Maximum screen-grid current	2.5 milliamperes

Operating Conditions and Output—Nominal performance data are given in the table below for a number of typical operating conditions. Less severe operating conditions should be selected in preference to maximum operating conditions wherever possible. The life of the tube at maximum conditions may be shorter than at less severe conditions.

The performance data include the fundamental voltage or power output for the indicated values of load resistance and input voltage, and the maximum second and third harmonic levels for input voltages no greater than the indicated values. The voltage output is given in peak volts, the power output in milliwatts, and the harmonic levels in decibels below the fundamental.

TABLE

Plate Voltage Volts	Screen-Grid Voltage Volts	Control-Grid Bias Volts	Suppressor-Grid Voltage Volts	Plate Current Milli-amperes	Load Resistance Ohms	Input Voltage Peak Volts	Output Voltage Peak Volts	Output Power Milli-watts	Second Harmonic db	Third Harmonic db
135	135	-3	0	5.4	20,000	3.00		250	22	30
					60,000	1.60		130	26	28
					60,000	0.95		60	35	45
					60,000	1.15	100		33	39
					100,000	0.57	75		35	50
180	185	-3	0	5.4	40,000	2.70		340	26	28
					100,000	1.50	175		26	30
225	135	-3	0	5.5	60,000	2.70		425	27	27
					100,000	1.80	220		27	31
*250	135	-3	0	5.5	60,000	2.70		480	26	30
					60,000	1.20		110	30	55
					100,000	2.10	250		26	29
					100,000	1.50	200		30	43

*Maximum operating conditions.

Curves showing the fundamental power and voltage output and the second and third harmonic levels as functions of input voltage for a number of values of load resistance and a typical operating condition are given in Figures 17, 18, 19 and 20.

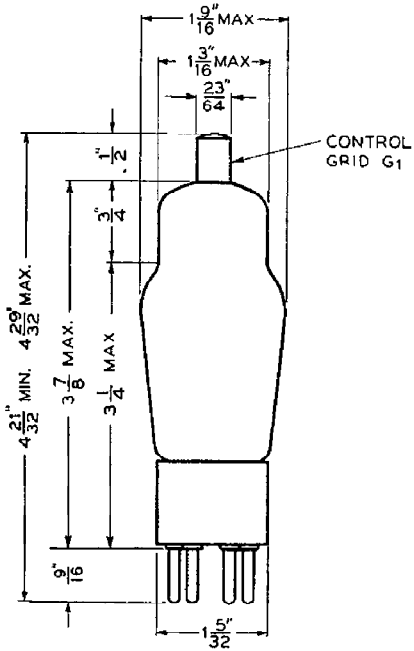

FIG. 1

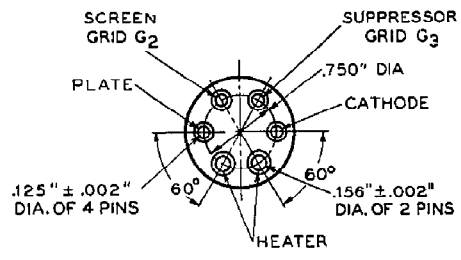

FIG. 2

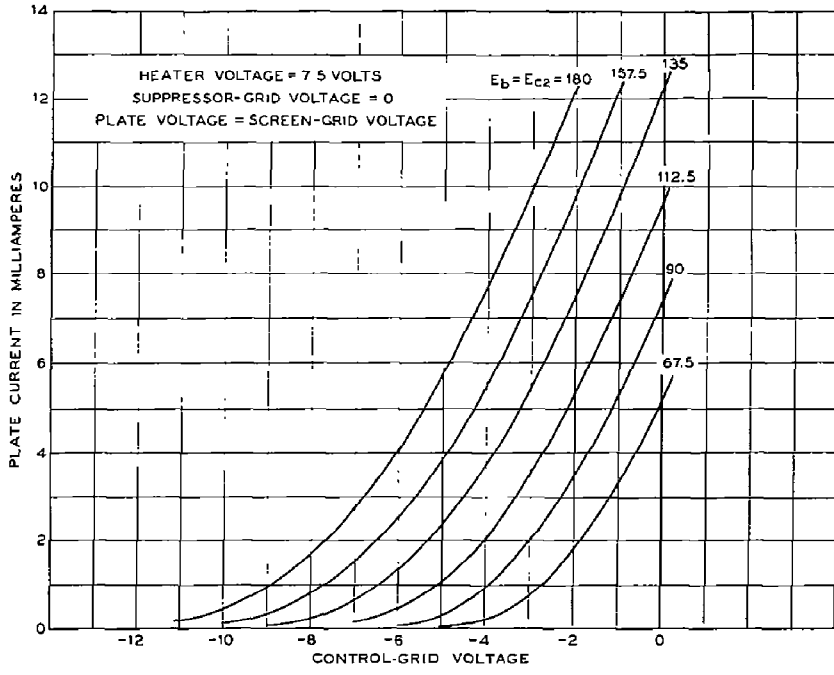

FIG. 3

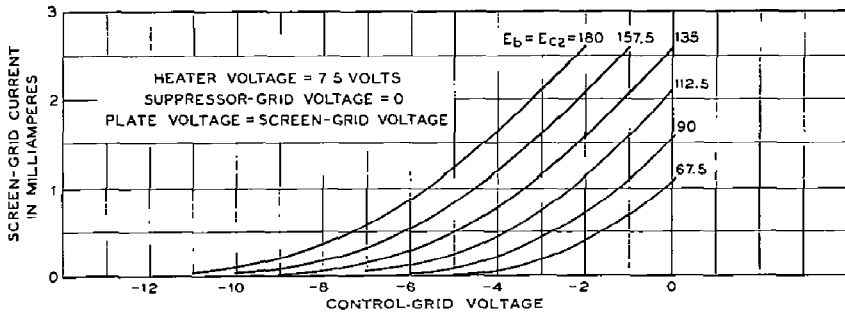
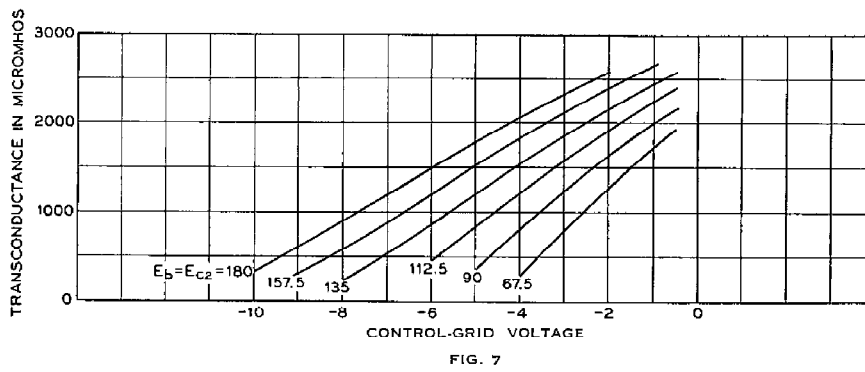
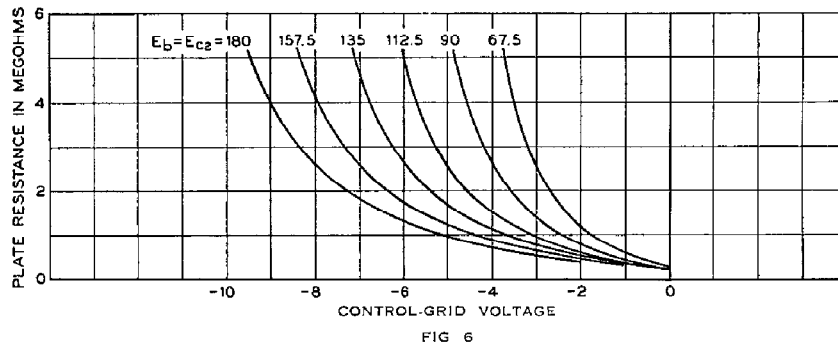
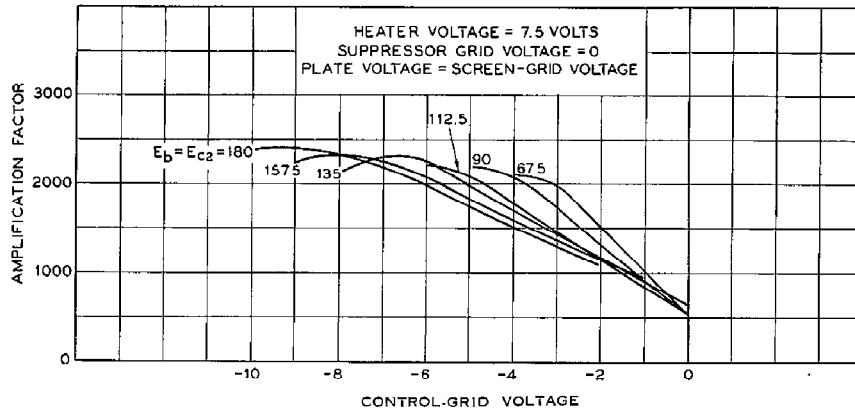

FIG. 4



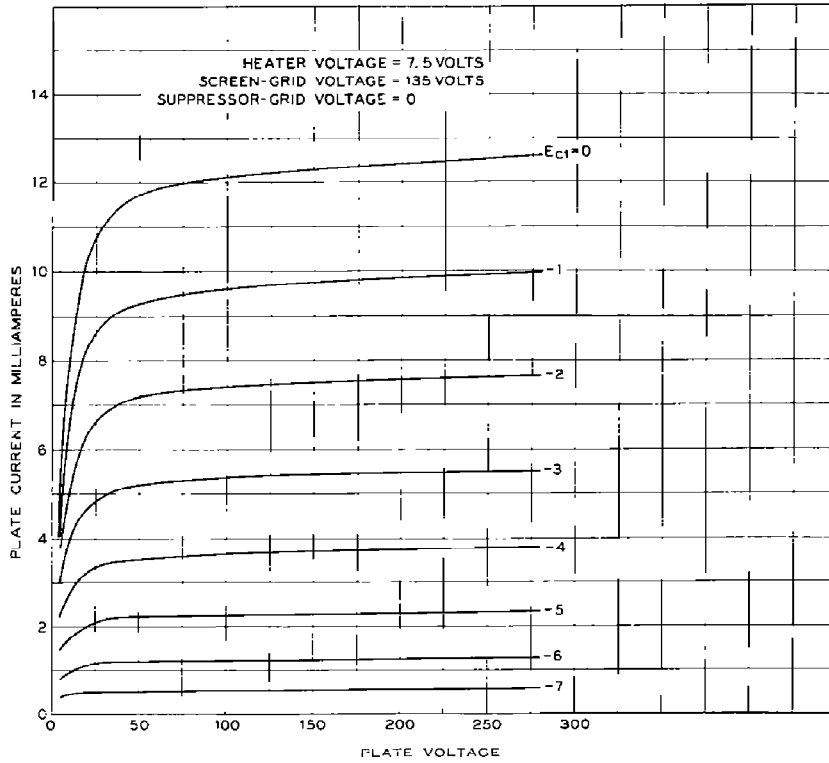

FIG. 8

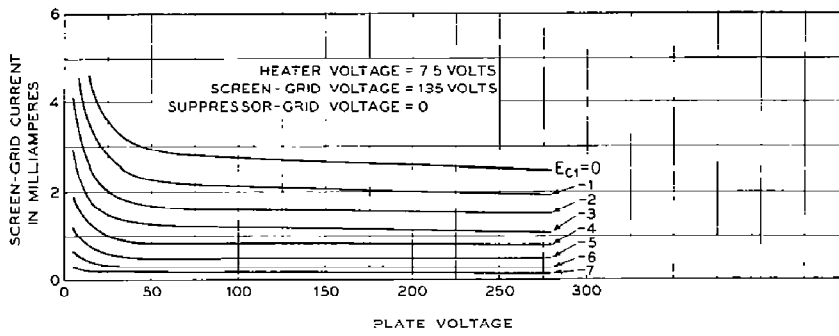

FIG. 9

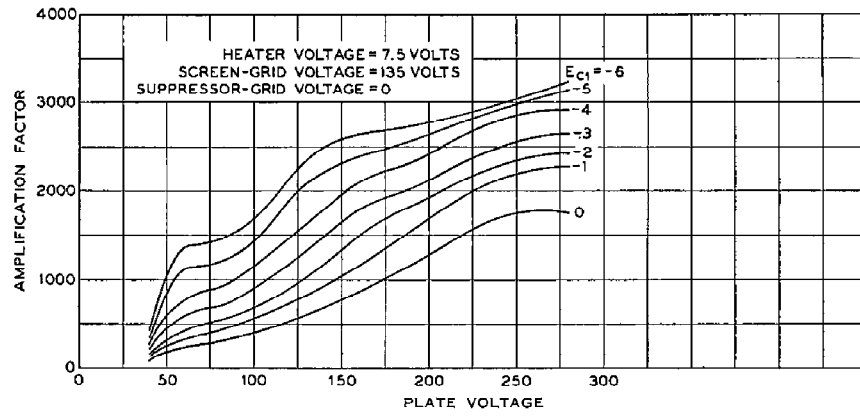

FIG. 10

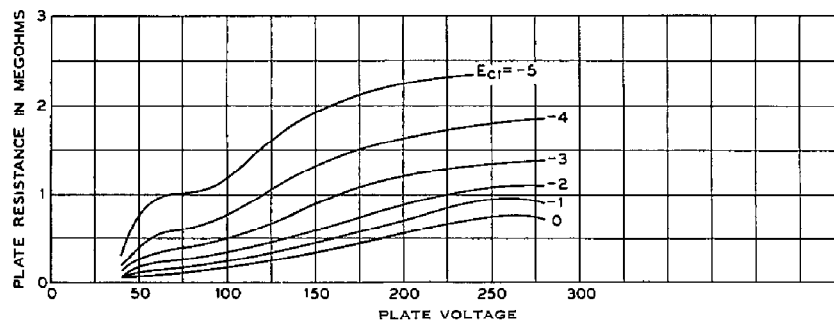

FIG. 11

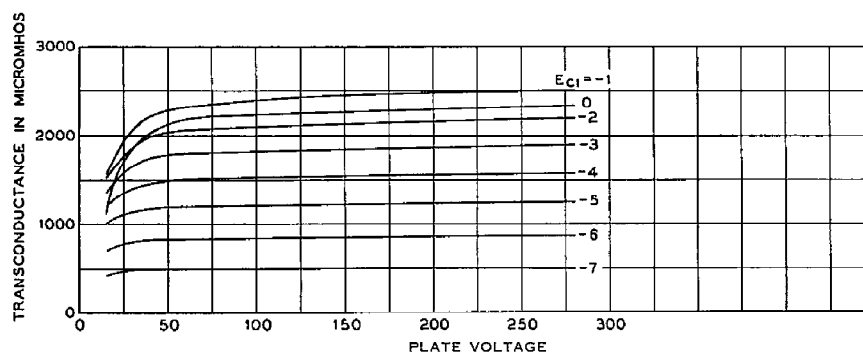

FIG. 12

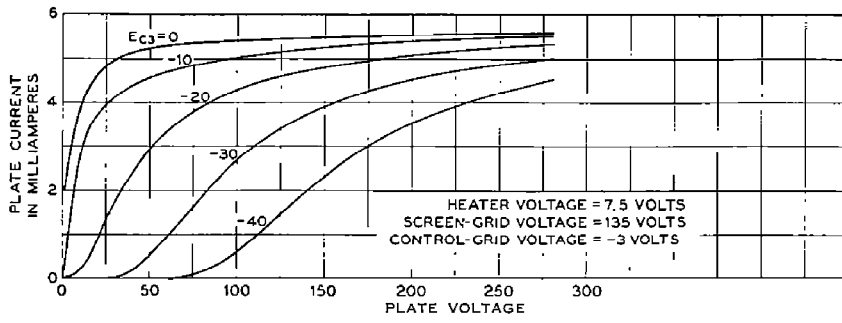

FIG. 13

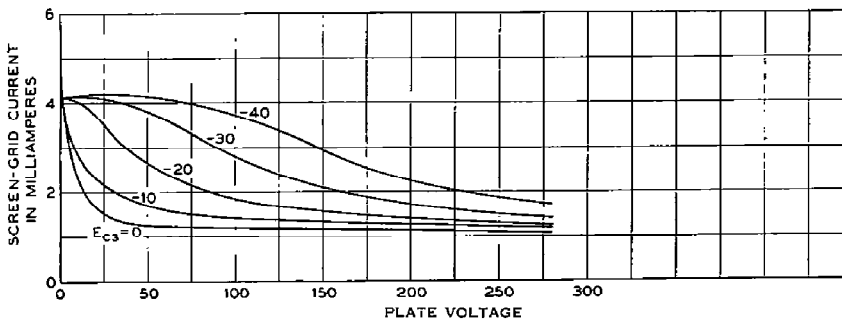

FIG. 14

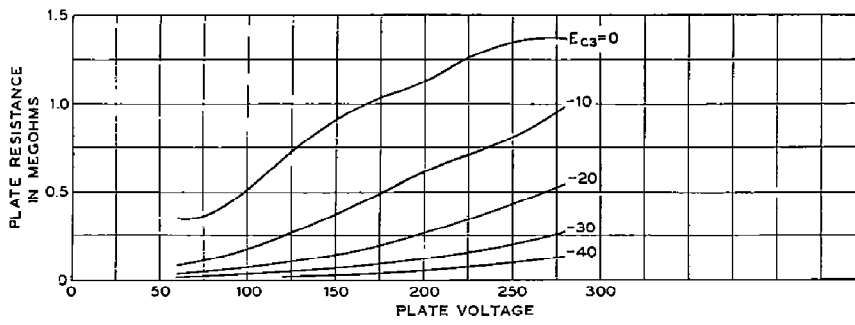

FIG. 15

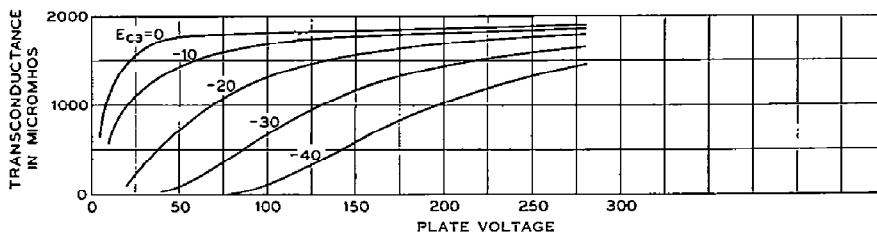

FIG. 16

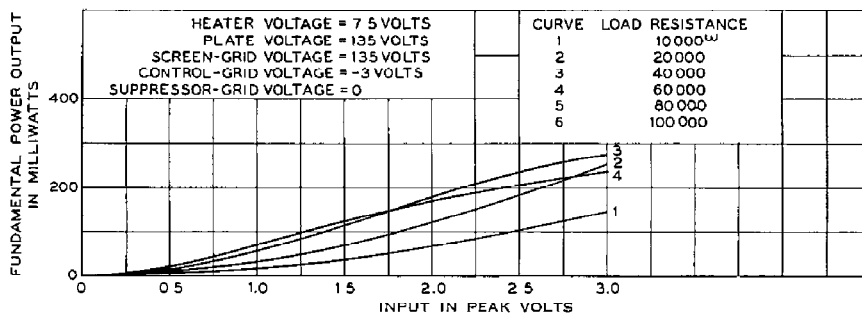

FIG. 17

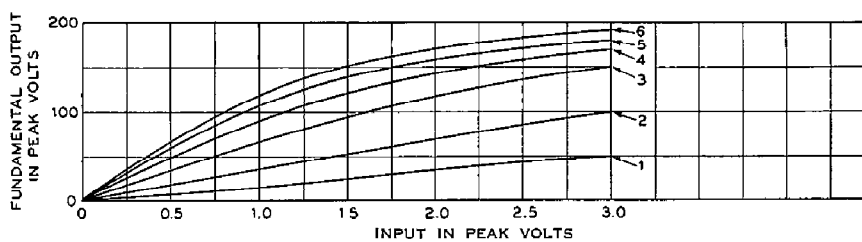

FIG. 18

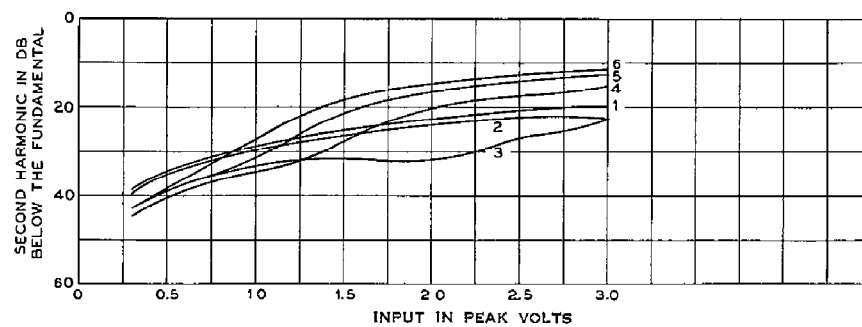

FIG. 19

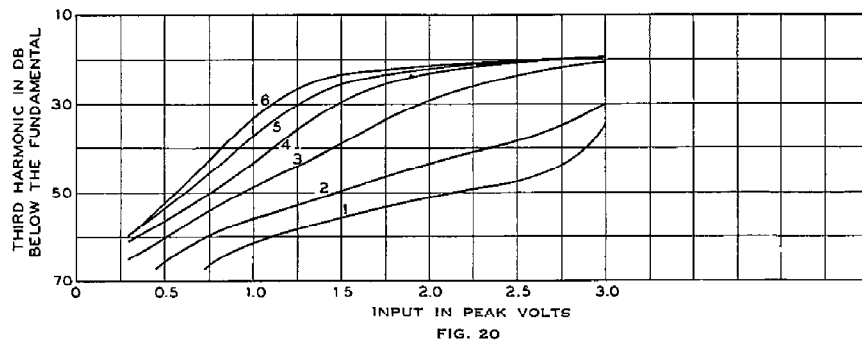

FIG. 20

ELECTRON TUBE DATA SHEET
WESTERN ELECTRIC 328 A ELECTRON TUBE



328A

DESCRIPTION

The 328A is an indirectly heated cathode type pentode having a separate suppressor grid connection. It is intended for use in audio, carrier and radio-frequency voltage amplifiers, oscillators or modulators. This tube, except for having a different heater voltage and current rating, is identical to the 310A tube.

CHARACTERISTICS

Heater Voltage	7.5 volts
Plate Current	5.5 milliamperes
Transconductance	1820 micromhos

$(E_b = 180 \text{ volts; } E_{c2} = 135 \text{ volts; } E_{c1} = -3 \text{ volts; } E_{c3} = 0)$

328A

GENERAL CHARACTERISTICS

ELECTRICAL DATA

Heater Voltage		7.5 volts
Heater Current		425 milliamperes
Direct Interelectrode Capacitances	without	with
	external	external shield
	shield	(RETMA #311)
Grid to Plate (maximum)	0.016	*0.010 $\mu\mu\text{f}$
Input: g1 to (h+k+g2+g3+i.s.)	6.0	*7.0 $\mu\mu\text{f}$
Output: p to (h+k+g2+g3+i.s.)	13	*13 $\mu\mu\text{f}$

MECHANICAL DATA

Cathode	Coated unipotential
Bulb	ST12
Base	Small 6-pin
Mounting Position	Any
Dimensions and pin connections shown in outline drawings on page 5	

MAXIMUM RATINGS, Design-Center Values

Plate Voltage	250 volts
Screen Grid Voltage	180 volts
Plate Dissipation	2.0 watts
Screen Grid Dissipation	0.4 watt
Cathode Current	10 milliamperes
Heater-Cathode Voltage	150 volts

TYPICAL OPERATING CONDITIONS AND CHARACTERISTICS

Plate Voltage	135	180	250 volts
Screen Grid Voltage	135	135	135 volts
Control Grid Voltage	-3	-3	-3 volts
Suppressor Grid Voltage	0	0	0 volts
Plate Current	5.40	5.50	5.60 milliamperes
Screen Grid Current	1.20	1.18	1.17 milliamperes
Peak A-F Signal Voltage	3.00	1.50	2.10 volts
Plate Resistance	0.75	0.90	1.15 megohms
Transconductance	1800	1820	1840 micromhos
Load Resistance	20000	100000	100000 ohms
Power Output	250	150	310 milliwatts
Total Harmonic Distortion	8.5	6	6 per cent
Control Grid Voltage, Approximate, for 10 Microamperes Plate Current	-9.5	-9.5	-9.5 volts

*with external shield (RETMA #311) connected to cathode pin.

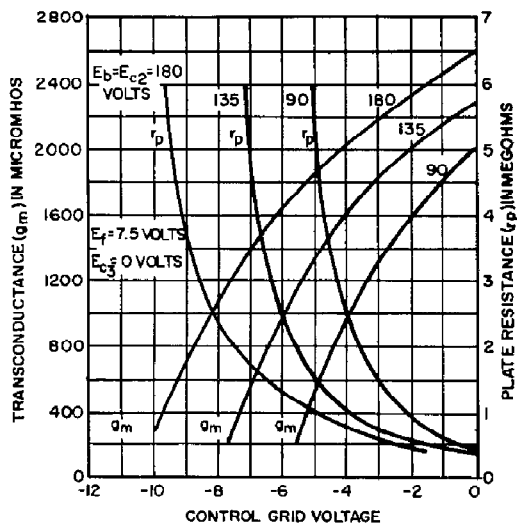
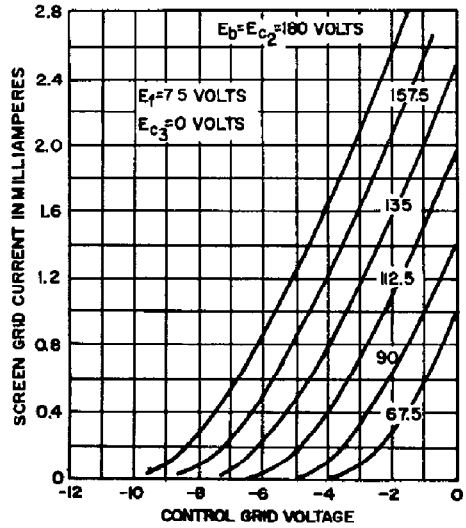
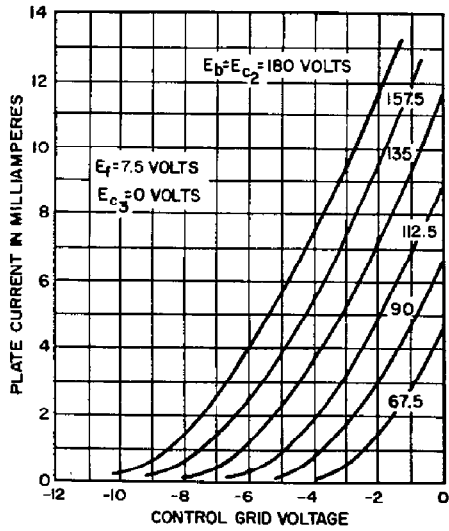

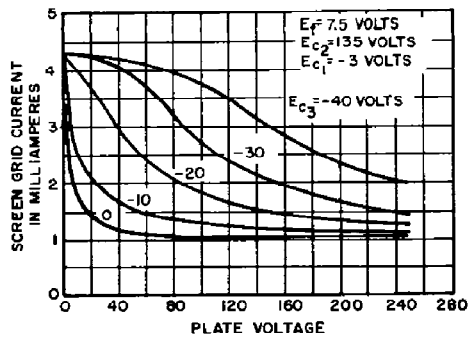
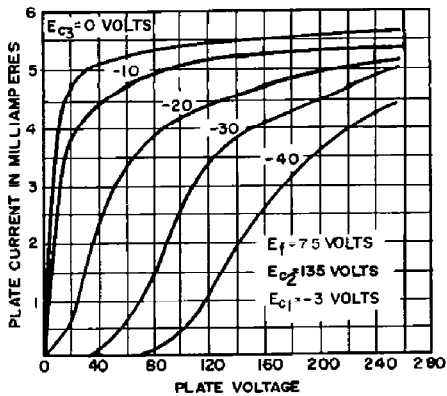
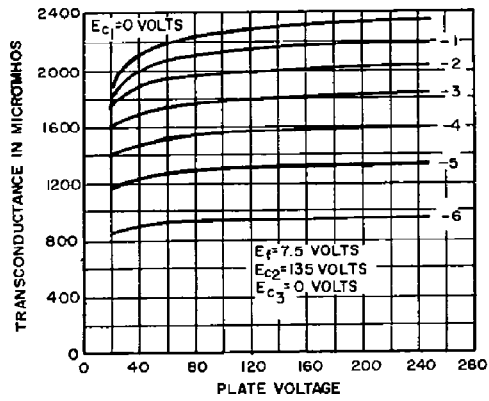
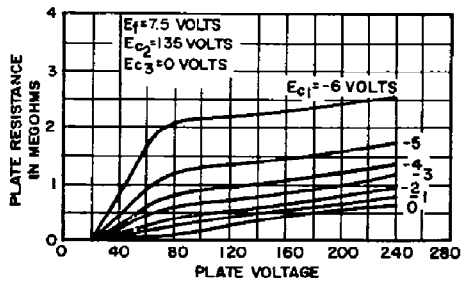
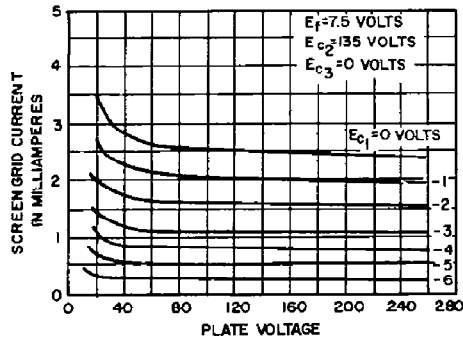
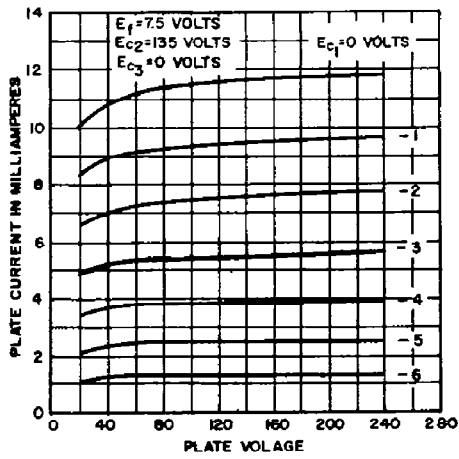

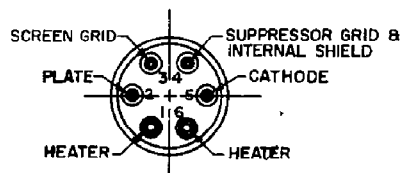
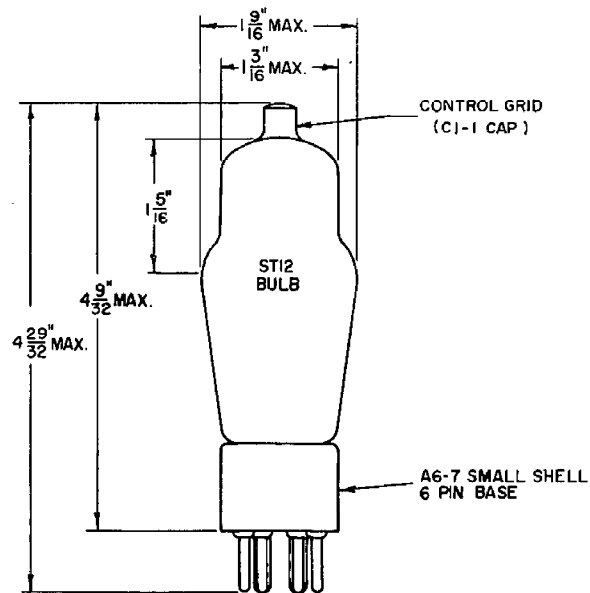
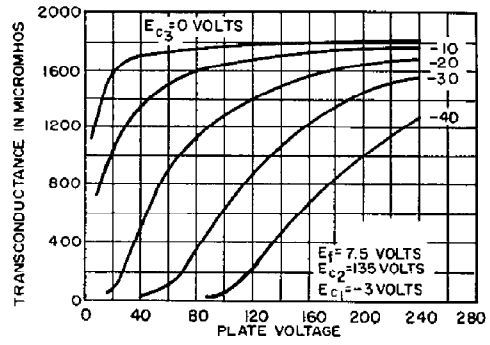
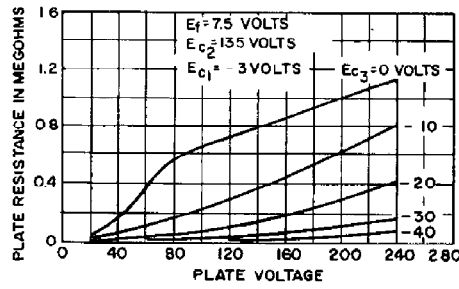

Western Electric

311A and 329A Vacuum Tubes

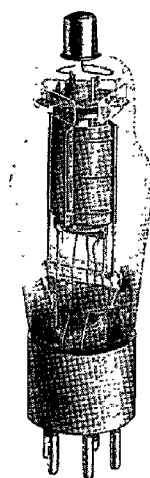

Classification—Low-power, suppressor-grid pentodes with indirectly heated cathodes

The 311A and 329A tubes are identical except for the heaters.

These tubes are intended primarily for use as audio, carrier or radio-frequency power amplifiers where power outputs of approximately two watts are required and where the plate voltage is not in excess of 180 volts. The suppressor grid is permanently connected to the cathode within the tube.

Dimensions and Connections—Dimensions, outline diagrams of the tubes and bases, and the arrangement of the electrode connections to the base terminals are shown in Figures 1 and 2.

Base and Mounting—These vacuum tubes employ small five-pin thrust type bases with silver plated pins. They are adapted for use in standard five-contact type sockets, preferably those provided with silver-plated contacts such as the Western Electric 141A socket. A small metal cap control-grid terminal is located at the top of the bulb.

The tubes may be mounted in any position.

**311A
329A**

Average Direct Interelectrode Capacitances

	<u>A</u>	<u>B</u>
Control grid to plate	0.29	0.07 $\mu\mu\text{f.}$
Control grid to heater, cathode and screen grid.	8	9 $\mu\mu\text{f.}$
Plate to heater, cathode and screen grid.	9	12 $\mu\mu\text{f.}$

Column A—Without shield.

Column B—With close fitting metal shield connected to the cathode.

Heater Ratings

	<u>311A Tube</u>	<u>329A Tube</u>
Heater voltage.	10.0	7.5 volts, a.c. or d.c.
Nominal heater current	0.64	0.85 ampere

The heaters should be operated on a voltage basis and at as near the rated voltage as practicable.

The voltage between the cathode and the heater should not exceed 150 volts.

Characteristics—Figures 3 and 4 respectively, show plate current and screen-grid current as functions of control-grid voltage for several values of screen and plate voltage. In all curves the plate voltage is equal to the screen voltage. Amplification factor, plate resistance and transconductance curves for the conditions corresponding to those of Figures 3 and 4 are given respectively in Figures 5, 6 and 7.

Plate current and screen-grid current are shown as functions of plate voltage in Figures 8 and 9 respectively, for a screen-grid voltage of 135 volts and for several values of control-grid voltage. Corresponding curves for amplification factor, plate resistance and transconductance are given in Figures 10, 11 and 12 respectively.

Curves showing the fundamental power output and the second and third harmonic levels as functions of input voltage for a number of values of load resistance for typical operating conditions are given in Figures 13, 14 and 15 respectively.

Limiting Conditions for Safe Operation

Maximum direct plate voltage.	180 volts
Maximum direct screen-grid voltage	150 volts
Maximum cathode current (plate current plus screen-grid current)	60 milliamperes
Maximum direct screen-grid current	12 milliamperes

Operating Conditions and Output — Nominal performance data are given in the table on page 3 for a number of typical operating conditions. Less severe operating conditions should be selected in preference to the maximum conditions wherever possible. The life of the tube at maximum conditions will be shorter than at the less severe conditions.

The performance data include the fundamental power output for the indicated values of load resistance and input voltage, and the maximum second and third harmonic levels for input voltages not exceeding the indicated values. Under certain conditions the maximum second harmonic level occurs at a lower input voltage than that given in the table. The power output is given in watts, and the harmonic levels in decibels below the fundamental.

TABLE

Control-grid voltage = -15 volts

Screen - grid voltage = 135 volts

Plate Voltage Volts	Amplification Factor	Plate Resistance Ohms	Transconductance Micromhos	Plate Current Milli-amperes	Load Resistance Ohms	Input Voltage Peak Volts	Output Power Watts	Second Harmonic db	Third Harmonic db
135	122	43,000	2800	30	3000	15	1.9	23	24
					3500	15	2.0	27	21
					4000	15	2.0	29	19
					6000	15	1.9	20	18
180*	146	50,000	2900	31	3000	15	2.5	18	30
					4000	15	2.8	21	24
					7000	15	2.5	23	18

*Maximum plate voltage.

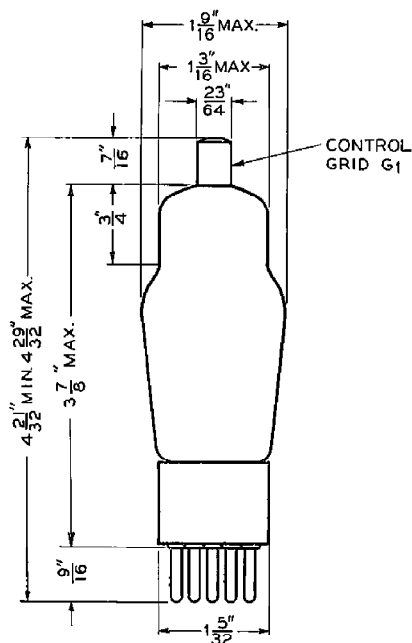

FIG. 1

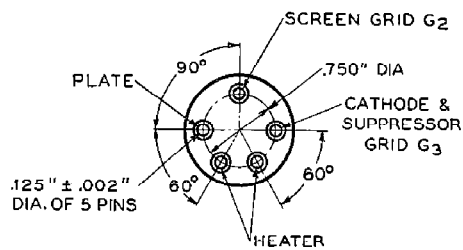

FIG. 2

311A
329A

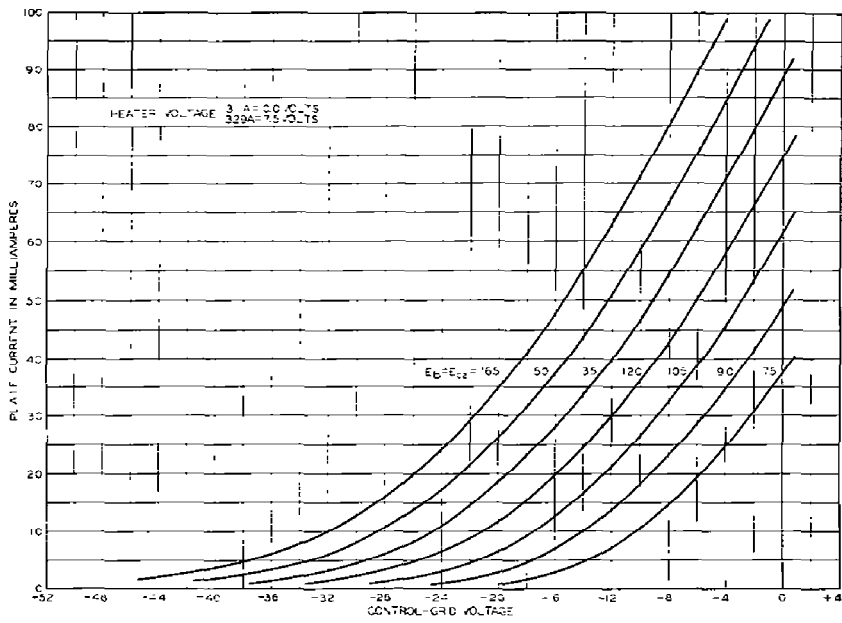

FIG. 3

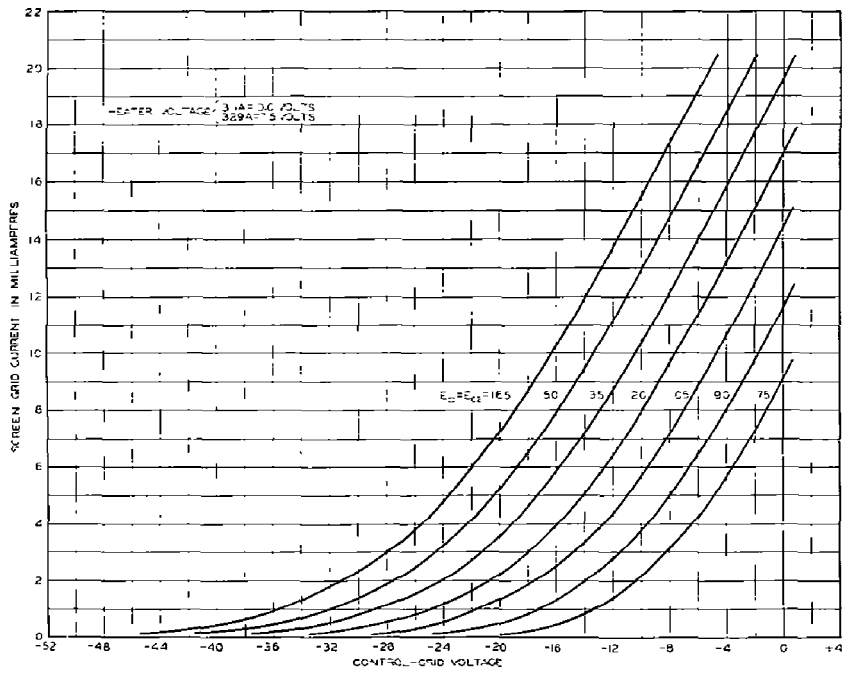

FIG. 4

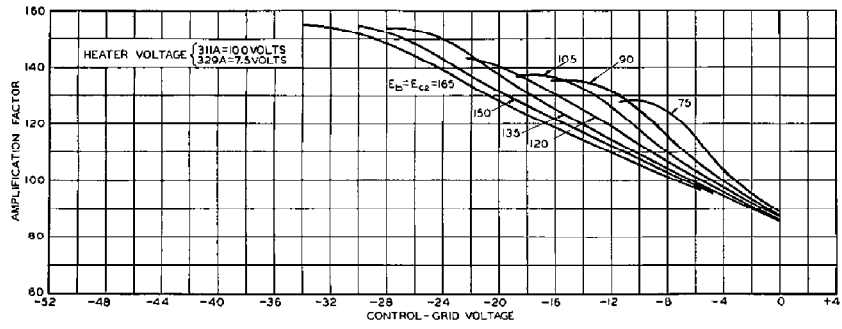

FIG. 5

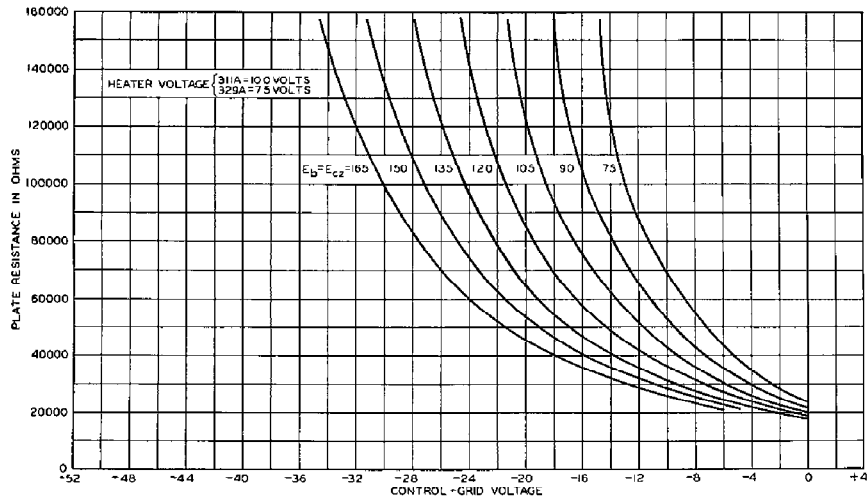

FIG. 6

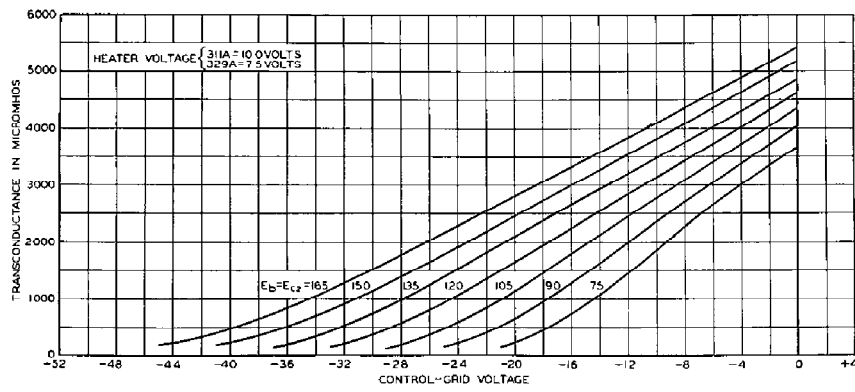

FIG. 7

311A
329A

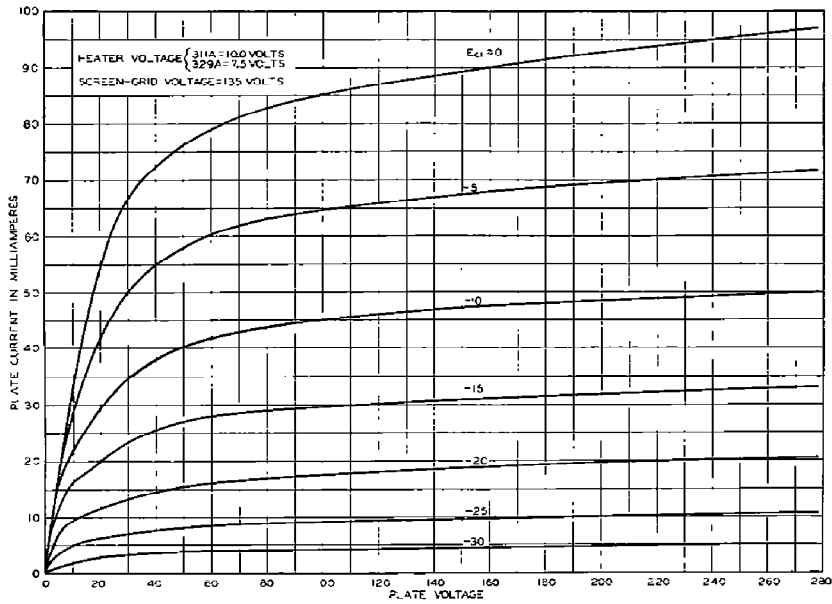

FIG. 8

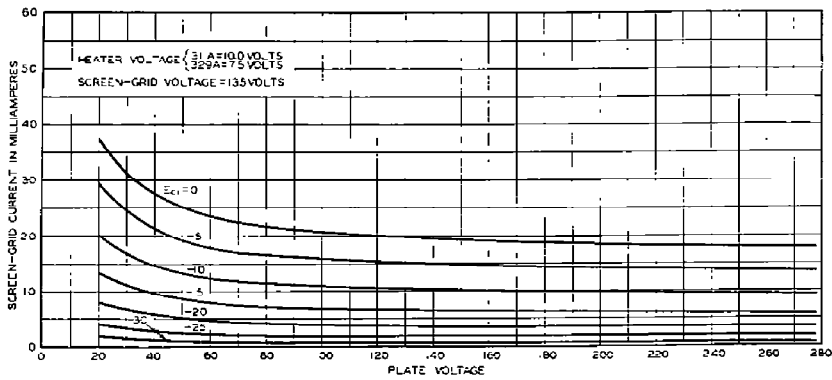

FIG. 9

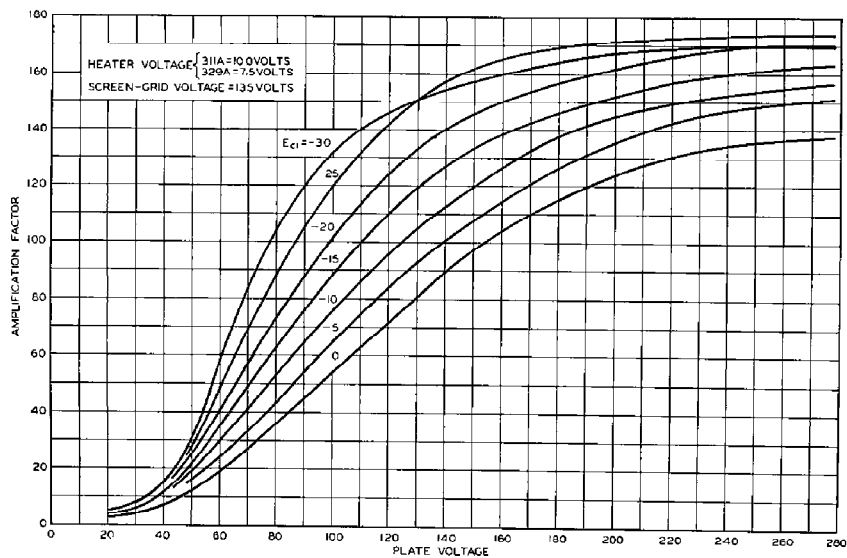

FIG. 10

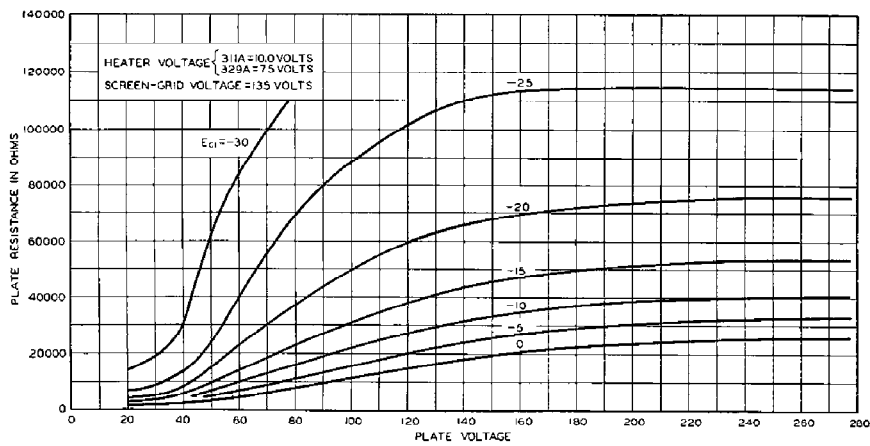

FIG. 11

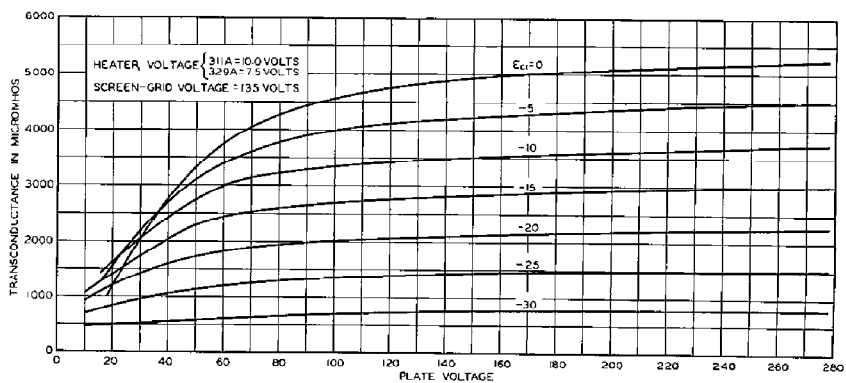

FIG. 12

311A
329A

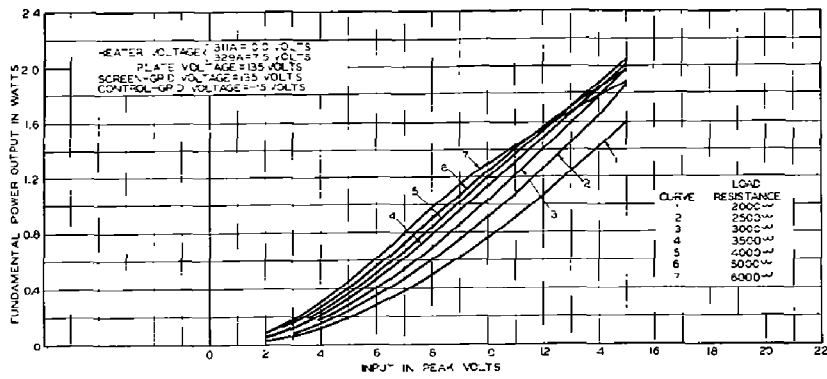

FIG. 13

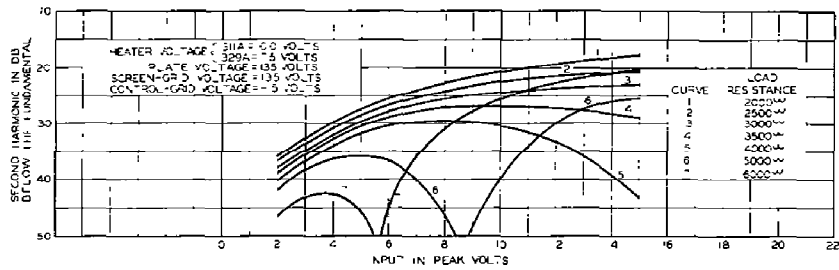

FIG. 14

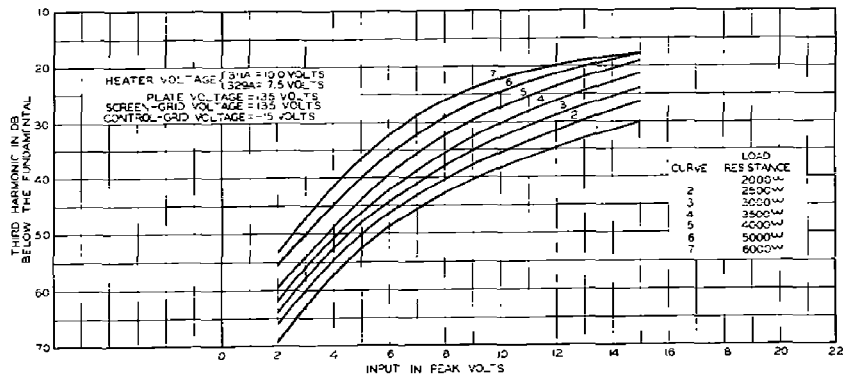
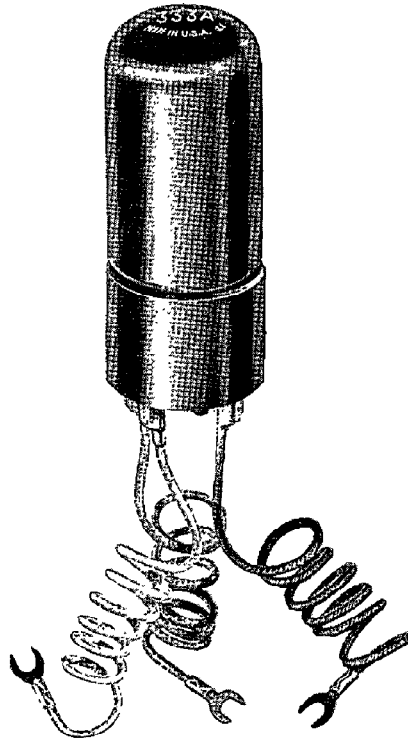

FIG. 15

1 H-39 6M
PRINTED IN U.S.A.

Developments of Bell Telephone Laboratories, Incorporated,
research laboratories of the American Telephone and Tele-
graph Company and the Western Electric Company

V. T. DATA SHEET
311A AND 329A
ISSUE 1



333A

COLD CATHODE

Western Electric

DESCRIPTION

The 333A is a three-electrode, inert-gas-filled, cold cathode tube for use in relay, voltage regulator, or rectifier circuits. This tube is especially suitable for use in control circuits such as in triggering, counting, or switching apparatus.

MAXIMUM RATINGS

Peak Anode Voltage	150 volts
Average Cathode Current	10 100 milliamperes
Average Life, approximate	10000 10 hours
Transfer Current	5 microamperes

333A
COLD CATHODE

MAXIMUM RATINGS, Absolute Values

Forward Peak Anode Voltage	150 volts
Forward Cathode Current	
Peak	100 milliamperes
Average	35 milliamperes
Averaging Time	2 seconds
Peak Inverse Anode Current	5 milliamperes
Ambient Temperature Limits	-55 to +85 centigrade

ELECTRICAL DATA

	Min.	Bogey	Max.
Starter Breakdown Voltage*	62	70	89 volts
Starter Voltage Drop at 20 milliamperes	52	60	74 volts
Anode Voltage Drop at 20 milliamperes	68	75	90 volts
Required Transfer Current at 130 Anode Volts (D.C.)	5		microamperes
Deionization Time, approximate			
Starter Gap		3	milliseconds
Main Gap		10	milliseconds
Inverse Current at -120 Volts Anode Potential**			3 milliamperes

MECHANICAL DATA

Mounting Position	Any
Net Weight, approximate	1 ounce

* Limits apply immediately after tube has conducted current. If tube has been idle, these values initially may be as much as 3 volts higher or lower.
 ** Negative anode voltage applied through 8,000 ohms. Starter connected to anode through 100,000 ohms.

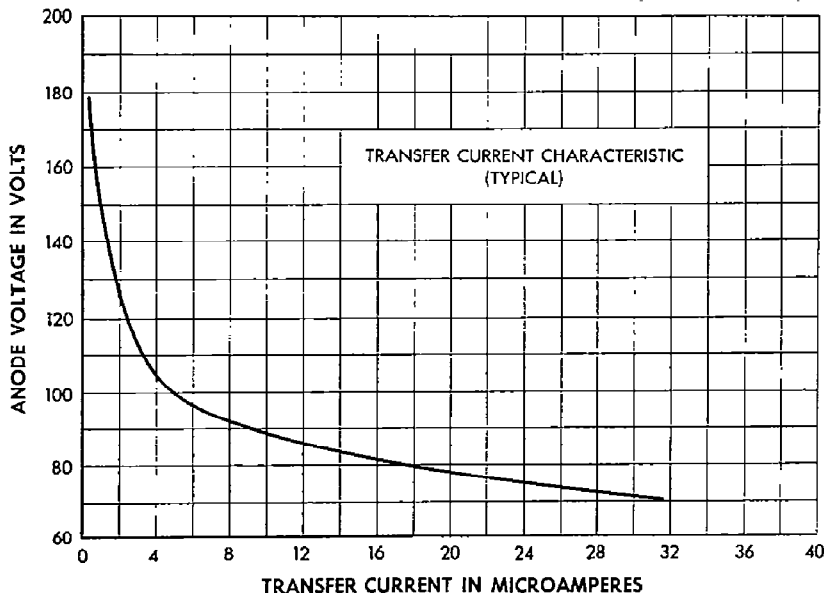

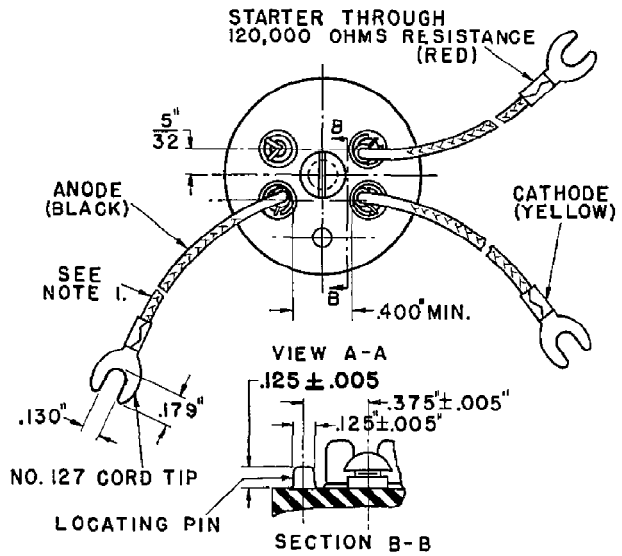
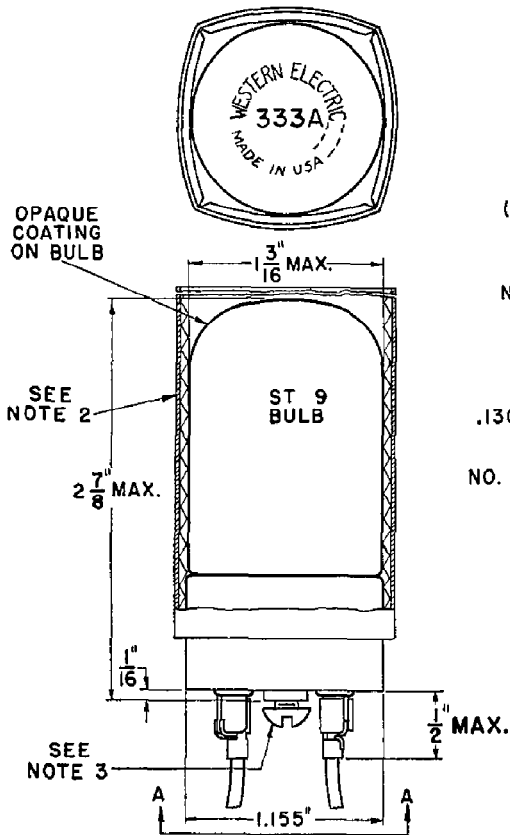
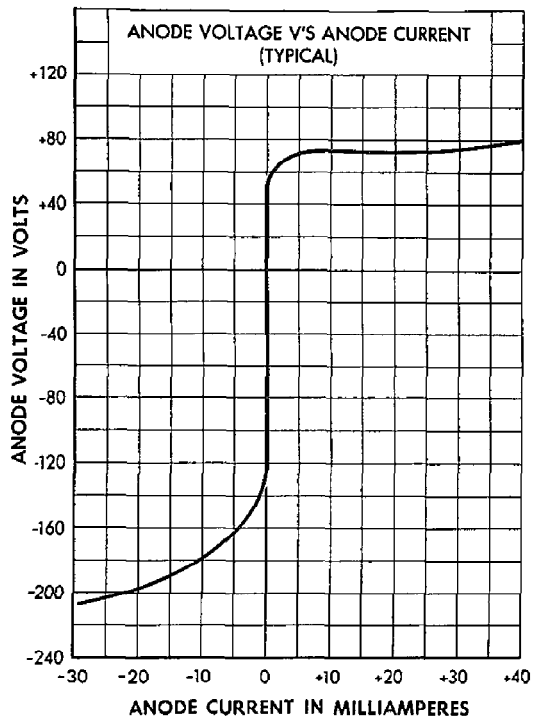
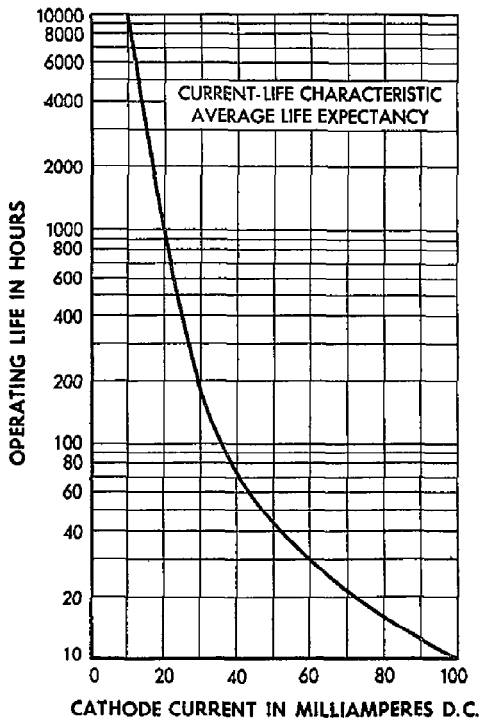

- NOTES -
1. LENGTH OF LEADS FROM END OF BASE SHELL TO END OF SPADE $1 1/32 \pm 1/2$
 2. TUBE SHIPPED WITH CORRUGATED PAPER SHOCK PROTECTIVE SLEEVE COVERING ENVELOPE AND PART OF BASE. SLEEVE SHOULD REMAIN ON TUBE WHEN INSTALLED IN TELEPHONE SET APPLICATIONS.
 3. THE $.164-32 \times 3/16$ SCREW, SUPPLIED WITH TUBE, ALLOWS FOR MOUNTING ON A BACKET $3/64$ THICK.

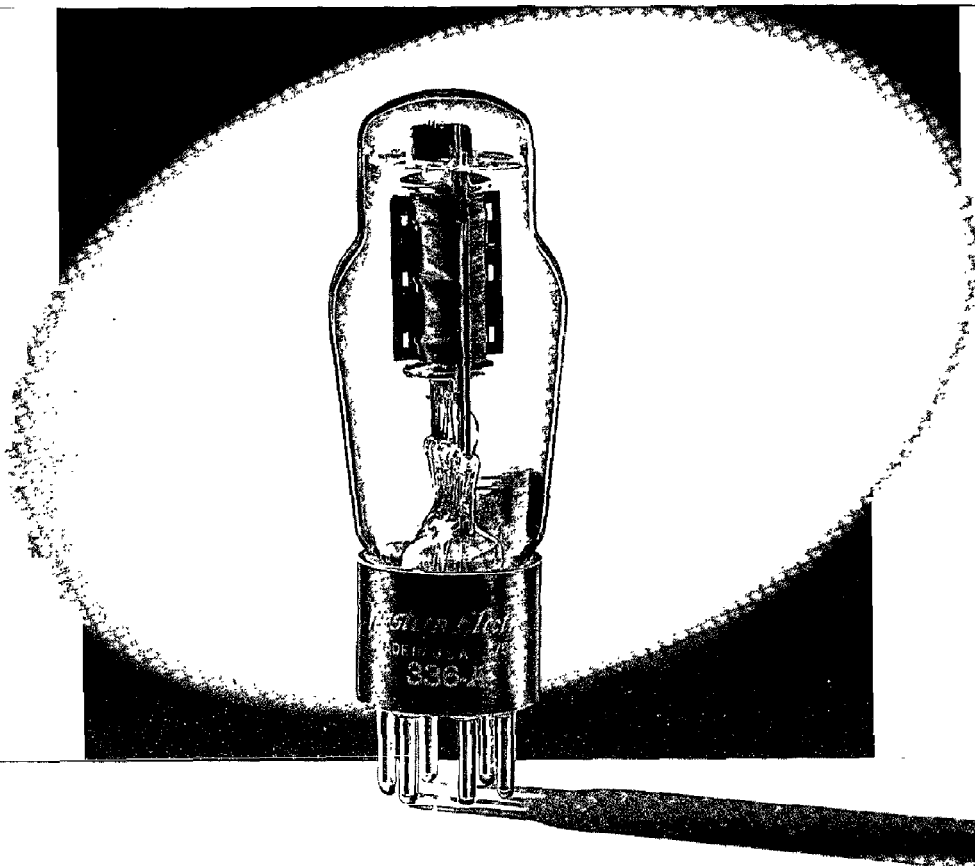

PENTODE

Western Electric

DESCRIPTION

The 336A is a suppressor grid, power pentode with an indirectly heated cathode. It is designed for use as an audio-frequency power amplifier in Class A₁ and AB₁ service.

CHARACTERISTICS

Heater Voltage		10.0 volts
Plate Current	$\left. \begin{array}{l} E_{b} = E_{c2} = 250 \text{ volts;} \\ E_{c1} = -14 \text{ volts} \end{array} \right\}$	32.5 milliamperes
Transconductance		4250 micromhos
Power Output		3.5 watts



GENERAL CHARACTERISTICS**ELECTRICAL DATA**

Heater Voltage, A-C or D-C		10.0 volts
Heater Current		0.64 ampere
Direct Interelectrode Capacitances	without external shield	with external shield (RMA #311)
Grid to Plate	0.52	*0.34 uuf
Input	11.5	*12.2 uuf
Output	8.1	*10.5 uuf

MECHANICAL DATA

Cathode	Coated unipotential
Bulb	ST12
Base	Small 6-pin
Mounting Position	Any
Dimensions and pin connections shown in outline drawing on Page 7	

MAXIMUM RATINGS, Design-Center Values

Plate Voltage	250 volts
Screen Grid Voltage	250 volts
Plate Dissipation	12 watts
Screen Grid Dissipation	3.5 watts
Cathode Current	50 milliamperes
Heater-Cathode Voltage	150 volts

TYPICAL OPERATING CONDITIONS AND CHARACTERISTICS**SINGLE TUBE AMPLIFIER — PENTODE CONNECTION**

Plate Voltage	180	250	250 volts
Screen Grid Voltage	180	250	250 volts
Control Grid Voltage	-8	-14	... volts
Cathode Resistor	330 ohms
Peak A-F Grid Voltage	8	10	10 volts
Zero Signal Plate Current	28.0	32.0	32.0 milliamperes
Maximum Signal Plate Current	29.5	34.0	30.5 milliamperes
Zero Signal Screen Grid Current	6.0	6.5	6.5 milliamperes
Maximum Signal Screen Grid Current	8.2	11.0	10.5 milliamperes
Transconductance	4100	4250	4400 micromhos
Plate Resistance	70000	84500	75000 ohms
Load Resistance	5000	7000	7000 ohms
Maximum Signal Power Output	1.8	3.6	3.3 watts
Total Harmonic Distortion	6.3	8.0	8.8 per cent

*With external shield (RMA #311) connected to cathode pin.

SINGLE TUBE AMPLIFIER - TRIODE CONNECTION*

Plate Voltage	250 volts
Control Grid Voltage	-16 volts
Peak A-F Grid Voltage	16 volts
Zero Signal Plate Current	30.0 milliamperes
Maximum Signal Plate Current	33.0 milliamperes
Transconductance	4550 micromhos
Amplification Factor	10
Plate Resistance	2200 ohms
Load Resistance	4000 ohms
Maximum Signal Power Output	1.3 watts
Total Harmonic Distortion	4.8 per cent

PUSH-PULL AMPLIFIER - PENTODE CONNECTION

Unless otherwise specified, values are for 2 tubes

Plate Voltage	250	250 volts
Screen Grid Voltage	250	250 volts
Control Grid Voltage	-18	... volts
Cathode Resistor	...	200 ohms
Peak A-F Grid-to-Grid Voltage	36	36 volts
Zero Signal Plate Current	35.5	55.0 milliamperes
Maximum Signal Plate Current	68.0	64.0 milliamperes
Zero Signal Screen Grid Current	8.0	12.0 milliamperes
Maximum Signal Screen Grid Current	20.5	19.5 milliamperes
Effective Load Resistance (plate-to-plate)	7000	7000 ohms
Maximum Signal Power Output	8.2	7.2 watts
Total Harmonic Distortion	5.5	5 per cent

PUSH-PULL AMPLIFIER - TRIODE CONNECTION*

Unless otherwise specified, values are for 2 tubes

Plate Voltage	250 Volts
Control Grid Voltage	-18 volts
Peak A-F Grid-to-Grid Voltage	36 volts
Zero Signal Plate Current	47.5 milliamperes
Maximum Signal Plate Current	59.5 milliamperes
Effective Load Resistance (plate-to-plate)	7000 ohms
Maximum Signal Power Output	3.0 watts
Total Harmonic Distortion	3.2 per cent

* Screen grid connected to plate.

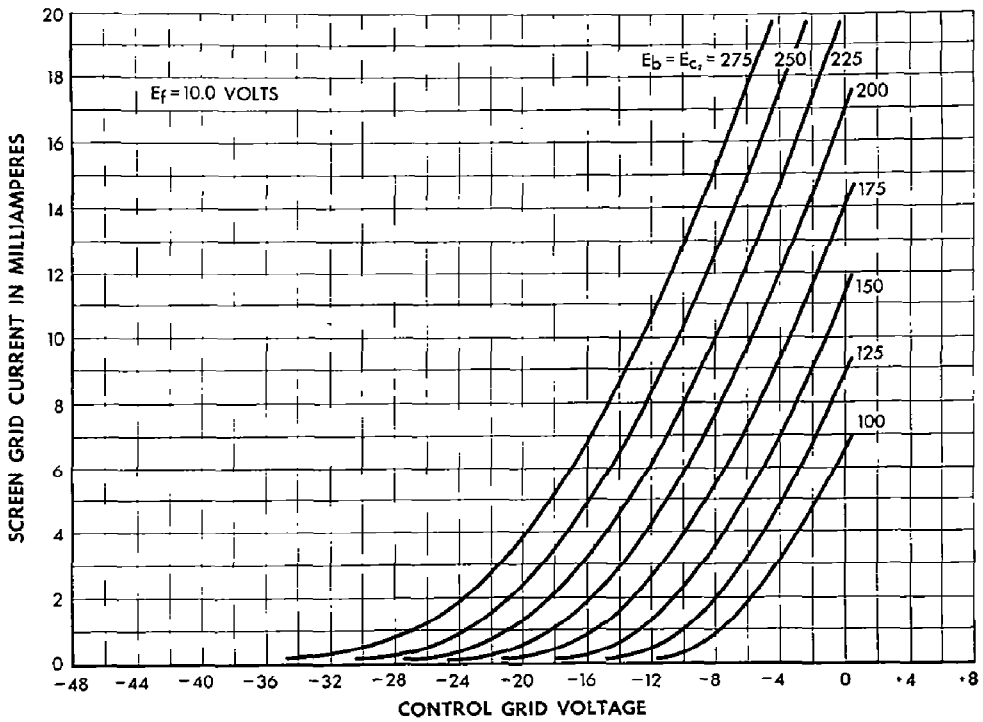
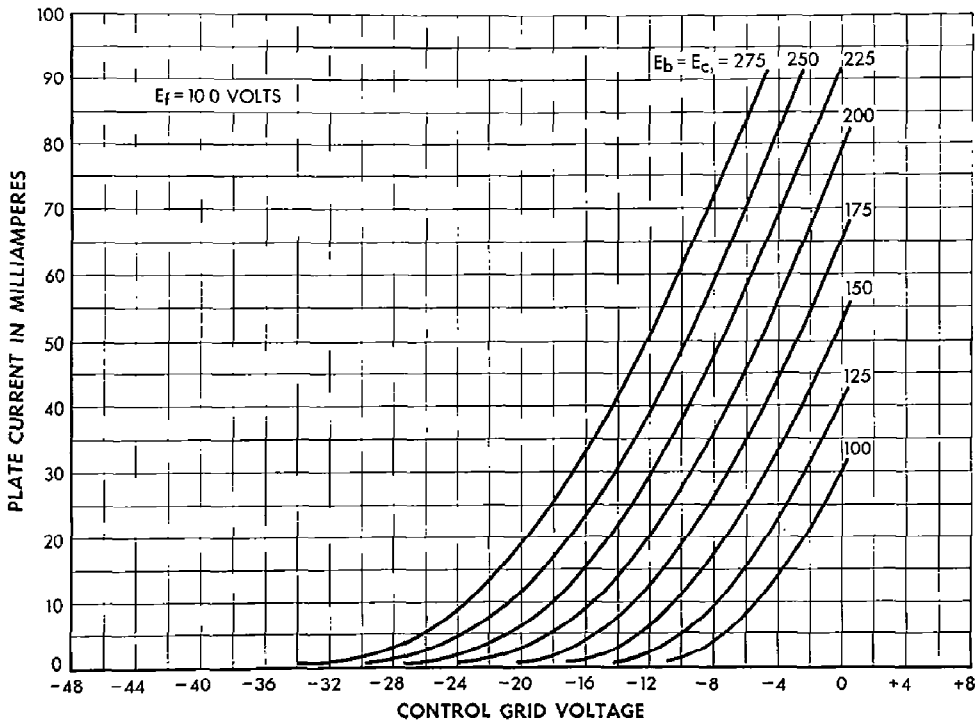

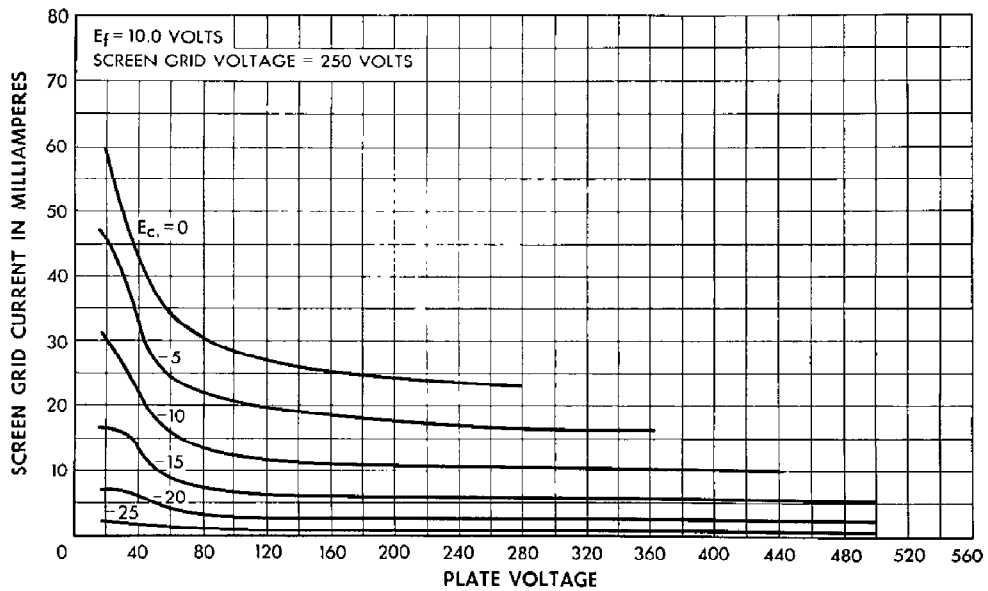
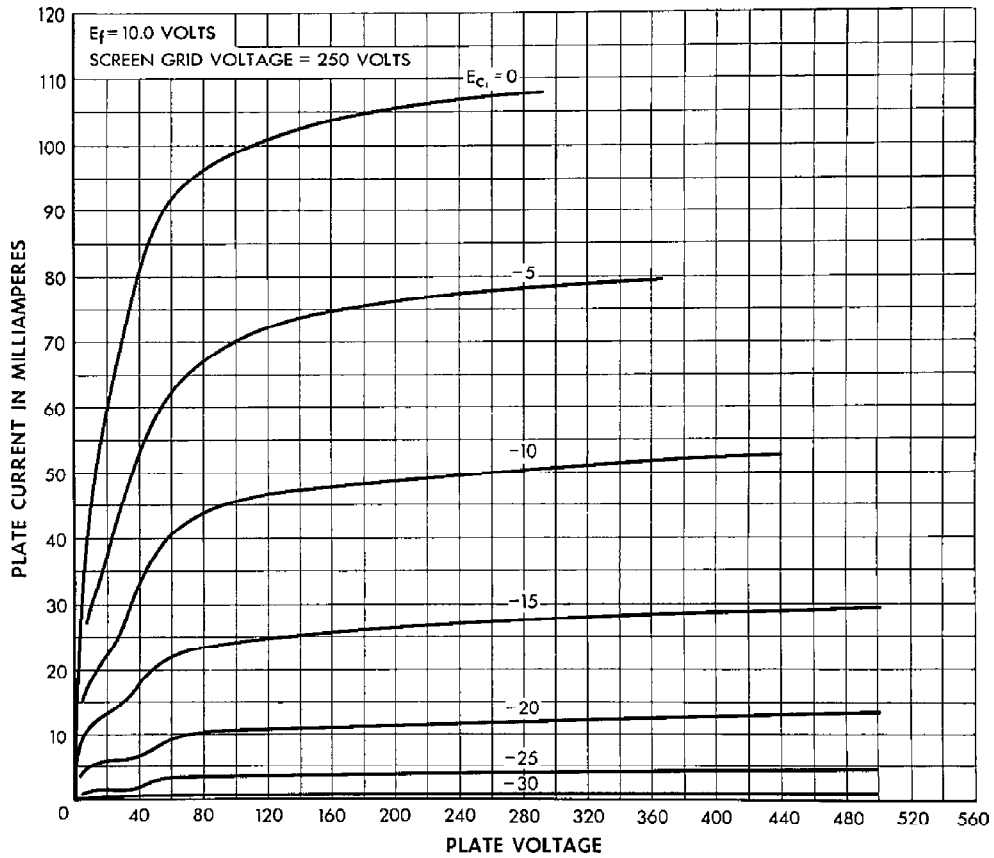

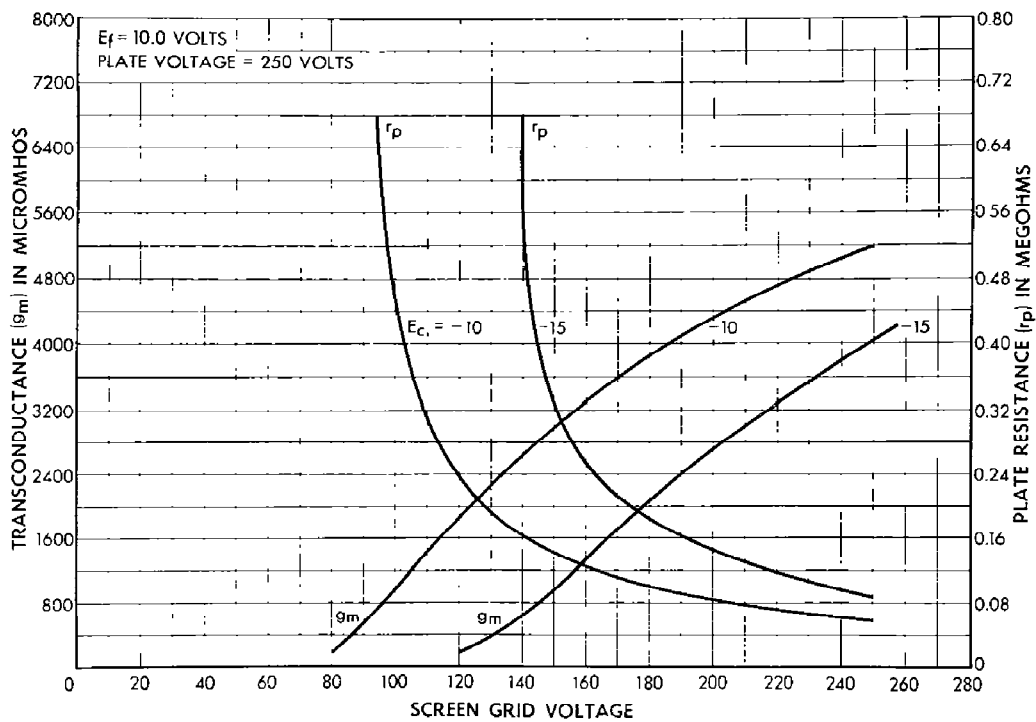
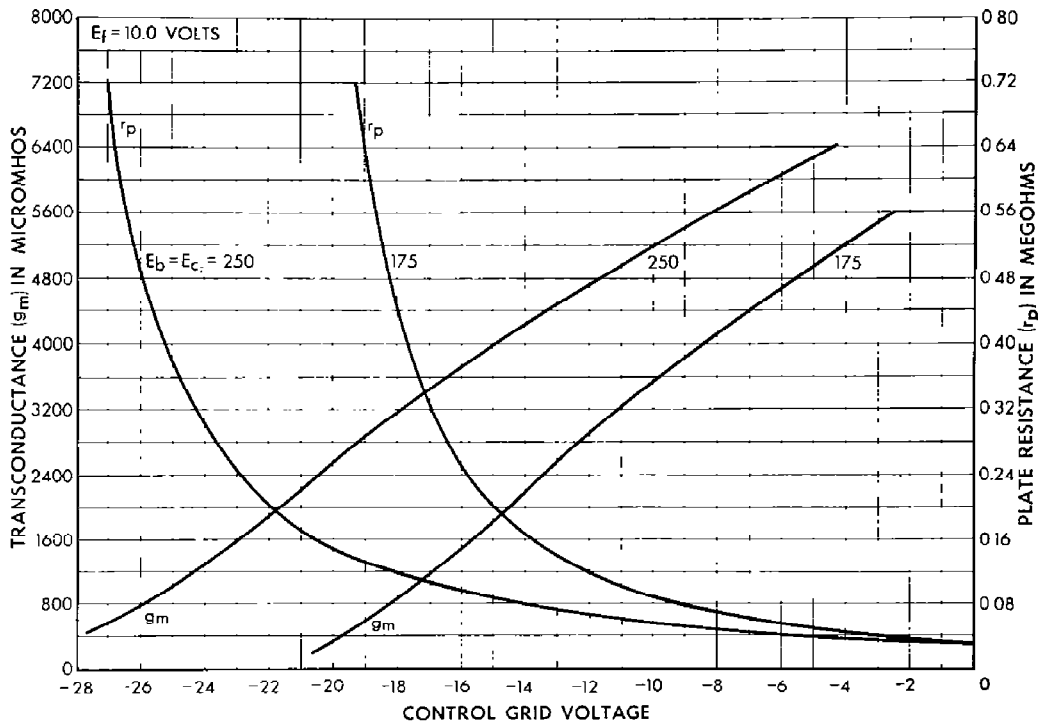

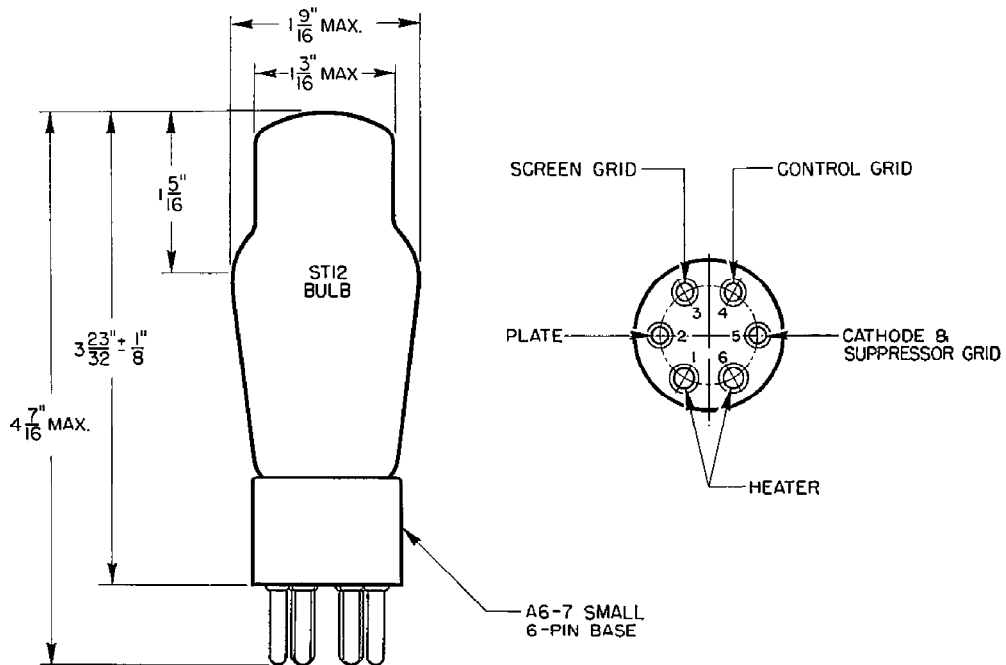
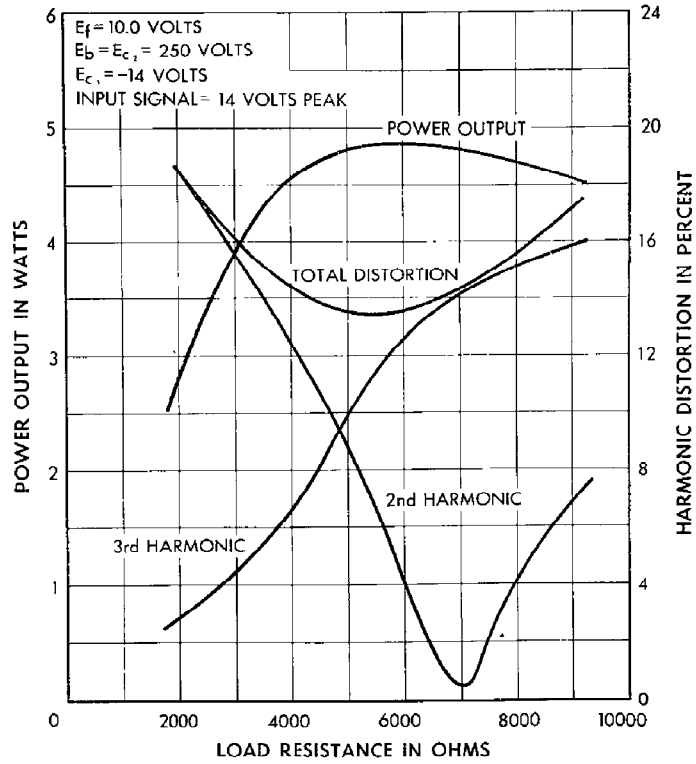

ELECTRON TUBE DATA SHEET
WESTERN ELECTRIC 337A ELECTRON TUBE

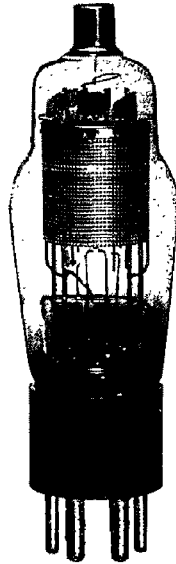

337A

DESCRIPTION

The 337A is a variable-mu pentode of the unipotential cathode type. The suppressor grid is connected to a separate base pin to provide flexibility in usage. This tube is designed for use as an audio, carrier or radio-frequency amplifier, oscillator or modulator.

CHARACTERISTICS

Heater Voltage	10 volts
Plate Current	$\left. \begin{array}{l} E_b = 180 \text{ volts;} \\ E_{c2} = 135 \text{ volts;} \\ E_{c1} = -3 \text{ volts;} \end{array} \right\} 6.3 \text{ milliamperes}$
Transconductance	1740 micromhos

GENERAL CHARACTERISTICS

ELECTRICAL DATA

Heater Voltage, A-C or D-C			10 volts
Heater Current			320 milliamperes
Direct Interelectrode Capacitances	WITHOUT EXTERNAL SHIELD	WITH EXTERNAL SHIELD (RMA#311)	
Grid to Plate (maximum)	0.016	*0.009	uuf
Input	5.9	* 6.5	uuf
Output	12.4	* 13.0	uuf

* With external shield (RMA#311) Connected to Cathode (Pin #5)

MECHANICAL DATA

Cathode	Coated unipotential
Bulb	ST12
Base	Small 6-pin
Mounting position	Any
Dimensions and pin connections shown in outline drawing on Page 5	

MAXIMUM RATINGS, DESIGN-CENTER VALUES

Plate Voltage	250 volts
Screen Grid Voltage	180 volts
Plate Dissipation	2 watts
Screen Grid Dissipation	0.4 watt
Cathode Current	10 milliamperes
Heater-Cathode Voltage	150 volts

TYPICAL OPERATING CONDITIONS AND CHARACTERISTICS

Plate Voltage	135	180	250 volts
Screen Grid Voltage	135	135	135 volts
Control Grid Voltage	-3	-3	-3 volts
Suppressor Grid Voltage	0	0	0 volts
Plate Current	6.2	6.3	6.35 milliamperes
Screen Grid Current	1.3	1.27	1.24 milliamperes
Peak A-F Signal Voltage	3.0	1.5	2.0 volts
Plate Resistance	0.55	0.85	1.16 megohms
Transconductance	1730	1740	1750 micromhos
Load Resistance	30000	100000	100000 ohms
Power Output	230	150	300 milliwatts
Total Harmonic Distortion	6.0	7.0	8.0 per cent
Control Grid Voltage (approximate) for			
Transconductance of 10 micromhos	-18.5	-18.5	-18.5 volts

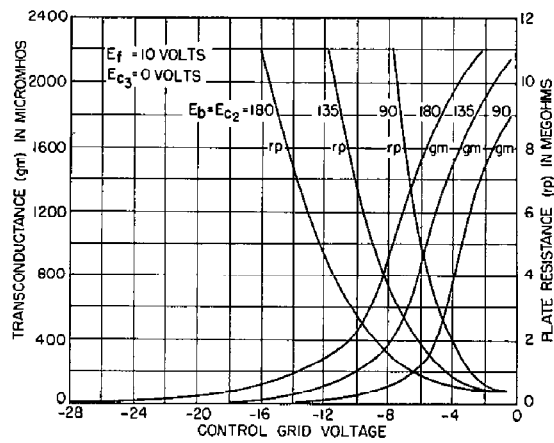
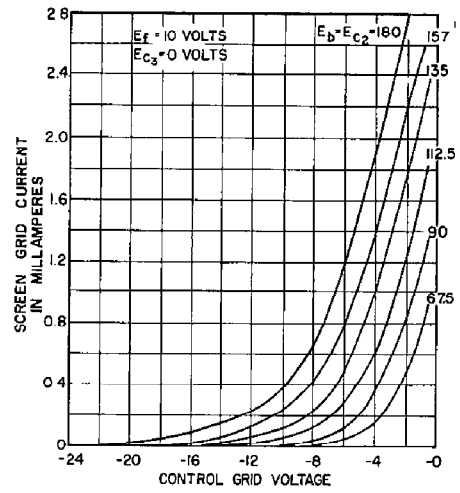
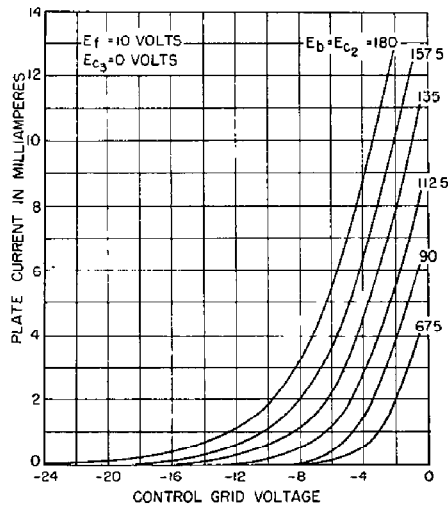

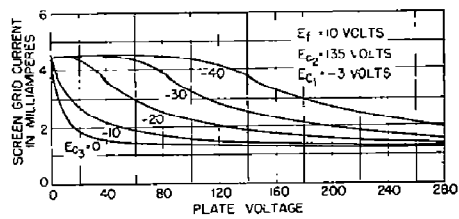
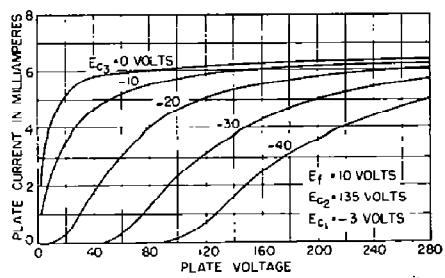
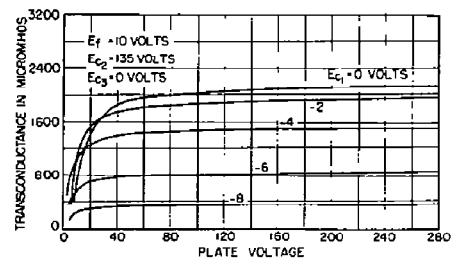
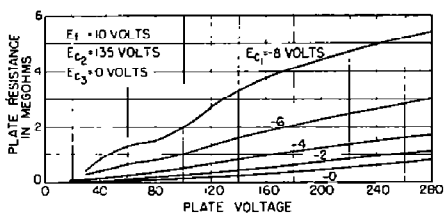
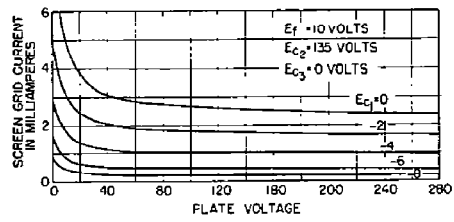
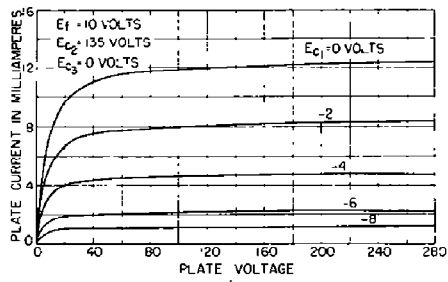

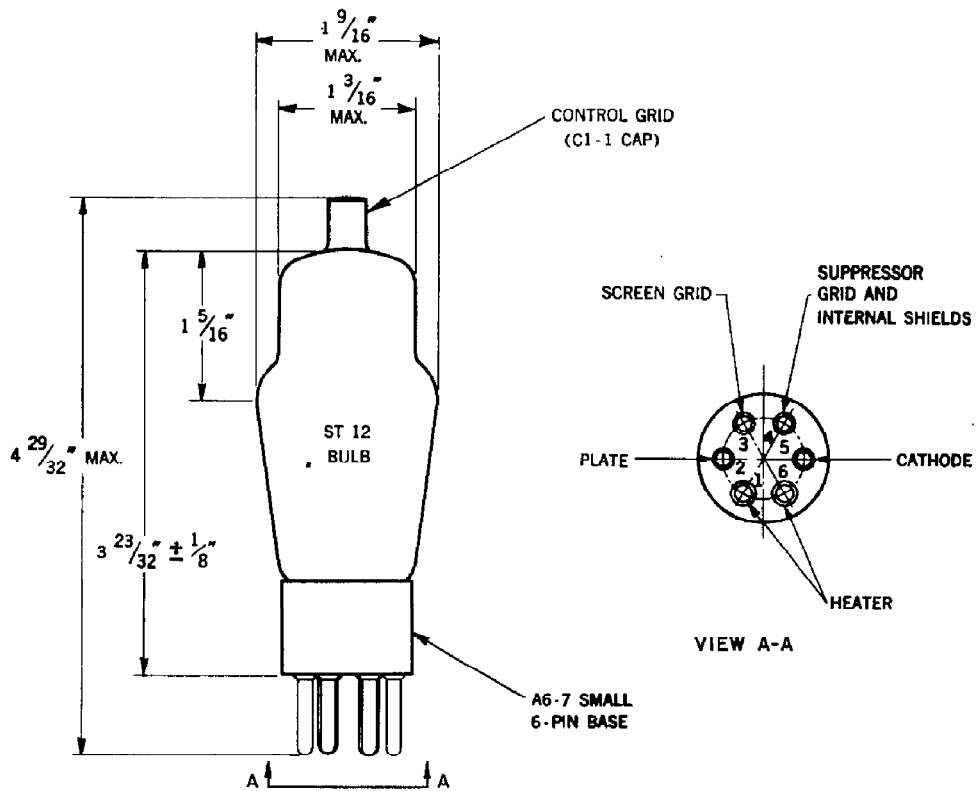
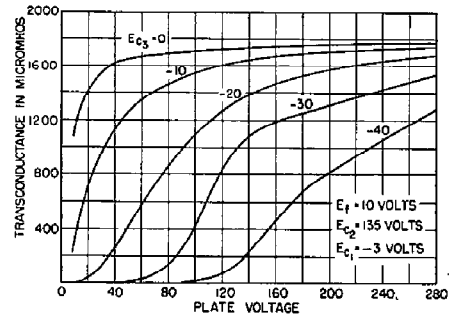
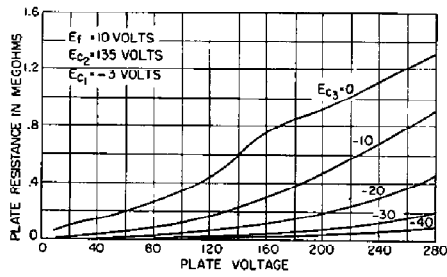

Western Electric 338A Vacuum Tube

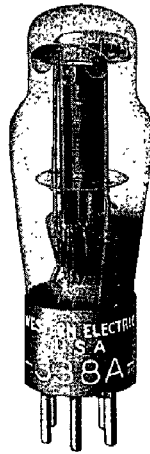

Classification—Three element, argon filled, thyratron, with an indirectly heated cathode

It is primarily a rectifier of low internal impedance whose conduction cycle is determined by the relative instantaneous grid and anode potentials. It is intended for use in special circuits as a relay or trigger-action device. A few of its other possible uses are: as a controlled-frequency oscillator giving a square wave form, as a voltmeter or volume level-indicator, as a source of sweep-voltage for a linear time axis, or as a variable-voltage rectifier.

Dimensions—The dimensions and outline diagrams are given in Figures 1 and 2. The overall dimensions are:

Maximum length. $4\frac{7}{16}$ "
Diameter. $1\frac{9}{16}$ "

Mounting—This vacuum tube employs a standard five-pin thrust type base suitable for use in a Western Electric 141A or similar socket. The arrangement of electrode connections to the base terminals is shown in Figure 2.

It may be mounted in either a vertical or horizontal position, although the vertical position is preferable.

FILE: THYRATRON SECTION

Heater Rating

Heater potential	10.0 volts
Nominal heater current	0.5 ampere
Required heating time	60 seconds

The heater element of this tube is designed to operate on a voltage basis from a direct or alternating current supply. The voltage should be maintained to within 5% of its rated value (10 volts). Operation of the heater element above the upper limit will definitely reduce the life of the tube, while a decrease below the lower limit may cause immediate failure.

Sufficient time should always be allowed for the cathode temperature to reach its normal operating value before anode current is drawn. Failure to allow sufficient time may result in immediate failure.

Operating Conditions

Approximate tube voltage drop	15 volts
Max. peak voltage between anode and grid	325 volts
Max. instantaneous anode current	0.600 ampere
Max. average anode current	0.100 ampere
Max. time of averaging anode current	5 seconds
Max. instantaneous grid current	0.010 ampere
Max. voltage between heater and cathode	50 volts
Operating ambient temperature range	-20° to +50°C.
Normal deionization time	1000 microseconds

The characteristics of the 338A tube are such that, for any given anode potential, there is a critical grid potential. If the grid is held more negative than this value and the tube is non-conducting, the anode current will remain zero. If it is made less negative, the current will assume a value determined by the applied potential and the resistance in the anode circuit. To extinguish the discharge and return the current to zero, the positive anode potential must be removed. When current is flowing a visible discharge occurs in the tube. Under this condition, the tube voltage drop is practically independent of the value of both the anode current and the grid potential. A protective resistance should always be included in the circuit to limit the anode current to the rated values. A typical curve relating the critical grid potential to the anode potential is shown in Figure 3. This characteristic may vary from tube to tube and during the life of a given tube.

Sufficient resistance must always be included in the grid circuit to limit the negative grid potential to 10 volts when anode current is flowing. Failure to observe this precaution will result in short tube life.

Typical Circuits

The tube may be used in a variety of circuits adapted to the application of thyratrons. Two general types are common. One use of the tube is to produce a saw-toothed, current wave. The circuit for this application is shown in Figure 4. The resistance R should, ordinarily, be at least 100,000 ohms, and the product RC (C in farads) approximately equal to the desired fundamental period.

The second general use for the tube is as a relay device. In this application the anode may be supplied from either alternating or direct current. When supplied from direct current, the circuit, Figure 5, possesses a "lock-in" feature, since the anode potential must be removed momentarily in order to restore the tube to the non-conducting condition. When supplied from alternating current, the circuit possesses no "lock-in" feature, but the average anode current may be controlled by the relative phase of grid and anode potentials. The schematic circuit for this application is shown in Figure 6. Figure 7 is a simplified circuit employing a photoelectric cell in place of the resistance, R, used in the phase shifting device in Figure 6. The photoelectric cell, however, is equivalent to a variable resistance in the sense that the current passed will depend upon the amount of light falling upon it.

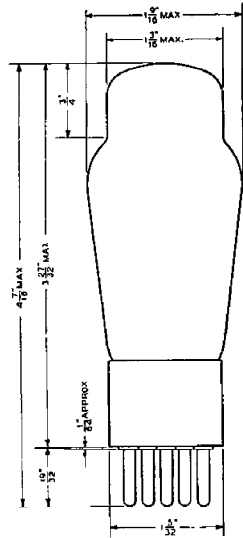

FIG. 1

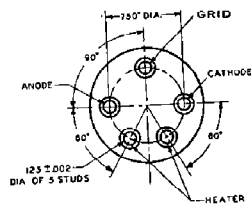

FIG. 2

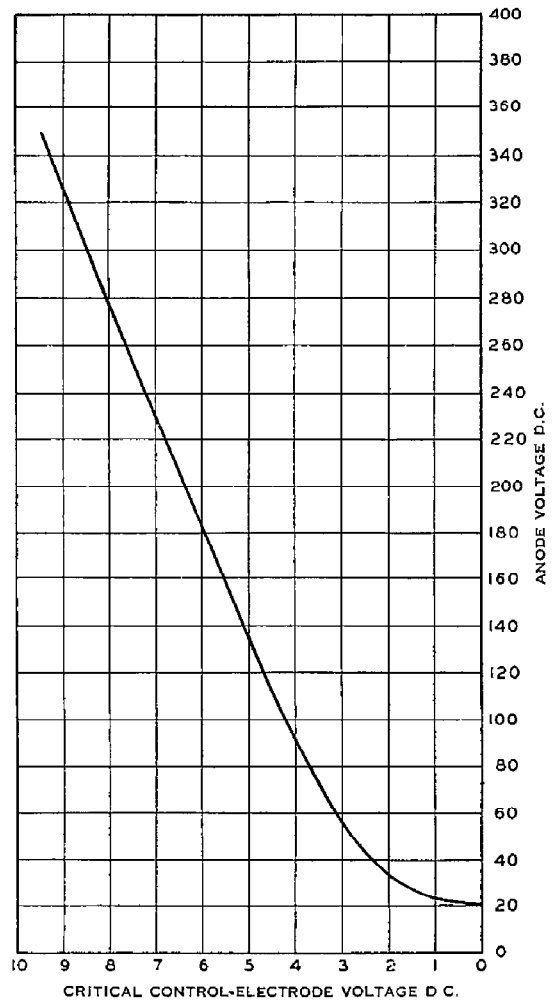

FIG. 3

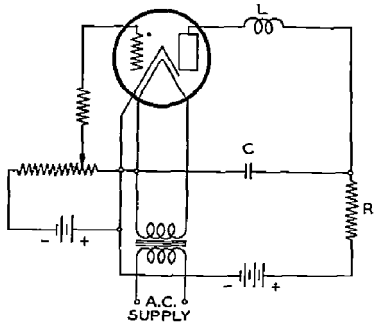

FIG. 4

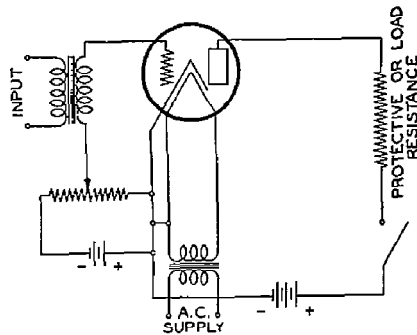

FIG. 5

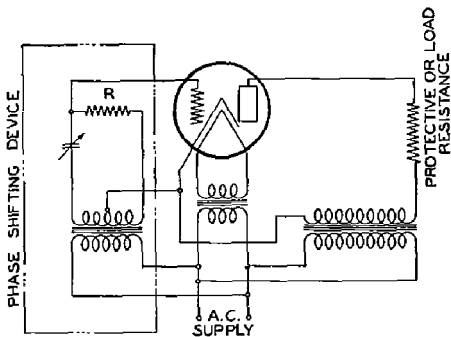

FIG. 6

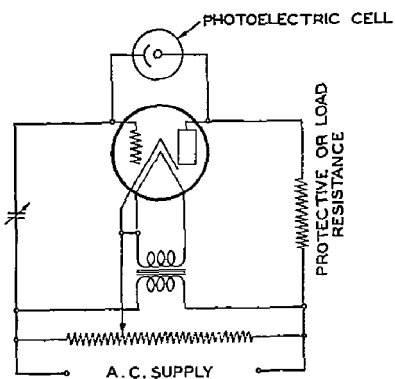
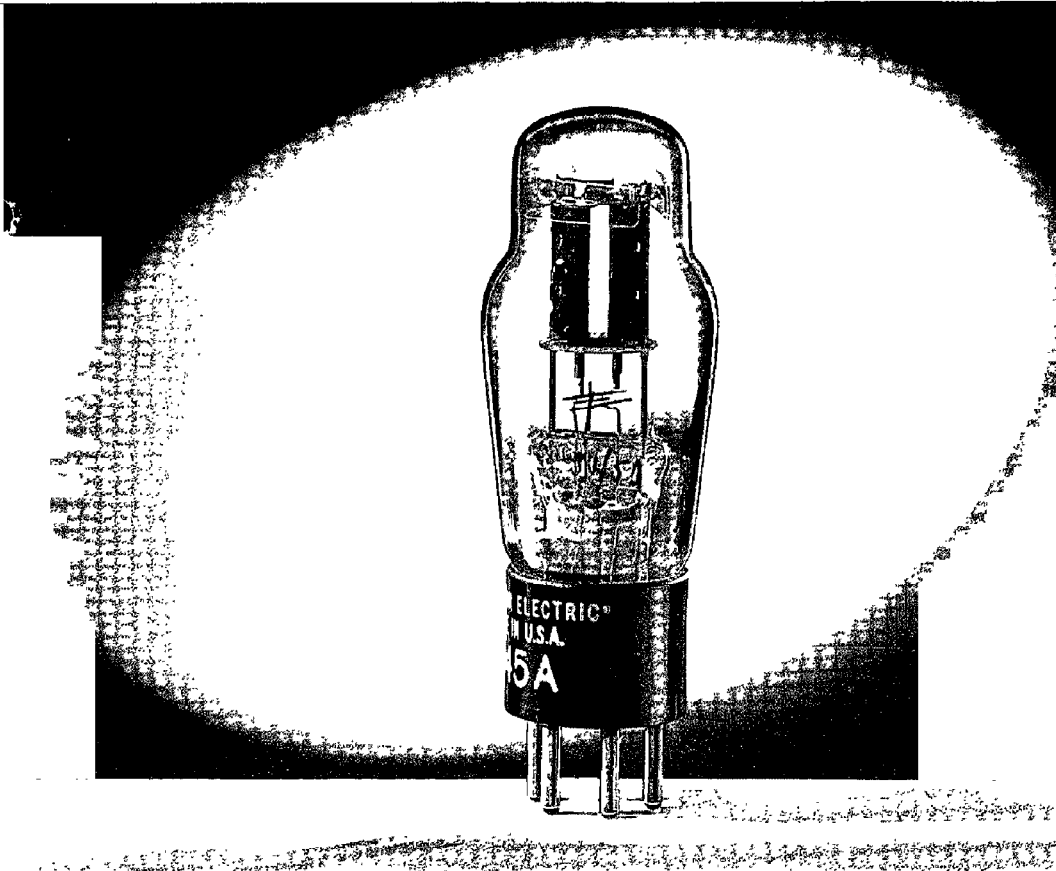

FIG. 7

A development of Bell Telephone Laboratories, Incorporated,
 the research laboratories of the American Telephone and Tele-
 graph Company and the Western Electric Company



RECTIFIER
FULL-WAVE, HIGH VACUUM

Western Electric

DESCRIPTION

The 345A is a full-wave rectifier with indirectly heated cathodes. It is designed to supply direct current from an alternating current source or to rectify radio-frequency currents for feedback purposes in broadcast transmitters.

CHARACTERISTICS

Heater Voltage	6.3 volts
Maximum Plate Voltage (RMS) per Plate	400 volts
Maximum D-C Output Current	100 milliamperes



GENERAL CHARACTERISTICS**ELECTRICAL DATA**

Heater Voltage	6.3 volts
Heater Current	1.0 ampere

MECHANICAL DATA

Cathode	Coated unipotential
Bulb	ST12
Base	Small 5-pin
Mounting Position	Any
Dimensions and pin connections shown in outline drawing on Page 4	

MAXIMUM RATINGS, Design-Center Values

Peak Inverse Voltage	1250 volts
Peak Plate Current per Plate	300 milliamperes
Peak Transient Plate Current per Plate	1.0 ampere
Peak Heater-Cathode Voltage	450 volts

With Choke-Input Filter:

A-C Plate Voltage per Plate (RMS)	400 volts
D-C Output Current	100 milliamperes
Minimum Input-Choke Inductance	4 henrys

With Condenser-Input Filter:

A-C Plate Voltage per Plate (RMS)	350 volts
D-C Output Current	100 milliamperes
Minimum Total Effective Plate-Supply Impedance per Plate	75 ohms

TYPICAL OPERATING CONDITIONS**With Choke-Input Filter:**

A-C Plate Voltage per Plate (RMS)	350 volts
D-C Output Current	100 milliamperes
D-C Output Voltage, Approximate, at Input to Filter	290 volts
Filter Input Choke	6 henrys

With Condenser-Input Filter:

A-C Plate Voltage per Plate (RMS)	300 volts
D-C Output Current	90 milliamperes
D-C Output Volts, Approximate, at Input to Filter	340 volts
Total Effective Plate-Supply Impedance per Plate	150 ohms
Filter Input Condenser	4 microfarads

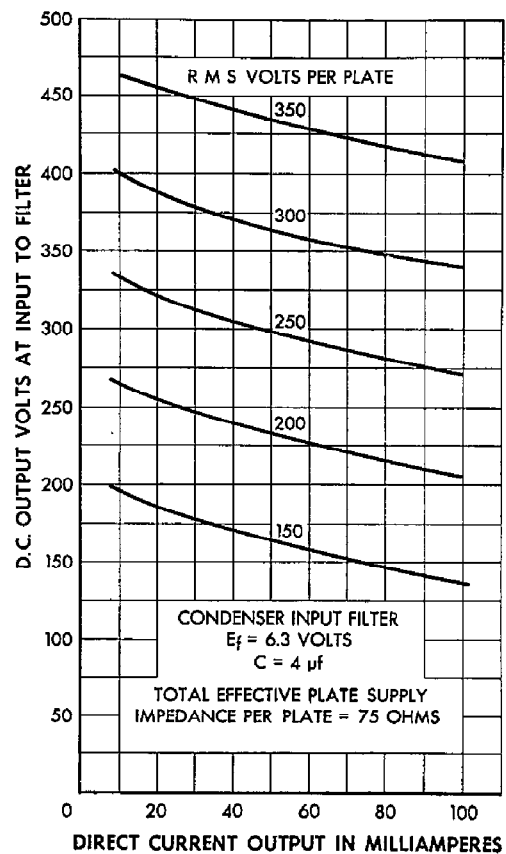
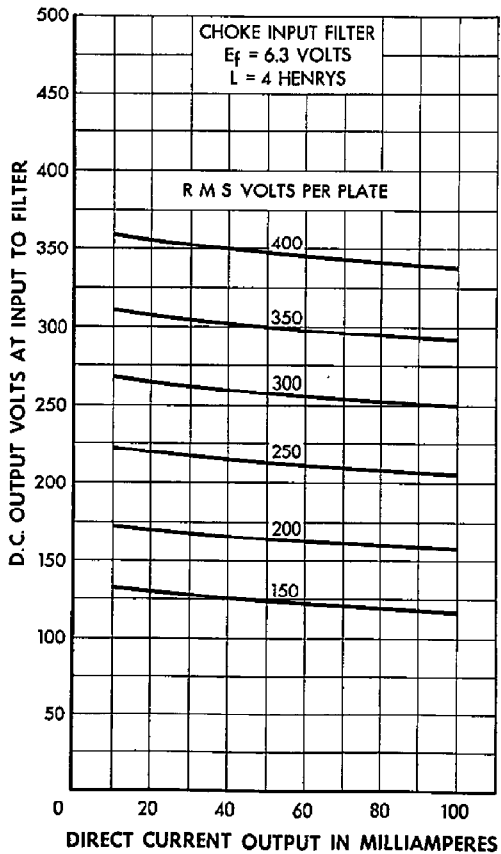
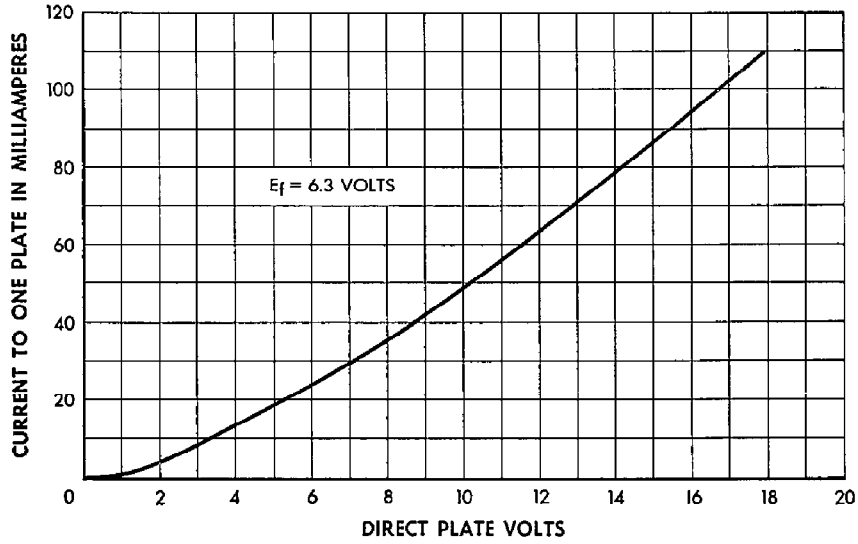

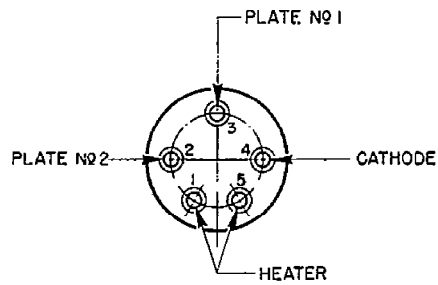
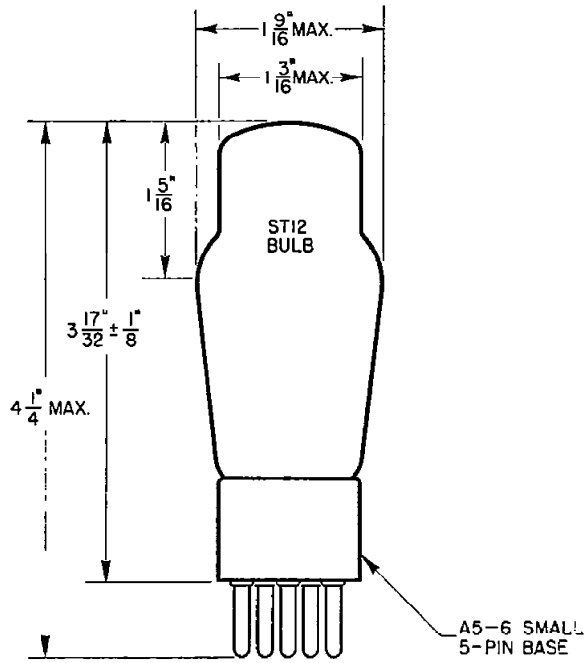

Western Electric

A development of Bell Telephone Laboratories, the research laboratories of the American Telephone and Telegraph Company and the Western Electric Company

ELECTRON TUBE DATA SHEET
WESTERN ELECTRIC 346B ELECTRON TUBE



346B

DESCRIPTION

The 346B is a three-electrode, inert-gas-filled, cold cathode tube for use in relay, voltage regulator, or rectifier circuits. This tube is especially suitable for use in control circuits such as in triggering, counting, or switching apparatus.

MAXIMUM RATINGS

Peak Anode Voltage		225 volts
Average Cathode Current	10	100 milliamperes
Average Life, Approximate	10000	10 hours

File: Cold Cathode Section
Issue 6, April 1956

346B

MAXIMUM RATINGS, Absolute Values

Forward Peak Anode Voltage	225 volts
Forward Cathode Current ¹	
Peak	100 milliamperes
Average	35 milliamperes
Averaging Time	2 seconds
Inverse Peak Anode Current ¹	5 milliamperes
Ambient Temperature Limits	-55 to +85 centigrade

ELECTRICAL DATA

	<u>Min.</u>	<u>Bogey</u>	<u>Max.</u>
Starter Breakdown Voltage ²	65	70	89 volts
Starter Voltage Drop at 20 Milliamperes	52	60	74 volts
Anode Voltage Drop at 20 Milliamperes.	72	80	90 volts
Transfer Current	See curve - Fig. 3		
Ionization Time - Starter Gap ³	---	6	---
Deionization Time, Approximate			
Starter Gap	---	2	---
Main Gap	---	8	---
Inverse Current at			
-120 Volts Anode Potential ⁴	---	---	3 milliamperes

MECHANICAL DATA

Mounting Position Any
 Net Weight, Approximate 1 ounce
 Dimensions and pin connections shown in outline drawing on page 4

- Note 1: Sufficient resistance must be used in series with the tube to assure that the electrode currents do not exceed their maximum rated values.
- Note 2: Limits apply immediately after tube has conducted current. If the tube has been idle, these values initially may be as much as 3 volts higher or lower.
- Note 3: With 15 volts starter overvoltage (15 volts above Starter Breakdown Voltage) with tube in total darkness.
- Note 4: Negative anode voltage applied through 8000 ohms. Starter connected to anode through 100000 ohms.

HANDLING

Western Electric cold cathode tubes contain a minute amount of radium bromide which is a radioactive material. The amount in most types is too small to require any special care in use, handling or disposal.

A few types contain a larger quantity of radium bromide in which the radium approximates that found on a luminous watch dial. These types bear a red three-bladed propeller-shaped symbol on the tube envelope. Instructions for handling such tubes are given below and also in Bell System Practices for Central Office maintenance.

Installations ordinarily require no precautions against radiation. However, quantities of the tubes should not be so installed, or so stored outside the shipping carton, that they will be within a few inches of personnel or in proximity to photographic film for extended periods of time. For example, however, a 40-hour week exposure at about one (1) foot from a bank of 500 tubes (covering an area of 20 inches x 45 inches) is well within the accepted tolerance limits for personnel. Reasonable care should be exercised in handling and disposal of broken tubes. In general, attention should be given to the following:

- (a) Avoid breathing dust or vapors from broken tubes.
- (b) Avoid contacting broken parts with bare hands.
- (c) Use wet rag to pick up broken parts. Wrap broken parts in rag and tie securely so as to form a package. Thoroughly wash hands after disposal.
- (d) Dispose of broken or defective tubes as they are taken out of service. One or two tubes at a time may be disposed of with normal waste material. Accumulation of tubes in one concentrated area of the place of final disposition should be avoided.

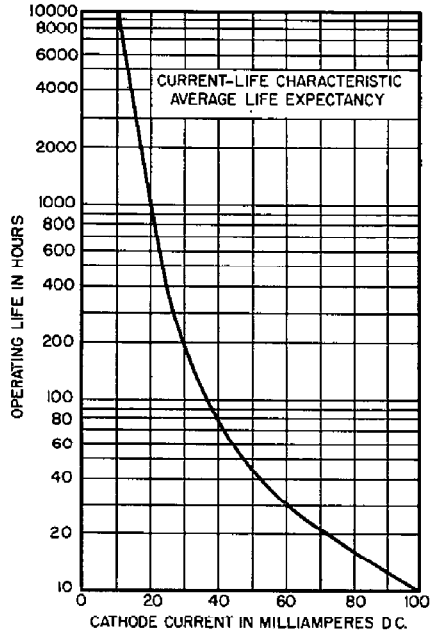

FIG. 1

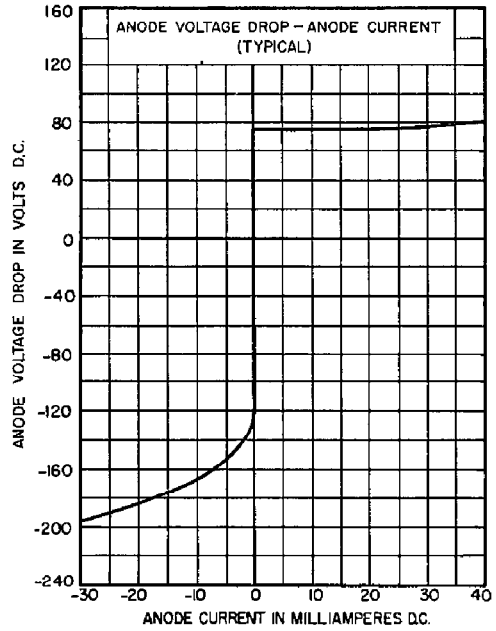

FIG. 2

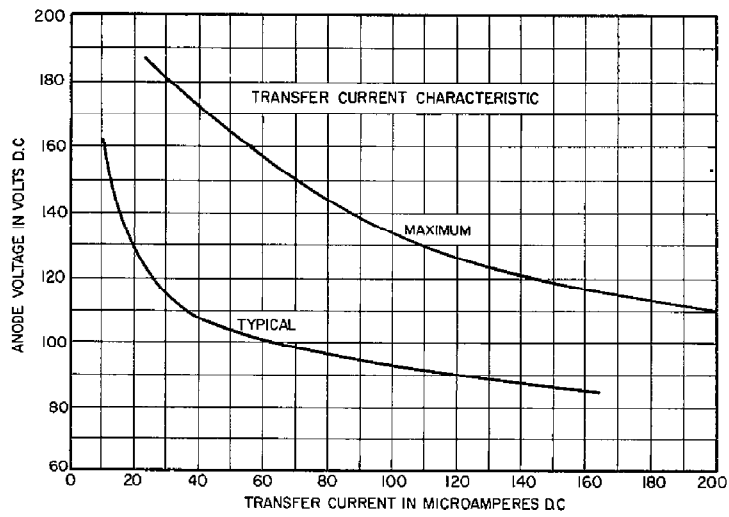
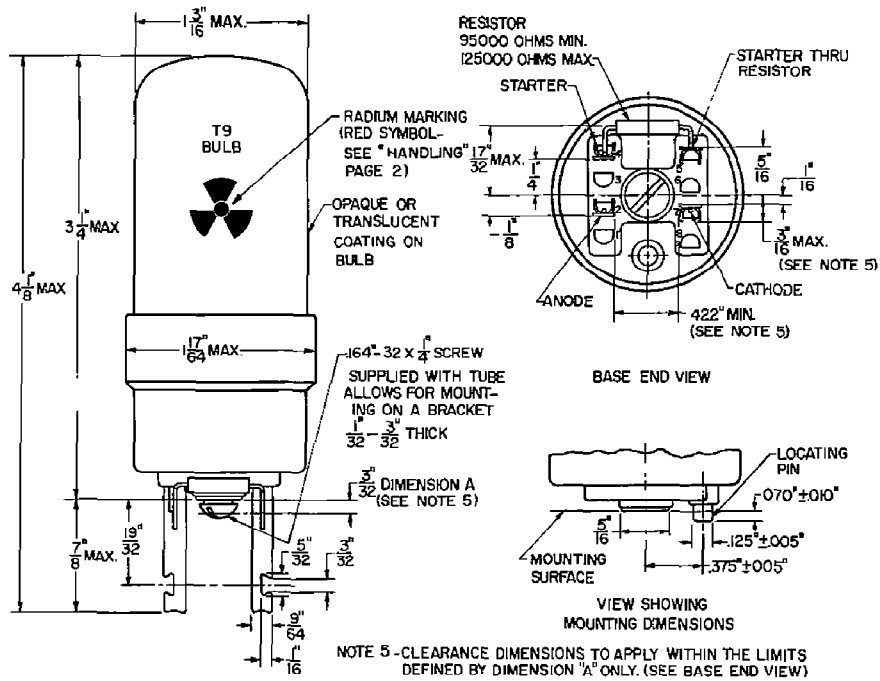
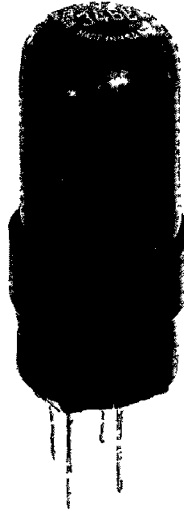

FIG. 3



A development of Bell Telephone Laboratories, the research laboratories of the American Telephone and Telegraph Company and the Western Electric Company.

ELECTRON TUBE DATA SHEET
WESTERN ELECTRIC 346C ELECTRON TUBE



346C

DESCRIPTION

The 346C is a three-electrode, inert-gas-filled, cold cathode tube for use in relay, voltage regulator, or rectifier circuits. This tube is especially suitable for use in control circuits such as in triggering, counting, or switching apparatus.

CHARACTERISTICS

Peak Anode Voltage		225	volts
Average Cathode Current	10	100	milliamperes
Average Life, Approximate	10000	10	hours

File: Cold Cathode Section

MAXIMUM RATINGS, Absolute System (Note 1)

Forward Peak Anode Voltage	225	volts
Forward Cathode Current (Note 2)		
Peak	100	milliamperes
Average	35	milliamperes
Averaging Time	2	seconds
Inverse Peak Anode Current (Note 2)	5	milliamperes
Ambient Temperature Limits	-55 to +85	centigrade

ELECTRICAL DATA, Throughout Life

	<u>Min.</u>	<u>Bogey</u>	<u>Max.</u>	
Starter Breakdown Voltage (Note 3)	65	70	89	volts
Starter Voltage Drop at 20 milliamperes.	52	60	74	volts
Anode Voltage Drop at 20 milliamperes.	72	80	90	volts
Transfer Current	See curve - Fig. 3			
Ionization Time - Starter Gap (Note 4)	-	6	-	milliseconds
Deionization Time, Approximate				
Starter Gap	-	2	-	milliseconds
Main Gap	-	8	-	milliseconds
Inverse Current at -120 Volts Anode Potential (Note 5)	-	-	3	milliamperes

MECHANICAL DATA

Mounting Position Any
 Net Weight, Approximate 1 Ounce
 Dimensions and pin connections shown in outline drawing on page 4.

HANDLING

This tube contains a small amount of krypton-85 gas which is a by-product radioactive material. The amount of krypton-85 is less than five microcuries, which is too small an amount to require any special care in use.

Atomic Energy Commission regulations require that the individual tube carton for tubes containing by-product radioactive material be appropriately marked. The marking includes the statement that tube disposal should be in approved manner.

Approved instructions for disposal of tubes containing krypton-85 are as follows;

Tubes to be disposed of should be broken or crushed in a well ventilated place releasing any resulting vapors to the outside atmosphere. The residual broken or crushed tubes should be disposed of in a normal public trash disposal system. Tubes should be disposed of at a rate of not more than 100 each week from any one location. Avoid breathing vapors from broken tubes.

Note 1: In the "Absolute System" the maximum ratings specified are limiting values above which the serviceability of the device may be impaired from the viewpoint of life and satisfactory performance. Maximum ratings, as such, do not constitute a set of operating conditions and all values may not, therefore, be attained simultaneously.

Note 2: Sufficient resistance must be used in series with the tube to assure that the electrode currents do not exceed their maximum rated values.

Note 3: Limits apply immediately after tube has conducted current. If the tube has been idle, these values initially may be as much as 3 volts higher or lower.

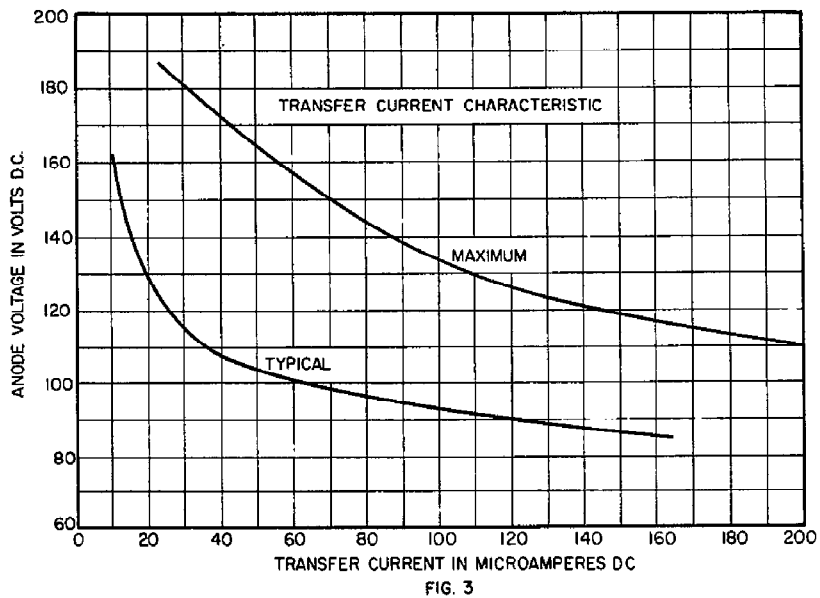
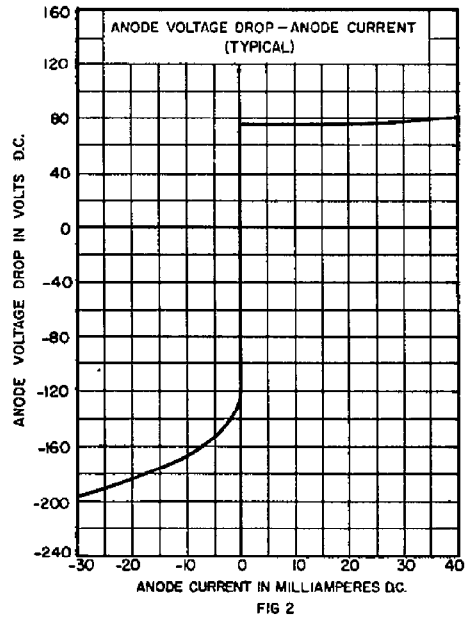
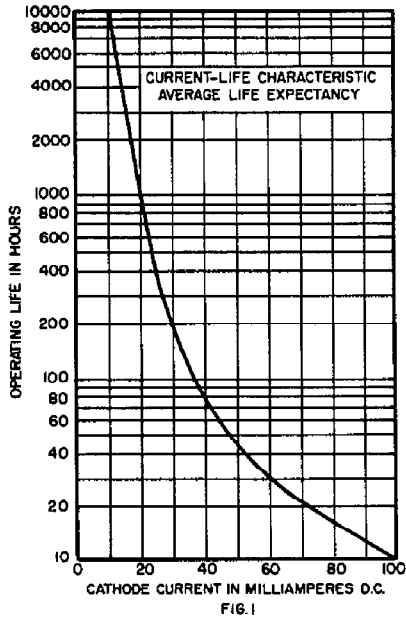

Note 4: With 15 volts starter overvoltage (15 volts above Starter Breakdown Voltage) with tube in total darkness.

Note 5: Negative anode voltage applied through 8000 ohms. Starter connected to anode through 100,000 ohms.

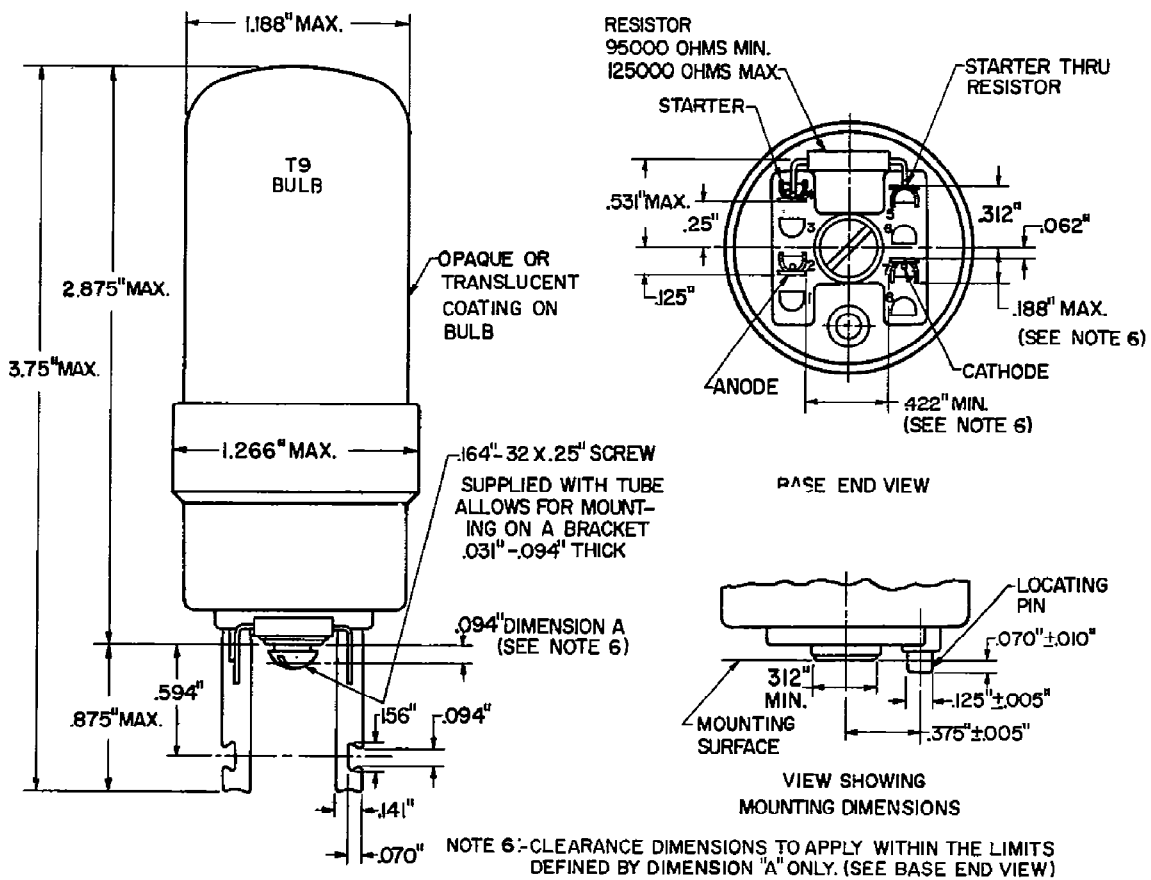

A development of Bell Telephone Laboratories, the research laboratories of the American Telephone and Telegraph Company and the Western Electric Company.

PRINTED IN U.S.A.

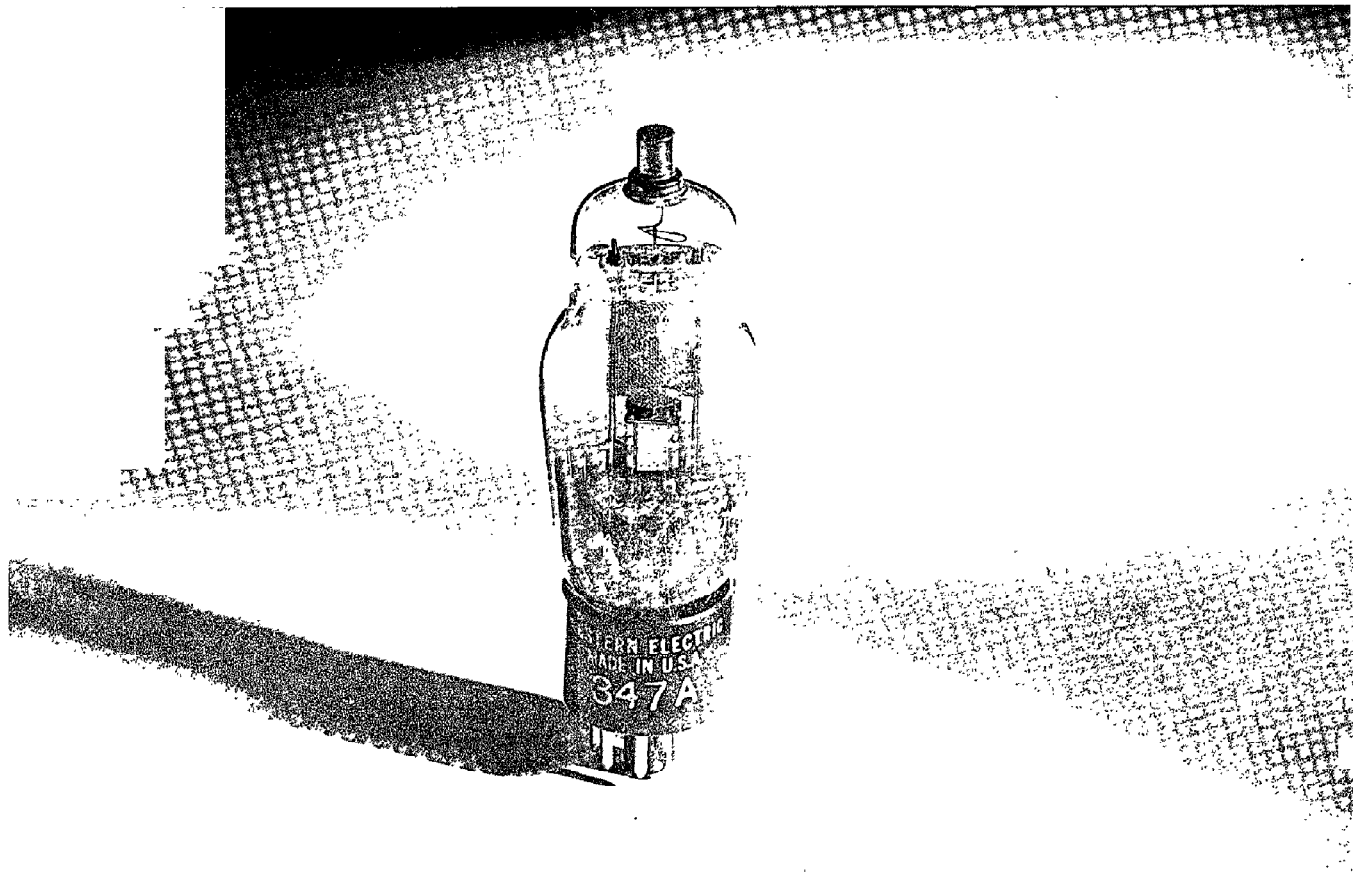

**TRIODE
AUDIO-FREQUENCY AMPLIFIER**

Western Electric

DESCRIPTION

The 347A is a triode designed for use as an audio-frequency amplifier where exceptionally low tube noise is required. Special design features minimize both the microphonic noise and the hum produced by a.c. operation of the heater.

CHARACTERISTICS

Heater Voltage	6.3 volts
Maximum Plate Voltage	180 volts
Amplification Factor	15

GENERAL CHARACTERISTICS**ELECTRICAL DATA**

Heater Voltage, A-C or D-C	6.3 volts
Heater Current	0.50 ampere
Direct Interelectrode Capacitances (without external shield)	
Grid to Plate	1.9 uuf
Input	2.4 uuf
Output	3.8 uuf

MECHANICAL DATA

Cathode	Coated Unipotential
Bulb	ST 12
Base	Small Shell Octal 5-Pin
Mounting Position	Any
Dimensions and pin connections shown in outline drawing on Page 5	

MAXIMUM RATINGS, Design-Center Values

Plate Voltage	180 volts
Plate Dissipation	2.0 watts
Plate Current	10.0 milliamperes
Heater-Cathode Voltage	30 volts

TYPICAL OPERATING CONDITIONS AND CHARACTERISTICS—CLASS A₁ AMPLIFIER

Plate Voltage	120	135	160	180 volts
Grid Voltage	-6.0	-4.5	-6.0	-7.5 volts
Peak A-F Grid Voltage	6.0	4.5	6.0	7.5 volts
Plate Current	1.0	3.0	3.0	2.8 milliamperes
Transconductance	560	890	880	840 micromhos
Amplification Factor	14.8	15.4	15.5	15.3
Plate Resistance	26600	17300	17700	18300 ohms
Load Resistance	100000	100000	100000	100000 ohms
Maximum Signal Power Output	24	18	31	48 milliwatts
Total Harmonic Distortion	4	2.5	3	3 percent

HUM

Under typical operating conditions, and with the cathode of the tube connected to the mid-point of the heater circuit, the equivalent hum voltage in the grid circuit will be less than 12 microvolts at the supply frequency and less than 6.0 microvolts at

double the supply frequency.

If the insulation leakage and capacitance between the external grid and heater connections are kept reasonably low, a resistance of 2 megohms may be used in the grid circuit without materially affecting the hum level.

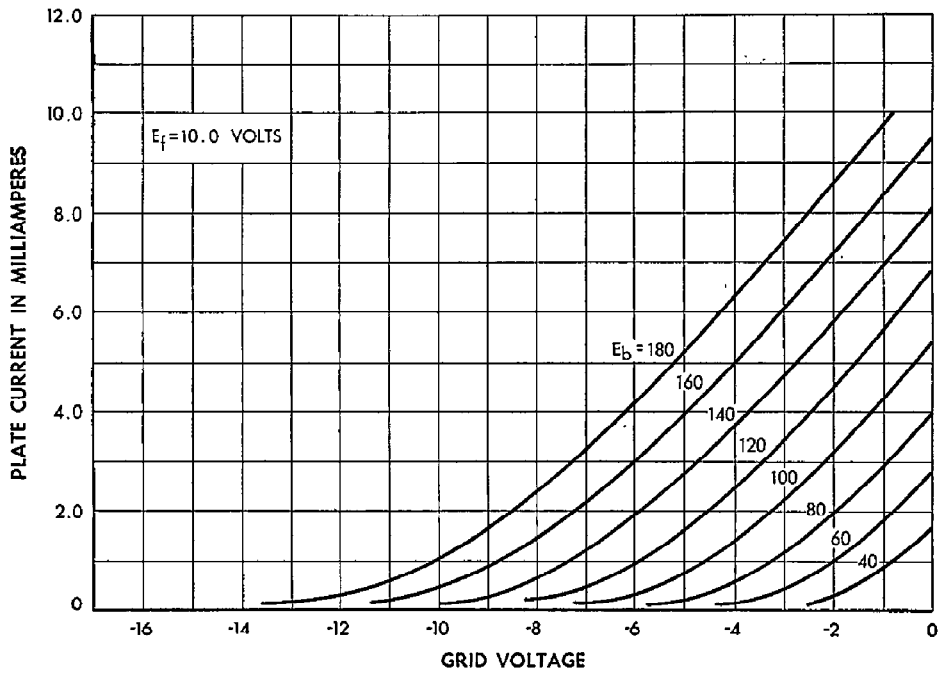
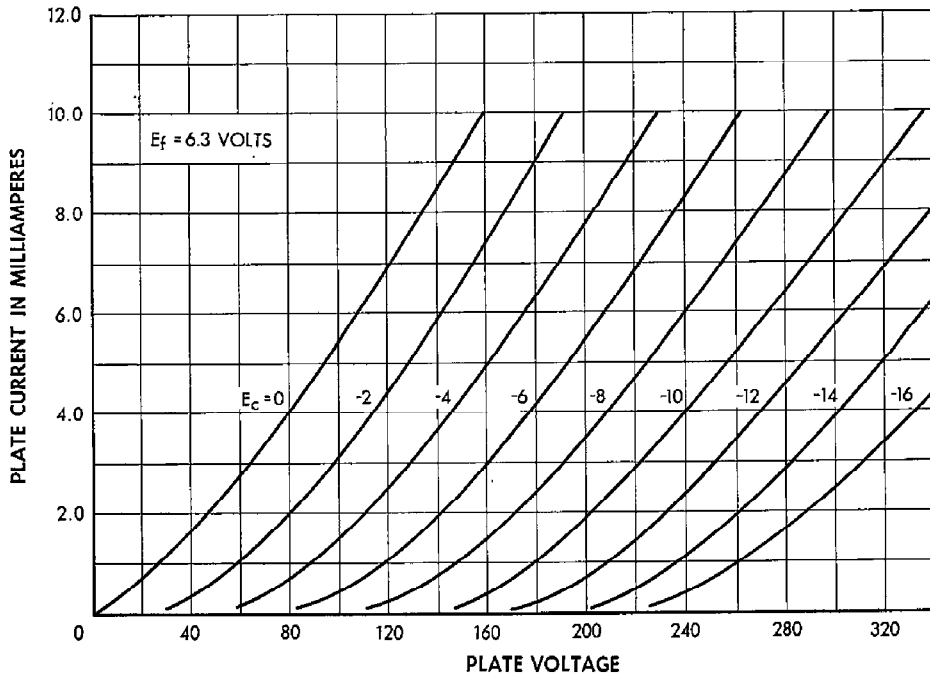

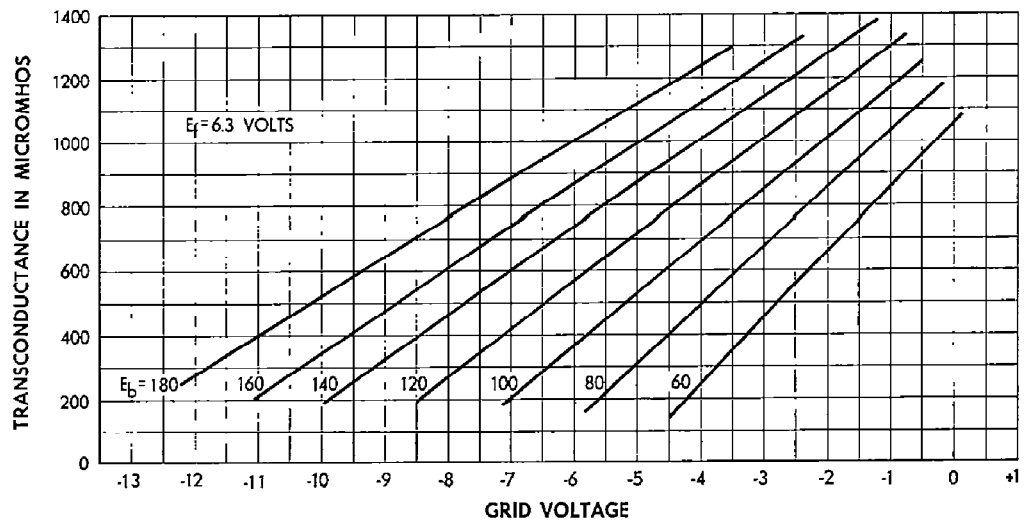
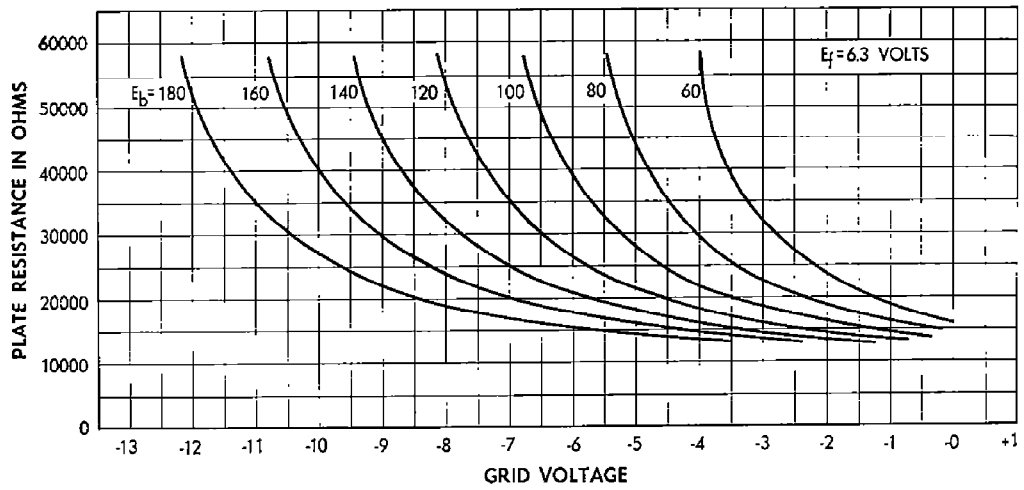
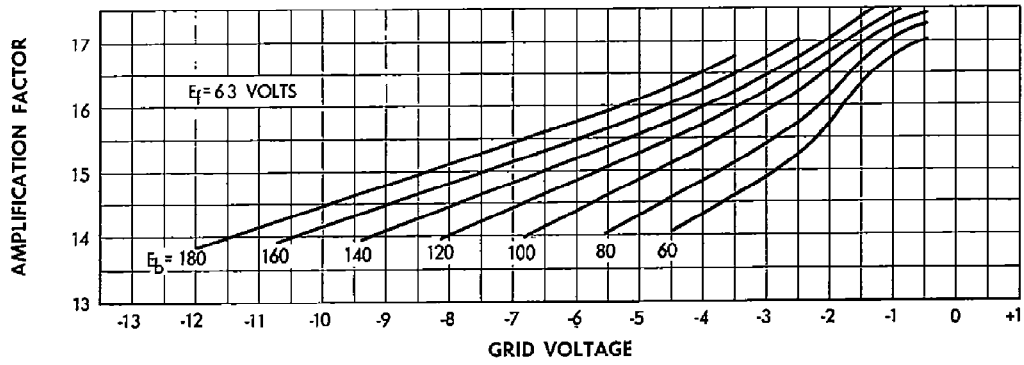

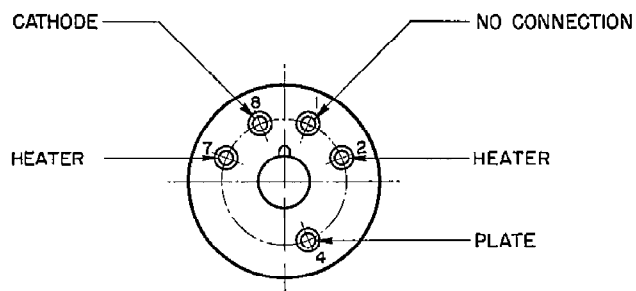
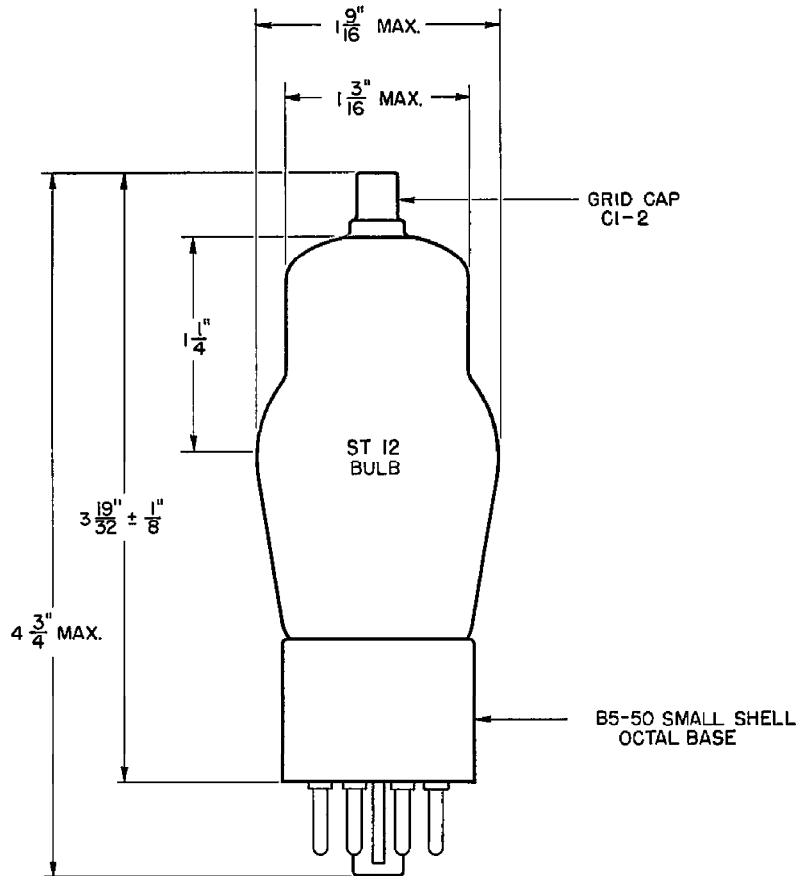

ELECTRON TUBE DATA SHEET
WESTERN ELECTRIC 348A ELECTRON TUBE



348A

DESCRIPTION

The 348A is an indirectly heated cathode type pentode having a separate suppressor grid connection. It is intended for use in audio, carrier and radio-frequency voltage amplifiers, oscillators or modulators. It has special design features to minimize microphonic noise and hum. This tube, except for having a different base, top cap, heater voltage and current rating, is identical to the 310B.

CHARACTERISTICS

Heater Voltage	6.3 volts
Plate Current	5.5 milliamperes
Transconductance	1820 micromhos

$\left(\begin{array}{l} E_b = 180 \text{ volts; } E_{c2} = 135 \text{ volts;} \\ E_{c1} = -3 \text{ volts; } E_{c3} = 0 \end{array} \right)$

File: General Purpose Section
Issue 3, 2-56

348A

GENERAL CHARACTERISTICS

ELECTRICAL DATA

Heater Voltage		6.3 volts
Heater Current		0.50 ampere
Direct Interelectrode Capacitances	without external shield	with external shield (RETMA #311)
Grid to Plate (maximum)	0.016	*0.010 μ f
Input: g1 to (h+k+g2+g3+i.s.)	6.0	*7.0 μ f
Output: p to (h+k+g2+g3+i.s.)	13	*13 μ f

MECHANICAL DATA

Cathode	Coated unipotential
Bulb	ST12
Base	Small, 7-pin octal
Mounting Position	Any
Dimensions and pin connections shown in outline drawing on page 5	

MAXIMUM RATINGS, Design-Center Values

Plate Voltage	250 volts
Screen Grid Voltage	180 volts
Plate Dissipation	2.0 watts
Screen Grid Dissipation	0.4 watt
Cathode Current	10 milliamperes
Heater-Cathode Voltage	30 volts

TYPICAL OPERATING CONDITIONS AND CHARACTERISTICS

Plate	135	180	250 volts
Screen Grid Voltage	135	135	135 volts
Control Grid Voltage	-3	-3	-3 volts
Suppressor Grid Voltage	0	0	0 volts
Plate Current	5.40	5.50	5.60 milliamperes
Screen Grid Current	1.20	1.18	1.17 milliamperes
Peak A-F Signal Voltage	3.00	1.50	2.10 volts
Plate Resistance	0.75	0.90	1.15 megohms
Transconductance	1800	1820	1840 micromhos
Load Resistance	20000	100000	100000 ohms
Power Output	250	150	310 milliwatts
Total Harmonic Distortion	8.5	6	6 per cent
Control Grid Voltage, Approximate, for Plate Current of 10 Microamperes	-9.5	-9.5	-9.5 volts

*With external shield (RETMA #311) connected to cathode pin.

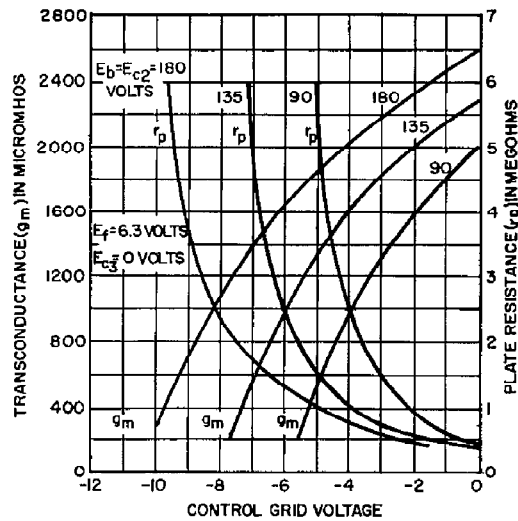
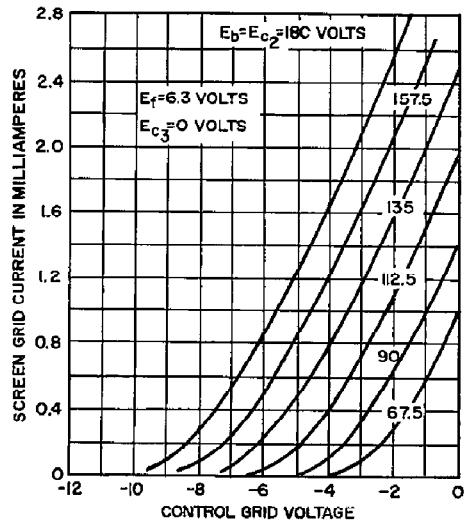
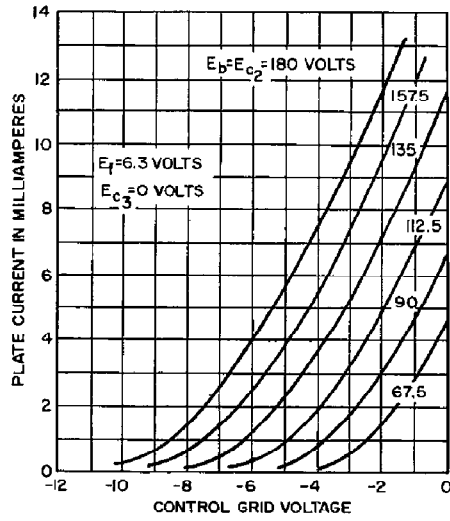

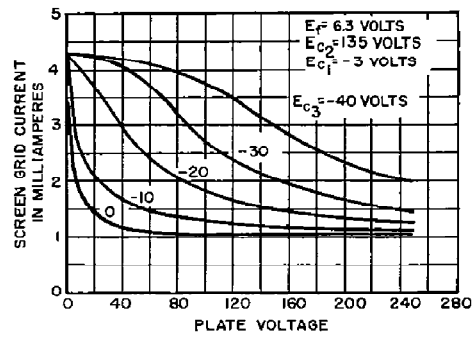
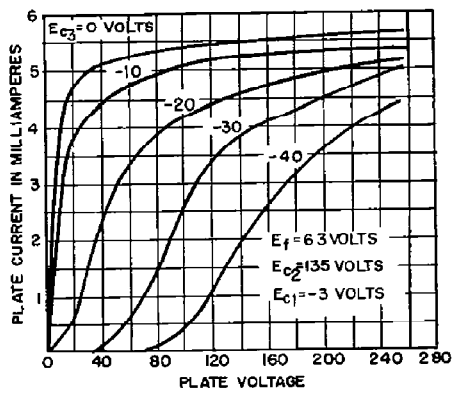
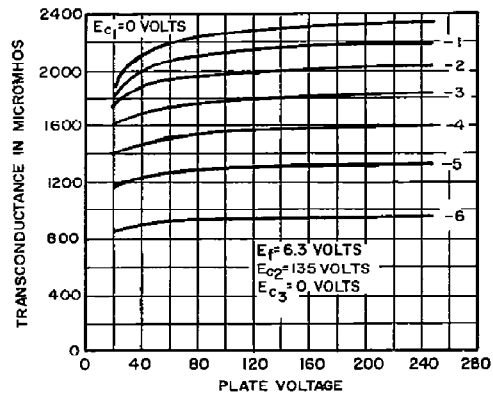
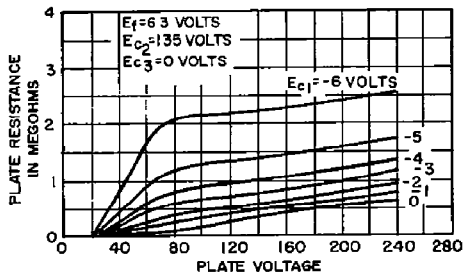
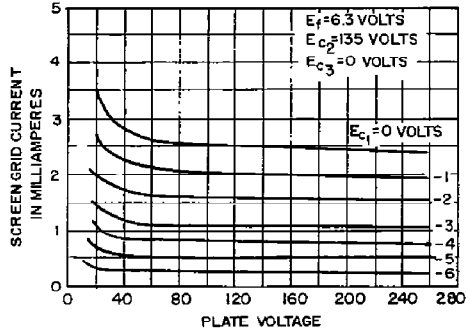
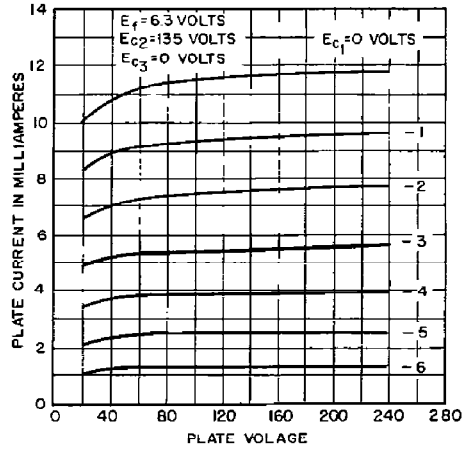

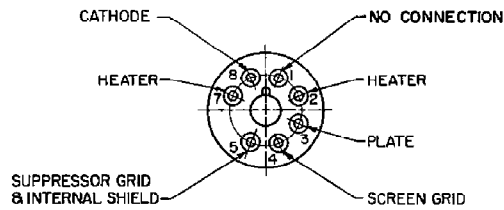
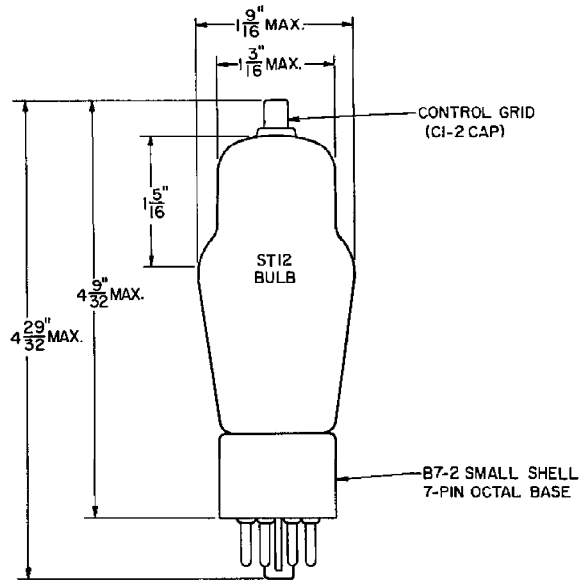
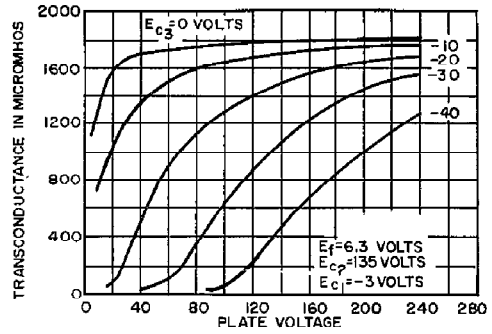
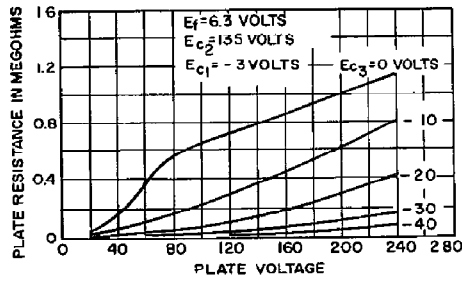

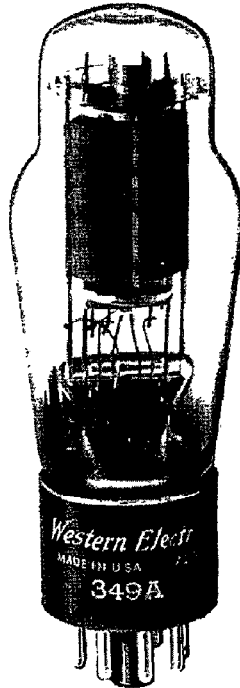

PENTODE

349A

Western Electric

DESCRIPTION

The 349A is a suppressor grid, power pentode with an indirectly heated cathode. It is designed for use as an audio-frequency power amplifier in Class A₁ and AB₁ service.

CHARACTERISTICS

Heater Voltage		6.3 volts
Plate Current	} $E_b = E_{c2} = 250$ volts; {	32.5 milliamperes
Transconductance		4250 micromhos
Power Output		3.5 watts
	} $E_{c1} = -14$ volts {	

GENERAL CHARACTERISTICS**ELECTRICAL DATA**

Heater Voltage, A-C or D-C		6.3 volts
Heater Current		1.0 ampere
Direct Interelectrode Capacitances	without external shield	with external shield (RMA #311)
Grid to Plate	0.46	*0.31 uuf
Input	11.2	*11.7 uuf
Output	8.1	*10.5 uuf

MECHANICAL DATA

Cathode	Coated unipotential
Bulb	ST12
Base	Small shell octal
Mounting Position	Any
Dimensions and pin connections shown in outline drawing on Page 7	

MAXIMUM RATINGS, Design-Center Values

Plate Voltage	250 volts
Screen Grid Voltage	250 volts
Plate Dissipation	12 watts
Screen Grid Dissipation	3.5 watts
Cathode Current	50 milliamperes
Heater-Cathode Voltage	150 volts

TYPICAL OPERATING CONDITIONS AND CHARACTERISTICS**SINGLE TUBE AMPLIFIER — PENTODE CONNECTION**

Plate Voltage	180	250	250 volts
Screen Grid Voltage	180	250	250 volts
Control Grid Voltage	-8	-14	... volts
Cathode Resistor	330 ohms
Peak A-F Grid Voltage	8	10	10 volts
Zero Signal Plate Current	28.0	32.0	32.0 milliamperes
Maximum Signal Plate Current	29.5	34.0	30.5 milliamperes
Zero Signal Screen Grid Current	6.0	6.5	6.5 milliamperes
Maximum Signal Screen Grid Current	8.2	11.0	10.5 milliamperes
Transconductance	4100	4250	4400 micromhos
Plate Resistance	70000	84500	75000 ohms
Load Resistance	5000	7000	7000 ohms
Maximum Signal Power Output	1.8	3.6	3.3 watts
Total Harmonic Distortion	6.3	8.0	8.8 per cent

* With external shield (RMA #311) connected to cathode pin.

SINGLE TUBE AMPLIFIER - TRIODE CONNECTION*

Plate Voltage	250	volts
Control Grid Voltage	-16	volts
Peak A-F Grid Voltage	16	volts
Zero Signal Plate Current	30.0	milliamperes
Maximum Signal Plate Current	33.0	milliamperes
Transconductance	4550	micromhos
Amplification Factor	10	
Plate Resistance	2200	ohms
Load Resistance	4000	ohms
Maximum Signal Power Output	1.3	watts
Total Harmonic Distortion	4.8	per cent

PUSH-PULL AMPLIFIER - PENTODE CONNECTION

Unless otherwise specified, values are for 2 tubes

Plate Voltage	250	250	volts
Screen Grid Voltage	250	250	volts
Control Grid Voltage	-18	...	volts
Cathode Resistor	...	200	ohms
Peak A-F Grid-to-Grid Voltage	36	36	volts
Zero Signal Plate Current	35.5	55.0	milliamperes
Maximum Signal Plate Current	68.0	64.0	milliamperes
Zero Signal Screen Grid Current	8.0	12.0	milliamperes
Maximum Signal Screen Grid Current	20.5	19.5	milliamperes
Effective Load Resistance (plate-to-plate)	7000	7000	ohms
Maximum Signal Power Output	8.2	7.2	watts
Total Harmonic Distortion	5.5	5	per cent

PUSH-PULL AMPLIFIER - TRIODE CONNECTION*

Unless otherwise specified, values are for 2 tubes

Plate Voltage	250	volts
Control Grid Voltage	-18	volts
Peak A-F Grid-to-Grid Voltage	36	volts
Zero Signal Plate Current	47.5	milliamperes
Maximum Signal Plate Current	59.5	milliamperes
Effective Load Resistance (plate-to-plate)	7000	ohms
Maximum Signal Power Output	3.0	watts
Total Harmonic Distortion	3.2	per cent

*Screen grid connected to plate.

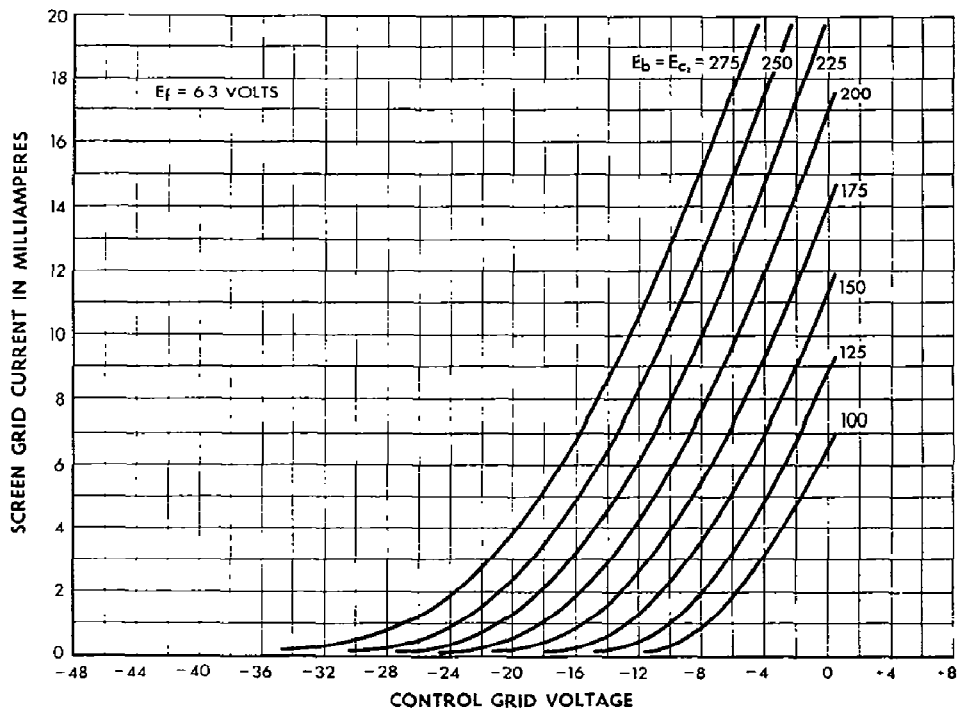
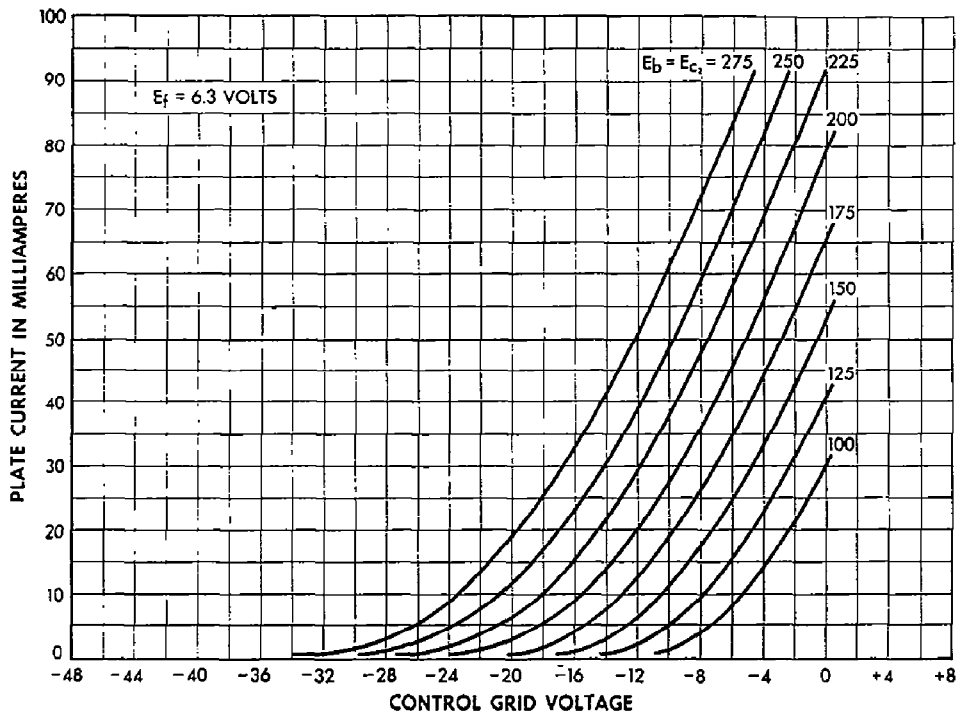

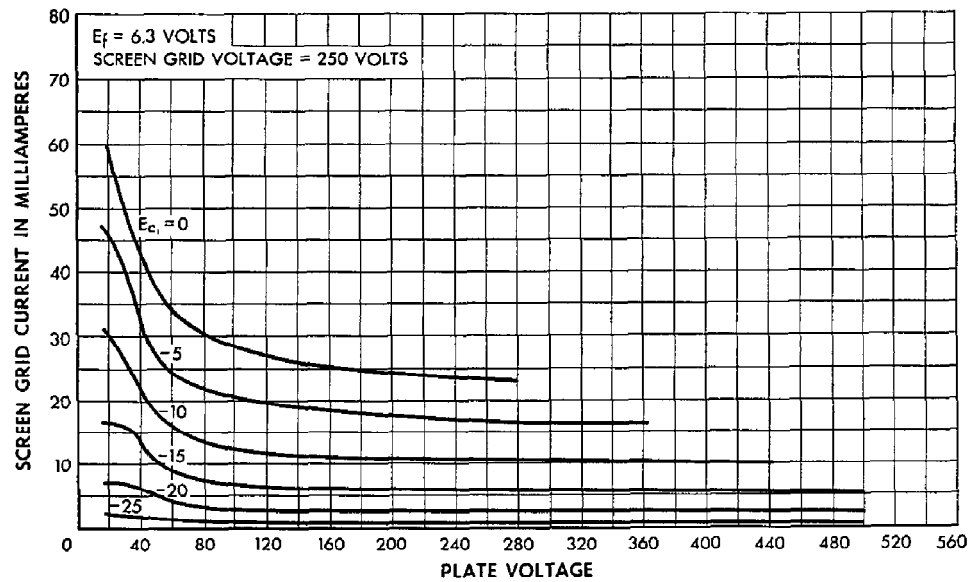
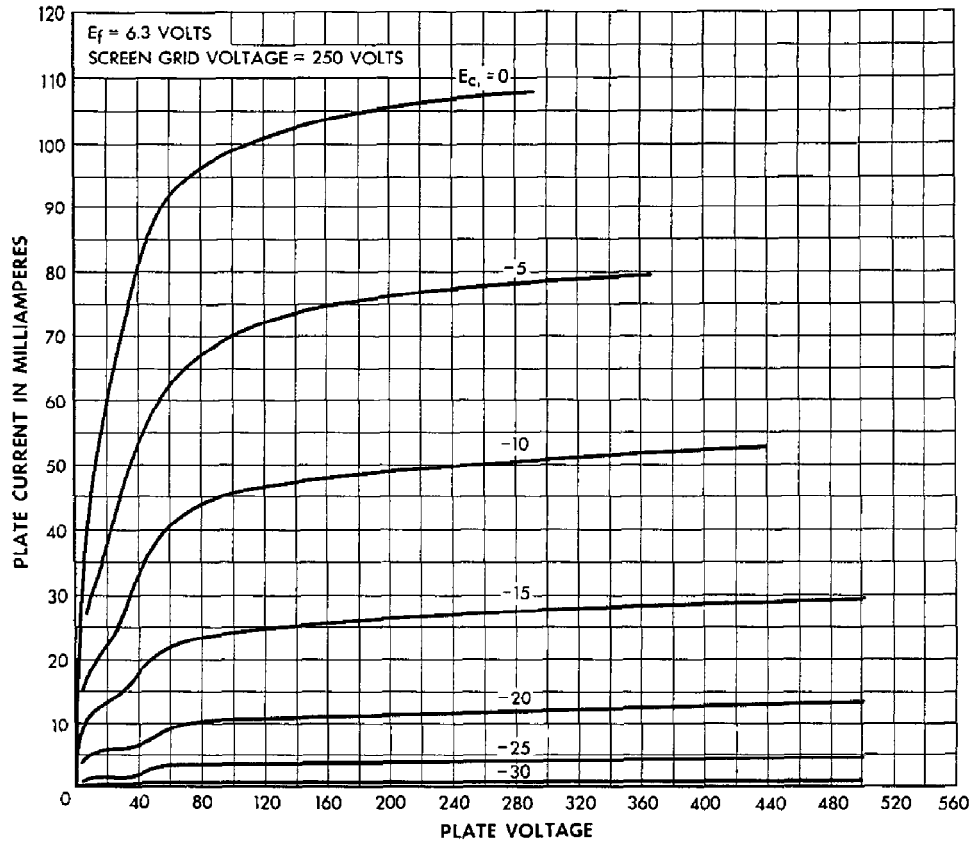

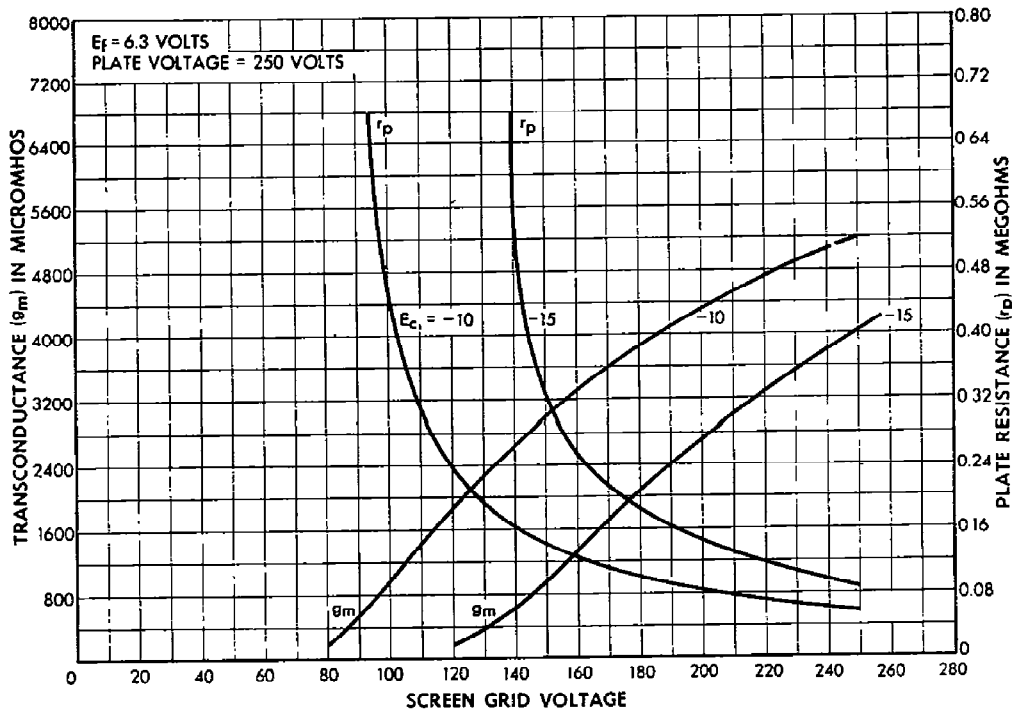
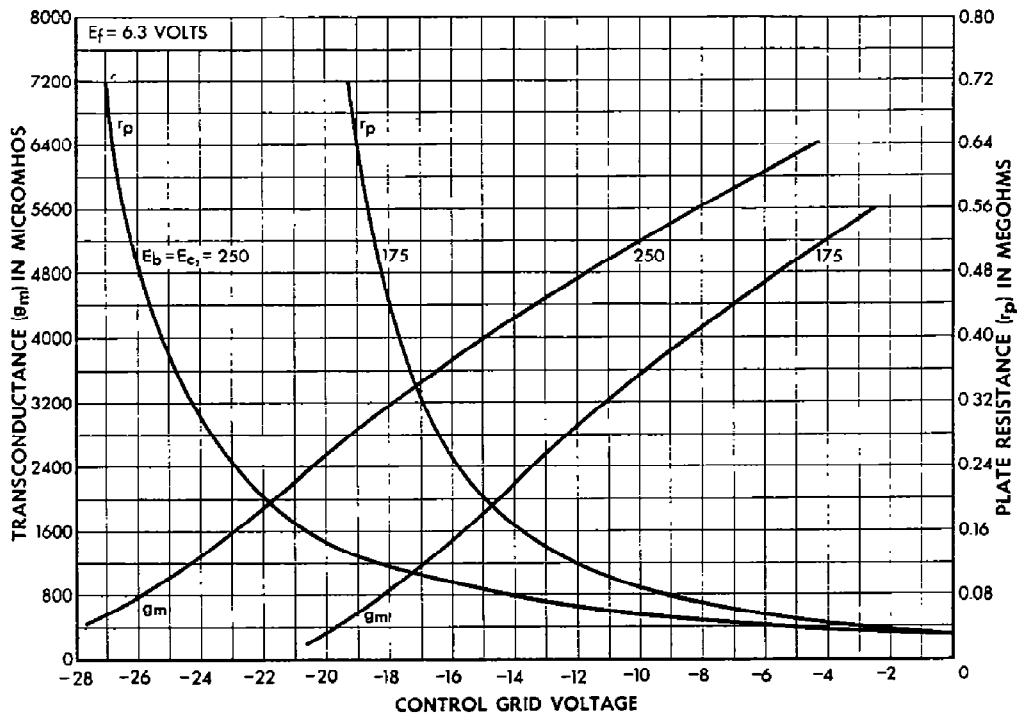

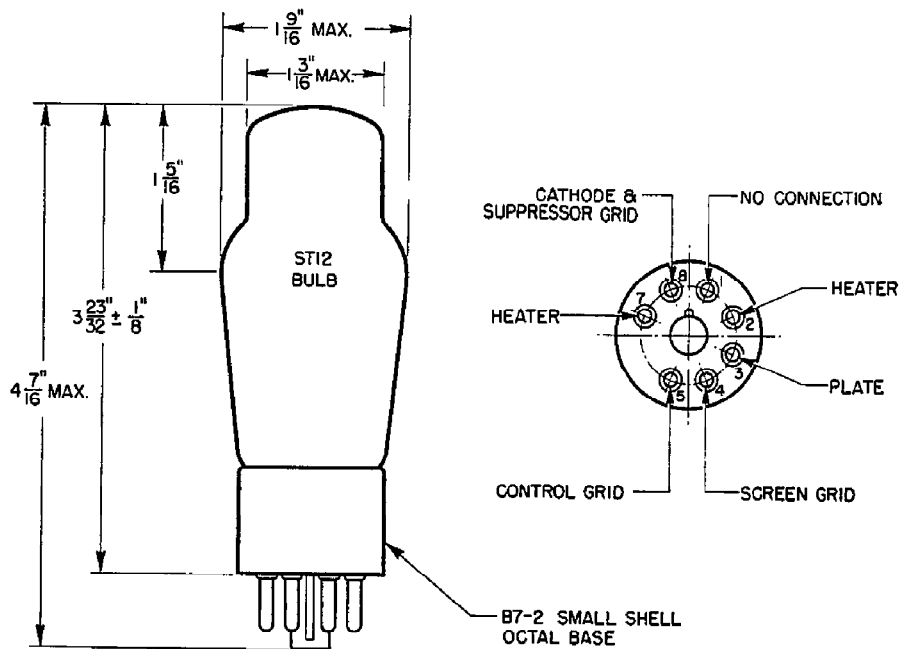
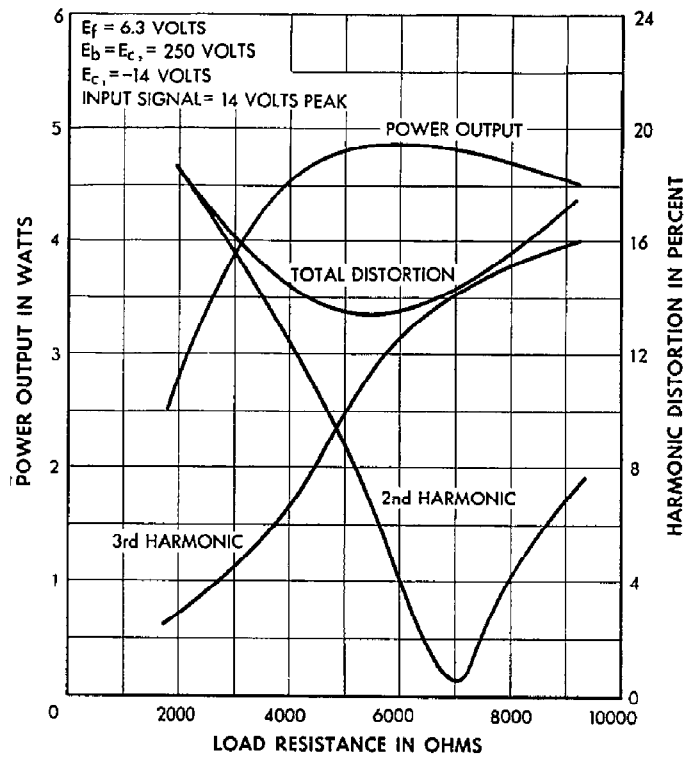

ELECTRON TUBE DATA SHEET
 FILE: GENERAL PURPOSE SECTION
 1-48

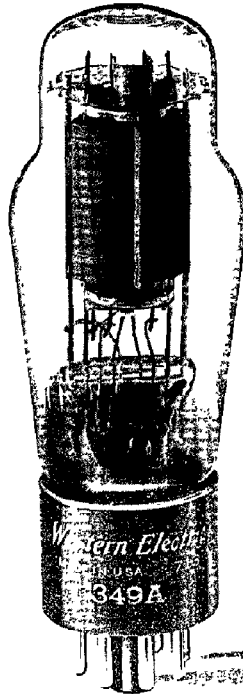

PENTODE

Western Electric

DESCRIPTION

The 349A is a suppressor grid, power pentode with an indirectly heated cathode. It is designed for use as an audio-frequency power amplifier in Class A₁ and AB₁ service.

CHARACTERISTICS

Heater Voltage		6.3 volts
Plate Current		32.5 milliamperes
Transconductance	$\left. \begin{array}{l} E_b = E_c = 250 \text{ volts;} \\ E_{c1} = -14 \text{ volts} \end{array} \right\}$	4250 micromhos
Power Output		3.5 watts

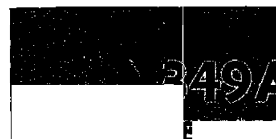

GENERAL CHARACTERISTICS**ELECTRICAL DATA**

Heater Voltage, A-C or D-C		6.3 volts
Heater Current		1.0 ampere
Direct Interelectrode Capacitances	without external shield	with external shield (RMA #311)
Grid to Plate	0.46	*0.31 uuf
Input	11.2	*11.7 uuf
Output	8.1	*10.5 uuf

MECHANICAL DATA

Cathode	Coated unipotential
Bulb	ST12
Base	Small shell octal
Mounting Position	Any
Dimensions and pin connections shown in outline drawing on Page 7	

MAXIMUM RATINGS, Design-Center Values

Plate Voltage	250 volts
Screen Grid Voltage	250 volts
Plate Dissipation	12 watts
Screen Grid Dissipation	3.5 watts
Cathode Current	50 milliamperes
Heater-Cathode Voltage	150 volts

TYPICAL OPERATING CONDITIONS AND CHARACTERISTICS**SINGLE TUBE AMPLIFIER – PENTODE CONNECTION**

Plate Voltage	180	250	250 volts
Screen Grid Voltage	180	250	250 volts
Control Grid Voltage	-8	-14	... volts
Cathode Resistor	330 ohms
Peak A-F Grid Voltage	8	10	10 volts
Zero Signal Plate Current	28.0	32.0	32.0 milliamperes
Maximum Signal Plate Current	29.5	34.0	30.5 milliamperes
Zero Signal Screen Grid Current	6.0	6.5	6.5 milliamperes
Maximum Signal Screen Grid Current	8.2	11.0	10.5 milliamperes
Transconductance	4100	4250	4400 micromhos
Plate Resistance	70000	84500	75000 ohms
Load Resistance	5000	7000	7000 ohms
Maximum Signal Power Output	1.8	3.6	3.3 watts
Total Harmonic Distortion	6.3	8.0	8.8 per cent

* With external shield (RMA #311) connected to cathode pin.

SINGLE TUBE AMPLIFIER - TRIODE CONNECTION*

Plate Voltage	250 volts
Control Grid Voltage	-16 volts
Peak A-F Grid Voltage	16 volts
Zero Signal Plate Current	30.0 milliamperes
Maximum Signal Plate Current	33.0 milliamperes
Transconductance	4550 micromhos
Amplification Factor	10
Plate Resistance	2200 ohms
Load Resistance	4000 ohms
Maximum Signal Power Output	1.3 watts
Total Harmonic Distortion	4.8 per cent

PUSH-PULL AMPLIFIER - PENTODE CONNECTION

Unless otherwise specified, values are for 2 tubes

Plate Voltage	250	250 volts
Screen Grid Voltage	250	250 volts
Control Grid Voltage	-18	... volts
Cathode Resistor	...	200 ohms
Peak A-F Grid-to-Grid Voltage	36	36 volts
Zero Signal Plate Current	35.5	55.0 milliamperes
Maximum Signal Plate Current	68.0	64.0 milliamperes
Zero Signal Screen Grid Current	8.0	12.0 milliamperes
Maximum Signal Screen Grid Current	20.5	19.5 milliamperes
Effective Load Resistance (plate-to-plate)	7000	7000 ohms
Maximum Signal Power Output	8.2	7.2 watts
Total Harmonic Distortion	5.5	5 per cent

PUSH-PULL AMPLIFIER - TRIODE CONNECTION*

Unless otherwise specified, values are for 2 tubes

Plate Voltage	250 volts
Control Grid Voltage	-18 volts
Peak A-F Grid-to-Grid Voltage	36 volts
Zero Signal Plate Current	47.5 milliamperes
Maximum Signal Plate Current	59.5 milliamperes
Effective Load Resistance (plate-to-plate)	7000 ohms
Maximum Signal Power Output	3.0 watts
Total Harmonic Distortion	3.2 per cent

* Screen grid connected to plate.

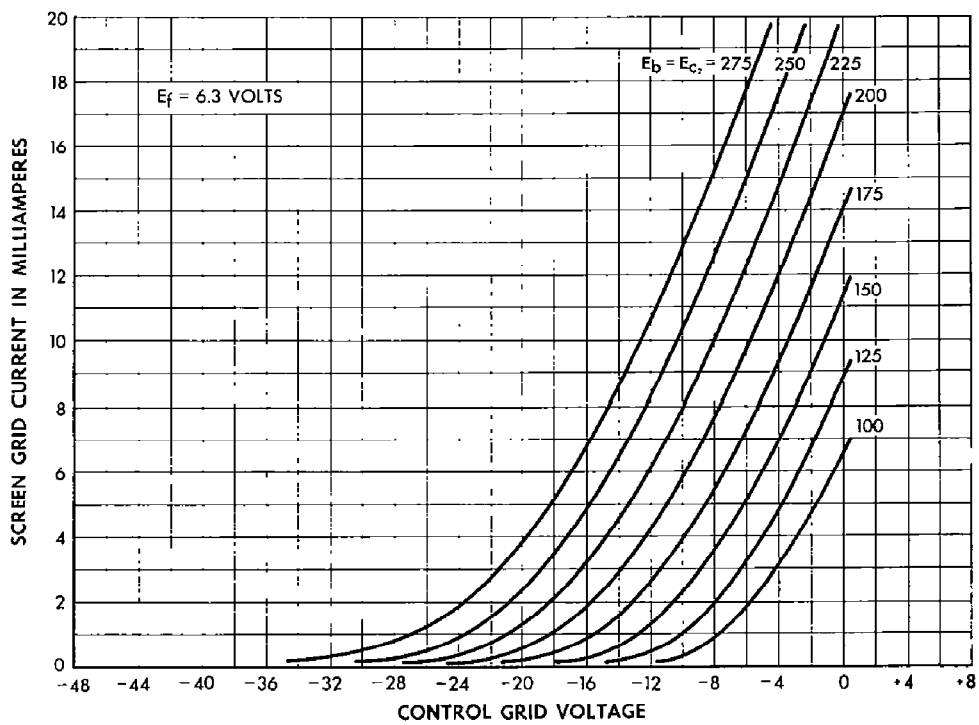
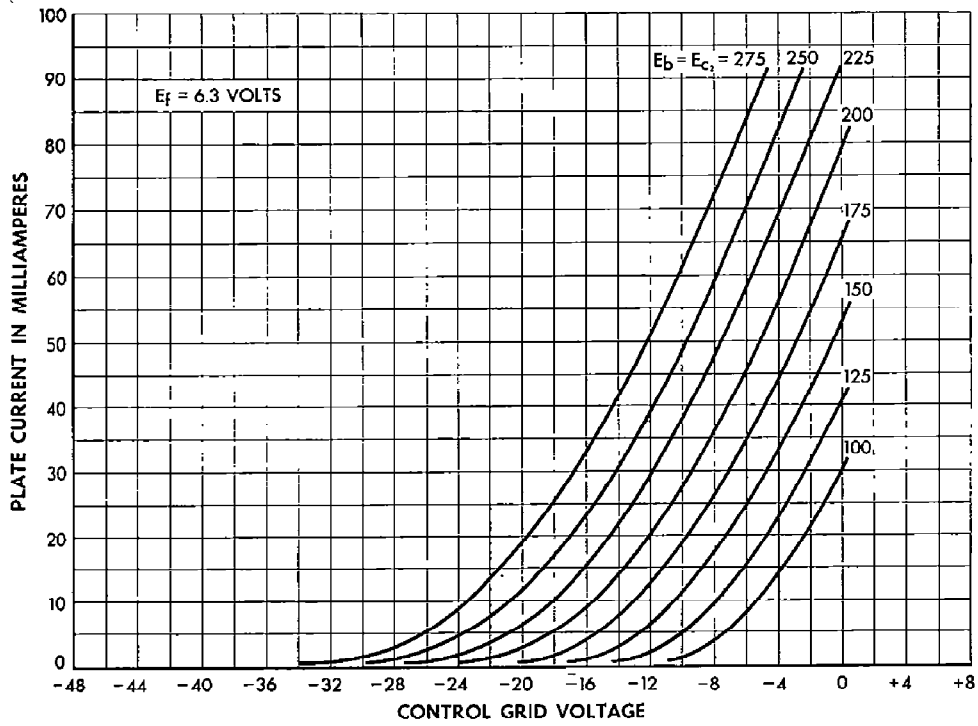

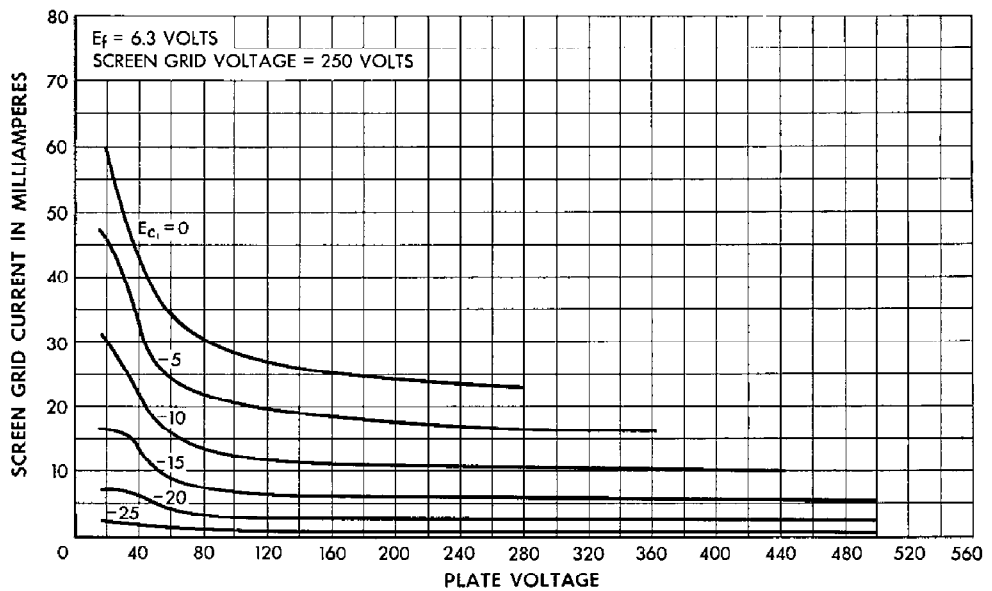
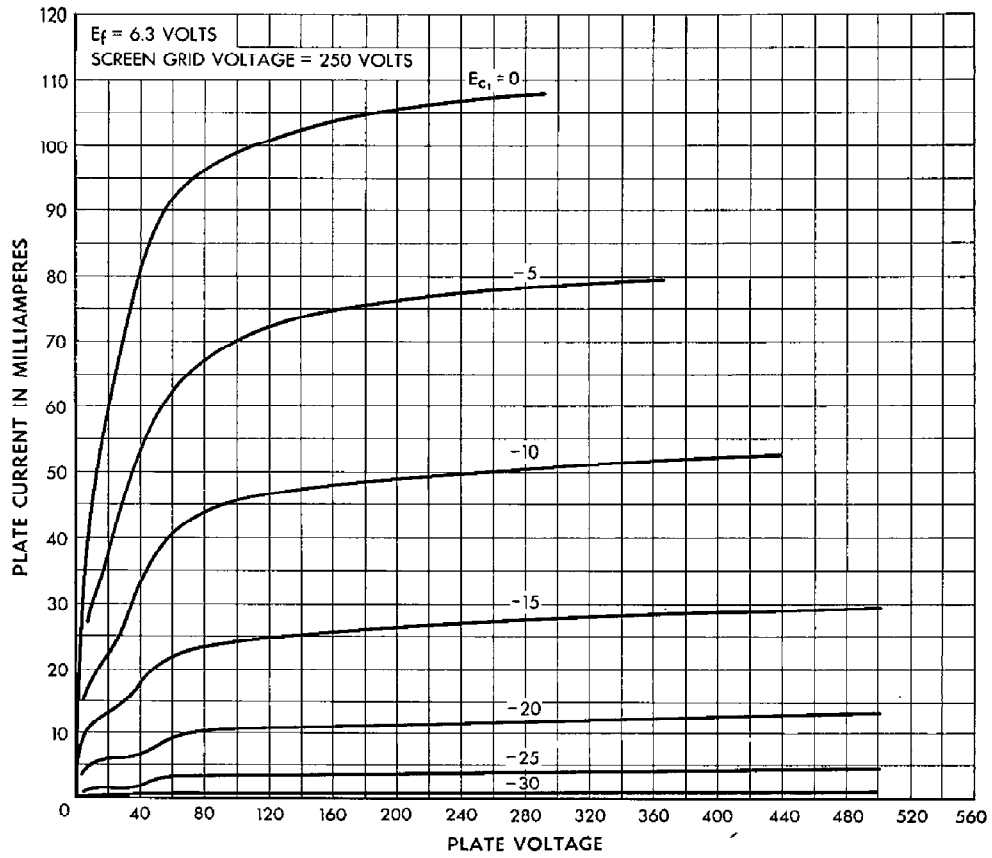

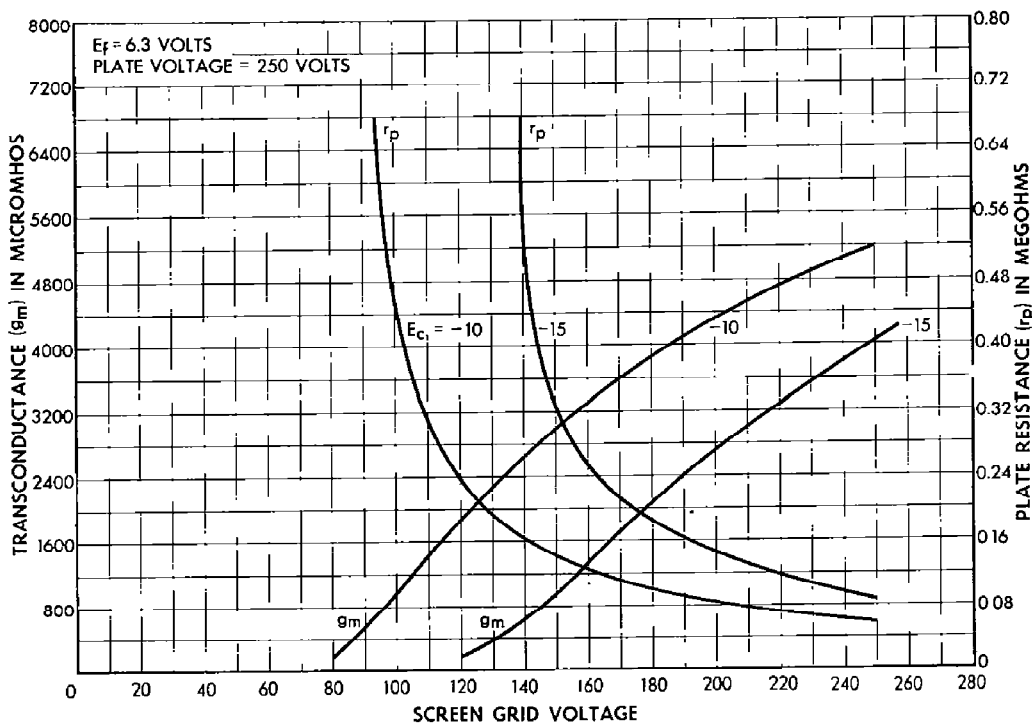
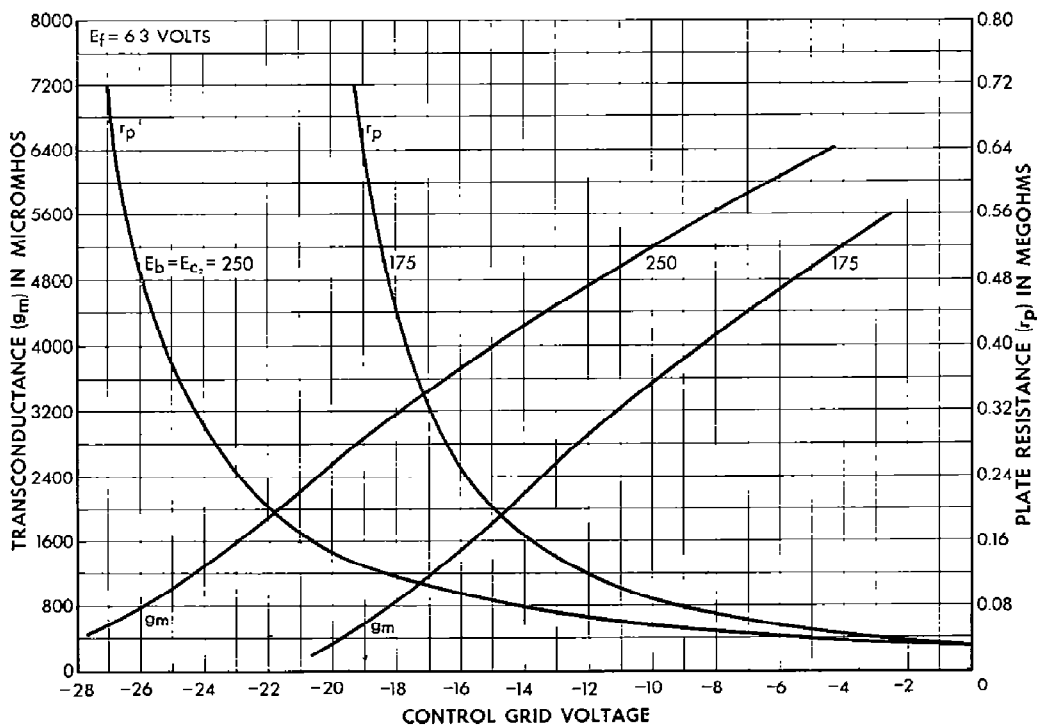

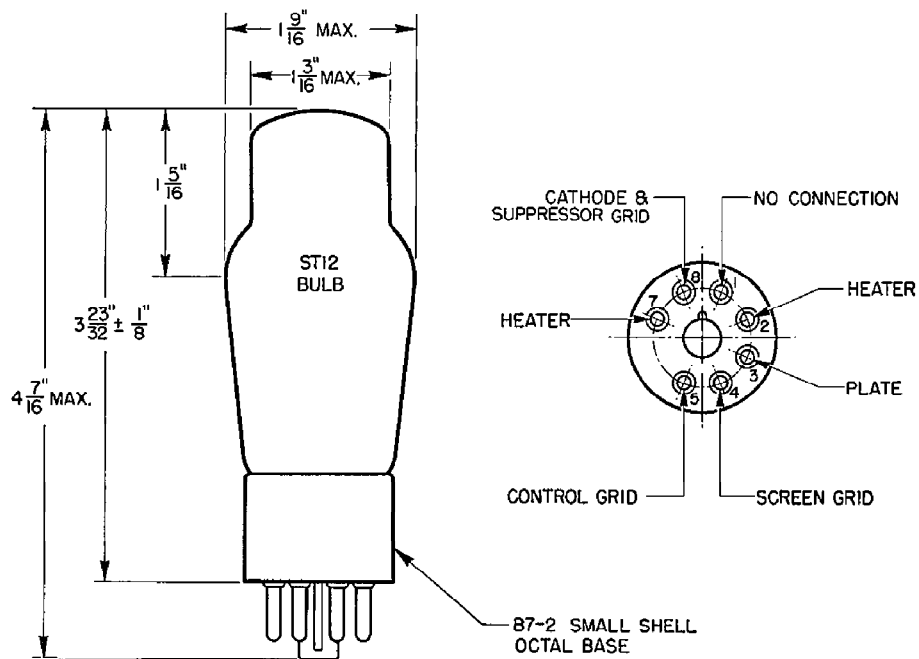
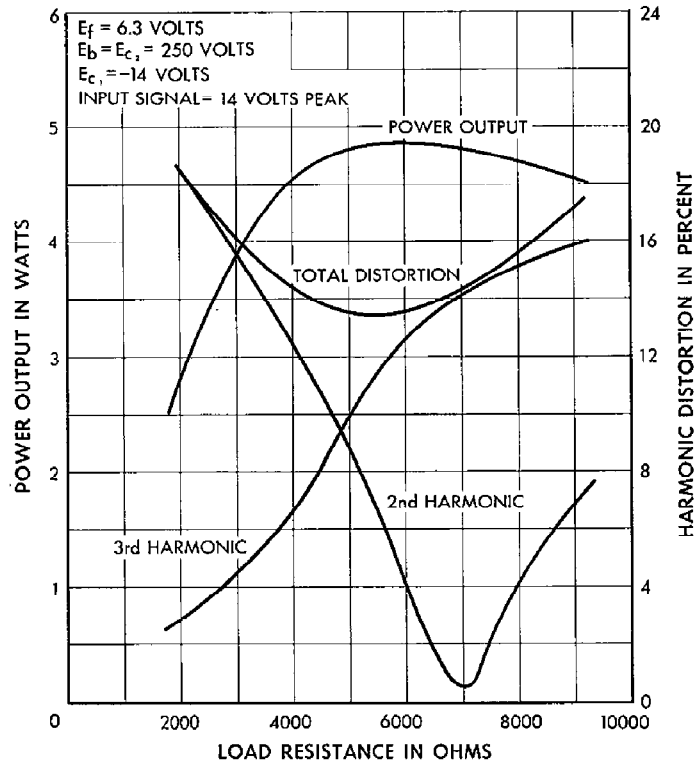

OK for Plant Dept use.
S. J. H.
6/15/0

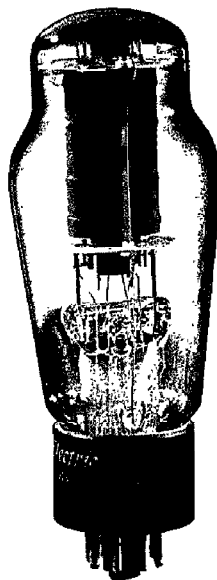

350B

**TETRODE
 BEAM POWER AMPLIFIER**

Western Electric

DESCRIPTION

The 350B is a beam power tetrode of the neater-cathode type. It is designed for use as an audio-frequency amplifier or as a radio-frequency oscillator.

CHARACTERISTICS

Heater Voltage	6.3 volts
Plate Current	93 milliamperes
Transconductance	8300 micromhos
Power Output	10.5 watts

$\left. \begin{array}{l} E_b = E_{c2} = 250 \text{ volts;} \\ E_{c1} = -14 \text{ volts} \end{array} \right\}$	$\left. \begin{array}{l} \\ \\ \end{array} \right\}$
--	--

350B
TETRODE

GENERAL CHARACTERISTICS**ELECTRICAL DATA**

Heater Voltage, A-C or D-C	6.3 volts
Heater Current	1.6 amperes
Direct Interelectrode Capacitances (without external shield)	
Grid to Plate (maximum)	0.5 uuf
Input	16 uuf
Output	8 uuf

MECHANICAL DATA

Cathode	Coated Unipotential
Bulb	ST16
Base	Medium shell, 7-pin octal
Mounting Position	Any

MAXIMUM RATINGS, Design-Center Values

Plate Voltage	360 volts
Screen Grid Voltage	270 volts
Maximum Signal Plate Current	125 milliamperes
Plate Dissipation	27 watts
Screen Grid Dissipation	4 watts

Maximum Grid Circuit Resistance for

Fixed Bias	0.1 megohm
Cathode Bias	0.5 megohm

TYPICAL OPERATING CONDITIONS AND CHARACTERISTICS**SINGLE TUBE AMPLIFIER — CLASS A₁**

Plate Voltage	250	350	250 volts
Screen Grid Voltage	250	250	250 volts
Control Grid Voltage	-14	-18	... volts
Cathode Resistor	130 ohms
Peak A-F Grid Voltage	14	18	14 volts
Zero Signal Plate Current	93	62	93 milliamperes
Maximum Signal Plate Current	97	81	89 milliamperes
Zero Signal Screen Grid Current	6.0	2.5	5.0 milliamperes
Maximum Signal Screen Grid Current	15	16	16 milliamperes
Transconductance	8300	7100	8500 micromhos
Plate Resistance	37500	57500	34500 ohms
Load Resistance	2000	3200	2500 ohms
Maximum Signal Power Output	10.5	15.8	9.6 per cent
Total Harmonic Distortion	11	18	11 per cent

SINGLE TUBE AMPLIFIER (TRIODE CONNECTIONS*) - CLASS A₁

Plate Voltage	250	250	volts
Control Grid Voltage	-20	...	volts
Cathode Resistor	350	ohms
Peak A-F Grid Voltage	20	20	volts
Zero Signal Plate Current	50	50	milliamperes
Maximum Signal Plate Current	56.0	52.2	milliamperes
Transconductance	6400	6800	micromhos
Amplification Factor	8	8	
Plate Resistance	1250	1180	ohms
Load Resistance	5000	6000	ohms
Maximum Signal Power Output	1.7	1.5	watts
Total Harmonic Distortion	5	3.6	per cent

PUSH-PULL AMPLIFIER - CLASS A₁

Unless otherwise specified, values are for 2 tubes

Plate Voltage	250	270	270	volts
Screen Grid Voltage	250	270	270	volts
Control Grid Voltage	-15	-17.5	...	volts
Cathode Resistor	75	ohms
Peak A-F Grid-to-Grid Voltage	30	35	32	volts
Zero Signal Plate Current	165	163	184	milliamperes
Maximum Signal Plate Current	203	212	196	milliamperes
Zero Signal Screen Grid Current	13	12	16	milliamperes
Maximum Signal Screen Grid Current	24	28	24	milliamperes
Transconductance	8200	8050	9500	micromhos
Plate Resistance	37500	50000	35500	ohms
Effective Load Resistance (Plate-to-Plate)	2000	2000	3000	ohms
Maximum Signal Power Output	15.5	20.0	18.6	watts
Total Harmonic Distortion	2.5	3.5	6.3	per cent

PUSH-PULL AMPLIFIER - CLASS AB₁

Unless otherwise specified, values are for 2 tubes

Plate Voltage	360	360	360	volts
Screen Grid Voltage	270	270	270	volts
Control Grid Voltage	-25	volts
Cathode Resistor	130	ohms
Peak A-F Grid-to-Grid Voltage	50	45	45	volts
Zero Signal Plate Current	68	132	132	milliamperes
Maximum Signal Plate Current	162	155	155	milliamperes
Zero Signal Screen Grid Current	2.5	5.5	5.5	milliamperes
Maximum Signal Screen Grid Current	24.5	18	18	milliamperes
Effective Load Resistance (Plate-to-Plate)	3000	5000	5000	ohms
Maximum Signal Power Output	22	25	25	watts
Total Harmonic Distortion	5	14	14	per cent

*Screen grid connected to plate.

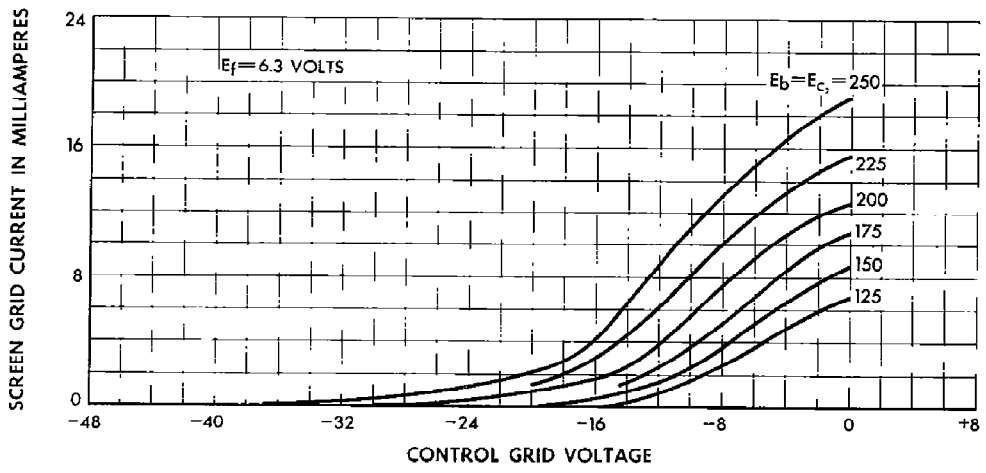
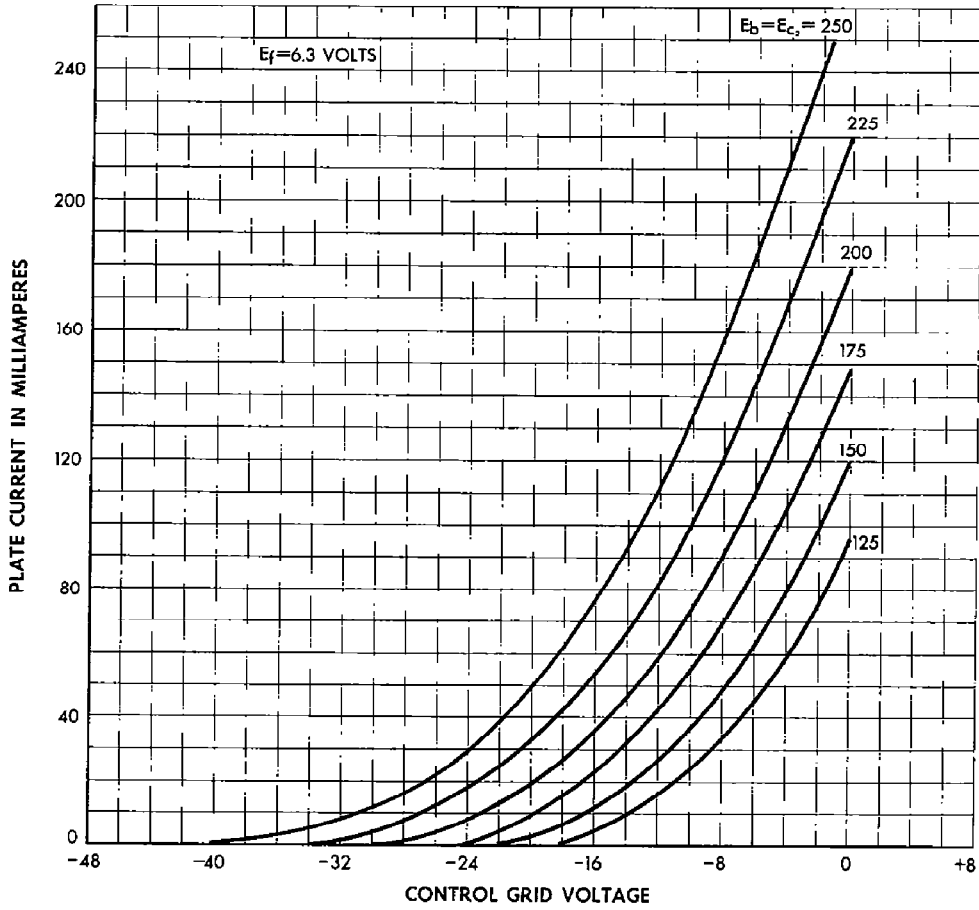

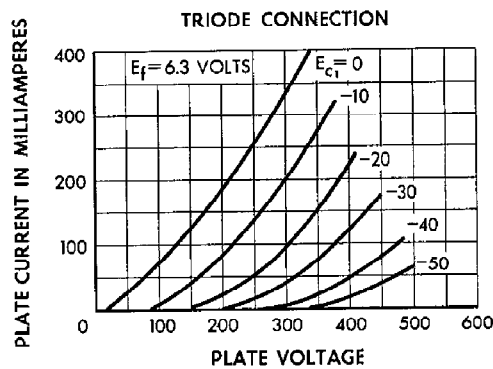
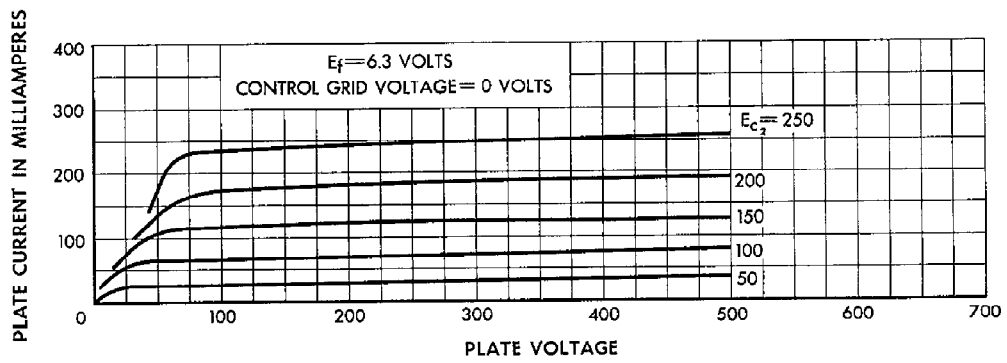
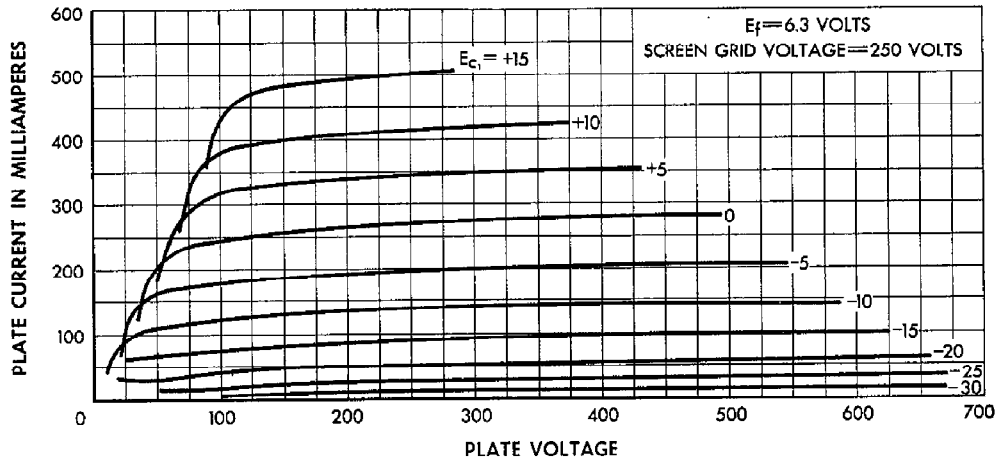

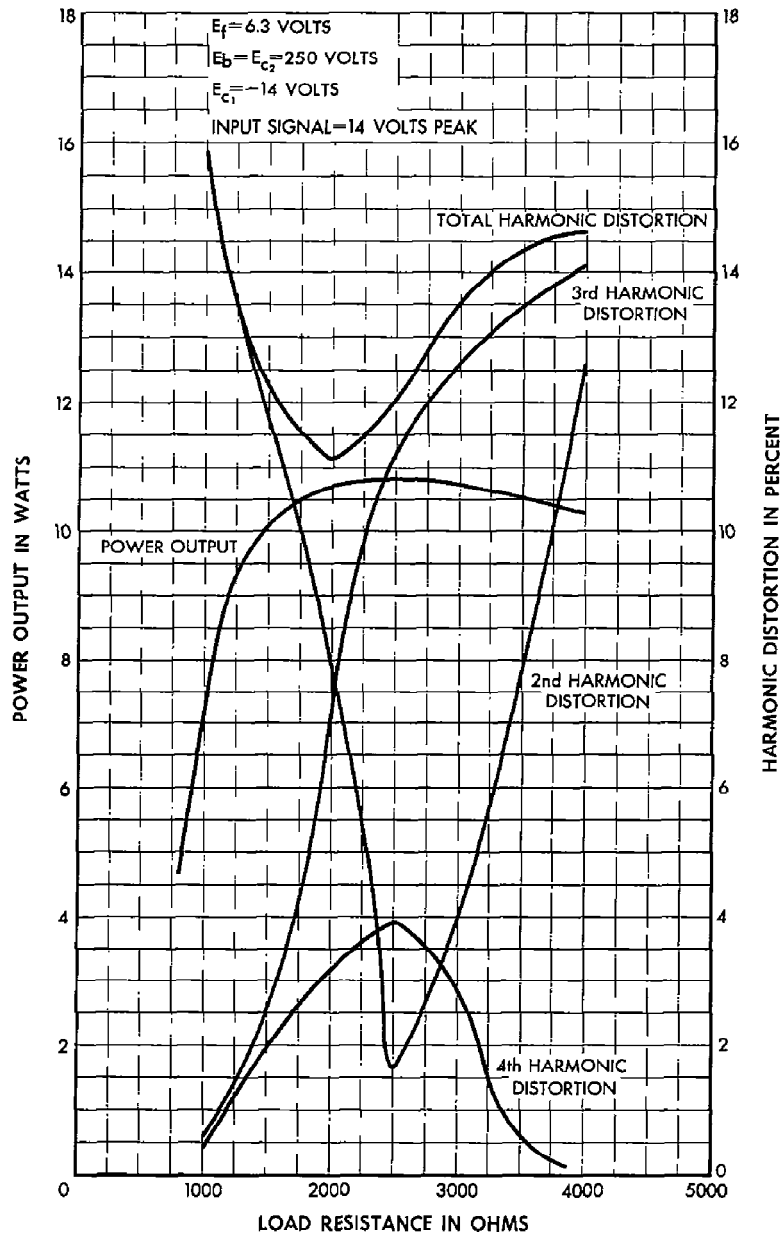

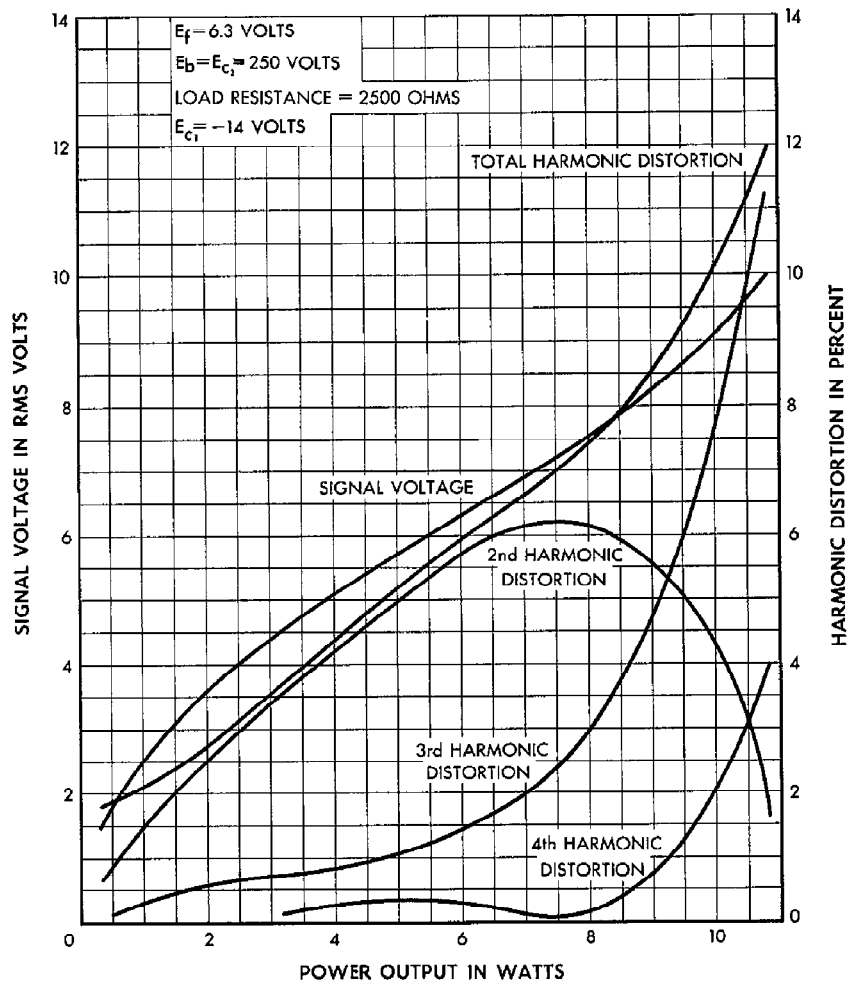

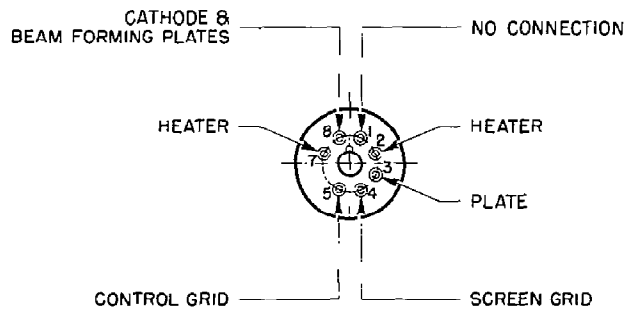
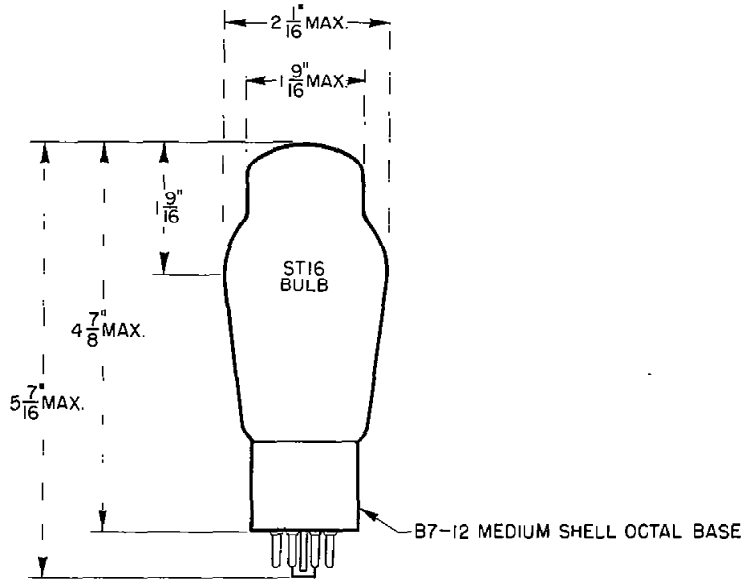

Western Electric

A development of Bell Telephone Laboratories, the research laboratories of the American Telephone and Telegraph Company and the Western Electric Company.

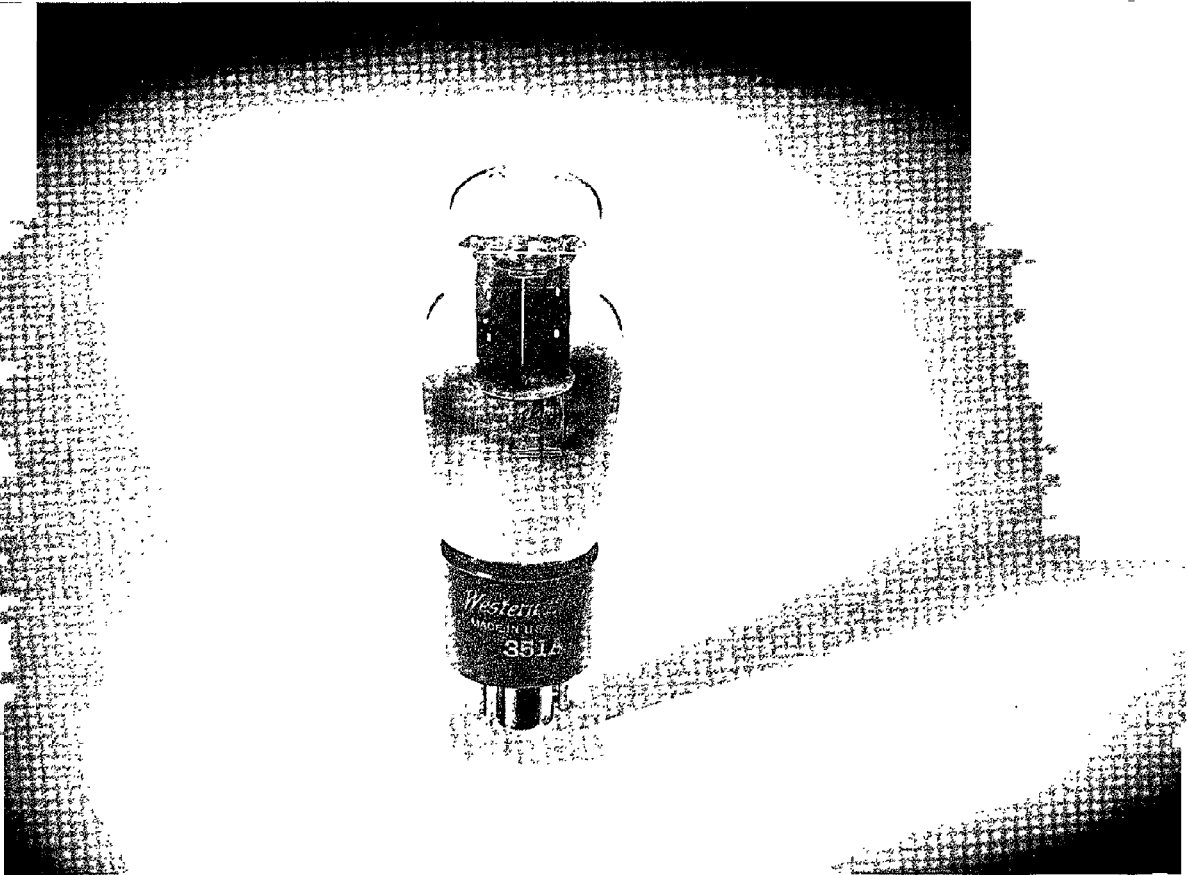

**RECTIFIER
FULL-WAVE, HIGH VACUUM**

Western Electric

DESCRIPTION

The 351A is an octal based full-wave rectifier with indirectly heated cathodes. It is designed to supply direct current from an alternating current source or to rectify radio-frequency currents for feedback purposes in broadcast transmitters.

CHARACTERISTICS

Heater Voltage	6.3 volts
Maximum Plate Voltage (RMS) per Plate	400 volts
Maximum D-C Output Current	100 milliamperes

GENERAL CHARACTERISTICS**ELECTRICAL DATA**

Heater Voltage	6.3 volts
Heater Current	1.0 ampere

MECHANICAL DATA

Cathode	Coated unipotential
Bulb	ST12
Base	Small shell octal
Mounting Position	Any
Dimensions and pin connections shown in outline drawing on Page 4	

MAXIMUM RATINGS, Design-Center Values

Peak Inverse Voltage	1250 volts
Peak Plate Current per Plate	300 milliamperes
Peak Transient Plate Current per Plate	1.0 ampere
Peak Heater-Cathode Voltage	450 volts

With Choke-Input Filter:

A-C Plate Voltage per Plate (RMS)	400 volts
D-C Output Current	100 milliamperes
Minimum Input-Choke Inductance	4 henrys

With Condenser-Input Filter:

A-C Plate Voltage per Plate (RMS)	350 volts
D-C Output Current	100 milliamperes
Minimum Total Effective Plate-Supply Impedance per Plate	75 ohms

TYPICAL OPERATING CONDITIONS**With Choke-Input Filter:**

A-C Plate Voltage per Plate (RMS)	350 volts
D-C Output Current	100 milliamperes
D-C Output Volts, Approximate, at Input to Filter	290 volts
Filter Input Choke	6 henrys

With Condenser-Input Filter:

A-C Plate Voltage per Plate (RMS)	300 volts
D-C Output Current	90 milliamperes
D-C Output Volts, Approximate, at Input to Filter	340 volts
Total Effective Plate-Supply Impedance per Plate	150 ohms
Filter Input Condenser	4 microfarads

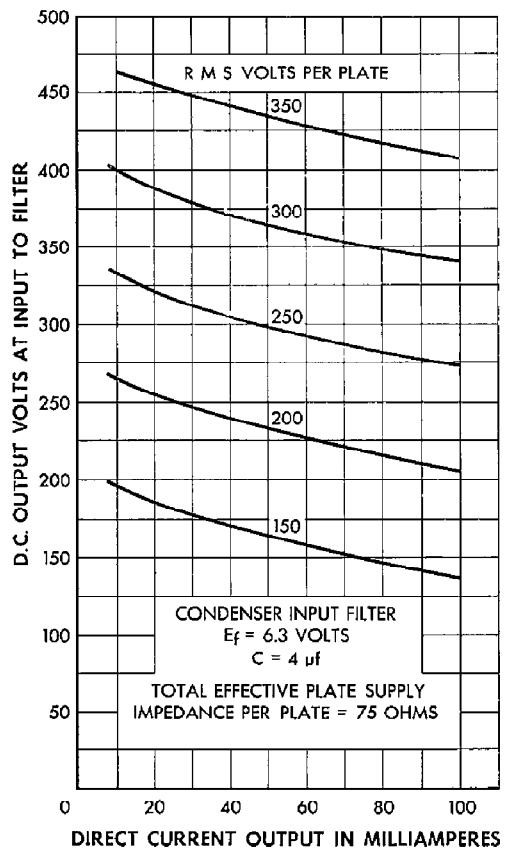
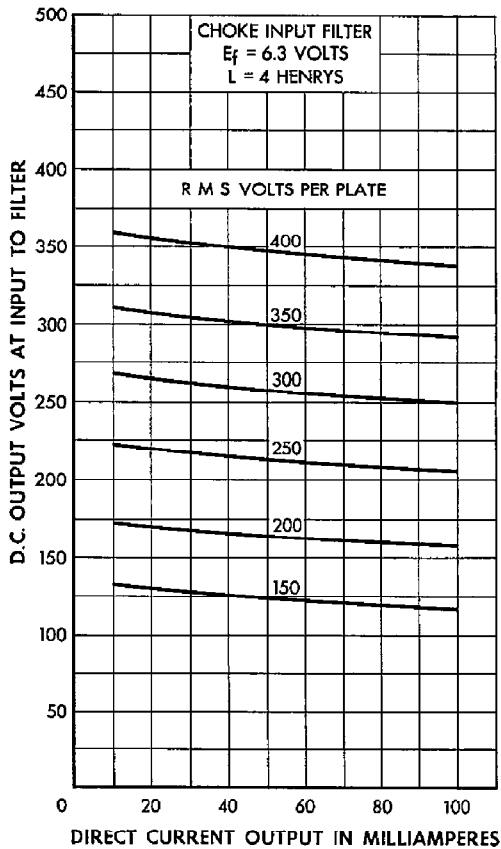
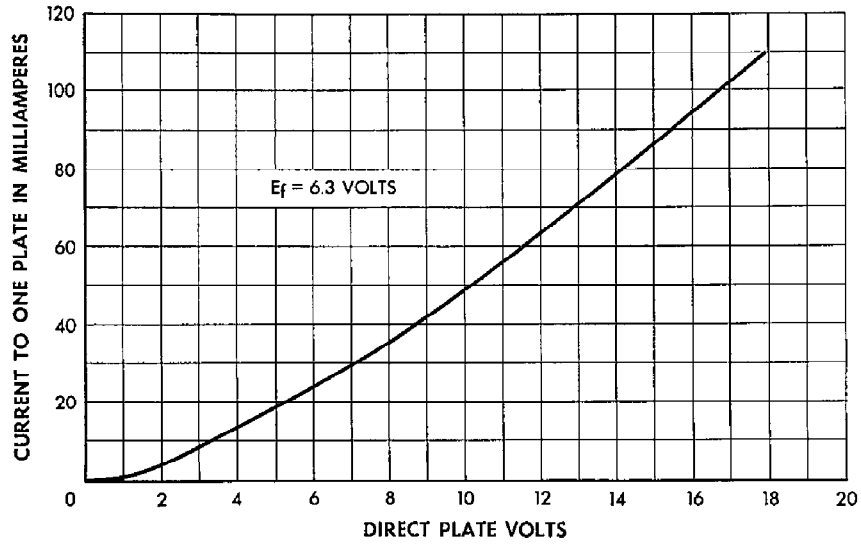

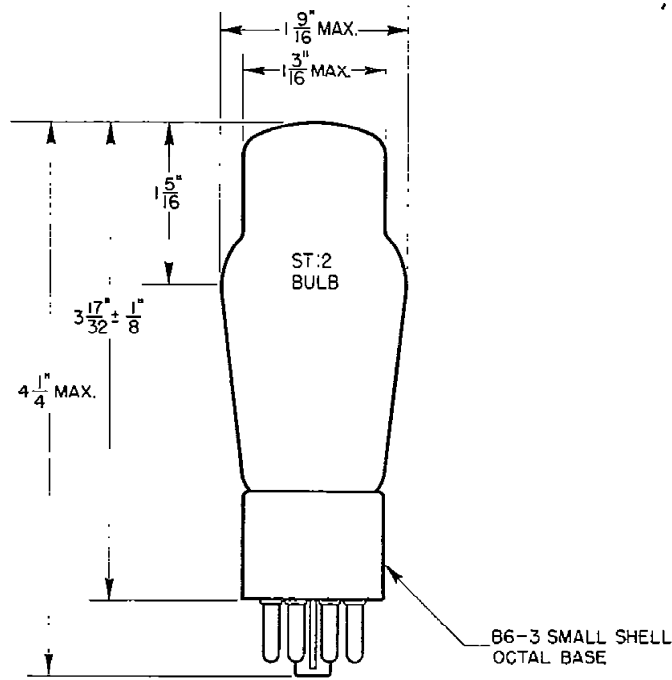

CATHODE — — NO CONNECTION

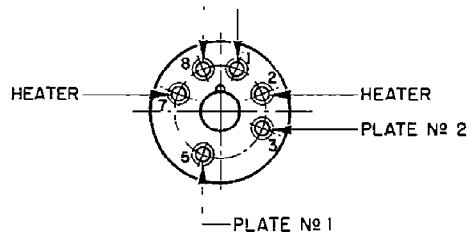

Western Electric

A development of Bell Telephone Laboratories, the research laboratories of the American Telephone and Telegraph Company and the Western Electric Company

Western Electric

352A Vacuum Tube

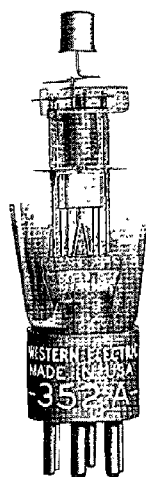

Classification—Duodiode triode with an indirectly heated cathode

The 352A tube comprises three distinct vacuum tube units which are independent of each other except that sections of a single cathode structure supply electron emission for all three. Two of these units are diodes. The other is a triode.

Applications—Diode detector, diode rectifier for automatic volume control voltage, and triode audio-frequency amplifier. If desired the two diodes may be used for full-wave rectification or they may be connected in parallel to provide a lower impedance half-wave rectifier. The former connection requires about twice as high an input voltage as the latter to give equal detector output.

Dimensions and Connections—Outline diagrams of the tube and base giving the dimensions and the arrangement of the electrode connections to the base terminals are shown in Figures 1 and 2.

Base and Mounting—This tube employs a small six-pin thrust type base suitable for use in a Western Electric 144B or similar socket. The base pins are silver plated. The triode grid terminal is a small metal cap located at the top of the bulb.

This tube may be mounted in any position.

Average Direct Interelectrode Capacitances

Triode grid to plate	1.5	$\mu\mu\text{f}$
Triode grid to cathode and heater	1.6	$\mu\mu\text{f}$
Triode plate to cathode and heater	3.8	$\mu\mu\text{f}$
Both diodes to triode grid	0.015	$\mu\mu\text{f}$
Both diodes to triode plate	1.4	$\mu\mu\text{f}$
Both diodes to cathode and heater	6.5	$\mu\mu\text{f}$

Heater Rating

Heater voltage	10.0 volts, a.c. or d.c.
Nominal heater current	0.32 ampere

The heater of this tube is designed to operate on a voltage basis and should be operated at as near the rated voltage as practicable.

Cathode Connection—Where alternating heater voltage is used the cathode should preferably be connected directly to the mid-point of the heater transformer winding or to the mid-point of a low resistance connected across the heater terminals. For direct current operation the cathode may be connected to either end of the heater. If voltage is applied between the heater and cathode, it should be kept low and must not exceed 50 volts.

Triode Characteristics—Typical curves showing triode plate current as a function of grid voltage for several values of plate voltage are shown in Figure 3. Corresponding amplification factor, plate resistance and transconductance characteristics are given in Figures 4, 5 and 6 respectively. Figure 7 shows plate current as a function of plate voltage for several values of grid voltage.

Triode Operating Conditions and Output

Permissible operating plate and grid voltages are included within the area, ABCD, in Figure 3. Amplification factor, plate resistance, transconductance and performance data for a number of typical operating conditions are given in the table. Recommended conditions or others of no greater severity should be selected in preference to maximum conditions wherever possible. The life of the tube at maximum operating conditions will be shorter than at less severe conditions.

In the last four columns of the table are given the fundamental power output, P_m , in milliwatts, the fundamental voltage output, E_{pm} , in peak volts and the second and third harmonic levels, F_{2m} and F_{3m} , in db below the fundamental, for the indicated values of load resistance. The peak value of the sinusoidal input voltage, E_{gm} , is numerically equal to the grid bias in each case. Where the level of the third harmonic is lower than 45 db below the fundamental, its value may be widely different from tube to tube. The values given represent a typical tube.

For a smaller input voltage, E_g , the fundamental power and voltage outputs and the harmonic levels are given approximately by the following relations:

$$P = P_m \left(\frac{E_g}{E_{gm}} \right)^2$$

$$E_p = E_{pm} \frac{E_g}{E_{gm}}$$

$$F_2 = F_{2m} + 20 \log_{10} \frac{E_{gm}}{E_g}$$

$$F_3 = F_{3m} + 40 \log_{10} \frac{E_{gm}}{E_g}$$

TABLE

Plate Voltage	Grid Voltage	Plate Current	Amplification Factor	Plate Resistance	Trans-conductance	Load Resistance	Power Output	Voltage Output	Second Harmonic	Third Harmonic
Volts	Volts	Milli-amperes		Ohms	Micro-mhos	Ohms	Milli-watts	Peak Volts	db	db
135	-4.5	3.2	14.0	17,500	800	20,000	31	35	25	50
						35,000	27	43	28	45
						50,000	23	48	29	45
135	-6.0	2.1	13.3	20,500	650	20,000	42	41	20	55
						35,000	40	53	24	55
						50,000	34	58	26	50
135	-7.5	1.3	12.7	26,000	490	20,000	46	43	16	38
						35,000	45	56	19	45
						50,000	42	65	21	55
180	-7.5	3.4	13.5	18,000	750	20,000	79	56	22	55
						35,000	68	69	25	50
						50,000	59	77	28	45
180	-9.0	2.4	13.0	20,500	630	20,000	90	60	18	45
						35,000	85	77	22	55
						50,000	76	87	24	55
180	-10.5	1.5	12.7	26,000	490	20,000	90	60	15	36
						35,000	87	78	17	38
						50,000	78	88	20	45
*200	-9.0	3.3	13.2	18,000	730	20,000	109	66	20	55
						35,000	96	82	24	55
						50,000	81	90	26	50
*200	-10.5	2.3	12.9	22,000	590	20,000	112	67	17	40
						35,000	106	86	21	50
						50,000	90	95	24	60

*Maximum operating conditions.

Triode Microphonic Noise—With a plate voltage of 135 volts, a grid bias of -6 volts, and a load resistance of 100,000 ohms, the mean microphonic noise output level of the triode section of the tube, measured in a laboratory reference test set, is 45 db below 1 volt. The range of levels of individual tubes extends from 20 to 60 db below 1 volt. Since microphonic noise depends on the type and intensity of the mechanical disturbance which produces it, the values given here are useful chiefly for comparison with the levels of other tubes which have been tested in the same way.

Diode Characteristics—The current-voltage characteristic of a single diode is shown in Figure 8. Rectification characteristics for a single diode are shown in Figure 9 for a number of values of impressed alternating input voltage. Each of these characteristic curves gives the relation between the direct voltage impressed on the diode plate and the average diode current as indicated by a direct-current microammeter for a constant impressed alternating input voltage of the value specified. Where the diode is used as a detector with the usual condenser-resistance circuit, the direct component of the voltage developed across the resistance by any alternating-voltage input is given by the intercept of the load line with the rectification characteristic corresponding to the input voltage. Load lines for zero fixed bias are shown in Figure 9 for load resistance values of 0.25, 0.5 and 1.0 megohm.

The potential of each diode plate with respect to the cathode on the positive swing of the input voltage should be limited to a maximum value of +10 volts.

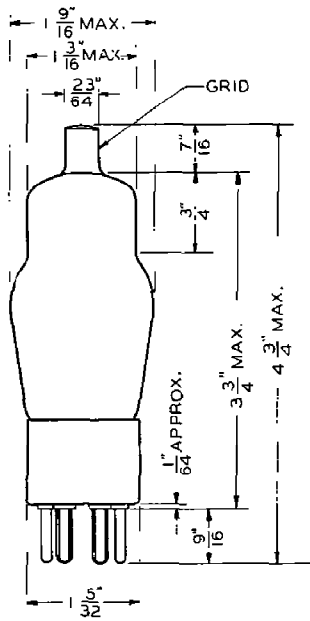

FIG. 1

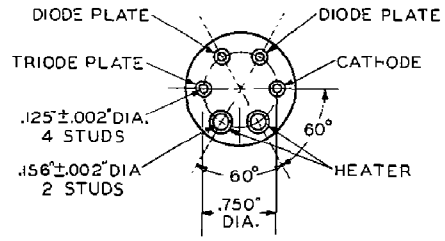

FIG. 2

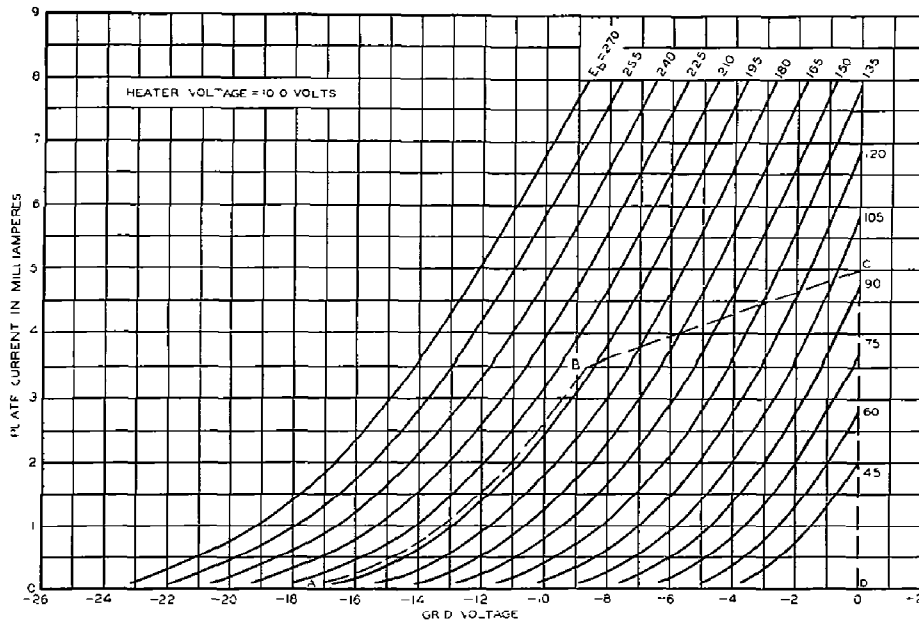

FIG. 3

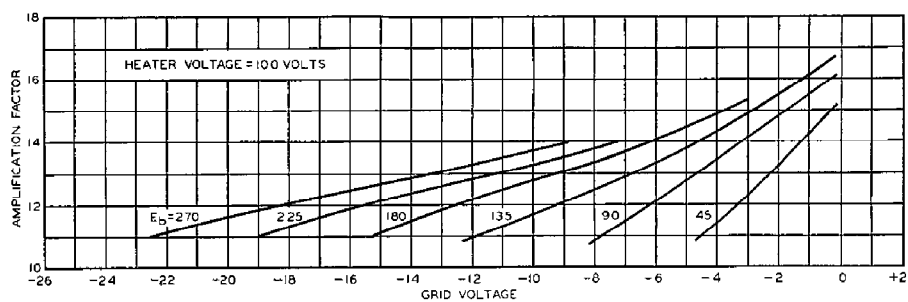

FIG. 4

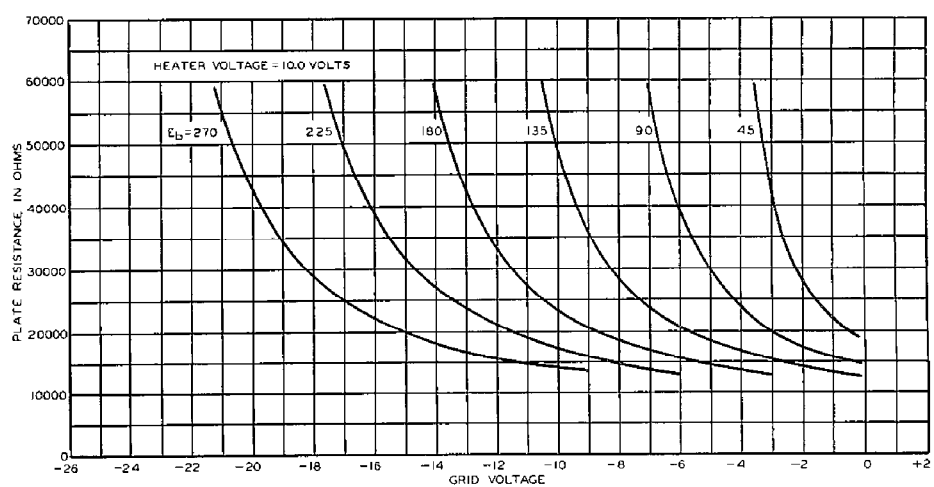

FIG. 5

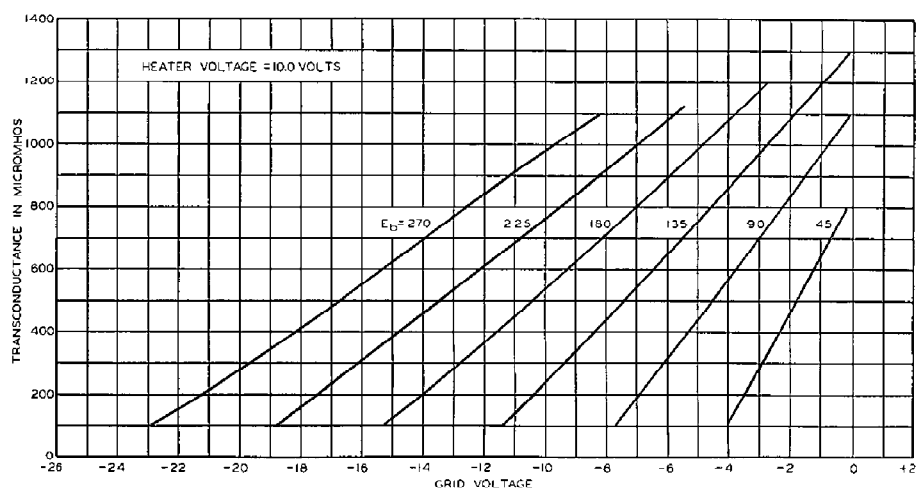

FIG. 6

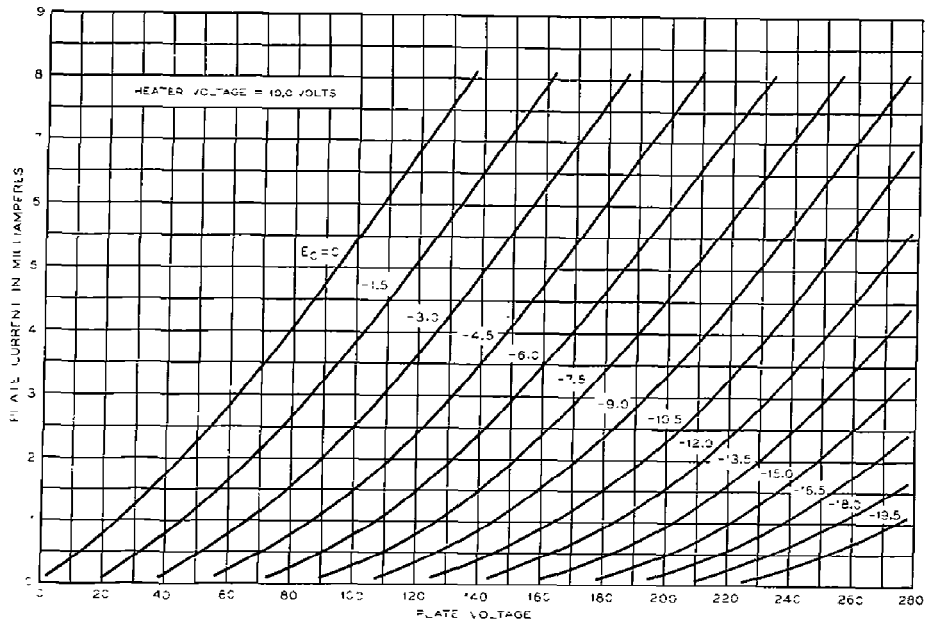

FIG. 7

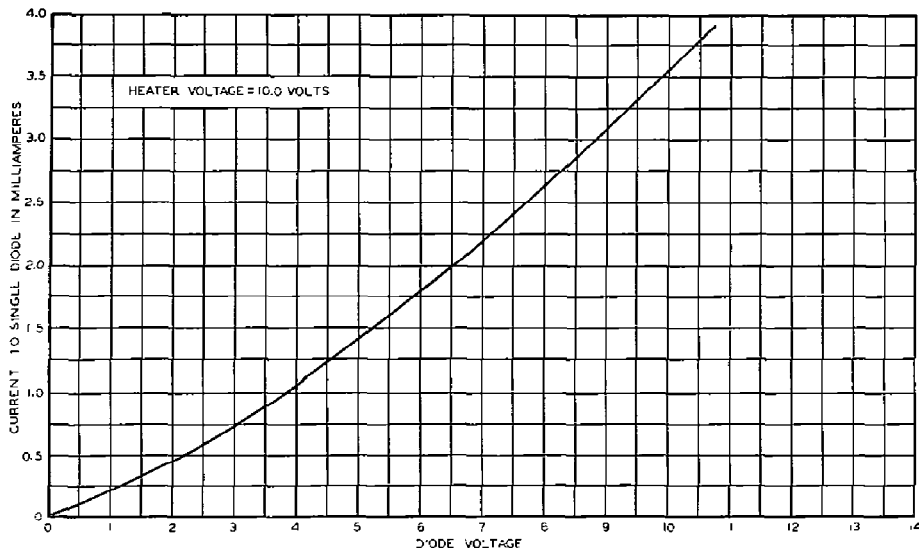

FIG. 8

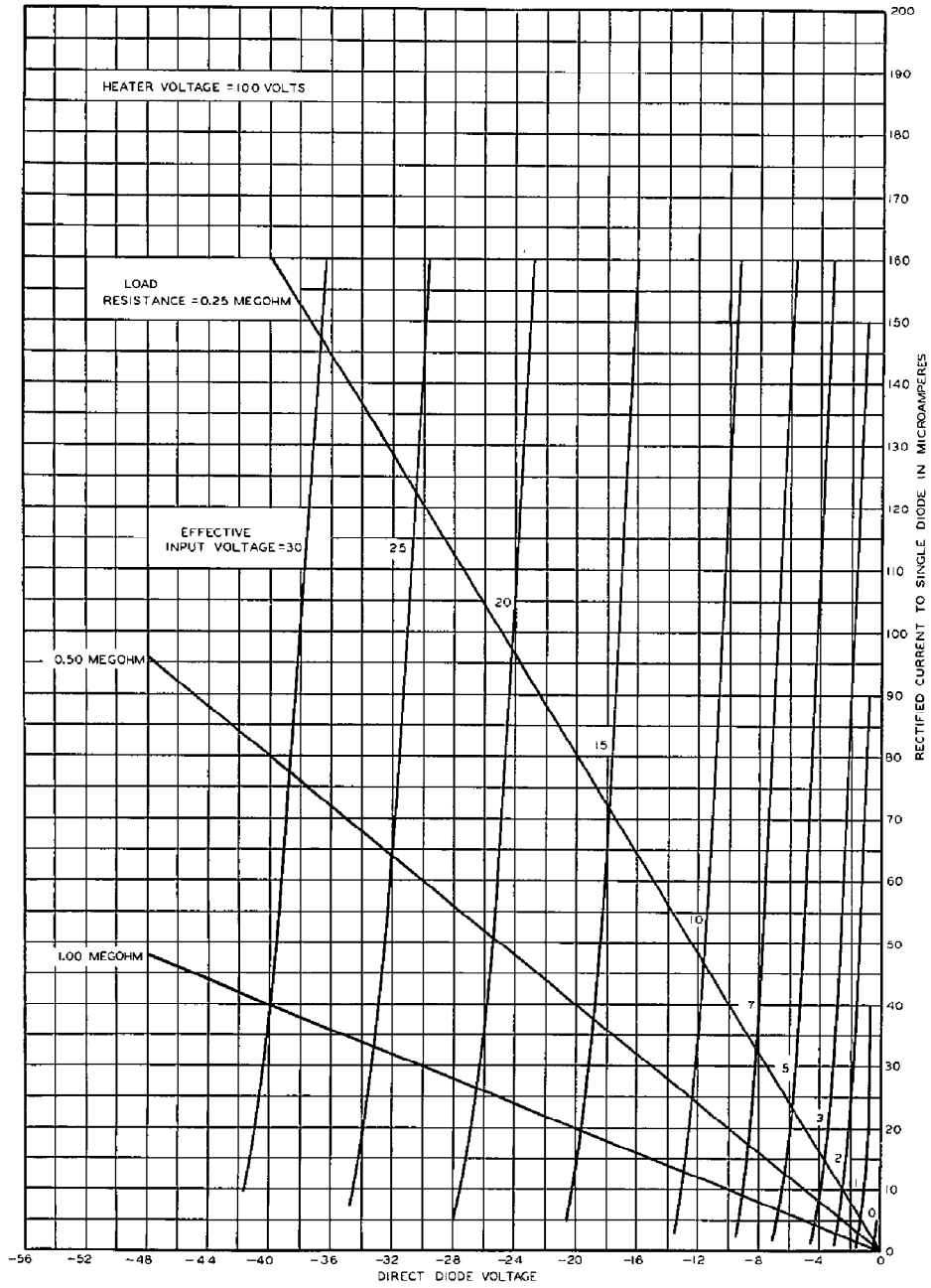

FIG. 9

1-J-39-61C
PRINTED IN U.S.A.

A development of Bell Telephone Laboratories, Incorporated
the research laboratories of the American Telephone and Tele-
graph Company and the Western Electric Company

V. T. DATA SHEET 352A
ISSUE 1

ELECTRON TUBE DATA SHEET
WESTERN ELECTRIC 353A ELECTRON TUBE

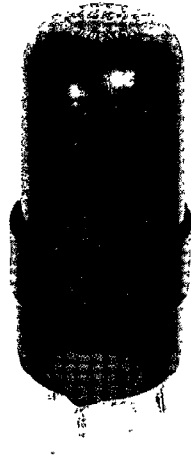

353A

DESCRIPTION

The 353A is a three-electrode, inert-gas-filled, cold cathode tube for use in relay, voltage regulator, or rectifier circuits. This tube is especially suitable for use in control circuits such as in triggering, counting, or switching apparatus.

CHARACTERISTICS

Peak Anode Voltage	-	150	volts
Average Cathode Current	10	100	milliamperes
Average Life, approximate	10000	10	hours

File: Cold Cathode Section

MAXIMUM RATINGS, Absolute System (Note 1)

Forward Peak Anode Voltage	150	volts
Forward Cathode Current (Note 2)		
Peak	100	milliamperes
Average	35	milliamperes
Averaging Time	2	seconds
Peak Inverse Anode Current (Note 2)	5	milliamperes
Ambient Temperature Limits	-55 to +85	centigrade

ELECTRICAL DATA, Throughout Life

	<u>Min.</u>	<u>Bogey</u>	<u>Max.</u>	
Starter Breakdown Voltage (Note 3)	62	70	89	volts
Starter Voltage Drop at 20 milliamperes	52	60	74	volts
Anode Voltage Drop at 20 milliamperes	68	75	90	volts
Transfer Current	See Curve, Fig. 3			
Ionization Time, Starter Gap (Note 4)	-	6	-	milliseconds
Deionization Time, approximate				
Starter Gap	-	3	-	milliseconds
Main Gap	-	10	-	milliseconds
Inverse Current at -120 Volts Anode Potential (Note 5)	-	-	3	milliamperes

MECHANICAL DATA

Mounting Position Any
 Net Weight, approximate 1 Ounce
 Dimensions and pin connections shown in outline drawing on Page 4.

HANDLING

This tube contains a small amount of krypton-85 gas which is a by-product radioactive material. The amount of krypton-85 is less than five microcuries, which is too small an amount to require any special care in use.

Atomic Energy Commission regulations require that the individual tube carton for tubes containing by-product radioactive material be appropriately marked. The marking includes the statement that tube disposal should be in approved manner.

Approved instructions for disposal of tubes containing krypton-85 are as follows;

Tubes to be disposed of should be broken or crushed in a well ventilated place releasing any resulting vapors to the outside atmosphere. The residual broken or crushed tubes should be disposed of in a normal public trash disposal system. Tubes should be disposed of at a rate of not more than 100 each week from any one location. Avoid breathing vapors from broken tubes.

Note 1: In the "Absolute System" the maximum ratings specified are limiting values above which the serviceability of the device may be impaired from the viewpoint of life and satisfactory performance. Maximum ratings, as such, do not constitute a set of operating conditions and all values may not, therefore, be attained simultaneously.

Note 2: Sufficient resistance must be used in series with the tube to assure that the electrode currents do not exceed the maximum rated values.

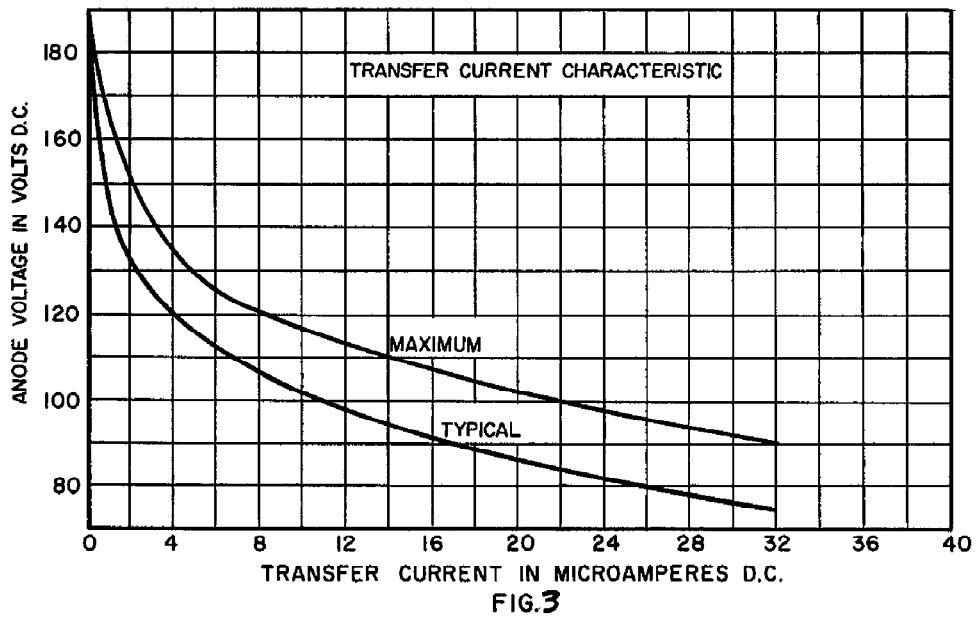
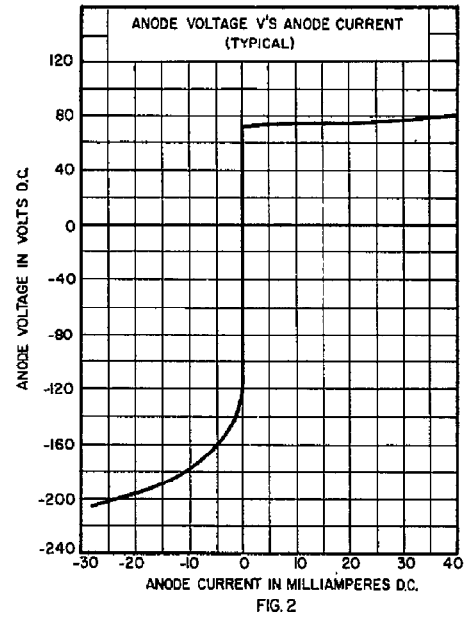
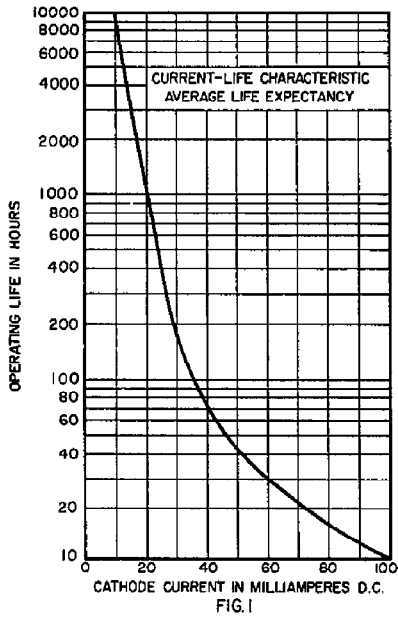

Note 3: Limits apply immediately after the tube has conducted current. If tube has been idle, these values initially may be as much as 3 volts higher or lower.

Note 4: With 15 volts starter overvoltage (15 volts above starter breakdown voltage) with tube in total darkness.

Note 5: Negative anode voltage applied through 8000 ohms. Starter connected to anode through 100,000 ohms.

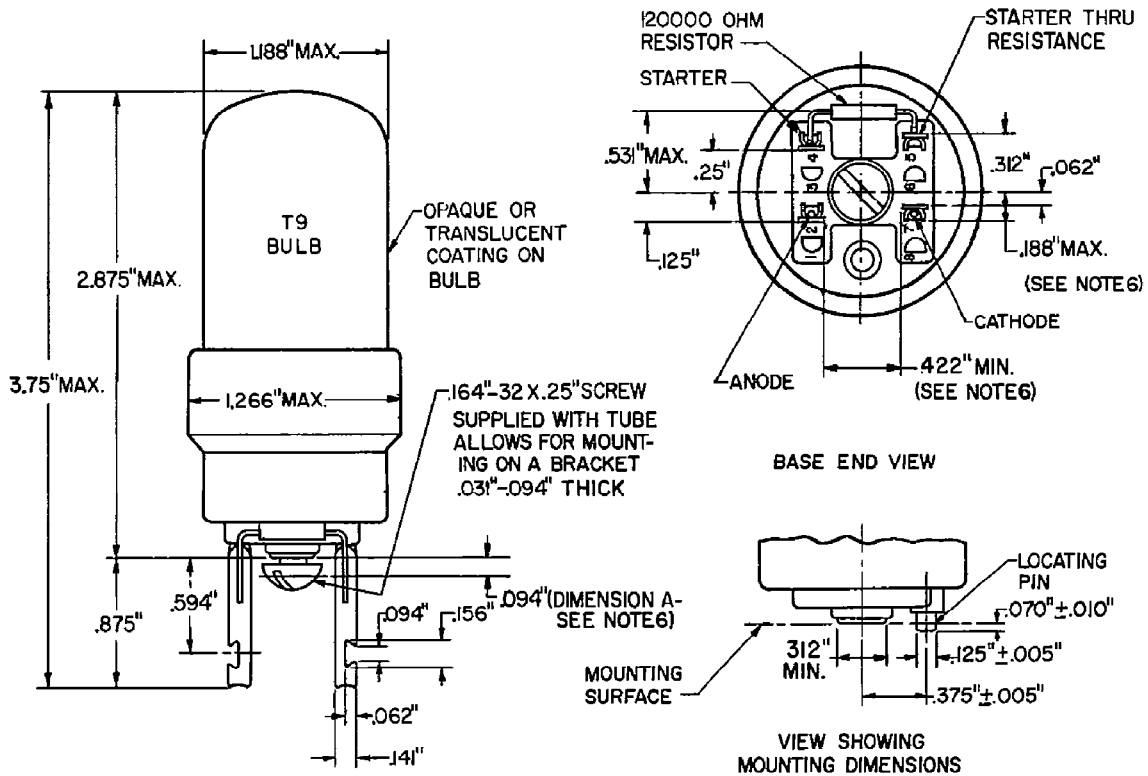

NOTE 6 - CLEARANCE DIMENSIONS TO APPLY WITHIN THE LIMITS DEFINED BY DIMENSION "A" ONLY. (SEE BASE END VIEW)

A development of Bell Telephone Laboratories, the research laboratories of the American Telephone and Telegraph Company and the Western Electric Company.

PRINTED IN U.S.A.

ELECTRON TUBE DATA SHEET
WESTERN ELECTRIC 354A ELECTRON TUBE

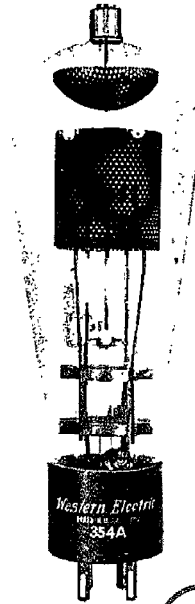

ONLY

354A

DESCRIPTION

The 354A is a three-electrode mercury-vapor thyatron with a negative control characteristic. This tube is designed for regulated or controlled rectifiers.

MAXIMUM RATINGS

Peak Anode Voltage	1500 volts
Average Cathode Current	4 amperes

FILE:THYRATRON SECTION

MAXIMUM RATINGS, ABSOLUTE VALUES

Peak Anode Voltage	
Inverse	1500 volts
Forward	1500 volts
Cathode Current	
Peak	16 amperes
Average	4 amperes
Surge (maximum duration 0.1 second)	160 amperes
Averaging Time	15 seconds
Negative Grid Voltage .	
Before Conduction	500 volts
During Conduction	10 volts
Positive Grid Current, Average	
(Averaging time - one cycle)	0.050 ampere
Condensed Mercury Temperature Limits +30 to +70 centigrade	

ELECTRICAL DATA

	<u>Min.</u>	<u>Bogey</u>	<u>Max.</u>
Filament Voltage	2.37	2.5	2.62 volts
Filament Current at 2.5 Volts	----	16	17.5 amperes
Filament Heating Time Required	45	----	---- seconds
Anode to Grid Capacitance	----	1.4	---- uuf.
Grid to Filament Capacitance	----	8	---- uuf.
Deionization Time, Approximate ¹			
E _{bb} =1500 volts; I _b =16 amperes;	----	2500	---- microseconds
E _{cc} =-25 volts; THg=80C; Rg=20000 ohms			
Ionization Time, Approximate ²			
E _{bb} =100 volts; THg=40C; Grid Overvoltage=5 volts	----	75	---- microseconds
E _{bb} =100 volts; THg=80C; Grid Overvoltage=25 volts	----	1	---- microsecond
Anode Voltage Drop	----	15	---- volts
Critical Grid Current at 220 Anode Volts	----	----	5 microamperes

MECHANICAL DATA

Type of Cooling	Convection
Equilibrium Condensed Mercury Temperature	
Rise Above Ambient	
At Full Load (approximate)	25 Centigrade
At No Load (approximate)	15 Centigrade
Mounting Position	Vertical - base down
Net Weight, Approximate	8 ounces
Dimensions and pin connections shown in outline drawing on Page 4	

1. Deionization time decreases with an increase in negative grid voltage or with a decrease in (a) condensed mercury temperature (THg), (b) grid resistance or (c) anode current immediately preceding the end of conduction.
2. Ionization time decreases with an increase in (a) anode voltage, (b) condensed mercury temperature (THg) or (c) grid overvoltage. Grid overvoltage is defined as the magnitude by which the applied voltage exceeds, in a positive direction, the critical grid voltage value. Critical grid voltage is the instantaneous value of grid voltage at the time when anode current starts to flow.

TYPICAL CONTROL CHARACTERISTICS.
 SHADED AREA SHOWS RANGE OF CHARACTERISTICS,
 CONDENSED-MERCURY TEMPERATURE +30° TO+70°C

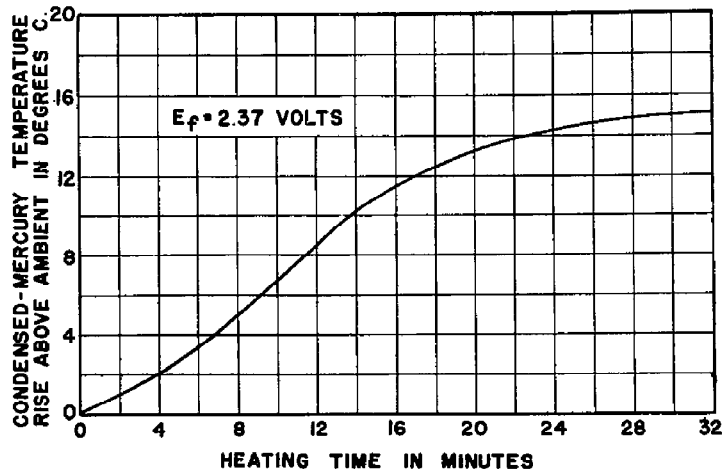
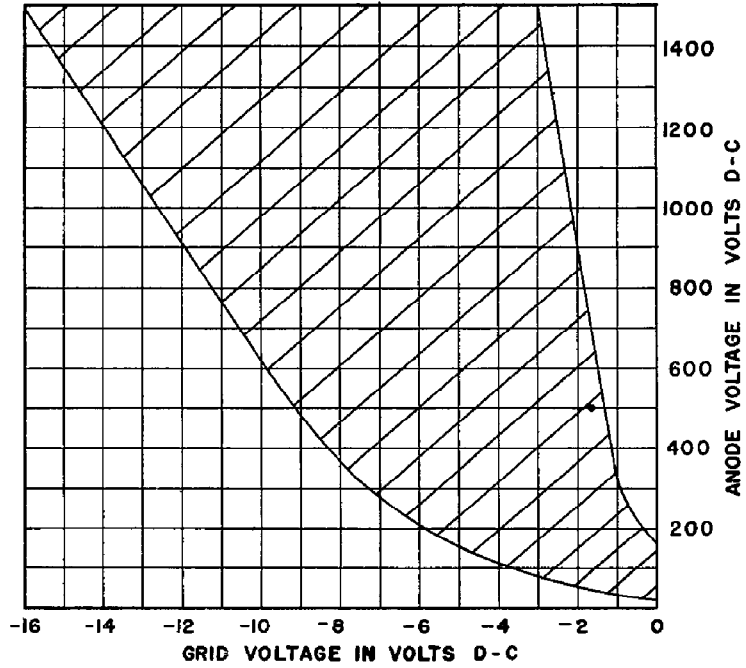

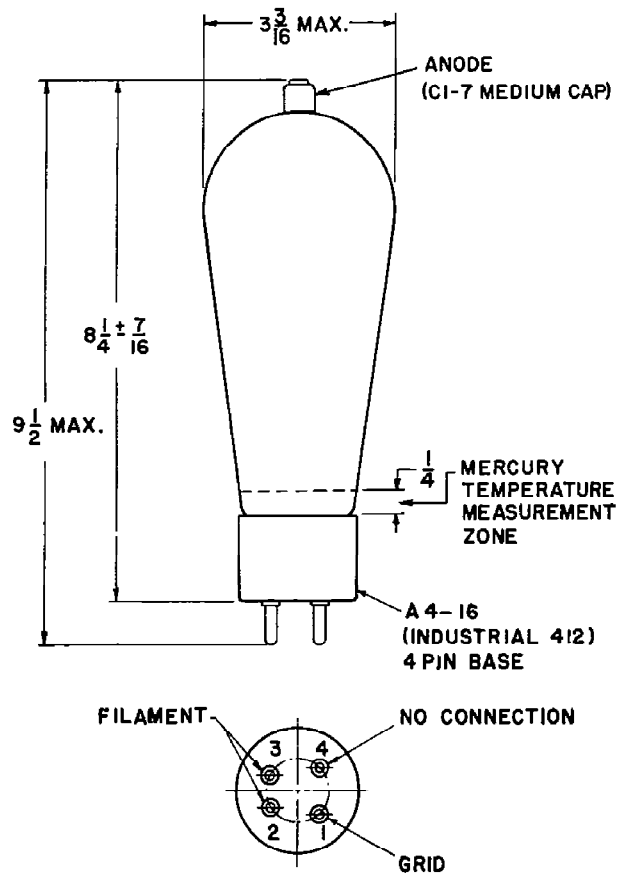

A development of Bell Telephone Laboratories, the research laboratories of the American Telephone and Telegraph Company and the Western Electric Company.

PRINTED IN U.S.A.

ELECTRON TUBE DATA SHEET
WESTERN ELECTRIC 355A ELECTRON TUBE

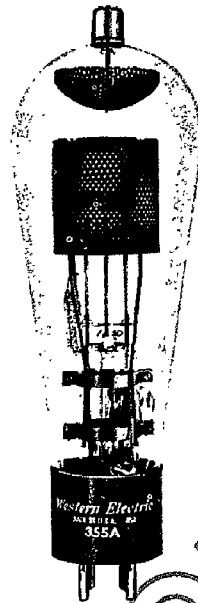

ONLY

355A

DESCRIPTION

The 355A is a three-electrode mercury-vapor and gas-filled thyatron with a negative control characteristic. This tube is designed for regulated or controlled rectifiers.

MAXIMUM RATINGS

Peak Anode Voltage 350 volts
Average Cathode Current 4 amperes

FILE:THYRATRON SECTION

MAXIMUM RATINGS, ABSOLUTE VALUES

Peak Anode Voltage	
Inverse	350 volts
Forward	350 volts
Cathode Current	
Peak	16 amperes
Average	4 amperes
Surge (maximum duration 0.1 second)	160 amperes
Averaging Time	15 seconds
Negative Grid Voltage	
Before Conduction	100 volts
During Conduction	10 volts
Positive Grid Current, Average (Averaging time = one cycle)	
	0.050 ampere
Condensed Mercury Temperature Limits ¹	
	-55 to +80 centigrade

ELECTRICAL DATA

	<u>Min.</u>	<u>Bogey</u>	<u>Max.</u>
Filament Voltage	2.37	2.5	2.62 volts
Filament Current at 2.5 Volts	----	16	17.5 amperes
Filament Heating Time Required	45	----	---- seconds
Anode to Grid Capacitance	----	1.4	---- uuf.
Grid to Filament Capacitance	----	8	---- uuf.
Deionization Time, Approximate ²			
E _{bb} =350 volts; I _b =16 amperes;			
E _{cc} =-15 volts; THg=80C; Rg=20000 ohms	----	3000	---- microseconds
Ionization Time, Approximate			
E _{bb} =100 volts; THg=40C; Grid Overvoltage=5 volts	----	15	---- microseconds
E _{bb} =100 volts; THg=80C; Grid Overvoltage=25 volts	----	1	---- microseconds
Anode Voltage Drop	----	15	---- volts
Critical Grid Current at 220 Anode Volts	----	----	5 microamperes
Change in Critical Grid Voltage at			
350 Anode Volts from +20 to +80 THg	----	0.2	---- volt

MECHANICAL DATA

Type of Cooling	Convection
Equilibrium Condensed Mercury Temperature	
Rise Above Ambient	
At Full Load, Approximate	25 centigrade
At No Load, Approximate	15 centigrade
Mounting Position	Vertical - base down
Net Weight, Approximate	8 ounces
Dimensions and pin connections shown in outline drawing on Page 4	

1. For starting conditions only. Equilibrium operation is limited to +20C minimum condensed mercury temperature.
2. Deionization time decreases with an increase in negative grid voltage or with a decrease in (a) condensed mercury temperature (THg), (b) grid resistance or (c) anode current immediately preceding the end of conduction.
3. Ionization time decreases with an increase in (a) anode voltage, (b) condensed mercury temperature (THg) or (c) grid overvoltage. Grid overvoltage is defined as the magnitude by which the applied voltage exceeds, in a positive direction, the critical grid voltage value. Critical grid voltage is the instantaneous value of grid voltage at the time when anode current starts to flow.

TYPICAL CONTROL CHARACTERISTICS
 SHADED AREA SHOWS RANGE OF CHARACTERISTICS
 CONDENSED MERCURY TEMPERATURE -55° TO +80°C

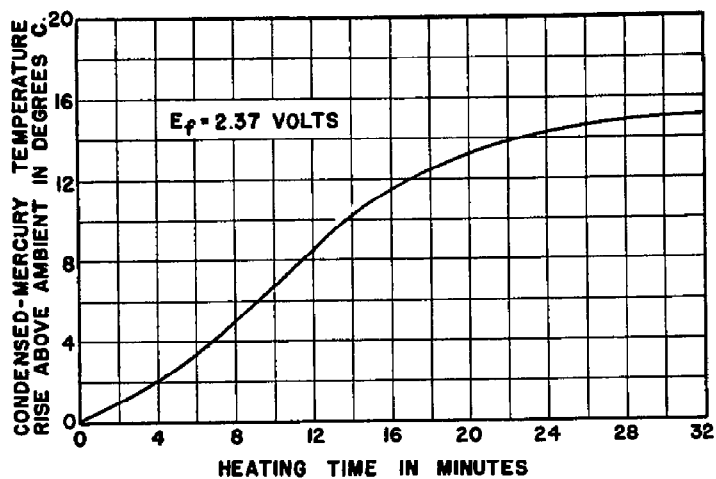
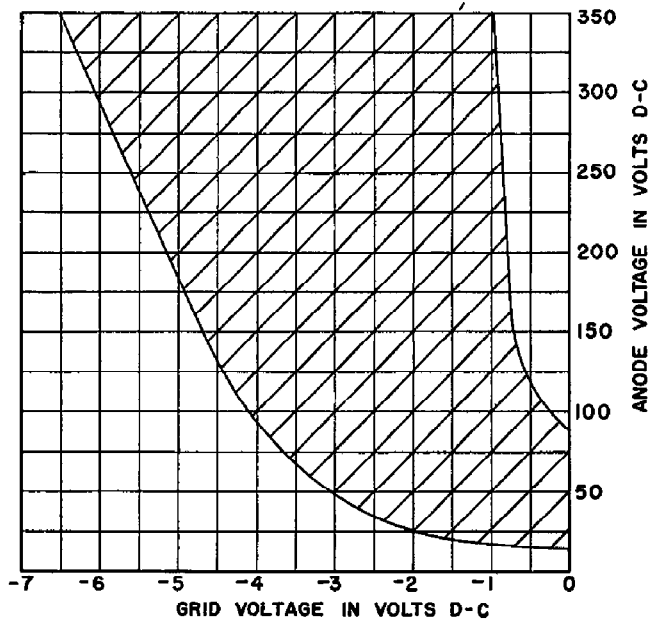

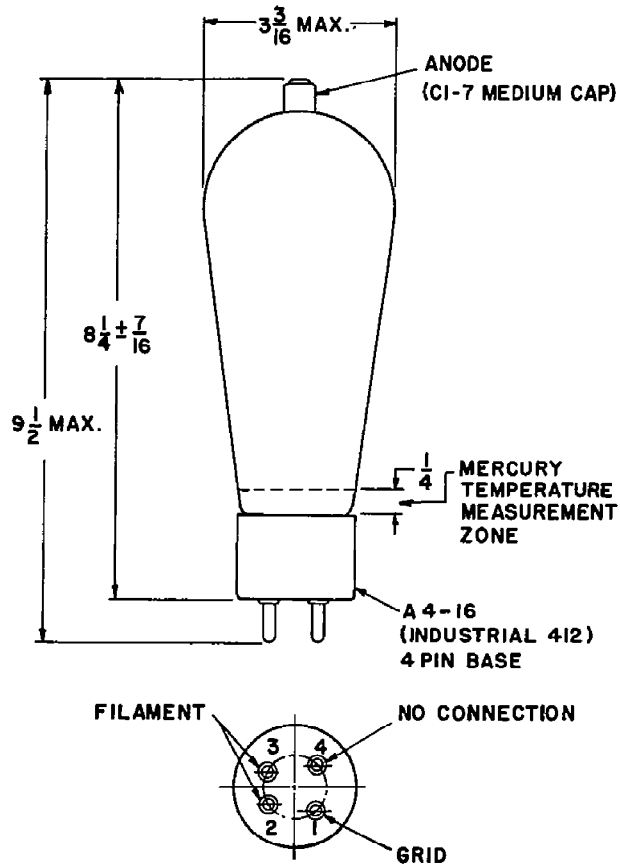

A development of Bell Telephone Laboratories, the research laboratories of the American Telephone and Telegraph Company and the Western Electric Company.

PRINTED IN U.S.A.

357B

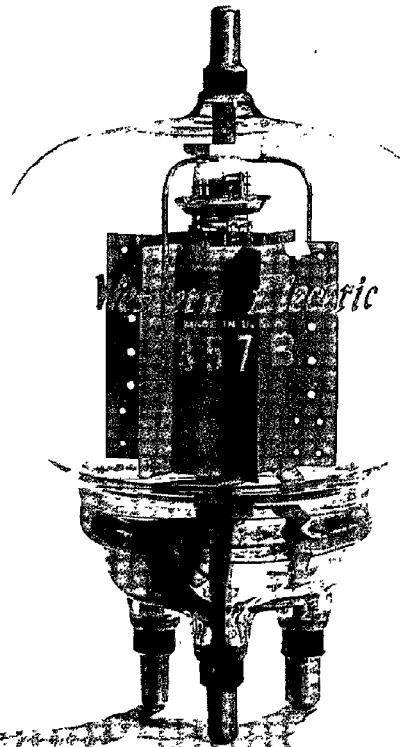

**TRIODE
AMPLIFIER, OSCILLATOR OR MODULATOR**

Western Electric

DESCRIPTION

The 357B is a three-electrode tube designed for use as a radio-frequency amplifier or oscillator, audio-frequency amplifier or modulator. The anode is capable of dissipating 400 watts. The tube is cooled by radiation at frequencies below 40 megacycles.

Forced-air cooling of the envelope is necessary at higher frequencies. The tube is capable of operating up to 100 megacycles at maximum ratings and up to 150 megacycles at reduced ratings. The cathode is a thoriated tungsten filament.

MAXIMUM RATINGS

D-C Plate Voltage	4000 volts
D-C Plate Current	0.500 ampere
Continuous Plate Dissipation	400 watts
D-C Grid Current	0.100 ampere



GENERAL CHARACTERISTICS

ELECTRICAL DATA

	Min.	Bogey	Max.
Filament Voltage	9.5	10.0	10.5 volts
Filament Current at Bogey Voltage	9.7	10.0	10.5 amperes
Filament Starting Current			50 amperes
Filament Resistance, Cold		0.12	ohm
Amplification Factor			
Conditions: $I_b = 200$ ma, $E_b = 2$ kv	27	30	34
Interelectrode Capacitances			
Grid-Plate	3.5	4.25	5.0 uuf
Grid-Filament	10.0	11.5	13.0 uuf
Plate-Filament	2.0	2.5	4.0 uuf
Maximum Usable Cathode Current ¹			2.5 amperes

MECHANICAL DATA

Mounting Position	Vertical, plate terminal up
Type of Cooling ²	Radiation or forced-air
Required Air Flow on Envelope	
When Operated Above 40 Megacycles	40 cfm
Maximum Incoming Air Temperature	45 centigrade
Maximum Glass Temperature	200 centigrade
Shock and Vibration	
Ruggedness ³ (duration of 5 milliseconds)	50 G
Natural Frequency of Elements	
Plate	100 cycles
Filament-Grid Structure	75 cycles
Net Weight, approximate	13 ounces

1. Represents maximum usable cathode current for tube as plate current plus grid current for any condition of operation.

2. Radiation cooling is adequate when the tube is operated below 40 megacycles and with a free circulation of air around the tube. If operated in a confined space or at a frequency above 40 megacycles, forced-air cooling is necessary. Satisfactory air cooling will be obtained from a blower delivering approximately 40 cubic feet of air per minute from a 2-inch diameter nozzle. The nozzle outlet should be placed approximately 3 inches from the

tube and directed toward the central point of the envelope, midway between the plate and grid terminals.

The plate terminal connector shall be of a design that will readily conduct heat from the plate terminal.

3. This test is equivalent to a JAN-1A Pendulum Bump Tester 15² test. The data given represent the maximum capabilities of the tube without electrical potentials applied and should not be construed to mean that the tube is capable of withstanding an infinite number of shocks of this magnitude.

MAXIMUM RATINGS AND TYPICAL OPERATING CONDITIONS**AUDIO-FREQUENCY POWER AMPLIFIER AND MODULATOR—CLASS B****MAXIMUM RATINGS, ABSOLUTE VALUES**

	CCS
D-C Plate Voltage	4000 volts
Signal D-C Plate Current ⁴	0.50 ampere
Signal Plate Input ⁴	1100 watts
Plate Dissipation ⁴	400 watts

TYPICAL OPERATION

Unless otherwise specified, values are for 2 tubes

	CCS	CCS	CCS ⁵
D-C Plate Voltage	2000	3500	3000 volts
D-C Grid Voltage	-50	-110	-85 volts
Peak A-F Grid-to-Grid Voltage	490	520	345 volts
Zero Signal D-C Plate Current	0.160	0.120	0.120 ampere
Maximum Signal D-C Plate Current	1.00	0.72	0.43 ampere
Effective Load Resistance, Plate-to-Plate	4360	11500	14700 ohms
Maximum Signal Driving Power, approximate	50.0	35.0	13.5 watts
Maximum Signal Power Output	1400	1840	850 watts

RADIO-FREQUENCY POWER AMPLIFIER—CLASS B

Carrier conditions per tube for use with maximum modulation factor of 1.0

MAXIMUM RATINGS, ABSOLUTE VALUES

	CCS
D-C Plate Voltage	4000 volts
D-C Plate Current	0.275 ampere
Plate Input	550 watts
Plate Dissipation	400 watts

TYPICAL OPERATION

	CCS	CCS
D-C Plate Voltage	2000	3500 volts
D-C Grid Voltage	-60	-125 volts
Peak R-F Grid Voltage	135	136 volts
D-C Plate Current	0.260	0.150 ampere
D-C Grid Current, approximate	0.100	0.001 ampere
Driving Power, approximate ⁶	25	8.5 watts
Power Output, approximate	175	190 watts

4. Averaged over any audio-frequency cycle of sine wave form.

5. As high level modulator for 1000 watt transmitter. Total harmonics approximately 1.5% at full output.

6. At crest of audio-frequency cycle with modulation factor of 1.0.

PLATE MODULATED RADIO-FREQUENCY POWER AMPLIFIER—CLASS C TELEPHONY

Carrier conditions per tube for use with maximum modulation factor of 1.0

MAXIMUM RATINGS, ABSOLUTE VALUES

	CCS
D-C Plate Voltage	3000 volts
D-C Grid Voltage	-500 volts
D-C Plate Current	0.400 ampere
D-C Grid Current	0.100 ampere
Plate Input	1100 watts
Plate Dissipation	235 watts

TYPICAL OPERATION

	CCS	CCS	CCS*
D-C Plate Voltage	2000	3000	3000 volts
D-C Grid Voltage	-310	-320	-270 volts
Peak R-F Grid Voltage	535	520	420 volts
D-C Plate Current	0.390	0.340	0.240 ampere
D-C Grid Current, approximate	0.070	0.065	0.035 ampere
Driving Power, approximate	35	35	20 watts
Power Output, approximate	550	780	550 watts

RADIO FREQUENCY POWER AMPLIFIER AND OSCILLATOR—CLASS C TELEGRAPHY

Key-down conditions per tube without amplitude modulation⁸

MAXIMUM RATINGS, ABSOLUTE VALUES

	CCS
D-C Plate Voltage	4000 volts
D-C Grid Voltage	-500 volts
D-C Plate Current	0.500 ampere
D-C Grid Current	0.100 ampere
Plate Input	1800 watts
Plate Dissipation	400 watts

TYPICAL OPERATION

	CCS	CCS
D-C Plate Voltage	2000	3500 volts
D-C Grid Voltage	-200	-240 volts
Peak R-F Grid Voltage	445	460 volts
D-C Plate Current	0.500	0.450 ampere
D-C Grid Current, approximate	0.085	0.070 ampere
Driving Power, approximate	35	30 watts
Power Output, approximate	780	1200 watts

Maximum ratings apply up to 100 megacycles. The tube may be operated at higher frequencies provided the maximum values of plate voltage and plate input are reduced according

to the tabulation below. Other maximum ratings are not affected. Forced-air cooling of the envelope with an air flow of approximately 40 cfm is required at these frequencies.

Frequency	100	125	150 megacycles
Percentage of maximum rated plate voltage and plate input.			
Class B	100	85	70 per cent
Class C, plate modulated	100	75	50 per cent
Class C, unmodulated	100	80	60 per cent

*. For 500 watt broadcast transmitter application.
 8. Modulation essentially negative may be used if the positive peak of the envelope does not exceed 115 per cent of its unmodulated value.

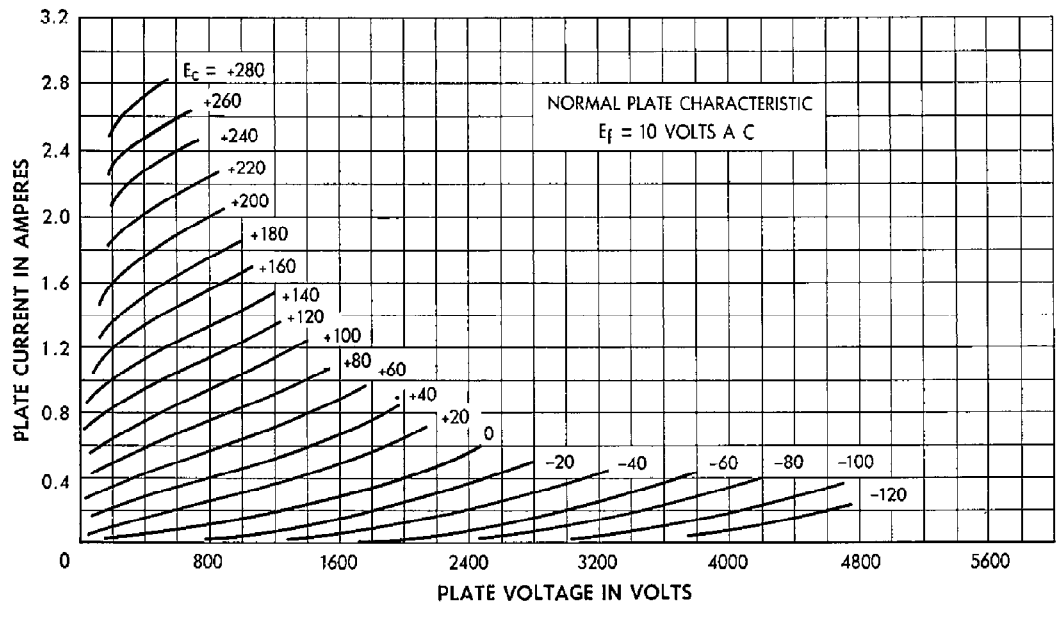
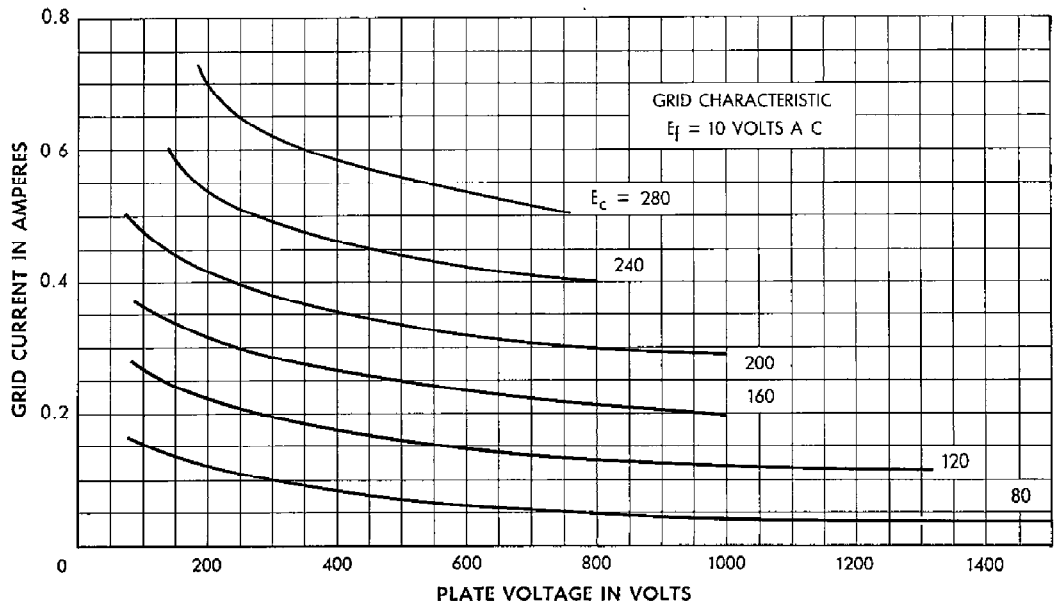

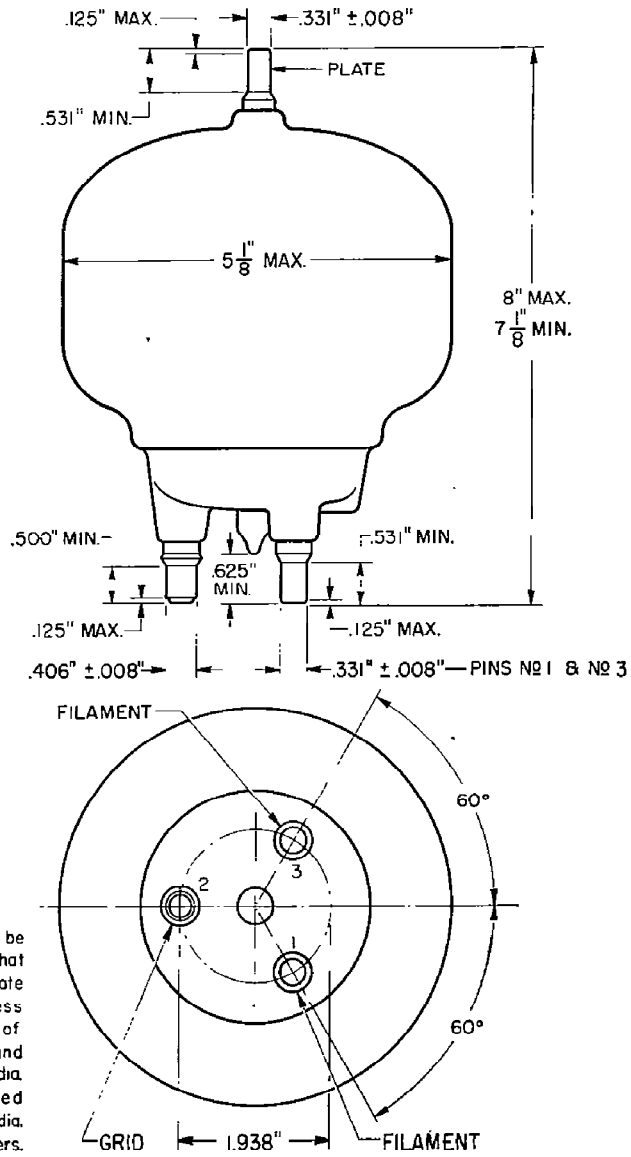

Note:
 Base pin positions shall be held to tolerances such that pins will fit a flat - plate gauge having a thickness of $.250''$ with 2 holes of $.391'' \pm .0005''$ dia. and 1 hole of $.469'' \pm .0005''$ dia. All holes shall be located on a $1.938'' \pm .0005''$ dia. circle at specified centers.

Western Electric

A development of Bell Telephone Laboratories, the research laboratories of the American Telephone and Telegraph Company and the Western Electric Company.

ELECTRON TUBE DATA SHEET
WESTERN ELECTRIC 358A ELECTRON TUBE

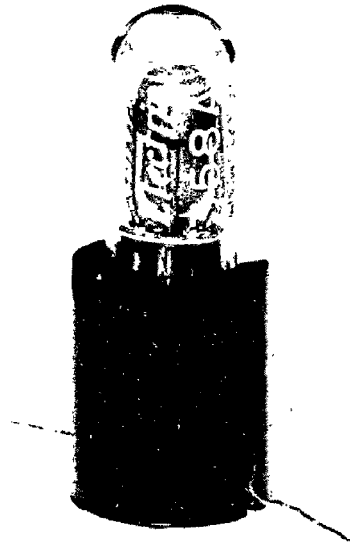

358A

DESCRIPTION

The 358A is a two-electrode, inert-gas-filled, cold cathode tube designed to provide a visual signal for telephone work. When the tube is conducting, a glow will appear near the surface of the negative electrode. If a d.c. voltage supply is used the negative polarity should be applied to the upper electrode. The upper electrode terminal may be identified by the adjacent circular dot of contrasting color on the base. When the tube is operating with an alternating voltage a glow will appear on both electrodes.

CHARACTERISTICS

Anode Breakdown Voltage, Maximum			85	volts
Average Cathode Current	7.5	10	18	milliamperes
Average Life, (approx. at above currents) . . .	5000	1000	100	hours

File: Cold Cathode Section

RATINGS, Absolute System (Note 1)

Cathode Currents

Maximum Peak	55 milliamperes
Maximum Average	18 milliamperes
Ambient Temperature Limits	-55 to +85° centigrade

ELECTRICAL DATA, Throughout Life (Note 2)

	<u>Min.</u>	<u>Bogey</u>	<u>Max.</u>	
Anode Breakdown Voltage	-	65	85	volts
Anode Voltage Drop	-	60	75	volts
Light Output at 15 mAdc	-	0.6	-	lumen

MECHANICAL DATA

Mounting Position Any
Dimensions and terminal connections shown in outline drawing on page 3.

APPLICATION DATA

This tube possesses a unique property not common to filamentary type lamps in that its impedance is essentially infinite for voltages below breakdown. In some applications this is an advantageous feature since the tube may be used to pass current at the higher potentials without placing a conducting path across the line for signals of lower voltage.

Unlike filamentary type lamps the light output of this tube is proportional to the current through the tube instead of varying as a power of this current. This tube is well adapted to furnishing a visual signal from a varying voltage source.

Note 1: In the "Absolute System" the maximum ratings specified are limiting values above which the serviceability of the device may be impaired from the viewpoint of life and satisfactory performance. Maximum ratings, as such, do not constitute a set of operating conditions and all values may not, therefore, be attained simultaneously.

Note 2: When the tube is operating from a direct current supply, the upper electrode shall be used as the cathode.

HANDLING

This tube contains a small amount of krypton-85 gas which is a by-product radioactive material. The amount of krypton-85 is less than five microcuries, which is too small an amount to require any special care in use.

Atomic Energy Commission regulations require that the individual tube carton for tubes containing by-product radioactive material be appropriately marked. The marking includes the statement that tube disposal should be in approved manner.

Approved instructions for disposal of tubes containing krypton-85 are as follows;

Tubes to be disposed of should be broken or crushed in a well ventilated place releasing any resulting vapors to the outside atmosphere. The residual broken or crushed tubes should be disposed of in a normal public trash disposal system. Tubes should be disposed of at a rate of not more than 100 each week from any one location. Avoid breathing vapors from broken tubes.

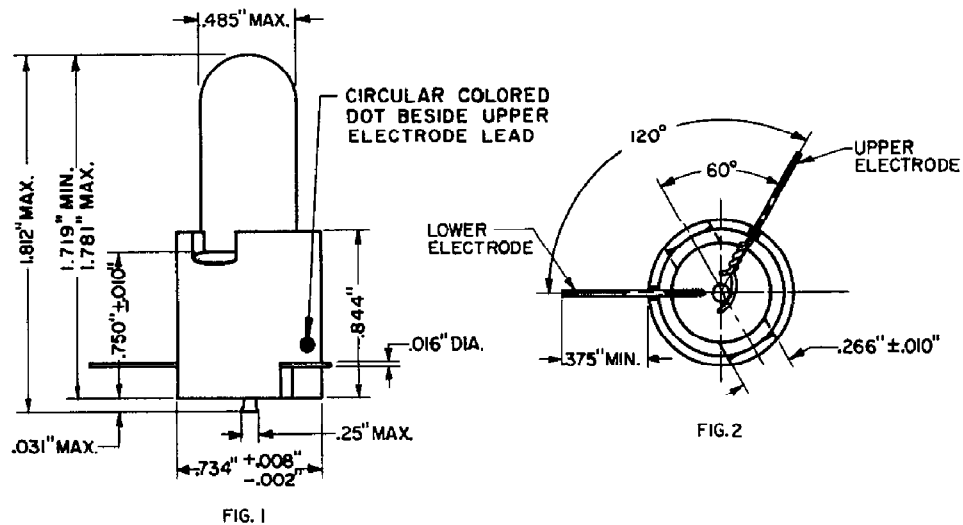

A development of Bell Telephone Laboratories, the research laboratories of the American Telephone and Telegraph Company and the Western Electric Company.

PRINTED IN U. S. A.

ELECTRON TUBE DATA SHEET
WESTERN ELECTRIC 359A ELECTRON TUBE



359A

DESCRIPTION

The 359A is a three-electrode, inert-gas-filled, cold cathode tube for use primarily as a relay in communication circuits. It is also suitable for use in control circuits such as in triggering, counting or switching apparatus and as a visual indicator. This tube, by reason of small size and provision for wiring directly into the circuits, may be used to advantage in equipment having limited space for components.

CHARACTERISTICS

Peak Anode Voltage, Maximum	165	165	volts
Average Cathode Current	4	40	milliamperes
Average Life, Approximate	10000	10	hours

FILE: COLD CATHODE SECTION

Indicates a change ←

MAXIMUM RATINGS, Absolute System (Note 1)

→ Peak Anode Voltage (Note 2)			
Forward	165		volts
Inverse	165		volts
Forward Cathode Current (Note 3)			
Peak	40		milliamperes
Average	15		milliamperes
Averaging Time	1		second
Peak Inverse Current, Anode or Starter (Note 3)	1		milliampere
Ambient Temperature Limits	-55° to +85°		centigrade

ELECTRICAL DATA (Throughout Life)

	<u>Min.</u>	<u>Bogey</u>	<u>Max.</u>	
Starter Breakdown Voltage (Notes 2 & 4)	67	80	89	volts
Starter Voltage Drop at 10 Milliamperes	52	65	74	volts
Anode Voltage Drop at 10 Milliamperes	66	80	90	volts
Transfer CurrentSee curve, Figure 1			
Required Transfer Current at 130 Anode Volts	50	-	-	microamperes
Deionization Time, Main Gap	-	1	-	millisecond
→ Ionization Time, Starter Gap (Note 5)	-	0.05	-	millisecond

MECHANICAL DATA

Mounting Position Any
 New Weight, Approximate 0.4 ounce
 Dimensions and lead connections shown in outline drawings on page 4.

HANDLING

This tube contains a small amount of krypton-85 gas which is a by-product radioactive material. The amount of krypton-85 is less than five microcuries, which is too small an amount to require any special care in use.

Atomic Energy Commission regulations require that the individual tube carton for tubes containing by-product radioactive material be appropriately marked. The marking includes the statement that tube disposal should be in approved manner.

→ Approved instructions for disposal of tubes containing krypton-85 are as follows;

Tubes to be disposed of should be broken or crushed in a well ventilated place releasing any resulting vapors to the outside atmosphere. The residual broken or crushed tubes should be disposed of in a normal public trash disposal system. Tubes should be disposed of at a rate of not more than 100 each week from any one location. Avoid breathing vapors from broken tubes.

Note 1: In the "Absolute System" the maximum ratings specified are limiting values above which the serviceability of the device may be impaired from the viewpoint of life and satisfactory performance. Maximum ratings, as such, do not constitute a set of operating conditions and all values may not, therefore, be attained simultaneously.

→ Indicates a change

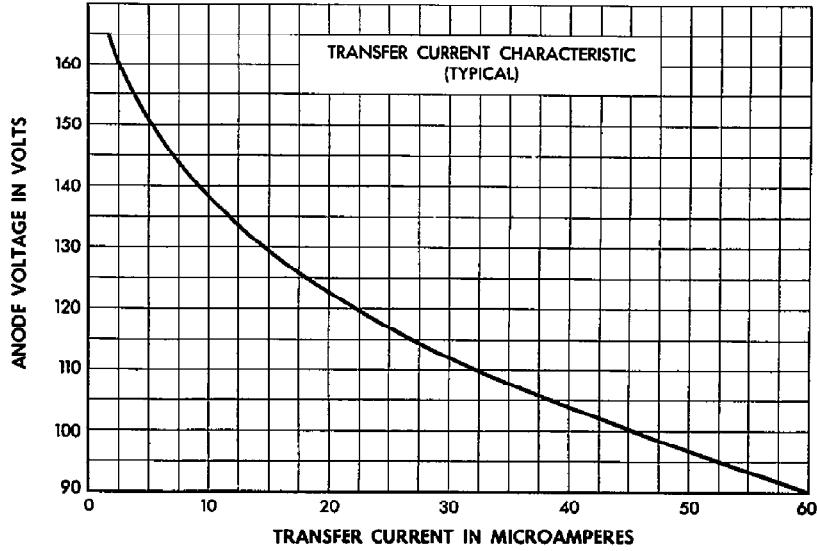

FIG. 1

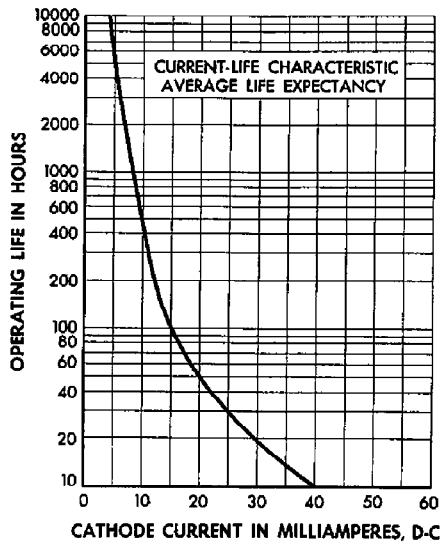

FIG. 2

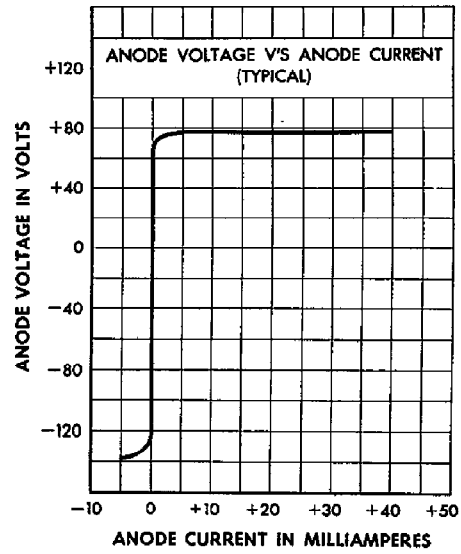

FIG. 3

Note 2: Values apply with the tube exposed to light in the order of 5 to 30 foot-candles. Exposure to direct sunlight may reduce peak anode voltage rating by as much as 45 volts and starter breakdown voltage by as much as 2 volts. ←

Note 3: Sufficient resistance must be used in series with the tube to assure that the electrode currents do not exceed the maximum rated values.

Note 4: Limits apply immediately after the tube has conducted current. If the tube has been idle, initially these values may be as much as 3 volts higher or lower.

Note 5: With 15 volts starter overvoltage. This value applies with the tube exposed to light in the order of 5 to 30 foot-candles. In darkness, ionization time will increase to a bogey value of 5 milliseconds. ←

← Indicates a change

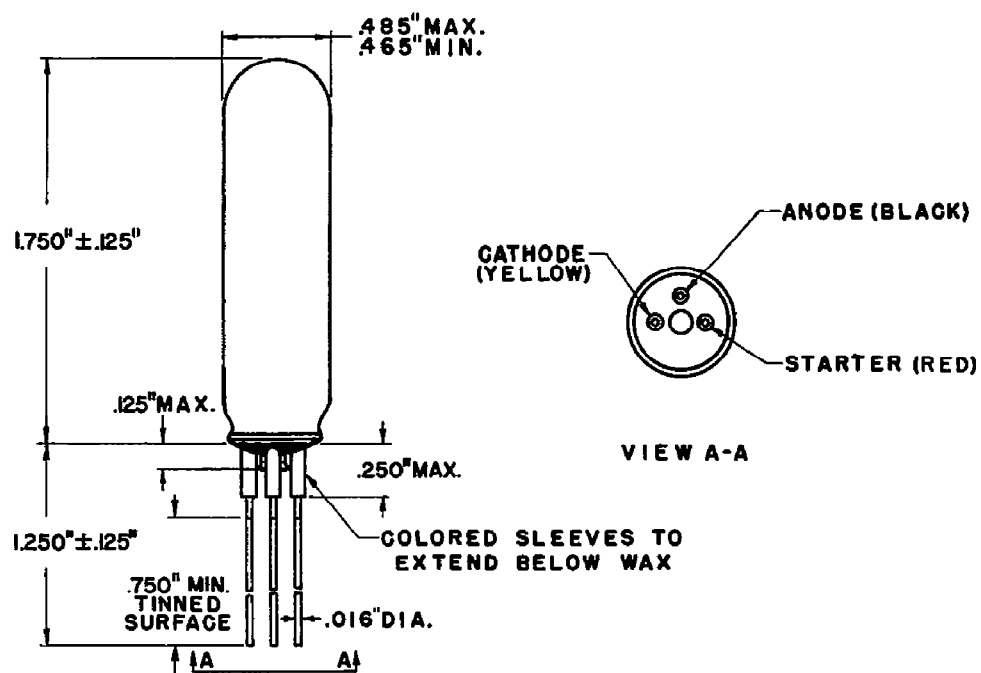

A development of Bell Telephone Laboratories, the research laboratories of the American Telephone and Telegraph Company and the Western Electric Company.

PRINTED IN U.S.A.

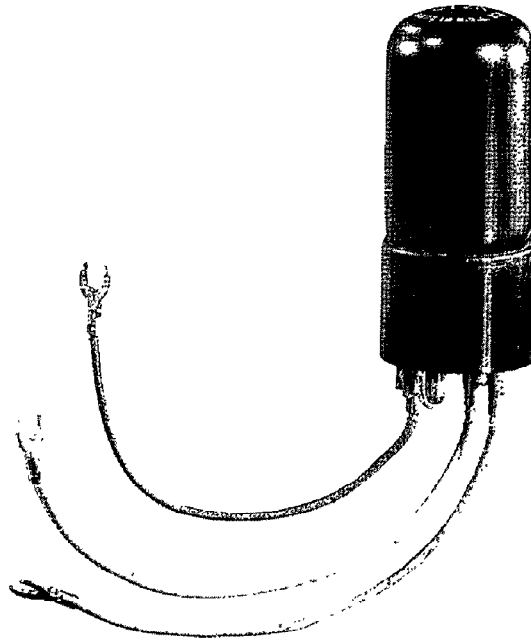

372A

COLD CATHODE

Western Electric

DESCRIPTION

The 372A is a three-electrode, inert-gas-filled, cold cathode tube for use in relay, voltage regulator, or rectifier circuits. This tube is especially suitable for use in control circuits such as in triggering, counting, or switching apparatus.

MAXIMUM RATINGS

Peak Anode Voltage	150 volts
Average Cathode Current	10 100 milliamperes
Average Life, approximate	10000 10 hours
Transfer Current	5 microamperes

MAXIMUM RATINGS, Absolute Values

Forward Peak Anode Voltage	150 volts
Forward Cathode Current	
Peak	100 milliamperes
Average	35 milliamperes
Averaging Time	2 seconds
Peak Inverse Anode Current	5 milliamperes
Ambient Temperature Limits	-55 to +85 centigrade

ELECTRICAL DATA

	Min.	Bogey	Max.
Starter Breakdown Voltage*	62	70	89 volts
Starter Voltage Drop at 20 milliamperes	52	60	74 volts
Anode Voltage Drop at 20 milliamperes	68	75	90 volts
Transfer Current at 130 Anode Volts (D.C.)	5		microamperes
Deionization Time, approximate			
Starter Gap		3	milliseconds
Main Gap		10	milliseconds
Inverse Current at -120 Volts Anode Potential**			3 milliamperes

MECHANICAL DATA

Mounting Position	Any
Net Weight, approximate	1 ounce

* Limits apply immediately after tube has conducted current. If tube has been idle, these values initially may be as much as 3 volts higher or lower.

** Negative anode voltage applied through 8,000 ohms. Starter connected to anode through 100,000 ohms.

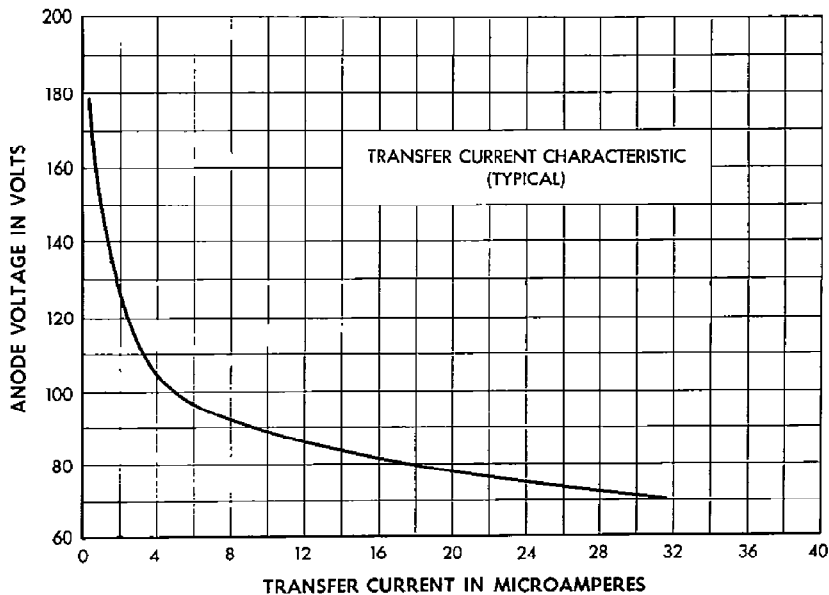

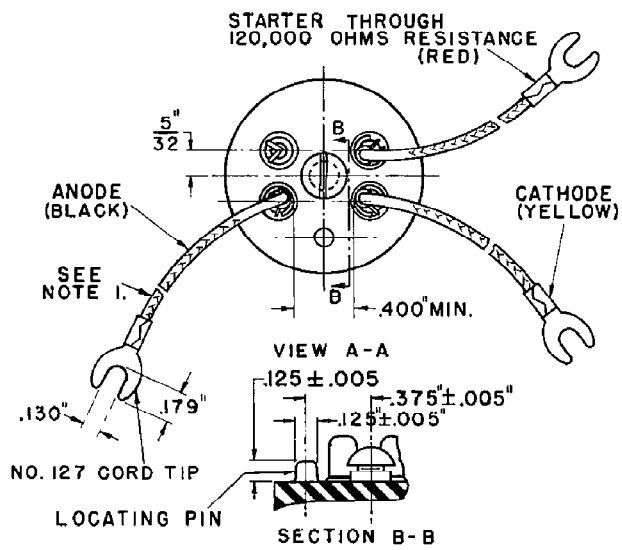
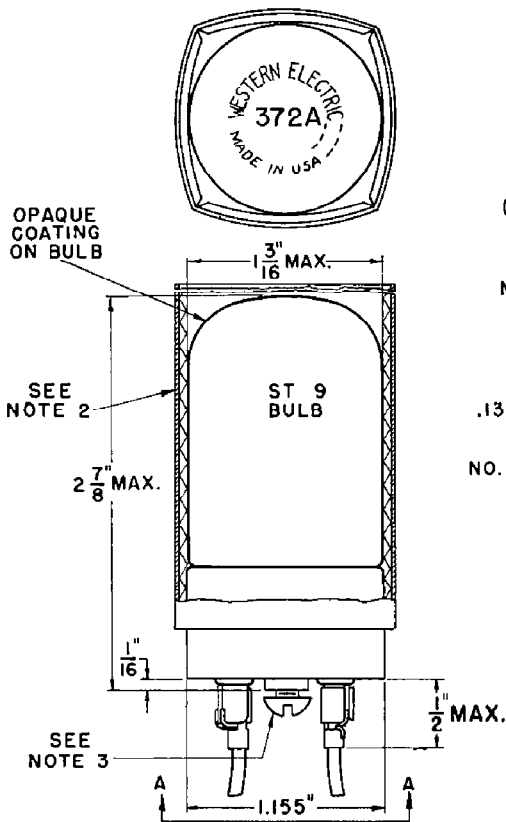
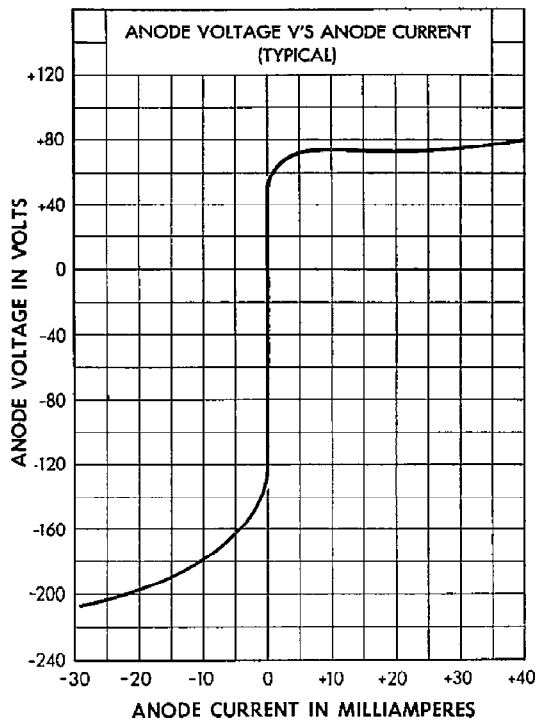
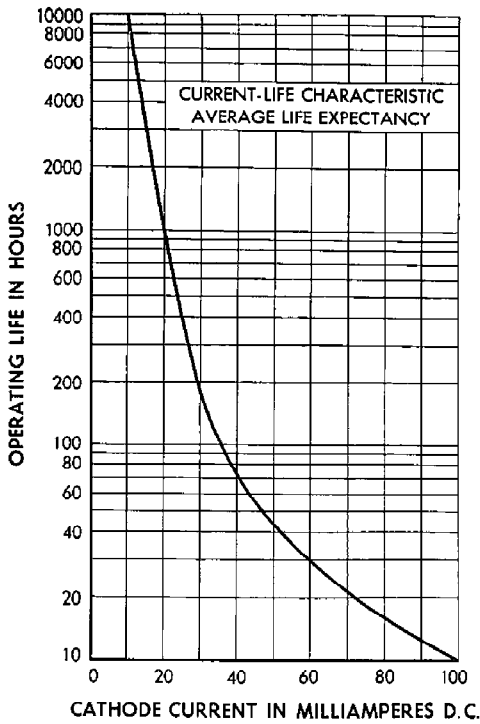

- NOTES -
1. LENGTH OF LEADS FROM END OF BASE SHELL TO END OF SPADE $5 \pm \frac{3}{4}$
 2. TUBE SHIPPED WITH CORRUGATED PAPER SHOCK PROTECTIVE SLEEVE COVERING ENVELOPE AND PART OF BASE. SLEEVE SHOULD REMAIN ON TUBE WHEN INSTALLED IN TELEPHONE SET APPLICATIONS.
 3. THE $.164 - 32 \times \frac{3}{16}$ SCREW ALLOWS FOR MOUNTING ON A BRACKET $\frac{3}{64}$ THICK. (SCREW NOT SUPPLIED WITH TUBE.)

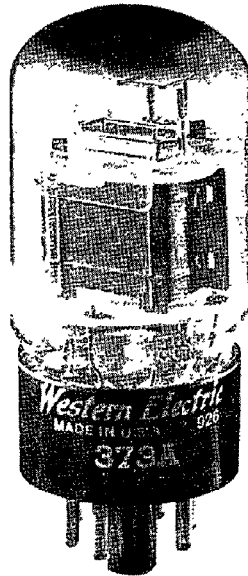

373A

PENTODE

Western Electric

DESCRIPTION

The 373A is a filamentary type suppressor grid pentode. It is designed for use as an audio, carrier or radio-frequency voltage amplifier, oscillator or modulator.

CHARACTERISTICS

Filament Voltage, A-C		2.0 volts
Plate Current	} $E_b = E_{c2} = 150$ volts; }	2 milliamperes
Transconductance		} $E_{c1} = -3$ volts; $E_{cs} = 0$ }

GENERAL CHARACTERISTICS

ELECTRICAL DATA

Filament Voltage, A-C	2.0 volts
Filament Current	250 milliamperes
Direct Interelectrode Capacitances	
Grid to Plate (maximum)	0.07 uuf
Input	5.9 uuf
Output	5.0 uuf

MECHANICAL DATA

Cathode	Coated Filament
Bulb	T11
Base ¹	Short intermediate shell, 7-pin octal
Mounting Position	Vertical — or horizontal with plane of filament vertical.

Dimensions and pin connections shown in outline drawing on Page 4

MAXIMUM RATINGS, Design-Center Values

Plate Voltage	250 volts
Screen Grid Voltage	150 volts
Plate Dissipation	2 watts
Screen Grid Dissipation	0.45 watt

TYPICAL OPERATING CONDITIONS AND CHARACTERISTICS

Filament Voltage, A-C	2.0	2.0 volts
Plate Voltage	150	250 volts
Screen Grid Voltage	150	150 volts
Control Grid Voltage	-3	-3 volts
Suppressor Grid Voltage	0	0 volts
Plate Current	2.0	2.1 milliamperes
Screen Grid Current	0.47	0.45 milliampere
Peak A-F Signal Voltage	2	2 volts
Plate Resistance	1.5	2.0 megohms
Transconductance	1280	1310 micromhos
Load Resistance	100000	250000 ohms
Power Output	120	160 milliwatts
Total Harmonic Distortion	8.5	7.8 per cent
Control Grid Voltage, Approximate, for 10 Microamperes Plate Current	-7.0	-7.4 volts

1. Pin #6 is connected internally to pin #5 and is approximately 3/32 inch shorter than the other pins to minimize noise when changing tubes while in service.

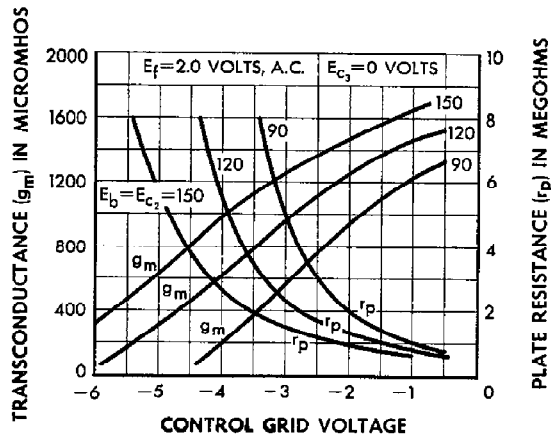
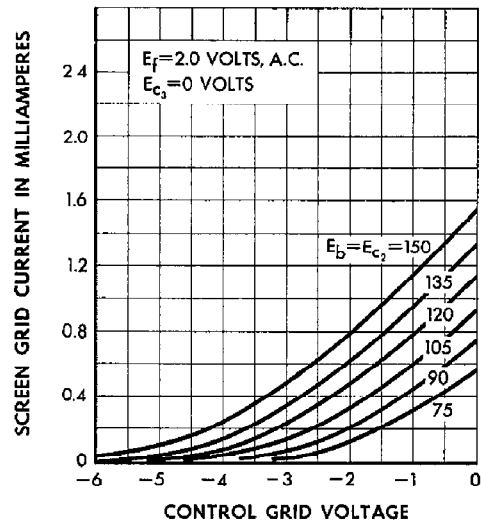
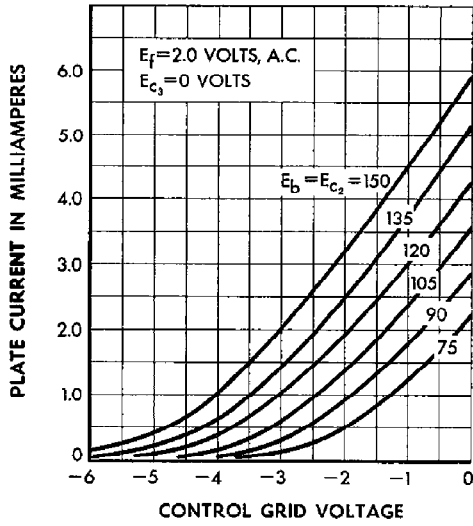

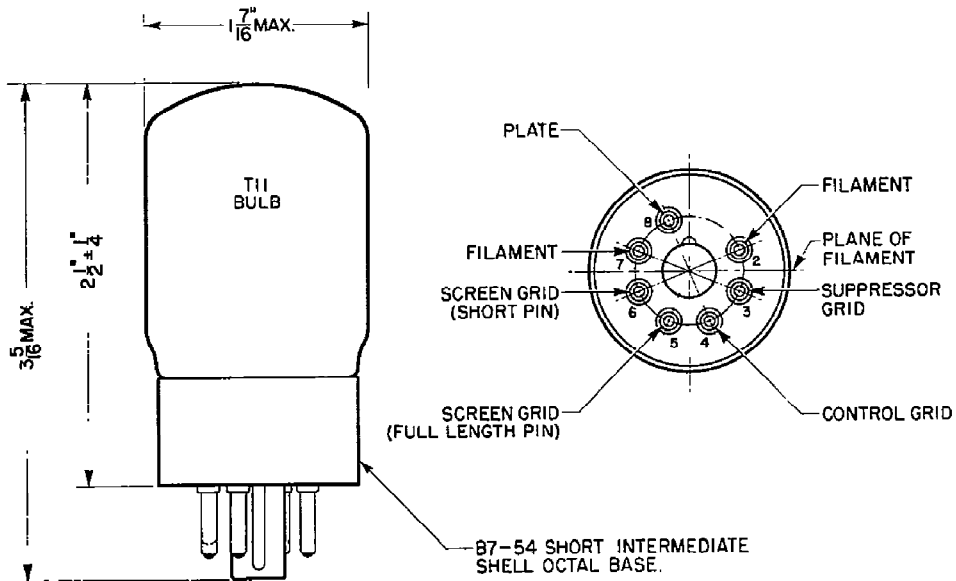
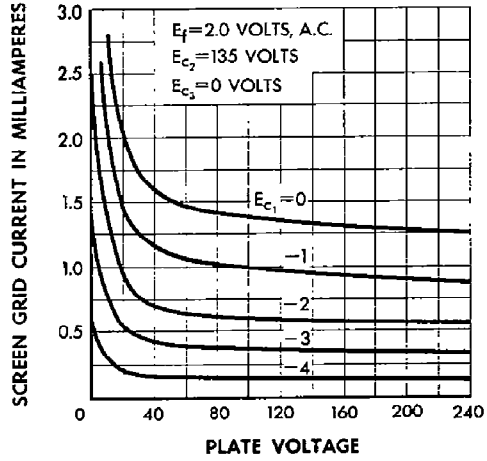
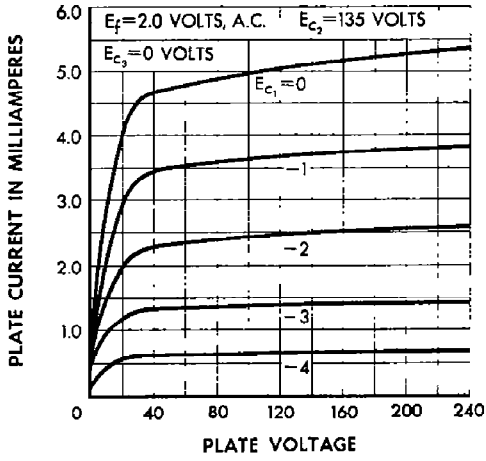

Western Electric

A development of Bell Telephone Laboratories, the research laboratories of the American Telephone and Telegraph Company and the Western Electric Company.