

**INSTRUCTION MANUAL  
FOR  
TRANSCEIVER  
MODEL TR-5C**

*the hallicrafters* co.  
A Subsidiary of Northrop Corporation



Printed in U.S.A.  
094-004710 Issue C  
1172



LIMITED RIGHTS TO TECHNICAL DATA

"This Instruction Manual is furnished at the request of the user and shall not be either released outside the user company, or used, duplicated, or disclosed in whole or in part for manufacture or procurement, without the written permission of The Hallicrafters Co., except for: (1) emergency repair or overhaul work by or for the user company, where the item or process concerned is not otherwise reasonably available to enable timely performance of work; or (2) release to a foreign government, as the interests of the United States may require: provided that in either case the release, use, duplication, or disclosure hereof shall be subject to the foregoing limitations. This legend shall be marked on any reproduction hereof in whole or in part."

TABLE OF CONTENTS

Section	Page
I INTRODUCTION . . . . .	1
1. Purpose of Equipment . . . . .	1
3. Functional Description . . . . .	1
5. Physical Description . . . . .	1
II SPECIFICATIONS . . . . .	1
III INSTALLATION AND ALIGNMENT . . . . .	5
8. Unpacking . . . . .	5
11. Alignment Procedures . . . . .	5
14. Location and Function of Controls . . . . .	8
IV OPERATION . . . . .	12
21. Operation . . . . .	12
V PREVENTIVE AND CORRECTIVE MAINTENANCE . . . . .	12
27. Introduction . . . . .	12
29. Theory of Operation . . . . .	12
37. Corrective Maintenance . . . . .	17
39. Trouble Shooting . . . . .	17
42. Parts Replacement And Alignment . . . . .	19
45. Alignment After Repairs . . . . .	19
50. Repair Replacement Schedule . . . . .	20
VI PARTS LIST . . . . .	26

LIST OF ILLUSTRATIONS

Figure	Title	Page
1.	Hamlet Radio Transceiver . . . . .	vi
2.	Transceiver Rear View, Crystal, Transistor and Adjustment Locations . . . . .	4
3.	Transceiver Top View, Crystal, Transistor, Vacuum Tube and Adjustment Locations . . . . .	6
4.	Model TS-20/35 Test Set . . . . .	8
5.	Hamlet Radio Transceiver, Control Location . . . . .	10



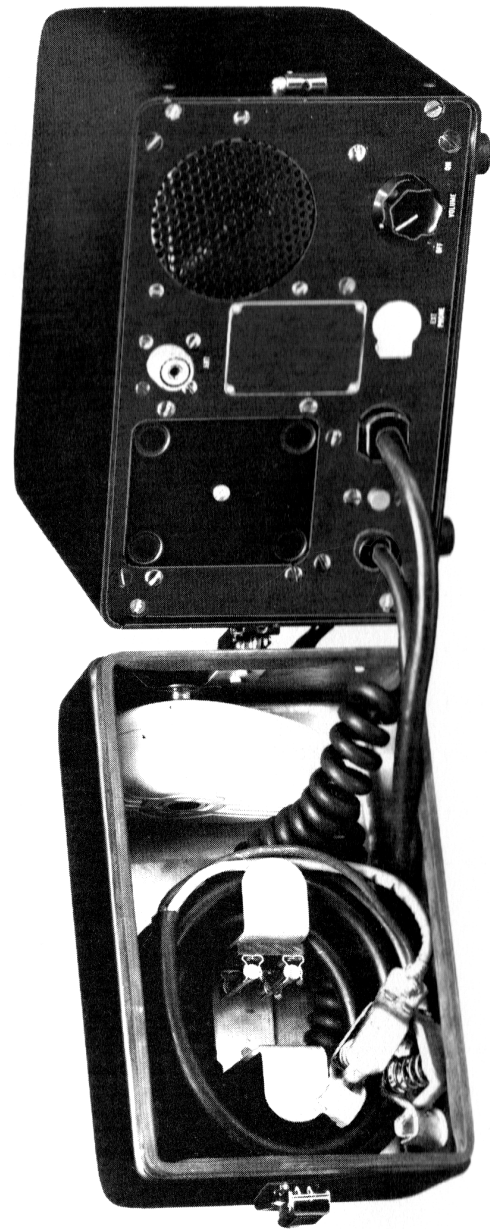

156-006450

Figure 1. Hamlet Radio Transceiver.

## SECTION I INTRODUCTION

### 1. PURPOSE OF EQUIPMENT.

2. The Hamlet Radio Transceiver, Model TR-5C, together with the Model A-20A Antenna provides reliable point-to-point communications. The Model TR-5C Transceiver operates in the 30 to 40 megacycle frequency range on a single pre-set channel, with AM (amplitude modulated) voice transmission and reception capabilities. The transceiver is compatible with the Village Radio Transceiver, Model TR-20 and Transceiver Model HT-1 equipments. The Hamlet Radio Transceiver Model TR-5C is designed for net operation with units of the same type and the Village Radio Transceiver, Model TR-20 as the control station. The power output (4 watts minimum) was chosen to provide reliable and effective communication without creating interference to users of the same equipment, and channel in neighboring villages.

### 3. FUNCTIONAL DESCRIPTION.

4. The transceiver operates from a 12 volt DC power source such as a storage battery. The transceiver is ready for operation when connected to

a suitable antenna and power source, and requires no adjustment or tuning procedures during operation. The use of transistorized circuits in the receiver, modulator, and power converter sections minimizes battery drain. The use of instant-heating filament type tubes in the transmitter section further reduces standby power requirements.

### 5. PHYSICAL DESCRIPTION.

6. The transceiver, shown in figure 1, is light weight, compact, and rugged in construction. The sealed case prevents damage due to moisture when in transit. The removable cover provides an effective seal through the use of a rubber gasket. It provides storage facilities for the microphone, power cord, earphone, and spare fuses during transit. All external connections are made at the front panel. The transceiver is 5 inches high, by 8 inches wide, by 7 inches deep, excluding the removable cover. The removable cover is 2-3/4 inches deep. The unit weighs approximately 7.5 pounds.

## SECTION II SPECIFICATIONS

7. Specifications applicable to the Hamlet Radio Transceiver are presented in Table I.

The transistor, diode, and vacuum tube complement is listed in Table II; fuses in Table III.

TABLE I. SPECIFICATIONS.

#### GENERAL:

Input Voltage - 12.0 volts DC,  $\pm 10\%$ , 4.5 amperes (maximum)  
 Transmit cycle (maximum) - 20% on a continuous basis  
 50% in any single 5 minute period

#### TRANSMITTER:

Electron tube circuit, instant-heating filaments for Buffer and Final Amplifier, Transistorized Oscillator  
 Power Output - 4 watts (minimum)  
 Emission - AM (amplitude modulated) Voice  
 Frequency Range - 30 to 40 megacycles  
 Number of Channels - 1 (crystal controlled)  
 Frequency Stability -  $\pm 0.005\%$   
 Output Impedance - 50-ohms (nominal)



TABLE I. SPECIFICATIONS (CONT.).

<b>RECEIVER:</b>	
Transistorized, Superheterodyne, double conversion	
Frequency Range - 30 to 40 megacycles	
Number of Channels - 1 (crystal controlled)	
Frequency Stability - 0.005%	
Input Impedance - 50-ohms (nominal)	
Sensitivity - 1 microvolt for 10DB $\frac{\text{Signal} + \text{Noise}}{\text{Noise}}$	
Selectivity - Better than 4 kilocycles at 6 DB down Less than 45 kilocycles at 60 DB down	
First Intermediate Frequency - 10,455 kilocycles	
Second Intermediate Frequency - 455 kilocycles	
Audio Output - 0.500 watt (mimimum)	
Standby Current - 0.030 ampere (no signal)	
Operating Current - 0.060 ampere (average signal)	
<b>MODULATOR:</b>	
Transistorized, high level, utilizing portions of receiver audio circuits	
Power Output - 6 watts (nominal)	
Frequency Response - 400 to 2,500 cycles	
<b>POWER CONVERTER:</b>	
Transistorized, 12-volt DC to 275-volt DC, 27 watts, with silicon power rectifiers	
Input Voltage - 12 volts DC	
Output Voltage - 275 volts DC, 0.100 ampere	

TABLE II. TRANSISTOR, DIODE, AND VACUUM TUBE COMPLEMENT.

Reference Designation	Type	Function
RECEIVER SECTION		
Q1	2N2654	RF Amplifier
Q2	2N2654 (modified)	First Converter
Q3	2N2654 (modified)	IF amplifier, 10,455-KC
Q4	2N2672	Second Oscillator/Converter
Q5	2N2672	First 455-KC IF Amplifier

Revised November 1972

TABLE II. TRANSISTOR, DIODE, AND VACUUM TUBE COMPLEMENT (Cont.).

Reference Designation	Type	Function
Q6	2N2672	Second 455-KC IF Amplifier
Q7	2N1098	Detector - AGC Amplifier
Q8	2N2672	First Converter Oscillator
Q9	SA536	First Audio Amplifier
Q10	2N4036	Class B Audio Output and Mod Driver
Q11	2N4036	Class B Audio Output and Mod Driver
Q12	2N2672	Squelch IF Amplifier
Q13	2N388	Squelch DC Amplifier
D1	1N48A	Noise Limiter
D2	G417	AGC Rectifier
D3	1N48A	Squelch Rectifier
D4	1N91	Polarity Protect Diode
D5	1N759	Zener Voltage Regulator, 12 volt
D6	1N48A	RF Overload Diode
D7	1N4001	
MODULATOR SECTION		
Q101	SP-777	Class B Modulator
Q102	SP-777	Class B Modulator
POWER SUPPLY SECTION		
Q103	2N1535	Power Converter, Switching
Q104	2N1535	Power Converter, Switching
D101	G417	Transient Spike Suppressor
D102	U214	High Voltage Rectifier
D103	U214	High Voltage Rectifier
D104	U214	High Voltage Rectifier
D105	U214	High Voltage Rectifier
D106	1N91	Polarity Protect Diode
TRANSMITTER SECTION		
Q301	2N3641	Transmitter Oscillator
V101	7905	Buffer/Amplifier
V102	7905	Transmitter Power Amplifier
D301	1N4737	Zener Voltage Regulator, 7.5 Volt

TABLE III. FUSE COMPLEMENT.

Reference Designation	Type	Function
F101	3 ampere, 3 AG	Destruct fuse
F102	8 ampere, 3 AG	Equipment overload protection

Revised November 1972



## SECTION III INSTALLATION AND ALIGNMENT

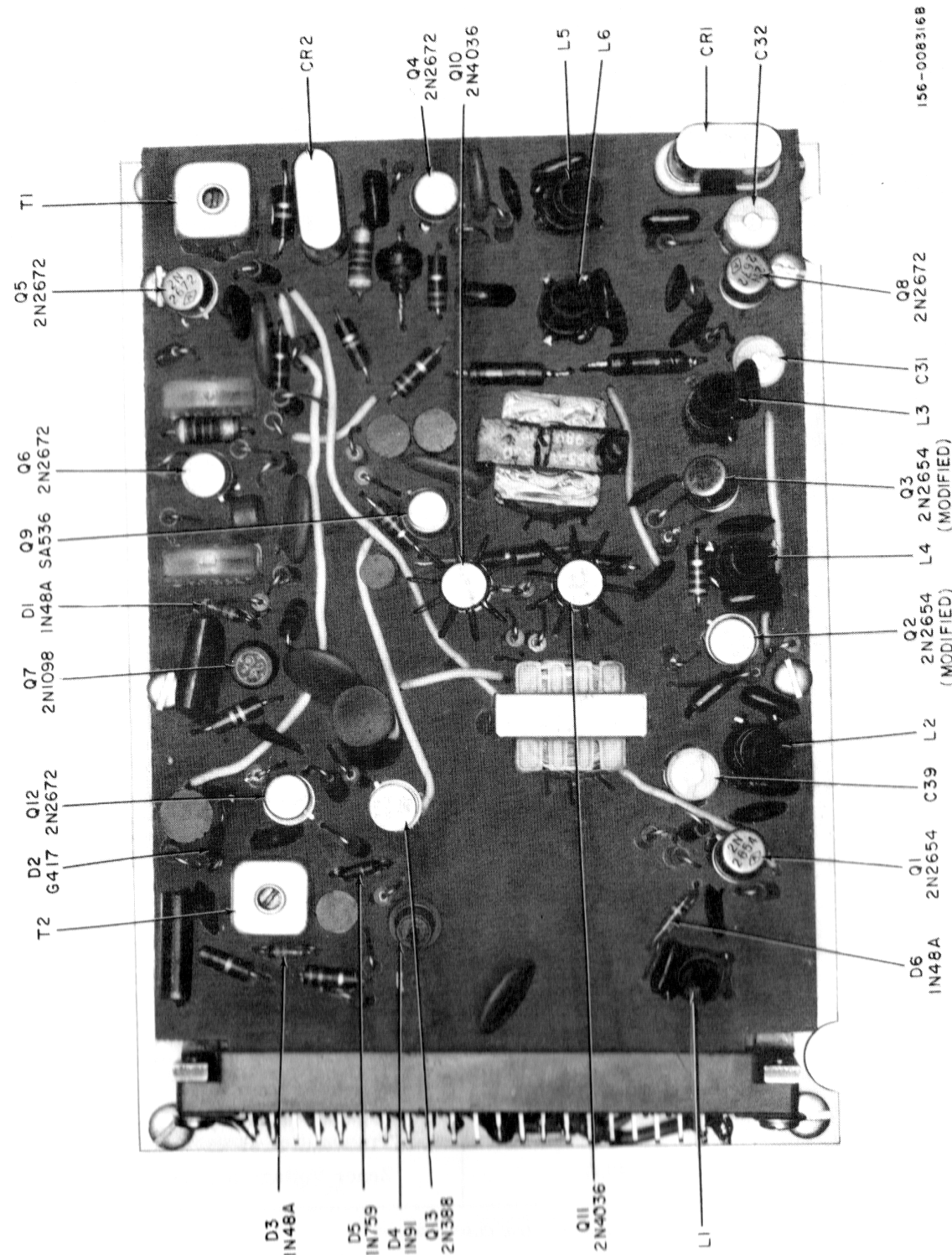

Figure 2. Transceiver Rear View, Crystal, Transistor and Adjustment Locations.

### 8. UNPACKING.

9. The equipment may be shipped in either export or domestic packing cases. In either event, no special unpacking procedures are necessary. When new equipment is received, select a location where the cases may be unpacked without exposure to the elements.

10. PRELIMINARY PROCEDURES. Complete the following steps to prepare equipment for use:

a. Remove cover and place beside unit. The retaining chain riveted to the cover and case prevents loss. The cover contains a microphone, earphone, spare fuses, and the power cord.

b. Identify and remove the four flat head screws in the front panel. Carefully slide unit out of case.

c. Inspect equipment for any possible damage incurred in shipment. Report any damage to responsible personnel immediately. **DO NOT ATTEMPT TO PLACE DAMAGED EQUIPMENT IN OPERATION.**

d. Refer to figure 2 and note location of receiver crystal CR1 on receiver printed circuit board. The frequency and letter 'R' stamped on the crystal case denotes channel frequency and receiver application. **DO NOT ATTEMPT TO USE CRYSTALS WITH OTHER MARKINGS, UNLESS CRYSTAL FREQUENCY AND MODE OF OPERATION ARE KNOWN.** The operating frequency of crystal CR1 is 10,455 megacycles below desired channel frequency. The proper frequency range of crystals is between 19,545 and 29,545 megacycles.

Example:

$$\begin{array}{r} 36,950 \text{ MC desired channel frequency} \\ -10,455 \text{ MC first intermediate frequency} \\ \hline 26,495 \text{ MC actual frequency of crystal CR1} \end{array}$$

The transceiver is normally shipped with receiver crystal CR1 installed and equipment pre-aligned to the channel frequency stamped on crystal case. In the event crystal CR1 is not installed or for the improper channel frequency, obtain the desired crystal and insert crystal firmly in socket. Refer to paragraph 16 of this section and complete alignment procedures.

e. Refer to figure 3 and note location of transmitter crystal CR301 in the transmitter section. The frequency and letter "T" stamped on the crystal case denotes channel frequency and transmitter application. **DO NOT ATTEMPT TO USE CRYSTALS WITH OTHER MARKINGS, UNLESS CRYSTAL FREQUENCY AND MODE OF OPERATION ARE KNOWN.** The equipment is normally shipped with crystal CR301 installed and pre-aligned for the channel frequency indicated on the crystal. In the event crystal CR301 is not installed, or of the improper channel frequency, obtain the proper crystal, install and complete alignment procedures of paragraph 17 of this section.

f. Place the ON-OFF VOLUME control and switch S101 in the OFF position, extreme counter-clockwise.

g. If equipment is suitable for operation, complete paragraph 18 of this section.

h. Refer to instructions covering the installation of Hallicrafters Model A-20A Antenna contained in this manual; install and adjust antenna.

### 11. ALIGNMENT PROCEDURES.

12. TEST EQUIPMENT. The following test equipment, in addition to the Model TS-20/35 Test Set, will be helpful in completing the alignment procedures.

a. Signal Generator, covering the 455 kilocycle to 40 megacycle frequency range.

b. Vacuum Tube Voltmeter or 20,000 ohm-per-volt Voltmeter with RF probe.

c. Wattmeter or indicating dummy load with power rating comparable with equipment output, Bird Model 611 or similar.

d. Frequency Meter or similar measuring equipment to determine operating frequency accurately.



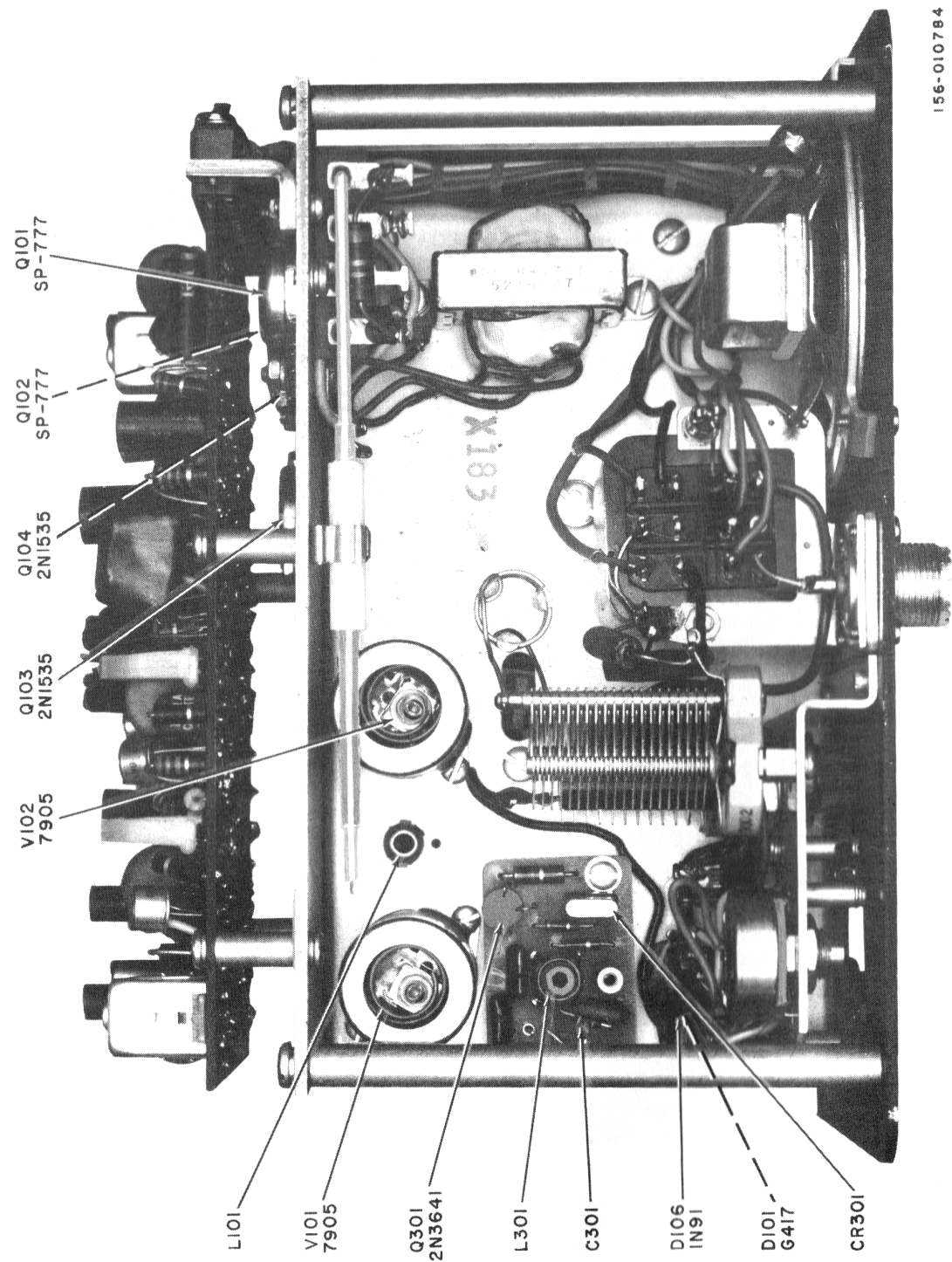

Figure 3. Transceiver Top View, Crystal, Transistor, Vacuum Tube and Adjustment Locations.

TABLE IV. TEST SET TS-20/35, SWITCH POSITIONING AND INDICATIONS.

Position	Test Function	Indication
1	Battery Voltage	Green
2	Not used in TR-5 testing	-
3	AGC Voltage	Note 1
4	Transmitter power amplifier grid current	Green
5	Transmitter power amplifier plate current	Green
6	Not used in TR-5 testing	-
7	Transmitter plate voltage	Green
8	Modulator current	Note 2

Notes

- In position three, correct reading will be in the upper red area with needle deflecting left with increase in AGC voltage, due to increase in signal strength.
- In position eight, normal reading will be to the extreme left in the red area, without modulation. Speaking into the microphone will deflect pointer to the green area on voice peaks.

TABLE V. TRANSCEIVER CONTROL FUNCTIONS.

Designation Reference	Item Name or Marking	Function
C115	P.A. TUNE	Tunes input circuit of pi-network to provide plate loading.
C116	ANT. LOAD	Tunes output of pi-network to provide efficient coupling to the antenna.
C31	First Converter Injection Level	Provides adjustment of first oscillator injection signal level to first converter stage.
C32	Receiver Oscillator Trimmer	Compensates for differences in crystal and circuit capacities in receiver first oscillator circuit and trims crystal to frequency.
C39	Spurious Frequency Trap Adjustment	Provides tunable component of spurious frequency trap circuit.
R101	VOLUME (ON-OFF) Control	Controls signal level applied to first audio amplifier stage controlling audio output level, p/o switch S101.
R102	SQUELCH Control	Controls threshold of operation of squelch circuit by controlling the bias of the Squelch DC amplifier.
S101	OFF-ON (VOLUME) Control	Controls application of power to the equipment, p/o control R101.

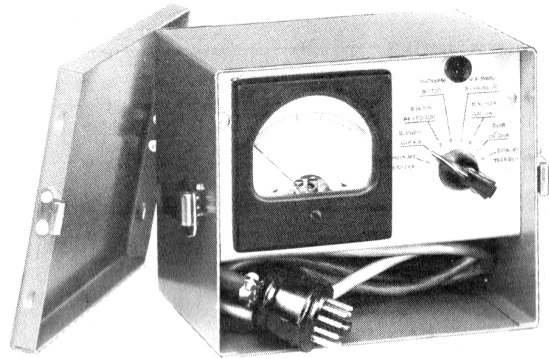

156-006667

Figure 4. Model TS-20/35 Test Set.

13. TEST SET TS-20/35. The Model TS-20/35 Test Set, shown in figure 4, is designed for use with communication equipment types TR-5, TR-20, TR-35, and HT-1. A 500 microampere meter with special scale markings, permits the check of circuits listed in Table IV by unskilled personnel. The circuits are checked by positioning the rotary selector switch and noting the position of meter pointer in relation to the color coded, segmented face. The special scale facilitates rapid checking without referring to a voltage and current chart.

**NOTE**

The green segment is a target area, an indication slightly into the red area does not necessarily indicate that the transceiver is not functioning properly. When a large variation from the green area occurs, the transceiver should be checked by a skilled technician.

14. LOCATION AND FUNCTION OF CONTROLS.

15. Table V lists the reference designation, item name or marking, and function of controls on the transceiver. Figures 2, 3, and 5 show their location.

16. RECEIVER ALIGNMENT. Complete the following steps to align receiver circuits:

a. Connect the RED (+) battery clip to the positive terminal of a 12 volt storage battery, and the BLACK (-) battery clip to the negative terminal.

b. Remove cover plate held in place by quarter-turn Dzus fastener and place aside. Refer to figure 5 and connect the TS-20/35 Test Set at TEST METER receptacle J103.

c. Place the eight position selector switch on test set in the number one position (Battery Voltage).

d. Place the ON-OFF VOLUME control and switch in the ON position by turning knob in clockwise direction. Test set meter should indicate presence of voltage, reading in the green target area.

e. Place the ON-OFF VOLUME control (S101-R101) and SQUELCH control (R102) in their extreme clockwise position.

f. Connect a signal generator to the ANT receptacle J102 on the front panel. Tune generator to channel frequency of crystal CR1, and apply a low level, modulated RF signal.

g. Using an insulated alignment tool, adjust first oscillator coil L3, for audible output of the modulated signal at the speaker. Refer to figure 2.

h. Using an insulated alignment tool, adjust RF input transformer L1 and first converter transformer L2 for maximum audible output at the speaker. Refer to figure 2.

**NOTE**

Under normal circumstances the slugs of L1 and L2 will have two possible operating points: One when the slug is above the winding, and the other when the slug is below the winding. The proper point is that which provides maximum coupling between windings.

i. In the event there is no audible signal present or the signal stops abruptly during adjustment, re-adjust oscillator coil L3 and coils L1 and L2 alternately until maximum output is obtained.

j. Note location of capacitor C32, crystal trimmer. Capacitor C32 is used to pull crystal slightly for netting or adjustment to exact frequency.

k. Adjust oscillator injection level, capacitor C31. Adjust capacitor C31 for the minimum amount of injection required for stable operation by noting audible output indication at the speaker.

l. Repeat steps g through k to obtain optimum performance and stability at the desired frequency.

m. Note the location of spurious rejection trimmer, capacitor C39. Using the formula:

$$f_d = f_{lo} + f_{if}$$

$$f_s = 2f_{lo} - f_{if}$$

$$f_{lo} = f_d - f_{if}$$

$$f_s = 2(f_d - f_{if}) - f_{if} = 2f_d - 3f_{if}$$

where:

$f_s$  = frequency of spurious signal

$f_d$  = frequency of desired signal

$f_{lo}$  = frequency of first oscillator

$f_{if}$  = frequency of first IF (10.455 MC)

Calculate the frequency of any spurious signals falling in the receiver passband. Set generator to calculated frequency and inject a low level, modulated RF signal at the receiver input. Adjust capacitor C39 to reduce the audible output below audible level.

n. Place the selector switch on Test Set in the number three position (AGC Voltage).

**CAUTION**

The TS-20/35 Test Set contains a sensitive meter, use care in alignment and measuring to prevent overload damage.

o. Repeat alignment procedures, steps g through k, with signal generator set to channel frequency, output reduced to minimum, and align for minimum meter reading on the test set (left deflection, disregarding scale markings).

p. RF transformers tuned to 10,455 kilocycles (10.455 MC), L4, L5, and L6 and 455 kilocycle IF transformers T1 and T2 are not adjusted when changing channel frequency. In the event difficulties are encountered, refer to alignment procedures after repair or part replacement in paragraphs 47 and 48 of Section V in this manual.

q. Rotate SQUELCH control R102 in a counter-clockwise direction until receiver mutes. With the RF signal generator set to channel frequency, proper squelch setting is attained when a signal level of 2 microvolts will break the squelch. Refer to figure 5. In the event difficulties are encountered, or after repairs or parts replacement have been made, refer to paragraph 49 of Section V for detailed alignment procedures.

r. Disconnect signal generator from ANT receptacle J102 and connect antenna lead. RF input transformer L1 may be adjusted for optimum signal-to-noise ratio by adjustment to an actual or simulated signal.

**NOTE**

When tuning coil L1 for optimum signal-to-noise ratio using a weak or simulated signal, it may be necessary to open squelch by rotating SQUELCH control R102 clockwise. Return control to previously determined setting.

s. Operate the transmitter by pressing push-to-talk button on the microphone momentarily and release button. Receiver should return to operation immediately indicating correct oscillator starting. Observe caution applicable to UNTUNED transmitter.

**CAUTION**

Do not operate transmitter for more than 30 seconds under the following conditions: Crystal CR101 removed from socket, zero grid bias, inoperative oscillator, without a suitable antenna load, or the power amplifier severely detuned.

17. TRANSMITTER ALIGNMENT. Complete the following steps to prepare the transmitter for use:

**WARNING**

Voltages present in the transmitter section are dangerous if contacted while grounded.

a. Connect a suitable indicating dummy load or wattmeter to ANT receptacle J102.

b. Connect VTVM to pin 2 of V101.

c. Depress push-to-talk button to operate transmitter and adjust coil L301 for maximum DC negative voltage indication on VTVM.



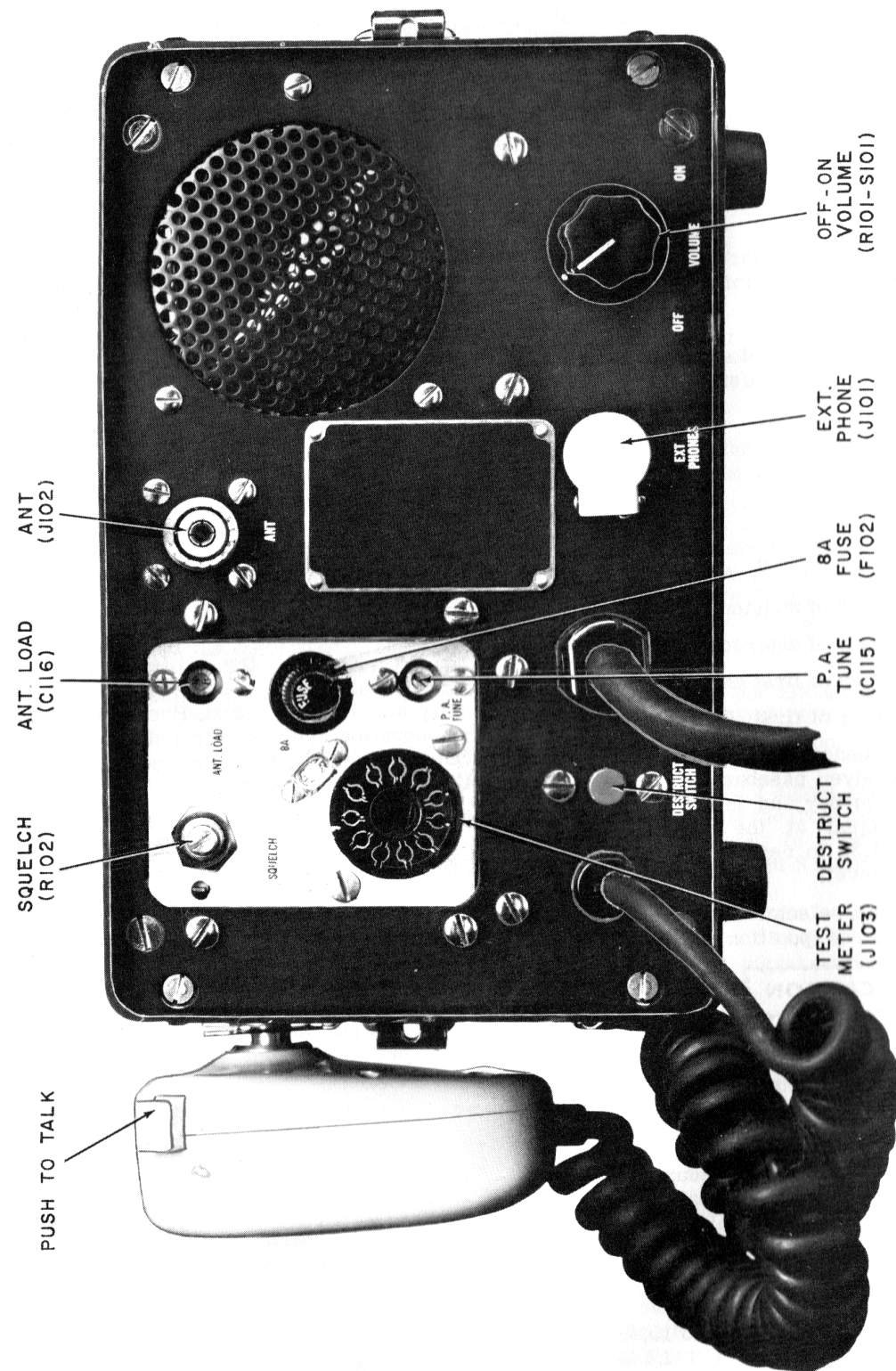

156-006459

Figure 5. Hamlet Radio Transceiver, Control Locations.

d. Place test set selector switch in the number four position (Transmitter Power Amplifier Grid Current).

e. Depress push-to-talk button to operate transmitter and adjust coil L101 (slug nearest chassis) for maximum indication on test set meter.

f. Operate transmitter and adjust coil L101 (slug farthest from chassis) for maximum reading on test set meter.

g. Repeat steps c, d, e, and f until no further increase is obtained.

h. Place test set selector switch in the number five position (Transmitter Power Amplifier Plate Current).

i. Operate transmitter and adjust P.A. TUNE capacitor C115 for resonance, indicated by a dip in the meter reading of the test set. Adjust ANT. LOAD capacitor C116 for maximum meter indication, maintaining the meter reading in the green area. Adjust capacitors C115 and C116 alternately until maximum indication is obtained with a perceptible dip at resonance on the test set meter. The indicating dummy load or wattmeter will indicate maximum output at this point; release push-to-talk button.

j. Place test set selector switch in number four position (Transmitter Power Amplifier Grid Current).

k. Operate transmitter and repeat steps e and f, checking transmitter power amplifier grid current.

l. Place ON-OFF VOLUME control in extreme counterclockwise.

m. Disconnect power cord from power source and complete installation procedures of paragraph 18.

18. INSTALLATION. Complete the following steps to complete installation procedures:

a. Carefully slide unit into case and secure in place with the four flat head screws removed in paragraph 16. Replace cover over TEST METER receptacle, insert fuse, and pre-set SQUELCH and tuning controls by turning quarter-turn fastener.

b. Place microphone in holder at side of case.

c. Connect coaxial connector from antenna lead to ANT receptacle J102.

d. Connect power cable to power source, note polarity marking RED (+) to positive terminal, BLACK (-) to negative terminal.

## SECTION IV OPERATION

19. **GENERAL.** The Hamlet Radio Transceiver, together with the Model A-20A Antenna, is assumed to be installed and adjusted in accordance with the previous instructions contained in this manual.

20. **STARTING.** Place the equipment in operation by rotating ON-OFF VOLUME control and switch (R101-S101) in a clockwise direction.

21. **OPERATION.**

22. **RECEIVER.** The receiver is operative when power is applied and requires only adjustment of VOLUME control to a suitable level. The SQUELCH control does not require adjustment under normal operating conditions. In the event extremely weak signals are encountered, the SQUELCH control may be adjusted to permit reception.

23. **TRANSMITTER.** The transmitter operates when push-to-talk button on microphone is pressed. Antenna change-over, receiver muting, and application of power are accomplished by relay

sequence. Speak into the microphone clearly and distinctly to modulate carrier to maximum output. It is not necessary to shout or speak in excessively loud tones to modulate carrier to maximum. The equipment design prevents over modulation when excessively loud speech is encountered, but may cause a slight amount of distortion due to clipping action of the circuitry.

24. The receiver returns to operation immediately upon release of push-to-talk button on the microphone.

25. The equipment is shut off when ON-OFF VOLUME control and switch is rotated to the extreme counter-clockwise position.

26. **OPERATION CHECKS.** The equipment requires no operating checks during or before operation. When operating checks are desired, refer to the instructions covering the Model TS-20/35 Test Set designed for use with Radio Industries communication equipment, paragraph 13 and Table IV.

## SECTION V PREVENTIVE AND CORRECTIVE MAINTENANCE

27. **INTRODUCTION.**

28. The successful and rapid application of preventive and corrective maintenance procedures requires a thorough understanding of the theory of operation for the Hamlet Radio Transceiver. The following paragraphs must be studied carefully before preventive or corrective maintenance procedures are attempted.

29. **THEORY OF OPERATION.**

30. The transceiver consists of a transmitter and receiver in one compact unit with dual purpose audio circuits and a DC-to-DC power converter.

31. **BLOCK DIAGRAM.** The signal path through the transceiver and control circuits is shown in the over-all block diagram of figure 6. Paragraph 32 covers the signal path through receiver circuits; paragraph 33 covers the signal path through the common audio circuits; paragraph 34 covers the signal path through transmitter circuits; paragraph 35 covers the operation of the DC to DC power converter, and paragraph 36 covers the control circuits. For circuit

details refer to the over-all schematic diagram shown in figure 10.

32. **RECEIVER CIRCUITS.** The operation of receiver circuits is covered, in order of signal flow, in the following sub-paragraphs:

a. **RF Amplifier Q1.** A type 2N2654 PNP transistor, in common emitter configuration, amplifies the incoming signal developed across transformer L1. The received signal is coupled from ANT. receptacle J102 through section (A) of de-energized relay RLY101 to coil L1 in receiver section. Stage gain is controlled by the application of automatic gain control (AGC) voltage to the base circuit. The output voltage is developed across transformer L2 and coupled to the first converter stage. Diode D6 protects transistor Q1 from strong RF signals.

b. **First Converter Q2.** A type 2N2654 (modified) PNP transistor, in common emitter configuration, combines the incoming signal coupled through transformer L2 and the first oscillator injection signal in the base circuit by heterodyne action. Heterodyning produces the first inter-

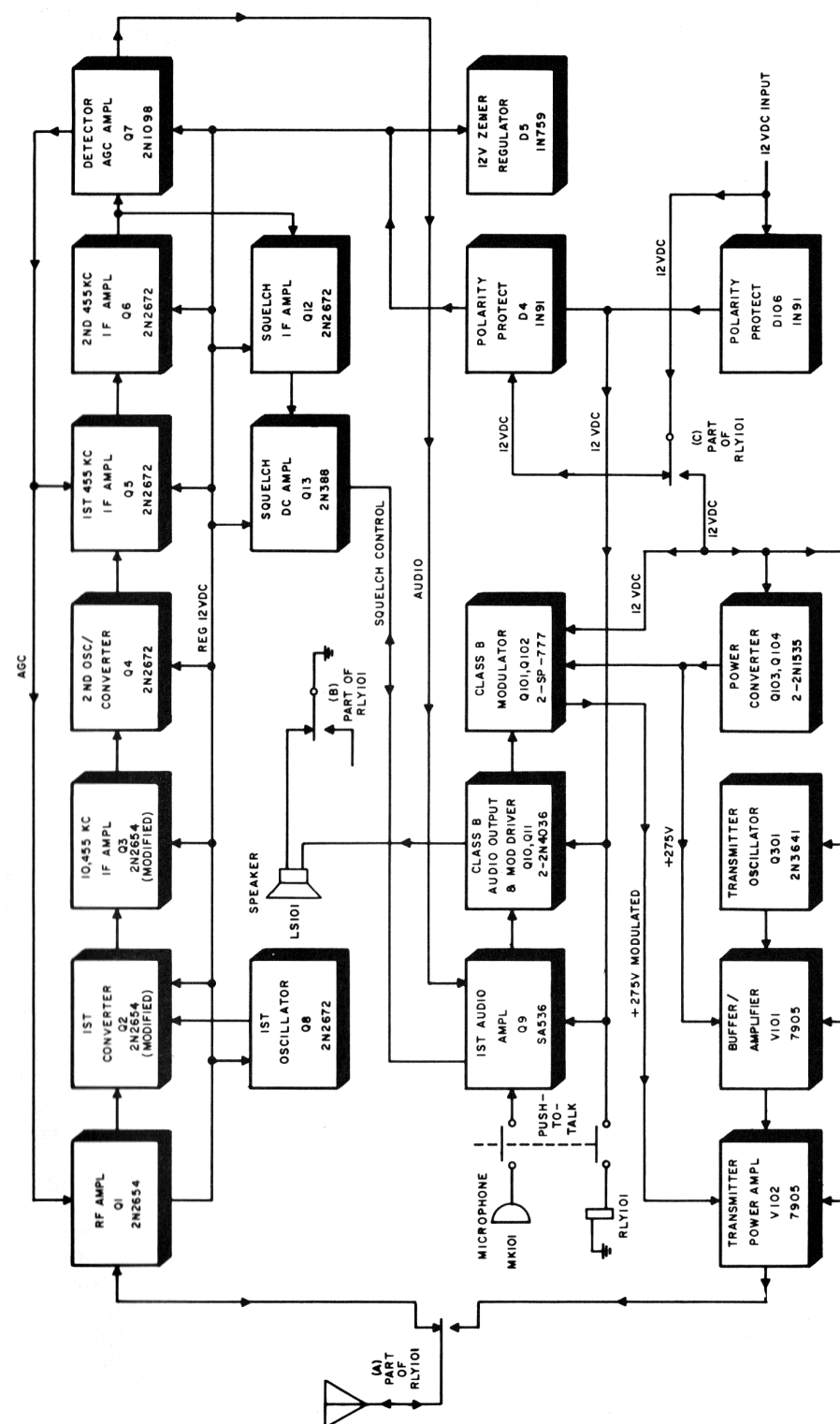

Figure 6. Hamlet Radio Transceiver, Block Diagram.



mediate frequency of 10,455 kilocycles (10.455 MC) developed across transformer L4 and is coupled to the 10,455 kilocycle (10.455 MC) IF amplifier stage. The combining action produces spurious frequencies which through harmonic relationship fall within the frequency range of the receiver. This frequency or spurious frequency must be eliminated to improve receiver characteristics. Variable capacitor C39 and radio frequency choke RFC1 perform the function of eliminating the undesired spurious frequency. The spurious frequency which must be eliminated is determined by the following formula:

$$\begin{aligned} f_d &= f_{10} + f_{if} \\ f_s &= 2f_{10} - f_{if} \\ f_s &= 2(f_d - f_{if}) - f_{if} = 2f_d - 3f_{if} \end{aligned}$$

where:

$$\begin{aligned} f_s &= \text{frequency of spurious signal} \\ f_d &= \text{frequency of desired signal} \\ f_{10} &= \text{frequency of first oscillator} \\ f_{if} &= \text{frequency of first IF 10,455 kilocycles (10.455 MC)} \end{aligned}$$

When C39 and RFC1 are tuned to series resonance the circuit presents a low impedance path to ground for the spurious frequency and reduces or eliminates the spurious signal.

c. First Oscillator Q8. A type 2N2672 PNP transistor, in common emitter configuration, develops the injection signal for the first converter stage. Frequency of oscillation is controlled by crystal CR1 and series trimmer capacitor C32 between collector and base to provide a feedback path for sustained oscillation. The oscillator operates 10,455 kilocycles (10.455 MC) below the desired channel frequency. The collector circuit is tuned by a parallel tuned circuit, consisting of capacitor C34 and coil L3. Variable capacitor C31 controls the amount of signal coupled from the output of Q8 to the base circuit of the first converter stage.

d. IF Amplifier 10,455 kilocycle Q3. A type 2N2654 (modified) PNP transistor, in common emitter configuration, amplifies the 10,455 kilocycle signal applied through transformer L4. The output is developed across transformer L5. Transformer L5 is the input circuit of a high-Q selective bandpass coupler at 10,455 kilocycles. Coupling to the output transformer L6 of the bandpass coupler is accomplished by mutual inductance. The signal developed across transformer L6 is applied to the second oscillator/converter stage.

e. Second Oscillator/Converter Q4. A type 2N2672 PNP transistor, operating in a common emitter configuration, provides the dual purpose circuitry effecting autodyne conversion. The 10,455 kilocycle signal developed across bandpass coupler transformer L6 is applied to the base circuit of transistor Q4. The oscillator circuit is completed by the feedback path from collector to base through crystal CR2. The oscillator operating at 10,000 kilocycles combines with the incoming signal to produce the difference frequency of 455 kilocycles across IF transformer T1 in the collector circuit. Radio frequency choke RFC2 prevents the 10,000 kilocycle oscillator frequency from appearing in the output circuit by presenting a high impedance path, at 10,000 kilocycles and a low impedance path to the 455 kilocycle signal.

f. First 455 KC IF Amplifier Q5. A type 2N2672 PNP transistor, operating in common emitter configuration, amplifies the signal applied to the base circuit through IF transformer T1. The output is developed across collector load resistor R21 and coupled to the following stage through 455 KC ceramic filter element FL1. The base circuit of transistor Q5 is controlled by the application of an AGC voltage to control stage gain with varying signal levels. The emitter circuit provides a convenient method of measuring the AGC voltage across resistor R18 and through series resistor R17. The measurement points are terminated at TEST METER receptacle J103 pins 7 and 8.

g. Second 455 KC IF Amplifier Q6. A type 2N2672 PNP transistor, operating in common emitter configuration, amplifies the 455 KC signal coupled through 455 KC ceramic filter element FL1. The emitter circuit of transistor Q6 is by-passed at the operating frequency by ceramic filter FL3. The effects of bypassing are increased gain at the operating frequency, with a resultant narrowing of the pass-band. The amplified output is developed across collector load resistor R25 and coupled to the Detector - AGC Amplifier stage through 455 KC ceramic filter element FL2.

h. Detector-AGC Amplifier Q7. A type 2N1098 PNP transistor, operating in common emitter configuration, performs the dual function of detection and the amplification of automatic gain control (AGC) voltage. Functioning as a Class B detector biased in the non-linear portion of the curve, rectification takes place across the base-emitter junction. The audio output voltage is developed across resistor R32, in the collector circuit and by-passed by capacitor C23, removing the 455 KC component. AGC amplification is the result of amplifying the audio output and conduction of diode D2. Diode D2 conducts when re-

verse bias of the diode applied through resistor R55 and series resistor R56 is exceeded. The developed AGC voltage is applied across the capacitor C19 to establish the proper delay characteristic. The AGC voltage is applied to RF amplifier Q1 and first 455 KC IF amplifier stages as a control bias. Diode D1 provides noise limiting action to clip high level noise pulses, the threshold of operation is established by the time constant of capacitor C22 and the fixed bias applied through resistor R31 derived from the emitter current flowing across resistor R28. Capacitor C24 by-passes the emitter circuit for the RF frequency.

i. Squelch IF Amplifier Q12. A type 2N2672 PNP transistor in a common emitter configuration, receiving a portion of the signal applied to the base of transistor Q7, amplifies the 455 KC IF signal. The output developed across IF transformer T2 is coupled to the squelch rectifier, diode D3. Diode D3 conducts on negative half cycles of the signal and applies a negative going voltage to the base of squelch DC amplifier, Q13. The filter network consisting of capacitor C38 and resistor R50 removes undesired RF components of the signal.

j. Squelch DC Amplifier Q13. A type 2N388 NPN germanium transistor, operating in common emitter configuration, functions as a DC amplifier, switching circuit. The bias of transistor Q13 is adjusted by SQUELCH control R102 to a point just sufficient to "turn on" the transistor (permitting collector current to flow), with the absence of a signal. When transistor Q13 is "on" or conducting, collector current is derived from the emitter of first audio amplifier, Q9. The increased current flow at the emitter circuit of Q9 squelches the audio by turning transistor Q9 off. With the presence of a signal, the base of transistor Q13 is biased by a negative going voltage and effectively "turns off" the squelch DC amplifier. When transistor Q13 "turns off", its collector current derived through the emitter circuit of first audio amplifier, Q9 returns to zero. The first audio amplifier stage operates in a normal manner and develops an output signal.

33. AUDIO CIRCUITS. The dual purpose audio circuits and their operation, under receive and transmit conditions, are covered in the following sub-paragraphs:

#### a. RECEIVE.

1. First Audio Amplifier Q9. A type SA536 PNP transistor in common emitter

configuration, amplifies the detected audio signal to the level required to drive the Class B audio output and modulator driver stage. The input signal is developed across VOLUME control R101, and is coupled to the base through capacitor C28. The stage is biased for Class A operation by resistors R37 and R40 in the base and emitter circuits respectively. The junction of resistor R40 and the emitter lead of transistor Q9 is returned to the collector of squelch DC amplifier, Q13 to control the first audio amplifier by "turn on" and "turn off" providing squelch function. When transistor Q13 is conducting, during the absence of a signal, the current flow through resistor R40 effectively biases Q9 to cut-off and squelches the audio output. When transistor Q13 is not conducting, a signal is present and the emitter current is returned to its normal state permitting transistor Q9 to amplify and develop an audio output signal. The output signal is developed across interstage audio transformer T3 and is coupled to the output and driver stage. Resistor R36 provides the feedback path from the output circuit of the Class B audio output and modulator driver stage to the base of transistor Q9. The feedback provides an equal response characteristic for the audio circuit.

2. Class B Audio Output and Modulator Driver Q10 and Q11. A matched pair of type 2N4036 PNP transistors, operating in a push-pull, common emitter configuration, amplifies the audio signal to the required output level. The input signal is coupled to the base circuits and is biased by resistor R42. Resistor R43 provides a small amount of forward bias to prevent severe cross-over distortion. The output signal is developed across interstage driver transformer T4. Feedback from the output circuit is applied to the first audio amplifier stage through resistor R36. The primary winding is tapped to provide an output to loudspeaker LS101. The secondary winding couples the output to the modulator stage which is reverse biased in the receive condition. This reverse bias presents a high impedance to the secondary winding of T4 of such a magnitude that the transformer is essentially open circuited.

#### b. TRANSMIT.

1. First Audio Amplifier Q9. A type SA536 PNP transistor, operating in a common emitter configuration, amplifies the audio signal delivered by the microphone to the base of transistor Q9 through capacitor C28, to a level suitable to drive the

following stage. Transistor Q9, biased for Class A operation, develops the output signal across interstage audio transformer T3. Emitter bias is fixed and is not affected by squelch DC amplifier due to removal of operating voltage to receiver circuits. The operating voltage for the microphone pre-amplifier is supplied from the junction of resistors R40 and R41 and by-passed by capacitor C29. Resistor R36 provides the feedback path from the output circuit of the Class B audio output and modulator driver stage to the base of transistor Q9. The feedback provides an equal response characteristic for the audio circuit.

2. Class B Audio Output and Modulator Driver Q10 and Q11. A matched pair of type 2N3046 PNP transistors, operating in a push-pull common emitter configuration, amplifies the signal coupled through transformer T3 and drives the Class B modulator stage. The audio output signal is developed across interstage driver transformer T4 and coupled to the modulator input. Feedback from the output circuit is applied to the first audio amplifier stage through resistor R36. Contacts of relay RLY101 open the audio output circuit through loudspeaker LS101 and PHONES jack J10.

3. Class B Modulator Q101 and Q102. Two type SP-777 PNP power transistors, operating in common emitter configuration, develop the modulating signal. The input signal is coupled to the base circuits through transformer T4. Polarity protect diode D106 provides a small amount of forward bias to eliminate cross-over distortion. Resistor R111 in the emitter circuit and the forward bias established by diode D106 provide the stabilizing element. The output signal is developed across modulation transformer T101 and is coupled to the secondary winding to provide high level modulation of the transmitter power amplifier. Resistor R114 terminated at pin 10 of TEST METER receptacle J103 provides the measurement point for modulator current. Resistor R110 provides measuring points for transmitter power amplifier plate current and high voltage, at pins 3 and 4 of TEST METER receptacle J103, respectively.

34. TRANSMITTER CIRCUITS. The operation of transmitter circuits, in order of signal flow, is covered in the following sub-paragraphs:

a. Transmitter Oscillator Q301. The transmitter oscillator utilizes a type 2N3641 NPN transistor in a common emitter configuration, crystal-controlled oscillator circuit. The carrier is developed across the tank circuit consisting of coil L301 and capacitors C303 and C304. The output is coupled through capacitor C302 to the grid of buffer/amplifier V101.

b. Buffer/Amplifier V101. The buffer/amplifier utilizes a type 7905 tube of the instant-heating filament type. Filament voltage is supplied through the series connected filament of tube V102 from the 12 volt DC input when in transmit condition. The signal applied to the grid is amplified to the level required to drive the transmitter power amplifier. The output is coupled to the transmitter power amplifier through L101.

c. Transmitter Power Amplifier V102. The transmitter power amplifier stage employs a type 7905 tube. The RF signal developed across the secondary of transformer L101 and capacitor C108 is coupled through capacitor C109 to the grid circuit. Bias for the grid circuit is developed by the signal applied across resistors R107 and R108. The junction between resistors R107 and R108 provides a measuring point for the transmitter power amplifier grid current and is terminated at TEST METER receptacle J103, pin 1. Capacitors C110 and C112 provide RF bypassing for the filament circuit, while capacitor C111 provides bypassing for the screen circuit. The suppressor grid is connected directly to ground to prevent secondary emission from the plate. The output circuit is coupled to the plate through parasitic suppressor PS101 and capacitor C114. The B+ voltage supply is applied to the plate circuit through radio frequency choke RFC101 and parasitic suppressor PS101. The screen is supplied B+ voltage through resistor R109. The output signal is developed across the pi-network comprised of input capacitor C115 (P.A. TUNE), coil L102, and output capacitor C116 (ANT. LOAD). Capacitor C117 paralleling the output capacitor provides a fixed pad to broaden the output tuning range. Radio frequency choke RFC102 provides bypassing of excessive currents. The output is coupled to contacts of relay RLY101 and applied to the antenna receptacle when relay RLY101 is energized. Transmitter power amplifier plate current and high voltage are measured across resistor R110 at TEST METER receptacle J103, pins 3 and 4, respectively. The filament voltage through V102 is supplied from the 12 volt DC input line when in transmit condition.

35. POWER CONVERTER Q103 AND Q104. Two type 2N1535 PNP power transistors form a DC to DC power conversion circuit. A high efficiency toroid transformer with multiple primary windings provides the oscillating circuit. Resistors R112 and R113 provide a starting bias for the base circuits of transistors Q103 and Q104. Application of power to the circuit results in a current flow through one half of the emitter winding and through the emitter circuit of the conducting transistor. The resultant current flow induces a voltage into the winding terminated at the base circuits of the transistors, and due to phase reversal, biases the conducting transistor to maximum conduction and the non-conducting transistor to maximum cut-off. The conducting transistor conducts until the saturation point is reached or the saturation point of the core is reached and the conducting transistor ceases to conduct. When the transistor that was conducting saturates and stops conducting, the current which was flowing starts to return to zero and induces a voltage in the reverse direction. The voltage induced by the reverse current flow in attempting to return to zero biases the non-conducting transistor into conduction and the saturated transistor to the maximum cut-off point, completing the cycle. The continuous oscillation started by the current flow continues to alternate until power is removed from the circuit. The output waveform appearing across the secondary winding by induction is stepped up by transformer action to the required high voltage level. The square-wave output of the secondary winding is rectified by a full-wave bridge rectifier circuit consisting of silicon diodes, D102 through D105, type U214. Capacitor C118 is essentially a tuning element for the secondary winding to prevent the generation of undesirable spurious frequencies. Capacitor C119 provides the filtering for the rectified DC output.

36. CONTROL CIRCUITS. The control circuits are completed by relay RLY101 through three sets of form C contacts, providing antenna transfer, audio muting, and transfer of DC power. The following sub-paragraphs cover the con- ductions under receive and transmit functions:

a. Receive. Relay RLY101 de-energized, section (A) connects antenna circuits of receiver section to ANT receptacle J102. Section (B) completes the audio through loudspeaker and/or PHONES jack J101 to ground. Section (C) of relay RLY101 applies 12 volt DC power to receiver circuits, with regulation provided by Zener diode D5, type 1N759 and through polarity protect diode D4, type 1N91.

b. Transmit. Relay RLY101 is energized, when push-to-talk button on microphone is pressed by completing the circuit through the relay coil to ground. Diode D101, Type G417, provides the by-passing element for transient spikes developed across relay coil when keyed and released. Section (A) transfers the antenna to transmitter output circuits, section (B) opens the audio output circuit through loudspeaker and/or PHONES jack J101, while section (C) transfers 12 volt DC power from the receiver circuits to the power converter circuit, the Class B modulator circuit, and the filaments of tubes V101 and V102. The first audio amplifier and the Class B audio output and modulator driver are supplied DC power under both conditions directly from input power circuits.

37. CORRECTIVE MAINTENANCE.

38. General. Corrective maintenance involves two basic procedures, localization of trouble and isolation. Localization means tracing the trouble to the circuit responsible for abnormal operation. Isolation means tracing the trouble to the defective component. Quite frequently, the source of trouble can be localized by the inspection of components and wiring.

39. TROUBLE SHOOTING.

40. TROUBLE LOCALIZATION. The localization of trouble is most easily accomplished by performing the alignment procedures of Section III and Section V, and noting the results or indications for comparison with the normal condition. This will frequently localize the trouble.



Care must be exercised in the use of an ohmmeter in the testing of transistorized equipment. The application of test leads between emitter and base may destroy the transistor if meter is set to the improper range. The current flow due to the internal battery within the ohmmeter may exceed the rating of the transistor under test. Know your test equipment polarities, voltage, and current drain on the various ranges before measurements are attempted.



41. TROUBLE ISOLATION. The isolation of trouble to the defective part is most easily accomplished by the use of a vacuum tube tester and a vacuum tube voltmeter or volt-ohmmeter. This equipment, in conjunction with the voltage chart, Table VI, facilitates rapid determination of the component at fault. During the process of isolation continuous reference must be made to the schematic diagram figure 10, to determine circuit configuration. Normal trouble shooting procedures may be applied to the vacuum tube circuits of the transmitter section to isolate any

possible trouble. The following sub-paragraphs cover basic tests for transistor circuits which may be performed in the isolation process:

a. Circuit Operation Checks. The circuit under question may be checked by voltage measurements based on Table VI. The transistor circuits of this equipment utilizes PNP transistors in all functions with the exception of the Squelch DC Amplifier Circuit, which uses an NPN type. The voltages on all elements of the transistors will be positive with respect to ground in all

cases except on the NPN stage. Voltages measured between the base and emitter circuits should reflect approximately .1 to .2 volt difference. No voltage, base to emitter, indicates possible transistor failure.

b. Operational Current Checks. Stage current is determined by measuring the voltage drop across either a resistor in the emitter or collector circuits. Calculating by Ohms Law  $E/R = I$ , to determine the current flowing. The current should not be below 0.5 milliamperes or above 3.0 milliamperes in low level stages. In the event calculated current does not fall within the range given, the resistance value across which the measurement was made should be checked, and other resistances in the circuit checked, before the transistor is replaced. This method is applicable to all circuits of the common configuration whether they are amplifiers, oscillators, or converters. In checking high level push-pull stages it is desirable to use separate resistors in the emitter circuits to determine the balance of current through the two transistors, to insure equal gain and current flow during operation.

c. Transistor Current Gain Check. A rapid check of the transistors ability to control current flow is made by shorting the base to the emitter while measuring the voltage drop across a resistor in either the emitter or collector circuit. When the base is shorted to the emitter the transistor will be cut-off and the voltage across the resistor will be nearly zero. Failure of the transistor to cut-off, thus permitting current to flow, indicates that the transistor is defective and should be replaced.

d. Oscillator Check. Transistor oscillator circuits in the receiver may be checked by either of two methods which follow:

1. Check for the presence of oscillation by using an RF probe with a sensitive vacuum tube voltmeter or volt-ohmmeter connected to the collector circuit.

2. Current measured with the circuit operating versus the current measured with the oscillator inoperative. Measure the voltage drop across the emitter resistor during normal operation. A typical voltage drop could be 0.4 volt. With the oscillator inoperative, by removing the crystal or shorting out the feedback path, the typical voltage drop would nearly double in value.

orthodox and should be obvious to personnel who are generally familiar with electronic equipment. Before replacing any part, refer to Section VI of this manual and select only that part which is an exact replacement. Refer to figures 7 through 9 for component part locations.

44. PRINTED CIRCUIT BOARD REMOVAL AND REPAIR. In the event repair or replacement of the printed circuit board is necessary the board is easily removed. Remove the four screws holding the board in place and remove board by pulling straight out from connector J104 to disengage the board from connector. Parts replacement may now be easily accomplished and the board replaced in the reverse manner. When replacing or removing components from the printed circuit board, care should be exercised to prevent excessive heat damage to the board and copper laminate.

45. ALIGNMENT AFTER REPAIRS.

46. General. After repairs or replacement parts are installed in the equipment, consideration should be given to the circuit or circuits that may be affected. When indicated, perform the applicable portion of alignment procedures given in Section III of this manual or those that follow in the subsequent paragraphs.

47. ALIGNMENT OF 10,455 KC IF AMPLIFIER. With the equipment aligned and operating in accordance with the procedures given in paragraph 16 of Section III, complete the following steps to align the remaining circuits for optimum operation:

a. Using a small loop, couple a 10,455 kilocycle signal from the signal generator to transformer L4 (see figure 2). Adjust the output of signal generator to approximately 10 millivolts and apply an RF carrier with tone modulation.

b. Using an insulated alignment tool adjust transformer L4 (see figure 2) for the maximum audio output audible at the speaker, or the minimum meter deflection on test set, set to the number three position, AGC Voltage.

c. Using an insulated alignment tool adjust the bandpass coupler transformers L5 and L6 alternately for maximum audio output at the speaker or minimum test set reading under the same conditions as in preceding step b.

d. Disconnect signal generator and proceed with the required procedures of paragraph 48 or those of paragraph 16, Section III.

TABLE VI. TYPICAL VOLTAGE AND CURRENT MEASUREMENTS.

NOTE

The voltage measurements listed below were made with a vacuum tube voltmeter with an input voltage of 12.6 VDC. As readings may vary slightly from one unit to another they should be considered as approximate values. Measurements made with TS-20/35 Test Set disconnected.

Measurement	Point of Measurement (to ground unless otherwise specified)	Voltage Readings
Transmitter Oscillator Collector voltage		7.5 volts DC
High voltage with transceiver in transmit mode, operating, loaded to 4 watts output	C119	305 volts DC
Buffer Amplifier plate voltage	Pin 6, V101	280 volts DC
Buffer Amplifier screen voltage	Pins 3, 7 and 8, V101	125 volts DC
Transmitter power amplifier plate voltage	Pin 6, V102	285 volts DC
Buffer Amplifier filament voltage	Pin 9, V101	6.3 volts DC
Transmitter power amplifier filament voltage	Pin 9, V102	12.6 volts DC
Transmitter power amplifier screen voltage	Pins 3, 7 and 8, V102	140 volts DC
Transmitter power amplifier grid voltage	Junction of R107 and R108 (J103-1)	-0.25 volts DC
Squelch rectifier voltage	Anode of diode D3	4.2 volts DC
Check all transistors for forward biasing. No voltage, base to emitter, indicates possible transistor failure	Base to emitter	0.2 volt DC (approx.)
CURRENT MEASUREMENTS		
Receiver, No Signal		30 milliamperes
Receiver, Average Signal		60 milliamperes
Transmitter, 4 watts output, Carrier only		3 amperes
Transmitter, 4 watts output, Average modulation		4 amperes

42. PARTS REPLACEMENT AND ALIGNMENT.

43. General. With the exception of the printed circuit board assembly, replacement of component parts in the transceiver is completely

48. ALIGNMENT OF FIRST 455 KC IF AMPLIFIER INPUT. With the equipment operating and aligned under the conditions specified in preceding paragraph 47 and paragraph 16 of Section III, complete the following steps to align IF input circuit:

a. Connect the signal generator to the collector circuit of Second Oscillator/Converter stage, and apply a tone modulated RF carrier of 455 kilocycles. The signal generator must be isolated by a DC blocking capacitor from the collector circuit of this stage.

b. Using an insulated alignment tool, adjust transformer T1 for maximum audio output at the speaker, or minimum deflection of the Test Set meter, in the AGC Voltage position.

c. Disconnect signal generator and proceed with alignment procedures of Section III or those which follow in paragraph 49, when applicable.

49. ALIGNMENT OF SQUELCH IF AMPLIFIER AND SQUELCH DC AMPLIFIER. The following steps complete the alignment procedures. Operating conditions for the equipment and alignment procedures of the preceding paragraphs and those of paragraph 16, Section III must be completed before proceeding. The alignment of the squelch circuit is the last alignment procedure; proceed as follows:

a. Connect the signal generator to the ANT receptacle J102 and set generator to channel frequency. Set generator output to the 2 microvolt level.

b. Set SQUELCH control R102 to the threshold, receiver muted, and using an insulated alignment tool adjust transformer T2 to the point where the squelch breaks and the audio output is audible at the speaker. Reset SQUELCH control R102 to mute receiver and readjust transformer T2 to break squelch, audio output audible. Repeat this process until no further benefit is obtained.

c. Disconnect signal generator and complete the remaining steps of paragraphs 16, 17, and 18 of Section III.

50. REPAIR REPLACEMENT SCHEDULE.

51. One characteristic of the majority of electronic parts is their failure to adhere to a predicted life cycle. A component for which long life may be predicted, will fail after a few hours of service. Conversely, an estimate of short life may prove inaccurate and a given part will last for years. For this reason a repair replacement schedule is neither feasible nor advisable. During the course of normal preventive maintenance any component showing signs of deterioration should be replaced immediately.

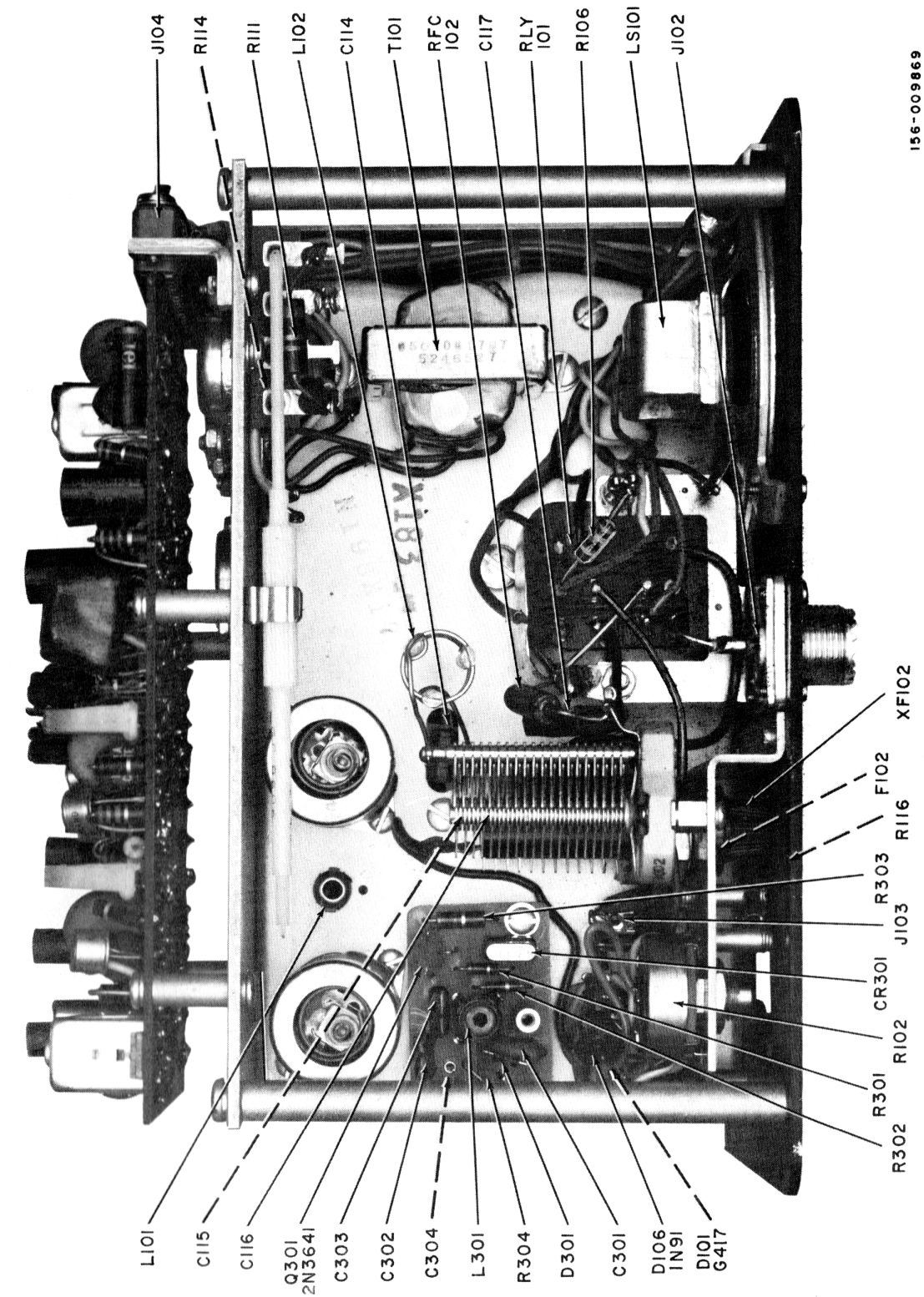

156-009969

Figure 7. Transceiver Chassis, Component Locations, Top View.



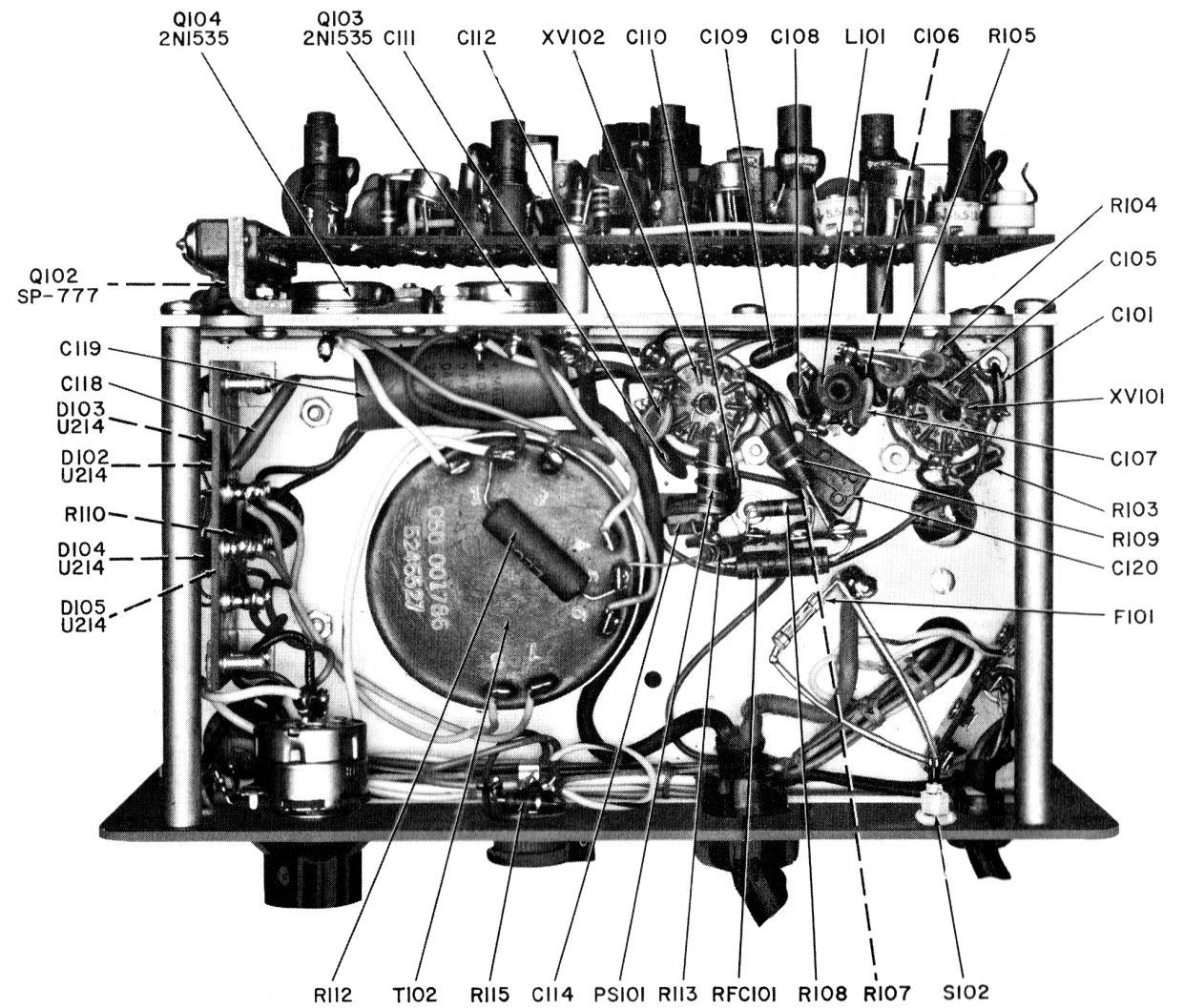

156-009876 B

Figure 8. Transceiver Chassis, Component Locations, Bottom View.

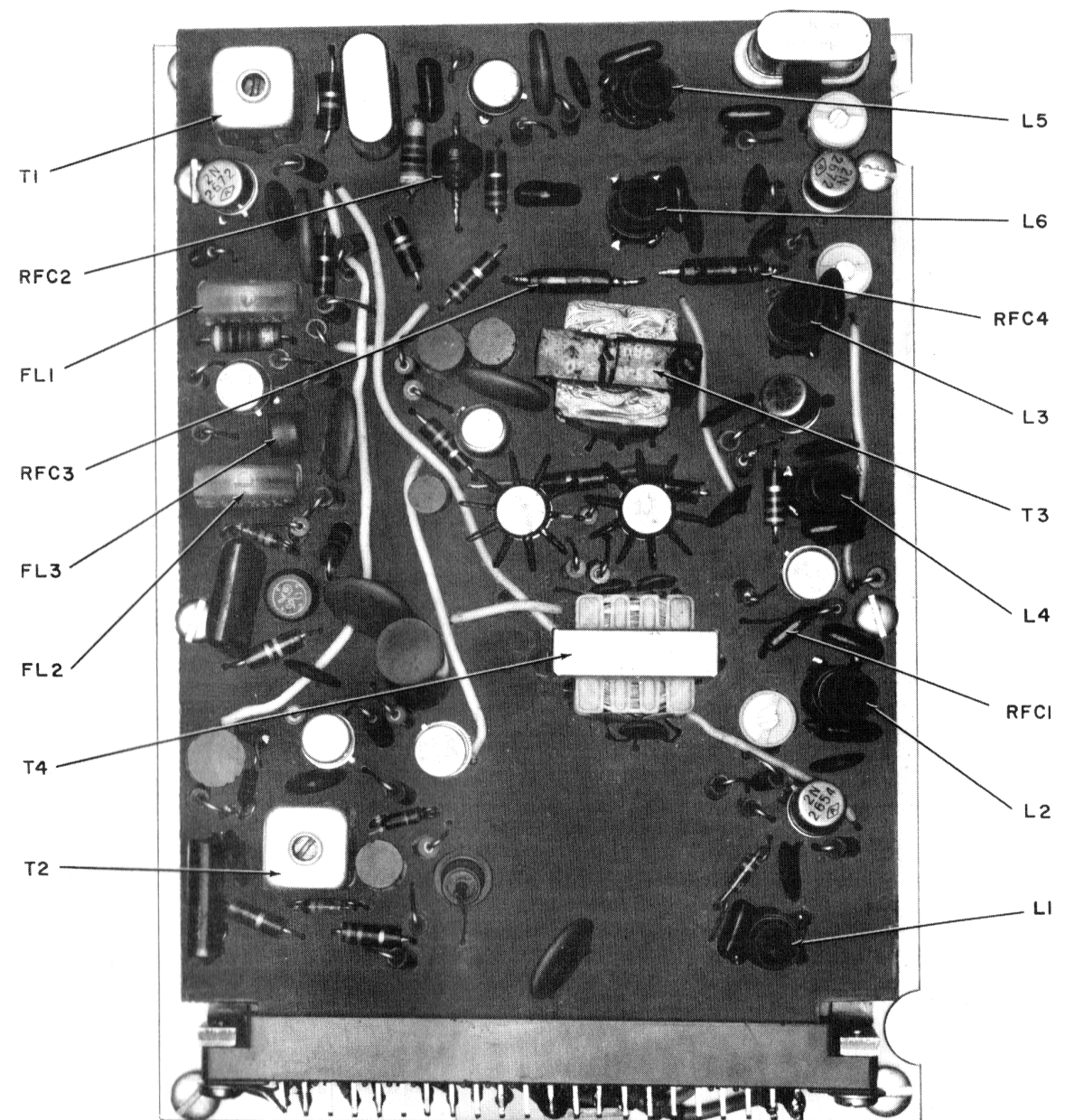

156-008317 B

Figure 9. Receiver Printed Circuit Board, Component Locations, (Sheet 1 of 3).

Revised November 1972

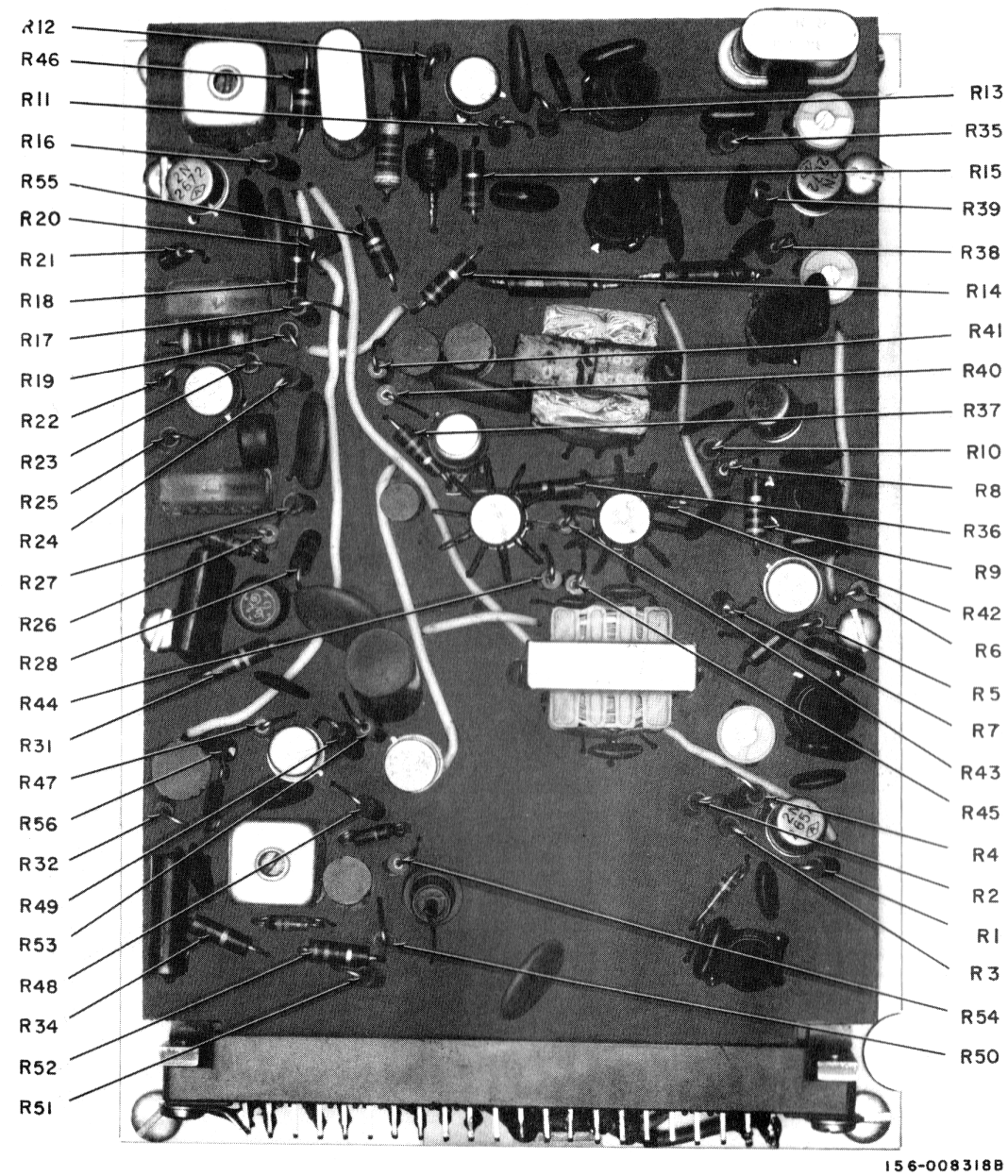

Figure 9. Receiver Printed Circuit Board, Component Locations, (Sheet 2 of 3).

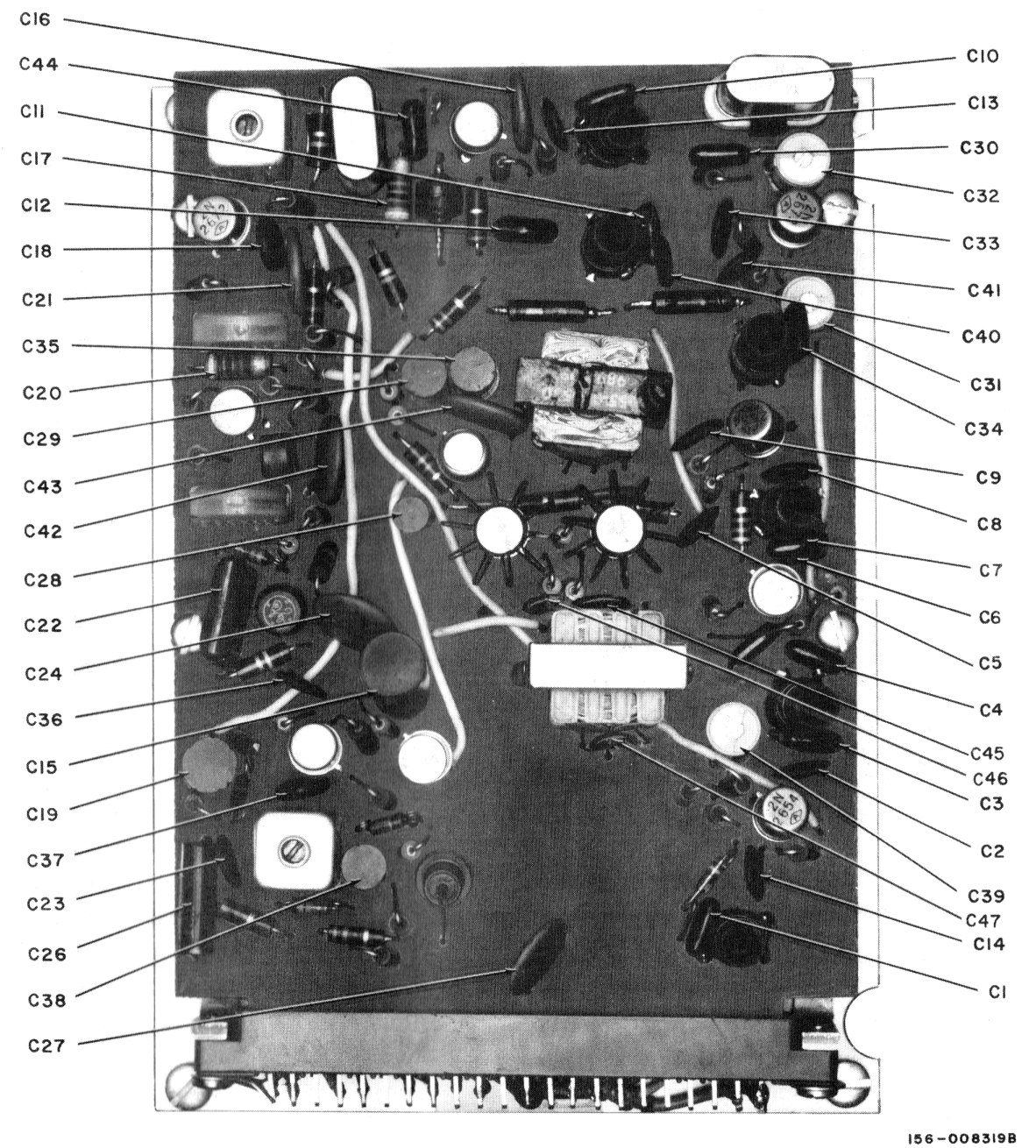

Figure 9. Receiver Printed Circuit Board, Component Locations, (Sheet 3 of 3).



**SECTION VI  
PARTS LIST**

NOTE

Components with reference designations from 1 to 99 are located on the removable printed circuit board. Components with reference designations from 101 to 199 are located on the main chassis. Components with reference designations from 201 to 299 are part of TS-20/35 Test Set, accessory item.

Reference Designation	Description	Part Number
C1	CAPACITOR, Mica, 68 PF, 5%, 500 VDCW	493-110680-233
C2	CAPACITOR, Ceramic, 0.01 UF, +70-30%, 300 VDCW	047-001900
C3	CAPACITOR, Mica, 110 PF, 5%, 500 VDCW	493-110111-234
C4	CAPACITOR, Mica, 50 PF, 5%, 500 VDCW	493-110500-233
C5	Same as C2	
C6	Same as C2	
C7	CAPACITOR, Mica, 75 PF, 10%, 500 VDCW	493-110750-133
C8	Same as C2	
C9	Same as C2	
C10	Same as C7	
C11	Same as C7	
C12	CAPACITOR, Mica, 300 PF, 2%, 500 VDCW	493-110301-334
C13	Same as C2	
C14	Same as C2	
C15	CAPACITOR, Electrolytic, 500 UF, 15 VDCW	045-001430
C16	CAPACITOR, Ceramic, 0.1 UF, +80-20%, 25 VDCW	047-001705
C17	CAPACITOR, Ceramic, 500 PF, 10%, 200 VDCW	049-000301
C18	CAPACITOR, Ceramic, 0.05 UF, 50 VDCW	047-001144
C19	CAPACITOR, Electrolytic, 5 UF, non-polarized, 20 VW	045-001242
C20	Same as C17	
C21	Same as C16	
C22	CAPACITOR, Mylar, 0.33 UF, 20%, 50 VDCW	047-001905
C23	Same as C2	
C24	CAPACITOR, Ceramic, 0.47 UF, ±20%, 12 VDCW	047-002794-010
C25	Not Used	
C26	CAPACITOR, Electrolytic, 6 UF, 20 VDCW	045-001186
C27	Same as C16	
C28	CAPACITOR, Electrolytic, 10 UF, 20 VDCW	045-001188
C29	CAPACITOR, Electrolytic, 20 UF, 15 VDCW	045-001191
C30	Same as C4	

Reference Designation	Description	Part Number
C31	CAPACITOR, Variable, 5.5-18 PF, NPO	044-000615
C32	Same as C31	
C33	Same as C2	
C34	CAPACITOR, Mica, 27 PF, 2%, 500 VDCW	493-110270-333
C35	Same as C29	
C36	Same as C2	
C37	Same as C18	
C38	Same as C29	
C39	Same as C31	
C40	Same as C2	
C41	Same as C2	
C42	Same as C16	
C43	Same as C16	
C44	Same as C34	
C45	Same as C16	
C46	Same as C16	
C47	Same as C16	
C101	Same as C2	
C102	Not Used	
C103	Not Used	
C104	Not Used	
C105	Same as C2	
C106	Same as C2	
C107	CAPACITOR, Mica, 20 PF, 5%, 300 VDCW	493-110200-221
C108	CAPACITOR, Mica, 18 PF, 5%, 300 VDCW	493-110180-221
C109	CAPACITOR, Mica, 100 PF, 10%, 300 VDCW	493-110101-124
C110	Same as C2	
C111	Same as C2	
C112	Same as C2	
C113	Not Used	
C114	CAPACITOR, Mica, 0.001 UF, 10%, 1000 VDCW	470-243102
C115	CAPACITOR, Variable, Air Dielectric, 6-41 PF	048-000579-001
C116	CAPACITOR, Variable, Air Dielectric, 9-140 PF	048-000579-002
C117	CAPACITOR, Mica, 180 PF, 5%, 500 VDCW	470-242181
C118	CAPACITOR, Ceramic, 0.01 UF, 20%, 2000 VDCW	047-001928
C119	CAPACITOR, Electrolytic, 5 UF, 450 VDCW	045-001241
C120	Same as C114	
C301	CAPACITOR, Ceramic, 0.05 UF, 50 VDCW	047-001144
C302	CAPACITOR, Mica, 20 PF, 5%, 300 VDCW	493-110200-221
C303	CAPACITOR, Mica, 10 PF, 5%, 300 VDCW	493-110100-221
C304	CAPACITOR, Mica, 82 PF, 5%, 300 VDCW	493-110820-223
CR1	CRYSTAL, Quartz, HC-6/U Holder, W/pins, for channel frequency (Receiver)	019-003375

Reference Designation	Description	Part Number
CR2	CRYSTAL, Quartz, HC-6/U Holder, 10 MC	019-003374
CR301	CRYSTAL, Quartz	019-003039
D1	DIODE, Germanium, 1N48A	019-003001
D2	DIODE, Silicon, G417	019-003364
D3	Same as D1	
D4	DIODE, Germanium, 1N91	019-001897
D5	DIODE, Zener, 1N759	019-003381
D6	Same as D1	
D7	DIODE, Silicon, 1N4001	019-003420
D101	Same as D2	
D102	DIODE, Silicon, power, U214	019-003363
D103	Same as D102	
D104	Same as D102	
D105	Same as D102	
D106	Same as D4	
D301	DIODE, Zener, Type 1N4737	019-005049
FL1	FILTER, Ceramic, 455 KC	049-000246
FL2	Same as FL1	
FL3	FILTER, Ceramic, 455 KC	049-000245
F101	Not Used	
F102	FUSE, Cartridge, 8 amperes, 125V	039-100347
J101	JACK, Phone, Miniature	036-000347
J102	CONNECTOR, Receptacle, Coaxial	010-100056
J103	CONNECTOR, Receptacle	006-200707
J104	CONNECTOR, Receptacle, 22 pin	010-001134
L1	TRANSFORMER, RF, input	051-003638
L2	TRANSFORMER, RF, coupling	051-003637
L3	COIL, RF, Oscillator	050-001609
L4	TRANSFORMER, RF, coupling	050-001610
L5	TRANSFORMER, RF, bandpass coupler	050-001611
L6	Same as L4	
L101	TRANSFORMER, RF, coupling	050-001606
L102	COIL, RF, output	050-001788
L301	COIL, RF	050-003465
LS101	LOUDSPEAKER, PM	085-000256
MK101	MICROPHONE	085-000258
PS101	SUPPRESSOR, Parasitic	050-001790
Q1	TRANSISTOR, PNP, 2N2654	019-004461
Q2	TRANSISTOR, PNP, 2N2654 (MODIFIED)	019-003383
Q3	Same as Q2	
Q4	TRANSISTOR, PNP, 2N2672	019-003384
Q5	Same as Q4	
Q6	Same as Q4	
Q7	TRANSISTOR, PNP, 2N1098	019-003367

Reference Designation	Description	Part Number
Q8	Same as Q4	
Q9	TRANSISTOR, PNP, SA536	019-003346
Q10	TRANSISTOR, PNP, 2N4036	019-005117
Q11	Same as Q10	
Q12	Same as Q4	
Q13	TRANSISTOR, NPN, 2N388	019-003390
Q101	TRANSISTOR, PNP, Power SP-777	019-003442
Q102	Same as Q101	
Q103	TRANSISTOR, PNP, Power, 2N1535	019-003360
Q104	Same as Q103	
Q301	TRANSISTOR, Type 2N3641	019-005021
RFC1	CHOKE, RF, 1 UH	050-001604
RFC2	CHOKE, RF, 200 UH	050-001575
RFC3	CHOKE, RF, 15 UH	050-001603
RFC4	Same as RFC3	
RFC101	CHOKE, RF, 10 UH	050-001612
RFC102	Same as RFC101	
RLY101	RELAY, Armature, 12 V Coil, 3 form C contacts	021-000762
R1	RESISTOR, 10K ohm, 10%, 1/2W	451-252103
R2	RESISTOR, 1800 ohm, 10%, 1/2W	451-252182
R3	RESISTOR, 1000 ohm, 10%, 1/2W	451-252102
R4	RESISTOR, 1500 ohm, 10%, 1/2W	451-252152
R5	RESISTOR, 5600 ohm, 10%, 1/2W	451-252562
R6	RESISTOR, 47K ohm, 10%, 1/2W	451-252473
R7	RESISTOR, 3300 ohm, 10%, 1/2W	451-252332
R8	Same as R5	
R9	Same as R6	
R10	Same as R3	
R11	Same as R5	
R12	Same as R6	
R13	Same as R3	
R14	RESISTOR, 470 ohm, 10%, 1/2W	451-252471
R15	RESISTOR, 6800 ohm, 10%, 1/2W	451-252682
R16	Same as R1	
R17	RESISTOR, 2200 ohm, 10%, 1/2 W	451-252222
R18	RESISTOR, 560 ohm, 10%, 1/2W	451-252561
R19	RESISTOR, 680 ohm, 5%, 1/2W	451-251681
R20	RESISTOR, 1200 ohm, 10%, 1/2W	451-252122
R21	Same as R3	



Reference Designation	Description	Part Number
R22	RESISTOR, 33K ohm, 10%, 1/2W	451-252333
R23	RESISTOR, 4700 ohm, 10%, 1/2W	451-252472
R24	Same as R18	
R25	Same as R17	
R26	RESISTOR, 39K ohm, 10%, 1/2W	451-252393
R27	Same as R3	
R28	Same as R18	
R29	Not Used	
R30	Not Used	
R31	RESISTOR, 220K ohm, 10%, 1/2W	451-252224
R32	Same as R15	
R33	Not Used	
R34	Same as R3	
R35	Same as R4	
R36	RESISTOR, 56K ohm, 10%, 1/4W	451-152563
R37	RESISTOR, 12K ohm, 10%, 1/2W	451-252123
R38	Same as R5	
R39	Same as R15	
R40	Same as R17	
R41	RESISTOR, 820 ohm, 10%, 1/2W	451-252821
R42	Same as R20	
R43	RESISTOR, 5.6 ohm, 10%, 1/4W	451-152056
R44	RESISTOR, 4.7 ohm, 10%, 1/2W	451-252047
R45	Same as R44	
R46	RESISTOR, 100K ohm, 10%, 1/2W	451-252104
R47	Same as R46	
R48	Same as R14	
R49	Same as R5	
R50	Same as R23	
R51	Same as R1	
R52	Same as R7	
R53	RESISTOR, 330 ohm, 10%, 1/2W	451-252331
R54	RESISTOR, 82 ohm, 10%, 1/2W	451-252820
R55	Same as R31	
R56	Same as R7	
R101	RESISTOR, Variable, 5K ohm, 1/4W W/SPST Switch S101	025-002415
R102	RESISTOR, Variable, 100K ohm, 1/4W	025-002378
R103	Same as R46	

Reference Designation	Description	Part Number
R104	RESISTOR, 120K ohm, 10%, 1W	451-352124
R105	RESISTOR, 1500 ohm, 10%, 2W	451-652152
R106	RESISTOR, 10 ohm, 10%, 1/2W	451-252100
R107	RESISTOR, 22K ohm, 10%, 1/2W	451-252223
R108	RESISTOR, 82 ohm, 5%, 1/2W	451-251820
R109	RESISTOR, 12K ohm, 10%, 2W	451-652123
R110	RESISTOR, 33 ohm, 5%, 1/2W	451-251330
R111	RESISTOR, 1 ohm, 5%, 2W	024-001441
R112	RESISTOR, 6 ohm, 5%, 5W	024-001518
R113	Same as R14	
R114	RESISTOR, 1000 ohm, 5%, 1/2W	451-251102
R115	RESISTOR, 100 ohm, 10%, 1/2W	451-252101
R116	RESISTOR, 22 ohm, 10%, 1/2W	451-252220
R301	RESISTOR, 8.2K ohm, 10%, 1/4W	451-152822
R302	RESISTOR, 1000 ohm, 10%, 1/4W	451-152102
R303	RESISTOR, 100 ohm, 10%, 1/2W	451-252101
R304	RESISTOR, 56 ohm, 10%, 1W	451-352560
S101	P/O R101	
S102	SWITCH, (Destruct Switch)	060-002583
T1	TRANSFORMER, IF, 455 KC	050-001600
T2	Same as T1	
T3	TRANSFORMER, Audio, driver	055-000530
T4	TRANSFORMER, Audio, Output and modulation driver	055-001091
T101	TRANSFORMER, Audio, modulation	050-001787
T102	TRANSFORMER, Power	050-001786
V101	TUBE, Electron, 7905	090-001554
V102	Same as V101	
XF102	FUSEHOLDER	006-000375
XV101	SOCKET, Electron Tube	006-001134
XV102	Same as XV101	

Reference Designation	Description	Part Number
R22	RESISTOR, 33K ohm, 10%, 1/2W	451-252333
R23	RESISTOR, 4700 ohm, 10%, 1/2W	451-252472
R24	Same as R18	
R25	Same as R17	
R26	RESISTOR, 39K ohm, 10%, 1/2W	451-252393
R27	Same as R3	
R28	Same as R18	
R29	Not Used	
R30	Not Used	
R31	RESISTOR, 220K ohm, 10%, 1/2W	451-252224
R32	Same as R15	
R33	Not Used	
R34	Same as R3	
R35	Same as R4	
R36	RESISTOR, 56K ohm, 10%, 1/4W	451-152563
R37	RESISTOR, 12K ohm, 10%, 1/2W	451-252123
R38	Same as R5	
R39	Same as R15	
R40	Same as R17	
R41	RESISTOR, 820 ohm, 10%, 1/2W	451-252821
R42	Same as R20	
R43	RESISTOR, 5.6 ohm, 10%, 1/4W	451-152056
R44	RESISTOR, 4.7 ohm, 10%, 1/2W	451-252047
R45	Same as R44	
R46	RESISTOR, 100K ohm, 10%, 1/2W	451-252104
R47	Same as R46	
R48	Same as R14	
R49	Same as R5	
R50	Same as R23	
R51	Same as R1	
R52	Same as R7	
R53	RESISTOR, 330 ohm, 10%, 1/2W	451-252331
R54	RESISTOR, 82 ohm, 10%, 1/2W	451-252820
R55	Same as R31	
R56	Same as R7	
R101	RESISTOR, Variable, 5K ohm, 1/4W W/SPST Switch S101	025-002415
R102	RESISTOR, Variable, 100K ohm, 1/4W	025-002378
R103	Same as R46	

Reference Designation	Description	Part Number
R104	RESISTOR, 120K ohm, 10%, 1W	451-352124
R105	RESISTOR, 1500 ohm, 10%, 2W	451-652152
R106	RESISTOR, 10 ohm, 10%, 1/2W	451-252100
R107	RESISTOR, 22K ohm, 10%, 1/2W	451-252223
R108	RESISTOR, 82 ohm, 5%, 1/2W	451-251820
R109	RESISTOR, 12K ohm, 10%, 2W	451-652123
R110	RESISTOR, 33 ohm, 5%, 1/2W	451-251330
R111	RESISTOR, 1 ohm, 5%, 2W	024-001441
R112	RESISTOR, 6 ohm, 5%, 5W	024-001518
R113	Same as R14	
R114	RESISTOR, 1000 ohm, 5%, 1/2W	451-251102
R115	RESISTOR, 100 ohm, 10%, 1/2W	451-252101
R116	RESISTOR, 22 ohm, 10%, 1/2W	451-252220
R301	RESISTOR, 8.2K ohm, 10%, 1/4W	451-152822
R302	RESISTOR, 1000 ohm, 10%, 1/4W	451-152102
R303	RESISTOR, 100 ohm, 10%, 1/2W	451-252101
R304	RESISTOR, 56 ohm, 10%, 1W	451-352560
S101	P/O R101	
S102	SWITCH, (Destruct Switch)	060-002583
T1	TRANSFORMER, IF, 455 KC	050-001600
T2	Same as T1	
T3	TRANSFORMER, Audio, driver	055-000530
T4	TRANSFORMER, Audio, Output and modulation driver	055-001091
T101	TRANSFORMER, Audio, modulation	050-001787
T102	TRANSFORMER, Power	050-001786
V101	TUBE, Electron, 7905	090-001554
V102	Same as V101	
XF102	FUSEHOLDER	006-000375
XV101	SOCKET, Electron Tube	006-001134
XV102	Same as XV101	



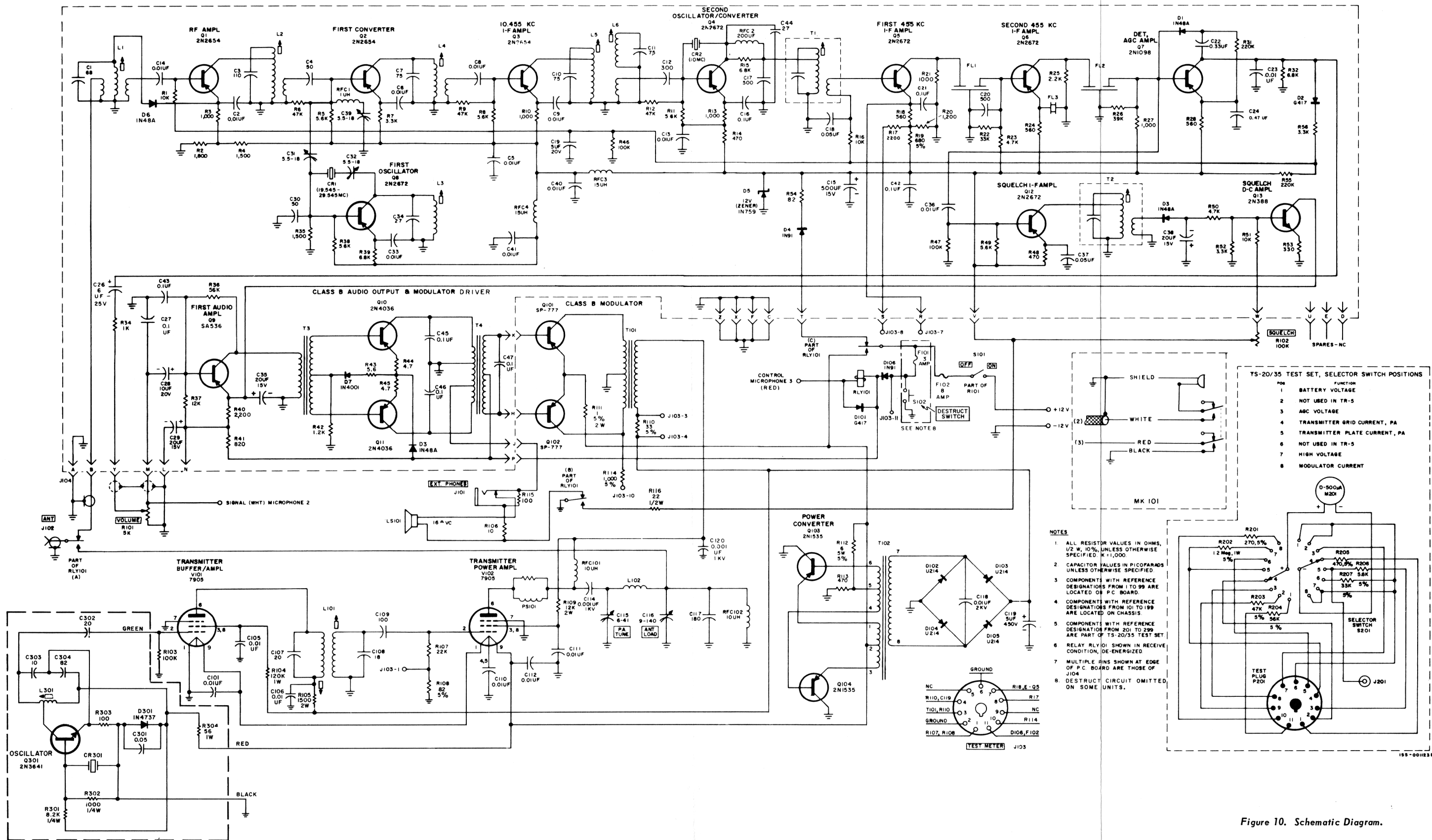

Figure 10. Schematic Diagram.

Revised November 1972

**SUPPLEMENTARY INSTRUCTIONS  
FOR  
ANTENNA MODEL A-20A**



TABLE OF CONTENTS

Section	Page
I INTRODUCTION . . . . .	1
Purpose of Equipment . . . . .	1
Description . . . . .	1
II INSTALLATION AND ADJUSTMENT . . . . .	1
Unpacking . . . . .	1
Tuning . . . . .	1
Assembly . . . . .	1
III THEORY OF OPERATION . . . . .	2
VI PARTS LIST . . . . .	3

LIST OF FIGURES

Figure	Page
1 Model A-20A, Antenna Assembly . . . . .	iv
2 Antenna Element Tuning Chart . . . . .	1
3 Model A-20A Antenna, Assembly Diagram . . . . .	4

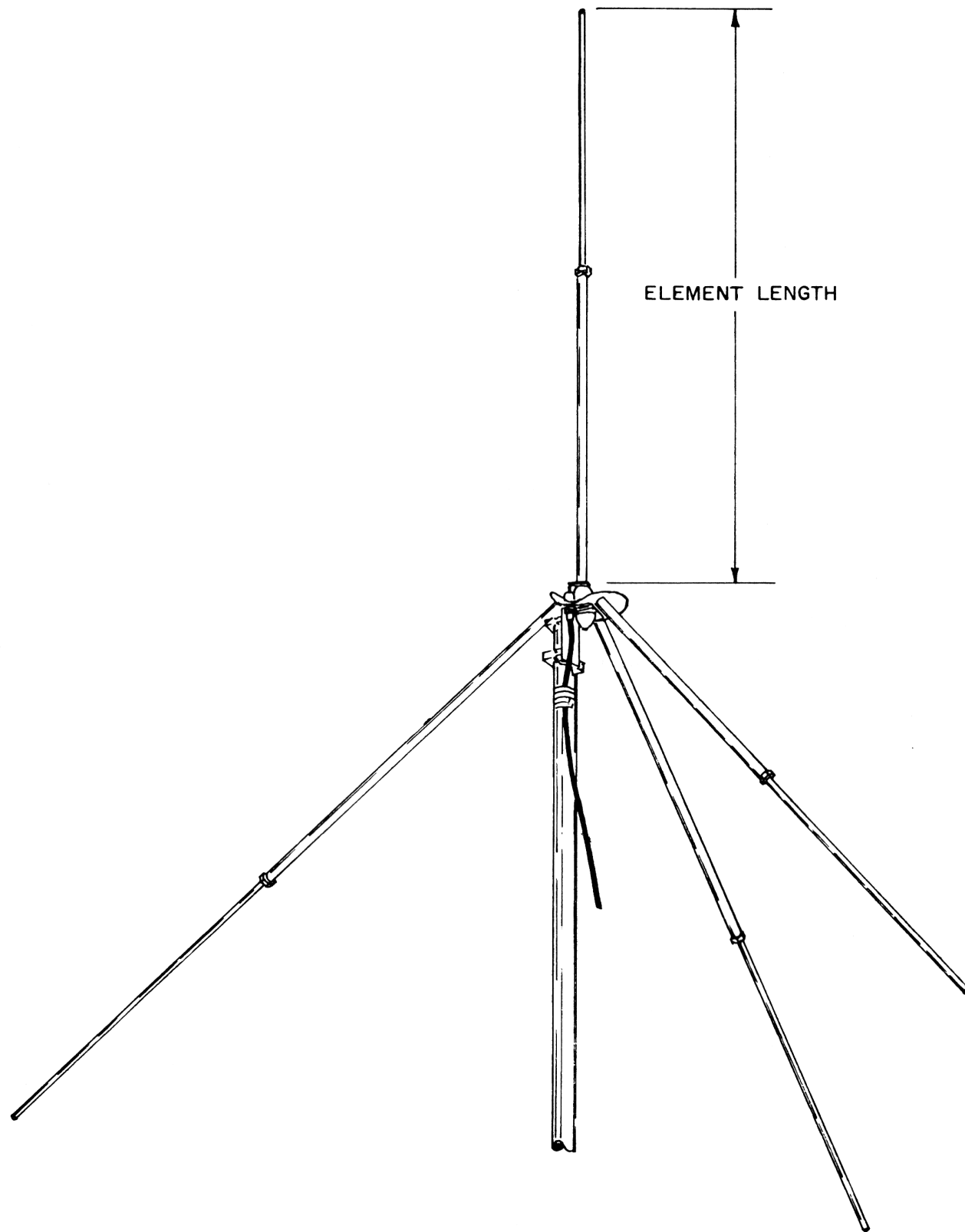

Figure 1. Model A-20A Antenna Assembly.

156-004645

## SECTION I INTRODUCTION

### 1. PURPOSE OF EQUIPMENT.

2. The Model A-20A Antenna is designed to provide unity gain at a specific operating frequency within the frequency range of 30 to 40 megacycles and provide a low angle radiated signal for increased ground coverage.

### 3. DESCRIPTION.

4. The Model A-20A Antenna, shown in Figure 1,

is of the ground plane type. The antenna consists of a quarter-wave vertical radiating element and three ground plane radials. The antenna feedline is 60 feet of RG-58A/U coaxial cable. The antenna and feedline, when properly tuned to the operating frequency, present the optimum load to the transmitter-receiver. The standing wave ratio of 1.1 to 1 approaches the ultimate condition. The antenna, when assembled, is approximately 12 feet in height. The mounting bracket is designed to mount on a 7/8 to 2-1/2 inch diameter metal mast.

## SECTION II INSTALLATION AND ADJUSTMENT

### 5. UNPACKING.

6. The parts required for one antenna assembly are packaged in two containers. The four telescoping antenna elements are packaged in a 52-inch paper tube; the coaxial cable, mounting plate and hardware are packaged in a corrugated carton 4-7/8 inches, by 6 inches, by 7-1/2 inches.

7. **CHECKING.** The parts list in this manual may be used to check for shortages upon receipt and prior to assembly. Inspect all parts for possible damage incurred in shipment. Report shortage and/or damage immediately to responsible personnel.

### 8. TUNING.

9. Refer to Figure 2 and determine the length of the telescoping antenna elements for the operating frequency desired. Refer to Figure 3, and loosen the locking nut, with a 5/8-inch open-end wrench. Position the telescoping element to the proper length determined from Figure 2 and tighten the locking nut securely. Complete this procedure for the three remaining elements, exercising care that all four are the same length.

### 10. ASSEMBLY.

11. Refer to Figure 3 and complete the following steps:

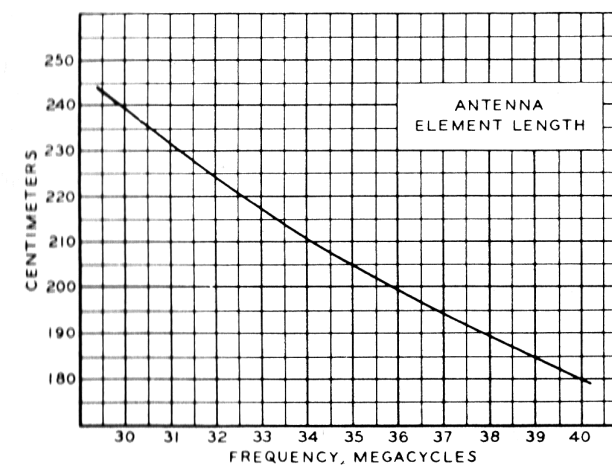

Figure 2. Antenna Element Tuning Chart

156-004646

a. Identify the mounting plate with insulator and mounting stud.

b. Attach antenna element to the stud at the mounting plate and tighten using two 5/8-inch open-end wrenches.

c. Attach the three remaining elements to the angle surfaces of the mounting plate using a 1/4-20 by 3/4 inch hex head screw and a 1/4 inch split ring lock washer, at each element. The antenna assembly may be permitted to rest upon the tips of the three ground plane radials during the tightening operation. Using a 7/16 open-end wrench on the hex head screw and a 5/8 inch open-end wrench on the tapped insert in the antenna element, tighten securely. **DO NOT ATTEMPT TO USE PLIERS OR OTHER GRIPPING TYPE TOOL ON THE ANTENNA ELEMENT WHEN TIGHTENING.**

d. Note the location of formed solder lug on the bottom insulator, this device provides lightning protection for the antenna when properly positioned. Proper position provides a gap the thickness of metal solder lug between tip and metal plate of antenna base. **DO NOT ATTEMPT TO USE ANTENNA WITH THIS DEVICE TOUCHING METAL BASE PLATE.**

e. Identify the two fixed mounting clamps

and attach to mounting bracket as shown in figure 3. Use one round head bolt 1/4-20 by 3/8 inch long and 1/4 inch split ring lock washer to secure. Tighten using a large screwdriver. Identify the two adjustable mounting clamps and assembly as shown in figure 3. Use two round head bolts 1/4-20 by 4-1/2 inches long and two 1/4 inch split ring lock washers at each clamp. Mount antenna on a metal mast using the adjustable clamping device. The clamps permit use of metal masts from 7/8 to 2-1/2 inches in diameter. Tighten securely using a large screwdriver.

f. Identify the coaxial receptacle (Type SO239) at the mounting plate and attach one of the coaxial plugs (Type PL259) terminating the 60 foot length of coaxial cable, tighten securely.

g. Tape the connection at the connector to prevent moisture entrance. Tape the coaxial cable to the mast approximately 5 inches below the mounting plate and at two foot intervals from there to ground. Taping of the cable to the mast relieves strain on the connector and cable.

h. Identify the 3/8 inch diameter four foot long ground rod and accessory strap. Place ground rod in earth approximately 6 to 12 inches from base to mast. Place strap around mast, tighten securely and connect pigtail from ground rod to strap.

### SECTION III THEORY OF OPERATION

12. The ground plane antenna minimizes the effects of re-radiation from the ground or other surface in the plane perpendicular to the radiating element. This is accomplished by the ground plane radials which tend to attenuate or minimize downward radiation from the vertical radiator. The radio frequency energy, which would otherwise be lost, is used to strengthen the horizontal radiation pattern. This strengthened horizontal

radiation pattern increases ground coverage through low angle radiation. The antenna radiation pattern is circular or omnidirectional.

13. The voltage at the base of the vertical radiator is low in value, thereby eliminating elaborate insulating procedures. The radiation resistance of the ground plane antenna of this design requires the use of 50-ohm coaxial cable.

### SECTION IV PARTS LIST

Quantity	Description
1	BRACKET, Mounting
1	PLATE, Mounting, base
2	INSULATOR, Antenna element
1	LUG, Solder, for 1/4 inch screw
1	LUG, Solder, for 1/4 inch screw, formed (lightning arrester)
2	GASKET, Fiber, 1-3/4 inch OD by 1-1/4 inch ID by 0.020 inch thk.
2	WASHER, Fiber, for 1/4 inch screw
2	WASHER, Flat, metal, for 1/4 inch screw
1	SCREW, Cap, hex head, 1/4-20 by 3-1/2 inches long
1	NUT, Hex, Special, 1/4-20. jam.
1	CONNECTOR, Receptacle, Coaxial, Type SO-239 w/moisture seal
4	ELEMENT, Adjustable, w/rain plug
4	NUT, Hex, Special, 5/8 in. locking
3	SCREW, Cap, hex head, 1/4-20 by 3/4 in. long
2	CLAMP, Mounting, fixed
2	CLAMP, Mounting, adjustable
2	BOLT, Round head, slotted drive, 1/4-20 by 3/8 inch long
4	BOLT, Round head, slotted drive, 1/4-20 by 4-1/2 inches long
10	WASHER, Split ring lock, for 1/4 screw
2	CONNECTOR, Plug coaxial, Type PL-259 with UG-175/u adapter
60 ft.	CABLE, Coaxial, 50-ohm, RG-58A/U
1	ROD, Ground, 3/8 inch dia. by 48 inches long with ground strap and pigtail



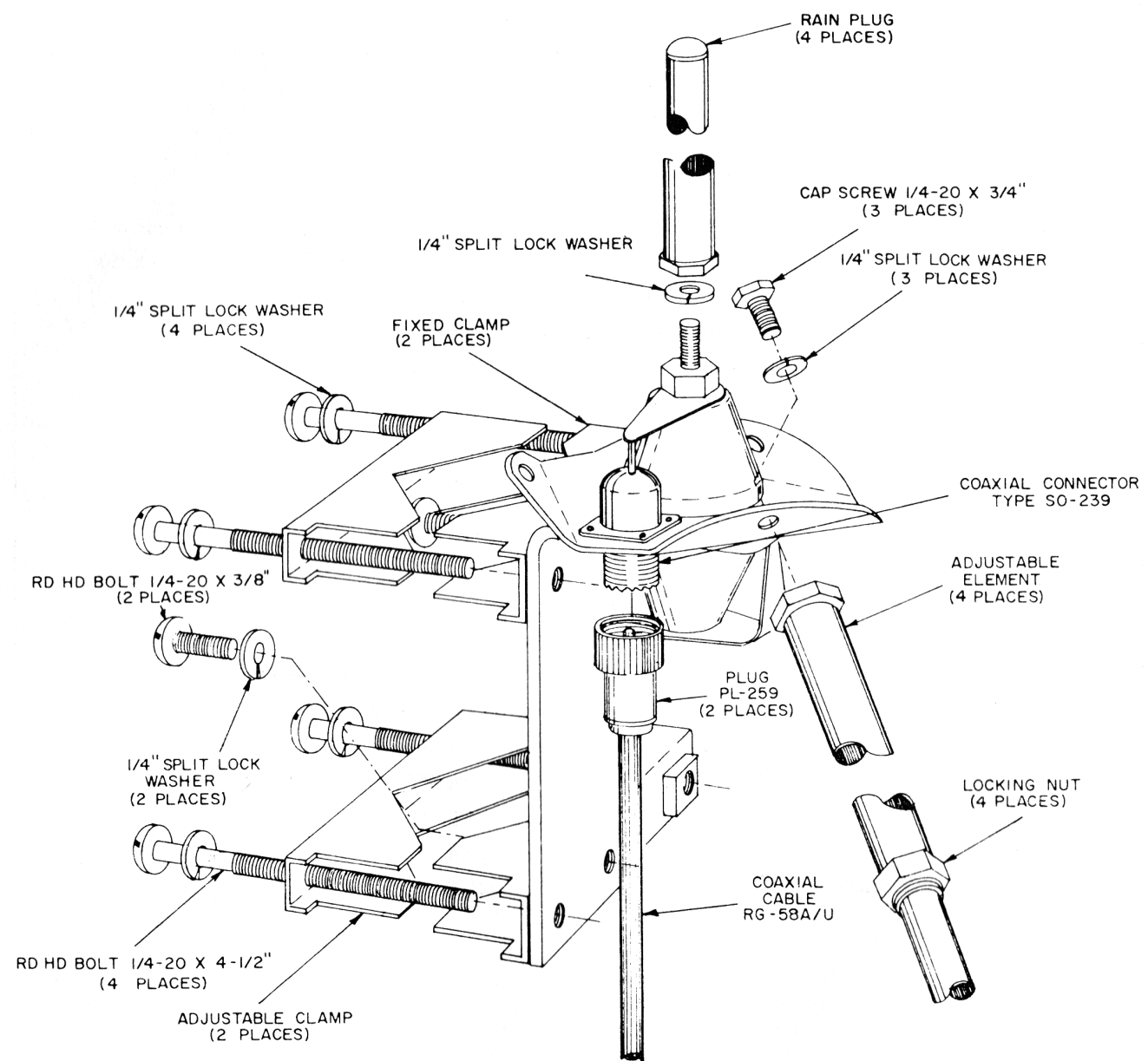

156-004647

Figure 3. Model A-20A Antenna Assembly Diagram.