

25c [^{30c} in Canada]

AUGUST, 1935

\$3.00
PER YEAR
BY SUBSCRIPTION

RADIO

ESTABLISHED 1917

SHORT-WAVE AND EXPERIMENTAL

OHM'S LAW

$$E = I \times R$$

$$R = \frac{E}{I}$$

$$I = \frac{E}{R}$$

CONDENSERS IN SERIES

$$C_{TOTAL} = \frac{C_1 \times C_2}{C_1 + C_2}$$

RESISTANCES IN PARALLEL

$$R_{TOTAL} = \frac{R_1 \times R_2}{R_1 + R_2}$$

BOTTOM VIEWS OF SOCKETS

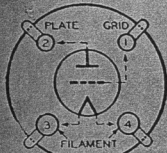

4-PRONG SOCKET
50-201-A, 45, 210, 30, 31, ETC.

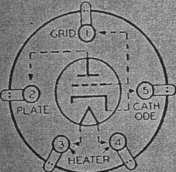

5-PRONG SOCKET
56-46-47-76-27-37
(Cathode is Screen Connection for *47)

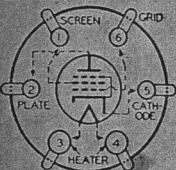

6-PRONG SOCKET
2A5-41-42-43

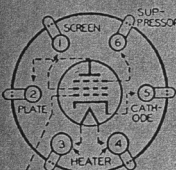

6-PRONG SOCKET
57-58-606-606-77-78

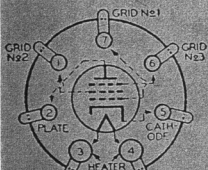

7-PRONG SOCKET 59

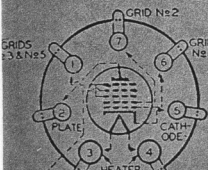

7-PRONG SOCKET
2A7-6A7

-IN THIS ISSUE-

Interlock Crystal Control

Controlled Carrier 1-KW. Phone at W6HYB

Half-Kilowatt C. W. Transmitter

A Novel 2 1/2-Meter Transmitter

2-Tube Receiver With Semi-Tuned R. F.



The 1 K.W. Class B Linear Amplifier at W6HYB, an economical and practical amplifier for use in a high-power Variactor Controlled Carrier Transmitter. A complete description of W6HYB and the details for adjusting the Class B Linear Amplifier are found in this issue.

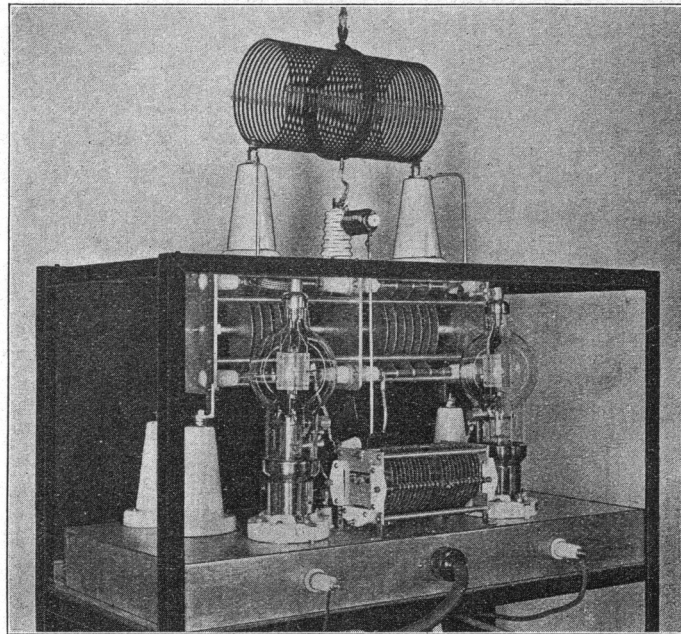

FEATURE ARTICLES BY ...

FRANK C. JONES - D. B. MCGOWN - W. E. SWARTOUT - COL. C. FOSTER
J. N. A. HAWKINS - FRANCIS CHURCHILL - G. F. LAMPKIN

Electric Current Moves From Negative To Positive Terminal—

● For many years it was assumed that electric current moved from Positive to Negative terminal. But in "THE 'RADIO' HANDBOOK" you learn why this theory was not correct. It has now been found that the contrary is true . . . electrons move from Negative to Positive terminal.

In "THE 'RADIO' HANDBOOK" you also find a complete chapter devoted to the fundamentals of electricity and radio. The newer Electron Theory is used throughout . . . a simpler, more practical, more understandable way to master the important subjects.

"THE 'RADIO' HANDBOOK" is up-to-date; in it you find theory which has not been published before. You find tables, charts, diagrams, formulae and facts of untold value to the radio amateur, engineer, experimenter, student, novice.

It is a 300 page book, chock-full of the latest and best in amateur receiving and transmitting equipment, including controlled carrier modulation, new grid-modulation systems, constructional details for building better receivers and transmitters, 67 pages of 5-meter data.

The sale of this handbook by "RADIO" has been enormous . . . far exceeding our fondest hopes. Letters and telegrams of congratulation are being received hourly. Some dealers have re-ordered as many as nine times within a single month.

If you want the new authority in amateur radio literature, get your copy of "THE 'RADIO' HANDBOOK" today. If your dealer does not sell it, send your order direct to the publisher. But go to your dealer first . . . he is your friend . . . he is anxious to serve you.

For those who cannot purchase copies from dealers, the coupon below can be sent to us. Attach a dollar bill, check, money-order or stamps . . . and MAIL TODAY.

Publishers of "RADIO"
Pacific Building, San Francisco, California

Here is \$1.00. Send me a copy of the 300 page book, "THE 'RADIO' HANDBOOK", postage-paid.

Name.....

Street and Number.....

City and State.....

BRANCH OFFICES:
New York City,
253 W. 128th St.
Tel. MOnument 2-2812
Boston,
J. H. Condon,
6 Marlboro St.
Chicago,
C. W. Nelson,
3618 North Bernard St.
Los Angeles, Calif.
1455 Glenville Drive.
Tel. CRestview 4017

RADIO

ESTABLISHED 1917

Reg. U. S. Pat. Off.

A NATIONAL MAGAZINE - PUBLISHED MONTHLY

Publication Offices—Pacific Building, San Francisco, California

H. W. Dickow, Publisher.

D. B. McGown, Technical Editor.
Clair Foster, Amateur Activity Editor.

Frank C. Jones, Engineering Editor
C. C. Anderson, Engineering Draftsman.

25c per copy, \$3.00 per year by subscription in the U.S. \$4.00 elsewhere. Send subscriptions to the San Francisco office. Entered as second class matter at the Post Office at San Francisco, California, under the Act of March 3rd, 1879.

Vol. 17

AUGUST, 1935

No. 8

Radiotorial Comment

● "The only cloud is a lack of prizes. We do not have enough small prizes for a drawing in which an estimated 500 will participate. We realize that your only return is derived from the 'good-will' and advertising received, and we will help you in this way to the greatest possible extent. The FRRL (Fox River Radio League of Aurora, Illinois) realizes that the manufacturer and dealer has been deluged with these requests, and that something must be done to reduce them. We shall bring this matter up during the convention, calling attention to the fact that the donors of prizes are deserving of special recognition for their generosity at this time. In return for your support we intend to go on record as favoring a reduction in the number of Hamfests and Conventions, and to cooperate with other clubs in this vicinity to further the plan."

So reads part of a communication received from the Fox River Radio League, Aurora, Illinois. A discussion of the matter has brought varied comment from manufacturers and dealers who have been questioned by the publishers of this magazine. The countless number of small hamfests have been a thorn in the side of manufacturers, jobbers and dealers. East Coast radio clubs write to West Coast manufacturers for prizes, and vice versa. Said one manufacturer who specializes in the making of high-priced equipment: "We hate like hell to turn down these requests for prizes, yet we fear a bad reaction on the part of the amateurs if we refuse to donate. Our product is a specialty; it costs us almost twenty dollars to manufacture, and our margin of profit is exceedingly small. If we donated a prize to each of those who requested us to do so, we would have been forced to close our doors long ago. Yet we have been roundly criticized because we politely refused to donate equipment to certain radio clubs, even after explaining in complete detail the reason why it is absolutely impossible for us to play Santa Claus to the myriad of clubs who ask us to offer donations. We are in favor of making donations only to the larger and more important annual conventions, and we welcome the time when some aggressive radio club membership will see to it that a ruling is made to the effect that prizes are solicited only for the important amateur gatherings."

Many an amateur will travel hundreds of miles to attend a hamfest in anticipation that he will bring home with him a few kilowatts of transformer, a dozen mikes of 5000 volt condenser, or perhaps a complete half-KW radiophone job, ready to operate, with a special-privilege radiophone license thrown in by a big-hearted radio inspector. Too often has the hamfester returned home in disgust, protesting that he spent two dollars

for a hamfest ticket and came home with nothing more than a 50,000 ohm resistor with one of the contacts broken off. Then there is the hamfester who wins a valuable prize—sells it for a fraction of its worth before he leaves the prize shuffle, and returns home to tell the neighboring hams that he didn't win a thing.

Some radio clubs have licked the free-prize racket in various ways, others have not been so successful. Are the radio amateurs the chosen people of God? When they meet, sometimes with only a handful in attendance, some manufacturer, dealer, jobber, somewhere, is approached for the usual lot of prizes.

If there are no prizes the rukus goes down in history as the worst flop since the Philadelphia Exposition. When a blow-out of radio servicemen is called, when automobile salesmen or mechanics meet, when aeronautical technicians gather, you don't walk in on those meetings and find a huge array of free console radio sets and airplane engines stacked high on the speakers' table. And nobody makes the rounds of the audience to peddle tickets at a dollar a dozen so that some lucky fellow can walk home with a nice new automobile body or an airplane engine under his arm.

The free-prize racket has made a chiseler out of many an otherwise-modest radio amateur. So to the Fox River Radio League of Aurora goes the unspoken thanks of many a radio manufacturer, jobber, dealer who has long waited for someone to take the bull by the horns and do something to clean up a situation which has oft given amateur radio a beautiful black eye. Unfortunately these manufacturers, jobbers and dealers dare not express their opinions publicly.

On the other hand, there isn't a merchant in the radio industry who wouldn't open the doors of his stock room to the radio amateurs so that their annual conventions can be well supplied with free prizes. Thus the FRRL suggestion should warrant action on the part of every business-like group of amateurs. If a standing rule is made that prizes will be solicited only for the big annual gatherings, watch the number and the quality of the prizes jump about 8 points on the R scale.

Viva La Roberts!

● ARRL Director Roberts of the Central Division will have something to say at the 8th Annual Convention, August 4 in the Exposition Park, Aurora, Illinois. What he will say should furnish material for a new chapter in amateur radio history. Roberts, when first elected to office, was a devout Warner supporter. Literature printed in his division carried glowing tribute to the man who so

successfully wiggled his way out of many an embarrassing situation (with major exceptions). More recently Director Roberts had a taste of how the Warner machine functioned. He returned from the Hartford Board meeting with fire in his eyes . . . determined to clean house at "Headquarters", had himself appointed a member of both the ARRL Investigating Committee and the ARRL Cairo Committee. Reports from the midwest are loaded with juicy, spicy tales of how this man Roberts feels about conditions at Hartford . . . how he is going about his work to make a clean sweep of the debris which has cluttered the trail of the amateur paper-victory propagandists.

It has been rumored that Roberts will declare himself at the Aurora Convention. He is a man mature in years, successful in business in no small way, active in amateur radio for quite a number of years. Some say that Roberts is cautiously feeling his way along, ready to spring a sensation or two when the ARRL Investigating Committee reports this fall. And so the entire amateur fraternity anxiously awaits the announcement which Roberts will make on August 4. Comment on his message will be in September "RADIO". In the meantime, it behooves every clean-thinking amateur not to sell Roberts short.

Lop-Sided Editorial Policy?

● Quotations from a letter from Colonel Foster to a Warner supporter: "I really enjoy getting beaten up. I only wish some of the other Warner supporters would come to his aid instead of leaving him to fight his battles all alone." Asking permission to reprint a post-card received from the Warner supporter, the Colonel adds: "If you will do this (permission to reprint the card) I'll see that it is printed in a prominent place in 'RADIO' and word-for-word just as you write it. You surely could have no objection to having the gang see in print what you send through the mails in an open postcard. Now, do I get the article or letter for publication? And do I get your permission to publish your postcard? I'll even PAY you for the material. I'll give you ten dollars for an article of, say 1000 words, and I'll give you five dollars for permission to publish your postcard. Anything fairer than that?"

So that those who have falsely labored under the impression that the pages of this magazine are open only to those on "our" side of the fence, an offer is made by the Colonel to pay for the aforementioned bit of pro-Warner propaganda. If the Warner man accepts, you will see his writings in "RADIO". If he refuses, the \$10 goes back into the Colonel's till.

(Continued on page 29)

Colonel Foster's Comment

OUR AUTHORIZED REPRESENTATIVES

● As a part of the record of a case in the Court of Appeals of the District of Columbia there appears this statement regarding the radio amateurs:

"Prior to Feb. 23, 1927, they were entitled to use the entire range of frequencies from 1,500 KC upwards . . . At the various National Radio Conferences, speaking through their authorized representatives, they offered to relinquish most of their territory for commercial development."

The publicity given to this court record by "RADIO" has opened the eyes of many amateurs and caused them to ask how it came about that their authorized representatives had relinquished nearly all of this territory and retained for the amateurs only narrow bands at 160, 80, 40 and 20 meters. The authorized representatives are now trying to meet the criticism directed at them. A series of articles is being printed in QST purporting to answer the question, "How did it come about that this amateur territory was given to the commercials?"

But instead of answering the question the authorized representatives are taking the position that the amateurs NEVER HAD any right to the territory below 200 meters except a band from 150 to 200. They assert that the law of 1912—the only law of the land until the act of 1927—did NOT give the amateurs the right to use the whole range of frequencies from 1,500 KC upwards. They advance as proof of their assertion the wording of the 1912 law which says that private, (amateur), stations shall not be licensed for waves above 200 meters. If these authorized representatives are right then it must have been unlawful to license amateurs to operate even on waves from 200 down to 150. And long before the 1912 law went out of existence they WERE licensed in bands at 160, 80, 40 and 20 meters. In fact, if the position now taken by the authorized representatives is right then it was unlawful to license amateurs ANYWHERE but ON 200 meters!

To claim now that "not over 200 meters" meant from 200 down only to 150 is of course too silly to talk about.

The authorized representatives of the amateurs evidently have planned a publicity campaign to meet the charge that they gave away a vast territory. They have been running short stories on the subject in succeeding issue of QST in the department they call, "What the League is Doing". In the May, 1935, issue there is, "More Ancient History", in the June issue, "Losses", in the July issue, "Ye Olde Times". These stories are what is known among advertising men as "follow-ups"—a device for clinching the mind of the reader to a specific belief. Sometimes the presumption is well-founded, sometimes not at all. Sometimes the purpose of the follow-up is meritorious, for a large proportion of the readers of magazines are non-discerning and a follow-up designed correctly to inform them is a praiseworthy plan. But when the conclusion sought to be conveyed to the mind of the reader is untrue or positively vicious then the more often the follow-up is repeated, the more widely spread and confirmed becomes the misinformation. That is the theory of virtually all advertising propaganda—reiteration of the same conclusions, whether they are truthful or not.

"Ye Olde Times" discloses in its first sentence that the author had in mind a campaign of follow-ups, all pointed at the same conclusion, namely, that the authorized representatives of the amateurs had given away nothing, but that, on the contrary, they had secured for the amateurs certain "substantial assignments" in the territory below 200 meters—which territory they say in another breath did NOT belong to the amateurs under the law of 1912. So just where does this kind of rationalization leave the amateur representatives!

Now get out the three issues of QST in question. Look at the first sentence of "More Ancient History". "We've heard some crit-

ics of the League say that amateurs used to possess all the frequencies above 1,500 KC." Just at the start the author wishes to instill into the minds of the readers the flagrant untruth that criticism of the acts of certain officers of the League is criticism of the League itself. And the author is well aware that the criticism of which he is about to speak is directed specifically at certain officers of the League, himself in particular, and not at the League itself. If any amateur ever made the ridiculous statement the author uses as his opening sentence then the author should not have dignified them with the name "critics". Nor should the author have demeaned amateur radio by publishing it in QST—unless to mislead those who are devoid of thinking processes. And I doubt if anyone was ever heard to say, "amateurs used to possess all the frequencies above 1,500 KC". Every radio man under the sun knows the amateurs did not "possess" them—for the simple reason that they never took possession of what the law had given them. So no one but an inmate of an insane asylum could have made such a remark. The amateurs COULD HAVE POSSESSED THEIR RIGHT TO THE USE of all such frequencies if their "authorized representatives" had not "relinquished most of their territory for commercial development."

"And that if the League had been on the job", continues the author, "we would still own all of the high frequencies now". Well, if the author was ever told anything so crazy as that his response should have been to call an ambulance, rather than to go into a long line of refutation and justification that is quite as silly and malapropos as the remark he quotes. All men know the amateurs ceased on February 23, 1927, to have such rights as they were granted by the law of 1912; so why would anyone but a crazy man or a child infer that under the present law the amateurs might still "own all of the high frequencies now!"

That the author of these three follow-up articles should introduce his subject with jargon so obviously contrived out of whole cloth casts discredit on all that follows. If a man has a truth to tell, or a point to make, it is the height of ineptitude to usher it in with a statement that no reasoning being could accept. The author of these articles—which are all designed to justify the actions of the "authorized representatives"—does his readers scant courtesy when he assumes that they are all boobs.

Following the specious introduction we find, "In just the same way the American Indian once owned all of North America". Oh, lay off this Indian stuff! That seems to be the pet analogy of the League officers. President Maxim told the world in QST for August, 1929, that if the amateurs "bucked" at further restrictions it would do them just about as much good as it did the Red Indian to buck the coming of the white man. The officers of the League have always broken the first law of all good publications—always to talk UP to the most intelligent of their readers, never DOWN to the least discriminating. They know that reference to the Red Indian paints a vivid picture in the minds of kids and that youngsters are likely to overlook the irrelevancy.

The Indian did NOT own the whole of
(Continued on page 35)

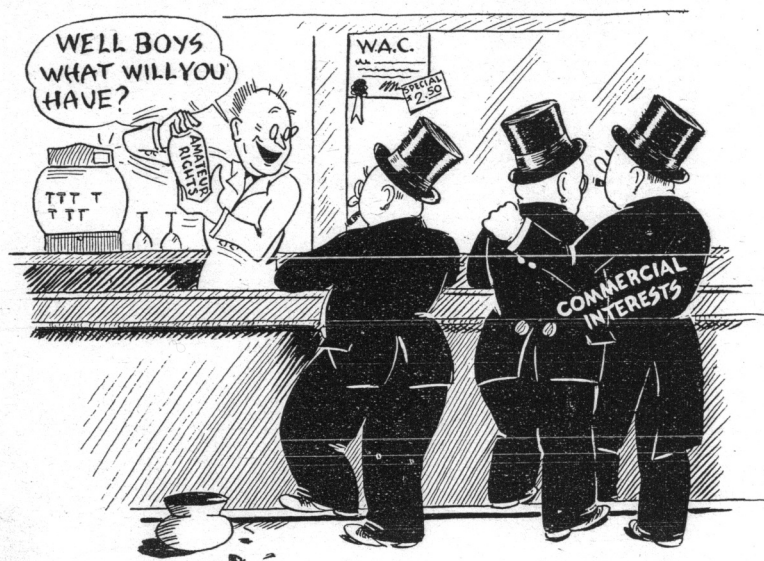

"Our Authorized Representative Shakes 'Em Up for the Commercials!"

Adventuring Hams

—Or How to Find a 5-Meter Location

By C. C. ANDERSON

● There comes a time in the life of every ham, when there is an impelling urge to do things great and different. On a beautiful spring day three hams, "Bob" Bell—W6QK, "Stan" Stokes—W6CLU, and W6FFP (that's me) set out on a great adventure. The idea was to work Fresno on 56 MC from a distant point, and two distant points were in mind, one being Moro Rock in the Sequoia National Park, the other Murieta Rocks, the famous stronghold of Joaquin Murieta, the young Mexican bandit who freely mixed his love affairs with banditry.

An old sheep-herder pal of QK's gave the directions for getting there, as follows: "Take the highway to Coalinga, and about two miles this side of Oilfields a power line guy cuts across the road. At that point, cut across the country in the direction of the rocks which are plainly visible." CLU's hoopy was provisioned, 5 meter portables were loaded into its rear, along with three trusty .22s, for who knew but that the old boy might still be living and hiding out in the rocks.

The sheep-herder's directions were followed, we galloped across the sagebrush, up and down hill across country that even the best of cow ponies would have had difficulty following. After ten miles of such travel we found ourselves on top of a knob, with a straight drop in front of us. The highway later changed into a rough dirt road which ended at a locked gate. Retracing our tracks we found a farmer who owned the lock to that gate. After much explaining and heckling the cow gentleman gave us the key and further directions on how to arrive at the rocks. The gentleman would not give us his name, for it turned out that Murieta Rocks was on his property and he didn't wish to be pestered with any more of our ilk trying to get up there. We even promised not to shoot any of his cows.

Once through the gate, the road got worse and worse, following the famous Salt Creek until Arroyo Cantua loomed before us. Soon the vision was obstructed by a great, big red bull, who blocked the road. We could peer around his quarters and see the oaks and cabin, and the gently sloping land of the Arroyo Cantua. There was no arguing with this gentleman of tobacco fame, we merely waited until he left the center of the road by his own free will.

It was on this Cantua that Joaquin's gang, with "Three-Fingered-Jack" as master of ceremonies, slit the throats of the Chinamen they had caught. We could tarry no longer, even though we wished to dream of Rosita, for our first sked time was approaching. Hence we continued our gallop up the trail to the point where the wild flowers were so thick that even QK's brawn could push us no further.

At this point we found beauty unexcelled, for each hillside was completely covered with a mass of varying colors.

Grudgingly we loaded the equipment on our backs and started climbing. After many starts and stops we reached a point on the hillside which gave us a clear shot into

Fresno at the appointed time for the first sked.

A pile of rocks looked suitable for a radio shack table. Then the excitement started, for at my feet were two fairly large rattlers. So I put the muzzle of the .22 a couple of inches from the first rattler and broke its back with the shot. By a stroke of fate it tangled the second rattler by convulsive squirmings, and soon the second rattler met the fate of the first. To make sure they were dead, each of us took

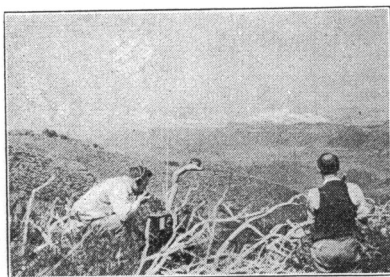

W6QK (left) and W6FFP (right) find a good location for their 5-meter set.

several shots (.22 caliber—not 90 proof). Right there we did something that has, to our recollection, never been done before—we broadcasted the first news of killing two rattlesnakes on 56 megacycles.

With no luck in contacting Fresno at this

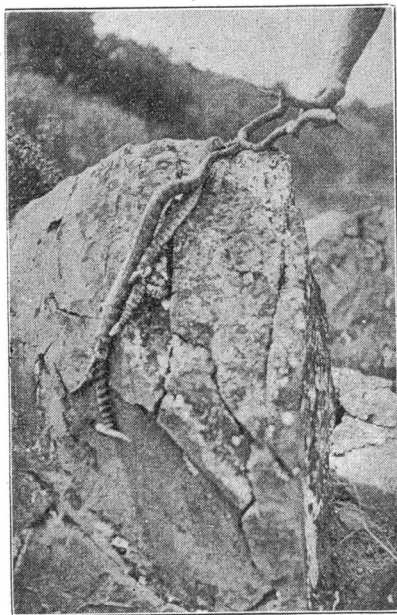

Two rattlers greet the 5-meter explorers. The story tells the rest.

point, we started on our weary climb upward, and upward. After an hour of climbing, Murieta Rocks finally greeted us.

The three domes were peculiarly suited for security and defense for Murieta, and for something Joaquin never dreamed of—a 56 megacycle transmitting location. The center dome was the highest, and from its summit commanded a view of the entire San Joaquin Valley from the Tehachapi on the south, to Stockton on the north. Murieta's lookout proved ideal for locating our rigs.

The western side of this dome was perpendicular and would not permit ascent, but the eastern side, though quite steep, could be climbed by first removing our shoes to secure a better foothold.

On schedule time, we called our heads off, but no response. Everything was checked over, we could talk from the base to the top with the other transceiver so we knew that things were working OK, but not a peep out of Fresno. The schedule ended.

Then thoughts of hidden gold caused us to explore around the base of all the domes. Heck! . . . it was in 1852 that Joaquin Murieta roamed; someone had beaten us to it!

Tired we were, yet exultant in the fact that we had done something no other ham had done before. But we felt defeated in purpose by the fact that no contact had been made after all the effort. So we started for home.

Checking up, we found that no one had kept their schedule with us.

And Another YL Got Bit! By W6FFP

● W9TSV, a new call and a new YL (YL still sounds better than OW or ex-YL to everyone), is Mrs. Mary Roth, 2132 Bingham street, Chicago, Ill. She comes from what can rightly be called "a 'ham' family."

VE5LP, ex-VE5GV, ex-VE4IS, of QRR fame three years ago, in connection with a disabled plane, and who received honor-

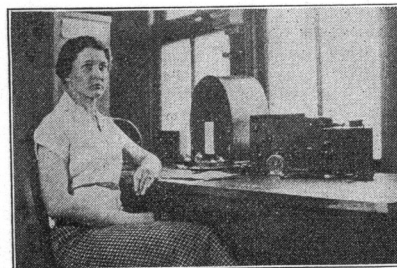

YL—W9TSV, Chicago, Ill.

able mention for the work in "QST", and "McLean's", a Canadian magazine, and who is now a commercial operator for the Canadian Airways at Cameron Bay, N. W. Territories, Canada, where the temperature is getting warmer (from 30 below at night to about zero in daytime), really started this radio family on its way. He is the

(Continued on page 21)

Interlock Crystal Control

By FRANK C. JONES

Occasionally there is a need for a crystal controlled signal from a relatively high-power amplifier where there is not sufficient buffer amplifier power available to properly drive the final amplifier. By the use of an oscillating final amplifier, a good signal can be had by means of an interlocking crystal controlled oscillator. Such signals always require careful monitoring in order to be sure that the two oscillators are both on the same frequency. The quartz crystal controlled oscillator is quite constant in frequency and thus the interlocking action tends to pull the larger oscillator into step with the smaller one. A low C, high power oscillator is rather unstable and usually has a rather ragged note when monitored in an oscillating CW monitor. The crystal oscillator has a pure CW tone and therefore it is easy to note whether the two oscillators are in step or not.

adjustment of coupling between the oscillators in order to prevent too much feed-back into the grid of the 47 tube, resulting in a fractured crystal. Doubling has the further advantage of allowing operation on 20 meters with a 40 meter crystal. 40 meter operation is obtained by means of an 80 meter crystal. The plate circuit of the 47 tube is, of course, tuned approximately to the frequency of crystal, as in any crystal oscillator. The coupling to the final stage is variable by means of a 30 mmfd. double-spaced variable condenser.

The 150T circuit is tuned up as an oscillator with enough feed-back through the 25 mmfd. condenser to allow moderate-to-weak self oscillation. Too strong self oscillation

crystal RF current within reasonable limits. It wasn't very practical. Another arrangement used a 42 crystal oscillator with its plate grounded and the cathode connected to the high power grid circuit, with a tuned circuit resonant to the crystal frequency. The 42 tube plate current was derived from the grid current of the 150Ts. This arrangement worked successfully under steady conditions, but it was impossible to primary key the power supply on the 150Ts and obtain a good note on dots and dashes. With the circuit here shown it is possible to primary key the system.

A 6A6 push-pull crystal oscillator circuit was also tested with capacitive coupling across only half of the 6A6 plate circuit, but one plate became red due to the unequal loading. A 47 pentode gave about the best results using a 500 volt power supply with a bleeder screen circuit giving about 125 volts on the screen grid. Operating the 47 at 550 to 600 volts gives better interlock at high power, but the 47 has a tendency to run away and a 40 meter quartz crystal will heat too much for normal operation. The crystal current in the circuit shown is about 85 to 100 MA with a 40 meter crystal, and from 50 to 75 with 80 meter crystals. Lower plate voltage, 350 to 400, does not give sufficient output for good interlock on the final amplifier.

The 150Ts, neutralized with link coupling to the 47 crystal oscillator, give an output of 300 watts at a plate voltage of 2,000 and plate current of 250 MA for two tubes.

The interlock system gives an output of 600 watts at a plate voltage of 2450 and plate current of 380 MA. The interlock effect is somewhat critical to maintain at this high power and better operation is obtained at plate voltages of from 2,000 to 2,200 with lower values of plate current. Outputs of more than 350 to 400 watts make it difficult to maintain good interlock for continuous keying.

Some of the readings obtained are given here. An 80 meter oscillator gave an output of 275 watts on 40 meters with 2200 volts at 200 MA with one 150T, and 400 watts at 2500 volts and 250 MA. Two 150Ts on 40 meters gave 600 watts at 2450 volts and 380 MA. One 150T on 20 meters with 40 meter crystal oscillator gave an output of 250 watts at 2200 volts and 200 MA input. Two 150Ts in parallel gave 500 watts on 20 meters at a plate voltage of 2100 and current of 400 MA. The values of plate current could be adjusted by the degree of loading, which in this case consisted of a bank of 100 watt lamps. If one listens on a monitor to a self-oscillator with lamp dummy antenna load when keying, there is no question about the desirability of crystal control. The lamps change in resistance as they warm up when keying, and thus they offer a variable antenna load as bad as a swaying antenna in a windstorm.

The crystal current ran somewhat higher in a 40 meter crystal oscillator when the latter was used to drive a neutralized final on 40 than when used to interlock a 20 meter oscillator for the same power output.

The plate tuning condenser shown has been described elsewhere in the magazine and no difficulty was had from flashover, even with no antenna load. The 25 mmfd. regeneration condenser is made up of 4 fixed and 4 moving plates, overlapping 3-in. x 3-in. when fully enmeshed. These plates are separated about a 1/2-in. and no flashover is

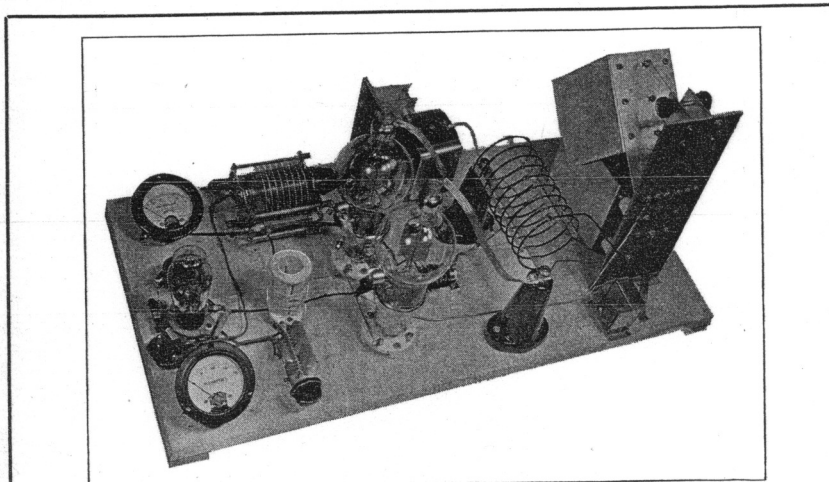

The Interlock Crystal Control Transmitter. The home-built high-power final tank condenser is at the right. The constructional details for building this condenser have been previously told in these pages.

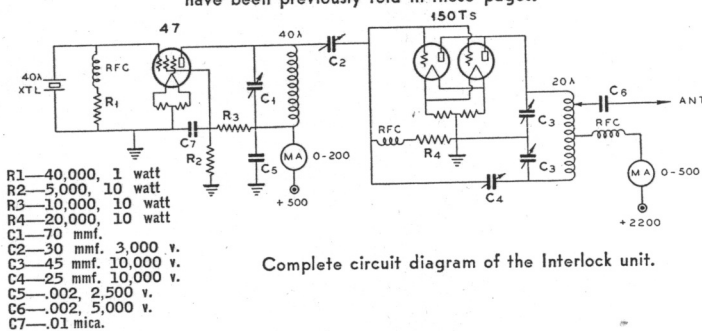

Several circuits were tested and the most successful one is here shown. A 47 pentode crystal oscillator is used to control, by its second harmonic, a high power oscillator using a pair of 150T tubes. The latter uses a Colpitts oscillator circuit with the control circuit in parallel across the grid circuit. This control circuit is at half frequency and if a low C circuit is used, it acts like an RF choke to the frequency of the final tank circuit. A low impedance circuit across the grid would prevent oscillation of the 150Ts.

By using the second harmonic of the crystal oscillator, sufficient interlock is obtained without danger of cracking the crystal. Operation at the fundamental requires careful

makes it difficult to obtain interlock with the crystal oscillator. The larger oscillator plate tank condenser is tuned to the point at which its frequency snaps into step with that of the crystal oscillator's second harmonic. The plate current of the latter will suddenly change, as will also the grid current of the 150Ts. On either side of interlock, a monitor will indicate other frequencies which have a poor tone, but at correct adjustment the tone is that of pure crystal control.

The 150Ts were run directly with crystal control in the grid circuit for outputs up to 200 watts, but great care had to be taken to load the 150Ts heavily in order to keep the

encountered. A 6500 volt variable condenser flashed over regularly at this point and a 5000 volt mica 50 mmfd. condenser became quite hot and shorted after operation of a few minutes when used as the feed-back condenser.

The inductances are of No. 10 wire for the final amplifier, $3\frac{1}{2}$ -in. in diameter and nearly 6-in. long. Nine turns are used on 20 meters and 20 turns on 40 meters. The 40 meter oscillator coil consists of 14 turns, $1\frac{3}{4}$ -in. diam., of No. 16 DCC close wound on a plug-in coil form. The 80 meter oscillator coil has 24 turns, No. 18 DSC, on a $2\frac{1}{4}$ -in. diameter, close wound.

The power supply consists of a 6000 volt 750 MA power transformer, center-tapped, working into a pair of 872A rectifiers. The filter circuit consists of a larger input inductance and a 2 mfd. 4000 volt filter condenser shunted by a 200 watt 200,000 ohm bleeder resistor. The primary circuit of the transformer has a fixed resistor of one ohm in series with it in order to reduce primary keying exciting current surges which cause key sticking, as well as a strain on the power transformer. For reducing power, several electric heater units are arranged so they can be connected in parallel with each other, and in series with the primary. The one ohm resistor must be capable of dissipating over 100 watts at high power. It is made up of electric heater replacement coil wire sections in parallel. Two 2 ohm or 3 three ohm pieces in parallel, mounted on a strip of asbestos, can be used in the primary circuit of nearly any power unit when employing primary keying.

The use of interlock control is not advis-

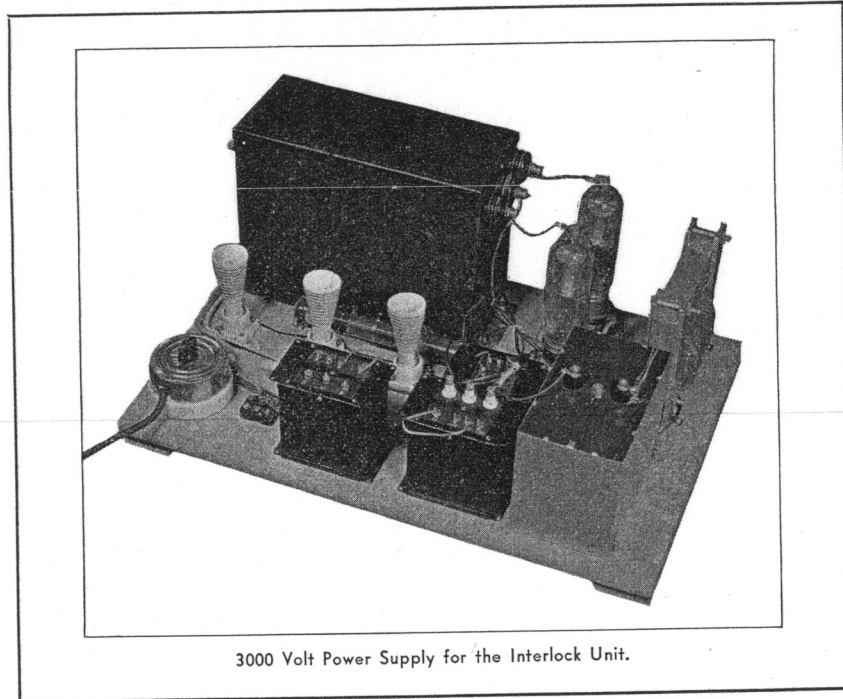

3000 Volt Power Supply for the Interlock Unit.

able for general use due to difficulty of always maintaining good interlock. However, it has certain uses where it is really

desirable, or rather necessary, in order to improve the CW note of a moderate or relatively high power oscillator.

A Portable V.T. Voltmeter

By D. B. McGOWN

● The vacuum tube voltmeter here described is useful for measurements which require a voltmeter of very high input impedance. The diode type VT voltmeter which was previously shown in these pages is suitable for most measurements except where the diode low impedance upsets the measurements. The type here shown can be used across grid circuits, or even across RF coils in some cases. Its range is from a small fraction of a volt to slightly over one volt, RMS value, or about $1\frac{1}{2}$ volts peak value. It is a peak type voltmeter.

The circuit is very simple. It uses a few C batteries for power supply in order to make the unit portable. A 0-50 micro-ammeter gives good sensitivity. The entire VT voltmeter is mounted in a card filing case about 6-in. x 8-in. x 5-in. A small bakelite panel supports the meter, rheostat and input binding posts. The UX 199 tube is mounted on brackets under the panel. The two batteries lie flat in the bottom of the case; the $4\frac{1}{2}$ volt unit supplies C bias and filament current, while the $7\frac{1}{2}$ -volt unit acts as a B battery.

The micro-ammeter has no bucking voltage system because the B battery voltage is low and a series protective resistor of 30,000 ohms is used. The latter has little effect at low readings, but tends to 'drop the plate voltage at higher values of current, resulting in a somewhat linear calibration curve of input voltage versus meter deflection. A $\frac{1}{2}$ mfd. low-leakage condenser by-passes all AC current from plate to filament, improving the detection characteristic. The meter and 30,000 ohm resistor provide a path for the DC plate current.

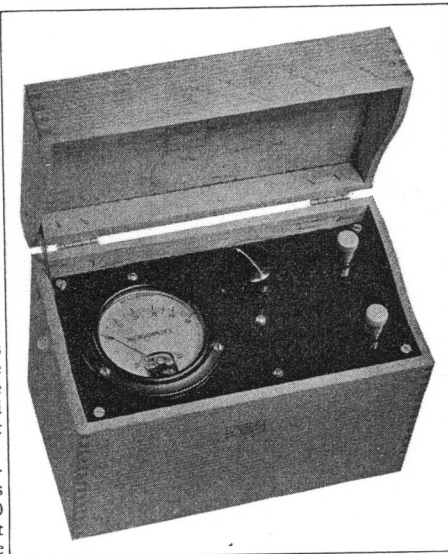

A 30 ohm filament resistor provides C bias due to filament current voltage drop across it of about $1\frac{1}{2}$ volts. A good 199 tube will act as a detector without running the filament at normal voltage because the plate current is only a small fraction of one milliampere. A 20 ohm filament rheostat al-

lows an initial reading adjustment and also provides an off-switch for the filament circuit. The rheostat is usually set to give an initial deflection of 5 micro-amperes, one main scale division on the meter. The input leads should be short-circuited at all times when the V.T. voltmeter is not in actual use.

The V.T. voltmeter can be calibrated by using a potentiometer and a low reading AC voltmeter across a filament winding of a transformer. The AC voltmeter reads RMS values; consequently $2\frac{1}{2}$ volts RMS equals 3.53 volts peak. The potentiometer can be used to impress known ratios of this voltage across the V.T. voltmeter. The actual impressed peak voltage should never exceed the bias voltage of about $1\frac{1}{2}$ volts.

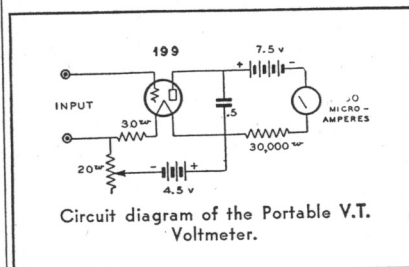

Circuit diagram of the Portable V.T. Voltmeter.

This same method can be used with higher C bias and plate voltage in order to read greater values of RF or AF voltage. In such cases, the micro-ammeter should have a bucking current with a variable resistor arranged to allow a zero meter reading at the desired initial plate current.

Sumner B. Young's Reply to W9GY

Wherein Many Heretofore Unpublished Facts Are Disclosed

EDITOR'S NOTE:

Printed here is a copy of a widely-discussed letter from Sumner B. Young to James H. Platz. The editor disapproves of some of the sentiments expressed by Mr. Young, and some of the impressions he seeks to convey in regard to his interpretations of Colonel Foster's writings. However, the letter is highly informative . . . brings many new facts to light. Both Mr. Young and Colonel Foster have but one thought in mind . . . to rid the ARRL of men whose incompetence has been proved. Comment on Mr. Young's letter is solicited.

* * *

May 14, 1935.

Mr. James H. Platz, W9GY,
659 S. Hawthorne Street,
Elmhurst, Illinois.

Dear Mr. Platz:

It was too bad that your signals hit QRM from W9LLN here on Saturday, as it was the end of a very interesting QSO. I heard you say that you have been in "Ham" Radio 12 years; and from your conversation with me over the air, I feel that you are fair-minded, and that you are well-equipped to follow a dispassionate, reasoned discussion of both sides of an argument.

Although I have been a "Ham" since April, 1913, I have only recently taken any active part in A.R.R.L. political matters and have done so only because I thought that I had something constructive to say, in a situation which, I believe, calls for high-class thinking, not hysteria.

I grew up in Boston, Mass., and my only active executive work in the League's organization in all these years was a tour of duty as "City Manager" of Boston, back in 1919 or 1920. I was active in club affairs there for two or three years, however, and was largely instrumental in forming the "Boston Executive Radio Council" to cope with the problems which arose at the time when interference with the early broadcasting stations first began to be felt, and we first came into serious collision with the B.C.L's.

We put into effect a modified "Chicago Plan" (originated in Chicago by Fred Schnell); and with the Radio Inspector and representatives from the Army and Navy and from several Greater Boston radio clubs sitting on the Board, we were able to deal successfully with the worst cases of QRM. We also carried on a campaign in the "Boston Traveler" (which opened a regular column to us) to try to obtain a certain amount of cooperation from the B.C.L's. and we also fought a City Ordinance in Salem, Mass., through a Salem newspaper. For a year or two I headed this Council, and was then succeeded by F. Clifford Estey, a well-known pioneer radio man.

About that time, I went out on the road selling oil, and my radio activities were pretty well curtailed. For a while, I had only a receiving set to fool with.

From 1917 to 1921, a number of my contributions to "QST" were published. An article on cage antennas, and one which won third prize in the contest for articles on "The Ideal Relay Spark Transmitter" became quite well known.

I had a transmitter on the air in 1925 again, and I have been "pounding brass" continuously ever since, but I have been in retirement as far as "politics" or Club activities are concerned until recently.

I tell you this because I think it will help you to understand my point of view and because I believe it will show you that I am

genuinely interested in "Ham" Radio, and that I have had contact with its problems from time to time in a practical way.

As to my attitude toward the League, I can simply state to you that I am loyal to the organization, am anxious to see it succeed, and have criticized its present management and organization only because I think they are headed wrong and that changes are needed. I am not out for anything for myself. I don't want to run for director, and I am not out to be named general counsel of the League, or to be appointed to any office whatsoever.

I have heard a great many charges brought against Mr. Weaver, but most of them are of the character which never could be proved by those who brought them. As to his honesty, I make no argument whatsoever. Fred Schnell, who lived with Warner about six years, says Warner is absolutely honest. My idea is that Fred ought to know and that his testimony on this point is good enough for me.

Furthermore, I believe that the Board of Directors of the A.R.R.L., as well as the membership at large, must share the blame for many things that have happened. Warner can't possibly be to blame for everything, nor can he possibly take credit for everything.

My criticism of Mr. Warner is based upon my estimation of his capabilities, his policies, and his personality. I think he has fallen down in many important respects, and should be removed. His personality is fair material for discussion only because he is the man who has represented us in many contacts where personalities must have been a tremendous factor in producing success or failure, and because a person in his position doubtless will continue to make many such contacts in the future. Thus, a matter which almost always is irrelevant and private becomes relevant and public.

One of the best ways to tell a story, I think, is to begin at the beginning and follow it through chronologically. This I shall proceed to do:

My recollection is that I joined the League early in 1916, and I have been a member ever since. Up until 1922 or 1923, at least, I firmly believed that the statement printed monthly in the front of every "QST" to the effect that the League numbers within its ranks practically every worthwhile amateur in the world, was almost literally true. The spirit of the organization seemed truly fraternal, and amateur opinion more solidified. The magazine was better, livelier, and more frank. It had a "sparkle."

Legislative difficulties, although present, were not very serious, nor did they have international aspects. The technical progress made, culminating in transoceanic reception, and finally (in 1924) in two-way contact, took everybody's breath away.

How was it that Warner seemed to fit into that picture during this period?

I met Warner for the first time at Worcester, Mass., in the fall of 1919, at the first "Hamfest" held in New England after the re-opening of transmission after the war. He had just been named editor. At that meeting he spoke, and he made a poor impression on me and on some of my acquaintances. We set him down as perhaps a capable editor, but as a poor "mixer" and an absolutely impossible speaker. As to his ability to handle legislative problems we had no inkling, except that we felt he was no lobbyist. But legislation wasn't the foremost problem, anyway.

Subsequent experience led the gang around Boston to dread the appearance of Mr. Warner

at conventions. I remember one ghastly incident when Warner spoke before about 350 people at the M.I.T. in Cambridge, Mass., and spoke on and on, in a flat, weak voice that couldn't be heard six or eight rows back, while Dr. Alexanderson, inventor of the Alexanderson high-frequency alternator and principal speaker of the evening, fidgeted around in his chair and the audience became more and more restless and resentful.

After a while we requested other H.Q. representatives than Warner to attend our gatherings, and Warner soon saw the light, and retired from the job of trying to make contact with the "Hams." A field-man did this, or some available man in Hartford was sent out.

Now, this was unfortunate, because Warner lost direct contact with the "Hams," and the "Hams" to a great extent lost contact with the man who gradually assumed most of the executive powers of the League.

What happened in other sections of the country to bring this situation about I don't know, but my guess is that similar incidents, leading to the same results, happened elsewhere.

Warner's salary was unknown, the details of administration at H.Q. were more or less unknown, directors were not elected on the present basis until about 1924, "QST" was a "sure-fire" proposition because it had many exciting technical developments to record, and because advertising space was plentifully bought by firms which were anxious to develop an expanding amateur market. Amateurs gradually began breaking up into groups determined by the wave length they operated on, and there was nothing to focus attention on Warner's personality, or on his editorial or executive abilities, to any great extent. The "Hams," too, began paying less attention to the League.

In 1924, however, one director, who, I believe, was the New England director, "went to the mat" with Warner about his salary contract, as it was quite obvious to this director, and subsequently to the Board, that this contract was improvident as far as the League was concerned, and that Warner was getting too great a proportion of the League's income. He was then getting part of the profits of "QST" and 25c on each new membership, plus a rather nominal salary besides. In 1920 he had somehow maneuvered things so that every subscriber became a member of the League, thus abolishing the old distinction between members on the one hand and subscribers on the other, and thereby increasing his commissions very materially. Warner was very hard to deal with. I have been told that the Board finally presented an ultimatum to the effect that they would disband the League rather than to allow the situation to continue, but I have never been shown detailed proof of this.

However, none of this got out to the general membership. I never heard of it until 1934, and I'll postpone telling you what my reactions to this then were. I believe this was Warner's first serious clash with the Board and that it had important effects on him.

The League "went Democratic" back in 1924 and my guess is that Warner believed that both the directors and the membership henceforth would require special handling as directors were now to be elected by members. Consciously or unconsciously, I believe that he swung around to the idea of censoring news in "QST" and telling directors and members only what he thought was good for them. This was pretty easy to do. The Board met only once

a year, and lived on Warner's letters meanwhile. He had absolute charge of "QST." The membership was not very vocal or very active in politics. Even directors' elections failed to bring out many votes. Look back at your old "QST's" if you want to check on this.

I can't furnish you with conclusive proof that Warner sought to influence the Board and to keep the membership at large quiescent, but I think the probabilities are with this conclusion. Warner always entertained the Board when they met at Hartford, and took them around to his house. I have seen a circular letter to board members (shown to me by Director Jabs) urging board members to disregard the instructions of their divisions and to vote according to their own convictions in circumstances where they thought it was the statesmanlike thing to do, and as early as 1927 I had personally gained the impression that both sides of important questions no longer were freely discussed in the pages of "QST," that the human-interest news, and reports from the Divisions were being cut to the bone; that the warmth and "sparkle" had gone out of "QST"; that the "Hams" themselves were no longer contributing the majority of articles for publication, and that the magazine was being "ground out," month by month, by rather uninspired technical editors. It looked to me as if H.Q. had settled down to the publishing business, and had gained the idea that they wanted no advice, because they knew what was good for the Amateurs anyway.

In 1927 I got rather a nasty jolt out of the results of the Washington Treaty. I wondered at the time if we hadn't been "leaning on a broken reed," as the saying goes, when we had relied largely on Warner to represent us there. You see, my impressions of the man had long since led me to believe that he would be out of his depth in such a situation.

(Recently I learned that just after the 1927 debacle Warner circularized the directors again, advising them strongly against making an attempt to put through a Senate reservation to the treaty, reserving to U.S.A. Amateurs a larger 40 meter band, although admitting the possibility of obtaining such a reservation at that time. Had I known of this in 1927 I would have been even more disturbed. A timid attitude in such matters won't get us anywhere.)

Then in 1932, I got another jolt, which made me believe that headquarters was out of touch with realities, when nothing could seem to be done about stopping W9USA's plans to set afloat great masses of traffic which could not possibly be handled. I visited H.Q. in West Hartford and talked with Budlong, Handy and Lamb; and I told them what would happen, but to no avail. I saw a big, elaborate and evidently costly H.Q. set-up, and remember wondering at the time whether it wouldn't be better to fire some of the technical editors and try to get the "hams" back into the habit of writing the bulk of their own magazine articles, by offering them at least nominal pay for accepted stuff.

But it was the Madrid affair that finally snapped me into action.

The result of that Treaty was to put an end to Trans-Pacific traffic, which was the only worthwhile amateur relay traffic we ever developed; yet Warner came home in triumph, and reported "no material change." I couldn't swallow that.

My examination of such facts as I could reach, convinced me that Warner and Segall had gone to Madrid after having made a deal with the American delegation that the amateurs would ask for no more frequencies, and that, in return, the delegation would give the amateurs full support. (This has never been denied).

I found, too, that back in February, 1928,

Warner had publicly announced in "QST", on page 15, that the Washington Convention forbade third party international messages "except by special arrangements between nations", and had thereby put himself on record as acquiescing in an unfavorable interpretation of a clause in that treaty which could bear another, and more favorable, meaning. As events later turned out, the United States Government was more lenient than our own "spokesman", in interpreting the Washington Treaty and applying it; but Mr. Warner probably found his hands tied when he got to Madrid, and found himself in a poor position to object to a redrafting of the clause in question so as to remove all further possibility of lenient interpretation from it, because he would then be forced to take the stand that his interpretation of February, 1928, had been wrong.

In any event, he came home and reported "no material change", thus vindicating his 1928 judgment, but not putting the membership of the League in possession of the material facts, and allowing them to make their own estimations.

This, I am frank to say, made a very bad impression on me, and I decided to look around and see what I could discover as to the state of League affairs in general.

I soon found that the League was not doing so well on "QST"—losing money, in fact—and that it was living very largely off of revenue from the "Handbook". I also found that League membership had increased only for a total gain of 500 or 600 over a period of about 5 years; that "RAIO" and "R/9", on the other hand, were able to make progress in spite of the depression; and that in those 5 years the number of licensed "hams" had increased enormously.

By talking with (and writing to) people who had been at headquarters in subordinate editorial capacities, I also learned that headquarters, as run by Warner, was not a happy place; that he was hard to work with; and that he had a positive talent for tactlessness and for making enemies. Several rather serious and fundamental criticisms of his editorial policies were made, as well. I discounted these revelations as a matter of precaution, but I was still left with a strong impression that things were in need of a change—that the Board should do more directing, and that the membership should be aroused from an unwarranted complacency.

Well, the net result was my speech to the Des Moines "ham" convention in April, 1934. Please get hold of a copy of the May, 1934, "RADIO" and read it. It represents the best advice I was capable of mustering after a long period of thought. I still hold to the same opinions as there expressed. If you can't locate a copy, please let me know, and I'll try to dig one up; for that speech, I believe, explains me, and explains why I think the way I do, better than anything else.

It deals with what I found out about Warner's plan to allow the 5 and 10 meter phone bands to be occupied by persons having no code knowledge, for one thing. It also records my suggestions for improving "QST" and for strengthening the League. (Some of these have been acted upon, by the way, with favorable results).

There was a big "explosion" at Des Moines, centered on Warner, the 5 meter scheme, the "N-prefix" case, and general dissatisfaction with the existing state of affairs. The shock went clear through to Hartford; and the next evening, Maxim addressed the banquet at Des Moines by long-distance phone connected to the public-address apparatus; and among other choice "gems", said that—"critics of the League were after one thing and one thing only—the surplus of the League"

That made him many enemies, and certainly didn't endear him to me, either.

I telegraphed him that since he had given Warner his warm public support, I would like copies of all of Warner's salary contracts, with figures on Warner's revenue from the League year by year. Maxim replied that he would send the dope along in a day or two. Then Maxim wrote me to make my request through my director, Carl Jabs, "in the interests of proper administration." Jabs forwarded my request by wire. Back came a letter to Jabs from Maxim saying that he refused to order the data to be collected before the Board meeting (May, 1934), and that evidently Mr. Young was out to prove something that didn't exist; that the accounts had all been audited, yearly, by C.P.A.'s, and that it was up to Jabs to decide whether or not this information should be furnished me. When Jabs got to Hartford, he had to sit up half the night, after a Board meeting, to get the data requested. He and Warner went to the office and dug it out of the books. A pretty piece of side-stepping had at last failed.

That data was subsequently published by Col. Foster, to whom I sent it. I am not responsible for the interpretation he puts on it. My own interpretation differs from his. Look back in "RADIO", if you are interested to examine his views.

My own reaction to Warner's salary history is, that it shows a highly-developed acquisitive instinct. His maneuvering to abolish the distinction between members and subscribers, back in 1920, manifests the same thing; and it was to the advantage of nobody but Warner, and to the distinct disadvantage of the League. I blame the directors, in both instances, more than I blame Warner, for letting him get away with this. Probably the Board passed, without question, the usual resolution ratifying the acts of executives and agents for the previous fiscal year, at the next annual meeting.

Both salary and membership-change incidents are devoid of dishonesty, so far as I can see.

Following the Des Moines incident, and the Maxim correspondence, Fred Schnell, former traffic manager of the League and an old friend of mine, called on me in Minneapolis. (He was out here lecturing for Grunow Radio, explaining short waves to the dealers).

Fred told me that Warner meant well, and that he was honest; and that he liked Warner personally. However, he said he would be damned if he would ever work under him. The traffic manager, you know, isn't under Warner, but reports directly to the Board. Fred told me that when he was living with Warner, Warner actually tried, over Fred's protest, to get the Board to subordinate Fred to him. Schnell told Warner and the Board that he would immediately resign if this went through, and the Board "laid off." But this illustrates Warner pretty well, I think.

Schnell also told me that Warner hadn't been out on the road for years; and that he was going to tell Warner, flatly, that Warner would have to get out and spend at least a year riding the trains and contacting the "hams", or "his goose was cooked", because his "stock" with the "hams" was running low, all over the United States.

This led, eventually, to Warner's recent "contact-trip" through the Middle-West. Neither Fred nor I thought Warner would ever make it.

Then I had some correspondence with Maxim, urging him to have a "census" made of the number of licensed "hams" in the League, in order to settle, once and for all, what the facts actually were. I had taken no stock in the story that only 20% of the members were "hams", although Schnell had said that in the course of a Board meeting, and it had been recorded by the stenographer. I did believe, however, that there were more "hams" outside of the League than in it. The

(Continued on page 32)

W6HYB

-A Variactor Controlled-Carrier Phone With 1 Kw. Class B Linear Amplifier

By W. E. (EDDIE) SWARTOUT*

● Radio amateurs everywhere are discussing the newer systems of controlled carrier modulation. Nightly the air is filled with technical QSOs regarding the relative merits of the various systems which have been publicized in recent months.

The equipment for converting standard phone transmitters into those which use carrier control is just now coming into the market, and already a considerable number of medium-power controlled carrier phones are heard in the amateur bands.

Content with nothing less than the maximum power allowed by law, and striving to get as much out of a transmitter as a limited pocket-book would permit, the writer began a series of experiments with the Variactor method of carrier control. The results have been highly encouraging; a 1 KW controlled carrier phone with class B linear amplifier is now on the air at W6HYB. Reports from listeners indicate that the quality of speech is excellent. The "R" reports, within a radius of 2,000 miles, have been "seven up". K7AO, Port Hobron, Alaska, approximately 3,000 miles from San Francisco, reports an R9 signal from W6HYB during a one-hour, 100% QSO. Conditions in the 75-meter phone band have not been very good during the summer months and it is with difficulty that San Francisco stations are reaching into the middle west. Yet W6HYB has received a report of QSA-4, R7 from another amateur phone in Kentucky. No tests on the 20-meter band have been made.

To begin at the beginning, W6HYB is the former W7BB, W7GM of Portland, Oregon. The W7 call letters were relinquished some six years ago because of a change in QRA to San Francisco.

The controlled carrier phone now in use consists of a Les-Tet 2B6 oscillator, RK-18 class C modulated amplifier and a linear amplifier in which two 150T tubes are used. The illustration of the linear is shown on the front cover of this magazine.

The antenna is a single wire fed Hertz, 118 feet long, 55 feet high at one end and 50 feet at the other. The antenna is fed from a tuned tank which is link coupled to the final amplifier. The single wire fed antenna is worked against ground across part of the antenna tuned circuit. This additional tuned circuit prevents radiation of illegal harmonics, without appreciably reducing the fundamental output from the final amplifier. This method allows the push-pull stage to work very efficiently because there is no unbalance in the push-pull stage itself. The antenna tank coil (L7 in the circuit diagram) consists of 22 turns of $\frac{1}{8}$ -in. copper tubing, $4\frac{1}{2}$ -in. in diameter, spaced $\frac{1}{8}$ -in. between turns and tuned with a 35 mmf. variable condenser with 1-in. spacing between plates. The coupling link consists of three turns around each coil . . . the link coupling at the antenna coil being at the grounded end of the coil. The coupling loop is made of No. 12 rubber-covered wire. The coupling around the final tank at the transmitter proper has three turns, wound around the center of the plate tank coil.

* 3055 - 25th Ave., San Francisco, Calif.



W6HYB—W. E. (Eddie) Swartout at the Mike.

The tuning procedure for the linear amplifier begins by adjusting the grid circuit for maximum mills by means of a constant tone applied to the audio channel of the class C modulated amplifier. Neutralizing is done in the conventional manner with the aid of a meter in the grid circuit. After the final is neutralized, plate voltage is applied and the circuit tuned to resonance.

The final is tuned to the antenna as follows: Before connecting the antenna to the final, apply voltage to the linear amplifier and then tune the tank circuit to resonance,

as indicated by maximum dip in plate mills. Then clip-on the link circuit to the antenna coil and apply the constant tone to the speech channel. Tune the antenna tank condenser for peak output, as indicated on a 0-2½ RF ammeter. Then go back and trim-up the final tank condenser for maximum dip in plate mills.

The Linear Amplifier

As its name implies, a linear amplifier is used to increase the modulated carrier output to the antenna circuit. In order to obtain linear operation, this amplifier is biased slightly below cut-off. For the transmitter here described the bias is approximately 180 volts, secured from B batteries.

The filter system in the power supply for the linear amplifier is rather a skimpy one, using only 2 mfd. of condenser and approximately 15 henrys of choke. The smoothing effect of the condenser seems adequate for this amplifier, but additional filter will soon be added.

The "swamping resistor" which is connected across part of the turns of the grid tank coil in the linear amplifier has the effect of dissipating about one-third of the output of the class C modulated amplifier which drives the linear. This method provides a more constant load to the modulated class C stage than would be given by the grid circuit of the linear stage itself. The swamping resistor is a 5,000 ohm Ward-Leonard "plaque" type, rated at 25 watts. This is a non-inductive resistor, available in various sizes.

The load can be varied by the position of the taps on the grid coil; however, the resistor should be connected at the points on the grid coil where best results are secured. First note the grid mill reading without using the resistor, then clip on the resistor at a point where the grid mills are decreased by about one-third to one-half of that indicated when the resistor is not connected. In practice it is found that about one-third of the output of the class C amplifier dissipated is approximately the correct value for proper operation. Additional loading is needed to bring the load impedance of the modulated amplifier to the proper value, and for this reason the resistor is used.

When the linear amplifier was first adjusted, and when an RF choke was used in both grid and plate circuits, it was found that it was impossible to keep the linear amplifier stable in operation at cut-off bias.

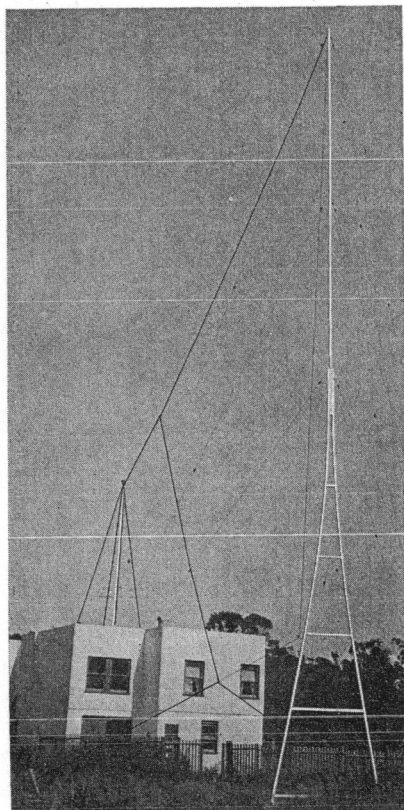

The Antenna at W6HYB

The linear would take-off at the slightest provocation. So the grid choke was shorted out and the amplifier then acted in a normal manner. It is suggested that a choke of widely dissimilar characteristics be used in the grid circuit from that in the plate circuit, if a similar experience is encountered by other amateurs. Try eliminating the grid choke entirely; if the linear operates satisfactorily leave out the grid choke. If the linear amplifier is so constructed that everything is symmetrical to ground, and if the nodal point of the grid coil is at the tap-off position, the grid choke is not required.

Buffer and Class C Amplifier

The crystal oscillator uses a 2B6 tube in the conventional Les-Tet Exciter circuit. The layout of parts in the oscillator is important. The unit is not shielded. It operates with 200 volts on the crystal and 450 volts on the buffer section. For 75-meter operation the buffer section is neutralized, operating as a straight-through amplifier, and 35 mills of grid current can be secured from a 75-meter crystal when working straight through into the grid of the RK-18. When doubling to 20 meters, 25 mills (maximum) grid current is obtained. The proper arrangement of the components in the oscillator is clearly shown in the accompanying illustrations.

An RK-18 triode is used in the class C modulated amplifier. This tube has a rated plate dissipation of 35 watts. It operates at a maximum of 750 volts. The neutralizing condenser is of very low capacity, only 10 mmf. A standard 3-plate Hammarlund double-spaced midget is used for neutralizing. The plate tank condenser is a 75 mmf. per section, split-stator, double-spaced Cardwell.

Condenser Mike and Pre-Amplifier

A condenser mike is used with a pre-amplifier of the type designed by W6BHO. However, a few minor changes in the circuit diagram were made so as to completely eliminate RF feed-back. As the circuit diagram shows, resistance coupling is used with cathode resistor bias. The voltage for the condenser mike head is taken off of a voltage

(Continued on page 23)

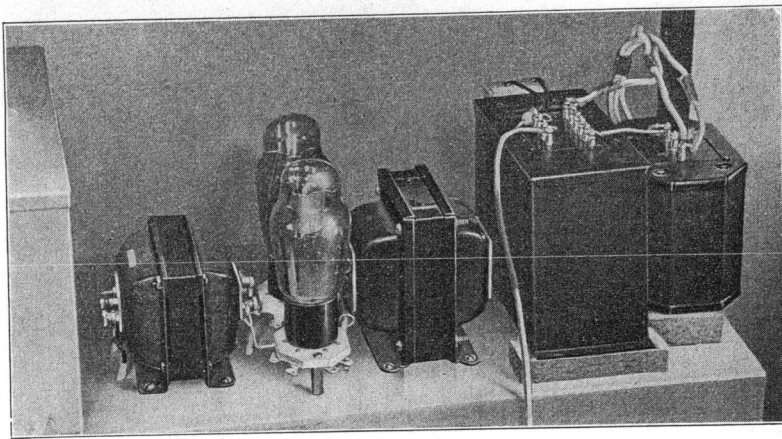

The Audio Channel, showing Variator and Autotransformer.

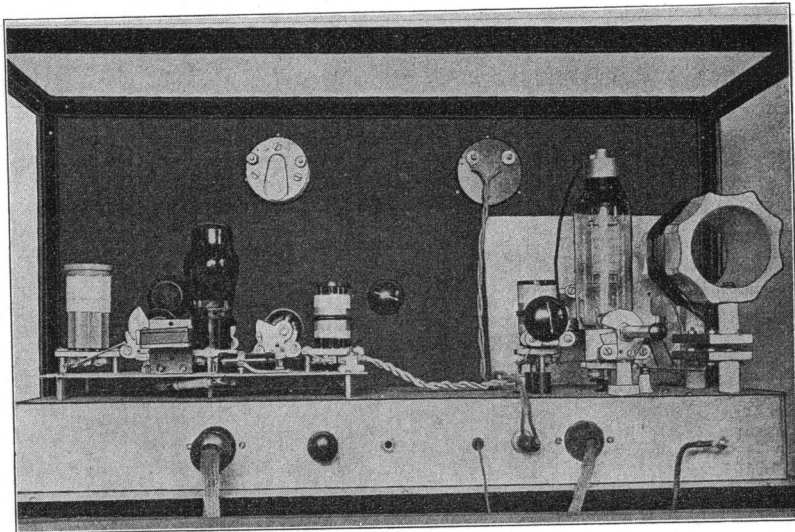

Les-Tet 2B6 Exciter and RK-18 Buffer Stage

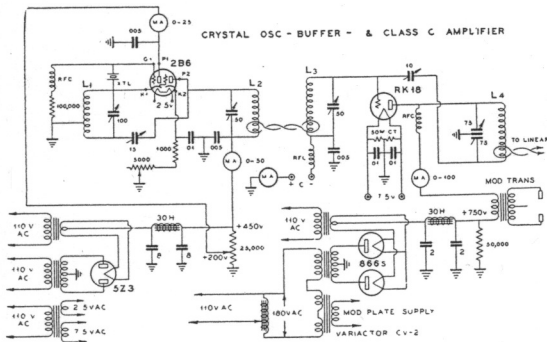

Legend for RF Unit
 C1—100 mmf.
 C2—15 mmf.
 C3—50 mmf.
 C4—50 mmf.
 C5—10 mmf.
 C6—75 mmf. per section.
 L1-L2—see text.
 L3—35 turns, No. 20, 1 1/4" dia., for 75 m.
 L4—21 turns, No. 16, on 2 1/2" dia., for 75 m.

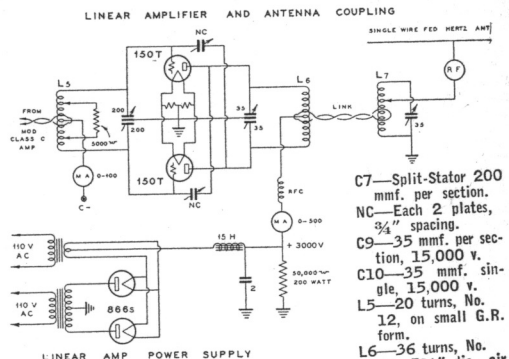

LINEAR AMP POWER SUPPLY

C7—Split-Stator 200 mmf. per section.
 NC—Each 2 plates, 3/4" spacing.
 C9—35 mmf. per section, 15,000 v.
 C10—35 mmf. single, 15,000 v.
 L5—20 turns, No. 12, on small G.R. form.
 L6—36 turns, No. 12, 5 3/4" dia., air spaced.
 L7—22 turns, 3/8" copper tubing, 4 1/2" dia., air spaced.

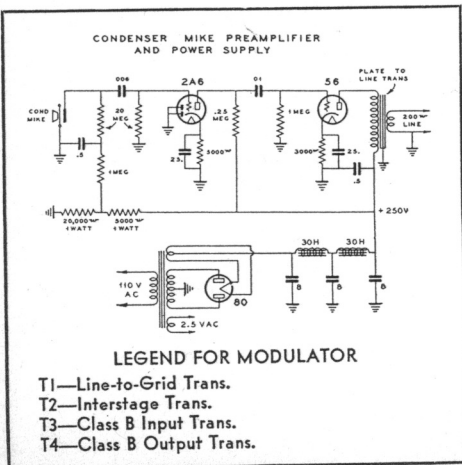

LEGEND FOR MODULATOR
 T1—Line-to-Grid Trans.
 T2—Interstage Trans.
 T3—Class B Input Trans.
 T4—Class B Output Trans.

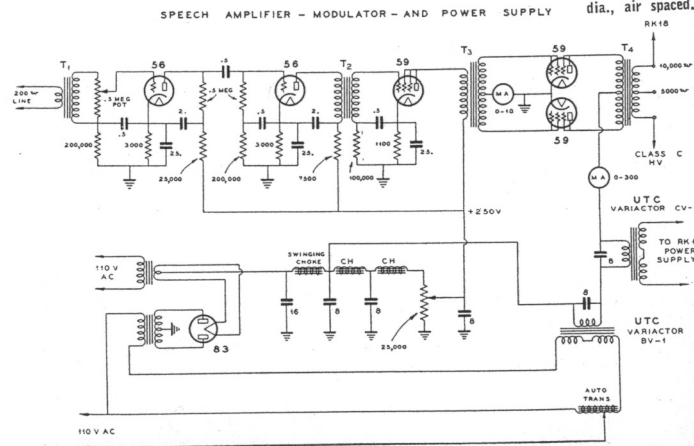

Half-Killowatt C. W. Transmitter Using Type 211 Tubes In Push-Pull

—And Some Suggestions for Building a Better Breadboard Transmitter.
Also Data on Running-down Parasitics--Link Coupling Hints
--Tuning Procedure.

By FRANK C. JONES

● This transmitter is straightforward in circuit design and is laid out in breadboard fashion. It will put out a 500 watt CW signal in the 40 meter band when used with a suitable power supply. Breadboard construction simplifies the work of building such a set and tends to give higher efficiency than a set built into a metal frame or cabinet.

The oscillator uses a 6A6 twin triode tube with one section oscillating on 80 meters and the other section doubling to 40 meters. With 400 volts on the 6A6, sufficient output is obtained on the second harmonic to drive a pair of type 10 tubes to approximately class C operation as a buffer stage. The latter provides more than ample output to drive the pair of 211 tubes in the final amplifier. This arrangement eliminates one or more doubler and buffer stages, which means more reliable operation over a long period of time.

The oscillator has been fully described in these pages, although a 53 tube has generally been used. The 6A6 is identical except for the heater voltage which is 6.3 instead of 2.5 volts. The 6A6 heater can be operated from the $7\frac{1}{2}$ volt filament supply by connecting a 1 or $1\frac{1}{2}$ ohm 10-watt resistor in series with one side to drop the voltage to about 6.5 volts. This oscillator uses cathode resistor bias and capacity coupling to the doubler section. The coupling condenser can be either a fixed 50 or 100 mmfd. mica, 1000 volt, condenser, or a 100 mmfd. midget variable condenser. The variable condenser, of course, allows optimum adjustment for any particular quartz crystal and is sometimes an aid in keeping the tube cathode current below 80 milliamperes. A fixed 50 mmfd. condenser is used in the transmitter herein described in order to simplify adjustments.

The cathode resistor and doubler grid leak are 1000 ohms and 25,000 ohms, somewhat higher values than those used in previous sets. These values permit operation at plate voltages of around 400 volts, or even higher, which is desirable for driving a pair of type 10 tubes. If the 6A6 tube is operated at 300 or 350 volts, the cathode resistor can be approximately 400 ohms, and the doubler grid leak about 15,000 ohms, for maximum output. These lower values will tend to run the cathode current of the 53 or 6A6 tube excessively high at 400 or 450 volts plate supply. The plate voltage is taken from the 600 volt plate supply through an adjustable resistor which can be adjusted to give about 400 volts. The actual value of this resistor is about 3000 ohms, if the plate supply voltage is 600.

The oscillator, doubler and type 10 grid tuning condensers are all of the single spaced, midget type. The type 10 neutralizing and plate condensers and 211 grid condenser are of the double spaced midget type. All of the condensers are mounted on small standoff insulators with short aluminum brackets to hold the condensers in place.

Lockwashers should be used to prevent the condensers from swiveling around on top of the insulators. The brackets can be extended down and fastened to the oak baseboard, thus eliminating the use of the stand-off insulators, with no appreciable loss in efficiency. The insulators give the transmitter a better appearance, but good dry hardwood is also a good insulator at moderate voltages.

The type 10 stage is an ordinary push-pull RF amplifier with link coupling input and output. At 600 volt power supply it will drive 50 MA of grid current through the final stage in actual operation on full load. The link coupling consists of one turn around the center of each coil, except the link to the doubler stage which should be around the plus B end of the coil. If the link

coupled coils are close together, it is desirable to try reversing the link coupling turn so that it aids the direct electromagnetic coupling between the two large coils. Shorter grid and plate leads would be desirable because long leads sometimes cause parasitic oscillation in push-pull amplifiers at a very short wavelength between 2 and 4 meters. A good test for this parasitic is to remove the crystal oscillator and apply reduced plate voltage to the following stages, one at a time. Parasitics can be checked with a small neon lamp, or by noting the action of plate and grid milliammeters. Parasitics could be found in the 210 stage of this transmitter at high plate voltage when the grid leads were about 2 inches longer than those shown.

The 10-in. x 6-in. x 12 ga. aluminum shields are not essential for CW operation but their use is desirable to prevent feedback into lower power stages, especially if the RF unit is to be used for phone operation. The aluminum shields should be

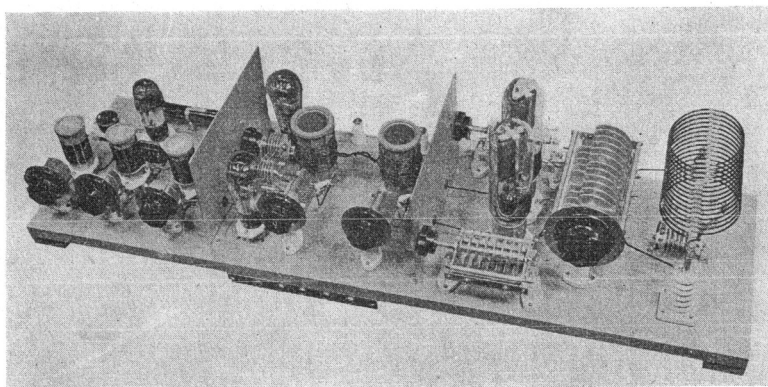

R.F. portion of Breadboard $\frac{1}{2}$ k.w. Transmitter using 211 tubes in final.

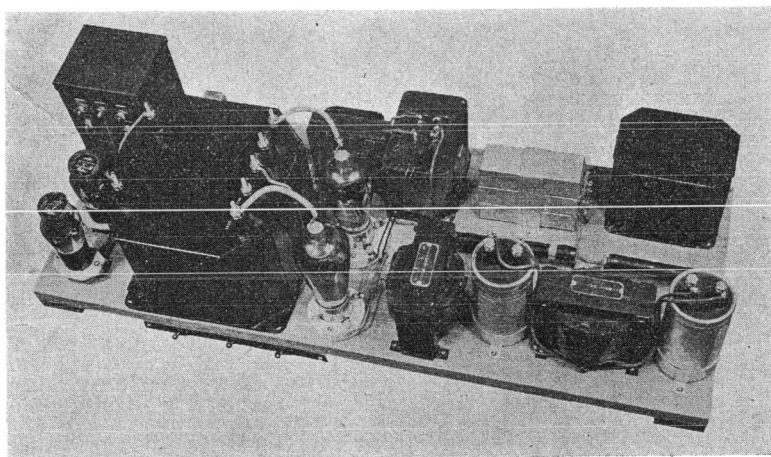

Power supply for above R.F. unit.

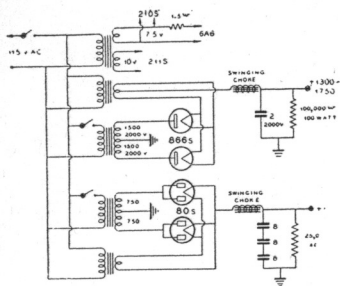

Power Supply for 1/2 k.w. Transmitter

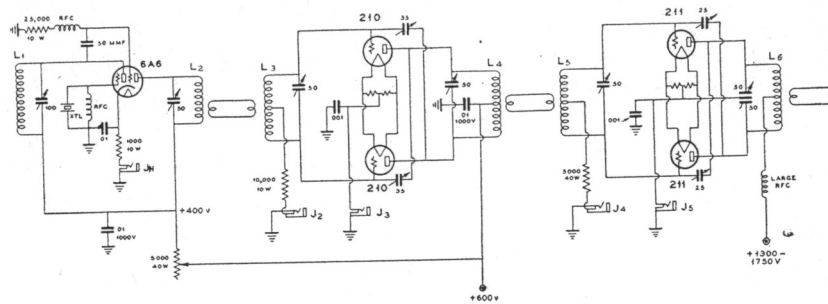

Circuit diagram of the R.F. portion. See text for Coil Winding Data.

grounded to negative B. The extra filter condenser and choke shown in the picture of the power supply are necessary for phone operation, but not for CW, as shown in the circuit diagram.

The baseboards are made of 12-in. by 1-in. oak with cleats under the ends. This enables some of the wiring to be run under the breadboard, and a few resistors and condensers can also be mounted out of sight. The power supply base is 12-in. by 30-in. and the transmitter unit 12-in. by 40-in. The aluminum shields are placed so as to shield the 10 stage grid circuit from the plate coil, and the 211 grid coil from its plate coil. The five current measuring jacks are mounted on a narrow strip supported to the lower edge of the baseboard. Filament and power leads are made to terminals along the back of each baseboard. The three AC power switches are also mounted on a narrow strip underneath the edge of the baseboard. These switches allow the plate voltages to be turned on after the filaments have first been given an opportunity to light.

The final amplifier uses a pair of 211 tubes in push-pull with a low C output circuit using a split-stator condenser. The spacing between adjacent rotor plates is approximately a half inch, and each section of the condenser has a maximum capacity of 50 mmfd. The final tank coil is of No. 10 wire wound on celluloid strips and is arranged for quick change by means of plugs fitted to the coil jacks on the tops of 3-in. insulators. Antenna coupling can be made by means of split coils for a Zepp antenna, inductive coupling to a tuned antenna coil, or preferably by means of link coupling to a tuned antenna coil. 2 to 3 turns of No. 12 rubber covered wire around the center of this coil connected through a twisted-pair of the same wire to a 2 or 3 turn link around the antenna coil is suitable. An end-fed antenna, single wire feed or Zepp antenna can be used in this manner and the extra tuned circuit tends to eliminate illegal radiation of harmonics. If a twisted-pair feeder is used to the antenna, usually about two turns, at 40 meters, around the final amplifier plate coil will provide suitable coupling.

The tuning-up procedure is fairly simple. The filament voltages should all be checked and the 866 tubes should be run for a half hour, if new, to bake out mercury from the cathode surfaces. The 600 volt supply can then be turned on, after an open plug has been inserted into the type 10 filament center-tap current jack. The oscillator will read not over 20 MA if not oscillating, and up to 80 or 100 MA if oscillating. The oscillator tuning condenser should be set so as to give maximum output as indicated by a neon lamp or a flashlight lamp and a turn of wire. Then the doubler coil can be tuned to resonance, as indicated by a dip in the cathode current, provided the following grid coil is not connected. The 6A6 cathode current should be adjusted to be not over 70 or 75 MA. The link coupling can then be adjusted for maximum transfer of

power to the grid coil by the use of a neon lamp indicator. The open plug prevents a reading of grid current because it is in the center-tap lead to the 10 tubes. After this grid coil is tuned to resonance the plate coil can be tuned so as to give an indication with the indicator lamp (or a coil and TC galvanometer) of the current in this plate coil. The neutralizing condensers should then be adjusted to balance-out this plate coil current.

After neutralization, the open plug can be removed and the plate current of the '10 tubes measured for different amounts of link coupling to the final stage. With a 600 volt plate supply, this plate current should be about 110 to 120 MA under load, and the grid current of the final about 60 to 70 MA with the final neutralized but with no plate voltage applied. This grid current will drop to about 50 MA under load on the final. 35 to 40 MA is sufficient current through the 5000 ohm grid leak for efficient operation; however, a little improvement is noticed with 50 MA.

The plate tuning on the final should be made for greatest dip of plate current without antenna load in order to be sure that the correct values are used for the coil turns and tuning range on the tank condenser. The antenna load should be adjusted so that at least 300 MA is drawn on the final. Upwards of 400 MA seems to place no strain on the 211 tubes. This actual value of plate current is the value as read on the C.T. jack, less the amount of grid current, because this meter jack reads both values simultaneously. The output with 1500 volts plate supply runs about 500 watts.

Some readings were taken by using a series-parallel bank of 100 watt lamps as a dummy antenna. This dummy antenna was coupled by means of 3 or 4 turns of wire wound around the center of the final tank coil. The oscillator cathode current read 65 MA, the buffer plate current 115 MA, the buffer grid current 13 MA, the buffer plate voltage 600 volts, and oscillator plate voltage 400. These values were maintained in all of the tests and the grid current on the final was from 40 to 60 MA at all times under load, usually about 50 MA.

At a plate voltage of 1200, the actual plate current was 325 for a certain degree of dummy antenna coupling with an input of 390 watts. As near as could be observed, the output was about 275 watts, because three 100 watt lamps were illuminated nearly to full brilliancy.

At 1400 volts the plate current was 350 MA and the output 400 watts. At 1600 volts and current of 390 MA, the output was a little over 500 watts. The output and plate current could be varied over a wide range for any given degree of antenna coupling.

At 2050 volts plate supply, from another power supply using 872A rectifiers, the plate current was about 500 MA, practically 1 KW input. The output was sufficient to light

eight 100 watt lamps at an estimated output of between 750 and 800 watts.

Just to see if these particular 211 tubes could be blown up, 2500 volts at 500 MA was impressed on the final stage. Ten 100 watt lamps were brightly illuminated when used as a dummy antenna, but rather careful tuning of the plate tank condenser was required in order to prevent a sort of motorboating effect. At the end of some two and three minute tests, the plates of the 211s showed no apparent color in a well-lighted room.

The 211 tubes used in this transmitter* have a special type of construction for the leads through the stem, and undoubtedly they will stand more plate voltage than most types of 211 tubes. 211 type tubes should not be operated at over 1700 or 1800 volts plate supply on CW and, of course, much less for phone operation.

For phone operation the power supplies should have very little AC ripple. The 600 volt supply has a 7 volt AC ripple which is a little over 1%. This is allowable on the '10 stage and the addition of 4 mfd. across the 400 volt leads to the crystal oscillator brought the ripple down to less than .2%. The filter choke on this 600 volt supply was a 250 MA choke, rated at 30 henrys and rather oversize, which was found desirable in order to avoid the use of an additional section of filter.

The high voltage supply under a 400 MA load had a 12% ripple for CW and about 1.5% for phone when an additional section of filter was used, as shown in the photograph but not in the circuit diagram. These values are satisfactory for amateur use if the crystal oscillator supply is well filtered.

Primary keying can be used on the 211 stage or center-tap keying will also be satisfactory. If the latter is used, a key click filter should be added, or a bank of 45 or 2A3 tubes operating as keying tubes can be used in order to prevent radiation of key clicks. If from 100 to 150 volts of fixed bias is available, this can be connected into the grid return leads of the buffer and final amplifier stages so as to allow keying of the crystal oscillator. The cathode jack of the 6A6 tube makes a very good place for keying, but even at this point some key click filter should be used. The succeeding tuned circuits eliminate most of the key click "sidebands" when the crystal stage is keyed. Keying the latter also tends to lessen crystal creepage on 40 and 20 meters. If center-tap keying is used on the last stage, it is a good plan to use a set of binding posts instead of the meter jack, because the latter is subject to arc-over. Keying the grid return of the 211 stage only gives about half as much surge, as indicated on an oscillograph, as when CT keying is used. Primary keying has a lag when a 2 mfd. filter condenser is used . . . a great handicap

(Continued on page 25)

* AmpereX

High-Efficiency 2½-Meter Transmitter

By FRANK C. JONES

● A new Raytheon tube has recently been released. It has very good characteristics for use in ultra-high frequency oscillators. This tube, RK-34, is a twin triode similar to the 6A6 or 53, except that the plate leads are brought out to caps on the top of the tube and a white ceramic base is used to keep the grid circuit losses low. This arrangement of the leads gives very low inter-electrode capacities and thus the RK-34 is also a very effective tube for use as a crystal oscillator.

Various circuits were tried for use on 1¼ to 2½ meters, such as the parallel rod, quarter wave long, oscillators. For some reason, satisfactory results were not obtained below 2 meters with this circuit, and even at 2½ meters the efficiency was not as high as with the circuit shown. This circuit is a push-pull oscillator using a resonant grid coil (TNT circuit) a parallel wire plate tank circuit. The latter gives a low C circuit of low losses, and consequently high efficiency could be obtained. This system also allows easy means of coupling to a two-wire antenna untuned feeder of the matched impedance type. The antenna should be a wire or rod about 4-ft. to 4-ft. 2-in. long, with the feeder wires fanned-out in a "Y" across the center portion of about 12-in. to 15-in. The feeders can be of any length and therefore the vertical antenna should be mounted as high as possible.

The circuit shown has both grid leak and cathode bias in order to prevent mishap to the tube in the event of failure to oscillate. The cathode resistor also prevents a tendency for the plate current running away at excessive values of plate voltage and current. It is possible to run the plate voltage up to nearly 500 volts at 100 MA with this system. The type 6A6 tubes are probably more subject to this creeping effect than the RK34s, preliminary tests show, since the former tends to run wild if the cathode current is more than 80 MA.

The 15,000 and 300 ohm resistors should be of the 10 watt size and the grid coil can be made of 5 turns of No. 18 bare wire, about ⅜-in. or 7⁄8-in. diameter and one inch long. The coil should be soldered to the socket terminals. The plate circuit consists of a pair of No. 14 bare wires about 12 inches long for 2½ meters with the antenna feeders connected across them about 2 inches from the short-circuited end. These wires are spaced about 1½-in. apart and held rigidly in place by means of small stand-off insulators. The plate RF choke consists of about 30 turns of No. 22 DSC wire, ¼-in. diameter. It is possible to operate the transmitter without any RF chokes because it uses a balanced push-pull circuit, although a simple choke in the plate lead prevents any possibility of

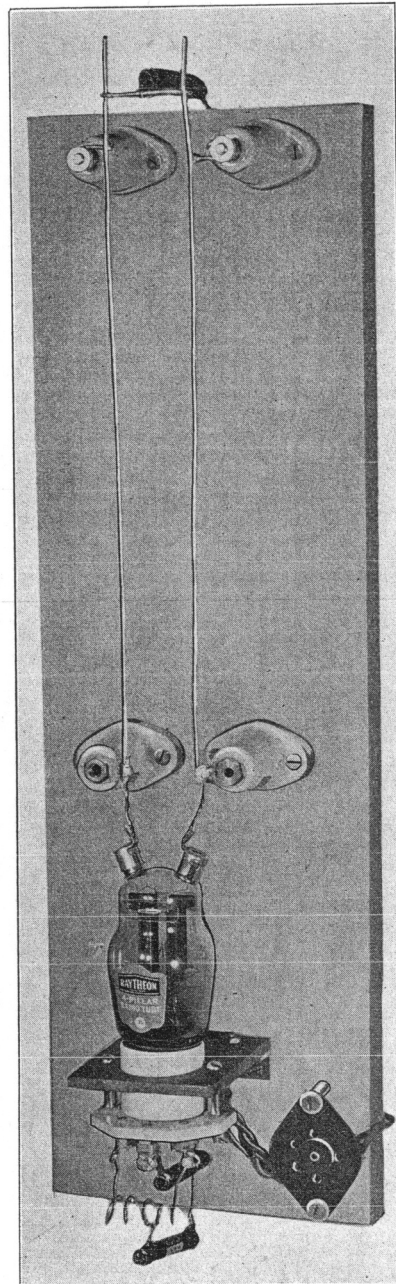

Breadboard layout for 2½ meter transmitter.

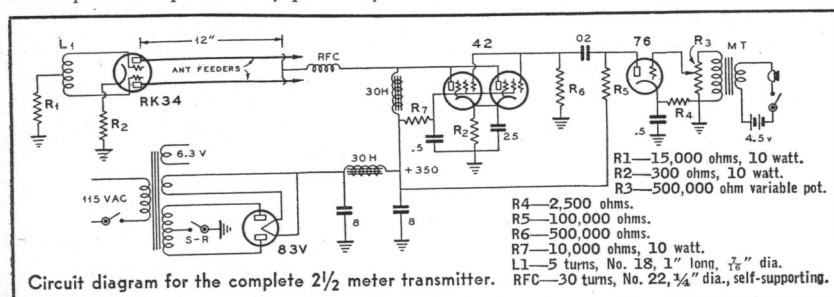

out of phase feedback due to the plate return lead being near the tank circuit.

The modulator consists of a pair of 42 pentodes in parallel, driven by a 76 resistance coupled speech amplifier. The modulator unit is part of a small relay rack set, used for other transmitters, and not shown in the illustration. A good quality single-button mike is satisfactory for amateur use on the ultra-high frequency bands. The modulator unit will supply well over 10 watts of audio, and will modulate an oscillator satisfactorily having an input of between 20 and 30 watts. An oscillator should never be modulated as high as 100% because of excessive frequency modulation. Probably a parallel rod oscillator would give better frequency stability, but at a considerable sacrifice in efficiency.

At an input of 48½ watts, 485 volts plate to cathode and 100 MA plate current, the output is 28 watts, giving an efficiency of 59%. The method of measurement was subject to errors, but measurement on a 5 meter Hi-C oscillator gave an efficiency of 30%, which is about right; thus the readings obtained are relatively accurate.

A plate voltage of 380 volts at 75 MA gave an input of 28½ watts and an output of 15 watts. The efficiency ran about 53%. Lower plate voltages gave less efficiency, but an average of 50% could be obtained on 2½ meters, which seems to be remarkably high. A 10 or 15 watt carrier on 2½ meters should provide a good signal for most amateur work. Many transceivers put out only a fraction of one watt on 2½ meters.

The same circuit can be used on 5 meters by using approximately 2½ times as many grid turns, and by using a plate circuit about 40 inches long. A sliding short circuit allows exact setting of frequency, and a few inches of "dead end" on the parallel wires will do no harm on 5 meters.

The same oscillator was used on 1.3 meters by running a grid wire directly across the tube socket terminals and with plate parallel wires about two inches long. The tube capacities prevent the use of much inductance below 1½ meters.

The 6A6 or 53 tube can be used in this same circuit at somewhat lower efficiency and output on 2½ and 5 meters. The frequency "wobulation" effect is not as great as one would expect under modulation. This is probably due to the very low interelectrode capacities of the RK34 tube and to the use of a cathode-plus-grid-leak form of grid bias. A change of plate voltage produces a small change of grid voltage which is apparently in such a direction as to be somewhat compensating insofar as frequency changes are concerned. For 5 and 10 meters this form of bias is very desirable, and for portable use, a tuned plate circuit can be used to conserve space. Tests on 7 and 8 meters have indicated satisfactory reception on some of the new all wave BCL receivers which tune to frequencies as high as that.

Any form of modulator which is capable of supplying at least 10 watts of audio power can be used.

CHARACTERISTIC OF RAYTHEON RK-34 4-PILLAR TUBE TWIN POWER AMPLIFIER (Uni-Potential Cathode Type)

Heater Rating:		
Voltage	6.3	Volts
Current	0.8	Amp
Interelectrode Capacities:		
Grid to Plate	2.7	Mmf.
Input	4.2	Mmf.
Output	2.1	Mmf.

A Two-Tuber With Semi-Tuned R. F.

By FRANCIS CHURCHILL

• A surprisingly large number of amateurs have expressed interest in a simple two-tube receiver which will give satisfactory reception in locations where there is an absence of high-power interference from other stations. The original "Gainer" receiver which was described in these pages has brought favorable comment from the reader; however, many an amateur has requested information on how to add RF amplification to a simple battery operated model. Thus an improved receiver has been developed, without claim that its features are new, but merely as an aid to those who seek better results from a minimum of equipment.

The battery-operated RF receiver here described uses a type 34 screen-grid tube in a semi-tuned RF stage, and a type 19 high-mu tube is used as a combination detector and audio amplifier. One section of the type 19 tube, the portion which is used for the audio circuit, is resistance coupled to the detector portion. Resistance coupling has been chosen because of its low cost and simplicity. The 19 tube has a high amplification constant and thus it is quite suitable for use in resistance coupled circuits.

The type 34 screen-grid RF tube was chosen because it is a variable mu type of tube. This tube, like the 19, has a two-volt filament. An analysis of the circuit diagram shows that coil L1 is wound on a 7/8-in. diameter form. This is the semi-tuned RF coil. Its function is to roughly tune the RF stage to whatever amateur band is being received.

Briefly, the function of the semi-tuned RF stage is as follows: (1) It increases the sensitivity of the receiver on the amateur bands. (2) It also increases the selectivity in that it prevents cross talk from nearby broadcast stations, usually troublesome in regenerative receivers.

Considerable gain is added to the receiver by the use of the semi-tuned RF stage. The RF coils are wound on 7/8-in. diameter forms. Cartridge fuses (blown-out) can be used. The coil winding chart gives the data for the number of turns on the RF coils for each of the four popular amateur bands. These small RF cartridge coils are supported in an ordinary grid-leak mounting.

The 25 MMF. antenna condenser is used to overcome the dead-spot effects which cause the detector to go out of oscillation when certain portions of the band are being tuned over. This condenser should be readjusted when the receiver is changed from band to band. It also broadly tunes the RF stage to resonance. One of the stator plates can be short-circuited when desired. The type 34 screen-grid RF tube must be well shielded. The large, bulky size of this tube calls for the use of one of the large, long aluminum shield cans. The type 19 tube can also be shielded if the receiver is to be operated in

locations where hum pick-up from AC power lines is heavy.

The 3-30 mmf. trimmer condenser which is in series with coil L2 should be adjusted

for the MAXIMUM capacity which will still allow the detector to oscillate on the shortest wavelength to be received. The purpose of this condenser is to couple the RF stage to the detector tuned circuit.

(Continued on page 17)

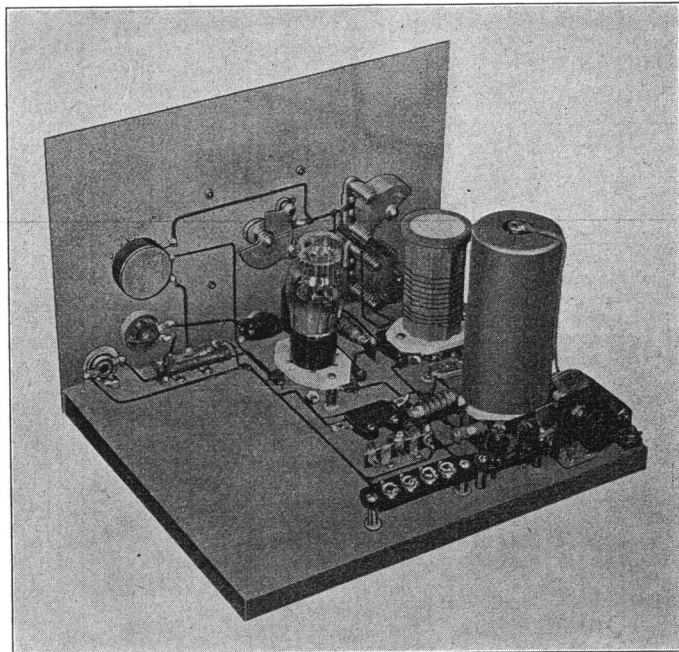

Rear view of the receiver showing correct placement of parts. The constructor is advised to adhere rigidly to this layout if best results are to be had.

	L1 (RF Coil)	L2 (Secondary Winding)	L3 (Tickler Winding)
For 20 Meters	35 Turns No. 22 DSC Wire. Winding space 1 inch long on a 7/8 inch dia. tube.	7 Turns, No. 22 DSC Wire, space wound to cover 1 inch winding space.	3 1/2 Turns, No. 22 DSC Wire, space wound to cover 3/2 inch winding space.
For 40 Meters	60 Turns No. 26 Enameled Wire. Winding space 1 inch long on a 7/8 inch dia. tube.	14 Turns, No. 22 DSC Wire, space wound to cover 1 inch winding space.	5 Turns, No. 22 DSC Wire, close wound.
For 80 Meters	160 Turns No. 36 DSC Wire. Scramble wound on a 7/8 inch dia. tube, 1 inch long.	27 Turns, No. 22 DSC Wire, close wound.	9 Turns, No. 22 DSC Wire, close wound.
For 160 Meters	300 Turns No. 36 DSC Wire. Scramble wound on a 7/8 inch dia. tube, 1 inch long.	60 Turns, No. 22 DSC Wire, close wound.	15 Turns, No. 32 Enameled Wire, close wound.

L1 wound on 7/16 inch tubing, or on cartridge fuse shells. L2 and L3 both wound on same form. Use 4-prong, 1 1/2 inch dia. forms. L2 is the upper winding on the form, L3 the lower winding. L2 and L3 are spaced about 3/8 inch from each other.

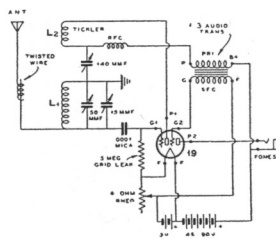

A simplified version of the same receiver circuit, but without the RF stage. This circuit is ideal for use in a portable receiver. Satisfactory operation is secured from only 45 volts of B Battery.

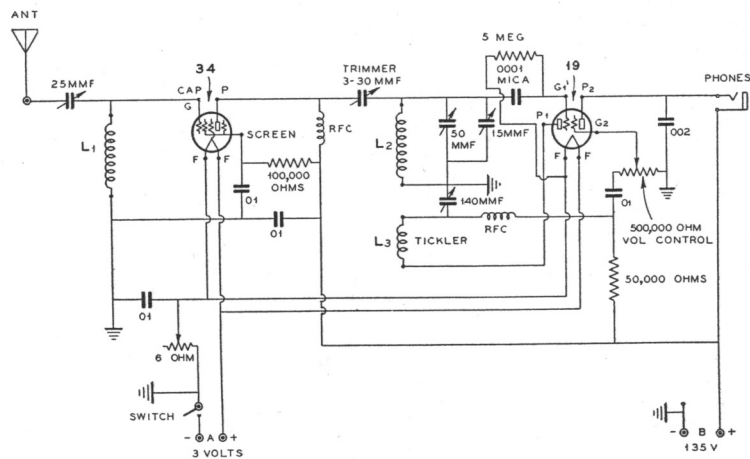

Circuit diagram of the receiver with semi-tuned RF stage. All values are given.

50-Watt Two-Band C. W. Transmitter

By HENRY WILLIAMS

● The Jones All-Band 53 Exciter Unit has created widespread interest and its popularity is increasing as more amateurs become acquainted with its advantages. As has been previously related, this exciter unit gives greater output than can be obtained from the older systems wherein a single tube is used in a multi-band arrangement. Furthermore, the Jones Exciter is easy on crystals and its output on harmonics is greater, with less plate voltage, than any of the other known methods. Rightfully, it has found its way into the heart of many an amateur station.

Various adaptations of this popular unit have already been shown; however, there has been a demand for the details on the design and construction of the most simple version of the Jones exciter wherein a 53 tube can be used as an oscillator-doubler for the purpose of driving a buffer or final amplifier stage in which a pair of 45s or 2A3s are used in push-pull. Such a transmitter is here illustrated; the circuit diagram gives the complete hook-up.

This is truly an ideal arrangement for the newcomer; at the same time it is a versatile unit for any amateur who desires to use it for the purpose of driving higher-power amplifier stages. Thus the unit never grows old, and it can always be used as the stepping stone to bigger and better transmitters.

From the illustrations it is seen that the oscillator-doubler section is shielded from the buffer or amplifier section. A piece of No. 12 gauge aluminum, 7 x 10 inches, is used for the shield. The shield is grounded to negative "B". Proper isolation between the doubler coil and the grid coil is secured by the use of this shield. The entire unit is mounted on a breadboard, 11-in. x 24-in. x 3/4-in. Small cleats are screwed to the bottom of the breadboard to raise it from the table top. The various small resistors, condensers, RF chokes, etc., are mounted on the under-side of the breadboard, out of sight, thus giving the completed unit a pleasing appearance.

A glance at the illustration shows that the oscillator-doubler portion is to the left. The coil to the extreme left is the oscillator coil; the one to the right is the doubler coil. The 53 tube is placed between these two coils. The plate tuning condensers for both these coils are supported on a piece of bakelite, 2 1/4-in. x 9-in. x 1/8-in. On this same strip of bakelite the on-off switches for the plate circuit of the oscillator and amplifier stages are mounted; the jacks for metering the oscillator plate current and for reading the grid current of the buffer grid coil are also mounted on this same strip of bakelite. The crystal is directly behind the 53 tube.

The buffer or amplifier section, in which a pair of 45s or 2A3s are used in push-pull, has its grid coil coupled by the conventional link method to the doubler coil. A single turn loop of wire at the bottom (cold) end of the doubler coil and a similar loop at the center (cold) portion of the buffer-amplifier grid coil constitutes the link coupling arrangement. The coupling loops are fixed; the two connections are brought to two of the prongs on the 5-prong plug-in coil forms on which the oscillator, doubler and grid coils are wound.

The grid coil of the buffer-amplifier stage is tuned with a .0001 mfd. star midget variable condenser. The neutralizing condensers are 35 mmf. Star midgets, double spaced. The neutralizing condensers are secured to a small

bakelite strip which is secured to the breadboard by means of two small angle brackets. The plate tuning condenser in the buffer-amplifier stage is a two-section, 35 mmf. per section, double spaced Hammarlund midget variable, with both sections connected in parallel so as to give a total capacity of 70 mmf. The plate coil in the buffer-amplifier stage is a Merrill Inductor, an inexpensive coil of No. 14 enameled wire, supported in four places by means of low-loss insulating strips. The use of wire-wound tank coils in preference to copper tubing coils results in greater efficiency and lower losses. The

plate circuit of the final. The doubler coil in the 53 stage is not used when operating straight through on the fundamental frequency. The 53 plate coil is then link coupled to the grid coil in the buffer-amplifier. Doubling is accomplished by using an oscillator coil tuned to the fundamental frequency of the crystal, a doubler coil tuned to twice the frequency of the oscillator, a grid coil tuned to the same frequency as the doubler, and a final plate coil also tuned to the same frequency as the doubler and grid coils. Thus for 80 meter operation, the oscillator uses a 160 meter crystal and a 160 meter plate coil; the doubler, grid coil and final amplifier plate coils are all of the 80 meter size.

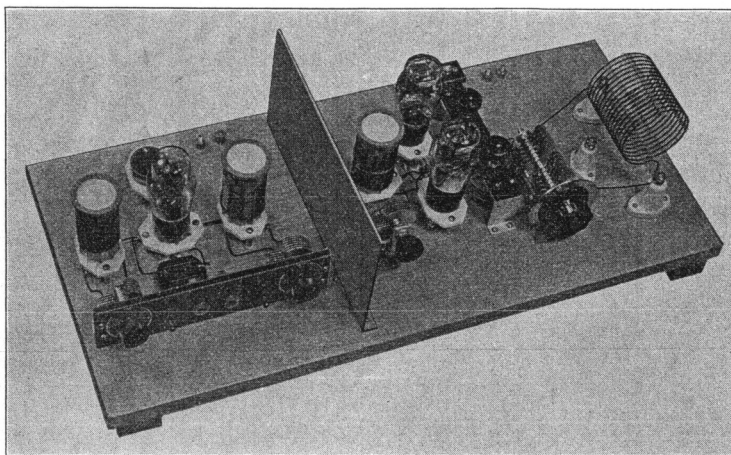

The Jones Exciter and Push-Pull 45 Amplifier, an ideal beginner's transmitter which can be used at any future time as a driver for a higher-power amplifier.

use of copper tubing coils should be completely discouraged for use in any amateur transmitter, other than those of the self-excited types. The correct number of turns of wire for each of the coils in this two-band transmitter is given in the table.

This "newcomer's" transmitter can be designed for operation on 160 and 80 meters; for 80 and 40 meters, or for 40 and 20 meters, depending on the frequency of the crystal used in the oscillator.

Straight-through operation on a single band calls for the use of a coil for the fundamental frequency in the oscillator stage, in the grid circuit of the buffer-amplifier and in

The theory of operation of this transmitter is simple and easily understood. The 53 tube has two grids, two plates, a cathode, and a filament of the heater type. The grids and plates of the 53 tube are marked P1, G1, and P2, G2. P1 and G1 are the plate and grid for the oscillator portion; P2 and G2 are the plate and grid for the doubler portion. Make sure that the proper connections are made, as stated, otherwise the oscillator grid will be erroneously connected in the circuit with the doubler plate, or vice versa. It is merely necessary to remember that P1 and G1 constitute one section of the tube; P2 and G2 the other. The heater current for

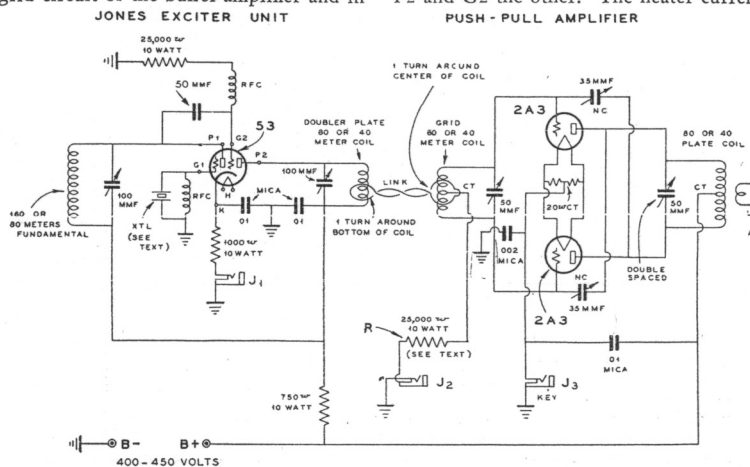

Circuit Diagram of 50-watt R.F. Unit using Jones Exciter.

meter size. For 160 meter straight-through the 53 tube must be supplied from a separate filament transformer than the one which lights the filaments of the 45 or 2A3 tubes in the buffer-amplifier portion of the transmitter. A separate 2½-volt filament transformer, or a plate transformer which has two separate 2½-volt filament windings can be used.

The oscillator can be keyed if battery bias (90 volts) plus the grid resistor for the 45 or 2A3 tubes is used, otherwise the buffer-amplifier stage should be keyed by means of the usual center-tap keying method, as shown in the circuit diagram.

A 25,000 ohm, 10 watt resistor is used in the grid circuit of the doubler section for the purpose of giving additional grid bias to the doubler. A doubler should have higher bias than an amplifier in order to obtain efficient operation. In previous circuits in which the 53 tube is used as an oscillator doubler a small value of resistor has been shown, but the 25,000 ohm size used in this circuit was chosen because the circuit is operated with a higher plate voltage. The plate current must not exceed 75 or 80 milliamperes. The cathode bias resistor for the 53 tube is of the 1,000 ohm, 10 watt size. When type 45 tubes are used in the buffer-amplifier stage, the bias resistor is of a value of from 25,000 to 40,000 ohms, whereas only 25,000 ohms is required when type 2A3 tubes are used because the latter tubes have slightly higher mu and mutual conductance.

Some practical methods for trouble-shooting this transmitter will aid the constructor in getting the most out of the completed job. If the output from the oscillator portion of the 53 tube is too low, trouble can usually be traced to the following:

1. Insufficient plate voltage.
2. Weak type 53 tube.
3. Too much plate current (over 80 MA).
4. Incorrect values of resistors.
5. Omission of cathode by-pass condensers.
6. Plate by-pass condenser not functioning properly.

If the output from the doubler section of the 53 tube is too low, check for the following trouble:

1. Omission of cathode by-pass condenser.
2. Cathode or grid leak resistor too high for plate voltage used.
3. Grid coupling condenser incorrect value.
4. Not enough coupling through link circuit to next coil.

The output from the doubler section should be greater than the output from the oscillator, as indicated by a loop of wire connected to a flashlight globe, or by means of a neon glow lamp. Greater output from the doubler stage than from the oscillator stage is secured because of less loading, and the fact that there is an actual gain in power through the doubler.

Where other types of universal exciter units give less output from the doubler than from the oscillator, this Jones Exciter Unit has the advantage that it gives greater output. A noticeable amount of amplification is secured from this doubler section, thus providing more driving power to the grid of the tube or tubes in the buffer-amplifier stage.

The transmitter is adjusted as follows:

1. Connect filament and high voltage leads to the oscillator.
2. Tune the oscillator coil for maximum output.
3. Tune the doubler section for maximum output. The cathode current for the 53 tube should read between 60 and 75 milliamperes. The oscillator tuning condenser should be set so that this current does not exceed 80 MA at the most, since the tube is liable to run wild with higher plate current.
4. With plate current disconnected from the buffer-amplifier stage, tune the grid coil of the buffer-amplifier to resonance. Then

neutralize. After the final stage is neutralized, connect the plate current to it and tune the final amplifier to resonance. Some slight readjusting of the grid coil, also of the oscillator or doubler coil may be necessary while the final is being neutralized. Make certain that the oscillator does not go out of oscillation while tuning the grid coil or while neutralizing the final.

The grid current on the final stage should be at least 6 MA and preferably from 8 to 10 MA. The plate current in the final amplifier will run between 100 and 150 MA, depending upon the plate voltage and antenna loading.

The most satisfactory method for coupling the final amplifier coil to the antenna is by means of link coupling. 2 to 3 turns of No. 14 rubber covered wire are wound around the center of the final plate coil and a twisted-pair feed line is then carried to a distant antenna coil, similar in size to that of the final amplifier plate coil. Three turns of wire should be wound around the antenna coil to complete the link coupling circuit.

Only one power supply is needed for the entire transmitter. The plate transformer should provide from 450 to 500 volts at 200 MA. If electrolytic condensers are used in the filter, two 8 mfd. 450 volt condensers should be connected in series to avoid breakdown.

Typical readings obtained with this transmitter are given in the following data:

At 400 volts plate supply, oscillator current equals 60, amplifier current equals 130, grid current 8 MA, and antenna output 35 to 40 watts.

At 500 volts plate supply, oscillator current equals 70, amplifier equals 150, grid current 10, and antenna power equals approximately 50 watts.

COIL DATA

40 METER OPERATION

Final Amp. Plate Coil—16 turns No. 14, 2¾-in. diam., 3-in. long, C.T.

Amp. Grid Coil—22 turns No. 18E, 1½-in. diam., 2-in. long, C.T.

Doubler Coil—20 turns No. 18E, 1½-in. diam., 1¾-in. long.

Osc. Coil (80 meters)—30 turns No. 22 DSC, 1½-in. diam., 1½-in. long.

80 METER OPERATION

Final Plate Coil—28 turns No. 14E, 3-in. diam., 4-in. long.

Amp. Grid Coil—33 turns No. 18 DSC, 1½-in. diam., close wound, C.T.

Doubler Coil—33 turns No. 18 DSC, 1½-in. diam., close wound, (not C.T.)

160 meter Osc. Coil—64 turns No. 22 DSC, 1½-in. diam., close wound.

A Two-Tube With Semi-Tuned RF

(Continued from page 15)

The constructor is cautioned to make certain that the proper connections are made to the socket which holds the type 19 tube. Grid No. 1 and Plate No. 1 of the type 19 tube constitute one section of the tube—the portion used as the detector; Grid No. 2 and Plate No. 2 constitute the other portion, that which is used for the audio section. A 500,000 ohm potentiometer is used for controlling volume. A 6 ohm rheostat controls the filament current of both tubes. This rheostat should be adjusted so that the filaments of both tubes light with a dull, red glow. Caution is also necessary in the proper wiring of the circuit, so that the positive and negative leads are connected in the proper manner. The circuit diagram should be followed with minute care.

L1 and L2 are wound on the same form,

1½-in diameter low-loss forms being used for all coils. L1 and L2 must both be wound in the same direction. L2 is the winding on the upper portion of the coil form, L3 is the lower winding. The bottom turn connection of L3 is connected to plate P1 of the type 19 tube.

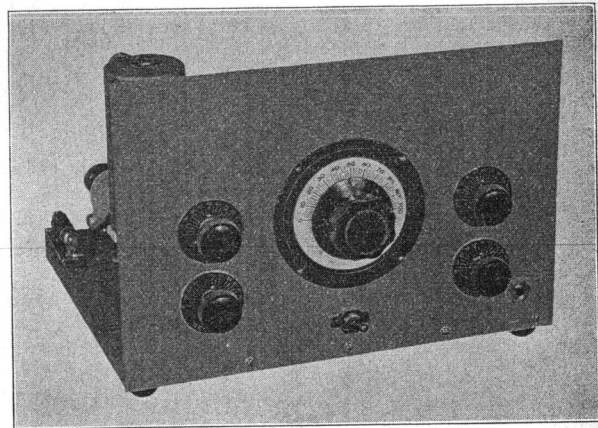

Front view of the Two-Tube

The .01 mfd. condensers are all of the small tubular paper-wound type, rated at 600 volts. The 100,000 ohm resistor and also the 50,000 ohm resistor are of the 1 watt size. The RF chokes are of the 2.5 mh., 5-pie small midget type.

The receiver operates from two 1½-volt dry cells, and three 45-volt B batteries. Best results are obtained when the B supply is 135 volts.

From the illustrations it is seen that the front panel is symmetrically arranged. The large Crowe band-spread tuning dial is in the center. To the left are the controls for the tank tuning condenser and for the regeneration condenser, the latter being the lower control knob. The two knobs to the right of the center dial are the volume control (top) and the control for the rheostat. The on-off switch is directly under the main tuning dial. The headphone jack is at the extreme right, bottom. The front panel is 7½-in. x 11-in., No. 12 gauge aluminum.

The baseboard is a piece of oak, 9-in. x 11-in. x ¾-in.

The RF Coil

Care should be taken to wind the coils exactly as shown in the coil tables. The size of the wire and the diameter of the form on which the wire is wound are critical. If the correct values are not used no gain will be secured from the RF stage. If the coils are made smaller in diameter than specified, a small mica trimmer condenser can be connected across the coil to peak the RF coil in each band.

If the receiver does not regenerate, the trouble can be traced to one of the following causes:

1. Wrong direction of tickler winding.
2. Not enough, or too many tickler turns.
3. Filament voltage too low, or weak 19 tube.
4. Error in wiring of the circuit.
5. Short circuit in the tuning condenser or coil circuit.
6. Insufficient B battery voltage.

If the RF stage fails to give appreciable gain, the trouble can be traced to one of the following causes:

1. A weak type 34 tube.
2. Incorrect plate or screen voltage.
3. No bias voltage on the control grid due to filament rheostat.
4. Lack of resonance in the RF coil due to too many or not enough turns on the small RF coil form.

A Comparison of Practical Dielectrics Available for Radio Insulation

By D. B. McGOWN

General

● Gone are the days when experimenters were interested in frequencies of 200 meters and above. Insulation in those days was important but the use of hard rubber answered most requirements. Of course, it did warp but who cared! Precision of frequencies of radio components were not too stringent.

Later as requirements became more severe, bakelite made its appearance. This insulation was easily handled, fairly strong and although it still warped some and absorbed moisture, it was taken to the radio experimenters bosom and answered most of his radio insulation requirements for quite a while. In recent years, however, the higher frequencies (lower wavelengths) have made their debut. Experimenters everywhere have bowed to the requirements which this new field imposed on radio circuits in the way of precision electrically and mechanically and today instead of experimenting from 100 to 200 meters, most experimental efforts and many commercial ones are centered between one and twenty meters and the precision of component parts has become as important as the circuit itself.

In receiving these frequencies the losses in the insulation material must not only be small to conserve what little energy is present but the form and position of the wiring of the circuit must be critically adjusted and just as important, must be held in place to preserve that adjustment. This means, of course, that insulation materials that have losses at ultra high frequencies are not satisfactory and that materials that absorb moisture and warp or that cannot be made to exact precision are also of no use.

In transmitting circuits losses in insulation means losses in much needed power and also the critical adjustment of grid and tank circuits must be maintained and that leakage of materials which absorb moisture at ultra high frequencies are very serious factors. Consequently, insulation materials that are non-hygroscopic and have high surface leakage as well as low losses that hold their electrical and mechanical characteristics indefinitely are needed in this new field.

Available Insulators

Many handbooks will give you a long list of insulating materials with their dielectric constant, power factor and insulation resistance.

The dielectric constant is simply a comparison of the material with air in its ability to store electrical energy—the higher the dielectric constant of insulation material, the higher would be the capacitance of a condenser consisting of two plates separated at a given distance by the insulating material under consideration.

Power factor is simply the measure of the loss in the material. Although other minor factors enter into it, the lower the power factor, the better the insulator.

Insulation resistance is, of course, the potential required to cause a given amount of current flow through a given cross section of the material and the higher the insulation resistance, also the better the material, which possess good characteristics.

In view of the above requirements, the following are equally important for practical use of the material:

- Permanence.
- Ease of shaping the material to the required form.

Leakage resistance across its surface.
Resistance to heat and moisture.

From the above considerations, we would all use quartz as insulation if we could, but if you have ever cut quartz crystals from Brazilian lumps of quartz, you will appreciate why very little of this material is used. It is extremely difficult to secure in pure form and to form into usable shapes.

The next most common insulators is glass. Glass in some grades is excellent—other grades of glass are less desirable than other materials. As usual, the good insulator is too expensive and the poor material is unsatisfactory.

This brings us to a comparison of the most commonly used insulating materials, namely: Bakelite, Isolanite, Mycalex, Victron, Steatite.

Of this group Mycalex is the newest member. It has been known to the commercial engineers for some time but a brief description here will serve to recall to the experimenters' minds, its composition.

In this material a very fine grade of powdered mica is mixed with a very high grade of powdered glass. Under terrific heat and pressure, in the presence of a chemical binder, these materials, both exceptionally good insulators, are fused together into a mass which possesses good insulation qualities.

Isolanite is a specially processed ceramic substance, the most important constituent of which is magnesium silicate.

Bakelite is a synthetic organic substance resulting from the condensation of phenols and formaldehyde.

Victron is an organic compound made from vegetable matter.

Steatite is another ceramic mixture similar to Isolanite and in general the comments on Isolanite will apply to the characteristics of Steatite.

Victron possesses the best electrical characteristics of the whole group and where it can be used makes an exceptionally fine insulator—it does have these disadvantages which for many applications are serious. It is a vegetable matter and thus deteriorates with time. It also has a low cold flow point so that when used under pressure it will actually change its form. It has a very low melting point so it cannot be used in any circuit where heat is present.

The next in order of desirability for its electrical insulating properties is Mycalex. This material is very non-hygroscopic, will not warp under temperatures less than 450° C. (any parts of a circuit running hotter than this just should not be), has excellent mechanical characteristics in addition to its highly satisfactory electrical ones. It possesses a mechanical strength of 15,000 to 25,000 pounds per square inch in compression and 7,000 pounds per square inch in tension. It has a thermal co-efficient of expansion of .0000088 per 1° C.

These characteristics have been taken on the new Leadless Mycalex which has recently appeared on the market in bulk and fabricated form. Some of the earlier specimens of Mycalex which were put on the market at first did not possess as good characteristics and have caused confusion. Some of the locally manufactured Mycalex should not be confused with the Leadless Mycalex which is

imported from England. The characteristics as stated above were taken on the Leadless Mycalex.

Isolanite has been very widely used for all sorts of fabricated parts in radio circuits. Isolanite as a material by itself is a good insulator possessing low losses and has good mechanical properties. However, it must be fired before these characteristics are obtained and in this firing process, real precision is very difficult to obtain. Also, Isolanite absorbs moisture on its surface very readily and consequently it is necessary to put a smooth finish on the natural material. This smooth finish is a glaze which does not possess anything like the good electrical characteristics of the Isolanite itself.

Steatite also has to be baked, making exact precision of parts difficult. They must also be impregnated to prevent high surface absorption of moisture which causes leakage. Materials used to impregnate the material are usually of higher loss at higher frequencies and must of necessity detract from the value of this insulation material. However, in many applications such as stand-off insulators and the like, Steatite has been very popular and has proven satisfactory where it has been impregnated with a good grade of wax.

In a very recent test made in one of the country's leading government laboratories, the following comparisons between Mycalex, Isolanite and Bakelite were made:

Material	Dielectric Constant	Power Factor %	Fig. of Merit K x P.F.	Freq. KC
Mycalex	7.18	0.183	1.31	1300
Isolanite	6.35	0.363	2.30	1320
Bakelite	5.82	4.360	25.30	1380
Mycalex	7.18	0.139	1.00	4000
Isolanite	6.35	0.296	1.88	4000
Bakelite	5.82	4.200	24.00	4200

The circuit used for determining insulating properties contained General Radio precision parts and was the well known substitution method as given in Bureau of Standards Circular No. 74 entitled, "Radio Instruments and Measurements". The product of the dielectric constant times the power factor gives the figure of merit.

Measurements on other materials with the sources of the information is tabulated below:

Material	Power F. 1000 KC 170° C.	Dielect. Const. (R.)	Loss Factor (P.F. x K.)	Information Source
Victron AA	.06	2.5	.15	"Insulation Engineer" Vol. 1, Dec., 1933
Victron AA	.08	3.0	.24	do. do.
Victron K	.12	3.5	.42	do. do.
Victron K	.15	4.0	.60	do. do.
XIB Rubber	.414	3.74	1.55	Amer. Hard Rubber Co.
X2B Rubber	.386	4.2	1.66	do. do. Synthane Corp. Bulletin
Bakelite Gr. XXX	3.5	5.0	17.5	
Pyrex (Glass)	.418	4.9	2.05	

Workability of Material

Of the group above, Mycalex, Bakelite, Hard Rubber and Victron are readily machinable and can be secured in bulk by the experimenter. Isolanite, Pyrex and Steatite must be purchased in finished form as after the final baking it is impossible to drill them or shape them. For mechanical strength, Mycalex, Isolanite, Steatite, Pyrex, Bakelite are strongest in the order named and for the group listed above only Mycalex, Isolanite

(Continued on page 20)

New Products for the Fall Season

The New Silver-"RADIO" Amateur Superheterodyne

● In cooperation with the technical staff of "RADIO", the engineering department of McMurdo Silver Corporation of Chicago has developed an advanced receiver of the superheterodyne type for amateur CW and phone reception. This new receiver, to be known as SILVER-"RADIO", will be formally introduced next month.

The new receiver has two stages of tuned RF amplification ahead of the detector. The detector and RF tubes are of the 6D6 type, as is the tube in the crystal filter portion. The beat oscillator is a 76 and a 6C6 is used for the second detector. A tuning meter denotes signal strength in R readings. High gain and selectivity are secured by use of the new Aladdin iron-core IF transformers which were first introduced to the radio

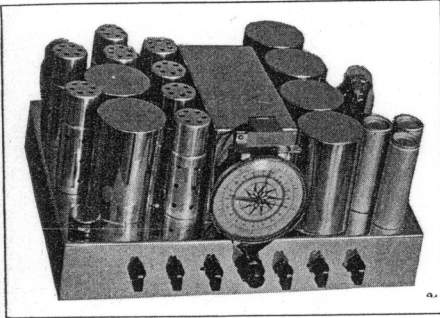

The new Silver-"RADIO" amateur superheterodyne, one of the precision, custom-built receivers which will make its appearance next month.

amateur in the Jones "222" receivers. The crystal filter in the Silver-"RADIO" receiver uses the new Bliley crystal and holder, the newest innovations in crystal filters being incorporated.

Coil-switching is used throughout. All controls are brought to the front panel, as the illustration of the chassis shows. A specially-designed Crowe airplane-type dial and frequency scale is provided.

Performance tests are now being conducted in the laboratories and a complete engineering report will be presented in September "RADIO". The introduction of this factory-built receiver is the answer to the demand from amateurs who have asked this magazine to arrange with a reliable manufacturer for the building of a receiver in which the many new design features sponsored by "RADIO" are included.

McMurdo Silver Corporation will also market a Jones All-Band Exciter and Amplifier unit which can be used as a driver for amplifiers ranging in inputs of from 100 to 500 watts.

The first of these exciter-amplifier units is here illustrated. An assortment of relay-rack transmitters for CW and phone operation will be built around the Jones Exciter unit. The circuit diagram shows the first of the new Silver-"RADIO" transmitter units for the amateur.

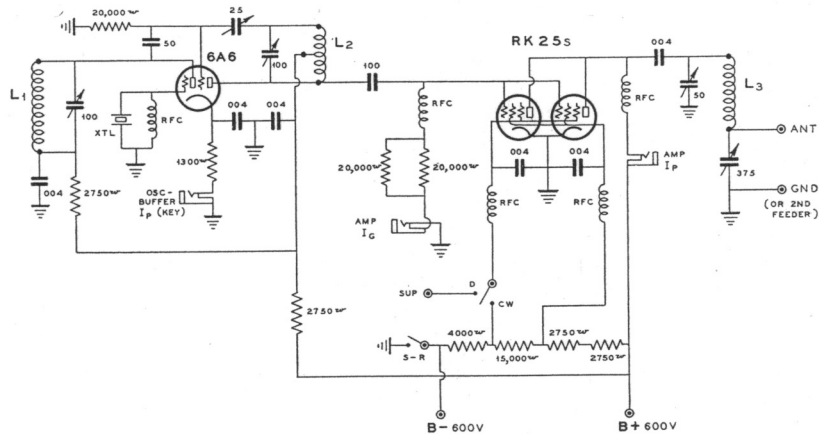
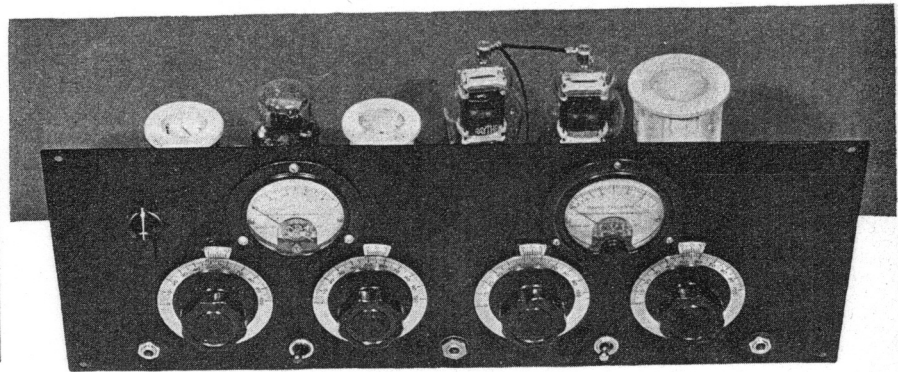
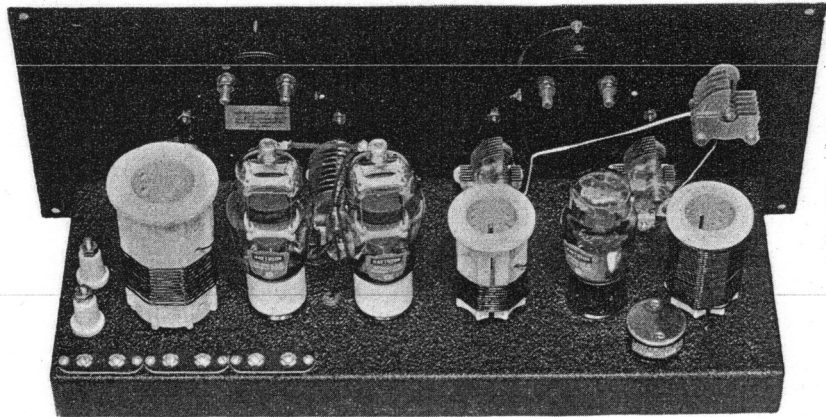

New ideas in amateur transmitters are soon to be announced. The above illustrations show the new Silver-"RADIO" exciter-amplifier unit, in which the Jones All-Band Exciter is used. These units can be secured separately or as part of a complete line of amateur transmitters, ranging in power input from 100 to 500 watts, CW and phone. A variety of standard relay rack transmitters will be offered.

Announcement

● United Transformer Corporation announces the removal of its offices and plant to a new location at 72-78 Spring street, New York City. The new plant represents a consolidation of the three floors formerly occupied at 264 Canal street into one large plant having more than twice the previous area and production facilities.

The additional manufacturing facilities

have been necessitated by the great demand for the company's diversified lines of audio transformers, power transformers, filters, etc. The scope of operations of the new plant includes audio transformers up to 50,000 watts and power transformers up to 100 KVA, 100,000 volts.

The new plant will enable UTC to render an even broader, more cooperative service to its many manufacturing and distributing outlets.

Letters to the Editor

—And His Comment Thereto

July 21, 1935.

To the Editor of "RADIO".

Dear Sir:

For the last two years I have been following the activities of the International Radio Fraternity, of Colonel Clair Foster and the rest of the more regular writers in "RADIO" in their efforts to arouse opinion on the matter of the proposed widening of the amateur bands. During these two years I have been content to sit back and look on, occasionally writing to the ARRL in Hartford, Conn., to find out what was being done about various matters and why nothing was being done about others. After scanning through the last issue of "RADIO" and noticing the article by the Cairo Club of San Jose, I have come to the point where I feel I should enter my say in the matter.

In almost every issue of QST one reads editorials or other articles pointing out that even though the ham does need more frequencies, especially on 20 and 40 meters, it is virtually impossible to obtain them. The gist of certain more recent articles has ever been that the ham needs no more territory. Pursuant to supporting this argument they print in the pages of QST articles by unthinking amateurs owning single signal receivers of the poorer class, amateurs who claim that on their receivers there is a large amount of empty space on the dial in both of the high-frequency bands (40 meters and 20 meters). The error of these statements can easily be established by any thinking amateur if he will just look at the matter with a perfectly open mind and make the same investigation as those amateurs writing in QST did, but make it on a GOOD receiver.

But it is not for us to quibble over the matter of the apparent QRM. Let us compare the number of licensed amateur stations in this country with the frequency assignments made to those amateurs! Let us now hasten to remind the unthinking person that amateur and commercial radio should share the frequency allocation in proportion to their use to the citizens of the country issuing the assignments, except in such instances as the assignment of these frequencies would interfere with the services of foreign governments which would be promptly ruled out by the international treaty agreements between the various governments. Let us now quote from report to the stockholders of the Radio Corporation of America, issued February 27, 1935: On page 9 of the report there is a division of the report headed "Inter-City Communications". It is reproduced herein in detail:

"Inter-City Communications"

"Through R.C.A. Communications, Inc., your Corporation inaugurated in 1934 its new, inter-city radio telegraph service, which now connects Boston, New York, Philadelphia, Washington, Detroit, Chicago, New Orleans, and San Francisco. The plans call for the addition of Los Angeles and Seattle in the near future. Other important cities will be added later.

"This inter-city message service, which offers fast, 15-word radiograms at the wire line rate for 10 words, and lettergrams of 60 words at the wire charge for 50, has grown steadily since the service was opened in April, 1934.

"Through an extension of previous working agreements with the Western Union Telegraph Company, inter-city messages 'via RCA' are accepted at, or delivered from, any of the telegraph company's offices in the cities to which the new RCA service extends. These

Western Union offices thus augment the pick-up and delivery facilities of R. C. A. Communications, Inc."

Gentlemen, if that is not sufficient evidence of the existence of superfluous territory which might well be used for the purpose of amateur communication, then I have been sadly misinformed as to the nature of radio communication. If my understanding of the matter be correct, it has long been one of the regulations of the old F.R.C., and now the F.C.C., that radio communication shall not be used in duplication of existing land service when and where that land service is satisfactory.

The article printed in "RADIO" for July, 1935, brings out this point, but not forcibly. It also brings out one other point. That we have but three years in which to do some real organizing in order that our delegation to the convention at Cairo will be instructed to look after the Army, Navy, and amateur radio services as they should be looked after, and as they justly deserve to be looked after.

Thus far it seems to me there has been very much talking, the greater part of which is perfectly justified, and in absolute accordance with the truth of the matter, but nothing has been as yet been done to lead to the accomplishment of the ideals to which all are subscribing. In the first place, to get every red-blooded amateur in this country to sit down and write his congressman and the F.C.C. would be almost impossible. But there are certain steps that need be taken. The F.C.C. should be advised of the fact that the American Radio Relay League DOES NOT reflect the opinion of the whole amateur radio fraternity, and that it does not reflect the opinion of a large portion of the amateur fraternity. The commission has in the past accepted the evidence of the American Radio Relay League in drawing-up new regulations for the amateur. It is high time that this matter be brought to the attention of the commission. One individual has taken it upon his shoulders to dictate to all the policy of amateur radio in this country. We should first draw up and have signed by as many amateurs as possible a resolution to this effect and pass the signed resolution on to the F.C.C.

We should next draw up a similar resolution and present it to the Congress of the United States, in order that this body of lawmakers will also be apprised of the true situation.

We should next see to it that the resolution of the Cairo Club of San Jose is circulated among the amateur fraternity and signed by as many amateurs as possible. Why should we attempt to clean-up the League and correct the evil conditions which now exist within the organization? The entire amateur radio fraternity in this country will be treated fairly by the commission if the proper approach is made. We should band ourselves together and present our own case to the F.C.C. We should probably meet with more success in this way than by trying to reform the ARRL, because it seems a hopeless task to me.

Sincerely,
(Signed) Morton E. Moore,
W6AUX, Hollywood, Calif.

Editor's Note:

Mr. Moore, your letter is similar in many respects to THOUSANDS of other communications which have reached the editorial desk. Time and again this magazine has been re-

quested to get behind a movement to organize a new association of radio amateurs. It is true that any group of radio amateurs can appear before the FCC, or the Congress, and demand the same hearing which is accorded the ARRL. It is also true that far more licensed U. S. radio amateurs are OUT of the League than IN it. The organized minority therefore dictates to the unorganized majority. This great unorganized majority has recently taken a more active interest in amateur radio politics, and PROGRESS is being made.

However, the ARRL is the nucleus for an organization which can truly be made representative of the wishes of the amateur. It would be a pity to let the ARRL "go to pot"; too much money has been invested in it by the radio amateurs. It CAN be made a representative amateur body when certain reforms are placed into effect—when the organization is purged of men whose incompetence has been proved time and again. An investigating committee has been appointed to investigate all affairs of ARRL administration. This committee will report in September, we believe. Should this committee see fit to bring about drastic reforms in ARRL administration—should it see fit to put men into office who will wage the kind of a fight the amateurs are clamoring for, should it see fit to make the ARRL an organization of none but licensed U. S. radio amateurs (yet permitting anybody, anywhere, to subscribe to "QST", but only as a mere subscriber, not as a member of an AMATEUR'S LEAGUE) there will be no need for the unorganized majority of amateurs to found a new organization in order to protect their interests.

It costs money to fight for our rights. The ARRL has the money—more than \$80,000 is safely tucked away in the treasury. It costs money to lobby in Washington . . . costs money to hire brilliant legal men who will fight for us. All that is required to put the amateur machine into proper operation is the hiring of competent men to run the machinery. Heretofore the amateur didn't give much of a whoop what happened at Hartford. But "RADIO's" two-year campaign has brought results. Let us be patient until the investigating committee reports. The committee has read the handwriting on the wall; all eyes are focused on it.

•••

Practical Dielectric Comparisons

(Continued from page 18)

ite, Steatite and Pyrex will not warp and for surface leakage of the pure insulator itself, Mycalex and Pyrex stand head and shoulders above the others. For non-absorption of moisture, Pyrex and Mycalex sit first in the order named.

Summary

It is hoped that with this exposition of insulation material characteristics that the experimenter will be able to properly judge the type best suited for his immediate requirements.

It is interesting to note that while Isolantite is being used by commercial engineers for parts that require molding, the new English Mycalex has been used very extensively by leading engineers in the major radio companies for all sorts of high frequency insulation service where special machined parts are needed to withstand high temperatures and retain their original form under even excessive electrical and mechanical stresses.

The Triple-Link Driver

By G. F. LAMPKIN*

● So many developments in radio tubes and in circuit methods have been made, that, in three or four-tube low-power transmitter construction the possible combinations are well-nigh innumerable. Among these combinations designs can be found that are conservative in tube costs, or that give maximum output for a minimum of equipment, or that simply fit the material which is on hand. For one reason or another a certain transmitter layout will appeal to a certain number of people. The transmitter to be described offers good outputs on the 3.5, the 7, and the 14 MC bands, and a fairly simple means of obtaining them from a 3.5 MC crystal.

A 53 oscillator, doubler, quadrupler is used to drive a pair of 10s. The chief claim to novelty lies in the triple-link coupling to the final amplifier. A link is used from the crystal driver to the grid input of the final amplifier. The link couples not only to the driver tank on the operating frequency, but also to all three driver tanks. The loss that might possibly be incurred by the extra two loops on the link line does not seem to exist. On the contrary, when quadrupling there is an actual gain in final grid driving power.

This apparently is due to regenerative coupling introduced by the link from grid to plate of the doubler section, rather than to transfer of fourth-harmonic energy directly from the crystal-oscillator plate section to the final amplifier grid-driving circuit. The relative polarity of the link loops on the 7 MC

monic thus developed drives the second section of the twin triode as a straight doubler. No regeneration is used other than as introduced by the link.

The performance of the three-band driver averages up as follows: crystal—3.5 MC, plate voltage on 53—400 DC, plate current on 53, both sections—60 to 90 milliamperes, output power on 3.5 MC—3 watts, on 7.0

figured to be high-C, and as such allows relatively free passage of the second harmonic currents to the lower trap. All other tank circuits are made low-C. The coils for the final amplifier, grid and plate, are made plug-in to facilitate the band changing.

The two ends of the link loop, around the final-amplifier grid coil in this construction, were soldered to the two halves of an ordinary snap dress fastener. The tube-socket plug-in coil permits fairly easy disposal of the link mounting and connections, but on the standoff-insulator mounted type of coil

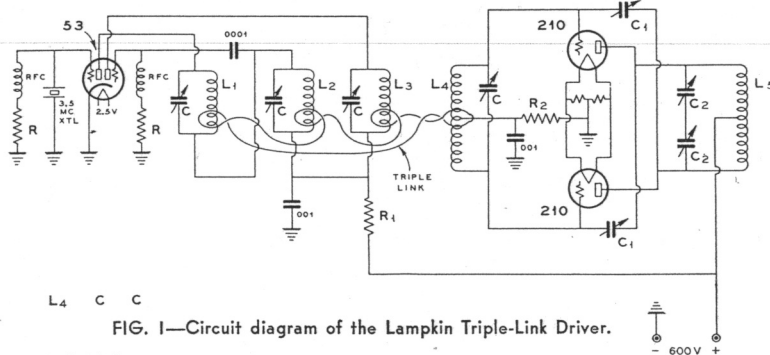

FIG. 1—Circuit diagram of the Lampkin Triple-Link Driver.

- C—50 mmf. Midget.
- C1—15 mmf. double-spaced Midget.
- C2—100 mmf. Midget.
- L1—29 turns, No. 18, 1 1/4 in. diam., 1 1/2 in. long, for 3.5 MC.
- L2—22 turns, No. 18, 1 1/4 in. diam., 1 1/2 in. long for 7.0 MC.
- L3—13 turns, No. 18, 1 1/4 in. diam., 1 1/2 in. long, for 14.0 MC.

- L4—14 turns, No. 18, 1 1/4 in. diam., 1 1/2 in. long, for 14.0 MC.
- L5—6 turns, No. 18, 3 in. diam., 7/8 in. long, for 14.0 MC.
- R—30,000 ohm, 1 watt.
- R1—5,000 ohm, 50 watt.
- R2—10,000 ohm, 10 watt.

MC—4 watts, on 14.0 MC—4 watts. The latter values represent actual grid-driving power measured on the input of the 10 tubes, by determining the RF grid voltage and the average grid current.

For reasons of conservatism type 10 tubes were selected for the output amplifiers. Very probably 4, 5, 6 or 7 tubes could be made to function satisfactorily, but the job comes more within the rating of the 10s. At new low prices for the latter tubes the absolute cost difference is not excessive.

The circuit diagram and the photo present the essential details of the transmitter. Since there is no need for plug-in coils anywhere in the driver, the inductances are made in most simple form on 1 1/4-in. tubing and soldered directly by their leads to their respective condensers. The tank tuned to the crystal fundamental is

this wrinkle can be made to function to advantage. The condensers used were those at hand—an obsolete Hammarlund MC-11 type. The present-day equivalent would be the Hammarlund Star design.

A 600-volt DC supply and a 7.5 and 2.5-volt filament supply are needed to power the transmitter. A 5000 ohm dropping resistor in series with the DC power supply to the 53 lowers the voltage to a value safe for tube and crystal, and also tends to prevent creeping of plate current on the 53. In tuning up the triple-link driver, or any multi-frequency driver for that matter, an absorption type wavemeter will be found most handy. It will prevent the embarrassment of ending up on the wrong harmonic. With everything tuned up tight the triple-link rig can put 30 to 40 watts measured power into an antenna on 14 MC.

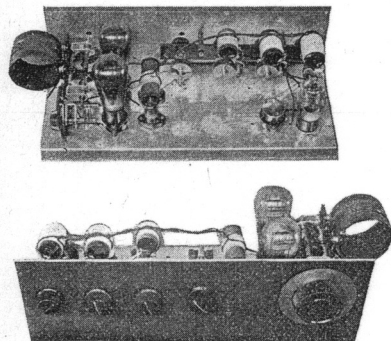

Lampkin Triple-Link Driver, front and rear views.

and the 14 MC tanks of the 53 tube has an appreciable effect on the 14 MC driving power.

The direction of coupling on the link should be reversed to find the condition for maximum quadrupling output. The triple-link driver has the distinction, unique among multi-frequency drivers, of giving greater output at second and fourth harmonics than on the fundamental. The triple-link can lay claim to three distinct advantages: no switching whatever is needed in the driver when changing bands, substantially greater output on the harmonics results, and band changing is confined entirely to the final amplifier.

The crystal oscillator portion of the 53 is conventional. An RF choke is put in series with the grid leak to avoid undue RF loading of the crystal, and the grid leak value itself is not critical. Doubling is done directly in the crystal oscillator plate circuit. This sort of doubling on most any oscillator will give outputs which are appreciable fractions of the fundamental. The second har-

Another YL Gets Bit

(Continued from page 5)

brother-in-law to W9TSV and brother of W9RIA, who was the second to get bit. Mary says that W9RIA's son and daughter also show signs of becoming hams.

While Mary was visiting W9RIA the bug bit her, and she was soon dit-dashing it all over the house. Her hubby, who is a radio service man, and immune to "hamitus", built her rig. After swallowing the technical side for license requirements she bravely entered the RI's office, confident as to code, but with "limbs-aquiver" at the thought of the questions. Leaving the examination room with gloomy thoughts, and a resolve to study up and pass the theoretical side of the examination as soon as her time limit was up, she was surprised and thrilled when

the mail man brought her license and call of W9TSV. This happened on March 1, 1935. March 4th she worked 6FFP, who blissfully thought he was working an old timer, 9BV, but much to his embarrassment found it to be really a new call down in the T's. After the usual bright-cracks over the air, he received a card saying it was a YL.

Mary has had over 300 QSOs since then, but she still remembers the first QSO when, in her own words, she says, "I was attempted to throw the big switch and leave the poor ham I was working in mid-air and run into the street! However, of course, I didn't do that, and finally got the QSO over with." How many remember that same feeling?

But here is news, she even gives her age, for she says she is "28 years old, and sure does get a 'kick' out of radio".

* Lampkin Laboratories, Bradenton, Florida.

Audio Frequency Amplifier Measurements

By W. ROBERT DRESSER*

● There seems to be a widespread belief among non-amateurs that the average amateur has no interest in audio frequency or quality measurements, whereas it has been found that the amateur can produce better results with simple tools suited to his needs than can many non-amateurs with more elaborate equipment.

The audio frequency measurements of most interest are amplifier and transmitter characteristics, modulation determination and overload tests. These measurements are not only necessary when a new station is first put into operation, but in order to maintain highest quality they should be a matter of routine test. It is also advisable to have a quality check on the response of the station receiver and speaker to assure more accurate monitoring and station reporting.

For amplifier and transmitter frequency response measurements the audio frequency generator requirements are more exacting than for straight modulation measurements. The usual method for determining the percentage of modulation of any transmitter is to employ a single sine wave output, most conveniently obtained from a 400 cycle vacuum tube oscillator as described in the May issue of "RADIO".

The transmitter input necessary to give 100% modulation is indicated by the antenna current or by a visual observation on the screen of a cathode ray oscillograph. The input signal required for full modulation is then referred to some convenient plate current or output indicating meter. For class "B" operation it is customary to employ the peaking of the class "B" plate current as an indication of the transmitter input, although the better practice would be to employ some standard form of output meter or power level indicator. This method of modulation measuring is, of course, subject to many errors and may often be misleading—first, because the single frequency input does not correctly represent the multi-wave characteristics of normal speech, and second, because the usual class "B" plate current indicator is too sluggish to accurately indicate the peak current values.

The more exacting methods of modulation measurement employs a composite sine wave source and the resulting power input necessary for 100% modulation is found to be less than that required for a single frequency. This method of modulation measurement will be outlined in a later article.

For audio frequency measurements we should first investigate the amplifier and driver stages of the transmitter and see what can be expected in line of performance. For the measurement of the gain of the amplifier it is possible to employ either a 400 cycle oscillator or a beat frequency oscillator as a driver source. Measurements of the relative gain offered by each stage of the amplifier or by the modulator stage itself can be made by noting the oscillator output necessary to drive each tube grid for 100% modulation, or to obtain some conveniently measured output level.

Most audio frequency oscillators have an associated volume control which will serve as a means of measuring the relative amplification.

If the oscillator has a high impedance output (5,000 to 10,000 ohms) it is advisable to employ a standard 25,000 ohm potentiometer across the output as relative values of amplification can be determined by noting the potentiometer setting. Measurements of

this type are made by connecting the oscillator potentiometer to the last grid in the amplifier, or to the modulator stage if the oscillator has sufficient output to directly drive the modulator tubes. The oscillator output is then adjusted to obtain a measurable modulator output and the oscillator connection is then transferred to the grid of the preceding tube and the output potentiometer adjusted to obtain the same output level as above. The change necessary in the output potentiometer is thereby a measure of the amplification of that particular stage.

Stage by stage amplification checks frequently reveal surprising conditions. This check could be made with a 60 cycle source, but amplifiers are frequently too lacking in amplification at 60 cycles to assure accuracy.

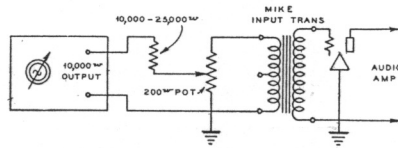

Overall amplifier measurements with high impedance oscillator output and 200 ohm input transformer.

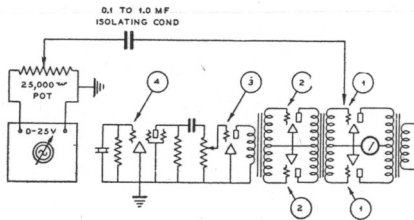

Grid-to-grid amplifier gain measurements employing audio frequency oscillator and class B meter as output indicator.

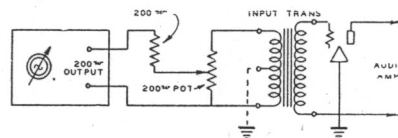

Overall amplifier measurements with 200 ohm oscillator output. Variable pad permitting low level amplifier inputs.

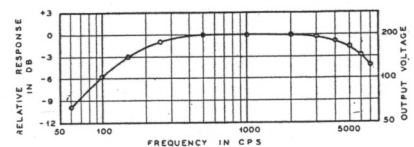

Frequency in C.P.S. Small P.P. 45 to voice coil transformer as output transformer for 37 booster amplifier, measured into 50 to 200 ohm mixer.

When a beat frequency audio oscillator is employed for this grid by grid check it is also possible to determine at what point frequency discrimination takes place. Output transformers—especially class "B"—with large secondary currents, are usually lacking in low frequency response. Screen-grid amplifiers are frequently lacking in high frequency amplification, and although certain frequency response characteristics tend to

balance each other, uniform amplification of all important audio frequencies is not always assured.

A simple check of the overall frequency response of an amplifier-modulator assembly can best be made with the output of the beat frequency oscillator sufficiently attenuated to match the normal amplifier input. The oscillator output should have a low impedance if the amplifier input is normally associated with a carbon, dynamic or ribbon microphone, although a standard high resistance potentiometer can be employed if the amplifier input is normally for a crystal or condenser microphone. With the oscillator set at any convenient frequency from 400 to 1000 cycles, the oscillator output and amplifier gain controls are adjusted to give a conveniently measured output from the amplifier or modulator. As mentioned above, modulator outputs can be roughly determined by noting the changes in modulator plate current although the linear vacuum tube voltmeter described in the March and April issues of "RADIO", or an oxide rectifier type of output meter will yield more accurate measurements.

To determine the frequency response characteristic of the entire system the oscillator frequency is varied and the output noted for each frequency setting. For purposes of plotting the outputs thus obtained are most conveniently recorded as changes from the 1000 cycle response.

As an entire volume could be written on the problem of plotting response, we can only say here that response measurements should be plotted with a simple d.b. scale or as the log of the output voltage or voltage ratio, as a linear plot of any normal frequency response characteristics is quite disappointing though truthful in every respect.

When employing a beat frequency audio oscillator for most accurate over all response measurements, it is advisable to use the output indicating meter to make certain that the oscillator output is the same at all frequencies, although this is not necessary with most commercial oscillators which supply a uniform audio output voltage. Either a high or low impedance output from the oscillator can be employed for most point to point frequency checks although it is advisable to match the oscillator output impedance to that of the circuit being investigated if an accurate measure of gain is required. As most measurements are for the determination of relative response it is not so essential to have exact matching, especially where the oscillator is always connected directly to the grid of the tube.

Any number of interesting problems can be solved and numerous amplifier combinations investigated by means of the beat frequency oscillator. It is frequently possible to arrange the various portions of the amplifier-modulator assembly so that the characteristics of the transformers will compensate for characteristic losses, resulting in uniform or equalized response over the entire voice frequency range. The characteristics of a particular type of microphone can be compensated for in the amplifier and the characteristics of the output transformer can be equalized in the input stages of the amplifier.

Microphones which tend to overemphasize the higher speech frequencies and cause an over abundance of sibilants can be compensated for in the resistance coupled stages by means of the various "tone control" type of terminations. Certain types of ribbon or

(Continued on page 31)

* Engineer, The Audio Tone Oscillator Co.

REVIEW / D of Factory Receivers

THE NEW SARGENT MODEL 10 RECEIVER

● Model 10 is a communication type receiver ideally suited for use in amateur stations, for point-to-point communication and for use on shipboard. The circuit employs a 6D6 stage of sharply tuned RF amplification, 6C6 regenerative detector, 76 audio driver and 42 output. The 80 rectifier, used in the built-in power pack, brings the total number of tubes to five.

In Model 10 particular attention has been paid to obtaining a high efficiency in the coil unit. A coil switching system is used for changing wavebands. The switch is of special construction, each rotor having an extra section to short-circuit all coils to the low frequency side of the frequency on which the set is being operated. (See diagram). "Dead-end" loss can be caused only by coils to the low frequency side, and this method of short-circuiting results in complete elimination of "dead-end" loss. Coils are separated from one another by more than one diameter spacing, and the RF stage coils are in a separate compartment from the detector coils. Both compartments form complete stage shields around the coils. There are no dead spots over the entire tuning range of the receiver, 15-550 meters on the Standard Model and 15-1500 meters on the Marine Model, and the circuit lends itself ideally to extension to still higher waves.

The band-spreading system is a further development of the mechanical band spreader that has been used for two years in Sargent Receivers. The main tuning condenser (right) is mounted on a swivel, instead of being solidly bolted down as in most receivers. A coupling arm, fastened to the rear of the tuning condenser rests on a cam which is turned by the left hand dial—the bandspread dial. This cam has three adjustments so as to give spread for narrow, intermediate or wide bands. When the band-spread dial is turned the cam lifts the coupling arm up or lets it down, thereby moving the stator of the tuning condenser over a small angle. This mechanical method of band-spreading has the advantage of accomplishing the purpose without any interference with the electrical part of the circuit. Hence capacities and inductances used in tuning can be concentrated in one place—an important consideration on the shorter waves. The system is entirely free from play, or backlash, as a spring takes up whatever lost motion might exist.

The band-spread dial is calibrated for direct reading in megacycles on the amateur bands. Band-spread for each band has been designed to cover about 50 degrees (on the basis of 100 "degrees" per half circle), this amount of band-spread being ample for calibration purposes and yet not so much that the operator gets "lost" in the band. The accuracy of the calibration within any amateur band depends upon how closely the main tuning (tank) condenser can be set. In the case of an amateur station having a transmitter of known frequency, a high degree of accuracy can be obtained. In this case, the band-spread dial should be set to the frequency of the transmitter and the transmitter then tuned in to zero beat with the Main Tuning dial. This insures absolute accuracy of the band-spread calibration at this one point, and within the small limits of an amateur band the percentage of accuracy

The new Sargent Model 10 receiver is ideal for amateur reception, in that its sensitivity is unusually high. This is perhaps the most compact and complete receiver in its field. Tests in the laboratory of "RADIO" have proved it to be unusual in performance. The novel short-circuiting switch in the coil-changing unit prevents dead-end losses.

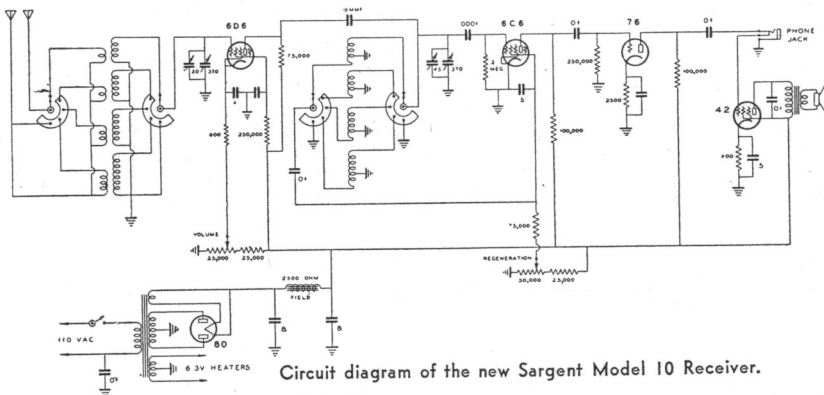
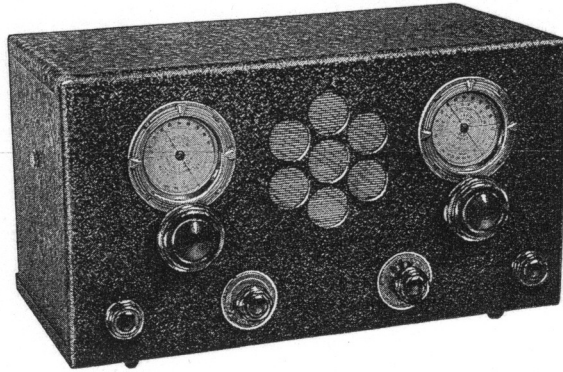

Circuit diagram of the new Sargent Model 10 Receiver.

will remain high. Lacking a transmitter, an accurate setting can still be obtained by using any amateur station of known frequency within the band, or a commercial just outside—TDC for example, on 20 meters.

Model 10 has been isolated as carefully as possible so as to keep it hum-free and to hold the noise level down to a minimum. Individual isolation resistors and by-passes

for this purpose have been freely used in the RF and detector circuits.

Model 10 has a built-in 5-in. speaker, also a headphone jack. Controls, bottom row, left to right, are Regeneration, RF Gain (Cathode of RF tube), Wave Changing Switch, Antenna Circuit Trimmer. The Receiver is furnished for AC, DC or battery operation.

W6HYB— (Continued from page 11)

divider so as to cut down the potential across the mike itself. The pre-amplifier is built into a metal stand on which the mike is supported. The plate-to-line transformer is built into the stand. Filament, plate and line connections are brought out to a six-wire shielded twisted cable, the shield being grounded, as is one side of the 200 ohm line and the mike stand. The power unit for the pre-amplifier is a rebuilt old-style Majestic B eliminator. The AC filament leads inside the pre-amplifier case are run through shielded twisted cable and isolated from the rest of the circuit.

Speech Amplifier and Power Supply

The speech amplifier has three stages, including the driver stage for the class B amplifier. The first two stages have resistance coupling between them and the second stage is transformer coupled to the driver stage.

The Variactors

UTC Variactor 1 is the type CV2 unit. Instructions furnished by the manufacturer give the necessary data for the proper placing of the connecting taps. Variactor 2 is the UTC BV-1 unit, which is used to improve the regulation of the class B audio power supply. Incidentally, regulation can be adjusted so that it will be upward, instead of downward, i.e., over-compensate for voltage drop at full load. The auto-transformer shown in the circuit diagram is an integral part of Variactor 2, self-contained in the unit. It was found necessary in this installation to use from 4 to 8 mfd. of condenser in shunt with the DC winding of Variactor 1, because without this condenser there was no modulation.

Battery bias is used on both the class C amplifier and the linear. For the class C stage 120 volts is used, for the final 180 volts (approx.) is used.

The class C power amplifier plate supply must be entirely independent of any other power supply units.

Amateur News

The Amateur's Legion of Honor

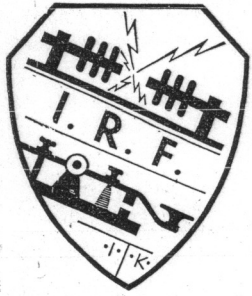

This department is edited by the Secretary of the International Radio Fraternity, Kenneth Isbell, radio W6BOQ, KFI, KECA. All communications concerning the International Radio Fraternity as well as inquiries from any amateur as to the requirements for membership, should be addressed to IRF Headquarters, International Radio Fraternity, 2705 1/2 St. Andrews Place, Los Angeles, California.

● We are pleased to note the steady increase in letters and cards of application into IRF. They are rolling in with the same old rapidity that has always been representative of IRF. It makes us happy, those of us who so freely devote our time toward making this opportunity possible for amateurs all over the globe, to be banded together for the good of each and all. A real fraternity composed of the best there is in amateur radio is a foregone conclusion.

In keeping with this, IRF wishes to again reiterate that you WRITE YOUR CONGRESSMAN NOW! Do it right away. And as stated last month, be sure to identify yourself as an IRF member. Explain all of the tricks of the commercials and how they are so unreasonably holding the channels that were explored and propagated by amateurs, only to be taken from them to make room for the usual commercial "V Channel" with its mere testing signal day and night.

These channels could be used to better advantage and purposes. If we keep after our lawmakers in Washington they will see fit to represent us as AMATEURS at the coming Cairo Conference. IRF members individually and collectively can play a very vital part in bringing this about. Let's cooperate! Now is the time to do what we all pledged when we entered IRF. If you don't exactly agree with us, write us your opinions. We are not dictators. We respectfully solicit your ideas. When we take a stand, as we are now doing, we do so with the knowledge that all who have written in think as we do. We want you to write HQ as to your thoughts on all matters. Do it immediately! IRF is composed of a "thinking bunch". That's what makes a real Fraternity.

● ● ● ● ●
HEADQUARTERS is proud to announce that W9DEA, Leonard Collett, was elected President of the International Radio Fraternity. We welcome you, DEA, and we wish you success! We are sorry to announce that we are unable to publish a picture of the new leader at this time. His being transferred by his concern to Kansas City and the accompanying stress of moving to his new quarters made this impossible. We hope to have a likeness of him in the next issue, also a few words from him.

● ● ● ● ●
ZSZA, O. W. Reid, writes that he is at present off the air, temporarily, but hopes to be active again soon. He states he will be answering cards very shortly.

● ● ● ● ●
Send in your station photos. We need them for publication. Those who wish to join the phone chain, made up of reliable IRF members, should also make application at once. This chain is going to be a big thing. We want more volunteers for this net, so write HQ immediately. Your fone station need not be of terribly high power. Don't miss out on this merely because your station happens to be a low power one.

● ● ● ● ●
Ye Ed. did do the loop-the-loop in his auto when a high power rig tried to modulate it with many voltages. And it succeeded quite well, too, rolling the car over 5 times and wiping off the antenna as well as the top, etc. But I am happy that I am "On Deck" again.

● ● ● ● ●
W6DOB, Lloyd Jones, IRF membership committee chairman, did not think the Southern California sun was hot! But he found that it had more sock than several thousand volts. As a consequence he is suffering third degree burns on his legs. We hope he recovers quickly.

● ● ● ● ●
Let's hear from some of our Eastern members. Summer weather, vacations and what-nots probably are keeping you from sending in your reports. Send them along . . . no matter how small they may be.

Remember to look up IRF when you come to the annual ham convention in Los Angeles, Calif., August 31-September 1 and 2. We hope to have a real IRF get-together there. Come one, come all!

● ● ● ● ●
W7AVL is busy QSOing VU stations. He worked VU2LJ who was only using 11 watts! Not so bad, Leo!

● ● ● ● ●
New Constitutions have been printed and they will be sent out promptly. Lack of funds was the reason why we could not have printed them previously. Pay your dues promptly when they fall due. Be sure to look over the expiration date on your membership certificate and send in your dues. Your dollar barely covers cost of postage and printing.

● ● ● ● ●
W6JTC, Joe Dockendorf, just left West Coast on S.S. Malanton, call WJAO, which will sail coastwise on the Atlantic. He expects to be away for several months.

● ● ● ● ●
W6ESC, Clyde Smith, recently returned from Santa Barbara, Calif., where he installed a large Public Address system at the high school.

● ● ● ● ●
W6EGH, Wally Gee, has just completed his vacation during which he and his family toured Oregon and points north.

● ● ● ● ●
W6HDV, Raymond Stevenson, is plenty busy handling traffic. He had a total of over 500 messages for the past month.

● ● ● ● ●
W6GK, George Glade, is hunting for 7 MC DX. He works lots of DX for the low power he is using.

● ● ● ● ●
W6JWL, Bruce Peterson, has not often been heard of late, so he must be QRL work.

● ● ● ● ●
W6WO, Leonard Robinson, worked two new countries last month and had several European contacts more recently. He thinks times are changing; heard 31 Europeans last month and only 9 so far this month. 14 MC poor also.

The Story of a Rat

● Believe it or not, the following incident occurred in a certain (British) Empire amateur station located less than 2,500 miles from London. The transmitter at this station, a rack and panel arrangement, has three shelves, the top containing the RF portion, and the middle shelf the power supply.

For some weeks certain unmistakable signs had pointed to the not infrequent nightly visits of a rat to the top shelf, with a particularly strong concentration of the above-mentioned signs around an open type crystal holder. Now it is an odd thing that this crystal, which hitherto had led a blameless life, very shortly after the rat's first visits, commenced "perking" on a frequency some 25 KC higher than previously, the inference being that the rat was prowling around with approximately 25 KC worth of quartz in his digestional system. There is a prologue to this.

One evening about 20,000 G.M.T. filaments and heaters were turned on preparatory to a call, allowed to warm up, and the H.T. applied.

The click of the H.T. switch going in was accompanied by a crack like a whip, a large flash, a squeak like a deflating bagpipe, and a hurtling mass of rat type color being ejected at considerable speed by some unseen force from the second shelf. On inspection, the rat, as such it proved to be, staggered unsteadily to beneath a neighboring cupboard, there to pant and gasp in his efforts at self-resuscitation. His decease was completed quickly with a mashie niblick. He had used the top and terminals of an H.T. filter condenser as a step to the top shelf.

It is proposed to bury him with the unconsumed portion of the crystal, and a small headstone to be erected with the following words thereon inscribed:

*Ham Rat, used as a commenser,
A very large filter condenser;
In his search for the crystal,
A crack like a pistol
Changed his soul into a past tenser.
—"The T. & R. Bulletin".*

Pacific Division Convention

● August 31, September 1 and 2 (Labor Day) are the three red-letter days of the year for the Pacific Division. The sixteenth annual convention of this great, progressive division will be held at Los Angeles with headquarters at the Hotel Biltmore. Everything that goes to make a convention complete is on the program. There are visits to recording studios, brand-new technical developments, professional vaudeville, Wouff-Hong initiation, Army, Navy, DX, CW and phone meetings, trips to movie studios with production demonstrated, open forum, ham-fests, brewery visits; and a banquet that is a banquet; prizes that will make the chills play up and own your spine.

One of the biggest programs ever offered, it will include many new departures in arrangements. The major one is the placing of the banquet and prize drawing on Sunday evening, September 1. This will allow those who live at a distance to leave at any time they feel necessary, although this does not mean that Monday will not be full of interesting affairs. The convention will close Monday afternoon, allowing ample time to rest before again starting the daily grind.

Nothing has been overlooked in an effort to make this the outstanding convention of all time. Notables from the ranks of Ham Radio will be in attendance to give the latest developments on all phases of the greatest hobby ever. There will be no lag in the program. "Something doing every minute" will be the slogan. This is the last time that the Southwestern gang will have the pleasure of being hosts to the entire Pacific Division and the boys cordially invite everyone to sample the Southern hospitality. Everything possible will be done to make the visitor feel at home.

Hotel rates in Los Angeles, within the radius of the metropolitan area less than two blocks from convention headquarters, range from \$1.00 per person up. Special provisions to care for delegates have been made at all the hotels close to the headquarters and special prices will prevail. Special arrangements for parking have also been made.

The price of tickets is \$3.00 which covers admission to all the functions, including the banquet and big prize drawing, for the entire three days, during which several surprise features will be forthcoming. There are several FB reservation prizes for the holders of the lucky tickets which are purchased or ordered before August 25. To be assured of being well-cared for, get your tickets before that date. Send all reservation or requests for tickets to: K, Kiernan, W6BPM, 220 E. Newmark St., Monterey Park, Calif.

Hold those three days, August 31, September 1 and 2 open for the biggest time you ever had! We'll see you there.

K7BC QSL Cards

All QSL cards for K7BC must hereafter be forwarded to Edwin R. Stevens, W7BB.

First Alaskan WAC?

A report has been received that K7BC, Ed. Stevens, Shumagin Islands, Alaska, is the first Alaskan amateur to enter the charmed circle of WAC. Stations worked: VK3OJ, LU4CB, XU9Y, U3AG, W1TS, ZG6AL.

Foreign Reports Wanted

"RADIO" subscribers in foreign countries are kindly asked to send monthly lists of CALLS HEARD. Numerous requests have been received from U. S. readers asking that these foreign calls-heard lists be published. Will our foreign subscribers be so kind as to send these lists regularly? Thank you.

2½ or 5 Meter Super-Regenerative Receiver

By FRANK LESTER*

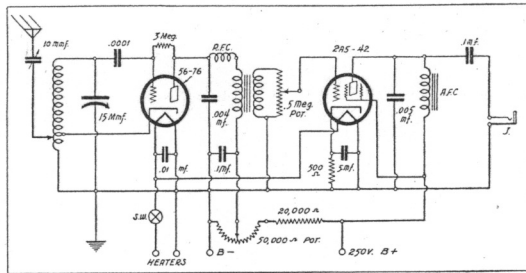
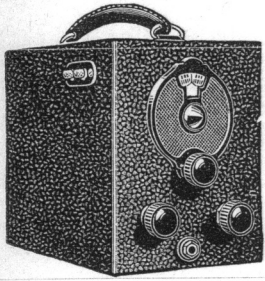

- ★ Highly Sensitive—Low Hiss
- ★ A. C. or Battery Operation
- ★ Copper Plated Chassis
- ★ Electron-Coupled Detector

• For ease of construction, simplicity of control and reliability of operation the super-regenerative circuit developed by Mr. George W. Shuart, W2AMN, of Ramsey, N. J., is of particular interest. This circuit may be used on either 2½ or 5 meters, depending on the size of the tuning coil.

The electron-coupling arrangement of the detector circuit permits the use of a grounded tuning condenser and a single tapped coil, one end of which is also grounded. The advantages and convenience of this scheme will be appreciated by every "ham" who has tried the usual split-coil hookup which requires a "floating" condenser.

Leak Controls "Super" Action

Super-regenerative action is produced by the grid-leak connected between the grid and the plate of the detector tube. While its value is not very critical and three megohms has been chosen as the optimum, different tubes may require slightly different resistor values and it will pay the constructor to do a little experimenting at this point. The higher the value of the leak the lower the audio output of the detector, but the greater the sensitivity and vice-versa.

For five-meter work the coil consists of 7 turns of No. 12 bare copper wire (tinned bus bar is excellent), wound around a form a half inch in diameter, and then slipped off. The spacing between turns should be about ⅛ inch. The cathode tap is two to four turns from the grounded end depending upon the particular tube being used.

The antenna tap is a matter of experiment, but as a starter it should be made to the cathode connection of the coil.

For two and a half meters the coil consists of four turns of No. 12 wire wound in the same manner as the larger coil.

Choice of Tubes

The detector may be either a 56 or a 76, the audio amplifier a 2A5 or a 42. The 76-42 combination is recommended since the heaters work on 6.3 volts and the finished receiver may be used with only a slight change on either AC, with a separate power pack, or on batteries for mobile operation. There is no appreciable difference between the two types of tubes in the results obtained, the choice between them depending on the available power supply and the probability of the set seeing portable service. It is a good idea to try more than one detector tube of the same type number. Some tubes are noticeably better super-regenerators than others and give much better all around results. Different leaks should also be tried.

*Engineer, Wholesale Radio Service Co.

Note that a volume control in the form of a potentiometer across the AF transformer secondary is used independently of the regeneration control in the plate circuit of the detector.

Hiss Disappears During Reception

In operation this receiver will produce a strong hiss which will drop in intensity considerably or disappear altogether when a station is tuned in. The .005 mfd. fixed condenser between the plate of the output tube and ground will help to reduce this noise.

AT W2AMN, W2AMJ and other stations, this receiver is used almost exclusively with a magnetic loud speaker because it has plenty of "hop". It lends itself nicely to duplex operation because of the complete shielding. Almost any kind of antenna will work although of course the best results will be obtained with a half-wave vertical antenna as high and clear as possible.

Available in Kit Form

Since the required parts for this receiver are few and small they can be built onto a very small chassis. A special chassis copper plated to provide a low resistance path for RF currents, and completely punched and formed is supplied with the Kit which also includes a black crystalline lacquered cabinet with a carrying handle. The case measures only 8¾ by 6½ by 5⅛ inches. It is constructed in two sections which separate to allow easy assembly of the receiver. It is ideal for portable and mobile use because it is compact and light in weight.

In and around New York, northern New Jersey and the Yonkers region where 5 meter activity is particularly pronounced at the present time, this receiver is very popular and has replaced many three tube sets which use a separate low frequency oscillator to obtain super-regeneration.

Parts List

- 1—Steel Case with Special Chassis
- 1—National Vernier Dial
- 1—Phone Jack
- 1—50,000 Ohm Regeneration Control
- 1—500,000 Ohm Volume Control
- 1—15 Mmfd. Tuning Condenser
- 1—.0001Mfd. Fixed Mica Condenser
- 1—.01 Paper By-Pass Condenser
- 2—.1 Paper By-Pass Condenser
- 1—.004 Fixed Mica Condenser
- 1—5 Mfd. Electrolytic Condenser
- 1—.005 Fixed Mica Condenser
- 1—3 to 30 Mmfd. Trimmer Condenser
- 1—500 Ohm 10 Watt Resistor—Wire Wound
- 1—3 Megohm ½ Watt Carbon Resistor
- 1—20,000 Ohm 1 Watt Carbon Resistor
- 1—Special 1:4 Ratio Audio Transformer
- 1—Audio Output Choke
- 1—R.F. Choke
- 1—Length of Tinned Bus Bar
- 1—5 Prong Isotex Socket
- 1—6 Prong Wafer Socket
- 1—4 Prong Speaker Plug and Cord
- 1—Antenna—Ground Binding Post Strip
- Miscellaneous Hardware
- Instruction Sheet and Diagrams

New Products

No Pre-Amplifier Required With New High Impedance Velocity Microphone

RETAINING such features as natural reproduction without peaks and the elimination of feedback, the new high impedance velocity microphone by Amperite has the added feature of operating directly into the grid—meaning the elimination of the

input transformer, the principal source of hum trouble, and the elimination of the pre-amplifier with amplifiers having a gain of 100 db. or more. The high impedance microphone can be fed directly into the photo-electric cell jack of "talky" amplifiers without any circuit changes. Condenser and crystal microphones can also be replaced in a similar manner. Another distinct advantage of the high impedance velocity is the fact that ordinary carbon volume controls can be used as mixers. Special low capacity coupling is used

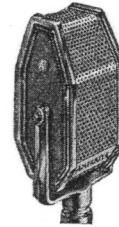

for the microphone lead which should not run over 30'. For longer lines, compensation for the lower impedance velocities should be used.

Half K.W. Transmitter

(Continued from page 13)

for fast sending. There is no click when the latter method is used, but only a small amount of filter can be used. The oscillograph showed a decided hum on the carrier with only one section of filter, but monitor tests on a linear rectifier indicated very little hum by ear—it is comparable with the better class of present-day CW signals.

On 20 meters, a 40 meter crystal was used with the 6A6 as a doubler to 20. The grid current to the 10 tubes ran between 8 and 10 MA with the plate current of the latter running about 135 to 145 MA at 600 volts supply. The oscillator cathode current was about 70 to 75 MA. The grid current on the final ran between 40 and 50 MA under load, and the output of the 211 stage was very nearly as great as at 40 meters. With the same output, the plate current ran about 10% higher on 20 meters. The final amplifier seemed to neutralize more completely on 20 than on 40, and no parasitic trouble was encountered. The link coupling had to be a little less than one turn to effectively give maximum transfer between stages.

COIL TABLE

Final Amp. Plate

- Meters
40—16 turns No. 10 E. 3½" d., 5¼" long. CT
20—8 turns No. 10 E. 3¼" d., 5½" long. CT

Final Amp. Grid and Buffer Amp. Plate

- Meters
40—15 turns No. 16 E. 2¼" d., 1¾" long. CT
20—9¾ turns No. 16 E. 1½" d., 1½" long. CT

Buffer Amp. Grid and Doubler Plate

- Meters
40—22 turns No. 18 E. 1½" d., 1¾" long. CT
20—10 turns No. 18 E. 1½" d., 1¾" long. CT

Osc. Coil for 40 & 20 Meter Operation

- Meters
80—31 turns No. 18 E. closewound, 1½" d.
40—22 turns No. 18 E. 1½" d., 1¾" long.
(E denotes enameled wire, d denotes diameter of coil.)

The New Armstrong Frequency Modulation System

When Major Armstrong, inventor of the oscillating circuit, says he has something new, the whole radio world takes notice. His latest development is an entirely new method of modulation that minimizes selective fading and atmospheric interference. His system uses frequency modulation instead of amplitude modulation. The system uses a variable sideband width, extending outward to a maximum of about 150 KC which means that the system is limited to the ultra short waves, for the time being. The new system lends itself to quadruplex operation on one channel.

Frequency modulation of the radiated carrier is obtained by a new method and the amplitude of the radiated wave is kept constant by means of current limiters. The swing in carrier frequency caused by the signal modulation is purposely made as wide as possible, which accounts for the 150 KC maximum band width.

The receivers are double supers (triple detection) and the third detector, or audio demodulator, consists of two tubes in push-pull, which tends to balance out atmospheric and set noise while responding to the signal modulation on the received carrier.

The principal advantages in the system seem to lie in the field of high fidelity broadcasting and television, although probably some enterprising amateur will soon find a use for some of the many new features in the amateur bands.

Speaker Fidelity

● The weakest link in all voice communication by radio is the loud speaker at the receiving end. The fidelity of all other transmitter and receiver components has been improved tremendously and practically perfect freedom from frequency and amplitude distortion can be obtained if one wants to pay for it. However, a recent group of both field and pressure tests on most of the so-called "high quality" speakers found none of them flat to even 10 db between 100 and 8000 cycles. It was also found that no two speakers of the same make had the same variations in frequency response, so that equalization is practically impossible in production. If the audio range is extended down to 40 cycles and up to 10,000 cycles, a tolerance of 15 DB will exclude practically every speaker made.

The situation in regard to amplitude, or harmonic distortion is even worse than the sad state of the frequency response depicted above. None of the speakers measured was capable of handling its rated power output without introducing at least 5% harmonic distortion; the vast majority introduced more than 12% distortion.

It was also found that only one make of 10 inch speaker could get down to 100 cycles without 10 DB of loss from the 400 cycle reference point, and none of the smaller diameter speakers could even get down to 200 cycles with less than 10 DB loss. 10 DB means a loss of 90% of the power present at zero level.

It looks like an entirely new speaker principle is due to be invented before long, if necessity is still the mother of invention.

Simple Two-Band Vertical Antenna

● Vertical antennas are very useful for long distance transmission in all directions. The antenna shown in Fig. 1 is a center-fed half wave Zepp for 40 meter operation and consists of two end-fed half waves excited in

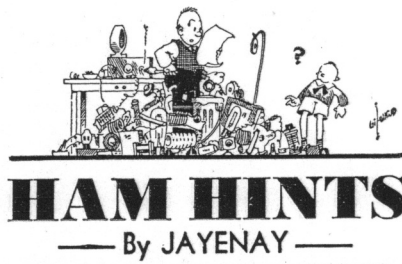

phase when operated on 20 meters. This antenna is particularly desirable for 20 meter operation because it provides a low angle radiation which is not obtained with the usual full wave 20 meter vertical antenna because the two halves of the full wave antenna are out of phase, resulting in high angle radiation.

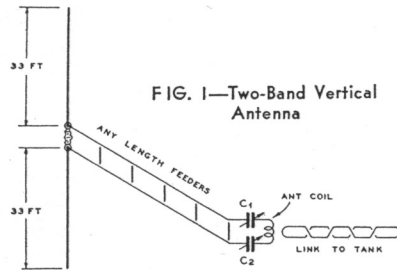

The feeders can be of any convenient length and should be well isolated from metallic objects because the feeders have standing waves on them. The feeder separators should be able to withstand high voltages. The feeder circuit must be tuned at the station end to some multiple of half waves. Series tuning is shown, but parallel tuning can be used, where required. Series tuning will usually allow more power into the antenna because there is less loss in the large series tuned coil than in a small shunt tuned coil. The antenna ammeter will indicate very low values of current for 20 meter operation, but fairly high values will be indicated on 40 meters.

Receiver Noise Reduction By Means of An Antenna Pre-Amplifier

● Most of the noise which appears in the output of a high frequency receiver is picked-up in the transmission line between the antenna and the receiver. The use of a twisted-

pair transmission line tends to reduce this noise somewhat, but in many cases there is still enough line pick-up to make weak signals unreadable. The pre-amplifier shown in Fig. 2 is mounted in the air, at the center of a doublet antenna, so that it amplifies the signal but not the noise, which would be the case when a pre-amplifier is located alongside the receiver.

The two tubes in the pre-amplifier can be mounted in a small, compact weatherproof coffee can, secured to an insulator located in the center of the doublet antenna. This pre-amplifier is not tuned, but the grid and plate chokes are resonated at the center of the band of frequencies which it is desired to receive. By adjusting the number of turns on L2, L3, L4 and L5 the pre-amplifier will give good gain all the way across any one of the amateur or short-wave broadcast bands. Coil data will depend on the size of form used, but in general a 1/2-in. form with a 1-in. winding similar to that used in the "222" Receiver will permit of optimum compactness. In some cases it may be desirable to use trimmer condensers in shunt with the coils in order to tune them to the desired band.

The circuit is conventional, except for the method of feeding the heater and plate voltage through the same shielded cable which carries the amplified signal to the receiver. The external shield on the cable carries the positive plate voltage, and therefore the cable should be isolated from grounded objects. If a four conductor cable is available this precaution is unnecessary.

The screen voltage divider uses a 30,000 ohm resistor between B+ and screen, and a 10,000 ohm resistor between screen and ground. The capacity of the by-pass condenser is .01 ufd. The heaters are wired in series and the voltage is applied from a filament transformer located in the radio room. The voltage will range from about 15 to 25 volts, depending on the length of the shield cable. The voltage should be adjusted with an AC ammeter in series with one side of the line. The heater voltage should be varied until the two heaters in series draw 300 mills for the 6D6, or 150 mills if acorn 954 tubes are used.

The device is satisfactory only for one-band operation, as is also the case with a doublet antenna. This pre-amplifier should be particularly beneficial to the radio dealer who demonstrates all-wave receivers in a noisy location. The use of three pre-amplifiers and three doublet antennas to cover the three most popular short-wave broadcast bands (49, 31, 25 meters) will enable the user to secure fine program quality from distant stations.

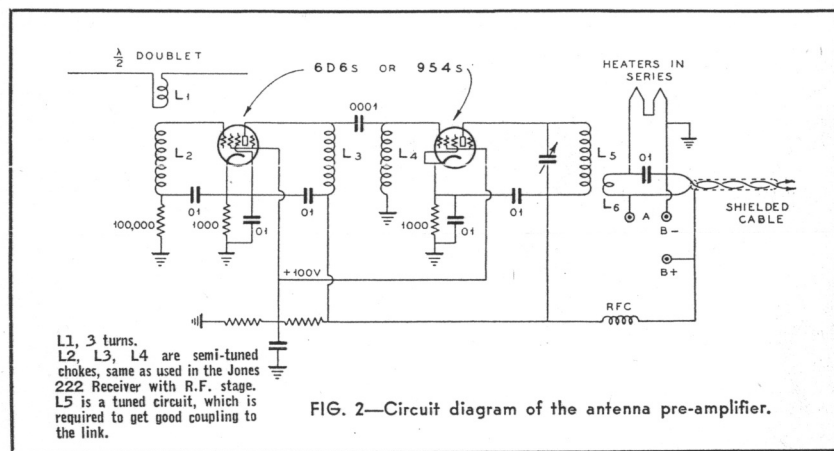

EIMAC Tubes—More Power, Less Cost

W6HYB Reports Excellent Results From His New Controlled Carrier Phone Transmitter

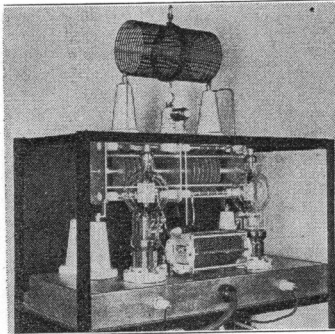

1 KW maximum input, 500 watts equivalent carrier output and 250 watts maximum sideband output.

● W6HYB has long been known for the consistent DX he has worked on phone on low power. His input has been less than 50 watts for several years. He recently added Variactor carrier control to his 50 watt class C stage and added a 1 KW class B linear amplifier using push-pull 150Ts which brought his effective carrier OUTPUT up to 500 watts.

He is to be congratulated on the especially nice mechanical and electrical layout of the final amplifier as all RF leads are short and symmetrical. It is estimated that W6HYB's rig can be duplicated for about \$350.00 (without meters). This works out at materially less than one dollar per watt of carrier output, which represents real transmitter economy. We are proud of the fact that W6HYB chose EIMACS for his final amplifier.

30,000 Meters

● The outstanding advantages of all EIMAC tubes at the high and ultra-high frequencies are well known. However, it is interesting to note that EIMAC 150Ts were chosen by a large industrial organization for a special low frequency oscillator application. Large amounts of power were required at 10,000 cycles (30,000 meters) to heat movable steel electrodes by eddy current and hysteresis losses. As the load on the oscillator varies over wide limits, a high safety factor must be provided in the oscillator tubes.

Again the flexibility and ruggedness of EIMAC design and construction proves that EIMACS ARE UNSURPASSED.

No. 5
of a
Series
of 12

Your Problems—and Their Solution Ultra High Frequency Operation

THE 10, 5, 2½ and 1¼ meter bands are rapidly finding wide use among amateurs and two way QSOs of over 900 miles on 5 meters have been reported.

One of the major problems on the higher frequencies is to obtain a low loss tank circuit in order to obtain high plate efficiency and frequency stability. We have found that the main source of tank circuit losses can be traced to excessive lead inductance, inter-electrode capacity and RF lead resistance in the tube used in the ultra-high frequency oscillator or amplifier. The answer is to use a tube designed for low inductance, capacity and resistance at the higher frequencies. The EIMAC 50T is ideal for use below 10 meters. A satisfactory 5 meter tank coil consists of eight turns, one and three quarters inches in diameter, tuned by a 1.5 uufd. variable condenser. The best test for any tank circuit is to measure the DC plate current with the antenna disconnected. With the 50T in this particular MOPA transmitter the minimum plate current dropped below 15 MA with 1000 volts on the plate. The oscillator was a type 45 running at 250 volts.

While the Terman parallel rod and Kolster Hat type of tuned circuits are very satisfactory, particularly at 2½ and 1¼ meters, very good results can be obtained at 5 meters and above with conventional tank coils, due to the fact that the exclusive low loss design of all EIMAC tubes minimizes the stray shunt impedance reflected across the tank circuit by ordinary tubes.

The elimination of internal insulators and the reduction of dielectric in the field of the plate means that high frequency arc-over and breakdown is unknown among users of EIMAC tubes. The input and output of EIMAC tubes is largely limited only by circuit efficiency and not by poor internal insulation. If efficient tank circuits are used, EIMAC tubes can give just as much output on 75 megacycles and above as on the lower frequencies. The short leads and extremely low interelectrode capacities. (Cap 2 uufds., Cpf 4 uufds., Cpf 2 uufds.) mean that the absolute minimum of stray inductance and capacity is shunted across the external tank circuits. The use of three parallel leads from the plate to the plate cap means a tremendous reduction in the lead resistance. The resistance at 5 meters of a large lead through a glass seal has been found to be about 100 ohms. The resistance of a small lead wire can be as high as 400 ohms. It is evident that reducing this resistance to below 35 ohms in EIMAC tubes represents a marked improvement, and allows materially lower losses with higher output.

One of our leading Universities reports operating a 50T in a modified BK oscillator on 2.5 CENTIMETERS, which is a frequency of 12,000 MEGACYCLES or 12,000,000 Kilocycles. The use of a Tantalum grid made the 50T the only tube that could be used for this application as the grid dissipation is quite high in this type of oscillator.

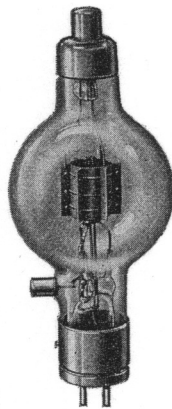

EIMAC 50T
Net - - - \$13.50

Compare and Reflect CONSERVATIVE RATINGS

50T

50 Watts of Available Plate Dissipation . . .
30 Watts of Filament Heating Power!

CHARACTERISTICS
Fil. Voltage 5V; Fil. Current 6A; Rated Plate Dissipation 50W; Amp. Factor 14; Max. Plate Current 100MA. Plate Voltage 1000 - Power Output 75W. Plate Voltage 2000 - Power Output 150W. Plate Voltage 3000 - Power Output 250W.

150T

150 Watts of Available Plate Dissipation . . .
50 Watts of Filament Heating Power!

CHARACTERISTICS
Fil. Voltage 5V; Fil. Current 10A; Rated Plate Dissipation 150W; Amp. Factor 14; Max. Plate Current 200MA. Plate Voltage 1000 - Power Output 150W Plate Voltage 2000 - Power Output 300W; Plate Voltage 3000 - Power Output 450W.

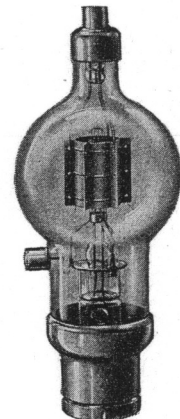

EIMAC 150T
Net - - - \$24.50

EITEL-McCULLOUGH, INC.

SAN BRUNO, CALIFORNIA, U. S. A.

Write us if you can't get EIMAC'S from your dealer

- | | | | |
|--|---|---|--|
| Albany, N. Y.
Uncle Dave | Detroit, Mich.
Radio Specialties Co. | Milwaukee, Wis.
Radio Parts Co. | Providence, R. I.
W. H. Edwards & Co. |
| Atlanta, Georgia.
Wholesale Radio. | Denver, Colorado.
Interstate Radio | Newark, New Jersey.
Wholesale Radio Svc. | Reading, Pa.
George D. Barbey Co. |
| Baltimore, Maryland
Radio Electric Svc. | Fayetteville, N. C.
Hunter Brothers. | New Orleans, La.
Shuler Supply Co. | St. Louis, Mo.
Walt. Ashe Radio Co. |
| Boston, Mass.
H. Jappe Co.
The Radio Shack. | Fresno, California.
Ports Mfg. Co. | New York City.
Gross Radio, Inc.
Wholesale Radio Svc. | St. Paul, Minnesota.
Lew Bonn Company. |
| Buffalo, N. Y.
Dymac Radio | Honolulu, T. H.
Honolulu Furniture Co. | Oakland, California.
Electric Supply Co.
E. C. Wenger Co. | San Francisco, Cal.
Offenbach Electric. |
| Butler, Missouri.
Henry Radio Shop. | Indianapolis, Ind.
Stanley Jewelry Co. | Oklahoma City, Okla.
Southern Sales Co. | Seattle, Washington
Seattle Radio Supply. |
| Chicago, Illinois.
Allied Radio Corp.
Chirad
Midwest Radio Mart.
Newark Electric Co. | Jacksonville, Fla.
Glover-Weiss Co. | Peoria, Illinois.
Radio Mfg. Engrs. | Spokane, Washington.
Spokane Radio Co. |
| Cleveland, Ohio.
Northern Ohio Labs. | Kansas City, Mo.
Radio Laboratories
LaCrosse, Wisconsin.
SOS Radio Supply. | Philadelphia, Pa.
Radio Electric Svc.
Herbach & Rademan | Spokane, Ark.
Mim's Radio |
| Dayton, Ohio
Standard Radio Parts | Los Angeles, Cal.
Radio Supply Co.
Radio Television. | Pittsburgh, Penna.
Cameradio Co. | Texasarkana, Ark.
Mim's Radio |
| Des Moines, Iowa
Iowa Radio Corp. | | Portland, Oregon.
Wedel Company, Inc. | Toronto, Ont.
Canadian Tire Corp. |
| | | | Tulsa, Oklahoma.
Radio, Inc. |
| | | | Wheeling, W. Va.
Cameradio Co. |

The Choice of Modulation Tubes

By J. N. A. HAWKINS

● The function of the modulator tube, or tubes, in any power modulation system, is to superimpose an AC voltage wave on the DC power supply voltage which supplies plate voltage to the modulated RF amplifier. When an AC voltage is superimposed on a DC voltage, the resultant voltage is still unidirectional, as long as the peak value of the AC voltage is less than the DC voltage, as it is at all percentages of modulation under 100 per-cent, although this unidirectional voltage is varying in amplitude. During periods of 100 per cent modulation, this voltage alternately swings from the normal DC value, down to zero volts . . . then up to twice normal and then back to the normal value again. The modulator tubes provide the means of swinging this DC plate voltage up and down over the unmodulated value. If there is a load across the DC power supply, as there always is when the RF modulated amplifier is drawing plate current, it then requires power to swing the DC plate voltage up and down. The power necessary to produce this voltage swing is proportional to the DC power that flows in the circuit when the carrier is unmodulated. The AC power that must be supplied by the modulators is proportional to the percentage of modulation and this power exactly equals one-half of the DC power under the condition of maximum, or 100 per-cent modulation. Thus the maximum undistorted audio power output of the modulator tube, or tubes, must equal 50 per-cent of the DC plate power that flows into the modulated RF amplifier.

The choice of the modulator tubes will, therefore, depend on the tubes used in the modulated RF amplifier, and upon the plate voltage and power input to that RF amplifier.

In the majority of amateur stations which use some form of power modulation, it is found that the same plate power supply is used to supply plate voltage to both the final modulated RF amplifier and the modulator.

A convenient way to classify and subdivide the various kinds of modulators is to separate them into push-pull and single-ended modulators.

Single Ended Modulators

Single ended modulators always operate strictly class A and 99 per-cent of the time they will operate from the same plate power supply that feeds the modulated amplifier. Also 99 per-cent of the time the class A single ended modulator will operate at a somewhat higher plate voltage than the plate voltage applied to the final amplifier. A dropping resistor in series with the B plus lead to the modulated amplifier will usually be used to drop the voltage applied to the modulated stage.

The choice of a single-ended class A modulator will usually be made from among the tubes available with a relatively low plate resistance. Such tubes will generally be found to also have a low amplification factor. Examples are 71A, 45, 2A3, 842, 250, 845, 284A, etc. Other tubes that have a fairly low plate resistance, and although having a somewhat higher amplification factor than those in the above list, include the 12A, 210, 211, 830, 242A, 354, 212D and 150T. These tubes are also often used in class A modulation circuits. In the high-power field, practically the only tubes available are high mu, high plate resistance tubes (relatively) such as the 204A, 849 and 851. These tubes are sometimes used in class A and the 851 is particu-

larly useful, although, in general, class AB or class B modulation is used where more than about 100 watts of audio power is needed.

Single-ended modulators have the advantage that expensive audio driver stages are unnecessary because the grid of a class A amplifier never goes positive. This means that no POWER is drawn from the preceding audio stage and the input coupling device can be an ordinary audio transformer. Usually no special output transformer or tapped choke is necessary and any good high inductance choke can be used as the coupling device between the single-ended modulator and the modulated amplifier. The adjustment of a class A modulator is not critical and considerable maladjustment can be tolerated before the speech quality is seriously impaired.

Audio pentodes usually make quite satisfactory low-powered class A modulators because they usually have good power sensitivity and give good power output for their size.

The main disadvantage of class A modula-

an output coupling transformer with electrically separate primary and secondary windings, it is a simple matter to isolate the plate circuit of the modulated amplifier from the plate circuit of the modulators, as far as the DC plate supply voltages are concerned.

It is very hard to accurately define the difference between class A-B and class B modulator operation. Class A-B can be defined as extended class A operation. By the same token, class B can also be defined as extended class A-B operation. In general, class A Prime and class B modulator considerations are very similar. Usually the push-pull, over-biased operation of low mu tubes is called class A-B, while the push-pull, over-biased operation of medium and high mu tubes is called class B operation. All over-biased audio amplifiers MUST be operated in push-pull to minimize the otherwise excessive harmonic distortion.

The following table shows some of the differences between these three types of modulators.

Tubes suitable for use as class A-B modulators are those listed above under class A operation. The grids are often driven positive and it is therefore desirable to choose the tube with the highest transcon-

ductance because such a tube will usually require the least grid driving power. A large amount of filament emission (usually indicated by a large amount of filament heating power), is usually more important than high plate dissipation.

Class B operation of modulators usually utilizes the medium and high mu tubes. In general, the medium mu tubes will be found to have the highest transconductance, and therefore will require the least

grid driving power, for a given power output. However, the medium mu tubes require more bias to reach cut-off, at a given plate voltage, so that the separate bias supply will be somewhat more expensive. However, the newer class B audio amplifiers and modulators in the medium and high powered field utilize the medium mu tubes because the additional grid drive required by the higher mu tubes costs more than the additional cost of the bias supply required by the medium mu class B tubes. The best medium mu class B tubes include the 210, 211, 242A, 212E, 354, 150T, 354, etc. The higher mu class B tubes include the 46, 59, 53, 6A6, 19, 89, NCB, 203A and 204A. As in class A-B modulators, it pays to look for high transconductance (formerly called Mutual Conductance) and high filament emission, rather than high plate dissipation.

Transformer Losses

Few amateurs realize that losses can be quite high in cheap class B output transformers. When exceptionally good transformers are used these losses can be held down to 2 per-cent or less, whereas when cheaper transformers are used these losses can be as great as 10 per-cent. Audio power is more expensive than the difference in cost between good and cheap output transformers and therefore it is good economy to buy the best.

Audio Amplifiers

Types of tubes commonly used	Class A low mu	Class A-B low mu	Class B medium and high mu
Bias Voltage	approx. half way between 0 bias and cut-off	between class A and class B bias	slightly less than cut-off
Can Bias be obtained from cathode resistor?	always	sometimes but not recommended	never
Is grid current drawn on voice peaks?	never	sometimes	always
Must the driver tube supply Power?	never	sometimes	always
Plate current variation during modulation.	none	increases 100 to 300%	increases 500 to 1500%

tion is that is usually more expensive, for a given amount of power output, than an equivalent class A-B or class B modulator. Class A modulators, using triode tubes as modulators, are rarely more than 20 per cent efficient. That is, the class A modulator is a rather inefficient converter of DC plate power into AC audio power. If the efficiency is 20 per-cent, then the maximum audio output equals 20 per-cent of the DC plate input to the modulator. The other 80 per-cent is radiated from the plate of the modulator tube in the form of heat. Because tube costs vary closely with the heat radiating ability of the plate, class A modulation requires an expensive tube whose plate dissipation rating must be from three to five times the power output (audio) to be obtained.

Push-Pull Modulators

Push-pull modulation systems include class A, class A-B, and class B audio amplifiers.

Push-pull modulators USUALLY utilize the same plate power supply that feeds the final amplifier, but quite often they do not. The plate current to practically all push-pull modulators varies rather widely with the percentage of modulation and therefore the plate power supply must have good voltage regulation with variations in load.

Because most push-pull modulators use

COMPLETE DESIGNS of 20 TRANSMITTERS

12 tested transmitter R. F. section designs! 8 modulator and speech amplifier designs!

Outputs ranging from a little fellow on which the O.W. can learn, to big ones comparing in every way with the best broadcaster.

Circuit, and complete parts specifications of transformers, inductances, and all other component parts.

One of the most complete and thorough handbooks on transmitter design ever printed!

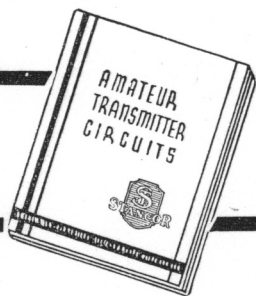

FREE!
VALUABLE
REFERENCE BOOK

This advertisement and 12c IN STAMPS, to cover mailing expenses, will bring your FREE copy of this valuable Reference Book. There is no obligation.

**STANDARD
TRANSFORMER
CORP.**



855
Blackhawk
Street
Chicago Ill.

**\$1 Brings You the Next
Four Issues of
"RADIO"
—Subscribe NOW**

ASTATIC

CRYSTAL MICROPHONES AND PICKUPS

Guaranteed instruments, known for their quality, dependability and ruggedness. Extensively used in both Professional and Amateur fields. Send for your literature today!

ASTATIC MICROPHONE LABORATORY INC., YOUNGSTOWN, OHIO

Radiatorial Comment

(Continued from page 3)

Sumner B. Young

Elsewhere in this issue is reprinted a copy of a letter from Sumner B. Young, brilliant attorney of Minneapolis and one of amateur radio's outstanding champions, to one James H. Platz of Elmhurst, Illinois. There is always space between the four covers of "RADIO" for the printing of material which Mr. Young submits for publication . . . likewise, there is ample space for the publication of letters from Warner supporters who, at this late date, may desire to rally to the cause of their battle-scarred chief. Mr. Young contends that Warner should be removed from office because of incompetence. The waning interest in League affairs is attributed by Mr. Young to lack of faith in the Warner machine.

Young is for the League—first, last and always (so are we). Every sane amateur knows that this gigantic hobby of ours must be ruled with an iron hand, by iron men. Powerful interests are at work to swallow-up the few tid-bits of the frequency spectrum in which the amateur is still permitted to scratch. In Mr. Young's file is a letter from "RADIO", in which he is told that this magazine will bring to an abrupt halt its campaign the moment more capable men are appointed to ARRL administrative offices. Once it becomes definitely known that the Board of Directors of the ARRL, and ALL OF THE LEAGUE EXECUTIVES unite to bring about a drastic change in the conditions which have confronted this hobby of ours, there will be nothing for this magazine to talk about . . . except words of praise for the League and all of its executives. We pray the day is not far distant when a united effort by all amateur magazine publishers can be made so that a gigantic campaign of constructive work can be undertaken. The ARRL's Investigating Committee can do its part to bring about a revolutionary change in the administrative affairs of the League. Such charges as are filed with that committee should be investigated without bias. One of the committeemen has already been supplied with a choice collection of charges. If the charges are proved, it becomes the solemn duty of the committee to report its findings to the entire amateur fraternity. If found untrue, it likewise becomes the solemn duty of that committee to PROVE the charges UNTRUE. If you, as a part owner of a corporation, charged an executive with incompetence . . . and if you reported to a director of that corporation that you wanted an investigation made, proof or no proof, it is the duty of that director to investigate your charges if they stand investigating. So let it not be said that the committee will investigate only such charges as are PROVED IN ADVANCE. The committee can find the proof, if it is seriously interested in INVESTIGATING THE CHARGES. The clues are given . . . the detectives can work on those clues, and if they don't find the answer perhaps someone else will be able to supply it. If those who press the charges are also asked to PROVE the charges, there is no need for an investigating committee, because it would then have NOTHING to investigate!

DIP or BRUSH R.F. COMPONENTS with Q-MAX No. 3

The only Victron base R.F. Coating

Do not destroy the efficiency of your apparatus by the use of ordinary lacquers never intended for high frequency service. USE Q-MAX No. 3. \$.25 per can at your dealer's store.

Communication Products, Inc.

245 Custer Avenue Jersey City, N. J.



Crystals, 80 and 160 meters, \$1.35. Get yours from The QSL Man, W9DGH, 1816 North Fifth Avenue, Minneapolis, Minnesota.

ENGRAVING instrument panels exclusively since 1925. A. L. Woody, 189 W. Madison Street, Chicago, Illinois.

Code machines, tapes and instruction for rent or sale. Rent may be applied on purchase if desired. Instructograph, 912 Lakeside Place, Chicago.

BARGAINS—Western Electric 250 watters, 212D. Used but excellent condition; two at \$15.00 each, both for \$25.00. Electric Hammer Drill "Syntron" make, for concrete, stone, brick or masonry, takes up to 5/8-in. drills; ideal for electrical contractor. Cost new \$135, sell for \$50.00, complete with cord and fibre carrying case. Good condition.

Cameras: 1 6 1/2 x 8 1/2 VView camera, 24-in. bellows, cannot be told from new, Wollensak triple convertible lens, 12-in., 18-in., 23 1/2-in., focal lengths, extra 8 x 10 wide angle lens, plate holders, film holders, carrying case and exposure meter; outfit cost over \$150, sell for \$35.

Used folding 5 x 7 camera, film and plate holders, in carrying case, Bausch & Lomb lens, \$10.00, good condition.

Enlarger, 5 x 7 Eastman, Ross lens (English) used but in good condition, \$10.00.

Motion picture camera, 35 mm. (Standard film) Willart make, all metal, with detachable 200-foot magazine, visual focus and footage indicator, Wollensak F 5.5 lens, tripod, with pan and tilt head, fine for newsreel man; including 500 feet unused panchromatic film; cost new about \$300.00, sell for \$75.00. Might trade for Leica camera.

D. B. McGown, W6ZE, 3950 Ortega Street, San Francisco, Calif.

One RCA Oscillograph complete, used 30 minutes. No longer need it. Price \$75.00.

Two RCA 800s, pair Nat. type neut. conds., price for the lot, \$12.00. B. Molinari, 2190 22nd Ave., San Francisco, Calif.

TRANSFORMERS: Power and audio built to order. Guaranteed. No mass production. Right prices. California Radio Laboratories, 2523 South Hill Street, Los Angeles, California. W6CYQ.

HEAVY DUTY 866's, \$1.39, guaranteed. Howard Radio, 5648 Race Ave., Chicago.

Any factory made transmitter duplicated. Save 35%. W9UW, Chicago.

The Gamma Punch cuts socket holes easily and quickly in metal chassis. Eliminates the hardest part of set building. Two sizes—1 1/8-in. and 1 3/8-in. diameter. \$1.50 net postpaid. Gamma Mfg. Co., 907 Guaranty Bldg., Detroit, Michigan.



**Professional
Headphones
For DX
Operators**

HERE is NEWS! Like the now-famous Brush Crystal Microphone, the new Brush crystal headphones are writing a new chapter in radio history. Try a pair of these ultra-sensitive phones. Listen to the signals come up from no-where. Using the piezo-electric principle, these phones give more faithful reproduction than any others. Prove the statement for yourself. For audio test purposes there is nothing finer. Non-magnetic, ideal for airplane use. \$12.00, list per pair. If your dealer cannot supply you, write us direct for literature.

Ask for Data Sheet No. 10, describing these new headphones . . . will be supplied on request.

The Brush Development Co.
1888 EAST 40th ST. CLEVELAND, OHIO

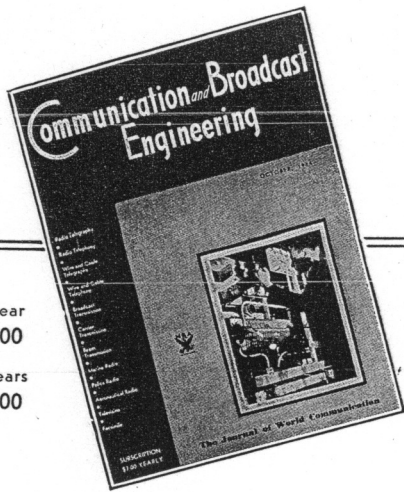

1 Year
\$3.00
2 Years
\$5.00

Communication and Broadcast Engineering

The monthly journal that thoroughly covers the fields of . . .

- Radio Telegraphy
-
- Radio Telephony
-
- Wire and Cable Telegraphy
-
- Wire and Cable Telephony
-
- Broadcast Transmission
-
- Carrier Transmission
-
- Beam Transmission
-
- Marine Radio
-
- Police Radio
-
- Aeronautical Radio
-
- Television
-
- Facsimile

BRYAN DAVIS PUBLISHING CO., Inc.
Dept. R, 19 East 47th Street, New York, N. Y.

- Enclosed find 25c to cover mailing costs of one sample copy of "Communication and Broadcast Engineering."
 Enclosed find { \$3.00 for 1 yr. { subscription.
{ \$5.00 for 2 yrs. }

Name (Please Print) _____
Address _____
Town and State _____
Name of Company _____
Title or Occupation _____

ASTATIC Crystal MICROPHONES AND PICKUPS

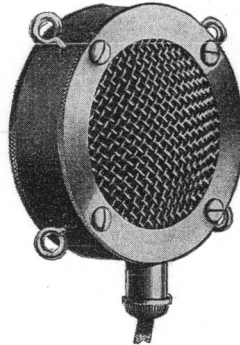

THE D-104 MICROPHONE

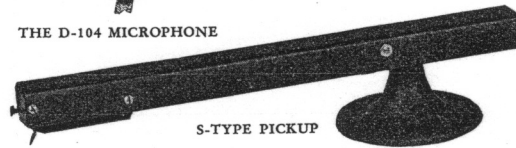

S-TYPE PICKUP

Designed for general use, Astatic quality crystal instruments have, through their continued successful application to public address, remote control, and studio broadcasting, become the choice of thousands of radio technicians throughout the world.

The Astatic line of microphones consists of the D-104 illustrated, for ring or stand mounting and two hand models. Pickups are furnished in 8" and 12" arms. See your jobber.

Licensed under Brush Development Co., patents

Astatic Microphone Laboratory, Inc., Youngstown, Ohio
"Pioneer Manufacturers of Quality Crystal Products"

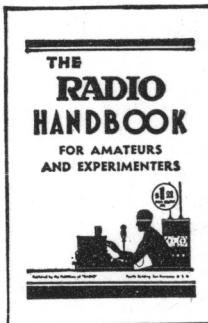

YOUR NEW AUTHORITY

The Handbook by "RADIO"
300 PAGES

Largest, Newest, Most Complete Book of Its Kind

AMATEURS everywhere are talking about the great, new Handbook by "RADIO". They are discussing it on the air, at club meetings, in radio stores. Something different . . . something NEW . . . something modern! "It's the last word," they say. The new high-power pentode transmitters are shown . . . the new theory on radio and electricity is creating wide comment . . . the complete chapters on antennas, radiotelephony, modern c.w. transmitters, ultra-high frequency equipment, etc., have brought an avalanche of commendation. Several hundred dealers have this book on sale. If your dealer cannot supply you, order direct from the publisher.

Immediate Deliveries
SEND YOUR ORDER TODAY!

\$1.00 PER COPY
POSTPAID

RADIO

Pacific Building - San Francisco, Calif.

This Handbook by "RADIO" is Your Guide to Better Radio

It begins at the beginning, tells you how to master the code by means of the SOUND system. Tells how to build any kind of an amateur or short-wave receiver, from a 1 tube to a 12 tube de luxe crystal filter superheterodyne. Tells how to build any kind of a c.w. or phone transmitter, from the beginner's one tube to the big 1 KW job. Tells how to build a dozen kinds of ultra-high frequency transmitters, receivers, transceivers. Many charts, tables, formulae. New tube characteristics. Data on metal tubes. Laboratory test equipment. 300 pages.

The "TACO" Noise-Reducing Antenna System

● The TACO noise reducing antenna systems described below are licensed by Amy, Aceves & King, Inc., and are fully covered and protected by their patents. These patents cover noise-reducing antenna systems where long and short waves can be received simultaneously on the same antenna without the slightest cross-talk, or interaction.

● Briefly the principles of the TACO noise reducing all-wave antenna system consists in placing the aerial at a point free from disturbances, and the lead-in in such a way that the signals picked up by the flat top aerial are brought down to the radio receiver without serious losses, while the transmission line is immune from pickup of electrical disturbances usually surrounding it, and by designing the couplers so that they will separate the disturbances from the signal induced voltage, and prevent the disturbances from reaching the input circuit of the radio receiver.

The Short Wave System

At high frequencies the aerial acting as a dipole will induce currents traveling at opposite directions in the transmission line by virtue of difference in phase of wave front at the ends of the doublet. This condition is shown in Fig. 1. Any interference currents induced in the transmission line will travel in the same direction (indicated by dotted arrows) and due to the construction of the lower coupler these currents will pass through the center-tap of the primary of the set coupler to ground. If transformers of suitable ratio and construction are incorporated in the upper and lower end of the transmission line, the same action will take place, and in addition the transfer of signal energy will be improved. In this construction the signal induced voltage will create an EMF in the secondary of the antenna coupler which is applied across the transmission line and carried to the primary of the set coupler the secondary of which will deliver an EMF across A-G thus becoming the driving force for the radio receiver.

The Broadcast System

At broadcast frequencies the action of the currents will be as per Fig. 2. The primary currents (as indicated by dotted arrows) pass through the high inductance primary winding L5 into the center-tapped secondaries L6-L7 and through the transmission line to the set transformers L8-L9 and down to ground through the mid point. These primary currents generate no voltage in the secondary L10 by virtue of the fact that they enter in opposite sides of the windings and leave by the center-tap. The secondary currents (as indicated by solid arrows) induced in the antenna couplers L5-L6-L7 are of the same nature as those produced at high frequencies by the dipole action, as in Fig. 1, circulating up and down the transmission line. Any EMF interference induced in the transmission line is balanced out in the same manner as in the case of the high frequency transformers.

The All-Wave Couplers

To make an automatic all-wave system out of these two sets of transformers previously described they are superimposed as shown in Fig. 3. In this combined circuit the high frequencies are blocked from the low frequency transformer by virtue of the high inductance winding L5, but transformers L-1, L2, L11, L12 will pass them into the transmission line. Condenser C1 completes the

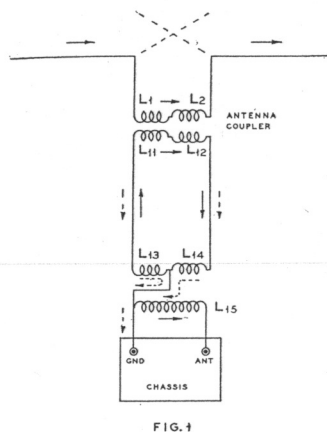

FIG. 1

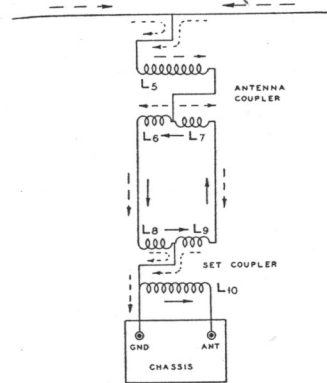

FIG. 2

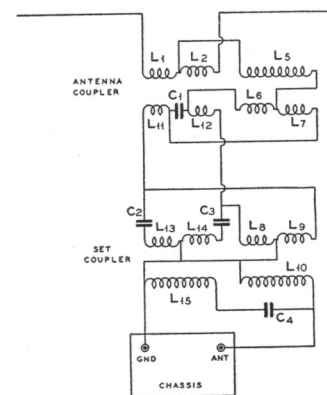

FIG. 3

circuit L11-L12 across the transmission line for H.F. but blocks the low frequencies. In the lower transformer the high frequency currents pass through C2 and C3 into the H. F. primary windings L13-L14. The passage through L8-L9 is blocked by the high inductance of these two windings. The standard broadcast signals coming down through the transmission line to the lower transformers L8-L9 are blocked from entering L13-L14 by the condensers C2-C3. The condenser C4 blocks the standard broadcast signals from passing through the low impedance secondary L15 to ground. The values of L10 and L15 are chosen to match

the input impedance of the standard all-wave receivers on the market today, having more or less high impedance input for standard broadcast band and low impedance input for the high frequency bands.

Transmission Line

The wires used in the transmission line are selected for their low loss and to obtain the best results it is preferable to leave the length of the line as supplied with the kit. If extended the same type of wire should be used. Never use ordinary fixture wire as the dielectric losses are high in that type wire. The length of the transmission line can be extended several hundred feet without materially changing the characteristics of the system.

Installation Precautions

By examination of Fig. 3 it will be noted that the signal voltages applied to the radio set are only those induced in the two secondaries of the set coupler, and that other voltages not originating from the antenna must cancel out themselves by virtue of the differential windings in the coupler. If, however, the lead connecting the mid point of these windings to ground is not very short, a drop of potential due to both signal and interference currents will be produced across it, and it will be added in series to the secondary voltages, thereby re-introducing the noise voltage into the set. Therefore, it is essential to make this lead as short as possible. Connection of the ground lead to a good ground may in some cases help in elimination of noises, depending on how "live" this ground is with electric currents flowing through it. The only way to determine this is by trial.

Audio Frequency Amplifier Measurement

(Continued from page 22)

velocity microphones tend to over emphasize the lower voice frequencies and become very "thick" or thumpy for close talking and should receive a small amount of low frequency attenuation. Class "B" output transformers frequently show a pronounced loss of low frequencies because of the core saturation resulting from high secondary currents. This loss of low frequencies can be compensated for in the amplifier either by the fortunate selection of audio transformers or by controlling the termination of the resistance coupled amplifier stages. (Transmitter measurements should always be made with a dummy antenna in order to avoid interference).

The use of the audio frequency oscillator also permits the selection of less expensive transformers to fulfil a particular requirement. Such savings have been realized in connection with output transformers for microphones, pre-amplifiers, boosters, etc. Standard P.P. 45 output transformers designed for 15 ohm voice coils can be employed as output transformers for 37 or 56 type tubes for pre-amplifiers or for receiver outputs where an inexpensive mixer system is desired.

Several output transformers can be used to bring all of the station equipment to a common control point and enable better phone relays or high frequency rebroadcasts. Frequently the savings realized in choosing the correct transformers and associated parts would more than repay the operator for his trouble or expense in providing a suitable source of audio frequencies for these tests, and permit more accurate modulation measurements.

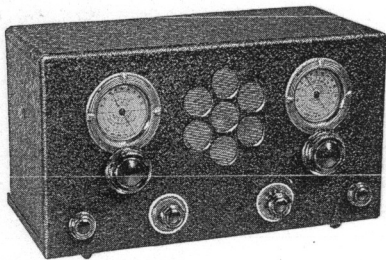

Announcing—
SARGENT MODEL 10
A Complete, Self-Contained
COMMUNICATION TYPE
All-Wave Receiver

Look at These Features—

- Covers Broadcast Band
- Illuminated Airplane Dials
- Tuning Dial Calibrated in M. C.
- Adjustable, Calibrated Band Spreader
- Built-in 5-inch Jensen Speaker
- Coil Switch for Wave Changing—No Plug-in Coils
- Choice of Three Tuning Ranges
- Built-in Hum-free Power Supply
- Large Tuning Knobs
- Headphone Jack
- Attractive All-Metal Cabinet
- Doublet or Regular Antenna
- An A-1 Amateur Receiver
- Ideal for Shipboard Installations
- Write for D.C. and Battery Prices

AMATEUR NET PRICES

Standard Model, 15-550 Meters, complete\$34.50
Marine Model, 15-1500 Meters complete\$39.50

IMMEDIATE DELIVERY

E. M. SARGENT CO.

212 Ninth St., Dept. R Oakland, Calif.

NEW 1936 MODELS

TROY ALL WAVE RADIOS

POWERFUL - EXTRA VALUE - NEW DESIGN

AC, AC-DC, DC, 32 Volt Battery and Auto

"A Model to Meet Every Requirement"

TROY ALL-WAVE "WORLD CLIPPER"
SUPERHETERODYNE

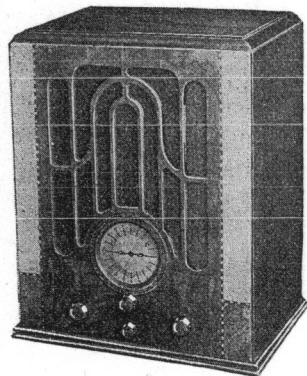

ALL WAVE
Burl walnut
inlaid
cabinet,
airplane
double ratio
vernier dial.
Distant
stations,
15-550
meters,
110 volts.
50-60 cycle.
8 tubes,
super-
heterodyne
circuit.
RF stage,
powerful,
8-inch
electro-
dynamic
speaker,
bass compen-
sation
volume
control,
—Phono
Jack.

MODEL 84U—ALL WAVE

Licensed by Radio Corporation of America
Underwriters Approved.

36 MODELS TO CHOOSE FROM—
NEW TROY FRANCHISE READY

Write us for new plan and circular on complete line
and territory

TROY RADIO MFG. CO.

1815 VENICE BLVD. LOS ANGELES, CALIF.
FOREIGN DIVISION—7 FRONT ST., SAN FRANCISCO

**\$1.00 brings you the next
four issues of "RADIO"
—Subscribe NOW!**



When it's tough sailing, Skipper Serviceman,
be nonchalant . . . steer by Centralab.

For Centralab Controls are built to "take
it" in all kinds of weather . . . under all sorts
of adverse conditions. It's smooth sailing under
sunny skies if you stock up with CENTRALAB
Radiohms for each and every replacement job,
which invariably work "better than ever be-
fore." Smooth, silent,
safe, sure and certain
. . . no wonder they are
the choice of servicemen
who "are in the know."

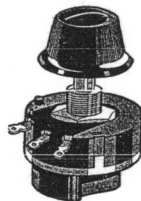

Write or see your jobber
for the new, revised,
accurate CENTRALAB VOL-
UME CONTROL GUIDE.

Every Radio Service Man
should be a member of the
Institute of Radio Service Men

Centralab

RADIOHM

Division of Globe Union Mfg. Co.
MILWAUKEE, WIS.

Sumner B. Young

(Continued from page 9)

West Coast took the position that Schnell's statement should stand as authoritative until the contrary was shown.

Maxim was in favor of this, and it eventually was done. Preliminary checks made at H.Q. had led Maxim to think that more than half of the "hams" in the United States belonged to the League, but I questioned this; and in February, 1935, I publicly predicted that the count would run about one-third in the League and two-thirds out. (See April, 1935, "R/9", recording my speech in Minneapolis on February 16, 1935, on the occasion of Warner's visit here).

Later I heard from Louis Huber, of Des Moines, that when he was at H.Q., a running count was kept of votes cast by members, although ballots were not supposed to be opened as they came in. This didn't look so good. Boyd Phelps, of Minneapolis, also told me that he had visited H.Q. one time after his resignation, and that Hebert had called him over and had told him "that their (H.Q.'s) man in the Hudson Division was then leading in the directors' race." This was the first definite basis I had ever heard for any claim that there had been voting irregularities at West Hartford, although I had heard plenty of loose talk about this before. I have never raised this question myself, but it is coming to the fore in several quarters now.

Warner's visit out here in the Twin Cities in February, 1935, only strengthened my conviction that he should go. I suggest that you read my 1935 Des Moines speech, which was published in the May, 1935, "RADIO", for reasons and details.

I think Warner fails to measure up to requirements in the legislative field, due to defects in training for this kind of contact which his experience, so far, has not overcome. I believe his policies are timid and unsuccessful, and that his personality is a handicap to his success and ours.

As an editor, I believe self-interest has prompted him to suppress any idea or fact which tends to criticize him or his policies, and that he has made it almost impossible for one "ham" to talk to another through the pages of "QST". I also believe his idea of having editors write the magazine is all wrong. (He's modified it somewhat, lately).

As to his contacts with the ARRL members, I don't believe he has ever done a proper job. He has buried himself in West Hartford for the most part, and I don't believe he ever will be a mixer. This cuts him off from the men he should know best.

In any event, his presence at the helm antagonizes many people. Even if he were very well fitted for the job (which I deny), it is rather obvious that he has outlived his usefulness, and that a new leader would be preferable, to solidify the League.

It is only a fiction that the League is run by the Board, although they possess the legal power to do so. Also, Maxim has not paid due attention to League affairs for several years, and a stronger hand is needed there, as well.

I'm for strengthening the League by an immediate membership campaign with the help of the affiliated clubs, the selection of the legal protection of our existence as the main objective of the League, and the abolition of timid methods of dealing with legislative problems. I also want to see the directors begin to direct, and to meet more than once a year.

Warner is already spreading uneasiness among the directors as to the wisdom of showing any fight at Cairo. (See his letter quoted by me in my 1935 Des Moines speech). The lack of "guts" should be stamped out. I doubt if we will ever get anywhere until we

(Continued on page 33)

Sumner B. Young

(Continued from page 32)

stiffen our backbones a good deal more, and work on the Canadian Parliament and the U. S. Congress, for a change.

Warner can be replaced, and should be. Schnell, Kruse, Dr. Jolliffe (former expert for Federal Radio Commission), and others, could do a better job. The job can pay enough to attract a damned good man.

At Sioux City, Iowa, Rex Munger, of St. Paul, asked Warner (from the floor) if "ham" radio wouldn't go on just the same as ever, if Warner should suddenly die. Warner said that "he thought it would." Rex asked him if he didn't KNOW that it would. Warner then said "he knew it would."

Warner also admitted, at Sioux City, that the agitation up here this last year and a half had made him work harder than he ever had before.

As I wrote Mr. Maxim a while ago, this "unrest" has had unpleasant features; but I feel sure that the net result, so far has been to bring about important changes for the better in "QST", more sense of obligation on the part of Board members, and, most important of all, a quickening of interest among members at large in the affairs of the League.

People who demand a lot of detailed facts from critics of League policies, may not understand how hard it is to get even the more simple bits of data, by mail or otherwise, from West Hartford, out of people who know that what they say or disclose, may be used against them. They forget that H.Q. has had absolute control of the League's mouthpiece, "QST", for years, and is firmly entrenched in lucrative jobs, well worth saving. One can only "paint with a large brush" under such circumstances; and individual items which you can turn up may not seem so terribly shocking. It's when you fit them together that the impression becomes bad.

When I was a student in Harvard Law School, I heard Professor MacLaughlin tell the class a story which has stuck with me a long time:

"A man whistling like a bird, isn't so unusual", he said. "And a thistle isn't so very remarkable when you see it; and even a man with his pants off isn't startling; but when you see a man with his pants off, sitting on a thistle and singing like a bird, you'd better investigate."

I feel, however, that although details are hard to come by, the results have been bad, and speak for themselves.

While it never can be proved that somebody else would have done better, I believe Warner's handling of legislative matters (Treaties, principally) has been bad, although "paper victories" have been built out of these failures. Our membership hasn't kept pace with the growth of "ham" radio. The morale of our members is bad. Our first purpose—to organize transmitting amateurs into reliable relay chains, has failed. Nothing has been fixed on, as yet, to serve as a primary purpose of the League, to take its place. There is no very concrete idea yet advanced, as to how we are to pay for our place in the air in between wars and public emergencies.

Warner has been extremely well paid for whatever he has done for advancing amateur radio. Whatever his services have been (and in my opinion, he hasn't done much), there is no debt outstanding between Warner and the League.

I hope I haven't burdened you too much by this lengthy letter. I suppose these thoughts have been pressing for expression, and your evident interest and fairness of mind prompted me to put them on paper.

Very truly yours,

Signed SUMNER B. YOUNG

McMurdo Silver Announces

THE FINEST PROFESSIONAL RECEIVER OF ALL TIME . . .

SILVER MASTERPIECE IV_a

The Super-fine Phone Receiver!

- No Inherent Circuit Noise
- Controllable Selectivity
- Plenty of Band Spread
- One Half Microvolt Sensitivity
- Complete Flexibility

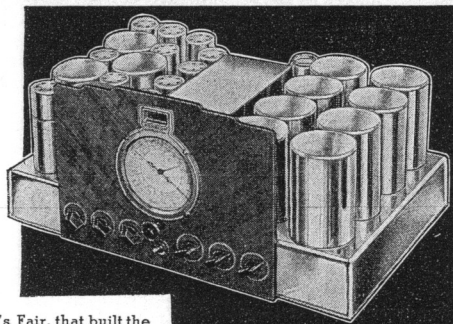

Out of the experience of over twenty-three years . . . that built all the receivers for W9USA at the World's Fair, that built the all wave receivers for Admiral Byrd, that has produced the famous 5B and 5C now doing their stuff in thousands of ham shacks, in government service, at engineering universities the world over . . . now comes the MASTERPIECE IV_a, the superlatively flexible professional receiver. It has so many totally new and unduplicated features that it takes the 32-page Blue Book to explain them all, but here are a few:

No Inherent Noise. Not over 20 milliwatts inherent receiver noise when "wide open" at 1/2 microvolt absolute sensitivity on all bands, means good readable signals where they are now lost in set noise or not even heard.

Controllable Selectivity. From sharp enough to give single signal C.W. to amply sharp to cut through crowded phone bands, to broad enough for standby, all controlled by the fidelity and two tone knobs.

Band Spread. One large 4" accurately calibrated airplane dial, with accurately re-logging geared band spread pointer on inside 0-200 division, 360 degree, scale. Spread on 160 meter amateur band 540 degrees, 80 meter, 280 degrees, 40 meter 130 degrees, 20 meter 80 degrees, and ten meter 180 degrees.

Range. 140 to 410 kc. (2150 to 732 meters) and 530 to 32,000 kc. (568 to 9.4 meters) covers all five amateur bands, short wave and regular

broadcast and long wave commercial, all at maximum sensitivity and selectivity.

Two Tuned R.F. Stages On All Bands. Perfect image selectivity even at 20 meters and inherent noise so low you'll think the set is dead until Aussies and Zedders roar in R9. All r.f. oscillator and i.f. circuits use permanent air condensers—only one compression trimmer in 33!

High Fidelity. It's there—30 to 9000 cycles and 15 watts undistorted output thru matched Jensen speaker. Not only is it the perfect amateur receiver, but a wow of a high-fidelity all wave broadcast receiver as well.

Control Flexibility. All controls are calibrated so you know exactly what you're doing, and can duplicate adjustments from day to day. Tuning meter with calibrated sensitivity control is perfect R-meter, allowing exact measurement of received signal strength.

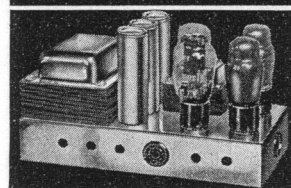

10 DAY FREE TRIAL. The Silver MASTERPIECE IV_a, like the 5C, is just so good that it's the only amateur receiver offered to you on a 10 day free trial basis. You can test it, make it do its tricks, and if you don't like it 100%, you can return it undamaged and get your money back instantly. With this wide-open guarantee, we get less than one-half of one percent back—so they must be good.

When you install a Silver MASTERPIECE IV_a on your operating desk, your receiver worries are over for years to come, for it's so far ahead of contemporary design that once you operate it, you'll only be able to say "man, what a receiver!"

These champion of champion receivers are being delivered right now—you can get one at once, without waiting until next year, and the price complete with 15 watt power amplifier and matched high fidelity speaker, is less than you could buy the parts for.

LAST MINUTE SCOOP!

Next month comes the new 5D—designed by "RADIO'S" Technical staff, McMurdo Silver and eleven other makers. It's the berries for c.w.—and phone, too. You can buy it or build this professional communication receiver and save money. Write for details.

McMURDO SILVER CORPORATION Division of G.P.H. Inc.
3362 N. Paulina St., Chicago, U. S. A.

McMURDO SILVER CORPORATION
3362 N. Paulina St., Chicago, U.S.A.

Send complete specifications of Silver MASTERPIECE IV_a, and details of FREE TRIAL OFFER.

Send complete story on the 5D Silver "Radio" xtal super-het.

Name

Address

City

State

8RM

JACK BRADLEY

Has Moved to New, Larger Quarters

Manufacturer of Radio Parts for the Amateur and for the Trade

Bakelite Engraving Panels, Etc.
Radio Construction and Repair
MYCALEX SHEET AND RODS

BRADLEY MFG. CO.

32 LASKIE STREET, SAN FRANCISCO
Off Mission, Bet. 8th & 9th. Phone UNDERhill 3887

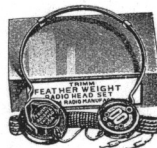

TRIMM

FEATHERWEIGHT HEADSETS

BUILT FOR EXPERTS BY EXPERTS
A Type for Every Need

NOW—

A REAL SPONGE-RUBBER EAR CUSHION
A TYPE TO FIT ALL
Lightweight - Standard Phones

TRIMM
RADIO MFG. CO.
1528 Armitage Ave., Chicago, Ill.



\$1 brings you the next four issues of "RADIO"—Subscribe NOW.

CROWE
RADIO COMPONENTS

DIALS, KNOBS and SWITCH PLATES for TRANSMITTERS,
SOUND EQUIPMENT, OSCILLATORS, Etc.

CARRIED IN STOCK BY LEADING JOBBERS AND DEALERS.



Chrome and black Gain plates in several styles and readings.

Die-cut instrument dials. Professional appearance and extreme accuracy.

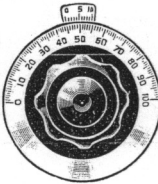

Black Bakelite knobs in matching sets.
Bar Knobs - Switch Knobs - Skirt Knobs



Aluminum and black Switch Plates, Gain Plates, Volume and Selector Plates.

Write for Bulletin No. 70 for complete details.

Established 1899

CROWE NAME PLATE AND MANUFACTURING CO.

1755 GRACE STREET

Cable Address: Crowname, Chicago

CHICAGO, ILLINOIS

WE KNEW YOU'D BE SKEPTICAL!

We knew that a price of only \$4.90 for brand new, standard, genuine guaranteed Western Electric fifty watters would make you think, "TOO GOOD TO BE TRUE!" And to question, "What's the catch?" We expected the orders to be worded like a seagoing lawyer's brief. And they were!

BUT, HERE'S THE LAUGH!!

After getting their tubes and giving them a stiff test, almost all of the boys rushed back repeat orders for one, two, and even three more tubes! "They surely are FBI!" was the consensus of opinion.

MORAL:

When Harrison offers a value it's not too good to be true, but it is too good to last long! So get yours now at the low price!

Western Electric 211-D FIFTY WATTERS

GENUINE - BRAND NEW - FULLY GUARANTEED

Standard Fifty Watter base. Standard characteristics (Interchangeable with type 211 and 211-A). Has new long life filament! Rated RF output as an amplifier—100 WATTS!

Every tube is in its original Western Electric carton! The WESTERN ELECTRIC name is your guarantee of highest quality! We guarantee REAL VALUE and COMPLETE SATISFACTION!

Regular selling price—\$17.50. Harrison's SPECIAL PRICE—only \$4.90! Your money cheerfully refunded if you do not agree with us that this is the GREATEST VALUE ever offered to the Amateur! Every tube is UNCONDITIONALLY GUARANTEED FOR THIRTY DAYS! (Broken glass or burnt-out filament the ONLY exception!)

ALL
STANDARD
LINES AT
LOWEST
PRICES
ORU?

HARRISON RADIO COMPANY
142 LIBERTY ST., Dept. P7 NEW YORK CITY

Mail Orders Filled Promptly. Deposit Required.

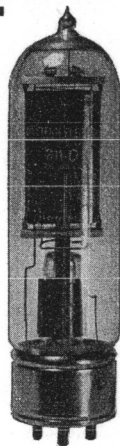

\$4.90

These are not 211-E! No RF Chokes in the base!! FB for RF!!



Osockme, Japan.
June 23, 1935.

Kind Sir:
Editor of "RADIO",
Dear Ed.:

Banzai! Scratchi have invented genuine new revolutionizingly extraordinary single signal receiver, which ARE a receiver and how, Hon. Ed. It are a truly true single signal receiver. It receive only one signal, the loudest signal in the band. High-frequency coils are wound on cellulose forms and there are a small phonograph installed in same receiver cabinet for make music when no amateur signals are heard on the bands. Scratchi's new receiver have controlled carrier reception and automatic push-pull slide in drawer for holding log books and paper books. High voltage divider resistor are installed inside of tuning dial so that Scratchi can keep hands warm while tuning over dial in vain hunt for another station. On second thought, after writing you this letter, Hon. Editor, Scratchi are of opinion that mayhap I have forgot to fasten tuning dial to condenser shaft which are sometimes cause for receiving only one station on entire dial range. Would you advice me to make look inside of receiver box to see if dial are fastened to condenser shaft, or would you rather make suggest that I send receiver to Bureau of Standards to become calibrated? If so, what are charge for either or both operations, and can usual ham discounts of 99% and 1% be secured through your kind offices, Hon. Ed? Or not?

It are becoming quite cold this month here in Japan, Hon. Ed., so Scratchi believe it are good plan to bring in the brass monkeys. Methink it will also become wise to take down antenna wire and clean the rust off of it because I are told by brother amateurs that my signal sound fuzzy.

I are laboring under false illusion that I are soon to find information in your valued pages which will be cause of enlightenment to Scratchi for knowledge of operations of Wheatstone Bridges. I are told by amateur here that such are musical instrument and when I ask another amateur if such are true he snap back with positive answer and say he are sure that Wheatstone Bridges play musical tunes, because he know of one tune which it play, and such are called Ohm, Sweet Ohm. Latter amateur who give me former information ask me to regard such as confidentials. He also pass advices along to me that it are never wise to pay cash for a storage battery, but it are always better to charge it instead. Such bum jokes make Scratchi form opinions that brother ham are dumb cluck. He are the kind of amateur who really believe, in his hearts, that a Hertz antenna are not painful at all.

It are now time for Scratchi to sign off and make weekly trip to local insane asylum to make converse with several hundred self-excited oscillators who are confined to such institution until new frequency bands far above the Heaviseide Layer spektrum can be found for them to operate in. PS. Hon. Ed. before closing remarks I wish make request of you from local ham club who ask for me to secure information on how our radio club can continue to function if no dues are paid by members. If you will make publish technical engineering formula in next issue you will receive 25c commission on each membership. With kindest seventy and three more, I make close with apologies and usual request for more elastic bands to operate in and out of, and further hope that Commercial Delegates to Cairo Convention make mistake by boarding wrong ship when they leave for Egypt.

Your other loyal supporter,
Hashafisti Scratchi.

LITTELFUSES

Write For FREE CATALOG

Tells about Littelfuses for instruments, meters—high voltage fuses for transformers and other Littelfuse Products. Write today!

LITTELFUSE LABS.
4503 Ravenswood Chicago



CHICAGO MORRISON HOTEL
 In the Heart of the Loop
 SINGLE ROOM **\$2.50** UP
 \$4.00 Double
 Each, with Bath, Servidor
 and Circulating Ice-Water
LEONARD HICKS
 Managing Director

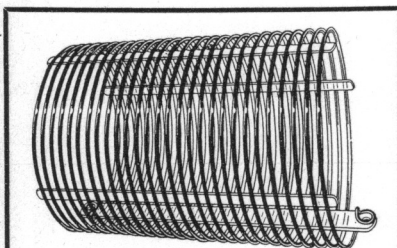

Here Is the Most Efficient Tank Coil For Your Transmitter

Recent Tests by Amateurs, Technical Editors and others have disclosed the fact that . . .

a wire-wound tank coil is infinitely more efficient than the older forms of copper-tubing tank coils. The new MERRILL tank coil has been designed for optimum efficiency. It is rigid, has very low dielectric losses, is easily mounted and is beautiful in appearance. Inductors for average transmitters cost less than \$1.00 net. The winding is supported on four high-grade insulating strips.

The inductance of the standard type of coil is such that it can be tuned with a 35mmf. condenser. However, other types of coils are available for use with any other size tuning condenser. The MERRILL line of inductors is complete. There is a size for every purpose. Heavy-duty coils for high-power final amplifiers can be supplied on order. Or we will build coils to any specifications. The beginners' transmitter described in this issue of "RADIO", and the high-power controlled carrier phone of W6HYB, also described in this issue of "RADIO", use the new MERRILL inductors. Many dealers carry a large assortment of these inductors in stock. If your dealer cannot supply you, write us for the name of the dealer nearest you.

Additional jobbers and dealers are wanted. Kindly write for complete information.

Merrill Manufacturing Co.
 4835 Edison Street, Los Angeles, California

When writing to Advertisers, kindly tell them you saw their announcement in "RADIO".

Colonel Foster's Comment

(Continued from page 4)

North America. He OCCUPIED it—just as the amateurs could have used the whole of the short-wave spectrum, thus establishing the "occupancy" that scores so heavily in commercial radio. The Indian had laws that prescribed and governed his occupancy but finally along came the white man and imposed his own. But the Indians didn't calmly relinquish most of their territory for commercial development. They fought like hell for several hundreds of years to retain what they held. Their authorized representatives did not give it away and then write follow-up articles to the tribes telling them, "Look what we got for you! Some substantial assignments of territory in the form of Indian reservations where you may crowd yourselves together and live the life of Reilly—if you succeed in living at all. Today in these substantial assignments", (See the conclusion of Warner's June editorial), "we can hold more pow-wows in an evening, or hold one pow-wow a longer period of time, or raise more hell—do more desired things rather than random things—than ever before in the history of the American Indian". If the Indians had had any such authorized representatives just what would have happened to them if they had printed that stuff on their official buffalo hide and circulated it among both Indians and white men! I'd hate to tell you. Well, if you can wade through the conglomerate nonsense of these three follow-up articles you can spot instance after instance of false assumption, or ambiguity, or equivocation, or circumlocution, or half-truths—all designed to convey to the reader that the authorized representatives could not have given anything away because the amateurs NEVER HAD anything to give away.

It is not of record that the authorized representatives ever consulted counsel regarding the rights of amateurs under the law of 1912, but, besides the Federal Radio Commission, the best legal men have said the amateurs had the right to operate anywhere from 200 meters downwards. And if any amateur had demanded to be licensed on any particular frequency in that area the Secretary of Commerce could not have denied him a license to use that frequency. The law was clearly stated and was mandatory. The Secretary of Commerce was named to administer it but it had conferred on the Secretary no discretionary powers in the line of wavelength assignments. Warner talks of "interpretations of the law of 1912". There weren't any. That was the trouble the commercials ran into; the law itself was so clear there was small opportunity for the Secretary of Commerce, or the secretary of the ARRL or anybody else to do any "interpreting". So what happened was that after broadcasting came, and after the amateurs had demonstrated the value of the territory from 200 meters downwards, the law was simply violated without scruple. Then it was every man for himself and the devil take the hindmost. The authorized representatives of the amateurs, being very much to the hindmost, "relinquished most of their territory for commercial development."

There was, of course, no especial place under the law for broadcast stations. They chose such spots as they saw fit, having only to keep clear of prescribed commercial services and the government stations. The Secretary of Commerce was obliged by the law to license them; and he was obliged by the law NOT to license them or any other commercial stations in the area below 200 meters. The law had never been passed upon by the Supreme Court but the Attorney Gen-

(Continued on page 36)

Lafayette "PRO 9" AMATEUR RECEIVER



BUILD IT AND ENJOY REAL RESULTS ON ALL HAM BANDS

Here is the last word in modern amateur all-wave receiver Kits! It incorporates a factory assembled coil-switching unit so that only a few simple connections are needed to wire this unit into the completed receiver. Features 1 R.F. stage on all bands; Beat Frequency OSCILLATOR for C.W.; AVC or manual control; Demountable power speaker unit, etc. No. PXY-22069—complete kit of parts including speaker and panel, complete instruction booklet, but less

tubes and cabinet. **\$36.75**
 If wanted completely wired.....\$7.50 extra
 Cabinet.....\$7.50 extra

5 METER Super Het

Here is a Super-het for 5 M. reception that is almost as simple as a straight super-regenerative receiver, but it will prove far superior as regards sensitivity, selectivity and noise level.

The absence of super-regenerative "Rush" is an outstanding characteristic. Any Ham can build it. No. PXR-22098—complete kit of parts including cabinet, panel and special copper plated chassis, complete instruction booklet, but less power supply, tubes and speaker **\$16.75**

If wanted wired.....\$3.25 extra

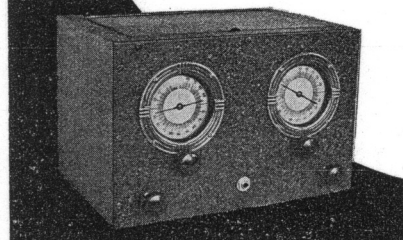

WHOLESALE RADIO SERVICE CO.
 Main Office and Warehouse
 100 SIXTH AVENUE - NEW YORK, N.Y.
 BRONX, N.Y. ATLANTA, GA. NEWARK, N.J.
 542 E. Fordham Rd. 430 W. Peachtree St. N.W. 219 Central Ave.

WHOLESALE RADIO SERVICE CO.
 100 Sixth Ave., Dept. P-85, New York, New York
 Send me more data on the "PRO-9"
 Send me more data on the "5 M. Super-het"
 Send me FREE Ham Catalog #58-A

Name.....
 Address.....
 City..... State.....

NOTICE

TO RADIO TECHNICIANS

Are you interested in the improvement of your ECONOMIC, SOCIAL, and TECHNICAL status in the radio operating profession?

The American Radio Telegraphists Association, Inc., is an organization OF, FOR and BY Airways, Broadcast, Marine, Point-to-Point, and Police radio operators who are striving to accomplish improvements along these lines. To date much has been accomplished, and more will be accomplished in the future. Join hands with your brothers in this big move for a better profession.

Information will be furnished on application to the American Radio Telegraphists Association, Inc., 10 Bridge Street, New York, N. Y.

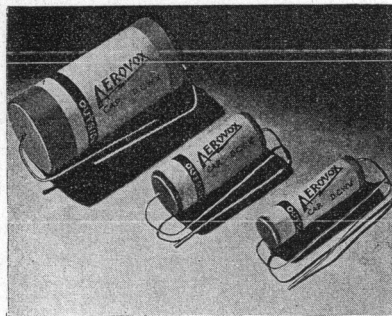

CARTRIDGE CONDENSERS

... Triple-Sealed!

With the return of the radio industry to full-sized sets, superior performance, lasting satisfaction, AEROVOX re-introduces the triple-sealed cartridge condenser. Here is genuine quality at new low prices . . . skilled engineering for an economical result . . . featuring:

- 1 Non-inductively wound section of selected paper and foil, wax-coated.
- 2 Sturdy wax-impregnated tubing with imbedded aluminum foil.
- 3 Liberal wax-sealed ends in place of usual unsealed spun-over ends.

Result: Far greater freedom from humidity . . . 4 1/2 times longer life than conventional unsealed tubulars. In single and dual sections . . . wide range of capacities . . . 200, 400, 600, 1000 volt ratings. And they cost no more!

DATA New 1935 catalog is yours for the asking. Also sample copy of monthly Research Worker. Meanwhile, see your local supply house about the AEROVOX line of condensers and resistors.



CORPORATION

84 Washington St. Brooklyn, N. Y.

RADIO CLUBS!

Write for Special Group Subscription Rates for "RADIO"

CANNON-BALL HEADSETS

Made by America's oldest manufacturer of headsets

Heavy bar magnets, double pole, aluminum cases, D. C. resistances of 2000, 3000 and 5000 ohms. Sturdy construction, sensitive and faithful in reproduction.

Sold everywhere in America

C. F. CANNON CO.
SPRINGWATER, N. Y.

Colonel Foster's Comment

(Continued from page 35)

eral in an opinion rendered on November 2, 1912, had advised the Secretary of Commerce that the issuance of a license to an applicant was mandatory if the applicant was a citizen of the United States.

When the commercials had become convinced of the value of the short waves there was a grand scramble for licenses to use them. Here was a real snag for the commercials. The law specifically forbade the licensing of any stations below 200 meters except private, (amateur), and experimental stations; and the law compelled the Secretary of Commerce to issue to any private station owned by a citizen of the United States a license for operation on the wave such a citizen might choose "not above 200 meters". The amateurs and experimenters were the ONLY users of the air who were sitting pretty under the law; the commercials could not be licensed below 200 meters without BREAKING the law. So the big commercial interests and their adherents got together and made a "gentlemen's agreement" to BREAK the law. And they made other "gentlemen's agreements" when they ran up against other features of the law that needed breaking. The authorized representatives of the amateurs became party to them. They have told us with the cheery nonchalance contrived by weaklings when they wish to convey the impression that they are the close associates of big shots. Just here this must be recalled as a significant circumstance: The authorized representatives were in the employ of an organization that they themselves had previously caused to be loaded up with commercial members. In old issues of QST are found many prideful references to the inclusion of the amateurs in this "gentlemen's agreement". This is THE outstanding instance of radio men making agreements deliberately to break laws enacted by the Congress of the United States. A gang may get together and make an agreement to rob a national bank but I doubt if it would be called a "gentlemen's agreement." Certainly it would not be referred to with an air of sanctifying it.

This gentlemen's agreement provided for partitioning the short-wave area of the amateurs among the commercials and the government services. The amateurs, of course, had to be left a little of their territory, for it was known that any ONE amateur who had the courage to go into court and demand his rights under the law could have upset the whole scheme. But the amateurs had trustfully left their interests in the keeping of their authorized representatives, so they got just what every weak member of a gang gets—bumped off by other members who are quicker at using their hardware.

The authorized representatives excused their support of the gentlemen's agreement by telling the amateurs, "the law had broken down and something had to be done about it." The law did NOT break down; it was simply that the commercials coveted territory that the law had withheld from them and they decided to BREAK it down. And the authorized representatives who are now printing follow-up articles in QST did their full part in breaking it down by "relinquishing most of their territory for commercial development."

The whole situation was thoroughly comprehended by all radio people, including the authorized representatives of the amateurs. Read this in Warner's editorial in QST of June, 1926, after the court had decided the Zenith case:

"It is also made clear that the Department of Commerce has no legal right to impose on

(Continued on page 37)



1935 SPRING & SUMMER ALLIED CATALOG

You will find complete answers to all of your Short Wave Transmitting and Receiving needs in this new Catalog, devoted 100% to Radio. Prices are LOWER than ever before—it will pay you to consult this book before you do your radio buying. Every leading standard Short Wave line is listed—outstanding new gear is fully described. Use the ALLIED Catalog and take advantage of our personal service. Let us help you with quotations for building any type of circuit—let our competent engineers and Amateurs in on your problems. We can always serve you better at ALLIED.



ALLIED RADIO

ALLIED RADIO CORP.
833 W. Jackson Blvd.,
Chicago, Dept. J.
Send me your FREE 1935 Spring and Summer Catalog.

Name _____
Address _____

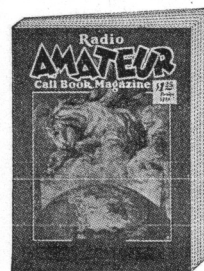

Radio Amateur Call Book

The only radio callbook published that lists all radio amateur stations throughout the entire World.

Also a complete list of high frequency commercial stations, International abbreviations and amateur prefixes, "Q, R, & T," systems for reporting signals, new US inspection districts and high frequency time, press and weather schedules.

Each copy contains a double post card addressed to the CALLBOOK for use in reporting your new QRA. We are extremely anxious to publish a callbook that will be 100% correct and want you to help us by checking your QRA at once in the latest edition and advise us of any errors.

PUBLISHED QUARTERLY MARCH, JUNE, SEPTEMBER AND DECEMBER

Single Copies \$1.25
Annual Subscription USA, \$4.00

Order your copy today from your local radio jobber or direct from:

Radio Amateur Call Book, Inc.
600 South Dearborn St. Chicago, Ill.

INCA Transformers



FOR the Ham who wants a really husky power supply INCA power transformers and chokes really fill the bill. Good examples are the new INCA B-24 and B-26. These transformers are designed for use with tubes in the 50 or 100 watt dissipation group and either of them will supply power for a transmitter using two 203 A's Class B modulated by 838's or for any similar combination. These transformers are liberally designed with plenty of iron and copper, are vacuum varnish impregnated, and are rigidly supported by heavy iron castings. Electrical specifications:

B-24—Pri. 115—50-60 Cycles

Sec. 2360-2940 Volts C.T. (A.C.)
Sec. D.C. output 1000 or 1250 Volts @ 350 M.A. (Choke Input) List Price \$21.

B-26—Pri. 115 Volts

Sec. 2360-2940 Volts C.T. (A.C.)
Sec. D.C. output 1000 or 1250 Volts @ 500 M.A. (Choke Input)
List Price—\$27.50



INCA

Obtain from your jobber or write to:

Phelps Dodge Copper Products Corporation
INCA MANUFACTURING DIV.
2375 E. 27th St., Los Angeles, Calif.

HI-POWER for SOUND EQUIPMENT

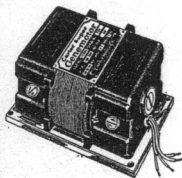

The Carter Genemotor supplies the most Reliable and Economical "B" power for Class A or B Amplifiers from a 6 or 12 volt battery. Output up to 500 volts. Sturdy — Compact — Quiet in operation — Requires no oiling — Guaranteed. Write for Bulletin showing complete line of Genemotors for every purpose or specify your requirements.

CARTER MOTOR CO.
365 W. Superior St. Chicago

\$1 brings you the next four issues of "RADIO"—Subscribe NOW.

Colonel Foster's Comment

(Continued from page 36)

the stations eligible to operate below 200 meters any additional regulations not expressly written into Section 4 of the 1912 law or provided for therein. Thus wave-length assignments in narrow bands, quiet hours, limitations on types of apparatus—all may be held to be without legal standing. This applies not only to us amateurs but to every other class of station found entitled to operate on waves below 200 meters.

"This situation has been no secret to the officers and the Legislative Committee of the ARRL. They have known it for years. In common with other radio interests, however, they have realized that the art has far outstripped the 1912 law, that the demand for radio channels is so pressing that no one interest has a right to more than it needs, and that as long as adequate legislation is withheld by the procrastination of politicians it is necessary to govern the art by extra-legal agreements arrived at in a spirit of mutual consideration and good will. The national radio conferences of Secretary Hoover have provided that opportunity.

"Now that it has been thoroughly aired that the regulations applied to amateur radio are extra-legal, it seems necessary to do some very plain talking in these columns. We want to say that, law or no law, the American Radio Relay League stands four-square and solidly for the 'gentlemen's agreements' of the fourth national radio conference to which it is a party."

This should effectually dispose of the untruthful propoganda with which Warner seeks to convince the amateurs that they NEVER DID HAVE any rights below 200 meters.

Clair Foster, W6HM.

MILLIONS IN USE

- Two Year Guarantee
- Low Power Factor
- Long Life
- Self Healing
- Efficient and Compact
- Patented and Patents Pending



The superior quality and performance of millions of Duco Condensers are recognized all over the world.

NOW GUARANTEED FOR 2 YEARS

Manufactured by

DUMONT ELECTRIC COMPANY, Inc.

514 Broadway New York, N. Y.

Write for free Catalogs, Sales and Jobber Territory

Beat Frequency Audio Oscillators

20 to 12,000 Cycles
Direct Dial Calibration

THE AUDIO-TONE MODEL 12-A

\$48.00 Net, Less Tubes
\$66 Net, with A.C. power supply and output trans.
Licensed under A. T. & T. Co. Patents

THE AUDIO-TONE OSCILLATOR CO.
901 LONGBROOK AV., STRATFORD, CONN.

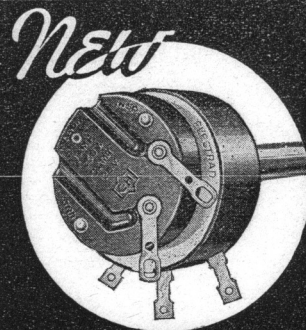

ELECTRAD VOLUME CONTROL

With New-Type CARBON RESISTANCE

NOT just another volume control—but the most advanced volume control ever offered the service man and experimenter.

It has uncanny quietness, and smoothness which improve with use.

Molded Bakelite case, when mounted, extends only 1/2 inch back-panel. New-type power switch (approved by underwriters) may be instantly attached or removed by a single screw. Long, easy-to-cut aluminum shaft. All standard and special values.



Carbon Resistance element fused to Bakelite ring.

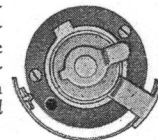

Mail Coupon for FREE Descriptive Folder, and General Catalog of Resistors for Every Purpose.

Floating contact shoe glides over carbon resistance element.

175 Varick St., New York, N.Y.
ELECTRAD

1935 CATALOG

ELECTRAD, Inc.

175 Varick St., New York, N. Y.

Please send new Resistor Catalog . . . Check here for folder on new QUIET Volume Control.

Name

Address

.....PR-8

new! KELLOGG TRANSCEIVER HANDSET

A better all-around Transceiver Handset! Highly efficient single-button Kellogg microphone, super-sensitive Kellogg receiver. Easy to hold. Fits the face. ● Microphone has greater sensitivity and "fatter" response curve than the usual "milk" of this type. Precision built, as are all Kellogg products. Gold plated diaphragm. Especially processed carbon. ● Receiver is the product of 35 years experience building telephone apparatus. Bi-polar magnet of cobalt steel. Cadmium plated diaphragm. Small, compact, easy on the ear. ● Simply and ruggedly constructed and light weight. Cast aluminum triangular handle. Baked black enamel finish. Has 6-foot, 4-conductor, 18-strand tinsel cord of telephone quality. ● You will be proud to own this unit. Better yet, it's not expensive. Code No. 38-A, 70 ohm receiver, list price \$10.00. Code No. 38-B, 2000 ohm receiver, list price \$11.

KELLOGG SWITCHBOARD & SUPPLY CO.
1070 W. Adams St. CHICAGO, ILLINOIS

Radio Dealers and Jobbers who desire to advertise in these columns are invited to write for rates.

RADIO BUYERS' GUIDE

A Monthly Listing of Reliable Radio Dealers and Jobbers who solicit the patronage of our readers. Buy from your nearest Dealer or Distributor. He is dependable and reliable.

CHICAGO, ILLINOIS

Chicago Radio Apparatus Company, Inc.
415 South Dearborn Street
Harrison 2276
Dependable Radio Equipment
Established 1921
Bulletins on request.
Everything for the amateur.
Get our very low prices.

CHICAGO, ILLINOIS

MID-WEST RADIO MART
520 South State Street
CHICAGO
Write for Special Catalog—Free

SCHENECTADY, NEW YORK

ATLANTIC RADIO SUPPLY CO.
712 Broadway
Complete Equipment Stocked for
Service men—Amateurs—Experimenters
Let us quote you

OAKLAND, CALIFORNIA RADIO SUPPLY CO.

2085 BROADWAY.
Hammarlund, Yaxley, Carter, National, Johnson, IRC, Cardwell, Miller, Morrill, Flechteim, Triplett, Haigis Transceivers
W6GFY

ST. PAUL, MINNESOTA

LEW BONN COMPANY
2484 University Avenue
Rex L. Munger, W9LIP, Sales Engineer
Radio Wholesaler Complete Stock

BUFFALO, N. Y.

DYMAC RADIO
216 E. Genesee St. CL 2080
Complete Stock Amateur Parts
STANDARD DISCOUNTS
—W8AWK—

LOS ANGELES, CALIFORNIA

RADIO SUPPLY CO.
912 SO. BROADWAY
The Amateurs'
HEADQUARTERS of the WEST
All Nationally Advertised Parts for Receiving and Transmitting carried in stock at all times.
9 Licensed Amateurs on Our Staff

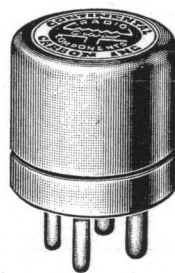
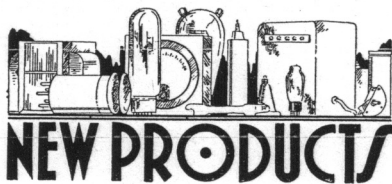

Conversion Resistor Plugs

Continental Carbon, Inc., of 13900 Lorain Ave., Cleveland, Ohio, announces production of seven special resistor plugs which may be substituted for the ballast tube in battery receivers which are converted from dry cell operation to air cell operation. The conversion resistor plugs fit the standard four-prong socket intended for the ballast tube and serve to reduce the 2.53 volt potential of the air cell to the correct operating voltage of the tubes. Conversion resistors 1, 2, and 3 are for use with certain types of Sears' battery sets having two filament circuits. The remaining resistors may be used in any circuit of the designated current drain. Plug Nos.: 1, 620 MA; 2, 300 MA; 3, 500 MA; 4, 540 MA; 5, 520 MA; 6, 620 MA; 7, 720 MA. Note: No. 7 is for use only with Air Cell SA600.

For Quieting Ford V-8 Radio Interference

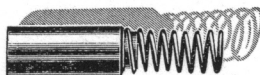

Continental Carbon, Inc., 13900 Lorain Ave., Cleveland, Ohio, has developed a special suppressor resistor for quieting the radio disturbance which originates in the distributor of Ford V-8 cars. This suppressor is made in the shape of the brush-contact in the ignition coil circuit of a Ford V-8 distributor and replaces this brush-contact. The resistance thus introduced in the ignition circuit has the effect of damping the oscillatory discharge without appreciably weakening the intensity of the spark.

A marked improvement in radio reception results from the installation of this suppressor. The suppressor contains a certain amount of graphite which gives it long wearing qualities. A spiral spring serves to maintain a constant pressure on the brush and assures good contact in the circuit. The solid molded resistance does not deteriorate with heat, humidity, or moisture. Only one suppressor of this type is required in a car in addition to the regular spark plug suppressors. Retail list price is 30c.

Probing Light

LIGHT for obscure places is the purpose of a probing light offered to the radio trade by the Thordarson Electric Manufacturing Company, 500 West Huron Street, Chicago, Illinois.

The probing light is particularly valuable for illuminating the interior of radio receiver cabinets and for use under automobile instrument panels while installing or repairing an auto radio. A pencil clip will hold the light on a cap visor or in a vest pocket, providing constant light for the user.

The probing light uses a standard radio pilot bulb in a socket mounted in one end of the 6-inch bakelite rod, 1/2 inch in diameter. A 6-foot cord carrying a series resistor similar to that which is used on AC-DC radio sets drops the standard 110 volt AC or DC supply to six volts for the pilot light. A non-breakable rubber plug fits standard fixture outlets. The retail price of the probing light is \$1.50.



110 V. A.C. - D.C.

CHICAGO, ILLINOIS

Chicago Radio Apparatus Company, Inc.
415 South Dearborn Street
Harrison 2276
Dependable Radio Equipment
Established 1921
Bulletins on request.
Everything for the amateur.
Get our very low prices.

SAN FRANCISCO, CALIFORNIA



1452 Market Street.
"The House of a Million Radio Parts"
Hammarlund and National sets and parts.
Sylvania Amateur Transmitting Tubes
Collins Transmitters.
Arcturus Receiving Tubes.
Trimm Phones, all types.
Johnson Antenna Feeders, Insulators,
Transposition Blocks.

FRESNO, CALIFORNIA

PORTS MANUFACTURING CO.

3265 E. Belmont Ave. Radio W6AVV
National FB7-SW3 and Parts; Hammarlund, Cardwell, Bliley Crystals; Johnson Insulators.
Distributors RCA-DeForest Transmitting Tubes
Established 1914 Send for Wholesale Catalog

BUTLER, MISSOURI

HENRY RADIO SHOP

Complete stock of RCA, Collins, Patterson, National, Hammarlund, Silver, RME9D, Super-Skyrider, Peake, Mac-Keys, Eimac, Taylor, Thordarson, Cornell-Dubilier, Cardwell, Dwyer, Triplett, Weston, Turner, Astatic, Trimm, Johnson, Bliley, and others at lowest wholesale prices. Your used apparatus accepted in trade, too. Write for any information.
Robt. Henry, W9ARA, Owner. 211-15 N. Main St.

OAKLAND, CALIFORNIA

ELECTRIC SUPPLY CO.

12th and Fallon Sts.—"Down by the Lake"

Our New Catalog contains valuable information for Dealers, Servicemen and Amateurs. FREE.

Amperex Transmitting and Special Purpose Tubes

Raytheon 4-Pillar Tubes Factory Sealed Cartons

DISCOUNT 40% on most all lines

W6AZG	} Located in } our store }	W6IDB
W6DTM		W6KGE

CHICAGO, ILLINOIS

Newark Electric Company

226 W. Madison St.
Chicago
All Kinds of Equipment for
Service Men - Amateurs - Experimenters
Write for free catalog

You're Bound to Win with **CROSLEY!**



Crosley speaks with a background of years in electric refrigeration . . . many more years in radio. During all these years the Crosley business philosophy has been this:

*Crosley cannot succeed without the loyal support of dealers;
Crosley cannot afford to do anything that will alienate this support;
As dealers profit, so Crosley profits.*

★ NO CUT PRICE SALES ON CROSLEY SHELVADOR MODELS

How many dealers in other lines have worked hard, spent a lot of money, time, and energy developing a profitable local market . . . only to find themselves in the position of competing with their own line in the hands of someone else who is underselling them?

Crosley dealers have never suffered this handicap because Crosley has never been compelled to dump last season's models in a desperate effort to change them into accounts receivable.

★ CROSLEY HAS NO OVERPRODUCTION! ★ CROSLEY HAS NO LAST YEAR'S MODELS!

Even if we would, we could not dump older models on the market . . . because we haven't any!

The demand for Shelvador refrigerators more than absorbs our peak production. All Crosley Shelvador models are current—sold to the trade at regular prices.

★ DEALER'S MONEY SAFE WITH CROSLEY

Dealers can confidently stock Crosley Shelvador models. They will continue to be sold only through dealers

holding the Crosley franchise—the most profitable in the field.

★ LOOK AT THE RECORD

Starting from scratch some four years ago, the Crosley electric refrigerator line has climbed in sales until now it is high among the leaders in the industry. This is due to a number of things:

- 1 Crosley has never dumped obsolete models, or any models.
 - 2 Crosley has consistently sold through established dealer channels.
 - 3 Crosley has protected the dealer franchise.
 - 4 Crosley has, of course, produced the one outstanding value in the field—the best money's worth.
 - 5 Crosley has introduced new features (such as Shelvador) that made Crosley refrigerators stand out from competition.
 - 6 Crosley has given the dealers a degree of cooperation that has helped to give them local dominance of the market.
 - 7 Crosley has made Shelvador a national household word by means of advertising.
- And these, we submit, are reasons why you cannot afford not to handle Crosley!

THE CROSLEY RADIO CORPORATION - CINCINNATI

POWEL CROSLEY, Jr., President

(Pioneer Manufacturers of Radio Receiving Sets)

Home of "the Nation's Station"—WLW—500,000 watts—most powerful in the world—70 on your dial

~~CROSLEY~~ ~~SHELVADOR~~

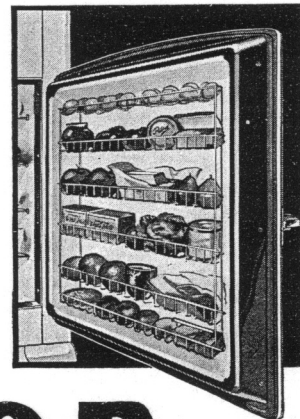



Variactor Controlled Carrier Modulation

Acclaimed the Greatest Forward Step in Radiotelephony

Phone Men who have switched over to Variactor Controlled Carrier Modulation agree it is the most economical and practical, least critical and simplest of any system of Controlled Carrier Modulation in use.

• • •

THE UTC SYSTEM OF VARIACTOR CONTROLLED CARRIER MODULATION:

- ★ Increases DX coverage many times over.
- ★ Allows power consumption savings of 50% or over.
- ★ Almost doubles Class C tube ratings and will double to quadruple Class B Linear Tube ratings.
- ★ Reduces interference between stations tremendously.
- ★ Increases tube life and power efficiency. Using the UTC Variactor CCM System the changeover from standard carrier to controlled carrier can be accomplished in less than an hour.

The Essential Variactor Unit Required for Controlled Carrier Modulation is now available in Six Types to take care of Transmitters from 25 to 800 Watts Output.

CV VARIACTORS FOR CONTROLLED CARRIER CLASS C

	List Price	Net to Hams
CV-1 25 to 50 watts maximum input controlled class C	\$ 7.50	\$ 4.50
CV-2 50 to 100 watts maximum input controlled class C	10.00	6.00
CV-3 100 to 170 watts maximum input controlled class C	15.00	9.00
CV-4 170 to 300 watts maximum input controlled class C	20.00	12.00
CV-5 300 to 500 watts maximum input controlled class C	25.00	15.00
CV-6 500 to 800 watts maximum input controlled class C	33.00	19.80

AV AUTOTRANSFORMERS FOR CV VARIACTORS 115/170 VOLTS AC

	List	Net
AV-1 for use with CV-1	\$ 5.00	\$3.00
AV-2 for use with CV-2	6.00	3.60
AV-3 for use with CV-3	7.00	4.20
AV-4 for use with CV-4	9.00	5.40
AV-5 for use with CV-5	12.00	7.20
AV-6 for use with CV-6	15.00	9.00

CV VARIACTORS are suitable for obtaining controlled carrier on any transmitter using high level plate modulation. For existing equipment the corresponding AV autotransformer must be used with the CV VARIACTOR.

A New CHROMSHIELD Transmitting Line

... outstanding in performance ... smartly professional in appearance ... popularly priced for ham pocketbooks

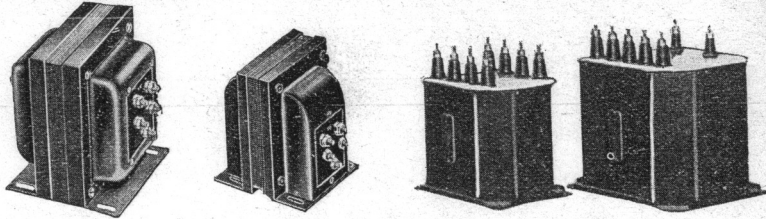

Plate transformers in full wave and bridge rectifier circuits

Type	Voltage each half secondary	Kind of rectifier circuit	2nd choke	1st choke	DC voltage	DC current	List Price	
CS200	450	Fullwave Bridge	CS301 CS 39	CS304 CS 39	350	150	\$ 6.50	
	450				715	100		
CS201	500	Fullwave Bridge	CS301 CS301	CS304 CS304	375	200	8.00	
	500				840	125		
CS202	600	Fullwave Bridge	CS301 CS301	CS304 CS304	465	200	10.00	
	600				1020	125		
CS203	800	Fullwave Bridge	CS301 CS301	CS304 CS304	660	150	7.50	
	800				1300	100		
CS204	800	Fullwave Bridge	CS302 CS301	CS305 CS304	650	250	10.00	
	800				1370	160		
CS205	750 or 900	Fullwave Bridge	CS302 CS301	CS305 CS304	590 or 725	350	17.00	
					1260 or 1530			220
					1035 or 1170			500
CS206	1250 or 1400	Fullwave Bridge	CS303 CS302	CS306 CS305	2160 or 2430	325	32.00	
					1170			500
					2160 or 2430			325

MATCHED SMOOTHING CHOKES FOR ABOVE

CS301 12 Henry, 200 MA; DC resistance 140 ohms	\$ 5.00
CS302 12 Henry, 300 MA; DC resistance 105 ohms	7.50
CS303 12 Henry, 500 MA; DC resistance 70 ohms	13.00

MATCHED INPUT SWINGING CHOKES

CS304 5/25 Henry, 200 MA; DC resistance 140 ohms	\$ 5.00
CS305 5/25 Henry, 300 MA; DC resistance 105 ohms	7.50
CS306 5/25 Henry, 500 MA; DC resistance 70 ohms	13.00

FOUR TUBE BRIDGE RECTIFIER FILAMENT TRANSFORMERS

CS410 5V.C.T. 3A; 5V.C.T. 3A; 5V.C.T. 6A; (4-83's) 5000 V. ins.	\$ 5.00
CS411 2½V.C.T. 6A; 2½V.C.T. 6A; 2½V.C.T. 12A; (4-866A's, etc.) 10,000 V. ins.	10.00

Write for CSI Bulletin for more details

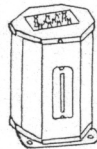

VT-1

VT-1 This Variactor is incorporated with a universal audio transformer. Two primaries are provided. One is suitable for working from a single or double button microphone, a low impedance pickup, or a line; the other primary is designed to work out of the plate of a tube or from a high impedance pickup. The secondary winding is center-tapped and is equally suitable for working into one or two grids. The types of response curves possible are shown in curves A to H in bulletin 1120.

List Price \$8.50

CHROMSHIELD "CS-5" KIT

A new, unique circuit, using the 6A6 tube cascaded into pushpull 6B5's to effect a gain of approximately 100 db. Peak power output 22 watts. Normal output 15 watts. List price of complete transformer kit with chassis \$20.25
Your net price 12.15

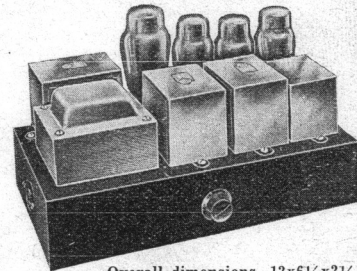

Overall dimensions, 12x6½x2½

For more details on Chromshield Kits see July issue of "RADIO"

UNITED TRANSFORMER CORP.

72-78 SPRING STREET

Export Division, 15 Laight St., New York, N. Y.

NEW YORK, N. Y.

Exclusive UTC distributors carrying a complete stock of UTC products.

Goldhamer's, Inc.	610 Huron Road, Cleveland, Ohio	Hall's	35 So. Cameron, Harrisburgh, Penna.
Wholesale Radio Service Co., Inc.	100 Sixth Ave., New York, N. Y.	Herbach & Rademan	438 Market St., Philadelphia, Penna.
Wholesale Radio Service Co., Inc.	219 Central Ave., Newark, N. J.	Cameradio Company	603 Grant Street, Pittsburgh, Pa.
Wholesale Radio Service, Inc.	430 W. Peachtree St. N. W., Atlanta, Ga.	W. H. Edwards & Co.	32 Bway, Providence, R. I.
Sun Radio	227 Fulton Street, New York, N. Y.	Seattle Radio Supply, Inc.	2319 Second Ave., Seattle, Wash.
Gross Radio, Inc.	51 Vesey Street, New York City	Portland Radio Supply Co.	1300 W. Burnside, Portland, Ore.
Leeds	45 Vesey Street, New York City	Spokane Radio Co., Inc.	611 First Ave., Spokane, Wash.
William Gram	1444 Sheridan St., Lansing, Mich.	San Francisco Radio Exchange	1284 Market St., San Francisco, Calif.
Mohawk Electric Co.	1335 State St., Schenectady, N. Y.		
Walter Ashe	1100 Pine St., St. Louis, Mo.		
Radio Shack	46 Brattle St., Boston, Mass.		
Harvey's Radio	105 W. 43rd St., New York, N. Y.		
United Radio Service	616 Main St., New Britain, Conn.		
Nutter & Cross	900 Milk St., Boston, Mass.		
Hatry & Young	203 Ann St., Hartford, Conn.		
Marine Radio Co.	124-13 101st Avenue, Richmond Hill, N. Y.		

SOUTHERN CALIFORNIA

Pacific Radio Exchange Inc.	729 S. Main St., Los Angeles
Radio Supply Co.	912-14 S. Broadway, Los Angeles
Coast Electric Co.	744 G. St., San Diego
Prest & Dean Radio Co.	400 American Avenue, Long Beach
Radio Television Supply Co.	1701 S. Grand Ave., Los Angeles, Calif.
Radio Specialties Co.	1516 West 8th St., Los Angeles, Calif.