

**OHM'S LAW**

$$E = I \times R$$

$$R = \frac{E}{I}$$

$$I = \frac{E}{R}$$

**CONDENSERS IN SERIES**

$$C_{TOTAL} = \frac{C_1 \times C_2}{C_1 + C_2}$$

**RESISTANCES IN PARALLEL**

$$R_{TOTAL} = \frac{R_1 \times R_2}{R_1 + R_2}$$

25c [ 30c in Canada ]

OCTOBER, 1935

\$3.00 PER YEAR BY SUBSCRIPTION

# RADIO

ESTABLISHED 1917

## SHORT-WAVE AND EXPERIMENTAL

**BOTTOM VIEWS OF SOCKETS**

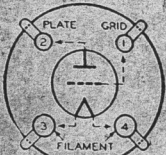

4-PRONG SOCKET  
50-201-A, 45, 210, 30, 31, ETC.

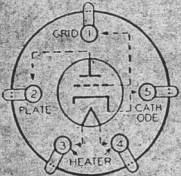

5-PRONG SOCKET  
56-46-47-76-27-37  
(Cathode is Screen Connection for '47)

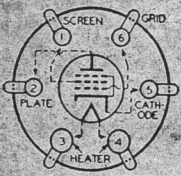

6-PRONG SOCKET  
2A5-41-42-43

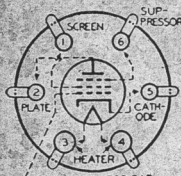

6-GRID-METAL TOP CAP  
6-PRONG SOCKET  
57-58-606-6D6-77-78

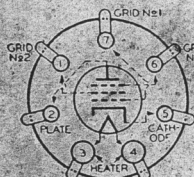

7-PRONG SOCKET 59

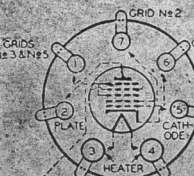

4-GRID No. 4-METAL TOP CAP  
7-PRONG SOCKET  
2A7-6A7

- IN THIS ISSUE -

- ★ The "Super-Gainer" With Crystal Filter
- The 20-Meter Problem and Its Solution
- Low-Power C.W. Transmitters for Newcomers
- Checking Transmitters With the Oscilloscope

- Ham Hints
- DX News
- New Products

*Oscillograph readings on 5-meter*



**GOING UP!**

The illustration shows the new super-power Low C triode, the 500T, by EIMAC. Crouching alongside the big fellow is a standard '03A 100-watter. The new 500T is designed to operate 'way down into the ultra-high frequency spectrum. New 5-meter records should be made by those who already have this giant tube on the air.

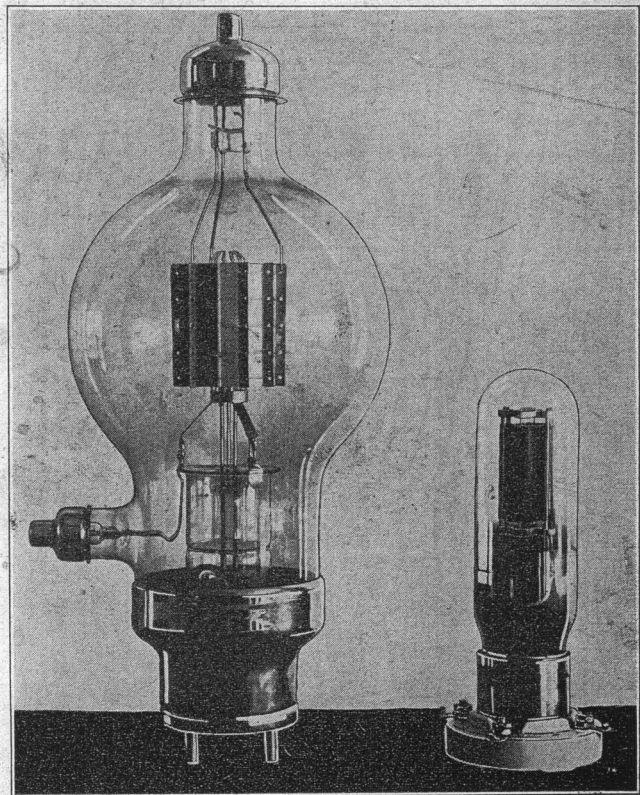

**FEATURE ARTICLES BY . . .**

FRANK C. JONES  
HERB. BECKER

D. B. MCGOWN  
FRANCIS CHURCHILL

SUMNER B. YOUNG  
HENRY WILLIAMS



That's what they all want to know — "What training have you had?" "Are you equipped mentally to keep pace with radio development?" "Is your mind trained to analyze — to reason things out for itself?"

After all, he has a right to be particular. He doesn't want a man who can just do what he is told — he wants a set of brains that can do its own thinking.

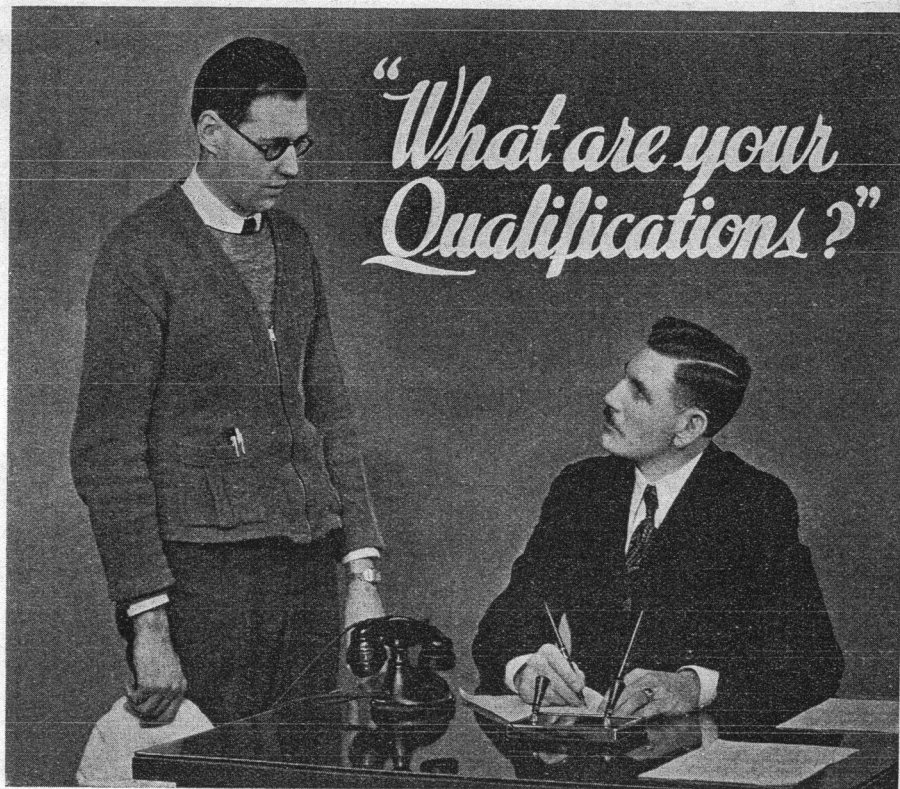

# "What are your Qualifications?"

The Edison Electrical Schools' course in Practical Radio Engineering trains you to do your work intelligently; to know the what and how and *why* of your work; to figure things out for yourself in matters of design, operation, and maintenance of radio equipment. It trains you from the ground up; thoroughly, carefully, effectively. If Practical Radio Engineering is your profession, or you are interested in making it your profession, do the job right. Master the subject. Write us today for our latest bulletin, and the complete outline of our course in Practical Radio Engineering. Let us tell you about our combined home-study and resident laboratory training; our method of teaching the theory as well as practice. We'll send along a sample lesson so that you may see for yourself how the subject is presented. Please tell us whether you are a beginner in radio, or have had some training and experience.

## MAIL THIS NOW

Please send me your Bulletin No. R-59 and a sample lesson of your Practical Radio Engineering course. I am now a Beginner  Amateur Operator  Commercial Operator  Radio Service Man

Name.....

Street.....

City and State.....

RADIO SOUND TELEVISION ELECTRONICS

# EDISON ELECTRICAL SCHOOLS



1740 University Avenue  
Berkeley, California



# Now *You* can build this PROFESSIONAL COMMUNICATION 10-TUBE SUPERHET



and save over

# 50%

No longer need you yearn in vain for that expensive communication receiver. Here's one that you can build at home, for less than half the cost of a factory-built set. You can buy the standard parts just as you can afford, or complete the job all at once if you wish.

This new "RADIO"-SILVER 9 to 200 meter professional superhet was designed by the Technical Staff of "RADIO" Magazine in collaboration with McMurdo Silver and fifteen of America's biggest part makers. And it comes to you on this money saving plan through the cooperation of these well known manufacturers of high grade radio equipment.

## 9 to 200 Meter "RADIO"-SILVER HIGH-FREQUENCY SUPERHETERODYNE

**LOOK**  
*what you get in this  
fine*  
**PROFESSIONAL  
SUPERHET!**

- Ten Raytheon Tubes.
- Two Tuned R. F. Stages on all four bands.
- Four Low-C Tuning Bands, 1500 to 33,000 kc. (9 to 200 meters).
- Ample and Accurately Relogging Crowe Band Spread Tuning anywhere in its range.
- Bliley Crystal Filter For Single Signal that doesn't cut down volume.
- All Chitran A. C. Operated—one unit—without hum.
- 8-inch Jensen Concert Speaker—and head phone jack.
- Polished Chromium Welded chassis.
- Air Tuned Polyiron I. F.—3 pi coils and big, no-loss copper shields.
- Separate R. F. Coils positively switched for each band—all Hammarlund Air Trimmed, not unstable compression mica.
- Sensitivity 1 Microvolt absolute and better.
- Selectivity just what you want—variable 50 cycle to 10 kc.
- Amplified Automatic Volume Control.
- No Inherent Circuit or Tube Noise—lets you copy signals now lost in the noise of the best competitive sets.
- Wired With Made-up Colored Coded Cable—requires no circuit tracing, or even a diagram.

**SEND TODAY for  
"HOW TO BUILD IT"  
Book—Buy parts from your  
local jobber**

This is not the usual makeshift "build-it-at-home" kit, but a precision job engineered for laboratory building. Yet it's so skillfully designed that any amateur at all can assemble it at home with pliers, screw driver and soldering iron. It's so thoroughly worked out that ordinarily critical alignment and testing is almost child's play. It requires no expensive test equipment—only what's right in it!

**Start for as little as \$7.30  
Buy the parts as you build!**

For only 10c (stamps or coin) we will send you the 32-page "How To Build It" book which tells the whole story of this latest and "hottest" high-frequency receiver. It is really an education in high frequency superhets—profusely illustrated with photographs of every assembly and wiring step, diagrams, performance curves, and testing and alignment procedure so simple that any amateur can build and align it in an evening.

Now is the time to get set for the good DX season. Start building this real receiver, that costs you less than half the price of equally good factory built sets. It can be yours for the bare cost of easily obtainable parts and a few hours fun of building it.

You can start for as little as \$7.30 and buy needed parts from your local jobber as you build. You've probably got many of its parts right now!

### SPONSORED BY

Bliley Piezo Electric Co., Crowe Name Plate and Mfg. Co., Hammarlund Mfg. Co., Chicago Transformer Corp., Yaxley Division of P. R. Mallory Co., Jensen Radio Mfg. Co., Sprague Products Co., Continental Carbon Co., Ohmite Mfg. Co., Readrite Meter Works, Raytheon Production Corp., Alladin Radio Industries, Inc., Steel Box & Display Co., Filtermatic Mfg. Co., McMurdo Silver Corp.



**MAIL COUPON  
WITH 10c**  
in stamps or coin for  
32-page Book  
"HOW TO BUILD IT"

R-S MERCHANDISING COMMITTEE  
1701 Roscoe St., Chicago, Ill., U. S. A.

Enclosed find 10c (stamps or coin) for which send me at once 32-page "HOW TO BUILD IT" Book with all details of new 10-Tube Professional Superhet.

Name.....  
Address.....  
City..... State.....  
10-RN

**R-S MERCHANDISING COMMITTEE**  
1701 Roscoe Street Chicago, Illinois, U. S. A.



# A Revolutionary Development!

## AMPEREX CARBON ANODE TUBES

### for Ultra-High Frequency Operation

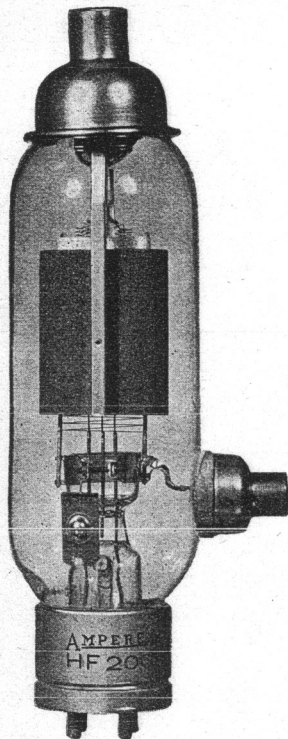

## AMPEREX HF 200

List Price \$24.50

#### RATINGS AND CHARACTERISTICS

##### Filament:

Voltage 10 Volts A. C.

Current 3.5 Amperes

Plate: Voltage A.C. 3000 Volts Max.

Grid: Maximum allowable r.f. current  
15 amperes

AVERAGE CHARACTERISTICS at Ef

10 Volts D.C. Ep 1000 Volts D.C.;

Eg 20 Volts D.C.

Plate current 150 milliamperes

Amplification Constant 17.5

Grid to Plate Transconductance 5000  
microhms.

AMPEREX has developed a distinctive group of tubes revolutionary in their design, which are especially suitable for ultra-high frequency operation.

Their performance at these frequencies is truly startling. A plate power output as high as 500 watts has been obtained from a single tube at 5 meters, and proportionate outputs at the lower wave lengths. Their remarkable performance has been made possible by the design which gives these tubes the distinct advantage of possessing the highest ratio of trans-conductance to inter-electrode capacitance yet attained in any tube. This characteristic in combination with their high mu reduces the requirements for grid excitation to a minimum.

Among the many engineering and design refinements and developments which make these tubes outstanding performers at ultra-high frequencies are the following:

A large plate area and a planer filament suspension resulting in low plate resistance and high transconductance. Large power outputs may therefore be obtained from these tubes at comparatively moderate plate potentials.

Grid and plate leads are as short and as of great an area as possible and taken to the nearest point in the glass envelope, thereby reducing R.F. lead resistance.

An ingenious grid support permits high insulation between grid and filament at the stem and the exclusive Amperex "Channel Supports" offer a positive contact low-loss path for the R.F. plate currents.

The plate itself is made of Graphite, the perfect heat radiating material, and represents an area of over 10 square inches.

The grid and plate terminals are designed with large heat radiating areas and silver soldered to their respective leads.

The design characteristics of these new high frequency tubes enable them to withstand abnormally high voltage and handle efficiently the resultant large circulating R.F. currents without danger of break-down or over heating.

These new Amperex tubes are proportioned along conventional lines. There is nothing freakish in their structure or appearance. In their design is incorporated the latest engineering practice and knowledge of ultra-high frequency operation.

*A characteristic and data sheet describing higher and lower power output tubes than the one illustrated here is available and will be mailed on request.*

**AMPEREX ELECTRONIC PRODUCTS, INC.**  
79 WASHINGTON ST. BROOKLYN, N. Y.

*West Coast Representatives*

C. R. STRASSNER  
1341 So. Hope St.  
Los Angeles, Calif.

R. C. JAMES  
Northwestern Agencies  
Third Avenue and Vine St., Seattle, Washington



BRANCH OFFICES:  
New York City,  
253 W. 128th St.  
Tel. MOnument 2-2812

Boston,  
J. H. Condon,  
6 Marlboro St.

Chicago,  
C. W. Nelson,  
3618 North Bernard St.

# RADIO

ESTABLISHED 1917

Reg. U.S. Pat. Off.

A NATIONAL MAGAZINE - PUBLISHED MONTHLY

Publication Offices—Pacific Building, San Francisco, California

H. W. Dickow, Publisher.

D. B. McGown, Technical Editor.  
Clair Foster, Amateur Activity Editor.

Frank C. Jones, Engineering Editor.  
C. C. Anderson, Engineering Draftsman.

25c per copy, \$3.00 per  
year by subscription in  
the U. S. \$4.00 elsewhere  
Send subscriptions to  
the San Francisco office.  
Entered as second class  
matter at the Post Office  
at San Francisco, Cali-  
fornia, under the Act of  
March 3rd, 1879.

Vol. 17

OCTOBER, 1935

No. 10

## Radiotorial Comment

### No ARRL "H.Q." Representation at Pacific Convention. Publication of Investigating Committee's Report Is Requested.

Almost 900 strong, the Pacific Division conventioners successfully conducted the largest, most dignified, most impressive, most orderly, most business-like affair of its kind ever held in the United States. The swank Biltmore Hotel was literally infested with radio bugs. Contagious they were, but only in that every amateur in attendance was bitten by the germ of friendliness, co-operation, fair-play!

The all-important conclave of radio amateurs, hot-bed of the anti-W-Men, was left high and dry without representation from Hartford! At an affair where not one, but two or three key-men should have put in their appearance from Hartford, the amateurs felt slighted to learn that the bosses of their own league had not sent at least one of their henchmen to pour oil on the troubled waters of the Pacific.

Director Culver was there . . . alert, cheerful, powerful! He commands the respect of the amateur, no matter where he goes. The convention at Los Angeles was the last of the southern gatherings at which Director Culver will preside; a new division is being whipped into shape, down there in the south. It will have its own director.

It is hoped that the southern amateurs will heed the advice of Culver . . . elect a man who will carry on the fight for the south in the same way that he, Culver, has fought for all of his division. Culver's activities will soon be confined to the northern section of the Pacific Division.

One of the candidates for director of the new division may formally request that serially-numbered ballots in duplicate be mailed to all in the division who are eligible to vote. Previously reported voting irregularities at Headquarters prompt this candidate to protect his interests. Director Culver needs a staunch, aggressive, California team-mate to sit with him on the board at Hartford. The several thousand readers of this magazine who reside in the southern portion of the state are urged to vote for the man who will PROTECT their interests. Such a candidate is in the race. You will meet him at your club, you will hear him on the air. He is a man who will impress you the moment you shake hands with him. The editor is curious to know how many amateurs have at this early date already picked the winner of the race. "He's a cinch", they say down south.

● The Pacific Division Convention passed a number of resolutions which will go down in amateur radio history.

Those at the open forum criticized the fact that the present league counsel is also the legal arm of a group of commercial radio interests. Thus a resolution was adopted which requests that the status of counsel fall in the same classification as that of league director.

The Cairo Club of San Jose presented a resolution to the effect that its original Cairo Plan be adopted by the ARRL's Cairo Committee—and the resolution was unanimously adopted. After the Cairo Club of San Jose had already presented its plan to some of the members of Congress, the ARRL saw fit to also appoint a Cairo Committee. Wise are the members of the ARRL's Cairo Committee if they adopt, without reservation, the draft which was prepared at San Jose.

Another resolution requested removal of headquarters from Hartford to a more-centrally located city. Then came a resolution that the board meet more than once each year. Still another resolution requests immediate action for widening the 40-meter band.

The all-important resolution calls for publication, in full, of the findings of the ARRL Investigating Committee. It has been widely rumored that this is to be a secret document, much to the embarrassment of those who helped wage the struggle to bring about the appointment of the Investigating Committee. Director Culver therefore takes to Hartford a resolution that the report of the Investigating Committee be published in full in all membership copies of QST.

More bitter than "The Bitter Tea of General Yen" would be the refusal of the board to permit the entire ARRL membership to know what goes on behind the scenes of an Investigating Committee. Whitewash, too, is hard to digest. A combination of the two could spell disaster.

● Those little pink slips which the amateur receives from the Federal Communications Commission in Washington were the cause of a highly interesting controversy at the Pacific Division Amateur Convention. A sore-spot, an indelible blot on the record of the offending amateur are these pansy-hued certificates of law violation. Argument waxed furiously from the convention floor as to a proper resolution to draft for submission to the FCC, via the usual conglomeration of grape-vine through which these requests must eventually pass.

Each year at a Pacific Division Convention there has been a motion made, seconded and carried, that the radio amateur be permitted to increase his power so that the output from,

rather than the input to, the final amplifier can be a full one-kilowatt. Each year this resolution has been made by Don C. Wallace, W6AM. So when Wallace took the floor at this year's Pacific Division Convention, the chairman's gavel rapped for order and Wallace was asked if his "high-power resolution" was to be made again.

But Wallace had something else in mind this year. The pink slips from the FCC were his grounds for complaint. Said Wallace: "An automobile driver can be 'tagged' a dozen or more times within the course of a year. But at the end of each year the tags are 'squared' and the offender is given a clean slate with which to begin a new year. Not so with the radio amateur. His pink certificate from the FCC is a more permanent adornment; it stays with him for keeps." Mr. Wallace then moved that a request be made that the FCC wipe clean the slate once each year of amateur radio offenses. Pink slips from the FCC are issued to amateurs who operate outside the assigned frequency bands; to those who cause wilful QRM; to those whose signals are not Simon-pure DC, no matter what kind of a groan a commercial station may pump into the air.

The first pink ticket comes to the offender as a warning, and he is asked to explain why such-and-such an offense was committed. The criminal then sits before his rusty typewriter, applauds himself with his knees, and sends a dignified-looking note to FCC telling them that he really don't know why the offense was committed, . . . and he throws himself on the mercy of the court. He later finds that he is not to be shot at sunrise, even though he don't get up that early in the morning. But when he gets the second of a series of three pink slips he has a more difficult problem on his hands. And when the third and final slip arrives he is faced with a suspension of his license. Once each year these pink slips should be destroyed, moved Mr. Wallace, and the amateur given a clean bill of health with which to start a new year. Amendments, amendments to the amendment, and amendments to the amendments to the amendments were made, until the matter became so confused that the chairman ordered all of the amendment-makers to accompany the original resolutions-maker to an ante-room and bring back a new resolution which could be understood by all. When the jury filed back into the room its verdict was unanimous that only the original resolution should stand. Thereupon it was unanimously carried that

(Continued on page 33)



# The New HF-200 Tubes in a Variactor Controlled Carrier High-Power Phone

By WM. L. COMYNS\*

• This transmitter uses the new HF 200 Amperex transmitting tubes in a linear amplifier driven by a Class C stage of controlled carrier. This results in giving about two to three times as much output from this linear stage as could otherwise be obtained in the conventional linear stage excited by the modulated Class C stage. The HF 200 tube has a rated plate dissipation of 150 watts. With a little "crowding", the input can be run up to a kilowatt for a pair of them.

The controlled carrier method used is the UTC variactor system operated by means of a Class B audio modulator. The varying current to the Class B audio tubes varies the amount of core saturation in a variactor, which in turn controls the plate voltage supply of the modulated Class C stage. An auto-transformer is used to compensate for the fixed line voltage drop through the variactor.

The entire transmitter was built into a metal frame with aluminum front panels so as to give a very pleasing finish. The special finish does not show finger marks and does not tarnish.

## Audio System

The speech amplifier uses a 57 tube connected as a triode, with transformer input. This tube drives a pair of 56s in push-pull which, in turn, drive a pair of 45s in push-pull. The latter act as a driver stage for a pair of Class B 801s which develop approximately 50 watts of audio power. The variation of plate current to the 801 tubes is used to actuate a UTC type AV-2 variactor for control of the Class C stage carrier output.

The audio amplifier plate supply uses an 83 rectifier with choke input filter. The C bias supply for the 801 Class B stage is from a pair of 82s in full-wave connection with choke input and a 2000 ohm bleeder. The plate current to either 801 can be read in order that a good balance can be obtained for proper Class B operation with low distortion.

## Exciter and Buffer

A Jones exciter is used with a 53 tube and a 160 meter crystal in the oscillator section. The second section of the 53 is used as a doubler to the 75 meter phone band. Link coupling provides good drive to the grid of an 801 buffer stage which uses plate neutralization. This buffer stage provides good isolation between the modulated stage

and the 53 tube and insures plenty of grid excitation to the Class C modulated stage.

The plate supply for these stages consists of a conventional 83 full-wave rectifier with choke input to the filter. C bias for the 801

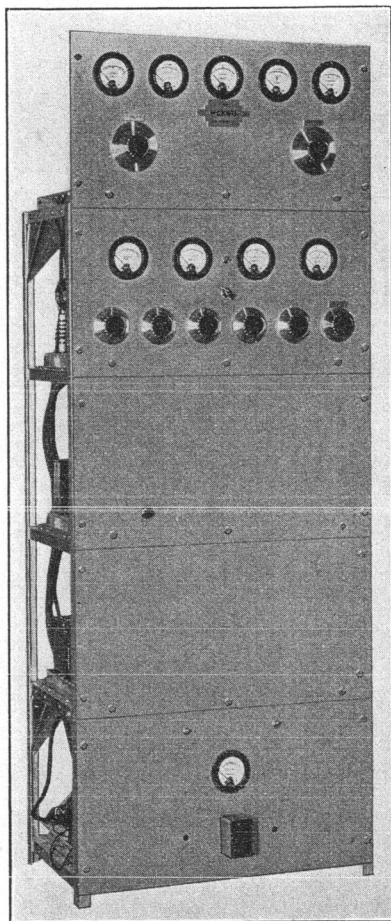

Front View of Controlled Carrier Phone Transmitter

and modulated stage is obtained from a 350 volt low resistance power supply using a pair of 82 tubes with a 1000 ohm bleeder across the output of the filter.

## Modulated Class C Stage

Link coupling from the 801 buffer drives the 203H Class C stage. The latter is plate neutralized and has its plate supply controlled by the variactor for controlled carrier output to the high power linear stage. This modulated stage is run at low power with an 83 rectifier power supply. The 801 Class B audio stage modulates this 203H tube to its full limit and the carrier output depends upon the voice syllabic output from the Class B stage.

## Final Amplifier

The final amplifier uses a pair of HF-200 tubes with a plate supply of 2750 volts. The latter is supplied by a pair of 866As in a full-wave rectifier with choke input to the filter. Split-stator tuning condensers are used in both grid and plate circuits of this stage, with link coupling to the modulated Class C stage and also to the external tuned antenna coil. Provision has also been made for the use of a Collins network for antenna tuning instead of link coupling, when desired.

C bias for the final stage is taken from the same power supply which is used for the previous RF stages. The value of voltage is fixed at cut-off for operation as a linear amplifier. A 5000 ohm swamping resistor is shunted across a portion of the grid coil in order to present a fairly uniform load impedance to the modulated Class C stage. Cross-neutralization is used in this push-pull RF stage.

## Power Controls

The power input to the transmitter is controlled by a main line switch and an AC operated relay with two time-delay relays. The latter provide protection for the tubes. Incorporated into the main line switch is an overload relay which is set to operate at a value which offers protection to the entire transmitter. Another switch also provides for break-in purposes and duplex operation, cutting off the carrier during listening periods.

Metering in the low power stages is provided by means of a rotary switch and a 0-1 MA meter. Suitable resistance shunts across the switch points allow grid and plate currents to be read with the one meter.

\* Radio Instructor, Frank Wiggins Trade School, 1646 So. Olive St., Los Angeles, California.

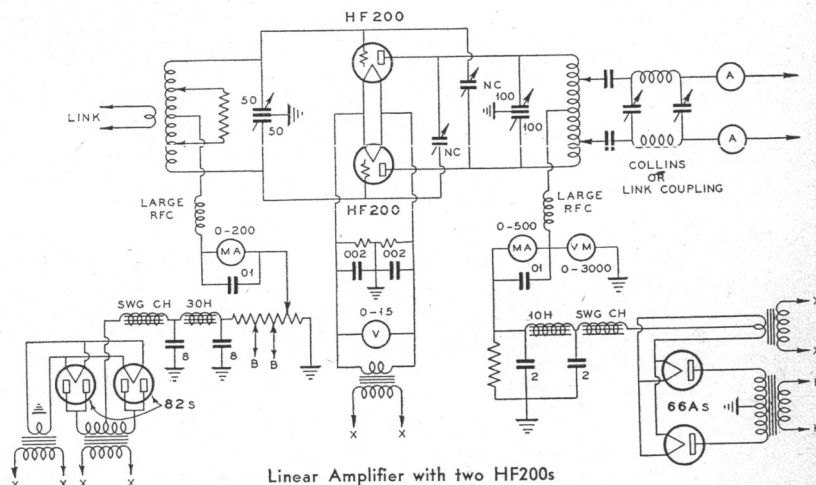
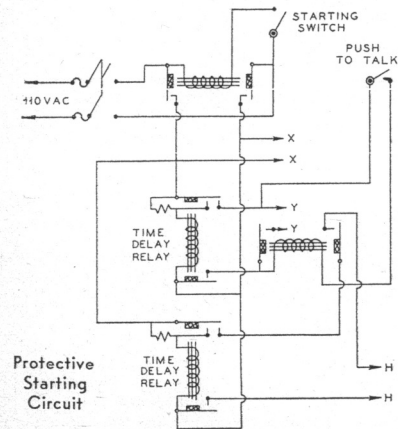



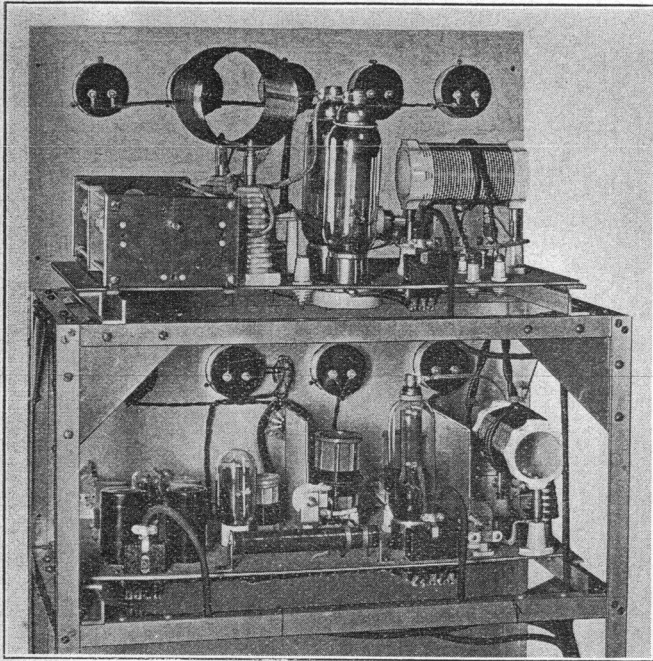

Rear views of the high-power Variactor Controlled Carrier Transmitter showing 203-H driver and HF200 Final. The illustration at the right shows the complete power supply and audio channel. The Variactor units are on the middle shelf, at the extreme right.

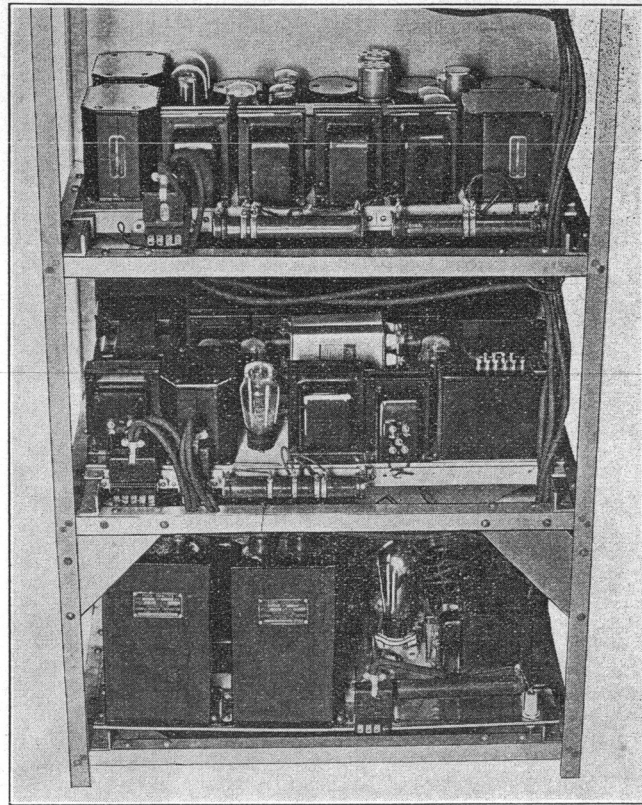

### Standard Frequency Service Broadcast By National Bureau of Standards

The National Bureau of Standards, Department of Commerce, provides a standard frequency service which is broadcast by radio. Beginning October 1, 1935, this service will be given on three days each week, from the Bureau's station WWV, Beltsville, Md., near Washington, D. C.

On each Tuesday and Friday the emissions will be continuous unmodulated waves (CW); and on each Wednesday they will be modulated by an audio frequency. The audio frequency will be in general 1,000 cycles per second. (There will be no emissions on legal holidays).

On all emissions the radio carrier frequencies will be transmitted as follows: noon to 1 P.M., Eastern Standard Time, 15,000 KC (kilocycles per second); 1:15 to 2:15 P.M., 10,000 KC; 2:30 to 3:30 P.M., 5,000 KC.

During the first five minutes of the one-hour emission on each carrier frequency, announcements will be given. For the CW emissions, the announcements will be made by telegraphic keying and will consist of the station call letters (WWV) and a statement of the frequency; this announcement will be repeated every ten minutes. For the modulated emissions, the announcements will be given only at the beginning of the hour; they will be given by voice and will include the station call letters and a statement of the carrier frequency and the audio modulation frequency.

Except during the announcements, the CW emissions will consist of continuous, unkeyed carrier frequency, giving a continuous beat note in the telephone receiver in heterodyne reception. The radiated power in the CW emissions will be 20 kilowatts.

The modulated emissions, except during the voice announcements at the beginning of the hour, will consist of an uninterrupted audio frequency superposed on the carrier

(Continued on page 15)

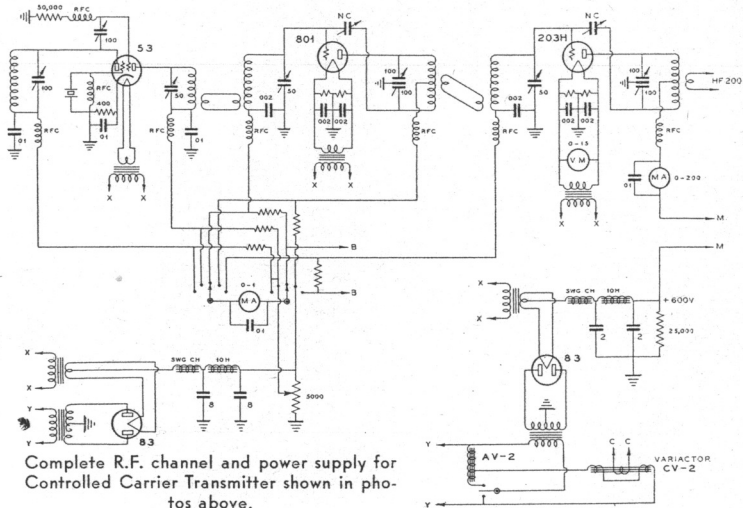

Complete R.F. channel and power supply for Controlled Carrier Transmitter shown in photos above.

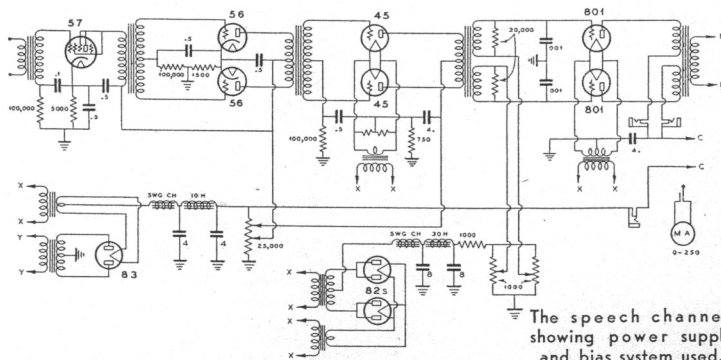

The speech channel, showing power supply and bias system used.

# "Underneath the Whitewash"

## An Amazing Disclosure of Amateur Radio Losses

### ★ Editor's Note:—

It has been written that the radio amateur suffered no important losses in his operating and frequency assignment privileges . . . that the campaign to expose the incompetence of those responsible for these losses is without foundation. The editor deprecates the method used to hoodwink the amateur into believing that he has been accorded full protection by his self-styled leaders. That an important series of substantial losses has been experienced is herein proved by Mr. Sumner B. Young. He speaks from fact, not fancy! The whitewash brush is not his weapon, nor does he resort to alibi and innuendo in driving home the true FACTS which give the lie to those who are so desperately trying to deceive the amateur.

● We Amateurs in the United States have experienced a series of losses in frequency assignments, although a contrary statement appears on page 39 of the June, 1935, "QST."

It is admitted that we did lose some frequencies when the Washington Treaty went into effect; but the argument is, that one loss, no matter how great, doesn't make a series. Perhaps Headquarters feels that what Congress gave us, under its own Radio Act of 1927, was comparatively unimportant. An international status, giving us fewer frequencies, may seem preferable to West Hartford. But many of us believe that when it comes to figuring the sum-total of our gains or losses, we should go back to the 1912 Act, and trace the story from there, instead of saying that "life began at Washington," in 1927, when the Treaty was negotiated.

The "QST" account tries to discourage us at the outset, by telling us that at some time or other the 1912 Act "broke down," and by intimating that our rights under it were not bottomed on a valid law.

And somewhere along the line it tells us that we never had any rights below 150 meters.

The truth, as I see it, is that under the act of 1912, we Amateurs were entitled to use the entire band of wavelengths from zero to two hundred meters. There is good ground for argument that to all intents and purposes this territory was ours exclusively; for although Regulation 15 of Section 4 of that Act gave commercial stations the privilege (if it could then be called a privilege) of dropping down to wavelengths below two hundred meters, for some purposes, they could not engage in commercial traffic-handling there. (See, also, the preamble of Section 4, relative to temporary licenses to experimenters.)

The interesting fact about the Law of 1912 is, that it did not confer upon the Secretary of Commerce legal authority to make regulations which compelled stations of the same class to use narrow bands of wavelengths. Aside from giving him certain minor discretionary powers, all of the authorized regulating that could be done, was set forth explicitly in the act itself. And the 1912 Act directed certain classes of stations to use certain wavebands, and did not divide each band up into little slices and apportion the pieces between the various stations authorized to operate within that particular band.

The 1912 Act never ceased to be law until superseded by the Act of 1927. It was not the best possible law under which to administer a growing art. After a while, extra-legal agreements and unlawful Regulations came into be-

By SUMNER B. YOUNG, W9HCC

ing, nourished very largely by a series of four Conferences which were called together at Washington by the Secretary of Commerce. These agreements and Regulations collapsed in July, 1926, following the decision of the well-known Zenith case in the Federal District Court for the Northern District of Illinois (12F.(2nd)166) and the opinion on the effect of that decision which Acting Attorney General of the United States Donovan rendered to Secretary Hoover on July 8th, 1926, (35 Op. Atty. Gen. 126). They collapsed because they were not legally warranted by the 1912 Law. The period which intervened between July 9th, 1926, and the enactment of the Radio Act of 1927 by Congress on February 23rd, 1927, was marked by virtually unregulated and chaotic operation of radio stations (broadcasting stations, in particular); and it has ever since been known in the radio world as the so-called "breakdown of the law," (See Reports of American Bar Association, Vol. 54, p. 442).

The principal thing to remember in connection with these four Conferences (variously called "Radiotelephony Conferences," "National Radio Conferences" and "Hoover Conferences") is that when our Amateur Representatives "sat in on them," they had tremendous bargaining-power available to them, if they properly understood our rights under the 1912 Act. But we shall see, as our story unfolds, that the men who represented us there did NOT fully appreciate what the second of the four Conferences (the one in 1923) was all about, were not (in 1923) aware of our rights under the 1912 Law, did not develop our bargaining-power fully, and thereby committed a momentous blunder. At a later date our executives became aware of this, but they never admitted the error of their ways. They have "whitewashed" the affair instead.

Later on, we shall see that in 1927 there was another disaster. Our representatives again failed to realize in advance what another type of Conference would be like; and that time, we had a whole lot less bargaining-power with which to protect ourselves. This affair has received similar treatment.

It seems to me that a recital of the facts as I see them may serve to point some salutary lessons. Anyway, the "whitewash" has been wearing thin; and the rank and file of "Hamdom" is old enough and intelligent enough, to be told the truth.

Let's begin at the beginning.

First, let's see what the Standing Committee on Radio Law of the American Bar Association said in regard to the Radio Act of 1912 in its 1929 Report in volume 54 of the Reports of the American Bar Association, pages 438 et seq:

"The United States participated in the London Conference and signed the second great International Radio-telegraph Convention on July 5, 1912; the treaty was ratified by the United States on February 5, 1913. In the meantime, partly as the result of a realization of the importance of radio growing out of the Titanic disaster and partly to carry out the obligations of the United States under the Berlin Convention, Congress enacted the first comprehensive statute regulating radio communication on August 13, 1912. This Act is usually referred to as the Radio Act of 1912. Under its terms interstate radio communication was

forbidden without a license from the Secretary of Commerce and Labor . . . No power to make regulations was conferred upon the Secretary of Commerce, and the regulations required by the treaty were set forth in detail in the statute . . . While the Act contained a section defining radio communication in such a manner as to include both radiotelegraphy and radiotelephony (the latter being at that time only a dream of the future), the rest of the Act was phrased with reference almost exclusively to radiotelegraphy. In spite of his lack of statutory authority, the Secretary of Commerce adopted and promulgated a series of regulations in 1919."

Page 439:

"The Radio Act of 1912 remained in force until Feb. 23, 1927. During that period it was never passed upon or interpreted by the United States Supreme Court. One of its great defects, however, was clearly prophesied in an opinion by Attorney General Wickersham, rendered on November 2, 1912, in which he advised the Secretary of Commerce that the issuance of a license to an applicant was mandatory if the applicant was a citizen of the United States and that corporations organized in the United States, even though controlled by foreign stockholders, were American citizens within the meaning of the Act. The occasion for this opinion was the application of the Atlantic Communication Company (controlled by German stockholders) for authorization to operate the Sayville station on Long Island. It will be remembered that this station was later taken over by the United States because of violation of its neutrality laws. . ." (Italics ours).

This indicates some of the defects in the 1912 law, and demonstrates the Secretary's lack of power to issue Regulations.

What of our wavelength assignments under that Act? Regulation 15 of Section 4 of the Radio Act of 1912 (which is not to be confused with the illegal Regulations issued by the Secretary of Commerce and not contained in the Act itself) says:

### "General Restrictions on Private Stations.

"Fifteenth. No private or commercial station not engaged in the transaction of bona fide commercial business by radio communication or in experimentation in connection with the development and manufacture of radio apparatus for commercial purposes shall use a transmitting wave length exceeding two hundred meters, or a transformer input exceeding one kilowatt, except by special authority of the Secretary of Commerce contained in the license of the station . . ."

Since it is now well established that the Secretary had no legal authority to tell us that our assignment should begin at 150 meters, or any other spot in this band running from zero to 200 meters, the only other question worth discussing at this point is whether or not the 1912 Law required us to share our frequencies with commercial stations; and, if so, to what extent.

Bearing in mind that in 1912 the high frequencies were thought to be commercially worthless, the fair interpretation of Regulation 15 of Section 4 (supra) seems to be, that if a commercial station wished to abandon bona fide commercial message-handling, or the conducting of experiments in connection with the development and manufacture of radio apparatus for commercial purposes, and to engage



in non-commercial activities, it was relegated to this undesirable region, and its power input was restricted to Amateur levels. There was no thought of authorizing commercial radio operation in the Amateur band.

Part of the preamble of Section 4 authorized the Secretary of Commerce to grant . . . "special temporary licenses to stations actually engaged in conducting experiments for the development of the science of radio communication, or the apparatus pertaining thereto, to carry on special tests, using any amount of power or any wave lengths, at such hours and under such conditions as . . . (would) . . . insure the least interference with the sending or receipt of commercial or Government radiograms, or distress signals and radiograms, or with the work of other stations . . ." Italics are ours.

The amount of experimental or of non-commercial radio communication by commercial stations in Amateur bands, then to be expected, was (naturally) almost nil. In practice, I believe it never amounted to a "hill of beans."

Our frequency (wavelength) assignments under the 1912 Act were, to all intents and purposes, then, exclusive; and our conclusion in this regard is reinforced by the author of the first radio law treatise ever written (Davis, "Law of Radio," 1927 Edition, p. 29):

... "At the time of the passage of the act, there were three known classes of radio stations:

"1. Government stations, which were excluded from the law.

"2. Ship stations and shore stations engaged in commercial communication.

"3. Amateur stations, referred to in the act as private stations 'not engaged in the transaction of bona fide commercial business' (Sec. 4, 15).

"For the purpose of preventing interference between them, the law authorized the use of wavelengths for these classes as follows:

"1. Government stations: 600 to 1,600 meters was reserved for them by excluding all others.

"2. Ship to shore stations: 300 meters; 600 meters (Reg. 1), 'other sending wavelengths' (Reg. 2).

"3. Amateurs: ANY wavelengths below 200 meters.

"It will be observed that the law neither made nor authorized any distribution of wavelengths among the individual stations composing the various classes. It contented itself with interclass allocation . . .

"Under this view, it followed that since the act itself authorized the wavelengths to be used, there was no necessity for a discretionary power in the Secretary in assigning them . . ." (Italics ours).

There is also an interesting statement in the printed record in the case of Intercity Radio Telegraph Company, Appellant, v. Federal Radio Commission, (Case No. 4987, Court of Appeals of the District of Columbia; not to be confused with the famous "Intercity Case," which was entitled "Hoover, Secretary of Commerce, v. Intercity Radio Co., Inc.," and which was decided by the same Court in February, 1923).

This record, entitled "Statement of Facts and Grounds for Decisions of Federal Radio Commission," was prepared by the legal department of the Federal Radio Commission at a time when Mr. Paul Segal, now General Counsel of the A.R.R.L., was serving there. Colonel Clair Foster, W6HM, tells me that Mr. Segal sent him a copy of the printed record, underlined in red crayon. Mr. Boyd Phelps, now of Minneapolis, testified as an expert for the Intercity Company in that case, and he also has in his possession a copy of the record.

Opening it at page 85, we find the following language, which is highly significant:

"... Amateurs are persons engaged in radio communication for personal and altruistic reasons. They are precluded by the International Convention and the General Orders and Regulations of the Commission, from gaining any financial benefit from their transmissions. Prior to February 23, 1927, they were entitled to use the entire range of frequencies from 1,500 kilocycles upwards. They were the first to make practical use of short waves and demonstrated their efficacy to the world by feats of the most dramatic character. Their contributions to the science of radio communication have only too often been the demonstration of the utility of frequency ranges only to arouse the desires of commercial interests to deprive them of the use thereof.

"At the various National Radio Conferences, speaking through their authorized representatives, they offered to relinquish most of their territory for commercial development . . ." (Italics ours).

The record continues for a page or more, and devotes itself to showing what we Amateurs have done, and how many of us there are. Then it states that

"... It is to be regretted that the provisions of the International Radiotelegraph Convention have afforded them so little in the way of frequency bands."

So much, then, for what we had under the Radio Act of 1912.

Before showing how it was that we got "chiselled down" from time to time, it is well to examine a few more facts.

In particular, we should understand about the famous "Intercity Case" of 1923, because it gives us some idea of what facts were available to our negotiators and spokesmen, at or about the time when the opposition began "sniping" at us, to give them an idea of what the National Conferences called by the Secretary of Commerce were all about. This case reached the Supreme Court of the District of Columbia in 1921, and the Court of Appeals passed on it in February, 1923.

Returning to Vol. 54 of the Reports of the American Bar Association, page 439, we find this account of the Intercity case:

"... In this case an application for a license to operate a radio station in New York City had been refused by the Secretary of Commerce on the ground that there was no wave available for use which would not interfere with government and private stations already licensed. As a matter of fact, there had been considerable complaint against this particular applicant because of interference it had caused by previous operation of the station

"... The Court of Appeals upheld an order, (of Supreme Court Dist. of Col., Nov. 23, 1921), directing the issuance of a writ of mandamus against the Secretary of Commerce, and held that the Secretary had no authority or discretion to refuse a license in such a case, and was under a duty of naming a 'wavelength' for the applicant. The court further held that the Secretary's only discretion was in selecting the 'wavelength' which in his judgment would result in the least possible interference . . ."

Now, this was a very important case. It embarrassed the Secretary of Commerce considerably. The Regulations which had been issued in 1919 were without statutory sanction, but they had been issued, just the same. Broadcasting had begun in 1920, and although the Intercity Company wasn't operating a broadcasting station, the principles announced by the Court of Appeals were, as the American Bar Report went on to say, ". . . of course, applicable to broadcasting stations."

There was a great scurrying around in the Secretary's office to take an Appeal to the

Supreme Court of the United States. "... A writ of error to the Supreme Court of the United States was allowed but was later dismissed because, by reason of the abandonment and dismantlement of the station, the case became moot, 266 U.S. 636." (page 439 and footnote of the Bar Report above mentioned). This dismissal was in the October Term, 1924.

To the initiated, it doubtless was plain enough in November, 1921, and still plainer in February, 1923, that the foundations under the Regulations issued by the Secretary of Commerce were fundamentally faulty; and that in particular, his discretionary powers under the Act of 1912 were very small. A competent study of the Act itself would have disclosed our strong position under its terms, even though the Supreme Court of the United States had not spoken the final word.

Pages 35 to 37 of the July, 1923, "QST" now tell an interesting tale. In an unsigned Editorial entitled "The Status of the Radio Amateur," we are informed that—"Amateur regulation first got disturbed"—(Italics ours) at the first of Mr. Hoover's "Radiotelephony Conferences," which met in Washington on Feb. 28th, 1922.

Why was that first Conference called? From what has been said above, the 1912 Act was in some respects inadequate. The Attorney General of the United States had ruled in November, 1912, that licenses could not be denied to United States corporations even if controlled by aliens who might cause trouble. The Regulations issued in 1919 by the Department were without statutory authorization. Broadcasting stations were crowding the ether; and the Secretary's lack of power to deny an application for a license to any citizen who wanted to open up a commercial radio station, interference or no interference, had already been declared by a lower Federal Court, in the Intercity case.

The Conference met in Washington—"to try to find out what a new radio law should contain. . . ." (Italics ours).

—"The Conference decided that the new law ought not to contain any wavelength assignments but ought to be a framework saying that the Secretary of Commerce had power to assign wavelengths any way he saw fit; and it also made recommendations to him how it would be well to assign the wavelengths to the different kinds of stations. It was recommended at that time that the amateur band be changed from 'not exceeding 200 meters,' to give us from 150 to 275 meters, and instead of the 375-meter wave for special stations, 310 meters was to be used. And the band from 150 to 275 meters was to be chopped up into smaller bands according to the kind of sending set a fellow had, whether spark or C.W. or phone. . . ." (Italics ours).

The account goes on to say that "nothing ever came of these fine plans, for Congress killed the proposed new law (the White bill) and that was the end of it. And meanwhile the old law of 1912 governed . . ." (Italics ours).

This was an almost complete "tip-off" to what the Secretary of Commerce and the commercials really wanted; and to the lack of legal authority on the part of the Secretary of Commerce to tell us that our wavelength assignments should begin at any particular point in the territory running from zero to two hundred meters.

But an even plainer sign soon appeared, to show the infirmities of the 1912 Act from a regulatory standpoint, and to indicate our enormous bargaining-powers, under it, if it was to be abrogated by "gentlemen's agreements," with executive blessings:

Hoover then proceeded to call the Second "Radiotelephony Conference," convening in

(Continued on page 28)

# The "Super-Gainer" With Crystal Filter

By FRANK C. JONES

● This receiver uses the same circuit ideas which were incorporated in RADIO'S "Super-Gainer" three-tube superheterodyne described in the September issue. A four tube set was hooked-up in order to study the experimental possibilities of this circuit for single sideband or "single-signal" reception. A quartz crystal filter is used, and one stage of IF was added to the original three tube circuit. It was found that the addition of the IF stage did not produce much increase in actual sensitivity to weak signals but, of course, the crystal filter made it very selective for CW reception.

The circuit consists of a 6C6 regenerative first detector using cathode regeneration at the signal frequency. The screen-grid voltage is used as a means of varying the regeneration. For good sensitivity, this regeneration must be peaked up to just below the point of oscillation. A 76 triode tube is used as an oscillator with electron coupling into the 6C6 detector suppressor grid. The separate oscillator is necessary to prevent the loss of sensitivity at high frequencies and inter-lock tuning effect which causes trouble in circuits using a combination tube, such as the 6A7. The latter would not provide as easy a means of obtaining regeneration in the detector circuit.

The IF amplifier is exactly the same as that used in the 222 Receiver and 40-20 CW receiver previously described in "RADIO". Iron-core IF transformers are used for input and output of the 6D6 IF amplifier tube. A diode center-tapped IF transformer is used for coupling into the crystal circuit. The latter consists of a series crystal with a

phasing condenser for elimination of one sideband in the received signal. The coil center-tap provides a Wheatstone Bridge circuit for the phasing condenser and crystal. The output of the latter is coupled into a second IF transformer through a small capacity of about 20 mmfd. which prevents the low impedance of the crystal at resonance from loading the tuned circuit too much. There is very little signal loss in this crystal filter circuit when the IF amplifier and BFO are aligned correctly.

The second detector and audio amplifier uses a 79 tube. Cathode regeneration is used to provide oscillation for beat-frequency oscillator purposes. Oscillation is obtained by means of an old BCL receiver coil in series with the cathode. The control of oscillation or regeneration is by means of a tapered 10,000 ohm variable resistor connected directly across this coil. A vernier tuning condenser, mounted on the front panel, is connected across the last IF transformer secondary in order to allow exact control of the BFO frequency. Since this circuit is used as a BFO, the coupling between these two IF coils must be quite loose in order to prevent excessive tuning interlock.

This form of BFO is more satisfactory when a crystal filter is not used, because a change of frequency of a few cycles is not noticeable in the former case. The regeneration or oscillation control does change the frequency, and therefore a change means a slight readjustment of the BFO vernier condenser. If the coil coupling to the IF stage is not quite loose, a change of IF volume control will also slightly affect the BFO note. A real S.S. receiver should use more tubes which, of course, greatly complicates the circuit and construction as well as in-

creasing the cost. This economical form is more satisfactory for S.S. reception than can be obtained by means of regeneration in the IF amplifier. The cost of the 465 KC crystal is offset somewhat by the saving in other parts as compared with most regenerative S.S. receivers.

The chassis is 10-in. x 12-in. x 2-in. with a vertical shielding partition about 4/4-in. from the back edge. The front panel is 12-in. x 7-in. of No. 12 ga. aluminum. The 76 oscillator and its condensers and coil are in front of the partition. The regenerative first detector is mounted toward the rear, with its tuning condensers also in back of the partition. The 20 mmfd. tuning condensers are ganged together through a flexible coupling and give sufficient bandspread to tune easily on all of the bands from 10 to 160 meters. The coils are designed so that this value of tuning capacity, together with the proper setting of the band-setting 100 mmfd. condensers, will tune over any of the bands, including the 160 meter band. The detector 100 mmfd. condenser must be set correctly in order to obtain full benefit of the regeneration which makes this circuit very selective. This condenser must be trimmed when tuning through any band, unless the coil turns are spaced exactly right before being cemented in place on the ribbed coil forms.

The detector band-setting 100 mmfd. condenser is driven by means of an extension bakelite shaft in order to make it adjustable from the front panel.

The second detector cathode coil is a small bank-wound Litz wire coil of about 250 microhenrys inductance, of the type used for tuning over the broadcast range in a BCL receiver. Too much inductance will give too sudden or strong oscillation, while too little inductance will not provide oscil-

(Continued on page 34)

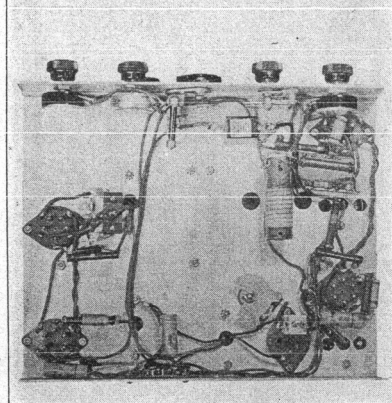
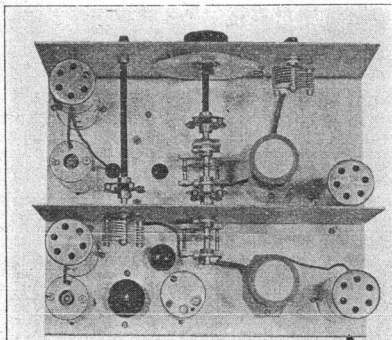

Above: Looking into the "Super Gainer".  
Below: Under-chassis view, showing placement of the regeneration coil.

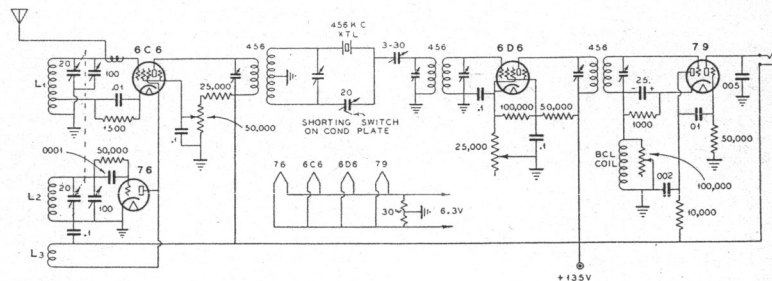

Complete Circuit Diagram of the "Super Gainer" with Crystal Filter

## COIL DATA

1/2 in. Diameter Forms Used Throughout

Wavelength	L1—Detector	L2—Oscillator	L3—Tickler
160 Meters	1 3/4-in. of No. 24E. tapped at 1/2 turns. Closewound.	1 1/4-in. of No. 24 E. Closewound. Grid on top end.	12 turns No. 24 E. Closewound 1/8-in. from L2. Same direction as L2 with plate on far end.
80 Meters	40 turns No. 20 DSC, spaced to cover 1 3/4-in. Tap at 3/4 turn.	33 turns No. 20 DSC, spaced to cover 1 3/4-in.	8 turns No. 24 E. Closewound 1/16-in. from L2.
40 Meters	12 turns No. 20 DSC, spaced to cover 1 1/2-in. Tap at 1/2 turn.	11 turns No. 20 DSC, spaced to cover 1 1/4-in.	5 turns No. 24 E. spaced 1/4-in. from L2.
Meters 20	5 turns No. 20 DSC, spaced to cover 7/8-in. Tap at 1/3 turn.	5 turns No. 20 DSC, spaced to cover 7/8-in.	3 turns No. 20 DSC spaced 1/4-in. from L2.
10 Meters	3 1/2 turns No. 20 DSC, spaced to cover 1-in. Tap at 1/3 turn.	3 1/2 turns No. 20 DSC, spaced to cover 1-in.	2 1/2 turns No. 20 DSC, 1/4-in. from L2 and spaced 1/16-in. between turns.



# A Low-Cost C. W. Transmitter

It Uses a 53 as Push-Pull Oscillator and a Pair of 10s in the Final

By HENRY WILLIAMS

● Much interest was created when it was stated in these pages that a 53 or 6A6 tube is ideal for use in a push-pull crystal oscillator circuit. The arrangement gives an output of 10 watts with 400 volts plate supply. However, the push-pull circuit shown as part of the diagram below is suitable only for one-band operation. In spite of this fact, an inexpensive, powerful CW transmitter can be built by using the 53 or 6A6 in the push-pull oscillator circuit as a driver for a pair of 210s in parallel or push-pull in a final amplifier circuit. Such a transmitter is here pictured and a complete circuit diagram is also shown.

It is sometimes advisable to use a double-spaced midget variable condenser for tuning the oscillator plate circuit. A standard two-section, 35 mmf. per section double-spaced midget is shown in the photo; the two condenser sections are connected in parallel, thus giving a total capacity of 70 mmf. Any value of from 50 mmf. to 70 mmf. is suitable. The oscillator plate coil is link coupled to the grid coil in the 210 stage. The grids of the 210s are driven with approximately 20 MA from the oscillator.

The neutralizing condenser in the 210 stage is a 35 mmf. double-spaced midget variable with both sections connected in parallel. Any other double-spaced condenser of from 50 mmf. to 70 mmf. can also be used. One of the new, inexpensive, wire-wound low-loss tank coils is used in the final plate circuit. The antenna can be coupled to the final plate coil in any conventional manner.

The final amplifier can first be built to operate with only one type '10 tube. When only one tube is used, the grid resistor should have a value of 10,000 ohms; when two tubes are used the grid resistor should have a value of only 5,000 ohms. Other values remain as shown in diagram. The oscillator can be keyed if 90 volts of battery bias is used on the 210 stage. A bias battery eliminator can also be used. The 210 amplifier can be keyed by plugging the key into the jack in the filament center-tap circuit.

A single 7½ volt filament transformer is adequate both for the oscillator and amplifier tubes if a 6A6 (6.3 volt equivalent of the 53) is used in the oscillator. A 1-ohm, 10 watt resistor is connected in series with one of the 6A6 heater leads and the 7½ volt filament winding, as shown in the circuit diagram.

Two type 5Z3 tubes, with plates connected in parallel, are entirely suitable for use in the high voltage rectifier circuit. Only one power supply is required for the entire transmitter, thereby making this a most economical medium-power CW job.

Conventional 8 mfd. electrolytic condensers are used in the power supply filter and .5 megohm (500,000 ohm), 1 watt rating, resistors are connected across these condensers in order to equally distribute the load on each condenser, thereby avoiding breakdown. The 5,000 ohm, 50 watt resistor in the lead to the oscillator plate coil should be equipped with a slider. Approximately 400 volts should be supplied to the oscillator plate.

Condenser C2 should be of the mica type, 2500 volt rating. All other fixed condensers shown in the circuit diagram should also be of the mica type, 1000 volt rating.

(Continued on page 15)

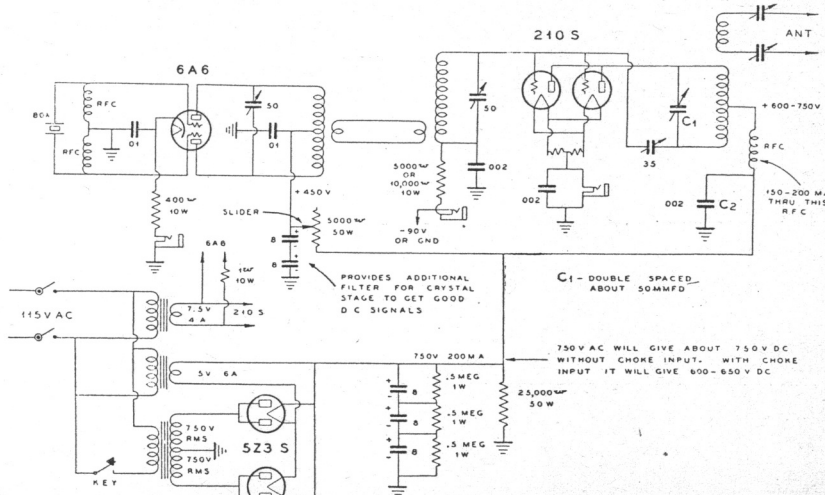
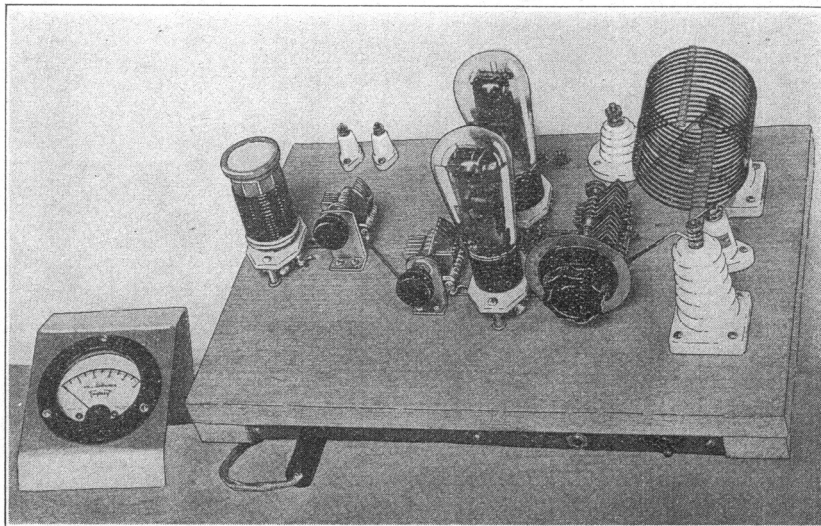
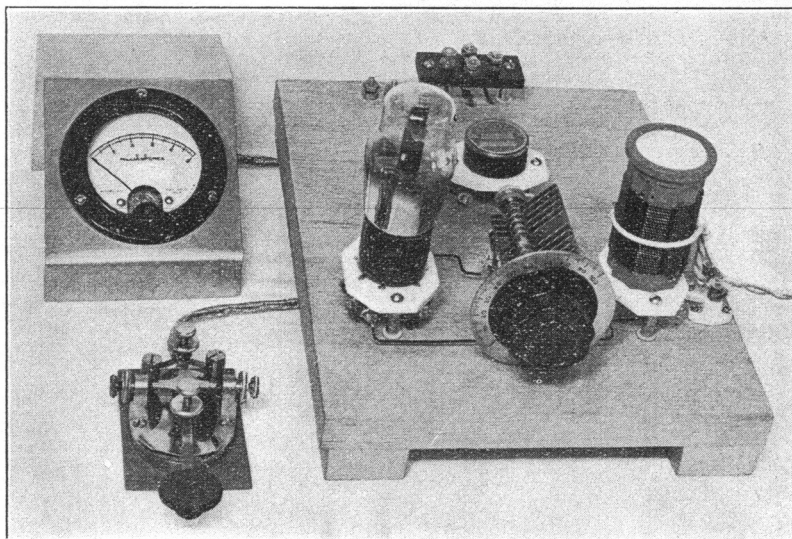

Photographs of the 53 Push-Pull Oscillator and 210 Parallel Amplifier. The lower illustration shows the complete circuit diagram.

# The 20-Meter Problem

... And Some Timely Suggestions for Getting the Most Out of Your 14 MC Transmitter. Neutralization, Excitation, Antenna Coupling and the Choice of Tubes Are Herein Treated in an Understandable Manner.

By FRANK C. JONES

● The 20-meter transmitter here shown will put out 150 watts at 2000 volts plate supply without overloading the 50T tube used in the final amplifier. By running the plate current a little higher than its recommended value of 100 MA, over 200 watts output can be obtained. The 150T will stand 3000 volts, but in the transmitter shown not sufficient grid excitation is available unless more than 750 volts is used on the buffer stage.

Most amateurs experience trouble in obtaining satisfactory operation on 20 meters, especially for phone operation when plate modulation is used. Grid modulation is usually easier to handle on 20 meters than plate modulation, because there is usually a lack of grid excitation for the latter type. The transmitter here shown has sufficient grid excitation to operate satisfactorily with plate modulation for phone with from 1500 to 2000 volts on the final amplifier. It was primarily designed for CW. More shielding between stages is necessary for good phone operation.

A 6A6 tube is used as a 40-meter crystal oscillator and doubler to 20 meters. The 6A6 drives a '10 or 801 buffer stage, using capacity coupling. The 801 is link coupled to a 50T final amplifier stage. An 800 or a

211H, or even a 211 could be used in place of the 50T if the proper plate and filament voltages are used. A 50T is apparently more difficult to drive than a 211D for the same output at medium wavelengths. A 50T has a maximum plate dissipation of 50 watts as against 100 watts for a 211D; therefore the 50T must operate at higher efficiency in order to obtain the same output. Any tube which operates into a high load impedance with high plate voltage requires more grid excitation, unless its mutual conductance is extremely high. A tube operating into a moderate load impedance with moderate plate voltage requires less grid excitation.

The 50T has very low inter-electrode capacities; therefore it is very efficient at 10 and 20 meters, whereas a 211 tube drops off rapidly in efficiency at these high frequencies. At 20 meters, the required grid excitation is about equal for phone operation, but the low C tube is easier to neutralize, an important feature if phone operation is desired. This applies especially to final amplifiers using a single tube on 20 meters.

The 801 tube with 750 volts at 100 MA

will drive the 50T at 2000 volts for CW, or 1500 volts on phone, with a good margin of safety of grid excitation, as checked on an oscilloscope. Short leads and low-loss coil forms and condensers are absolutely necessary if sufficient output is to be obtained from the 801. The latter is slightly more efficient than a '10, which can only be operated with a dull red color on the plate under load at 20 meters; the 801, on the other hand, will operate without color on the plate.

The 801 (or 210) buffer stage is driven by a 6A6 working at 450 volts plate supply, 25 volts of which is lost in the cathode resistor. Between 75 and 100 MA RF will pass through the 40 meter crystal, consequently a special-cut, low temperature coefficient crystal should preferably be used. An X cut crystal will stand this load if the 6A6 tube is keyed for CW in the cathode circuit. As shown in the circuit diagram, sufficient C battery bias must be used to allow plate current cut-off on the buffer and final stages when the crystal stage is keyed. At 1000 or 1200 volts on the final, 90 volts fixed C bias is sufficient. At 1500 volts, 135 volts bias is sufficient. The remaining grid bias is obtained by means of grid-leaks.

The plate voltage on the crystal stage is obtained by means of a 5000 ohm 40-watt resistor in series with the 750 volt supply in order to eliminate the need for an extra power supply. For phone operation a more desirable arrangement would be a separate 350 volt plate supply working into a 6A6 or 53 oscillator-doubler and 45 tube buffer stage enclosed in a ventilated metal shield can. The 45 stage could be capacitively or link coupled into the 801 stage. If 2500 or 3000 volt plate supply is used on the final stage, the 801 buffer will not provide sufficient power, and an 800 or an additional 50T would be required, with at least 1000 or 1200 volts plate supply. The buffer stage does not have to be operated at twice cut-off, and it can be used with only a little more than cut-off bias if the plate current is not too high. For plate modulated phone operation the final stage must be operated with at least twice cut-off bias and with upwards of 20 MA of DC grid current. The oscilloscope shows very little difference in a completely modulated carrier when the grid current is increased from 20 to 30 MA, as long as the actual total grid bias is at least twice cut-off.

20 MA through 10,000 ohms equals 200 volts, plus a fixed bias of 100 volts gives a total of 300 volts when the 50T is operating at 1500 volts plate supply for phone use. Twice cut-off at 1500 volts would be

1500  
 $\times 2 = 270$  volts, where the actual mu of the tube is 11.

For phone use, the antenna load does not have to be reduced as much from CW operation as when a 211D tube is used. The plate impedance under normal operating conditions for these two tubes is quite different, being several times as high with the low C tube. This means that less C is needed in a tank circuit in order to maintain a Q of 10, for example, in the final tank circuit. Apparently the shift from CW to phone is more nearly an identical antenna load because the C of the tuned circuit is about the same

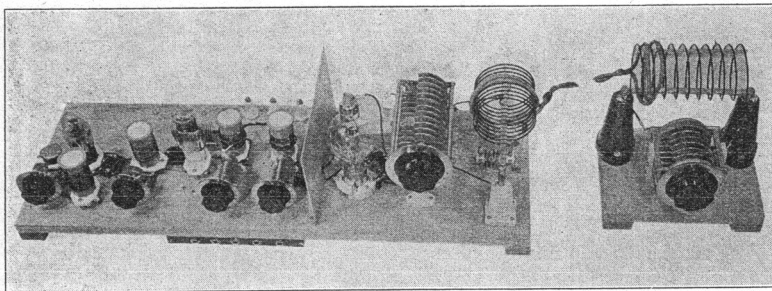

The complete 150 Watt CW 20-Meter Transmitter and Antenna Coupler. The circuit diagram is shown below. A 40-meter crystal is used in the Jones Exciter Unit, capacitively coupled to an 801 buffer which drives the 50T in the final amplifier.

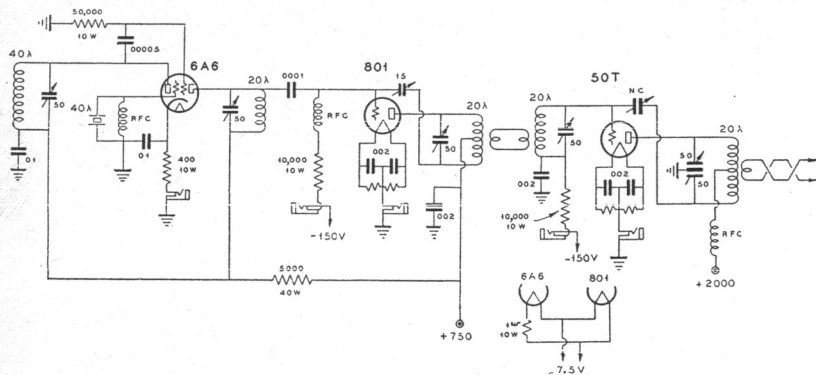

FIG. 1

## COIL DATA

Final Plate Tank	Final Grid Coil	Buffer Plate	Doubler	Osc.
10 turns No. 10 E. 3 1/2-in. diam. 3-in. long. C.T.	11 turns No. 16 E. 1 1/2-in. dia. 1 3/8-in. long.	11 turns No. 16 E. 1 1/2-in. dia. 1 3/8-in. long. C.T.	9 turns No. 16 E. 1 1/2-in. dia. 1 3/8-in. long.	20 turns No. 18 E. 1 1/2-in. dia. 1 3/8-in. long.



for both tubes. The 211D can be loaded more heavily for CW operation, although with less efficiency.

In this transmitter, or in any other transmitter, care should be taken to properly transfer the power into each succeeding stage, otherwise the output from the final stage will be low. The coupling link must be so adjusted that maximum grid current is obtained in the driven stage. In the case of the transmitter here shown the grid current ran at 30 MA under no plate voltage condition, and 20 MA with normal output into an antenna. Insufficient link coupling reduces this current and draws less than 100 MA from the 801 stage. Excessive coupling runs the current up to 140 or 150 MA, and also drops the grid current slightly.

If capacity coupling is used between stages as shown, the grid coupling condensers should have sufficient capacity to provide a normal load on the preceding tube with maximum grid current. Lower frequencies, such as 3500 KC, require a .00025 grid condenser between the doubler circuit and the 801 grid for the same loading effect on the 6A6. If a low impedance tube, such as a 6A6 or 53 in a doubler plate circuit is used, capacity coupling can be used into a buffer stage with nearly as much grid drive as when link coupling is used . . . provided a high or medium grid impedance load is offered. A low or medium mu tube offers a higher grid impedance load than does a high mu tube such as a 203A or 46. Capacity coupling between the 801 and 50T, both medium mu tubes, gives only a little more than half as much grid current as is obtained when link coupling is used. These important points should be remembered when a transmitter is to be put into operation on 10 or 20 meters, because the margin of available grid excitation is much less than on 40 or 80 meters. Probably 90 per cent of the trouble with 20 meter transmitters is lack of sufficient grid excitation on one or more stages.

The transmitter here shown, with 130 watts carrier, will modulate satisfactorily to over 90 per cent without apparent distortion, as viewed in an oscilloscope. It showed a slight regenerative curvature at values approaching 100 per cent, due to lack of sufficient shielding between stages. The set was designed for 150 watts output CW, and the modulation tests were made only for the purpose of studying the effect of various amounts of grid excitation. CW excitation requirements are less important, because the plate voltage supply is not doubling in value. Too-little excitation will result in excessive tube heating and low output for a given plate input; thus it is better to use plenty of grid excitation even for CW.

Neutralizing on 20 meters is no more difficult than on 40 or 80, if a certain amount of shielding is used between grid and plate circuits (not between link coupled circuits), and if short leads are used. High C tubes unbalance the split tank circuits and push-pull operation on 20 meters is highly desirable. With low C tubes, such as a 50T, the unbalance is slight and a single tube of this type can be used even on 10 meters. Each side of the filament should be by-passed with a .002 mfd. condenser to its particular RF stage ground-bus in order to provide low impedance paths for neutralizing purposes. Too-low C in the final tank circuit makes neutralization difficult, and does not give any more output on the fundamental frequency.

The final amplifier is coupled to an antenna tuned tank circuit by means of a one or two turn link circuit, as shown in the photograph on page 12. This system does not cause unbalance to the split-stator tank circuit; it also keeps the antenna feeders away from the set, with the result that "hot" stray RF need not be reckoned with. Fig. 2a shows the proper

method for use with an end-fed half or full wave antenna of the Fuchs type, or a single-wire-fed Hertz. The single-wire-fed Hertz, having a feeder impedance of 500 or 600 ohms, should be tapped down about half or two-thirds of the coil turns towards the grounded end. A Fuchs antenna, having an end impedance of possibly 2000 ohms or more, should connect either to the end, or down a little on the antenna coil. This antenna coil should be similar to the final amplifier coil, but with fewer turns, usually 2 less turns for 20 meter operation.

For use with a 2-wire matched impedance fed antenna, the system shown in Fig. 2b

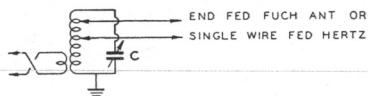

FIG. 2A

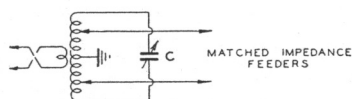

FIG. 2B

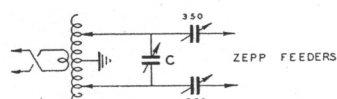

FIG. 2C

C = 50 MMFD - 6500V

can be used. The coil is grounded at its center and the feeders tap on about half-way out toward the coil ends.

For a Zepp antenna, Fig. 2c can be used. 350 mfd. well-spaced receiving condensers are used to tune together with the shunt condenser. The number of coil turns for this system will depend, to quite an extent, on how near to some multiple of odd quarter wave lengths the antenna feeders are. The same circuit can be used for a center-fed Zepp, and in both cases the link coupled coil should have from 2 to 5 turns around the antenna coil. In the other cases, usually 2 or 3 turns is sufficient, and this twisted pair can be connected across 2 or 3 turns near the grounded part of the coil instead of using a separate coupling coil. For most purposes, rubber covered No. 14 or No. 12 flexible wire can be twisted together as a feeder between coils for powers up to 1 KW.

If a twisted pair feeder is used to the transmitting antenna, a few turns (2 or 3) of this feeder around the amplifier tank coil center is suitable for coupling. Too low C in this tank circuit should then be avoided.

### Parasitics

● A parasitic oscillation is a spurious oscillation which takes place in a circuit at some frequency other than the normal tuned frequency. Parasitics can cause a poor CW note, additional radiated carriers, instability, loss of efficiency, voltage flashover or failure of tubes. The method of eliminating these is by de-tuning and damping. The connecting leads from the vacuum tube to the coils and condensers usually form an ultra-high frequency resonant circuit, and the grid and plate leads may form a tuned-grid-tuned-plate oscillator circuit. Detuning can be accomplished by making the grid leads longer or shorter than the plate leads, or by using a few turns of wire in the form of a small coil in series with the grid leads at the tube socket terminals.

Parallel, push-pull or single tube circuits are all subject to this effect. A small neon

lamp is sometimes useful in locating this form of oscillation, or a study can be made by the use of plate and grid current meters, with and without RF grid excitation. An all-wave receiver is also useful in locating parasitics, care being taken to see that receiver "images" do not mislead one into spotting false parasitics.

The secondary emission from the grid of a large tube can cause a dynatron oscillation in the grid circuit when the positive grid potential is high, consequently the grid circuit leads are of importance. When looking for possible ultra-short wave resonant circuits, the tuning condenser may act like an inductance at these frequencies and the coils may act as a low capacity condenser, like any RF choke at frequencies above its natural period. If the plate or grid leads are not more than an inch or so long, these parasitic troubles are seldom encountered.

Other circuits within circuits can be of the Colpitts or Hartley type, with inductive feedback between the grid and plate portions of the circuits. Another is of the Barkhausen type, where the grids are positive and the plate voltage is removed, or is at zero value. In push-pull circuits, the leads to the neutralizing condensers can form inductances which cause high-frequency oscillation, un-neutralizable. In general, it is best to make the grid-to-grid or grid-to-filament circuit as short as possible, via the grid tuning condenser. This condenser should be mounted as close to the tube or tubes as possible in order to detune the ultra-high frequency parasitic circuits to a higher frequency than that of the plate circuits.

Radio-frequency chokes in grid and plate circuits should have widely different values of inductance in order to prevent a long wave parasitic oscillation. If a non-inductive grid leak is connected in series with the grid RF choke, this trouble does not occur. Shunt feed RF chokes may cause trouble from complex resonance conditions; therefore, series feed is always desirable.

In Class B audio modulators, a radio-frequency oscillation can take place, but it can be eliminated by connecting 20 to 40 ohm, 10 watt, resistors in series with the plate leads, by-passing the grids to filaments with small RF condensers of .00025 to .001 mfd. sizes, and loading the input Class B transformer with 10,000 to 20,000 ohms across each side to center-tap.

Screen grid tubes may oscillate from a tuned-grid-tuned-plate high-frequency circuit, caused by the connecting leads and by-pass condensers in the control grid and screen grid circuits. A grid resistor or a small 6 or 8 turn coil will cure this difficulty. Even crystal oscillators suffer from this trouble if the grid lead to a crystal holder is too long.

The use of short grid leads, plus a short path through a tuning condenser, is always desirable. It may be necessary to add a small parasitic choke inductance next to the plate in order to cause detuning for parasitics. Link coupling between stages is desirable from this standpoint.

### NEW BOOKS

"Modern Radio Servicing" — By Alfred A. Gbirardi.

● This 1300-page book covers every phase of radio servicing, from actual repairing to advertising and selling radio service. It is a textbook written in a simple style, with practically no mathematics, for the purpose of teaching radio servicing. The use and construction of modern radio service equipment is fully covered. This book sells for \$4.00 and is published by the Radio and Technical Publishing Co., 45 Astor Place, New York City. As a supplement to this book, a manual selling for \$1.50, written by A. H. Gbirardi and B. M. Freed, is of value to the service man in his daily work. It lists much specific data on all makes of broadcast receivers and many remedies for troubles encountered in the field. This supplement has 240 pages of a size which can be carried in a coat pocket or tool kit.

# What the Oscilloscope Saw When Checking a High-Power Plate Modulator

By FRANK C. JONES

• This modulator and speech amplifier is capable of putting out over 200 watts of audio power which will modulate between 400 and 500 watts input to a Class C RF stage. It uses a Class B modulator system with a pair of 838 tubes. The latter will put out over 250 watts, if matched properly and if sufficient plate voltage is used.

The speech amplifier consists of a 57 high gain pentode amplifier resistance coupled into a 56 audio stage. The latter drives a pair of 45s into Class AB region in order to obtain sufficient drive for the 838 tubes. The 838s are relatively easy to drive, and a pair of 45 tubes in Class A-Prime will therefore serve as drivers. The 45 tubes will give nearly as much audio output as a pair of 2A3s and they are less difficult to match in a pair for push-pull operation.

The entire unit is built on a 30-in. x 11-in. x 1-in. oak baseboard, with the low voltage power supply at one end and the speech input amplifier at the other end. Only enough gain is used to allow close talking with a crystal diaphragm type microphone, and even then some hum is noticeable in the input at full gain setting. The input terminals, grid leak, mike lead and 57 tube must all be shielded, and the shielding must be grounded in order to prevent excessive hum pick-up. The low voltage power supply could be placed near the Class B output transformer, as shown, without hum pick-up. This output transformer has primary and secondary taps so that it can be varied in order to match the 838 Class B tubes to the particular Class C stage load used. This transformer must handle over 200 watts of power and it is therefore quite large, physically. The Class C stage plate current can be run through the secondary without core saturation difficulties when this large transformer is used. If the Class C stage plate current is over 200 MA it would be good practice to use a 4 mfd. H.V. condenser coupled into a 30 henry heavy-duty choke in order to keep the DC out of the Class B transformer.

The Class B input transformer must be designed for working between push-pull 45 tubes into Class B 838 tubes which have a low grid impedance. These operate at zero bias, and the 45s are in push-pull, therefore the transformer is not very critical, and a step-down ratio of about  $2\frac{1}{2}$ -to-1 of total primary to half secondary is satisfactory. Actual tests with other ratios indicated that this value was not very critical. The secondary was loaded with a pair of resistors and condensers in order to prevent Class B oscillation or parasitics. A pair of 40 ohm, 10 or 20 watt resistors in series with the plate leads are sometimes necessary for this same purpose. The audio transformer between the 56 and 45 tubes is one designed for driving a Class A-Prime stage and has a slight step-down ratio.

The unit here shown was used to modulate a breadboard transmitter using a pair of 211D tubes in the final stage. This transmitter had been used for CW transmission with a half KW output. As a phone transmitter, the plate voltage was dropped to 1100 volts and less antenna coupling was used. Many interesting difficulties were traced down with the use of an oscillograph. After these tests were completed, no wonder can be expressed as to the overmodulation, non linearity output of most amateur phone stations.

In the first place, an abundance of grid excitation is needed on the grids of the Class C stage, a condition which is easily accomplished on 80 meters, but difficult to accomplish on 20 meters. At least twice as much grid excitation is needed for phone operation as for CW, because on modulation peaks the plate voltage reaches twice normal, in this case 2200 volts.

The tank circuit on the final stage must have a certain amount of C to L ratio in

The original power supply gave 1200 volts, which was used for both the 838 and 211D stages. Tests on steady tone with an oscillograph caused a total drain of over 600 MA which necessitated a new and larger power transformer in short order. The 866 tubes stood up, but they were greatly overloaded. As this was usual amateur practice, tests were continued. The Class B stage fed from the choke input section of filter and the RF stage was isolated by a second section of filter. With this arrangement it was found that the trapezoidal figure on the oscillograph would not come to a point unless the Class B

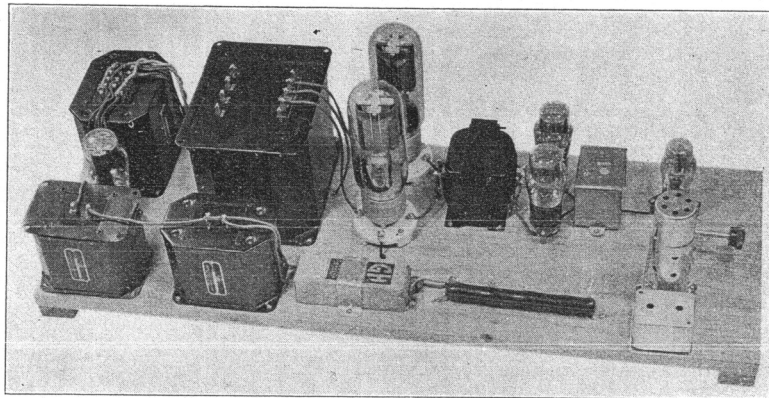

High-Power Modulator Using RCA-838 Tubes in Final Stage.

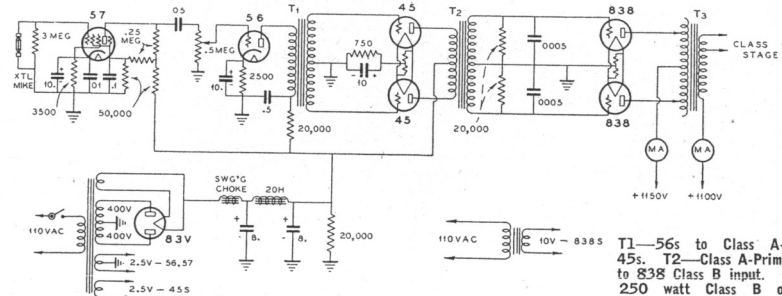

Complete Circuit Diagram of the 838 Modulator for Crystal Mike Operation.

order to obtain the best load for the Class C stage. Too low C means that for a given antenna coupling, the Q of the circuit will be too low for phone operation. In this case, push-pull final stage, the split-stator condenser required a capacity of more than 50 mmfd. for operation on 80, and more than 100 mmfd. at 160 meters. The original condenser had a maximum usable capacity of 40 mmfd. with the two sections in series, and it was found that the final stage could not be loaded-up to much more than 275 MA at 1100 volts before the oscillograph picture showed lack of modulation depth. The value of condenser required will vary with the plate voltage and plate current, in that a higher plate voltage or lower current calls for less tuning capacity. A certain fly-wheel effect is necessary in this tank circuit under conditions of modulation, because this tuned circuit supplies the power to the antenna over the entire RF cycle while the tubes, in Class C, only work a small fraction of each cycle. This also applies to CW, but to only about one-half in effect.

stage filter section condenser was increased from 2 up to 6 mfd.

Apparently this greater capacity was needed in order to prevent poor power supply regulation on modulation peaks from affecting the Class C stage. The Class B stage at no input drew 100 MA, and 300 MA with the 500 cycle tone input for 100 per cent modulation. The Class B stage has an appreciable effect on the common power supply when operating, even though the DC milliammeters and the DC plate voltage on the Class C stage are constant.

By far the best arrangement is to use a separate power supply for the modulator and for the modulated stage. This means two smaller power transformers, smaller swinging choke or chokes, and about the same total filter condenser capacities. Two half-KW power transformers are usually as cheap as a 1 KW unit. 250 MA chokes are much cheaper than 500 MA chokes of the same effective inductance. The two power supplies enable the use of 866 rectifiers instead



of 872s, if more than a few hours operation is desired.

The antenna load must be non-reactive; that is, the plate tank circuit must be tuned exactly to resonance, or the oscillograph will indicate one side modulated more than the other side of the carrier. In general, this antenna load cannot be over one-half as great as for CW operation with plate modulation. In general, a 500-watt CW transmitter will only allow a 250 watt carrier if correct operation is to be obtained, as viewed on an oscilloscope. The latter is a necessary instrument for every phone station and should be used both on sine wave 500 cycle oscillator input tests and on speech as an over-modulation indicator. A carrier shift indicator using a diode tube and milliammeter is suitable for over-modulation indication only after the transmitter has been properly adjusted by means of an oscilloscope.

The 211D RF tubes were rewired for parallel operation as a test. The output was about the same, but more C was needed in the tank circuit in order to obtain linearity. Exact neutralization was difficult, and this is extremely important for phone operation. On 20 meters, neutralization and proper loading were very difficult for parallel operation, except at reduced input. Push-pull operation seems to be desirable for phone operation if more than one tube is needed in the final stage.

Fixed bias only on the modulated stage prevented obtaining 100 per cent linear modulation. Grid leak only gave a good figure, but a combination of the two was slightly better. Grid leak bias is rather critical, depending upon the RF grid excitation available and the age of the 211 tubes. A pair of

new tubes required about twice as high a value as a pair that had been aged a few days in a CW transmitter. The plate current in both sets of tubes was approximately the same for the same output. The value of grid leak seemed to vary between 5,000 and 15,000 ohms with 10,000 as a good average for a pair of 211Ds. 5,000 gave more carrier as for CW operation, but the peak output was not as great as with 10,000 ohms, which meant less than 100 per cent modulation. In all of these tests over-modulation could be obtained by running-up the Class B modulator output, but either the peaks or troughs of modulation on the oscilloscope screen showed over-modulation before it normally should. A trapezoid figure is an especially easy means for detecting adjustment flaws when using a sine wave audio oscillator input.

Another source of trouble was due to insufficient shielding between stages. This allowed direct capacitive coupling to the pick-up coil in the final tank circuit, with a result that a steady small carrier was indicated even when no power was impressed on the final stage. This would prevent obtaining "100 per cent modulation", as viewed on the screen, until actually far beyond 100 per cent, unless the driver stage was modulated by reaction back from the final modulated stage. The latter effect can be checked by moving the oscilloscope pick-up coil back to the buffer stage tank circuit. In bad cases, even the crystal oscillator stage may be affected, which would result in frequency modulation. A plate modulated phone transmitter should employ complete shielding of all driver stages from the final tank circuit or antenna leads.

Especially on 20 meters, RF feedback from

an antenna or unbalanced antenna feeder will cause non-linearity by getting back into some low powered stage or into the speech amplifier. These effects are all difficult to find or analyze by ear or meter tests, but they certainly show up on oscilloscope tests. The average amateur phone station is usually always incorrectly adjusted or overmodulated, even if only 60 per cent modulated. A well-adjusted phone will allow peak modulation up to 100 per cent. For voice modulation, the milliammeter in the Class B stage should only kick-up to about one-half as much as for 500 cycle sine wave input. The average power energy in a speech tone is only half as great as for a sine wave tone for the same peak values of voltage. The peak values are the ones that should reach 100 per cent modulation, not the average values. If the Class B meter shows as much kick-up on speech as on a steady pure tone 100 per cent modulation, overmodulation is very severe.

If one wishes to blast the speech input to a phone transmitter in order to raise a DX station through QRM or QRN, the best bet seems to be controlled carrier. Here one can blast a linear RF amplifier without having to overmodulate the Class C stage with its attendant local QRM and poor quality.

In spite of popular acclaim, a plate modulated phone is not easy to adjust if anything more than mere intelligibility is desired. For correct operation, grid bias, suppressor grid, or plate modulation are about equal for ease of adjustment. Controlled carrier is slightly more difficult to adjust, because a RF linear amplifier is generally needed to derive the full benefits of the system.

## Standard Frequency Service

(Continued from page 7)

frequency. The radiated power will be only one kilowatt; reception is therefore not as reliable as for the CW emissions of Tuesdays and Fridays; it is hoped to increase the power later. The modulated emissions are somewhat experimental, and for this reason an audio frequency other than 1,000 cycles per second may be used on some occasions. The presence of the audio modulation frequency does not impair the use of the carrier frequency as a standard to the same high accuracy as in the CW emissions.

The accuracy of the frequencies as sent out from the transmitting station will be at all times better than a part in five million. Transmission effects in the medium (Doppler effect, fading, etc.) at times may result in slight fluctuations in the frequency as received at a particular place. However, these will practically never impair the reception of the carrier frequency to the accuracy stated. Under some conditions, momentary fluctuations as great as 1 cycle per second may occur in the modulation frequency. It will generally be found possible, however, to use the modulation frequency with an accuracy better than a part in a million by selecting that one of the three carrier frequencies which has the least fading. The use of automatic volume control on the audio frequency will be found helpful.

Information on how to receive and utilize the standard frequency service is given in a pamphlet obtainable on request addressed to the National Bureau of Standards, Washington, D. C. From any single frequency, using harmonic methods, any frequency may be checked.

● The Beaver Valley Amateur Radio Club will hold its fourth annual banquet and hamfest at 6 P.M., on Saturday, October 26, in the Grill Room of the Woodlawn Hotel, Aliquippa, Penna.



# Important Announcement

Extensive experiments conducted in the laboratory of "RADIO" by our Engineering Editor, Frank C. Jones, brought to light a most interesting new theory regarding the amount of grid drive power required for operation of circuits in which single-section or split-stator condensers are used. These unusual findings will be told to you in November "RADIO", an ace-high issue, containing more exclusive technical information than has yet been published in any issue of the magazine. The new grid-excitation theory should prompt almost every radio amateur to rebuild his r.f. amplifier. You will be told how to get twice as much grid drive from the same buffer stage . . . enabling you to build a more efficient transmitter for less money. In the November issue you will also find an engineering article on how to design the finest inexpensive class B amplifier. Three other surprises also await you.

## Low-Cost Transmitter

(Continued from page 11)

For 40 meter operation the final plate coil should be 2 $\frac{3}{4}$ -in. diameter, with 16 turns of No. 14 enameled wire, space wound, 6 turns to the inch. The 80 meter final plate coil should have 34 turns of No. 14 enameled wire, 2 $\frac{3}{4}$ -in. diameter, 9 turns to the inch.

The oscillator plate coil for 40 meter operation has 20 turns of No. 18 enameled wire, slightly space wound, on a standard 1 $\frac{1}{2}$ -in. diameter plug-in coil form. The 80 meter coil has 33 turns of No. 18 DSC or DCC wire, close wound.

The grid coil for 40 meter operation has 22 turns of No. 18 enameled wire, slightly space-wound, on a 1 $\frac{1}{2}$ -in. diameter plug-in coil form. For 80 meter operation the grid coil has 33 turns of No. 18 DSC or DCC wire, close wound.

### Crolite Magicore

● The new Crolite Magicores offer possibilities for improving amateur receivers. These new metallic cores for RF and IF coils improve selectivity and gain over that obtainable with air-core coils. The units are made of a magnesium ferrous alloy, held by a crolite ceramic binder, or insulator. The units are  $\frac{1}{2}$ -in. long by  $\frac{3}{8}$ -in. diameter with a  $\frac{1}{8}$ -in. center hole and they have a smooth, hard-polished silver appearance. The material will not alter its characteristics, will not rust or corrode it is claimed, regardless of the length or kind of service.

Two of these units would be used in an IF transformer. Because of its permeability, less turns would be needed for a given frequency. Loose coupling would also be needed between the two coils.

The manufacturer claims an increase in "Q" of an air core high-frequency transformer from 95 to 150 by insertion of one of these Magicore coils. This means more gain and better selectivity. In another air core transformer, the band width of 20.6 KC was changed to 17.1 KC by simply substituting Magicores for the air cores. With specially designed coils even better results would be obtained.

\* Manufactured by Henry L. Crowley & Co., 1 Central Ave., West Orange, New Jersey.

# A Non-Directional Microphone

By R. N. MARSHALL  
Member Technical Staff, Bell Telephone Laboratories

● Since its introduction in 1931, the Western Electric moving coil microphone has solved many of the difficulties encountered in broadcasting, sound recording, and public address service. While this microphone was a decided advance over apparatus existing at the time of its introduction, extensive field experience during the past four or five years, and continued development studies have now made possible the production of a distinctly better instrument. While retaining all the good features of the previous, or 618A type, the new microphone has the added advantages of a more uniform frequency characteristic from 40 to 10,000 cycles, a considerably wider range than the 618A, and is essentially non-directional in its response. At the same time the microphone is smaller and lighter than the old, and thus of increased portability and convenience. It differs radically from previous microphones in appearance, consisting of a two and one-half inch spherical housing with a two and one-half inch acoustic screen held a fraction of an inch off the surface. The position of the microphone when in use is shown in the photograph at the head of this article.

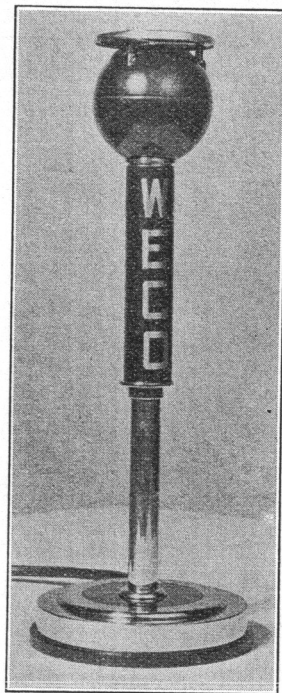

Not an ash-tray—but a new non-directional, high-quality microphone by Western Electric.

To build a microphone that will respond uniformly to sound pressures at its face is quite a different thing—and much simpler—than designing it to respond equally to sound coming from any direction. In general a sound field is disturbed by the presence of the microphone, and as a result the pressure at the face of the microphone will not be the same as it was before the microphone was placed in position. This change in pressure caused by the presence of the microphone is largely an effect of diffraction. It is limited to the higher frequencies, varies with the frequency, and is a function of the size and

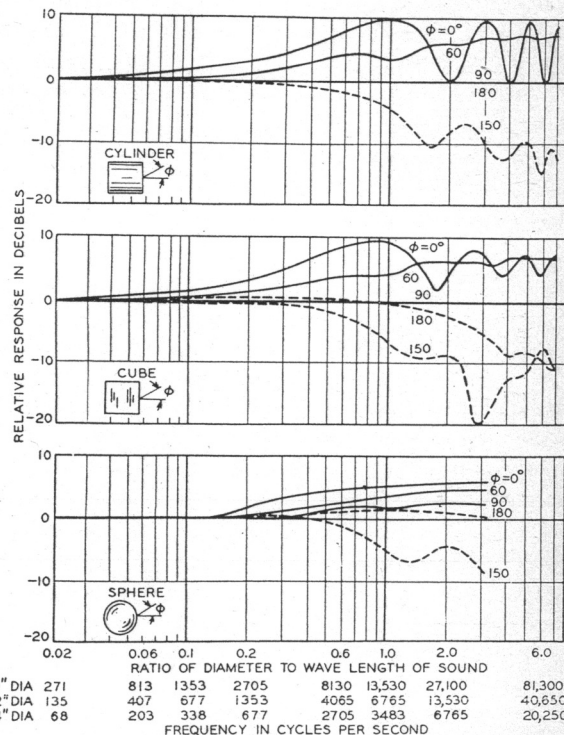

FIG. 3. Difference of response at the center of a sphere, a cube and a cylinder for sounds coming from different directions and at different frequencies.

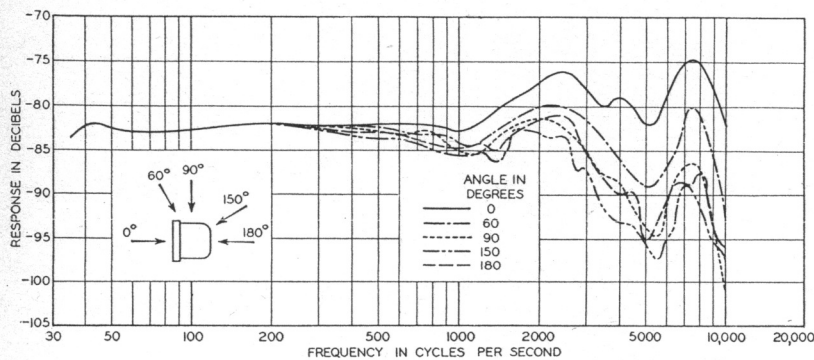

FIG. 1. Field response of the standard (not the new non-directional) moving coil microphone (No. 618A) over the frequency range from 40 to 10,000 cycles for five angles of incidence.

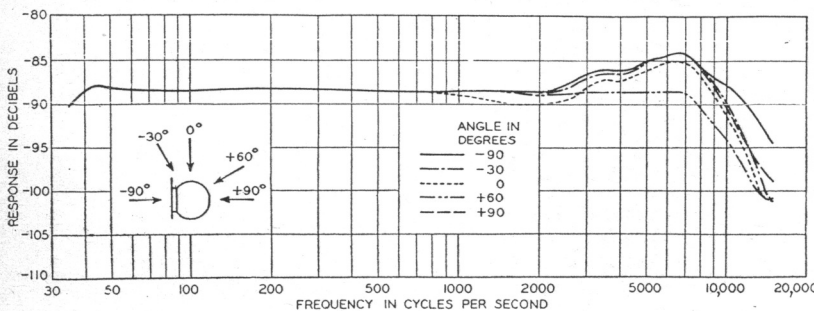

FIG. 2. Field response of the new "non-directional" Western Electric moving coil microphone for similar angles of incidence and for the same frequencies as in Fig. 1.

shape of the microphone and the direction from which the sound waves approach the microphone. Because of this, previous microphones have shown a marked directional effect, which not only varied with the angle of sound incidence, but for any one angle varied greatly with frequency.

This varying in response with direction and frequency results in a distortion of the output. In many cases—such as when used as a pick-up for large orchestras or choruses, or in sound picture studios—the sound reaching the microphone directly is only a small part of the total. The major part of the sound reaches the diaphragm only after one or more reflections from the walls of the room. As a result most of the sound arrives at the microphone from directions other than the normal one. If the response in these various directions differ, the output of the microphone will not truly represent the sound at the point of pick-up—and this, of course, is distortion. In the new microphone this directional distortion is so slight as to be imperceptible.

The directional effect for the 618A microphone is shown in Fig. 1 for five angles. At 10,000 cycles the difference in response between certain angles is 20 db, and at 5,000 cycles may be over 15 db. In the new microphone this variation has been greatly reduced, as shown in Fig. 2. At 10,000 cycles the maximum difference in response for any two directions is only about 5 db, which is imperceptible to the ear. Moreover the new microphone is designed to be mounted so that its diaphragm is horizontal, and thus its response is perfectly uniform for all horizontal angles. The very slight residual direc-



# With the Manufacturers

## Miller Pre-Selector

● For use ahead of a short wave receiver to raise weak DX signals, a high gain, two-stage radio frequency amplifier has been designed by engineers of the J. W. Miller Company 5917 S. Main street, Los Angeles.

The Model 302 pre-selector is available completely wired and housed in a metal cabinet with black crackle finish. There is also available a kit which includes antenna coil, RF coil, RF choke coil, switch and three dual trimmer condensers.

In addition to increasing signal strength, the Miller pre-selector reduces both atmospheric disturbances and tube noises.

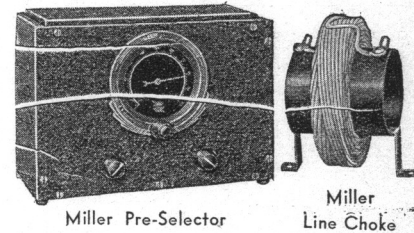

Miller Pre-Selector

Miller Line Choke

The chassis layout has provision for self-contained power supply, relieving the receiver from the extra load. Provision is also made to switch the antenna from the pre-selector to the receiver without disconnecting the antenna leads.

The coils are designed to cover the full range of the high frequency bands from 12 to 200 meters, and provision is made on the band switch to facilitate the incorporation of broadcast or long wave coils if desired. The last position on the switch in the "antenna through" position, in which the antenna is coupled directly to the receiver.

The Miller pre-selector cabinet measures 12-in. wide by 6 $\frac{3}{8}$ -in. deep by 8 $\frac{3}{4}$ -in. high. The lid is hinged for ready access to tubes, while louvers on sides and back provide ventilation.

List price of coil kit is \$8.00, and of metal cabinet, \$6.50. List prices on all parts, including three tubes, total approximately \$35.00.

## Miller Line Filter Choke

(See Illustration Above)

● Elimination of high frequency disturbances from power supply lines is accomplished by a new line filter choke developed by the J. W. Miller Company, 5917 S. Main Street, Los Angeles, for use with receivers, transmitters or any source of interference.

Duo-lateral wound for minimum distributed capacity, the newly designed choke is available in various sizes of 2, 5, 10 and 20-ampere carrying capacity.

Use of a duo-lateral wound choke makes a radio receiver more selective by by-passing the station signals picked up through the electric wiring. Used with a transmitter, the Miller line filter keeps the signal in the antenna and out of the AC line.

In general, the filter choke may be used for radio receivers, transmitters, vibrating and rotating machinery, mercury arc, mercury rectifiers and wherever it is desired to eliminate interference from either AC or DC supply lines.

List prices range from \$1.00 for 2-ampere type to \$4.00 for 20-ampere choke.

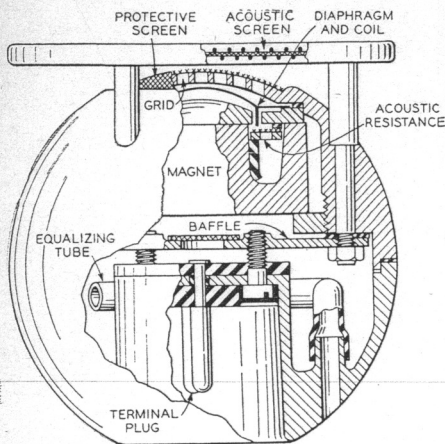

FIG. 4. Simplified cross sectional view of the Western Electric non-directional microphone.

tional effect exists only in the vertical plane. When it is used for picking-up addresses or other sounds arriving only in the horizontal plane, there is no directional distortion whatever.

This great improvement has been made possible by extensive study of the causes of the directional effect and the possible means of avoiding it. The directional effect is largely a function of the size of the microphone relative to the wave length of sound. It might be avoided, therefore, if the microphone could be made small enough, but calculations showed that to make the effect negligible at 10,000 cycles, the instrument would have to be approximately 1/2-in. in diameter. While a microphone of this size could have been built, its output would be considerably less than for the larger instruments, which is objectionable in a microphone designed for general broadcasting and sound picture use. The size of the new microphone was reduced, therefore, only to the point where a satisfactory output could still be obtained, and the remaining tendency to directional distortion was overcome in the design—chiefly by employing a spherical shape and by using the acoustic screen mounted post in front of the diaphragm.

Studies made in these laboratories clearly brought out the effect of the shape of the microphone on the directional response. This is indicated in Fig. 3, which shows the computed response at a point at the center of three different shaped objects of equal diameter with variation in frequency and direction of arrival. The abscissas are given as the ratio of the diameter of the object to the wavelength of the sound, but the table at the bottom indicates the corresponding frequencies for diameters of 1, 2, and 4 inches. It will be noticed that both the cylinder and cube result in a marked directional effect, made more serious by the wavy character of the response, while the variation in response for the sphere is much less and the waviness has practically disappeared.

With a spherical microphone mounted with the diaphragm horizontal, there would be a tendency for the response to be too high for high-frequency sounds coming down from above, that is directly toward the diaphragm, and too low for similar frequencies coming from angles very much below the horizontal. These effects have been almost completely avoided in the new microphone, and an essentially uniform response obtained from sound coming from all directions, by mounting an acoustic screen in front of the dia-

phragm. This screen was developed by F. F. Romanow, and is designed to produce a loss in sound passing through it, and to reflect back to the diaphragm sound coming from behind the microphone. It thus compensates for the unequal diffractive effects and makes the instrument non-directional in its response.

Besides these changes designed primarily to reduce the directional effects, extensive changes were made in the internal construction and arrangement of the microphone to even out the response curve and to extend its range. The general construction is shown in Fig. 4. In many of the earlier types of microphones, the cavity in front of the diaphragm introduced an undesirable resonance. In the new microphone this resonance is controlled by the design of the protective grid, which is that part of the outer shell directly in front of the diaphragm. Instead of being the source of undesirable distortion, the grid and cavity have become a valuable aid in improving the response of the instrument at very high frequencies. This grid also incorporates a screen to prevent dust and magnetic particles from collecting on the diaphragm.

The inherent loss due to the reduction in size is partially offset by making the diaphragm light in weight and of very low stiffness. It is very important that the diaphragm should vibrate as a simple piston throughout the entire range. To secure such action over a wide range of frequencies has proved in the past to be a very difficult problem. This problem has been solved quite satisfactorily in connection with the new microphone. No evidence of vibrating in other modes is shown by the diaphragm below 15,000 cycles.

The size and shape of the housing was selected with particular reference to the requirements that had to be met. The size is such that the housing fits closely over the diaphragm and thus produces little more diffractive effects than would the diaphragm itself, and the spherical form allows the maximum amount of air space behind the diaphragm, which is essential to minimize the impedance to vibration. To prevent resonance within the case, an acoustic-resistance baffle is provided to divide the space into two parts. A tube, with its outlet at the back of the housing, serves the double purpose of equalizing the inside and atmospheric pressures, and of increasing the response of the instrument at low frequencies.

The acoustic screen that compensates for the directional effects is mounted over the grid in front of the diaphragm, and is thus an additional protection for the diaphragm. This places it in a vulnerable position, however, but it is designed to withstand considerable shock and the acoustic screen itself is a separate unit and easily replaceable. The terminals of the microphone are provided in the form of a plug recessed in the housing behind the microphone unit. This arrangement provides protection for the terminals and conceals the connecting jack.

Thorough-going research and development studies have thus not only made it possible to provide a microphone that is smaller, more easily handled, and more attractive in appearance than previous types, but have extended the frequency range and reduced the directional effects to a point where they are imperceptible. Its convenient form and desirable characteristics make the new microphone suitable for practically any type of service.

# Oscilloscope Studies of Plate and Grid Modulation

Some Disclosures Which Should Prove Highly Interesting to the  
Phone Station Operator

By FRANK C. JONES

● Numerous theoretical articles have been published on the cathode-ray oscilloscope and its associated circuits, but there has been a lack of practical data on the results obtainable. The "scope" is a practical device for amateur use, especially if phone operation is contemplated. Some care should be exercised to prevent false readings, but these are relatively insignificant if the oscilloscope itself is functioning properly.

The uses of a cathode-ray oscilloscope in the laboratory are many and varied, and no attempt will be made to cover this field. An interesting comparison between grid and plate modulation is more easily adjusted for 20 meter operation, and plate modulation is easier adjusted on 80 and 160 meters, due to excitation problems. A correctly adjusted plate modulated phone presents a real problem, as can be easily verified by listening on the air. The more general use of an oscilloscope would certainly clear-up the air in the phone bands.

When two AC voltages of the same magnitude are impressed on the vertical and horizontal plates of the cathode-ray tube, the result will be as shown in one of the patterns of Fig. 1. These patterns are useful in determining phase shift in an audio amplifier system.

For checking audio amplifiers a sine wave audio oscillator should be used with its waveform shown on the vertical plates, using a saw-tooth oscillator to produce a sine wave picture on the end of the tube. The vertical plates can then be connected across the output of the amplifier through a suitable attenuator to compare the waveform for distortion. Class B amplifiers will sometimes show a high-frequency oscillation super-imposed on the main sine wave, sometimes at such a high frequency that it appears as a thickening of a portion of the sine wave figure. Circuit changes can be made while studying the figures and trouble shooting is thereby greatly simplified.

The intermediate frequency amplifier can be correctly aligned by means of a modulated test IF oscillator, an oscillograph and a sweep condenser, motor driven. This procedure shows a visual picture of each tuned circuit; it can therefore be used to obtain a broad-band IF amplifier for high fidelity receivers, or for obtaining a single sharp peak for amateur phone or CW receivers.

There are two methods of studying the modulation of a phone transmitter; one uses a sweep circuit oscillator giving solid sine wave envelopes, and the other uses a solid trapezoidal figure. Each has certain advantages, the former probably being best for voice tests. The trapezoid method requires very little equipment because a 60 cycle tone can be used on the horizontal plates as well as for the tone into the audio system or modulator. The vertical plates are connected to an RF pick-up coil which is coupled to the antenna or final tank circuit. With no modulation, the figure is a rectangle; at 100 per cent modulation the figure will be a triangle, provided the transmitter is cor-

rectly designed and adjusted. The percentage can be calculated by means of the formula shown in Fig. 2. The various patterns here shown will serve as a guide in analyzing transmitter troubles.

Two transmitters were tested, one a grid modulated set using a combination of cathode bias and fixed cut-off grid bias with four type

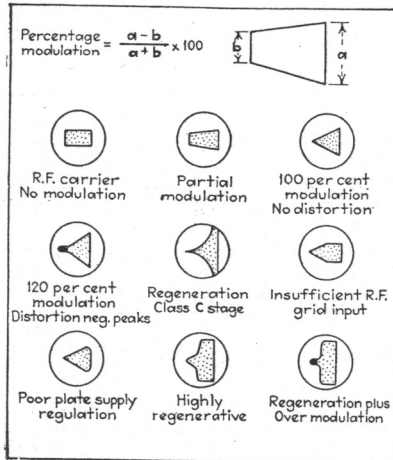

FIG. 2  
Oscilloscope chart, showing typical trapezoidal readings of a phone transmitter when sweep circuit is not used. —Courtesy "Electronics"

150T tubes in the final stage; the other was a plate modulated set with two 211 tubes modulated by a pair of 838 tubes in Class B.

Fig. 3 shows some of the figures obtained for different adjustments of the grid modulated set, using an RCA oscilloscope. The audio input was practically a pure sine wave as shown at about 400 cycles per second. These figures look fairly good, except when too much RF grid excitation is used. Detuning the final tank circuit shortens the modulated envelope on one side or the other.

Fig. 4 shows the same set using trapezoidal figures. Here undesirable modulation characteristics are more clearly shown than in the sine wave figures. Inability to modulate 100 per cent, linearly, is readily shown when grid current flows. To obtain a good figure, it is necessary to have a heavy antenna load, zero grid current and steady plate current, otherwise grid modulated phone patterns usually look like the figure noted as "typical heavy grid modulated phone." The grid current in the latter case ran up to a few milliamperes and the plate current at about 330 MA. Linear modulation was not obtained with more than 275 MA. Reducing grid RF excitation, rather than changing antenna load, is the proper way to vary the current. Too low a value of C in the final tank circuit will also cause non-linearity, and values as high (or higher) than needed for plate modulation, are necessary.

The plate modulated phone showed a need for rather light antenna load in order to obtain 100 per cent modulation in a linear form. Fig. 5 shows various degrees of modulation when using a sweep circuit oscillator. Fig. 6 shows the trapezoidal figures obtained under

various conditions. A common plate voltage supply was used for the modulator and Class C stage and at least 6 mfd. by-pass was needed from Class B output center-tap to ground in order to allow over 70 per cent modulation without excessive distortion. 2 mfd. was insufficient, even though the Class C stage was isolated by an additional section of filter. The oscilloscope was connected so as to include the characteristic of the speech amplifier, modulator and Class C stage. The actual antenna output for distortionless output was about one-half that obtained for CW output in this transmitter, one reason being that the value of C in the Class C stage was not as high as it should be. Using twice as much tuning capacity as for CW, the output would be improved, even though the circuit was no longer low C. Many amateur phones overmodulate, due to the use of low C in the final stage in an effort to obtain 100 per cent modulation at high efficiency.

Overmodulation can occur long before 100 per cent is reached, unless careful design and adjustment is made. An oscilloscope is a real necessity for phone in testing and adjusting. A linear rectifier and meter, or an overmodulation indicator of the diode tube type, can be used to indicate carrier shift or overmodulation as a constant monitoring device during normal operation.

The oscilloscope can be used in cases such as above to compare the input and output wave forms from speech amplifier to Class B stage, as a whole or any part. Insufficient by-pass across the Class B plate supply becomes easily apparent, as well as amplitude distortion in any stage. A frequency run can be made if a beat-frequency or variable frequency audio oscillator is available, although in most transmitters the amplitude distortion is far worse than frequency distortion. The exploring or pick-up coil connected to the vertical plates can be used to see how much modulation is "backing up" into the buffer and crystal oscillator stages. Lack of sufficient shielding or neutralization will show-up as a steady carrier in the output, as viewed on the oscilloscope screen. Under such conditions it is obviously impossible to obtain 100 per cent modulation as indicated by a point on the triangle. A check should therefore be made to see that this condition does not exist when the plate voltage is removed from the modulated stage.

An oscilloscope is easily affected by stray AC fields due to power transformers or filter chokes not being properly shielded, electromagnetically. This condition usually manifests itself in a curvature or eclipse of the straight line on the screen when an AC voltage is impressed on one set of plates. Stray RF fields from a relatively high power buffer stage will sometimes prevent the line from being thin on the screen when preparations are made to test a final amplifier stage. The best method is to use ample shielding in the transmitter, although in some cases shielded leads and a separate ground connection to the oscilloscope will allow the tests to be conducted.

Keying surges in CW transmitters or ripple on the carrier, due to insufficient power supply filter, can be studied on the oscilloscope. Fig. 8 shows some carrier screen pictures obtained with various filter combinations on the final stage. Crystal oscillator filter supply is usually important, although a meager buffer supply filter can sometimes be used if



the grid of the final amplifier is driven to saturation so as to prevent grid modulation or any possibility of linear RF amplification.

Keying surges are difficult to picture without the use of a fast camera because the clicks are in the form of transients which die away

rapidly. As viewed on the screen, violent peaks and irregularities occur in the otherwise-smooth carrier band when keying.

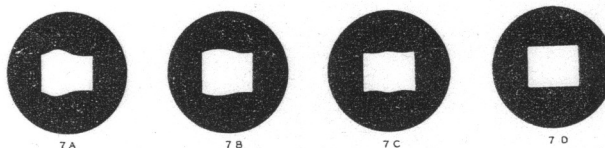
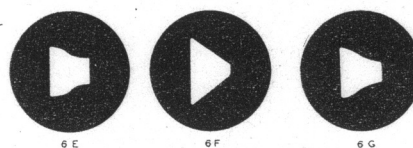
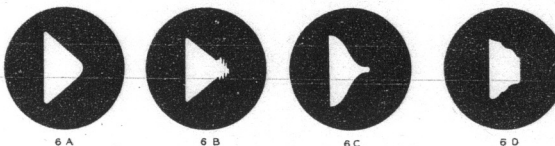
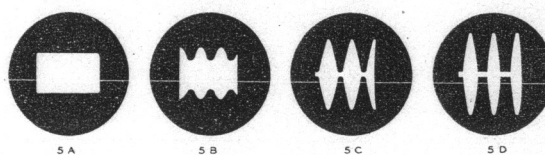
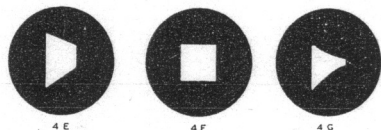
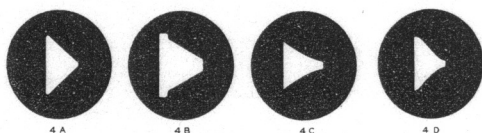
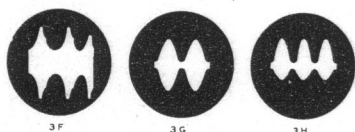
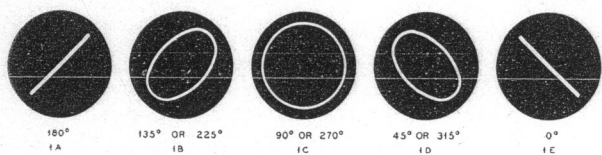

FIG. 1—Phase relation between two AC voltages in an audio amplifier system.  
 FIG. 3a—400 cycle audio waveform.  
 FIG. 3b—Grid Modulation—ideal condition.  
 FIG. 3c—Grid Modulation—over modulated.  
 FIG. 3d—Grid Modulation—with too much r.f. grid excitation.  
 FIG. 3e—Grid Modulation—partially modulated.  
 FIG. 3f—Grid Modulation—Final tank circuit detuned from resonance.  
 FIG. 3g—Grid Modulation—100% modulation.  
 FIG. 3h—Grid Modulation—Too much positive grid current.  
 FIG. 4a—Grid Modulation—Same adjustment as FIG. 3g.  
 FIG. 4b—Grid Modulation—Typical adjustment, heavily modulated with excessive r.f. excitation and output.

FIG. 4c—Grid Modulation—Same as 4b with no grid current when unmodulated.  
 FIG. 4d—Grid Modulation—R.F. excitation very low and overmodulated.  
 FIG. 4e—Grid Modulation—about 50% modulated.  
 FIG. 4f—Grid Modulation—Zero per cent modulation.  
 FIG. 4g—Grid Modulation—Same as FIG. 3f, plate tank detuned.  
 FIG. 5a—Plate Modulation—Carrier only.  
 FIG. 5b—Plate Modulation—Partially modulated.  
 FIG. 5c—Plate Modulation—100%.  
 FIG. 5d—Plate Modulation—Over modulated.  
 FIG. 6a—Plate Modulation—100%.  
 FIG. 6b—Plate Modulation—Best adjustment obtainable with insufficient Class B audio by-pass condenser (only 2 mfd).

FIG. 6c—Plate Modulation—Over modulated before reaching normal 100% condition.  
 FIG. 6d—Plate Modulation—Same as 6c at point of best modulation obtainable. Regeneration, lack of r.f. shielding, Class B trouble and too heavy antenna loading.  
 FIG. 6e—Plate Modulation—Maximum modulation with Class B greatly mismatched to Class C load.  
 FIG. 6f—Plate Modulation—Maximum modulation with too heavy antenna load.  
 FIG. 6g—Plate Modulation—With insufficient grid r.f. excitation.  
 FIG. 7a—CW carrier with one section filter on final stage and saturated choke.  
 FIG. 7b—CW carrier with one section using larger choke.  
 FIG. 7c—CW carrier with two section filter, both filter chokes too small.  
 FIG. 7d—CW carrier 2 section filter with large chokes.

## Reward Offered

● Since financial motives seem to be the only kind which Mr. Warner understands, it is perhaps only natural to find one of his underlings industriously trying to ascribe such a motive to Colonel Foster, who has battled long and hard against the Warner-Maxim-Segal combine.

We have before us a letter written by Mr. Clinton DeSoto, of ARRL Headquarters, to one Joseph Orlan, 8531-101st street, Richmond Hill, Long Island, New York. In this letter, Mr. DeSoto says:

*"After all, 'RADIO' is Foster's personal mouthpiece, largely owned and controlled by him; the same is not true of 'QST' as affecting the officers of the League . . ."*

Perhaps it is a tribute to the effectiveness of Colonel Foster's sincere and disinterested efforts

in behalf of Amateur Radio, that Headquarters has now been forced to the spreading of lies like this, particularly through the agency of a politician of the DeSoto type.

While we would be honored to number the Colonel among our stockholders, we wish categorically to deny that he is the holder of any of our stock, or that he is financially interested in "RADIO", or that he controls the policies of this magazine. His activities as Political Editor are carried on without pay.

One of the policies which "RADIO" will pursue to a successful conclusion, is to fight for the interests of the Licensed Amateurs in this country by urging them to take charge of their own League, and to oust those who would turn it into a mere publishing business, run largely for the benefit of "insiders" drawing large salaries, and mismanaging legislative affairs.

If there be "surplus-snatchers" outside of West Hartford, there are a lot of "Surplus Saps" at Headquarters whose ranks should presently be thinned in the interests of economy, if nothing else.

But a job is a job; and when a high salary is attached to it, some people will stop at nothing in their efforts to retain it.

In order to close the door on one unscrupulous method of doing so, by trying to cast doubts on the Colonel's motives, "RADIO" hereby offers \$1,000 reward to any person who can prove that "RADIO" is largely owned and controlled by Colonel Clair Foster, as Mr. DeSoto represents.

Step up, you guys at "Headquarters", and see if you can collect a little extra cash. If you are telling the TRUTH, it ought to be easy.

# Personalities – News – New Products

## McElroy Is World Champ

A new all-time record of sixty-nine words per minute was set at the World's Championship Radio Code Speed Copying Tournament, Massachusetts State Fair, Brockton, Mass., September 14th, 1935.

T. R. McElroy succeeded in regaining the title from J. Chaplin, Press Wireless, who had wrested it from him at Chicago in 1935, at a speed of 57.3 words per minute.

The contest was conducted in four heats, the first heat being at 48, the second at 54, the third at 61, and the final at 69 words per minute. At 61 W.P.M. both McElroy and Chaplin made perfect copies, while at 69 W.P.M. McElroy made two, and Chaplin, three minor errors.

The other contestants were J. P. Donnelly, of Mackay Radio, B. G. Seutter, Press Wireless, and E. Carter, RCA Communications, Boston. They all made splendid showings, but were decisively outclassed by the winner and the second man.

In charge of the operation of the contest were F. Rigby, Superintendent of RCA Communications in Boston and New England, and B. F. Borsody, W2AYN, of Brooklyn, N. Y.

The judges were C. Kolster, Radio Inspector First District, who represented the Federal Communications Commission, J. Toye, Editor of the Boston "Traveler", L. Greene, Radio Editor of the Boston "Globe", and N. Thompson, Radio Editor of the Boston "American".

The sending speeds were timed continuously during the transmissions by one of the judges, with a split second stopwatch. The word count was according to the international commercial practice, whereby twenty-four center holes of Wheatstone Transmitting tape, corresponding to twenty-four dots, are counted as one word. According to this count, the word "Paris" followed by a space, is a standard word in length.

The judges selected the material from Boston newspapers, immediately preceding the contest. This material was perforated into transmitting tape and run through the automatic transmitter by B. F. Borsody, W2AYN. The automatic transmitter used in this tournament was constructed by Mr. Borsody, and is normally used at Station W2AYN, Brooklyn, N. Y.

The contestants were required to copy the transmitted material in double case, using capital letters where necessary, and inserting all indicated punctuations. When the judges' decision was announced, that a world's championship had changed hands, the crowd gave Mr. McElroy an ovation. Mr. Chaplin, congratulating the winner, stated that the contest was the best run he had ever seen, and that he had no alibis to offer. The crowd, among which many comments were heard on Mr. Chaplin's modest demeanor and good sportsmanship, gave him another ovation.

## The Eimac 500T

• The Eimac 500T is a new radiation cooled triode manufactured by Eitel-McCullough, Inc. The Eimac 500T fills the long felt want for a triode of low interelectrode capacities and having such electrical characteristics as will permit a high power conversion factor. The Eimac 500T is fast finding favor with television broadcasting stations, high power diathermy equipment, police transmitters, etc. These services require a tube that will give high power outputs at very high radio frequencies. A single 500T will easily give class C outputs upwards of 1350 watts. Because of the one-kilowatt input regulation,

amateurs will not be able to use the high power outputs that the 500T is capable of giving. However, amateurs who desire simplification and added flexibility of equipment afforded by having ample power dissipation capabilities in the power tube will welcome the 500T. The tube is capable of giving a carrier power output of 250 watts when used as a conventional class B linear amplifier.

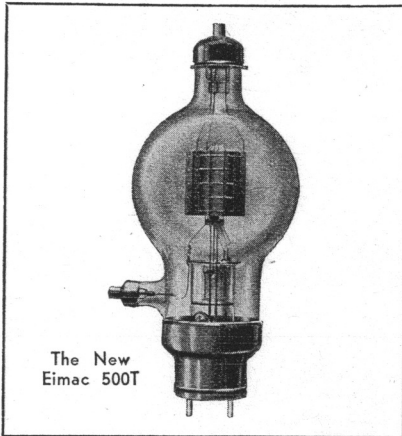

The New Eimac 500T

The Eimac 500T is constructed with tantalum grids and plate. The use of tantalum permits the 500T to be momentarily overloaded without danger of releasing gas. Long filament life is assured because the filament is not poisoned by gas liberated by the electrodes during operation. The Eimac 500T is now the big brother to the 50T and 150T.

Filament voltage	7½ volts
Filament current	20 amperes
Plate dissipation (continuous)	500 watts
Amplification factor (approximate)	15
Plate current (maximum)	.450 amperes
Grid current (max. DC)	.125 amperes
Plate voltage (maximum)	4000 volts
Plate-grid capacitance	4.5 mmfds.
Grid-filament capacitance	6.0 mmfds.
Plate-filament capacitance	.8 mmfds.
Envelope	GT 56 Nonex
Base	Special*
Overall height	16½ inches

## Class C Radio Frequency Amplifier Performance

Federal Communication Commission ratings for use in the last stage of high level modulated radio telephone power output, 500 watts.

Operating as a high-efficiency amplifier (75%) capable of 100% high level modulation. Power output 1350 watts.

Class B radio-frequency amplifier (modulation factor 1.0). Carrier power output, 250 watts.

Two 500Ts operating as a class B audio amplifier:

3000 volts	1200 watts audio
4000 volts	1600 watts audio

\* Socket readily fabricated from standard parts.

## A TALE OF RUGGED HAM INDIVIDUALISM W2HLO's Prize-Winning "LIAR'S Contest" Essay

• Well, lids, to make a long story longer, my tale commences near the ending and proceeds in logical order to the beginning.

Yep! I can remember the good, ole days when radio was first inaugurated as a national pastime in Abyssinia. I mean, the time when Marc Anthony first commissioned Edison and Marconi, those brilliant archaeologists, to build an up-to-date radio for his latest sweetie pie, Cleopatra.

It finally evolved into a siggle-sniggle receiver with super-special suppressor-grid speech amplification.

Yessiree, I can recall those days when we were grouped around the receiver, holding 365 watt lamps between our toes, to furnish the light by which to see. (This was one of those July nights when the sun set earlier in the day). We used to listen to 1MK come roaring in so loud that the neighbors would complain of rattling windows.

No kidding! And all this on a lonely, moth-eaten, dog-eared 224 megacycle AT cut xtal. The fones were merely draped around the xtal—in parallel with the fones, of course. The tuning was a problem, but was finally solved by placing the xtal in a hydraulic press, thereby changing the thickness, and thus the frequency.

Of course, the 160-meter fone lids cud not be heard on this xtal, so we added two common twinplex-super-dekaflex pentodes in a doubling arrangement to work on the 1/5 harmonic.

So much for the receiver; except that I might add that the fone cushions were made of selected, high-grade mountain-grown cast-iron. Iron was preferable to wood for two reasons. First, since the signal strength was nil, iron kept the fones from bouncing off our heads. And then it energized the vacuum existing between the normal ham's ears.

Naturally, since the signals were so loud something had to be done about it. Therefore when the energy overflowed from the xtal, it was gathered up carefully and placed into perforated cellophane holes.

Now we come to the xmitter. There I can proudly say, neither money nor time nor the patience of youth was stinted upon. Alas, I only wish you cud have seen it; that grotesque conjecture of Hugo Turnbull, who, by the way, was my sister-in-law's second cousin's brother on her mother's side, which is beside the point.

To continue, this transmitter consisted of only two tubes. The first, which I can proudly say as being the first to own, was a brand new 80, oscillating on 17 meters by a brute force arrangement whereby only 3481 Perrine volts positive RMS were applied to the grid adjacent to the plate. No voltage was applied to the plate, since as you all know that the "mu" of an 80 is great enough to pass all the surplus voltage to the plate. The extremely low voltage was used because I wanted to keep the tube only a crimson red and thus insure perfect frequency variation in accordance with NRA regulations. The other tube took care of the remaining functions of the xmitter.

It was an old 954 and doubled down to 43 meters, reflexed back and doubled again to 86 meters, with the astounding gain of —40 decibels. Then it was neutralized and operated as a straight amplifier on 3490 KC.

But alas alack; woe is me! There were only two things which prevented me from going on the air. First, the tube wud always stop oscillating for sum unknown reason every time I neutralized it. The second reason was that I only had a Class A ticker which did not allow triple sideband xmission on the 160 meter band.

Sooooo, there I was, right where I started, but fortunately in abt the year 1936 my parents met at a Radio Exhibition in Cortlandt Street (local gyp joint) and a few years later I was initiated into the world amidst a flock of the new sensational WD12's.

And so, dear reader (singular), you sure must have patience if u cud get this far—forthwith endeth my tale.

73's

W2HLO.



# Standardized Message Form

● It is not the writer's objective to disrupt or change the system of message handling adopted by ARRL as standard for message form, but merely to show the advantages of a form which is standard for commercial companies' practice the world over, and which would undoubtedly be much less of a handicap for those amateurs who are interested primarily in traffic handling. In fact, as was stated by the writer in several other articles dealing with the importance of this particular branch of radio, the amateur's message handling insures his place on the air because he can then prove his "Public Convenience and Necessity."

If all the commercial companies in the communication field each used a different message form, traffic would indeed be slowed down to a speed whereby only a small amount of it could be moved. But because all commercial communication companies, as a rule, use the same message form, same handling, and same count, traffic can be moved from one circuit to another without becoming garbled. When an operator is trained to hold down a circuit, his early experience enables him to handle traffic for any company he may be employed by. Of course, each company has its individual rules, but the message form, as stated above, is generally uniform.

If the amateurs adopt one form, and one form only, the art of traffic handling would become easier, and much more interesting. But under the present circumstances that have existed for years, one can find almost any kind of message form used by operators in the ham bands. With the ever-increasing interference problem, new stations crowding in our "inadequate bands", etc., it is inevitable that a standardized form be adopted. A great number of the amateurs ultimately desire to become commercial operators, therefore the ham game is not a mere hobby to them, but a routine or elementary method of training.

The present systems of message handling used by the amateurs are not entirely proper. For example, the gentleman who instigated the system used by ARRL evidently never handled a commercial message; he probably discovered a system of his own, now called "standard". No wonder so few ham messages reach their destination; with the present type of message form almost anything can result.

Here is shown a standard form of message used the world over by leading communication companies, with the exception of private companies who may either have a form of their own or a more or less modified system:

By R. G. MARTIN, W6ARD-W6ZF

When counting cable count, which is used by the majority of communication companies, everything within the addressee, text and signature is counted. If domestic count is used, only the text is counted. In the message shown at the bottom of the page, for cable count we find the "check" is fifteen, with signature W6XYZ counting as one word, but for domestic count the "check" is nine. GHQ is counted as three words, if sent as G. H. Q. If sent as GHQ it counts as one word.

If the same form is printed thus:

```
NR 28 W6XYZ CK 15 SAN FRANCISCO CALIF 245 PM AUG 5
NELLIE HART
BOX SIX
TWIN FALLS IDAHO
CONGRATULATIONS APPOINTMENT G.H.Q. IDAHO SECTION GOOD LUCK
W6XYZ
```

perhaps it might appear a little clearer. The difference in copying it in the indented or block form rests entirely with the operator's personal likes and dislikes, which do not materially effect the message form itself.

Such a form then becomes a message which an operator can handle with fair assurance of having it copied properly, and relayed in the same form. The majority of fellows coming into the ham game know from past experience, seeing a few telegrams, perhaps a few radiograms of the above described form of message, will recall the form used, because they know it is a standard in the commercial field. Nearly all beginners listen to some commercial station for code practice and in order to increase speed. Impressed upon their minds is the message form just described. Why make him use another type of form after he has so clearly and strongly fixed in his mind the form he first heard? The form must be good if our government (with the exception of the navy's communications) has adopted it. And even the navy's system is not much different.

Did ARRL ever have anything to do with any of the system of communication? Did any of its officers ever hold a responsible

position in a communications company? Their adherence to such silly systems as their message form is ridiculous.

How much better it would be to have a uniform and standard system of message handling, rather than our present ham system. It would not only be educational, but it would help strengthen our hold on the air. When we can no longer show that our cause is in the "Interest of the Public, a Convenience and a Necessity", ham radio will be like the Old Medicine Shows of years ago—here today, but gone tomorrow. If a commercial company cannot show just cause why it should not receive frequency assignments, licenses,

etc., it usually gets no consideration from our Commission in Washington.

● The Radio Club of Rensselaer Polytechnic Institute, Troy, New York, will begin its activities for the coming year with a social get-together in the Rensselaer Union Club House on Thursday evening, September 19th. The object is to welcome new members, and to compare notes on summer activities. Policies of the year will be discussed.

Professor H. D. Harris, professor of electrical engineering and physics at the Institute, will speak of the privileges and duties connected with membership in the Radio Club. Mr. John R. Banker, a student in the department of electrical engineering, will speak of five-meter activity, of which it is hoped there will be considerable this season.

The Radio Club has been an active organization at Rensselaer Polytechnic Institute for many years. As a body, it has built and operated the amateur radio W2SZ, located in the Communication Laboratory of the Electrical Engineering Department. Regular monthly meetings are held at which the normal business is supplemented with guest or student speakers. The equipment used by the Club is thoroughly modern and two way communication is carried on with all parts of the United States and with foreign countries.

Institute students interested in any phase of radio activity are invited to join. Code practice classes will begin the week to aid beginners to obtain their amateur licenses, and old timers to better their speed. An interesting season is promised.

● Amateurs of San Francisco were host to the local FCC staff at a stag dinner held on September 20th. Mr. V. Ford Greaves, in charge of the FCC's western division, was welcomed to his new post. Mr. Greaves is one of the Coast's best-known radio engineers, having been associated with the Federal Telegraph Co. and The Magnavox Co. in former years.

NR — CALL (ORIGIN) CK (Prefixed denoting type of msg)	—CITY—	Date	Time, or Time	Date.
Addressee .....	.....	.....	.....	.....
Text .....	.....	.....	.....	.....
Signature.....	.....	.....	.....	.....

To show what this form will look like when properly sent by a station:

NR 28 W6XYZ CK 15	San Francisco, Cal.	2:45 PM August 5
Nellie Hart	Box Six	Twin Falls Idaho
Congratulations appointment GHQ Idaho Section. Good Luck.		
W6XYZ		

## New Ball Bearing Mike Stand



● Moving up and down with a smooth pneumatic action, the new stands by Amperite require only 1/8 turn for a positive stop—free from "creeping". This smooth and positive action is obtained by the use of a newly engineered ball bearing clutch. The ball bearing clutch also permits the stand to be rotated without loosening the clutch—a very desirable feature when it is necessary to rotate the microphone in a hurry. There are no parts to wear out and no adjustments to be made. The action is always positive and smooth. The general appearance of the stand was designed by one of the foremost product design engineers. It is unusually rugged throughout. It can be obtained in either a chrome or black finish and with a 15-lb. or 25-lb. base.

# The Quartz Crystal Filter

By FRANCIS CHURCHILL

● A band width of relatively few cycles only is required for CW reception. By limiting the received band to approximately a hundred cycles, the ratio of signal to static or electrical noise is improved, because the signal is a single frequency and static is usually spread out over a very great amount of the frequency spectrum. The quartz crystal, properly cut and ground, can be used as part of a very selective filter for obtaining reception on a narrow band.

A quartz crystal will oscillate or vibrate mechanically when an electrical potential of a certain frequency is impressed across it. In so doing, its impedance to the electrical current is quite low and it can therefore be used as a series element of an electrical filter for CW reception. The quartz crystal can be compared to an electrical circuit as shown in Fig. 1, where C1 is the electrical capacity across the quartz plate when not vibrating, R is the electrical resistance equivalent to the frictional effects of the vibrating crystal, L is the inductance corresponding to inertia, and C is the capacity corresponding to the elasticity. On one side of resonance the circuit has capacitive reactance because the elastic forces control the crystal vibrations, while on the other side of resonance the reactance is inductive, due to the inertia effects. At resonance the crystal can vibrate freely, limited by the frictional effects. Here L and C are equal in reactance and this resonant frequency is the same as the mechanical resonance of the crystal.

If the impressed voltage is at the resonant frequency, the current through it will be large, limited only by the resistance R, as in any series resonant electrical circuit. There is also a leading current component due to C1 which can be balanced out by means of a phasing condenser in a SS (single signal) receiver. A phasing condenser is used in all SS receiver circuits in order to eliminate the by-passing effect of C1 of Fig. 1, or to use it as a means of eliminating one side band. C1 combined with L and C will provide a parallel resonant circuit at a frequency slightly different from series resonance at which the inductive effect is sufficient to provide this resonance.

By placing the phasing condenser in the circuit so that the voltage across it is out of phase with that across the crystal and therefore across C1, this parallel resonance can be shifted to above or below crystal resonance. Thus the phasing condenser can be set so that the parallel resonance causes a sharp dip in the response curve at some desired point, such as 2 KC away from the desired signal peak. This means that the other side band 1 KC away from zero beat with the beat frequency oscillator can be practically eliminated. The series resonance effect is used to pass the desired signal through an intermediate frequency amplifier for further amplification.

The effective Q of this mechanically resonant circuit is much higher than can be obtained with ordinary coils and condensers.

The Q of a circuit, ratio of  $\frac{wL}{R}$ , determines

the width of the resonance characteristic, i.e., the ability to reject signals of frequencies differing from that of the desired one. The more selective or sharper the response curve, the less the interference, thus it is desirable to have the band width only about 100 cycles wide, down to a point at which the gain of the receiver will not make undesired signals audible in the output. A good crystal filter

will provide an attenuation of about 60 DB to signals more than 5 KC off resonance with, of course, that much or more attenuation of the opposite side band, 1 KC from zero beat on the opposite side from the peak response.

Quartz crystals have a greater Q at lower frequencies. For this reason most filters are designed for operation at 500 to 450 KC, and used in an IF amplifier peaked up to that frequency. There is no way in which to vary the resonant frequency of a crystal to any extent which necessitates its use in an amplifier tuned to a fixed frequency. The actual signal is changed to the IF frequency by means of a first detector and high-frequency

ever, image interference becomes more troublesome, as in any superheterodyne receiver.

The crystals used in this work have a Q ranging from 1,000 to 10,000, a capacity usually in the vicinity of .01 micromicrofarads and an inductance of several henrys. The value of R ranges between 2,500 and 10,000 ohms, which means that the circuit should be designed to minimize its loading effect on any tuned circuits, otherwise the impedance irregularity will cause an excessive loss even at the desired signal frequency. This latter condition occurs in the popular circuit shown in Fig. 2.

The difficulty can be overcome to a good extent by using the circuit of Fig. 3, where the grid leak is replaced by a tapped resonant RF choke. The resonant effect, plus the tap, gives a step-up in impedance from the series element (the quartz crystal) and therefore only a slight loss in signal strength results. The only difficulty is in the design of the resonant choke, if the full possibilities of this system are to be utilized.

The only remaining difference between Fig. 2 and 3 is in the matter of obtaining an out-of-phase voltage across the crystal. The coil can be center-tapped to ground, or the center point of two condensers can be used. In any case, the crystal-input circuit tuning condenser and phasing condenser are adjusted simultaneously for maximum signal response. The IF amplifier and BFO must be adjusted to that frequency and to 1 KC off resonance respectively; therefore the crystal is often used in an external oscillator circuit which is used to produce a test signal for alignment purposes.

In the circuit of Fig. 4 the crystal is used as a series element, connecting two parallel resonant circuits together in a band-pass circuit. The small condenser C of 20 or 30 mmfd. is necessary in order to prevent over-coupling between the tuned IF transformers, because at series resonance only a few thousand ohms is offered as impedance. The small condenser C causes no great loss in signal because it couples two tuned circuits together, as in any band-pass filter. The only effective loss is in the use of the extra tuned circuits which are needed in order to eliminate the usual spurious side-band responses of most quartz crystals. These side responses are usually a few kilocycles away from resonance and thus the tuned IF transformers can be used to attenuate the amplification at values that are far from resonance.

The circuit shown in Fig. 5 (Hammarlund Pro) is another method for matching impedances; the low impedance of the crystal at resonance does not over-couple the two parallel tuned circuits. A 30-to-1 step-down ratio of impedance is used to work into the crystal, and a similar step-up ratio is used to couple it into the grid tuned circuit. Here again, a small series condenser is used to prevent over-coupling. Tests show that very little, if anything, is gained by the step-down transformers as compared with the system shown in Fig. 4. Any of the latter three circuits are infinitely better than the one shown in Fig. 2.

An air-gap type of crystal holder should be used because the value of R is lowest when the crystal is most free to oscillate. Too large an air gap may result in producing supersonic air wave resonance and excessive damping. An air gap about the thickness of a piece of thin paper is sufficient for best results.

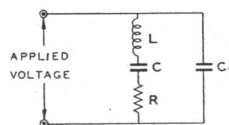

FIG. 1

Equivalent Quartz Crystal Circuit.

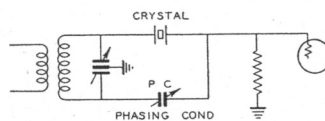

FIG. 2

James Lamb's Crystal Filter.

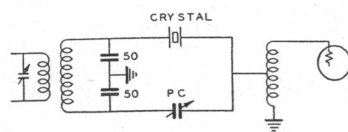

FIG. 3

McMurdo Silver's Crystal Filter.

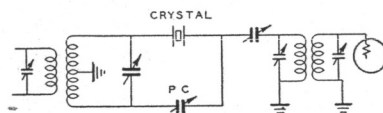

FIG. 4

Crystal Filter Circuit by Frank C. Jones of "RADIO"

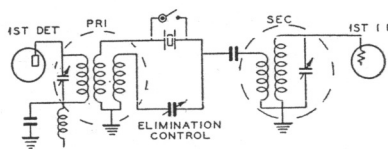

FIG. 5

Standard "Pro" Crystal Filter.

oscillator. The BFO (beat frequency oscillator) is used in order to obtain a signal of about 1000 cycles which can be heard as an audible tone in the output when receiving CW. From a selectivity standpoint, frequencies lower than 450 KC would be desirable because the crystal Q would be greater; how-



# REVIEW of Factory Receivers

## Patterson R-16

The new Patterson PR-16 amateur communications receiver incorporates many advanced features of design and construction. As its name implies, it has 16 tubes. Its tuning range is from 8 to 550 meters, grouped into 5 bands which are selected by a coil-changing switch. It has three stages of IF amplification.

A 6D6 is used for the first detector, two

6D6s are used in the parallel-operated RF amplifier stage, a 6C6 oscillator, 6D6 first, second and third IFs, 6C6 HF oscillator, 76 IF vacuum-tube voltmeter circuit, 6F7 second detector and beat oscillator, 6C6 in the AVC stage, 6A6 first audio push-pull phase inverter and two 76s as drivers for a pair of 6A3s in the final audio stage complete the tube line-up. The rectifier is a 5Z3. A 12-inch dynamic speaker is supplied as standard equipment.

The IF transformers are Litz-wound, 458 KC, band-pass type, four coils per unit. There are 16 tuned circuits in the IF amplifier alone.

The front panel controls include a phone jack, manual volume control, communication switch, volume control and AC switch, tone control, station selector with two speeds, wave band switch, beat oscillator switch, crystal phasing control, quiet-between-station switch, crystal filter series-parallel switch, 360 degree illuminated band spread dial, "camera shut-

ter" type tank condenser tuning dial and an illuminated meter showing the carrier in Rs.

The tuning condenser has six sections, low C. The filter has a total capacity of 56 mfd. The audio channel is flat from 2 DB plus or minus, 50 to 10,000 cycles; three stages of push-pull are used.

The complete circuit diagram is reproduced below.

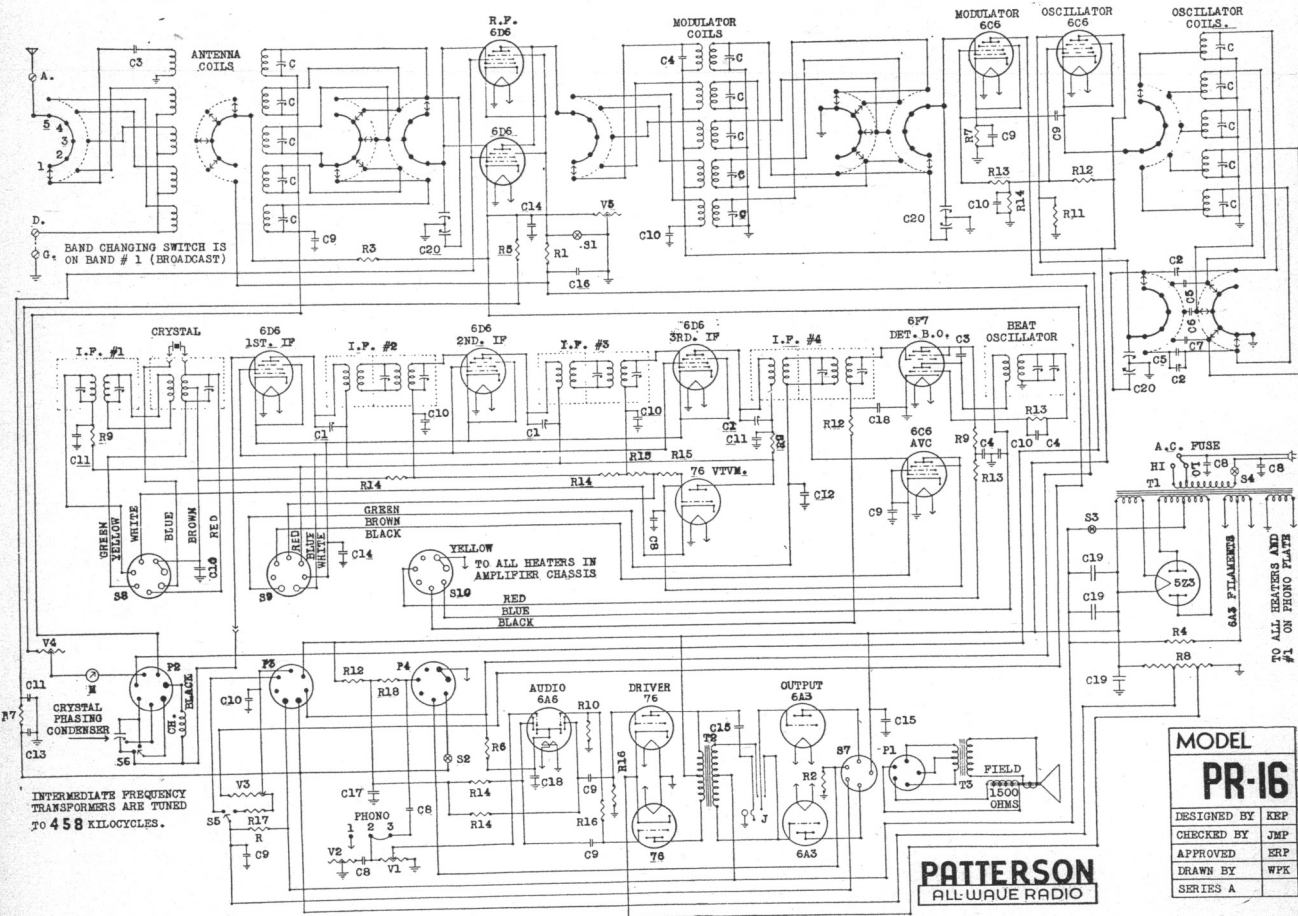
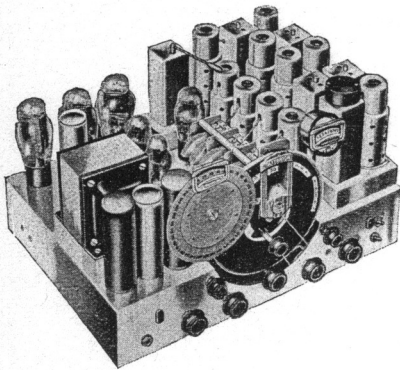

★ Herb. Becker, W6QD, here presents the first of his DX pages which will be a regular feature in "RADIO". In order to make the new department a success, DX men the world over are kindly asked to contribute liberally to these columns with news and information, station photographs, data on antennas, transmitting and receiving systems used, notes of personal interest, human and humorous comment on DX, etc. Through these columns the spirit of DX Amateur Radio will be reflected. Do your part. Appoint yourself a one-man committee to round-up some bit of news each month . . . and send it to Mr. Herb. Becker, 1117 West 45th street, Los Angeles, California. Copy for the November issue is needed in Los Angeles by October 15th; for subsequent issues on the 15th of each month. Come on, fellows, let's make this the most informative page of DX information ever presented.—Editor.



By HERB. BECKER, W6QD

Readers are invited to send monthly contributions for publication in these columns direct to Mr. Becker, 1117 West 45th Street, Los Angeles, California.

● It has been quite a job to get this column started, especially to get enough DX news from around the world to really make it varied. If all you fellows will keep your shirts on, things will pick up next month . . . that is, if some of the fellows who have promised to report every month don't break an arm or get a bad case of parasitics.

ZL4AI has packed his "works" and moved to London. His old sidekick ZL4BQ gives this info, and also says 4AI will not be allowed to use more than 10 watts for some time. That draws a smile when I think of that rip-roarin' R12 signal he used to pour into USA. The ol' three-phase sig that has churned through many a DX contest will not be quickly forgotten. G6WY says he sees ZL4AI every day or so, and at present he is helping him with one thing or another.

HZ7GRO . . . ah, there's a pip! . . . and he's causing plenty of headaches among the Ws. This elusive bird is in Hedjaz and as far as I can find out he has only hooked up with three Ws. His first W contact was with W6BYU, Chas. Reily, and since then he has worked W5EGA and another W station. From an authentic source comes word that W8CRA went to sleep calling this HZ fellow. S'matter, Frank? . . . next time better get a box of NO-DOZ. Anyway, 8CRA worked his 112th country a couple of weeks ago.

European contacts on the West Coast are still a daily occurrence, although in the evenings they have practically faded out. The boys out here surely can't squawk this year about not having a chance to work European stations. Of course, all this has been going on in the 14 MC band. On 7 MC things have been picking up lately, with the South Africans coming through, both in the mornings and evenings. About two weeks ago W6GRX put up a Diamond antenna which is directional for Europe. It is a rather flexible affair but at present he is using it on 7 MC. In one week he had 12 QSOs with G5BD and F8EX. He was doing this when a lot of the fellows were still wondering when Europe was going to come through on 40. His Diamond Beam certainly covers the landscape, and I think he had to annex part of another town in order to get it up. (Someone said he didn't believe this part of it . . . oh, well, let it pass).

ZS2A, our old friend, Pye, was operating at ZS2X the other night and says he will be on with a few watts sometime in November.

OK2AK is going in for a little power; just recently he bought an HK-354 and a couple of 866s. This equipment, hooked to that beam antenna of his, should really put in a snorting sig . . . just about anywhere.

LU1EP has just had a successful QSO with ON4AU on each of the three high-frequency

bands, 28, 14 and 7 MC. Then along come the Sasaki brothers, W6CXW, and within 6 hours they QSO LU1EP on the same bands. That, not being enough, the three of 'em, ON4AU, LU1EP and W6CXW, get together and have a 1½-hour solid ragchew. Well, guess that's taken care of . . . wait a minute, here's CXW again. He's always in somebody's hair. This time he works his second YL . . . it being YL2BQ, 14375 KC and NDC sig. Quoting W6CXW, "That makes two YLs I've worked, blonde and brunette." OK, Henry!

Maybe it was a surprise that Dave, W4DHZ, wanted to pull . . . but anyway I find that he has a new QRA about six miles outside of good ol' Atlanta. From all reports, it's really the stuff. Said something about "a swell big shack and all the fixings." Can't quite figure what the "fixings" are, but it's bound to come out sooner or later.

W8CRA, W6GRX, G5BD and VS1AJ had a lot of fun a couple of weeks ago in a 4-way QSO. Every exchange was solid, all around. One of these days a guy is going to pop up and say he was in on a 17-way ragchew that required 36 hours to enable everyone to have his turn. Who knows . . . mebbe we'll be having multiple marathon QSOs yet.

Did you know that G5BD has contacted W6GRX just exactly 101 times?

It seems that F8EX has a YL by the name of Marinette, but in the next breath he says he likes Virginia better. Say, what is this? Maybe that is the reason he is not on 14 MC anymore. Don't see why that should affect him . . . but still there's a chance.

W6HYB with a 1 KW controlled carrier phone has just received a pouch of mail from the jumping-off place of the Kangarooosters, and the verdict seems unanimous that he is the loudest W phone on the air. Well, guess we'll have to convert him to CW.

Wonder how that DXer, Fat Benning, W4CBY, is getting along? Bet he's spending too much time with that "corn" patch of his . . . or was it batch? Also, where is W6WB, W3BBB, W3ANH, W5ATF and a flock of the others who used to bat it out every night.

Flash! WAC in 55 minutes. Doc Stuart, W6GRL of Ventura, Calif., has been on the rampage during the past three weeks. On Sunday morning, September 22nd, within 55 minutes, Doc worked the following stations: J4CR, KA1JC, ZT5R, VK6FO, W6QD, LU4DQ, and G6MK. Brother, that's really steppin' on it. But wait . . . you haven't heard it all . . . Sunday, September 8th, the same ol' Doc does the six continents in 1 hour and 30 minutes . . . then exactly one week later he WACs in 1 hour and 15 min-

utes. By the time you read this, don't be surprised to hear that GRL has worked 'em all simultaneously.

It may not be new, but VR1DZ comes through every now and then with a DC signal on about 7150 KC. Time, around 0700 GMT. Suppose he is in Mauritius, or British Guiana, but don't bet on it.

Here's one for the book: W6HXU, Bill Seitz, has just moved to Manhattan Beach. One of the first problems at a new QRA is putting up a couple of sticks. Willie must have had a real nightmare on this method because this is what actually took place. The roof on his house is about 25 feet above the ground, so he decided to put a 40-foot pole on top of it, making the top of the pole 65 feet from ground. The pole was made in 2 sections. He took the lower half and dropped it down the chimney, that leaves just enough above to bolt the upper section. When the two halves are together, W6CUH grabs one guy wire, W6CGQ holds one, and I do the best with mine. HXU lifts the whole pole out of the chimney and sets it on the roof . . . what could be more simple? Says he may add another 20 feet every weekend. Ahem!

How's my DX? Lessee . . . oh, yes, last week I worked a new W9.

## RADIO CLUB ACTIVITIES

### The 210 DX Club

15060 Greenview Blvd.,  
Detroit, Mich.,  
August 28, 1935.

Editor of "RADIO":—

Several of the low power fellows have gotten together over the air and decided that what this country needs is not a good five-cent cigar, but a nation-wide QRP DX Club. So, from this need has arisen The 210 DX Club.

The requirements for the club are as follows:

- (1) The applicant must use not over 150 watts input to the final stage.
- (2) The applicant must be W.A.C.
- (3) The applicant must have worked at least 50 countries.
- (4) The applicant must use tubes of the 210 nature, or tubes of that power rating.

I imagine that there are several smaller DX clubs throughout the U. S. A. and Canada, but I think that our plan for a nationally known DX club will go over big with "we of the lower power rigs".

Anyone interested in belonging to our club, and who can qualify to the above requirements, can get more information by writing the club secretary, W8GQB. The officers will be chosen from the applicants, the president being the one with the most countries to his credit, and the next highest the vice-president, etc. For the time being W6GAL will hold the top notch with 64 countries to his credit.

Yours truly,  
THE 210 DX CLUB,  
WIN PEEBLES, Secy.,  
W8BQB.

### Milwaukee Radio Amateurs' Club Broadcast

Commencing October 10th, 1935, and on each second Thursday of the month thereafter, up to and including May, 1936, The Milwaukee Radio Amateurs' Club will broadcast the entire proceedings of one of its regular meetings over The Milwaukee Journal's shortwave station W9XAZ. Programs will run from 8:00 P.M. to 10:00 P.M., SGT, on 31600 KC, or 9.4 meters.

Technical and political talks and discussions of particular interest to the amateur will be featured and dramatic sketches of amateur events may also be enacted from time to time.

The programs are also being scheduled to aid in the development of 10 meter research, W9XAZ's frequency of 31600 KC being just 1688 KCs outside the high end of the amateur 10 meter band.

W9XAZ is licensed to use 500 watts. Its antenna is located 300 feet up atop the 27 story Schroeder Hotel in Milwaukee.

Both W9XAZ and the Milwaukee Radio Amateurs' Club will appreciate reports of reception of this feature anywhere. Comments and criticisms are welcomed.

Address all communications to W9XAZ, The Milwaukee Journal, Milwaukee, Wis.



# EIMAC Tubes—More Power, Longer Life

## The EIMAC Tube Handbook

This new 12 page bulletin contains much valuable general information on the design, construction and adjustment of amplifiers and transmitters, in addition to the characteristics of EIMAC tubes. The tube characteristics are presented in the new and exclusive constant-current charts which tremendously simplify the determination of optimum operating conditions for Class A, Class B or Class C operation. Write to your nearest EIMAC dealer, whose name and address is shown below, and he will send you a copy.

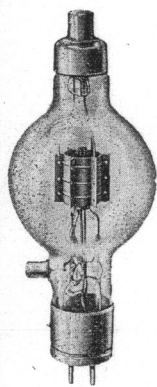

**50T** - Price \$13.50 Net  
50 watts of available plate dissipation. 30 watts of filament heating power. Only 2.5 ufd's. plate-to-grid capacitance.  
Filament 5 V. at 6 A. Rated plate loss 50 W. Amp. factor 13. Max. plate current 100 MA. C<sub>gp</sub> 2.5 ufd's. C<sub>gf</sub> 2.0 ufd's. C<sub>gr</sub> 4 ufd's. Base UX 4 pin. Max. height 7½ inches. Max. diameter 3⅜ inches.

Plate Voltage	Class C RF Output One Tube	Class B Audio Output Two Tubes
1000 V.	75 W.	100 W.
1500 V.	115 W.	150 W.
2000 V.	150 W.	200 W.
2500 V.	185 W.	230 W.
3000 V.	250 W.	260 W.

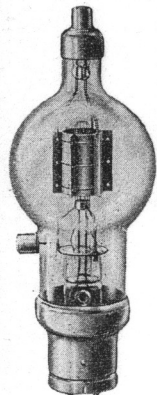

**150T**—Price \$24.50 Net  
150 watts of available plate dissipation. 50 watts of filament heating power. Only 3.5 ufd's. plate-to-grid capacitance.  
Filament 5 V. at 10 A.; rated plate loss 150 W. Amp. factor 14. max. plate current 200 MA. C<sub>gp</sub> 3.5 ufd's. C<sub>gf</sub> 3.0 ufd's. C<sub>gr</sub> .5 ufd's. Base 50 watt. Max. height 10 inches. Max. diameter 3¾ inches.

Plate Voltage	Class C RF Output One Tube	Class B Audio Output Two Tubes
1000 V.	150 W.	200 W.
1500 V.	225 W.	350 W.
2000 V.	300 W.	500 W.
2500 V.	375 W.	625 W.
3000 V.	450 W.	700 W.

## EIMAC PRESENTS THE 500T

**T**HE newest member of a great family is the EIMAC 500T. The 500T is a medium-high-power general purpose radiation cooled triode. It has the lowest interelectrode capacities of any tube of comparable ratings and it can be operated, at reduced output, clear up to 100 megacycles. The nominal class C rated output at 72% plate efficiency is 1350 watts. Particular attention has been paid to reducing the stray inductance, capacity and resistance of the grid and plate leads in order to minimize losses at the ultra-high frequencies.

The low plate resistance and favorable grid current characteristic make the 500T very useful as a class B audio or radio-frequency amplifier. The ultra-high vacuum which characterizes all EIMAC tubes allows the 150 watt Thoriated Tungsten filament to operate at high efficiency and give long life. The use of Tantalum as a grid and plate material ensures the maintenance of the vacuum throughout the life of the tube, despite momentary overloads. The elimination of the "Getter" and all internal insulators prevents tube failure from overheating these two prolific sources of gas.

The lack of a satisfactory socket and base arrangement for high power tubes led us to design our own base. A socket for the 500T can be made in a few minutes by drilling four holes in a small piece of Bakelite, or similar material, and mounting therein four standard quarter-inch coil or copper tubing chucks, such as those made by E. F. Johnson Co., and others. The filament leads are paralleled through each pair of the four base pins in order to minimize the possibility of a poor connection at this point.

The 500T requires much less grid excitation at radio frequencies than comparable tubes, due to its high power gain at high plate efficiencies.

While the insulation and vacuum are both good enough to allow the 500T to be operated at 4000 volts, it should be emphasized that the low plate resistance allows high power output to be obtained at materially lower plate voltages.

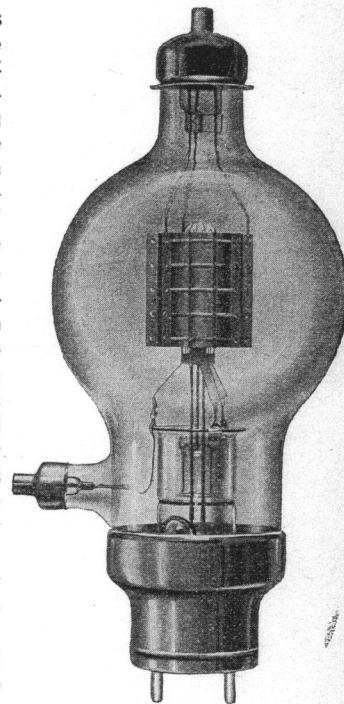

EIMAC 500T  
\$175.00 Net

**EITEL-McCULLOUGH, INC.** SAN BRUNO CALIFORNIA, U. S. A.

Albany, N. Y. Uncle Dave	Midwest Radio Mart. Newark Electric Co.	Grand Rapids, Mich. Radio Distributing Co.	Los Angeles, Cal. Radio Supply Co.	Peoria, Illinois. Radio Mfg. Engrs.	San Diego, Calif. Coast Electric Co.
Atlanta, Georgia. Wholesale Radio.	Dayton, Ohio Standard Radio Parts	Honolulu, T. H. Honolulu Furniture Co.	Radio Television.	Philadelphia, Pa. Radio Electric Svc.	San Francisco, Cal. Offenbach Electric.
Baltimore, Maryland Radio Electric Svc.	Des Moines, Iowa Iowa Radio Corp.	Jacksonville, Fla. Glover-Weiss Co.	Milwaukee, Wis. Radio Parts Co.	Herbach & Rademan	Seattle, Washington Seattle Radio Supply.
Boston, Mass. H. Jappe Co. The Radio Shack.	Detroit, Mich. Radio Specialties Co.	Kansas City, Mo. Radio Laboratories	Newark, New Jersey. Wholesale Radio Svc.	Pittsburgh, Penna. Cameradio Co.	Spokane, Washington. Spokane Radio Co.
Buffalo, N. Y. Dymac Radio	Denver, Colorado. Interstate Radio	LaCrosse, Wisconsin. SOS Radio Supply.	New Orleans, La. Shuler Supply Co.	Portland, Oregon. Wedel Company, Inc.	Texasarkana, Ark. Mim's Radio
Butler, Missouri. Henry Radio Shop.	Fayetteville, N. C. Hunter Brothers.	Lancaster, Pa. Conestoga Elec. Co.	New York City. Gross Radio, Inc.	Providence, R. I. W. H. Edwards & Co.	Toronto, Ont. Canadian Tire Corp.
Chicago, Illinois. Allied Radio Corp. Chirad	Fresno, California. Ports Mfg. Co.	Little Rock, Ark. Vinson Radio Co.	Oakland, California. Electric Supply Co.	Reading, Pa. George D. Barbey Co.	Tulsa, Oklahoma. Radio, Inc.
			Oklahoma City, Okla. Southern Sales Co.	St. Louis, Mo. Walt. Ashe Radio Co.	Wheeling, W. Va. Cameradio Co.
				St. Paul, Minnesota. Lew Bonn Company.	

## Neutralizing Condensers

The inter-electrode capacity of a vacuum tube determines the value of condenser capacity needed to neutralize a transmitter circuit. Tube inter-electrode capacities vary from 2 to 15. The higher the inter-electrode capacity of the tube, the greater will be the capacity required to neutralize the circuit.

The capacity of the neutralizing condenser can be determined from the formula:

$$C = \frac{.225A}{d}$$

where A is the area in square inches of the interleaved plates of the neutralizing condenser, multiplied by the number of air spaces; d is the distance in inches between adjacent plates; C is the capacity in microfarads.

For example, a condenser that will be suitable for neutralizing a single 211 tube will have two plates, each 4 inches square, and spaced about 1/4 inch apart. These plates can be secured to standoff insulators in such a manner that the movable plate can be rotated through a 45° arc. Transmitting coil plug-in pins and jacks make a good bearing arrangement for the rotor plate.

For a low C tube, such as the 50T, 150T, 354, etc., the size of the neutralizing condenser plates should be approximately 3 inches square, spaced 1/2 inch apart. The corners and edges of the plates should be rounded and polished. The plate area sizes here given are those which actually overlap.

So that the neutralizing condenser will not flash-over when high voltage is used, the spacing between plates should be 1/4 inch for plate voltages up to 1500 volts; 1/2 inch for plate voltages up to 2500 volts; 1 inch for plate voltages up to 5,000 volts.

## A Simple RF Voltmeter

Very few amateurs have an RF measuring instrument at their disposal. Neon glow tubes are satisfactory for some purposes, but it is quite difficult to measure two different settings of an antenna tuning condenser, for example, then measure again, and compare the two settings by the glow of a neon tube, because it is not easy to remember just how brightly the tube glowed the other time.

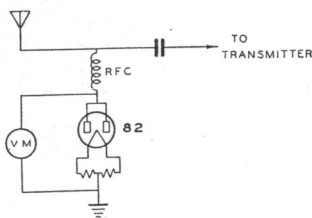

Here is a novel and simple method of measuring the peak settings of an antenna tuning unit with only a low-range voltmeter, an 82 tube and a RF choke. The only voltage to be measured will be the leakage of the RF choke, and this particular setup shows 7 volts peak. By substituting a 100,000 ohm resistance for the choke, I get about 300 volts, but this of course imposes a larger drain on the antenna and affects the tuning slightly. With the RF choke the tuning is not affected at all. The meter can be read accurately, of course, and direct comparisons between two settings of the tuning unit are shown. Be sure to couple to the antenna exactly as shown, so that the DC plate voltage will not get on the meter. Incidentally, this is an excellent test of the effectiveness of different chokes at your transmitter frequency.

Contributed by Jerrold A. Swank, W8HXR  
2819 N. Main St., Dayton, Ohio

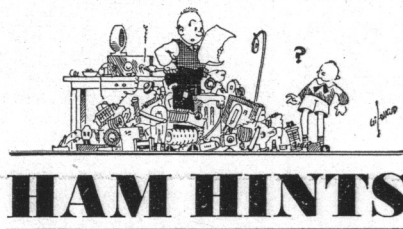

## HAM HINTS

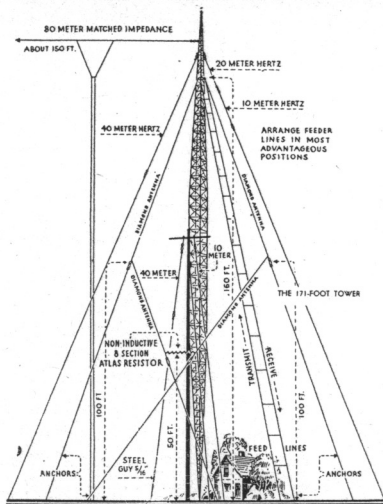

New 171 ft. tower and antennas at W6AM, Don C. Wallace, Long Beach, Calif.

A similar light-weight lattice-work tower was completely described in November 1933 "RADIO" by B. Molinari. It is inexpensive; a 60-foot tower can be built for \$10.00. Furthermore, the average tower can be made self-supporting and it can be mounted on roofs or supported to the walls of a building. A 60-foot tower can be carried by one person. The tower at W6AWT has successfully weathered a number of violent storms.

## How To Cut Aluminum

Sheet aluminum is hard to "work", unless the constructor is familiar with short-cut methods. When cutting a piece of sheet aluminum, first lay a T-square, or other flat rule, on the metal. With the aid of an awl, cut a deep groove into the metal. Continue to "scratch" this groove (on both sides of the sheet) until the metal has been grooved to about 1/2 its thickness. Then lay the metal sheet on a flat-top table, with the scratch marks at the edge of the table. Bend the overlapping end back and forth and the metal sheet will neatly break apart. Or, the sheet can be placed into a vice and the "loose end" given a series of rapid jerks until it breaks apart.

## How To Make "U" Bends

Place two pieces of wide angle iron into a vice. Place the metal sheet between the angle pieces. With the aid of a sturdy block of wood, laid against the metal where it protrudes from the iron angle pieces, press down on the wood block and the metal will bend easily. A wood or rubber mallet can also be used to gently shape the metal to the desired angle.

## Finishing Aluminum

Hold the aluminum sheet against a motor-driven wire-wheel brush and a beautiful stain-like finish will be secured. Lesser effective results are secured by rubbing the metal with steel wool. Rub in one direction only.

Aluminum can be given a dull, stain-like finish by immersing it in a hot solution of caustic soda and water. "Cook" the metal in a large pan or bucket for a few minutes. Then remove with the aid of a pair of pliers. Rinse quickly in cold water. Stand upright to dry, so that the water will run off without streaking the metal.

A "laboratory" finish can be applied to aluminum panels by holding the metal against a motor-driven cork. An ordinary cork is held in the chuck of a drill press or lathe and the spinning of the cork, when pressed against the metal, will "grind" concentric circles into the metal. The circles can be of any size, depending on the size of cork used for the work. Some beautiful effects can be secured by an overlap of these concentric circles, or a border design of small circles can be run close to the edges of the panel, if desired.

## RF Chokes

There are several varieties of pie-wound RF chokes. Those who prefer to wind their own should choose the solenoid winding type. A RF choke, if designed for maximum impedance in one amateur band, is not satisfactory for operation in other bands because of the effect of its distributed capacity and inductance. The choke would prove satisfactory on three times the fundamental frequency, but worthless on twice that frequency.

The coil should be wound so that its fundamental operating frequency is about midway between its lowest and highest impedance. On even harmonic operation, therefore, the reactance will be fairly high. If the RF choke is to be used only on one band, it can be wound for resonance. Its effect across a tank circuit, when being tested, is negligible at that frequency. If, for example, it is to be used on both 80 and 40 meters, more or less turns are needed in order to also keep the second harmonic impedance high. In all such cases, the lower end of the RFC should be by-passed back to ground because some RF current will flow through it.

If the length of the solenoid is not great in comparison to its diameter, its fundamental resonance can be calculated from C in mmfd. = .24d, where d = diameter in inches and C is the distributed capacity. The inductance can be obtained from L in micro-

$$\text{henrys} = \frac{a^2 n}{9a + 10b}$$

a = radius of coil in inches  
n = number of turns  
b = length of coil in inches

$$f = \frac{254 \times 10^6}{LC} = \frac{160,000}{LC} \text{ in kilocycles.}$$

These formulae give a starting point. Actual construction for short wavelengths, such as 5 to 40 meters, can well be made on small diameter rods or tubing with a long winding, several times its diameter. The wire should be large enough to safely carry the DC plate or grid current, as well as a fair amount of RF current.

In high power circuits, RF chokes should be placed at points of low RF potential, if possible, because even the pie-wound chokes, contrary to popular belief, are not efficient on all amateur bands. Care must also be taken to see that grid and plate RF chokes do not cause a tuned-grid-tuned-plate oscillation at the fundamental frequency of the RF chokes. If possible, the grid choke should have an inductance of at least 10 or 20 times that of the plate choke.

"RADIO" will give a one-year subscription to readers who send acceptable HAM HINTS for publication.



# The Lowly "Bloopers"

—But a "High-Brow" Performer and an Excellent, Inexpensive Little Receiver for the Rural Amateur.

By HENRY WILLIAMS

You need not be ashamed to show this one-tuber to your ham friends, nor are apologies necessary when a demonstration is given; for this is a receiver that does its "stuff" and many a tried-and-true ham has built one and boasted of its merit to other hams. The circuit was previously shown in "RADIO", but because only a passing suggestion was made that it would be an ideal circuit for a portable set, nobody paid attention to it. Build one of these little fellows and prepare yourself for a pleasant surprise. There's not much to it; a type 19

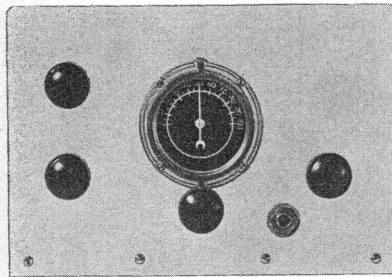

The controls on the front panel are: Top, left—"Tank" tuning condenser. Bottom, left—Regeneration condenser. Center—Airplane tuning dial. Extreme right—Rheostat control.

The headphone jack is mounted between the airplane dial and the rheostat control. This jack MUST be insulated from the metal front panel and a hole at least 1/8-inch larger in diameter than the outside diameter of the screw thread on the jack should be drilled in the panel.

tube which acts in the dual role of detector and audio amplifier, an old audio transformer, a few condensers and coils, a 6-ohm rheostat, a 45 volt B battery and two dry cells, a few sundry parts, and you are ready to build the receiver.

It gives surprisingly good volume and it pulls in the DX with ease. The circuit diagram is self-explanatory. The usual plug-in coils, 5-prong type, are used. The antenna is coupled to the "hot" end of the secondary coil by twisting a few turns of the lead-in wire around the lead which goes to the top of coil L1. A single-turn loop of the antenna lead, wound around the top of coil L1, will likewise give good results.

G1 and P1, one section of the type 19 tube, serves as a detector; G2 and P2, the other section of the tube, connect to the audio circuit. Care should be taken to see that the proper grid and plate connections are made, as shown in the circuit diagram.

Bias is secured by means of the rheostat in the filament circuit. Here, again, the constructor is advised to follow the circuit with care. The movable arm of the rheostat connects to negative A, and also to the negative F terminal on the audio transformer.

Best results are secured when a 5 megohm grid-leak is used. Smaller values will some-

times cause the detector to go into regeneration with an unpleasant roar.

Still smoother regeneration is sometimes secured by connecting a 250,000 ohm, 1/2 watt, resistor across the secondary (G-F) terminals of the audio transformer.

The band-spread tuning condenser is a 3-plate midget variable; the "tank" tuning condenser is a 50 mmf. (or 100 mmf.) midget variable. A 140 mmf. midget variable con-

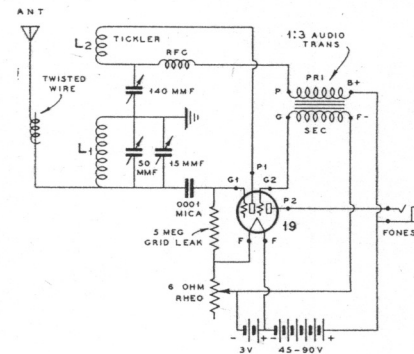

Circuit Diagram for 1-tube "Bloopers"

denser should be used for the regeneration control, as shown in the circuit diagram. The secondary and tickler coils are both wound on the same form, and both coils must be wound in the same direction, otherwise the detector will not oscillate.

The front panel is a piece of No. 12 or No. 14 gauge aluminum, 7-in. x 9-in. The wood baseboard is 9-in. x 11-in. The band-spread condenser, "tank" condenser and regeneration condenser are mounted directly on the aluminum panel and the rotors of all of these condensers are grounded to the panel. However, the rotors of all three condensers should be connected together and then also connected to ground. An inexpensive airplane vernier tuning dial adds beauty to the job. This dial controls the 3-plate band-spread tuning condenser.

The photograph of the rear view of the receiver shows a small midget variable condenser at the center rear of the baseboard. Such a condenser can be connected in series

with the antenna lead and the top lead of coil L1. It can be used as a substitute for the twisted wire coupling arrangement, if the constructor so desires.

Ordinary Fahnestock battery connector clips can be used for headphone connections in place of the phone jack; these connector clips can be secured to the baseboard in any convenient location, preferably alongside the audio transformer.

An on-off switch can be added, if desired, or the dry cells can be disconnected from the receiver when it is not in use. Two 1 1/2 volt

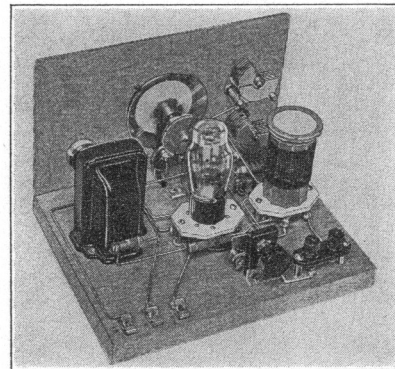

Rear View of the Completed Receiver

dry cells are required. They will give good service over long periods of time. The B battery voltage can be as low as 22 volts, but at a sacrifice in audio volume. 45 to 90 volts is more suitable for normal operation, except when the receiver is used as a portable. A 22 1/2 volt C battery can be used for the latter service. The tickler coil must be moved quite close to the secondary coil when only 22 1/2 volts is used.

All connections should be electrically and mechanically perfect. Rosin-core solder should always be used. Avoid the use of soldering paste, flux or acids. The soldering iron should be well tinned.

No. 22 DSC wire is satisfactory for winding the coils for any band. The 20 and 40 meter secondary coils should be space wound, but the tickler coils can be close wound, with the exception of the tickler winding for the 20 meter coil, which should also be space wound.

	L1 (Secondary Winding)	L2 (Tickler Winding)
For 20 Meters	7 turns, No. 22 DSC wire, space wound to cover 1 inch winding space.	4 1/2 turns, No. 22 DSC wire, space wound to cover 3/8 inch winding space.
For 40 Meters	14 turns, No. 22 DSC wire, space wound to cover 1 inch winding space.	5 turns, No. 22 DSC wire, close wound.
For 80 Meters	27 turns, No. 22 DSC wire, close wound.	9 turns, No. 22 DSC wire, close wound.
For 160 Meters	60 turns, No. 22 DSC wire, close wound.	15 turns, No. 32 enameled wire, close wound.

L2 is spaced 1/4 inch from L1. Both coils wound in same direction.

# "Underneath the Whitewash"

(Continued from page 9)

Washington on March 20th, 1923. Further perusing the July, 1923, Editorial, we find that the object of this Second Conference was—"TO STUDY THINGS ALL OVER AGAIN AND SEE IF A WAY COULDN'T BE FOUND TO DO THE THINGS THEY WANTED TO DO UNDER THE OLD LAW, SINCE THEY COULDN'T HAVE A NEW ONE." (Italics ours).

"This time," says the Editorial, "the hue and cry was to cut down the amateur—". The account then records the way in which the Amateur representatives at that Second Conference bargained with the opposition. Read it. Here and there, as in other articles we may read together before we're through, their apparent lack of preparation, and their full measure of innocence and naivety, will peep out at us from the printed page.

On page 35 we find their spokesman, in that unsigned Editorial, more or less apologizing for them:

... "This conference didn't have a bit of power, you understand; it was merely a body of experts from all kinds of radio interests (including our president as a representative of our A.R.R.L.), which had been asked to study radio problems and report. BUT WHEN A REPORT HAD BEEN MADE UP OF WHAT THE MAJORITY AGREED UPON, THE DEPARTMENT OF COMMERCE ANNOUNCED THAT THEY ACCEPTED THE REPORT IN FULL AND WOULD FOLLOW THE RECOMMENDATIONS.

"Then we asked the Conference, what about our 375-meter 'Z' wave," which the previous conference had talked about cutting down to 310 meters . . ." (Italics, except that of the words "This conference didn't have a bit of power," are ours. Those words will be found italicized in the original!)

Now, I ask you!

What did our spokesmen think that those "experts" were down there to do, anyway? Clearly, they were down there because they, and Mr. Hoover, (who lacked "discretion" enough under the 1912 Act), wanted to agree on some scheme whereby a lot of illegal and legally-questionable things could be done, which could NOT be done under the 1912 Act. The motives underlying the Second Conference were noble enough, here and there; but the commercials wanted slices of the Amateurs' territory quickly; and they had no idea of waiting for Congress to dish this territory out to them. As "QST" says, . . . "This time, the hue and cry was to cut down the amateur."

The acceptance, in full, of the recommendations of the Conference was to be expected. The idea was to get as many interests as possible to agree, so that nobody would rush into a Federal Court to "upset the apple-cart."

But the rudest jolt was yet to come.

Turn to Page 37 of that July, 1923, "QST." Read it and weep:

... After the second Hoover Conference had hammered us Amateurs down to 222 (220) meters for a top limit, it developed that 150 meters had been specified as the lowest wave with which the conference should concern itself—the lower waves were 'reserved'. Consequently, even though the conference did assign 130 m. and 143 m. to the Navy, their recommendation for us Amateurs reads from 150 to 220 m. WHAT OF OUR TIME-HONORED RIGHT TO ALL THE WAVES FROM ZERO TO 200 METERS, WE ASKED. NOTHING TO IT, WE WERE TOLD, TAKE A LOOK AT THE LAW. AND SURE ENOUGH, THE LAW DOESN'T SAY THAT WE CAN USE ANY WAVE BELOW 200 M., AS

MANY HAVE THOUGHT, BUT THAT THE DEPARTMENT CAN ASSIGN US WAVES ON WHICH TO WORK SO LONG AS THESE WAVES DON'T EXCEED 200 METERS. AND THE DEPARTMENT SAID OUR ASSIGNMENT WAS TO START AT 150 METERS. THIS IS SOMETHING WE WEREN'T LOOKING FOR, SOMETHING WE DON'T UNDERSTAND, AND SOMETHING WE DON'T LIKE AT ALL . . . But the Department is adamant, and it looks like orders from 'higher up'; THE CHIEF ONLY SAYS WE'VE GOT ENOUGH CYCLES AND OUGHT TO BE SATISFIED. We are assured that experimenters seriously interested in the development of waves under 150 meters can get X-licenses for that purpose without difficulty, but there the matter of shorter waves rests at this writing—" (Italics ours).

To my way of thinking, it was proper enough to release some of our frequencies for commercial development via the "Gentlemen's Agreement" route. BUT WHAT GRIPES ME IS THAT OUR REPRESENTATIVES WENT TO THAT CONFERENCE UNPREPARED, WITHOUT BEING AWARE OF OUR LEGAL RIGHTS UNDER THE 1912 LAW, AND WITHOUT PROPER REALIZATION OF THE EXACT NATURE OF THAT MEETING. Under such circumstances, it was apparent to the commercial interests that we were not adept at developing our full bargaining powers, and that an "adamant" attitude on the part of the "Chief" left us baffled.

At some later date, as Warner claimed in 1925 and 1926, Headquarters may have discovered their mistake. BUT IT SEEMS COMPLETELY CERTAIN FROM THIS "QST" ACCOUNT THAT IN 1923 THEY WERE IN A FOG.

In between the Second and Third Conferences, little of interest appears to have happened. However, on page 7 of the September, 1924, issue of "QST", I find a reprint of the Amateur Regulations issued by the Department of Commerce under date of June 24th, 1924.

One paragraph, only, deserves notice:

"Hereafter special amateur stations will not use wave lengths above 200 meters. They may be authorized to use the band of wavelengths from 105 to 110 meters in addition to the wavelengths within the bands authorized for general restricted amateur use, where the special amateurs are engaged in conducting tests with government or commercial stations. . . ."

The Third National Radio Conference was held in Washington from Oct. 6th to 10th, 1924.

A report of it will be found in the December, 1924, "QST", at pages 16 to 17; and comments by A. E. Kennelley on the same meeting will be found on page 18 of this same number.

What was the status of the conference of 1924? The "QST" article says that it was ". . . advisory to the Department of Commerce . . ." (p. 16), and states that its ". . . recommendations can not be considered as effective unless adopted by the Department . . ." (p. 16).

Unlike the Second Conference of 1923, this Third Conference of 1924 ("assigned" ALL wavelengths from 0 to 3,158 meters (see page 16). On the same page, it is stated that the "assignments" were to be for one year only, and that the Conferences were to be annual affairs.

The recommendations closely paralleled those of the Department—or, rather, the temporary and "tentative" Amateur allocations dated June 24th, 1924, and found in the Sep-

tember, 1924, "QST," at page 7, as mentioned above.

As a result of the 1924 Conference, the Amateurs "got," by virtue of Regulations of the Department of Commerce, passed in accordance with the dicta of this Conference, (See p. 29 of the March, 1925, "QST") the following wavelength assignments (Regulations dated Jan. 5th, 1925):

150 to 200 meters;
75 to 85.7 meters;
37.5 to 42.8 meters;
18.7 to 21.4 meters;
4.69 to 5.35 meters.

The privilege theretofore extended to special stations, to use the waves from 105 to 110 meters, was withdrawn.

By 1925, Headquarters had some inkling of the true state of affairs. But the mistake of 1923 was not admitted.

On page 39 of the April, 1925, "QST", a letter from the Department of Commerce was printed, saying that the "B.C.L.'s" had been experiencing interference from "Ham" stations operating with broadly-tuned sets below 85 meters during "quiet hours;" and Mr. Warner's comment, appended to this letter, was to the effect that the Regulations violated were not sanctioned by the Law of 1912.

He advised us, however, that the 1912 Law had "broken down;" and in the same breath he cautioned us against violating the Regulations, because it still was vital enough to cause cancellation of our licenses for "deliberate interference." ". . . Don't try to wriggle out of it through that hole . . ." we were told. (Page 39).

We were not informed just how the 1912 Law had "broken down," nor why it was that a law could "break down" and still have "teeth" in it.

Possibly our growing knowledge softened the heart of the Secretary of Commerce; for during 1925, two "tid-bits" were handed out to us.

The May, 1925, "QST," at page 36, recites General Letter No. 269 of the Department of Commerce, dated March 17th, 1925, authorizing Amateur beam transmission for experimental purposes on 400,000 to 401,000 K.C. (0.7496 to 0.7477 meters). It is stated that any Amateur could apply; but my guess is, that few did so. At any rate, this band was opened at the League's request.

The other "tid-bit" was handed to us shortly after this; for in the July, 1925, "QST," at page 38, we find a notice that—"In a conference at the Bureau of Navigation, Department of Commerce, on May 29th, it was decided to permit radio transmission of pictures and facsimiles under ordinary amateur licenses. Stations may use any wavelength for which they are at present licensed."

Then came the "Fourth National Radio Conference." This took place in Washington on Nov. 9th to 11th, 1925. Mr. Warner's report of it, (p. 33, Jan., 1926, "QST") says:

... "All of the amateur bands remain as they were before the conference. Three recommendations affecting amateurs were adopted.

"(1). The opening of a 100 Kc band from 83.3 to 85.7 meters (3500 to 3600 Kc.) to amateur phone operation, the usual quiet hours applying.

"(2). The opening of the so-called amateur 80-meter band to naval aircraft and naval vessels working naval aircraft.

"(3). The prohibition of the spark on all waves below 200 meters . . ." (Italics ours).

However, when it came to issuing Regula-



tions based on these "recommendations," the Department failed to "knock out" the sparks. (See Feb., 1926, "QST," page 8).

The Navy, of its own motion, rejected the idea of using Amateur frequencies, except for work at the Naval Research Laboratories at Bellevue, D. C. (See "QST," Feb., 1926, p. 58).

Then came the big "blow-off," in 1926, upsetting these "Gentlemen's Agreements" for all time.

Let's pick up the story as it is told by the American Bar Association's Standing Committee on Radio Law in 1929 (Vol. 54, Reports of Am. Bar Assn., p. 440 et seq.)

This account first mentions the Intercity Case which was in the Court of Appeals of the District of Columbia in February, 1923 (Hoover v. Intercity Radio Company, 286 Fed. 1003), and then says:

(p. 440) "... The inadequacy of the Radio Act of 1912 was perfectly obvious after the decision of the Court of Appeals ...

(p. 441) "... The long anticipated calamity then occurred. On April 16, 1926, Judge Wilkerson of the Federal District Court for the Northern District of Illinois gave judgment for the defendant in a prosecution brought by the Government against the owner of a broadcasting station, who, in violation of the terms of his license, had broadcast on a frequency (a Canadian exclusive channel) other than that assigned in the license and on full time instead of for the limited period authorized. (United States vs. Zenith Radio Corporation, 12 F. (2d) 614. See also Carmichael vs. Anderson (D. C., Mo., July 19, 1926), 14 F. (2d) 166). The court actually held that the prosecution had improperly been brought under Section 1 of the Act and implied that it might properly be brought under Section 4 of the Act. *The court also, however, intimated that if the Secretary of Commerce had power to impose restrictions as to frequency and hours of operation the statute might have to be construed as unconstitutional for failure to provide a standard to control the Secretary's discretion.* In the publicity given the decision its scope was represented and was popularly understood as being somewhat broader than is actually justified by its language. At any rate, the Secretary of Commerce referred the question as to the extent of his discretion under the Act of 1912 to the Department of Justice. On July 8, 1926, Acting Attorney General Donovan rendered an opinion to the effect that under the Act of 1912 the Secretary had no power to determine or restrict the frequency, power or hours of operation of a radio station or even to limit the term of its license. (35 Op. Atty. Gen. 126). On July 9, 1926, as the result of this opinion, the Secretary of Commerce virtually abandoned regulatory control of radio communication and became a mere bureau for registration of licenses, issuing licenses to all applicants for whatever frequency, hours or power were designated in the applications. Fortunately the Secretary of Commerce did not abandon his previous practice of limiting all licenses to short periods of three months.

(p. 442) "In the period which intervened between July 9, 1926, and the enactment of the Radio Act of 1927 on February 23, 1927, nearly 200 new broadcasting stations came into existence ... These new stations selected such frequencies as they chose without regard to interference or the rights of either American or Canadian stations. Existing stations which were dissatisfied 'jumped' to other frequencies and increased their power and hours of operation at will. The result was a chaos which will long be remembered in the radio world as the 'BREAKDOWN

OF THE LAW,' in which radio reception was virtually ruined . . .

(p. 443) "... On December 8, 1926, Congress passed a joint resolution, limiting licenses to a ninety-day period and stipulating that no license or renewal be granted unless the applicant execute in writing

"a waiver of any right or of any claim to any right, as against the United States, to any wave-length or to the use of the ether in radio transmission because of previous license to use the same or because of the use thereof. (44 Stat. 917).

"On February 23rd the two Houses finally reached an agreement and hastily enacted a compromise bill known as The Radio Act of 1927 . . ." (Italics ours).

Warner's review of the situation created by the decision of Judge Wilkerson in the Zenith case is in the June, 1926, "QST," at page 7.

Still the mistake of 1923 was not admitted. Although the account of the Second Radiotelephony Conference in 1923 entitled "The Status of the Amateur" shows us plainly that the spokesmen of "Ham" Radio didn't know what to do when our "time-honored right" to all the waves from zero to two hundred meters was challenged, and when the Secretary of Commerce "went adamant" on us, Mr. Warner (in 1926) would have us believe that our authorized representatives had been "wise" to the true state of affairs, all the time, even back in 1923.

Turn to the June, 1926, "QST," above mentioned, and let's read Warner's review of the situation together:

Of the Zenith case, he says that this decision held that "... It manifestly had been the intent of Congress, in framing the 1912 radio law, to specify in the regulations in Section 4 all of the regulations which could be applied to radio administration, and that, except in the few cases of specific discretionary power given the Secretary of Commerce, he is not authorized to apply and enforce the numerous other restrictions and regulations governing power, wave lengths, operating hours, and so on, with which we have become so familiar in recent years . . ."

He then announces (p. 8) that the A.R.R.L. stands—"four-square and solidly for the 'gentlemen's agreements' of the Fourth National Radio Conference to which it is a party—," and tells the "Hams" to stay right within their present bands.

He goes on to say that (p. 7) "It is also made clear that the Department of Commerce has no legal right to impose on the stations eligible to operate below 200 meters any additional regulations not expressly written into Section 4 of the 1912 Law or provided for therein. Thus wavelength assignments in narrow bands, quiet hours, limitations on types of apparatus—all may be held to be without legal standing. THIS APPLIES NOT ONLY TO US AMATEURS, BUT TO EVERY OTHER CLASS OF STATION FOUND ENTITLED TO OPERATE ON WAVES BELOW 200 METERS.

"This situation has been NO SECRET TO THE OFFICERS and the LEGISLATIVE COMMITTEE OF THE A.R.R.L. THEY HAVE KNOWN OF IT FOR YEARS. In common with other radio interests, however, they have realized that the art has far outstripped the 1912 law, that the demand for radio channels is so pressing that no one interest has a right to MORE THAN IT NEEDS, and that as long as adequate legislation is withheld by the procrastination of politicians it is necessary to govern the art by extra-legal agreements arrived at in a SPIRIT OF MUTUAL CONSIDERATION and goodwill. THE NA-

TIONAL RADIO CONFERENCES OF SECRETARY HOOVER HAVE PROVIDED THAT OPPORTUNITY . . ." (Italics ours).

I leave it to you to say just how many years it was that the officers and the legislative committee had been "in on" this secret; and in particular, I ask you whether they knew the whole truth in 1923.

Not having been there, I can't gauge the amount of "mutual consideration and good will" which was present at the Four Conferences, but I doubt if it was so great that it slopped over onto the rugs.

We "got off on the wrong foot" in 1923, and gave away too much, too easily, I fear.

However, we Amateurs are nothing if not naive, trusting and high-minded. These characteristics of ours, plus more lack of preparation, were to deal Amateur Radio another staggering blow in 1927, when the Washington Convention (Treaty) negotiations began; although Colonel Clair Foster, W6HM, tells me that he personally told Mr. Warner what we Amateurs would be up against when negotiating or dealing internationally, and says that he advised Mr. Warner to "get set" for trouble.

But we are getting ahead of our story; and it is time to consider the Act of Congress known as the Radio Act of 1927.

Turn to page 24 of the December, 1927, "QST," where the Regulations of the Department of Commerce dated Oct. 28th, 1927, are set forth.

Our bands were then as follows:

AMATEUR FREQUENCIES		
Kilocycles		Meters
401,000 to 400,000	0.7477 to	0.7496
64,000 to 56,000	4.69 to	5.35
16,000 to 14,000	18.7 to	21.4
8,000 to 7,000	37.5 to	42.8
4,000 to 3,500	75.0 to	85.7
2,000 to 1,500	150.0 to	200.0
AMATEUR PHONE PERMITTED IN:		
64,000 to 56,000	4.69 to	5.35
14,000 to 14,500	20.68 to	21.4
2,000 to 1,580	150.0 to	190.0

It will be observed that this "hastily enacted" 1927 Act gave the Amateurs, legally, what the Four Hoover Conferences (variously referred to as "Radiotelephony Conferences," "National Radio Conferences" and "Hoover Conferences") had "chiselled" them down to, via the extra-legal "Gentlemen's Agreement" route. It is reasonable to suppose that if we had emerged from these four sessions with the Secretary of Commerce and the Commercials with more to show for our efforts, the 1927 Act would have allowed us to retain what we had saved. In any event, the more we had at the end of those four Conferences, the more we would have had to trade on when the next crisis arose. And had we exhibited more astuteness, the Commercials would have had more respect for us.

In negotiating with hostile interests, any good business man or lawyer knows that it is far easier to hang onto what you already have, than it is to get something back again, once you've lost it. This principle applies to wavelength negotiations with great aptness; for when frequencies are once lost by us, the Commercials are always careful to occupy them and to build up legal claims to them in every possible way.

Now, the year 1927 was also memorable because an International Conference took place in Washington during that twelvemonth.

An experienced Realist like Colonel Foster knew well enough what the "international grabbing-match" would be like. He says that he implored Warner, personally, to prepare in advance for plenty of "brass-knuckle" work. The Colonel tells me that it was no use; and

(Continued on page 32)

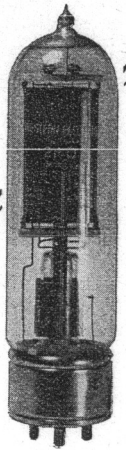

**\$4.90**

# Western Electric

## 211-D FIFTY WATTERS

GENUINE - BRAND NEW - FULLY GUARANTEED

Do not hesitate to buy brand new, *first grade*, genuine Western Electric fifty watters for \$4.90. (Regular price \$17.50). Standard Fifty Watter base. Standard Characteristics (Interchangeable with type 211 and 211-A). Has new long life filament! Rated RF output as an amplifier—100 WATTS!

Every tube in its original Western Electric carton! *The WESTERN ELECTRIC name is your guarantee of highest quality. Your money cheerfully refunded* if you do not agree with us that this is the *greatest value* ever offered to the amateurs! Every tube is *unconditionally guaranteed* for 30 days. (Broken glass and burned out filament the only exception.)

SEND YOUR ORDERS NOW as our stock is limited.

### MORE TUBE VALUES

#### FIRST GRADE - BRAND NEW

Unconditional 30 Day Guarantee

Genuine DUOVAC types 845, 872, or 242 (211) Any type	\$ 7.95
DUOVAC 860 Screen Grid	14.75
DeForest 10 or 8L	.79
CARBON PLATE 203-A	8.45
865 Screen Grid. Carbon plate	8.75
Heavy Duty 10. Large plate	.79
Good 46's. FB for Xmitting! Three for	1.00
HEAVY DUTY 866 RECTIFIERS	1.15
Columbia 50's. Special	.69

Buy on Approval From Harrison!  
Don't keep it if you don't like it!

### FILTER CHOKES

Acme 20 Henry, 250 MA. Mounted. 7½ lbs. An FB Choke!	\$ 2.45
Polymet 30 Henry, 200 MA. Mounted. 5½ lbs. net	1.95
Thordarson 20 Henry, 125 MA. Mounted. Actual weight 2 lbs. Special	48c
Thordarson 8 Henry, 400 MA. Neatly metal cased, FB for input choke, 3000 volt insulation. 75 ohms	1.35

### SUPER-SPECIALS

<b>AEROVOX MICA CONDENSERS</b>	
Large moulded Bakelite type 1450. .01., each, 27c; Four for \$1. .0002 or .00025, each, 10c; Six for, 40c.	
<b>THORDARSON T-2385</b> — 750-550-0-550-750 Volts. 100 watt rating. List price \$14.00.	
<b>SPECIAL</b>	\$ 3.35
<b>GENERAL ELECTRIC METERS, 2". D'Arsonval Regular moving coil movement with zero adjuster. Supplied with shunt wire and instruction for converting to any desired DC Milliamp range.</b>	
G. E. Soldering Irons. Heavy Duty. 55 Watt	1.95
500 Ma Xmitting RF Chokes. Duo Lateral wound	.18
Mike cable, 3 wire, Shielded, rubber covered, per ft.	.04

### "SUPER-GAINER" PARTS

<b>Hammarlund:</b>	
MCD-35-MX. Dual 35 mmf. condenser	\$ 2.06
SM-100 Star 100 mmf. condenser	.58
Insulantite Sockets. Any prong	.35
XP-53 Plug-in coil forms. 4 or 5 prong	.21
Alladin Polyiron IF Transformer	1.50
50,000 ohm Centralab control	.39
10,000 ohm tapered potentiometer	.49
1 Watt Lynch resistors	.12
Adjustable hum-bucker	.22
Magnet Wire. Any size or insulation. Spool	.24
BCL Coil .19c Tube Shields	.14
Insulated phone jack	.15
.1 Mfd Condenser .07 .01 Mfd	.06
25 Mfd. 25 Volt Electrolytic	.23
Sangamo Illini Mica .002 .15; .00025	.12
Aluminum ⅛" thick. 1.10 per sq. ft. 7"x14" panel	.68

Immediate shipment of anything else you need

### FREQUENCY METER-MONITOR

Complete Listening—Monitor—Frequency Meter. Accurately calibrated and supplied with calibration chart and coils for 1.7, 3.5, and 7 Mc bands. Self-contained in crackle finished metal cabinet with hinged lid to match your other equipment. Complete as described with tube, coils, Burgess Batteries, and chart \$6.75

### FILAMENT TRANSFORMERS

Thordarson. Metal cased. Binding post terminals. AC cord and plug. Delivers 13 volts at 4 Amps. Heavy 2 ohm rheostat included to adjust to exact voltage needed—the best way to operate filaments for a long life. Special Combination Price—Transformer and Rheostat \$1.10

2½ Volt, 8 Amp. CT Midget transformer	.69
2½ Volt, 12 Amp. Center-tapped. Open frame mount. 10,000 volt insulation. Tapped primary	1.25

## HARRISON

### RADIO COMPANY

142 Liberty St., Dept. PR-10 New York City



Osockme, Japan,  
August 23, 1935.

Conventional Editor of "RADIO",  
Sir Hon. Ed.:-

Convention seasons are in bloom again, Hon. Ed., and Hashafisti Scratchi have been gleefully enjoying such contraptions with greatest of care-free joy. Announcings of convention come to Scratchi that tickets for admission are three dollar bucks each piece so Scratchi proceed to make reservation. On arrivals at convention, Scratchi lay down \$1.80 on registration table and inexperienced ticket seller ask for what are such. Scratchi reply "that \$1.80 are for my \$3.00 ticket. I are an amateur. I expects my customary 40% discount." Scratchi have always been given 40% off on everything he buy in line of ham gear and it seem so crazy to me that age-old rule of 40% become violated and repealed when it come to buy convention ticket. But it are useless task to make argument with ticket cellar, so Scratchi borrow extra needed cash from local office of Salvation Army, where I are also given free bed-like sleeping contrivance on which to repose and such.

Come next the dawn and shrieking whistle wake Scratchi up from sound effect sleep. Scratchi mayhap think such whistle are local brewery announcings of going to work time, but it are merely bedlam of steam unloadings by amateurs who have assemble in convention to listen to speech of greetings from mayor, but who appear in form of Coroner's assistant to make opening convention screech, because Hon. Mayor have been called suddenly out of town some months ago by husband of young YL blonde preferred, because such husband wish make proposition to mayor that he leave YL blonde alone and attend more strict to business of opening ham convention meetings.

Hon. Coroner who are pinch-socking for Mayor make announcings that he are mighty glad to see so many of his future prospects assembled in convention at one time. Coroner he say as following: "Gentleman amateurs, you have all been dead since the Washington Treaty, and only your spirits fly through the small cracks in the ether on 5, 10, 20, 40, 80 and 160 meterings. You all should have come to my office many years ago to provide proper burial for yourselves. However, I are sure I will see you all very soon in persons because it are conclusive facts that you will soon make perish from suffocations. It are inconceivable to me how 45,000 hams can squeeze into a few meters, and sure annihilation are staring you in naked face, unless you immediately pump your stomachs full of balloon gas so you will swell out so much that you will bump into commercial people who sit right on top of your bands and almost ready to fall inside of them". Such were great speech, Scratchi applaud. And upon looking around I find I are only fool who make such applause because all other amateurs have left convention room and Coroner were making speech all by himself to Scratchi alone. So Scratchi also make haste foot to down stairs hard licker room where The Spirit of Amateur Radio are sold in bottled form. Upon evidence shown from Liquor List, Scratchi find from instant slide-rule calculation that according to price per glass charged for invigorating refreshments, each quart of liquor cost actually more than three type 204-A tubes in push-pull. So Scratchi make quick decision that tube manufacturers are friendly peoples after all.

Scratchi find so many friends crowded against mahogany bar who wish to buy Scratchi free drinks for splendid advices which I so regularly give in these columns, that I are, as usual, soon water-logged and I are instantly become accused of being intoxicated.

Snooted fellow amateur pat me on back and he say hic hic Scratchi I think you are ready to pour yourself back into bottle. To which I reply that it are not Scratchi who are intoxicated, but it are the very man who accuse me of such factless fact. I say I prove to him that he are intoxicated, and not Scratchi. I point my finger to other end of hotel room and I say . . . "Look here, brother-loving ether hogger, I will prove to you I are not intoxicated. You look down there and you see two beautiful YL blondes coming down the stairs. Now, if I were intoxicated, it are evident I would see FOUR of such YLs instead of only two." "HI, HI, HI, the other amateur exclaim, there are only one YL coming down those stairs." So Scratchi become insensed at ravings of brother (Continued on facing page)



### BILEY CRYSTALS

"World's Finest Crystal"

Guaranteed to improve your crystal stage efficiency and give you perfect satisfaction and performance! Holder free with each crystal!

BC3 (within 5 kc.—3.5 or 7 mc.) \$3.95  
LD2 (within .1%—1.7, 3.5 or 7 mc.) \$4.80  
Sent C.O.D. if desired—no money down.

Inquiries answered promptly. Folder free on request.

ORDER DIRECT FROM  
**HAM PRINT SHOP—W8DED**  
53 East Seventh St. Holland, Mich.  
We Sell EIMAC Tubes and ARRL SUPPLIES

### SPECIAL GROUP SUBSCRIPTION RATES TO RADIO CLUBS

Generous discounts on subscriptions if 5 or more members subscribe at one time. Radio club secretaries are invited to write for special proposition. "RADIO", Pacific Bldg., San Francisco, Calif.

### LITTELFUSES

Instrument LITTELFUSES, for Meters, 1/200 amp. up—Hi-Volt Fuses for Transmitters, etc., 1,000, 5,000 and 10,000 volt ranges, 1/16 amp. up. All needed by radio men and save valuable equipment. Neon Voltage Fuses & Indicators (Tattellites), 100, 250, 500, 1,000 & 2,000 volt ratings—100 uses—A new test instrument. FREE Catalog on all Littelfuse Products—Aircraft Fuses, Auto Fuses, Mountings, etc. Write

LITTELFUSE LABS  
4236 Lincoln Avenue Chicago, Ill.

\$1 brings you the next four issues of "RADIO"—Subscribe NOW.



ham, whose name are Joe. I invite Joe to talk walk down to water front with me and after nineteen hour walk we reach such water front. Scratchi walk back to big city alone. I go into nearest telephone booth and I call up Coroner who make convention speech. I ask him as follows: "Hon. Coroner, do you have a friend of mine by name of Joe in your refrigerator?" Coroner snap back and say he have no such Joe on ice. So I say to Coroner that it must me mistake somehow, because Scratchi are positive that Joe should have made appearance at Coroner's place almost any moment because Scratchi have thrown Joe into the bay nine hours ago. I therefore make quick retreat from convention, Hon. Editor; because Scratchi were afraid he mayhap run into countenance of your esteemed self, Hon. Editor, and I still believe I make great mistake in throwing my friend Joe into bay instead of waiting for your arrival. Mayhap next time you bring some of your Hon. editorial staff with you and perform great service to hamdom by having all three of us jump into the bay together, yes?

I sign off now, Hon. Editor, because I have much work to do on new RST system which have numbers from one to infinity and in which system all letters in Greek alphabets will be combined to simplify reporting system for brother hams. So Scratchi c.u. l., or like L. I. C. U.?

Yours until the last grid leak is plugged,  
Hahafisti Scratchi.

...

### New Books

"The Cathode-Ray Tube at Work"—By John F. Rider, 1440 Broadway, New York City.

● This is a practical manual of instruction on diagnosing troubles in radio receivers by means of the cathode-ray oscillograph. The first third of the 322-page text is devoted to an explanation of the general action of cathode-ray tubes in commercial types of oscillographs. The remainder of the book is concerned with some of its useful applications.

These include the measurement of phase difference, determination of frequency, measurement of AC and DC voltage and current, study of periodic wave-forms, and checking RF, IF, and AF amplifiers. Alignment of tuned circuits with the auxiliary aid of frequency modulators is exceptionally well covered in a 50-page chapter. Concluding chapters deal with tests of auto-radio vibrators and methods of adjusting "ham" transmitters.

NEW!

Now Ready the 1936  
ALLIED CATALOG

New!

RCA V-Cut Quartz Crystals in pressure-airgap ceramic holder. Complete listing in the new ALLIED Catalog. Supplied in the hand. 3.5 to 4.0 m.c.

New!

The entire line of new Thordarson Transmitters—you'll find them all in the 1936 ALLIED Radio Catalog.

New!

The new RCA 838 and 803 Transmitting tubes, also—they're in the complete new Amateur section of the 1936 ALLIED Catalog.

New!

The Ohmite Band-Switch for instant QSY. Here's another example of the newness, the "up-to-dateness" of the 1936 ALLIED Catalog.

ALLIED RADIO CORPORATION  
833 W. JACKSON BLVD., CHICAGO, ILL.

# BUILD YOUR OWN

## ALL-WAVE ALL METAL TUBES

# Meissner De Jong "8"

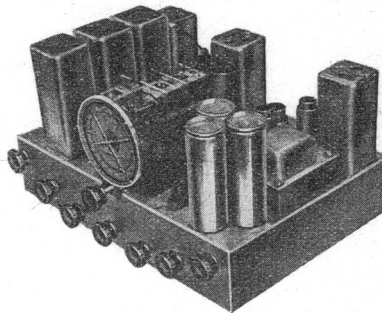

IT'S the latest "wrinkle" in radio receivers—with features not to be found in *any other kit or receiver on the market!*

Where else can you find such things as IRON-CORE I. F.'s—electrical band spread *already mounted on the chassis base*—a beautiful set of perfect coils (Ant.—R.F.—Oscillator) pre-mounted on the base and *pre-balanced!*

*You don't need any instruments to build this set—just a screw driver, a pair of pliers and a soldering iron. All the balancing has been done for you in advance.*

Ask your Parts Jobber for all the details—or send the Coupon to the factory for FREE literature!

## YOUR JOBBER HAS IT

### Features

- ★ Four Bands—giving continuous coverage from 540 kc.—25,000 kc. (15-550 meters.)
- ★ 8 All-Metal Tubes—with the Chassis especially engineered around them.
- ★ Iron-Core I. F. Transformers (Meissner Ferrocart)—the last word in super-selectivity and gain!
- ★ Meissner Coil Assembly (Ant. R. F. Oscillator)—pre-built, matched, mounted on the chassis and balanced.
- ★ De Jong Band Spread tuning unit—giving micromatic electrical band spread over entire tuning range.
- ★ Beat Frequency Oscillator for ease in tuning S-W phone and making Code signals audible.
- ★ Automatic Volume Control—Tone Control, and sufficient Output to cover the block.
- ★ Chassis Base already drilled for mounting parts.

MAIL THIS COUPON

## Meissner

2819 WEST 19th STREET  
CHICAGO, ILLINOIS

Meissner Mfg. Co.  
2819 W. 19th St.  
Chicago, Illinois

**FREE** details on the Meissner De Jong "8".

Name .....

Address .....

City..... State.....

## \$1 Brings You the Next 4 Issues of "RADIO"

### 7000 Kc. XTALS

New thick cut—highly active  
—single frequency response **\$2.25** P.P.  
—no special holder required — guaranteed — close to freq.

—Also—

C&S—Thick cut, low drift, 80-160..... **\$2.00**  
(Recommended)

AT—Accurately cut, 80-160..... **\$2.00**

Y—cut, 80, 160 m..... **\$1.35**  
All cuts close to freq. - Guaranteed

QRA: C & S XTALS  
836 E. WEBER AVE. STOCKTON, CALIF.

### HI-POWER for SOUND EQUIPMENT



The Carter Genemotor supplies the most Reliable and Economical "B" power for Class A or B Amplifiers from a 6 or 12 volt battery. Output up to 500 volts. Sturdy — Compact — Quiet in operation — Requires no oiling — Guaranteed. Write for Bulletin showing complete line of Genemotors for every purpose or specify your requirements.

**CARTER MOTOR CO.**  
365 W. Superior St. Chicago

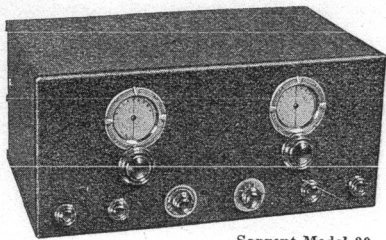

Sargent Model 20

## Short Wave Fans! Amateurs! Here It Is!

*Everything You Want  
in an All-Wave  
Communication Type  
Super*

- One Stage Pre-Selection
- A.V.C. and Manual Volume Control
- Continuous Band Spread, Calibrated for Amateur Bands
- Coil Switching—No Plug-in Coils
- Built-in, Hum-free Power Supply
- Headphone Jack
- Excellent Broadcast Band Reception
- Ideal for Shipboard Work
- Razor-edge Selectivity
- Fractional Microvolt Sensitivity
- Outperforms Receivers selling for 3 times its price.

Everything you can possibly ask for in a communication type super-het, yet priced so you can afford to buy it. Model 20 is a well built receiver, carefully designed to amplify the weakest signals with an absolute minimum of interference and noise. Its "effective sensitivity" is extremely high, and it receives weak signals lost in the noise level on most sets.

Model 20 prices given below include an 8" Jensen speaker unit and a complete set of tubes. For speaker cabinet, finished to match receiver add \$3.25 net to these prices.

This will be the outstanding receiver of the 1936 season. ORDER YOURS TODAY.

AMATEUR NET PRICES  
Model 20-SA, 15-550 Meters, complete.....\$59.50  
Model 20-MA, 15-1500 Meters, complete.....\$67.50

IMMEDIATE DELIVERY

### E. M. SARGENT CO.

212 Ninth St., Dept. R

Oakland, Calif.

## CROWE

RADIO COMPONENTS

DIALS, KNOBS and SWITCH PLATES for TRANSMITTERS,  
SOUND EQUIPMENT, OSCILLATORS, Etc.  
CARRIED IN STOCK BY LEADING JOBBERS AND DEALERS.



No. 260

Chrome and black Gain plates in several styles and readings.

Die-cut instrument dials. Professional appearance and extreme accuracy.

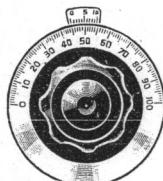

No. 292

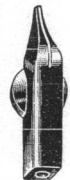

No. 285



No. 286



No. 284

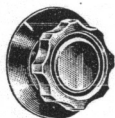

No. 283

Black Bakelite knobs in matching sets.  
Bar Knobs - Switch Knobs - Skirt Knobs

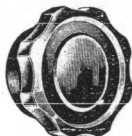

No. 280



No. 275



No. 278

Aluminum and black Switch Plates, Gain Plates, Volume and Selector Plates.

Send for Bulletin No. 60 showing other Amateur Items

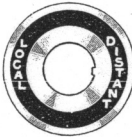

No. 30

Established 1899

### CROWE NAME PLATE AND MANUFACTURING CO.

1755 GRACE STREET

Cable Address: Crowname, Chicago

CHICAGO, ILLINOIS

## ASTATIC

### CRYSTAL MICROPHONES AND PICKUPS

Guaranteed instruments, known for their quality, dependability and ruggedness. Extensively used in both Professional and Amateur fields. Send for your literature today!

ASTATIC MICROPHONE LABORATORY INC., YOUNGSTOWN, OHIO

### FREE OFFERING

NEW METAL TUBE BOOKLET  
HAMMARLUND SHORT WAVE BOOKLET  
WORLD-WIDE COLORED SHORTWAVE  
MAP

Send DIME EACH for Postage and etc.  
Sets, Kits Parts. Factory Prices.

RADIO CITY LABS., Suite 1221  
30 Rockefeller Plaza New York, N. Y.

## "UNDERNEATH THE WHITEWASH"

(Continued from page 29)

it is my hope that he will soon publish an account of this.

In any event, the pages of "QST" show plainly enough that once again we failed to realize the character of another Conference, ahead of time.

Look at Mr. Warner's Editorial on pages 9 to 11 of the December, 1927, "QST":

"If anybody had been able to tell us a month ago what this International Radio Conference was going to be like, we would have taken flight on the next ship to Patagonia or St. Helena or some other quiet jumping-off place, or found some convenient way of leaning accidentally against the high-tension terminals of our plate supply, or something. As it is, we expect to be a candidate for Elizabeth Hill or whatever the pretty name is of the big Government nut-house near this fair city. We have been right here for the longest month of our life, while our optimism has slowly seeped away like the charge in a bum condenser, and right here we're going to stick 'for the duration.' We started out with the gay idea of flitting back and forth twice a week between here and Hartford, keeping an eye on both jobs. But that was forgotten in the first week, when we got a wire recalling us here when we sneaked home for the first week-end, and so Hartford is having to manage to get along without us and of course the Washington conference has the benefit of our picturesque presence and all that sort of thing . . ." (Italics ours).

On page 10 he says:

"Fellows, they don't like us. We're a nuisance. We want wavelenghts, and wavelenghts are mighty valuable things, so necessary for government and commercial needs that we oughtn't to have any . . ." (Bold type ours).

While you have that same December, 1927, issue of "QST" in your hand, turn also to page 11, and read President Maxim's article called "Big Dividends." I don't believe there were any big ones.

Some day, I hope that the full, detailed and truthful story of that International Conference in 1927 will be told. One of the U. S. Navy representatives is said to have "bucked up" Warner's courage for him at least once; and there were a number of persons who came in contact with our main "Spokesman" whose testimony would be interesting.

You are all familiar with the fact that the Treaty DID cut down our bands as granted by Congress in 1927; and the Madrid affair is still fresh enough in your minds so that I shall not bother to review it.

If there hasn't been any SERIES of losses, I'd hate to see a real series commence!

### Compact Line Filter for Receivers

• A line filter that employs both inductance and capacity filtering for elimination of noises picked up by receivers through power lines, is being offered by the J. W. Miller Company, Los Angeles.

Equipped with approved rubber cord and unbreakable plug, the attractive, compact unit may be readily installed on any broadcast, short-wave or all-wave receiver by connecting in the line and attaching a single ground wire.

Special duo-lateral wound chokes produced by Miller-designed winding machines are used exclusively in the line filter with oil-impregnated paper dielectric condensers.

The complete assembly is housed in a compact metal case attractively finished in Kem-Art black, with polished chromium plated ends.

List price, \$4.00.

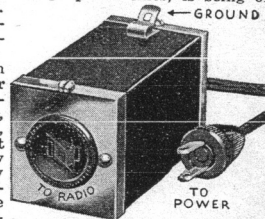

Miller Line Filter #7818



## Radiotorial Comment

(Continued from page 5)

the FCC be instructed to wipe clean the slate of amateur offenders once each year.

And so there is to be no "high-power" resolution from Wallace hereafter. He hopes to have better luck with his pink-slip resolution. So do we—and many other amateurs, too—especially those who have been embarrassed by the receipt of a pink plaster from Washington. Perhaps an offending amateur scrubbed his crystal so thoroughly that enough kilocycles were rubbed into the crystal to cause the signals to sneak-up too close to some of those V-wheel commercials who squat in some of the wide open spaces which once were our very own (until "our authorized representatives relinquished them for commercial development"). ...— ...— ...—

### "W"-Men

● A few years ago, many amateur leaders throughout the United States were solidly behind one K. B. Warner of Hartford. These "W"-Men (Warner men) spread the "loyalty-to-Hartford" message far and wide. Hartford could do no wrong. It was Simon-pure; it was the roost where the angels sat, harp in hand . . . the amateurs goose-stepping to a jolly tune. As the two-dollars-and-fifty-cent pieces came rolling in, Warner bit a chunk out of each collection in the form of a membership dues commission which he kept for himself.

Then came RADIO's scorching denunciation of the Hartford machine. So plain were the facts that even the young school boy was made to understand. He was told how K. B. Warner collected more than forty thousand dollars in commissions from memberships paid by ARRL members . . . forty thousand dollars (and more) over and above his salary! The members did NOT vote to pay this commission to Warner. They were not asked to vote. Where is the answer to the oft-repeated request that Warner show proof that he received prior approval of the board of directors to take this commission money from the ARRL treasury? Why does not the ARRL Investigating Committee look into this matter? Why is it possible, even at this writing, for "any person interested in amateur radio" . . . licensed OR NOT . . . to be eligible for membership in ARRL? Even an undertaker has an interest in amateur radio; he buries the amateur who dies. Thus he, too, is eligible for membership in ARRL. And the commercial man who hates the very mention of the word amateur . . . the man who is FIGHTING the amateur . . . ready to kick him off of the air at the first opportunity, is also "interested in amateur radio", is he not? His interest, however, is on the side of the undertaker; yet he is eligible for membership in ARRL . . . an AMATEUR'S LEAGUE! But . . . get this point: Warner received a commission of 25c on each yearly membership dues, and the more people who joined the league, the more money he made. However, there is still time to make the ARRL a league of none but Licensed U. S. Radio Amateurs! The Investigating Committee can so recommend . . . the Board of Directors can so declare.

If only a licensed U. S. radio amateur is given membership in ARRL, the income to the ARRL will NOT be impaired; anybody, anywhere, can still continue to subscribe to QST as a mere subscriber at \$2.50 per year. But ONLY a licensed U. S. radio amateur should be entitled to MEMBERSHIP! Then we will have a league that should never belie its name.

# The New '5D' Superhet!

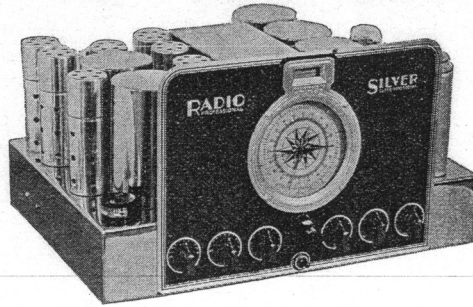

... We Believe It's  
the Finest Amateur  
Set Built Today!

No single important new engineering feature has been overlooked in designing the 5D. We know it has more

valuable features than any other professional communication receiver offered at anywhere near its price. It's the ideal receiver for amateurs.

Available from your jobber, the fully laboratory-assembled and tested 5D, complete with ten Raytheon tubes, Blyley crystal and Jensen loud speaker, RCA and Hazeltine licensed, is priced at \$114.00 net to amateurs.

Send coupon for free descriptive circular, or enclose 10c for 32-page manual of design, construction and operation.

### These Features Tell Some of the 5d Story:

- No plug in coils — efficient band switching and send-receive switch.
- Two tuned r.f. stages on all four bands.
- Low C tuned circuits — all circuits air trimmed and tuned.
- Blyley crystal filter for single signal C.W. and super-selective phone reception without loss of volume.
- Accurately relogging band spread anywhere in its tuning range—hundreds of degrees for each amateur band.
- Covers all five amateur 10, 20, 40, 80 and 160 meter and all S.W. broadcast bands—9 to 175 meters.
- Almost no inherent noise—the quietest yet most sensitive set you've ever operated.
- Sensitivity better than 1 microvolt at all points of all bands.
- Selectivity, just what you want, variable iron-core and air-tuned i.f. transformers.
- Tone what you want—from single signal "peaked audio" to fine broadcast quality.
- Ten new Raytheon 6.3 volt tubes—with 12 tube functions!
- "R" or sensitivity meter.
- All AC operated in one unit with no hum.
- 8" matched Jensen dynamic speaker.
- Polished chromium finish on heavy welded steel chassis fully shielded and temperature isolated for 100% frequency stability.

### NEW PARTS



17E - 500 Ma.  
1 Kw. R.F.  
Choke

An extremely efficient plate choke capable of carrying 500 ma. continuously at 2000 volts or more for 10 to 160 amateur bands. Has D.C. resistance of 15 ohm, inductance 2.5 m.h., distributed capacity approximately 2 mmf. Provided with two terminal lugs and one mounting screw, net to amateurs 96c.

### 17G Crystal Auto Transformer and Shield

Designed to materially increase gain and improve performance in single-signal superhets by providing proper crystal impedance match. Requires no circuit tuning adjustment. Supplied with aluminum shield, mounting screws, grid lead and grid clip. Net to amateurs, 60c.

### 6F Steatite Socket for RK-28—RCA 803

Meets the need for a low loss but inexpensive socket for the new large five-pin transmitting tubes. Steatite base with large spring steel reinforced contacts with soldering lugs and two mounting holes on a 2" diameter. May be mounted above or below chassis. Net price to amateurs 90c.

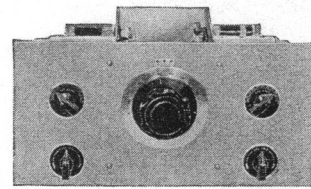

### Jones-Silver "Super Gainer" Three Tube Superheterodyne

Designed by Frank Jones, technical editor, "RADIO," and McMurdo Silver. The three tube Super Gainer with double R.F. and I.F. regeneration gives results almost equalling those of expensive factory built superhets.

Its sensitivity is unlimited, exceeding even that of the highest priced receivers. Its selectivity is controllable—anything up to practically single-signal.

The circuit uses a 6C6 regenerative first detector, 76 H.F. oscillator and 79 as regenerative second detector and audio stage with Aladdin iron core I.F. transformer. The mechanical assembly is of the most advanced communication type, with all parts arranged for the shortest direct leads for wiring. It will immediately give results no other set at its price can touch.

Price, fully assembled, wired and tested, with one pair of coils for 80 meter amateur and 49 meter broadcast, \$23.40 net.

Add for four additional pairs of coils to cover 10, 20, 40 and 160 meter amateur and all short wave broadcast bands, \$4.50 net.

Add for resistor, cord and plug, two electrolytic condensers and choke for complete A.C. or D.C. operation, \$4.50 net.

McMurdo Silver Corporation  
3362 N. Paulina Street, Chicago, Illinois  
 Enclosed 10c for 32-page Manual of Design, Construction and Operation of new 5D Superhet.  
 Send free circulars on the new 5D and Jones-Silver "Super Gainer."

Name .....

Address .....

City..... State.....

10-RM

**McMURDO SILVER CORPORATION** Division of  
G.P.H., Inc.  
3362 N. Paulina St. Chicago, U. S. A.

### DIP or BRUSH R.F. COMPONENTS with

#### Q-MAX No. 3

The only Victron base R.F. Coating

Do not destroy the efficiency of your apparatus by the use of ordinary lacquers never intended for high frequency service. USE Q-MAX No. 3. \$.25 per can at your dealer's store.

Communication Products, Inc.

245 Custer Avenue Jersey City, N. J.

## ENGRAVING

Instrument Panels Exclusively Since 1925  
Bakelite Nameplates. List on request.

A. L. WOODY

189 W. Madison St. Chicago, Ill.

## Surge-Proof ELECTROLYTICS

The new AEROVOX wet type electrolytics offer interesting possibilities in amateur radio work. Particularly because of high capacity and voltage ratings, minimum bulk, and the ability to take punishment.

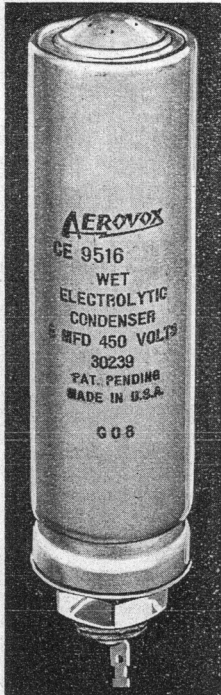

Cost less than other types of electrolytics for given capacity and voltage rating.

Compact, neat, positively leak-proof and seepage-proof.

Unique Aerovox vent at top provides instant escape for any gas pressure, yet effectively seals container against leakage of liquid electrolyte.

Operated in convenient vertical position. Connections and mounting at bottom.

Popular for ability to take extreme voltage overloads, breaking down momentarily but immediately re-healing and as good as new.

Undamaged by freezing temperatures. Unaffected by high operating temperatures. Exceptional life.

These wet electrolytics are being used by enterprising "hams" in combination with other type condensers as a safety valve against surge voltages. Also used in power filter circuits. And wherever condensers "must take it!"

**DATA:** Send for latest catalog covering complete condenser and resistor line. Also sample copy of monthly Research Worker. Your local supply house can show you the Aerovox line.

# AEROVOX

CORPORATION

84 Washington St.

Brooklyn, N. Y.



## SANGAMO

Accurate  
Condensers

A quality product for the amateur who wants the best results. Available in 1000, 2500, and 5000 volt construction.

Write for catalog sheet

SANGAMO ELECTRIC CO.  
SPRINGFIELD, ILLINOIS

RADIO CLUBS . . . Write for Special  
Group Rates for "RADIO"

## The "Super Gainer"

(Continued from page 10)

lation at the IF frequency plus or minus 1000 cycles. This coil is not critical.

Lining-up this receiver is like lining-up any other S.S. set, in that the crystal frequency must be known, or it can be used as an oscillator to line up the IF transformers to that frequency. A calibrated modulated all-wave test oscillator is needed for aligning the coils and tuning condensers over each band. The coil data is listed in the table on page 10.

## "The Radio Amateur Newcomer"

A New Book by Frank C. Jones

Now on the press  
25 Cents Per Copy

Dealers and Jobbers Wanted  
Write to FRANK C. JONES  
422 Pacific Bldg., San Francisco, Calif.

## If you need any of the following Items buy them from W8DED

Who Has Been an Active Ham for Over Ten Years  
QSL CARDS "W8DED PRINT" World's finest! Stamp for samples and prices. CALLBOOKS (W9FO) with all U. S. & Foreign QRA's! Latest, \$1.25. QST SUBSCRIPTIONS (new and renewals) send yours through W8DED. \$2.50 year. RADIO magazine SUBSCRIPTIONS (write for big money saving offer from W8DED). HANDBOOKS (RADIO or ARRL) you need them both. \$1 each. Both \$1.75. BILEY XTALS (within 3.5 or 7 MC. within 5 kc or less if you QRX) WITH HOLDER \$3.95. LIFETIME MIKES!! (Finest for the price—write for free catalog from W8DED). STATION CARDS! 7x11, 2 colors, 2 for 40c.

Send this ad along with your order and get a 7x11 station card FREE! Your call in red type.

Mail All Orders Direct to Rus Sakers, W8DED  
53 EAST 7th ST., HOLLAND, MICH.



## Radio Amateur Call Book

The only radio callbook published that lists all radio amateur stations throughout the entire World.

Also a complete list of high frequency commercial stations, International abbreviations and amateur prefixes, "Q, R, & T," systems for reporting signals, new US inspection districts and high frequency time, press and weather schedules.

Each copy contains a double post card addressed to the CALLBOOK for use in reporting your new QRA. We are extremely anxious to publish a callbook that will be 100% correct and want you to help us by checking your QRA at once in the latest edition and advise us of any errors.

PUBLISHED QUARTERLY MARCH, JUNE, SEPTEMBER AND DECEMBER

Single Copies \$1.25  
Annual Subscription USA, \$4.00

Order your copy today from your local radio jobber or direct from:

Radio Amateur Call Book, Inc.  
600 South Dearborn St. Chicago, Ill.

## New

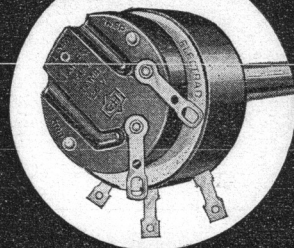

## ELECTRAD VOLUME CONTROL

## With Smooth, Long-Lived CARBON RESISTANCE

A RADICALLY improved type of carbon volume control, with exclusive mechanical features, which is registering a huge success in the service field.

Individually tested at the factory for noise, the longer you use it the smoother it operates. Molded Bakelite case, when mounted, extends only 1/2 inch back-panel. New-type power switch (approved by underwriters) may be instantly attached or removed by a single screw. Long, easy-to-cut aluminum shaft. All standard and special values.

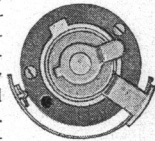

Carbon resistance element fused to flat outer rim of Bakelite ring, over which a special-alloy floating contact shoe gently glides.

Mail Coupon for FREE  
Descriptive Folder and  
General Catalog.

175 Varick St., New York, N.Y.  
**ELECTRAD**

1935 CATALOG

ELECTRAD, Inc.

175 Varick St.  
New York, N. Y.

Please send new Resistor Catalog  
... Check here for folder on new  
QUIET Volume Control.

Name.....  
Address.....  
.....PR-10

## Hammarlund Develops Guide Groove Isolantite Socket

Another interesting development—a high frequency socket with a circular "Guide-Groove"—has just been completed in the laboratories of the Hammarlund Manufacturing Company, Inc., 424 W. 33rd St., New York City.

The lowest loss, strongest Isolantite made—grade "B-100" substance—is used exclusively. The top and sides of the socket are glazed and underneath it is "Ceresin" treated to afford highest surface resistivity and prevent moisture absorption. A new method of prong anchorage is used. The prongs are gripped in square insets. With this new grip, the contact cannot twist, loosen, or shift its position with changes in temperature or humidity. Long leakage paths are also assured with these new positive side gripping contacts. Soldering is simplified by the extremely long semi-looped contacts. This unusual construction also guarantees a sturdy connection.

The new circular "Guide-Groove" feature not only makes insertion easier, but prevents any errors in tube installation. These new sockets are made in 4, 5, 6, and 7 prong style with a large and small base 7 prong type available, too.



**BE UP-TO-THE-MINUTE!**

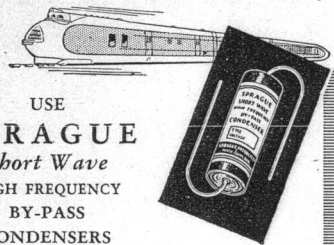

USE  
**SPRAGUE**  
Short Wave  
HIGH FREQUENCY  
BY-PASS  
CONDENSERS

*The Ideal Mica Replacement—Oil Impregnated*  
IF YOU HAVEN'T TRIED these popular Sprague units, you're missing a real treat! Guaranteed as excellent mica substitutes for Short Wave by-passing and many other uses. Smaller than mica—cost far less—and you can't break them down. Metal encased, non-inductive, low power factor, oil impregnated, 1500 V. and 1000 V. continuous D. C. rating. See them at your jobbers or write for complete "600" Line catalog including famous Sprague Oil Transmitting Condensers. Ask for FREE BOOKLET "Condenser Facts." SPRAGUE PRODUCTS CO., North Adams, Mass.

**SPRAGUE CONDENSERS**  
SPRAGUE 600 LINE

**RADIO CLUBS**

Special Group Subscription Rates are offered if 5 or more members subscribe at one time. Write for rates. "RADIO," Pacific Bldg., San Francisco, Calif.

**BUILD** This Great **PROFESSIONAL RECEIVER.**  
**AMATEURS-S.W. LISTENERS!**  
SAVE over **50%**

9 TO 200 METER  
H. F. SUPERHET

The new RADIO-SILVER 10 Tube Communications Superhet Kit. Designed by the Technical Staff of "RADIO", together with McMurdo Silver and 15 leading radio parts makers. A precision job for laboratory building. You wire with made-up colored cable. Start for as little as \$7.30—buy the parts as you build. Features air-tuned Polyiron I.F.'s; separate R.F. coils for each band, air-trimmed; 1 MV absolute sensitivity; crystal filter; bandspread tuning; 4 bands—2 tuned RF stages on each, etc.—all for less than half the cost of a factory-built set.

**FREE** Send for FREE 6-page circular describing the new RADIO-SILVER Superhet. For 32-page "How-to-build-it" book, including diagrams, etc., send 10c.

**ALLIED RADIO**

ALLIED RADIO CORPORATION  
833 Jackson Blvd., Chicago, Dept. J.  
 Send me FREE Radio-Silver Kit circular.  
 Find 10c enclosed for "How-to-build-it" book.

Name.....  
Address.....

COMPLETE DESIGNS of  
**20**  
TRANSMITTERS

12 tested transmitter R. F. section designs! 8 modulator and speech amplifier designs!

Outputs ranging from a little fellow on which the O.W. can learn, to big ones comparing in every way with the best broadcaster.

Circuit, and complete parts specifications of transformers, inductances, and all other component parts.

One of the most complete and thorough handbooks on transmitter design ever printed!

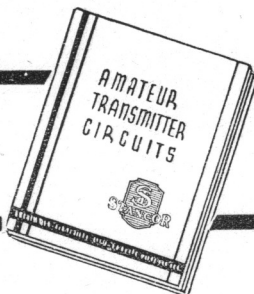

**FREE!**  
VALUABLE  
REFERENCE BOOK

This advertisement and 12c IN STAMPS, to cover mailing expenses, will bring your FREE copy of this valuable Reference Book. There is no obligation.

**STANDARD TRANSFORMER CORP.**



855  
Blackhawk  
Street  
Chicago Ill.

**Sh! — Silence!**

That's what some members of the family would like to tell you, but out of consideration for your enthusiasm they hold back.

**CANNON BALL HEADSETS**

You will get clearer reception of all foreign programs and you will not disturb the rest of the family.

Made by America's oldest manufacturer of headsets

Heavy bar magnets, double pole, aluminum cases, D. C. resistances of 2000, 3000 and 5000 ohms.

Sturdy construction, sensitive and faithful in reproduction.

Sold everywhere in America

**C. F. CANNON CO.**  
SPRINGWATER, N. Y.

*Revolutionary*  
New Efficiency  
Increased Selectivity  
Highest Quality  
Plug-in Installation  
Lifetime Service

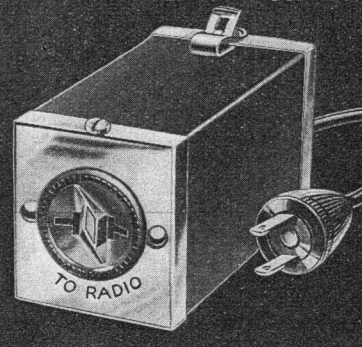

**LINE FILTER**

No. 7818 \$4.00

This sensational new Miller Line Filter positively eliminates all line noises. Use it to prevent crackling and sizzling in your radio not removed by "noiseless" antenna systems which is due to household appliances, motors and high-frequency disturbance pickup from power lines. Requires no adjustment or attention.

Exclusively combines both inductive and capacitive filtering, with the famous Miller duo-lateral wound choke, and impregnated paper dielectric condensers.

More efficient than any filter on the market and built to the Miller standard, the price is doubly sensational...\$4.00 complete in handsome chromium and black Kem-Art metal case with approved rubber cord and unbreakable plug. Shipping weight 16 ozs.

Beat the demand. Order now from your dealer or write



**J. W. MILLER CO.**

5917 So. Main St., LOS ANGELES, CAL.

**REMOVAL NOTICE!**

**LEW BONN CO.**

Moves to a New Location . . .

1124-26 HARMON PLACE  
MINNEAPOLIS, MINN.

Phone Nestor 6365

A branch store will also be opened at  
506 Robert St., St. Paul, Minn.

# DYKANOL

"Hey, hold on! Put me down for a couple!"

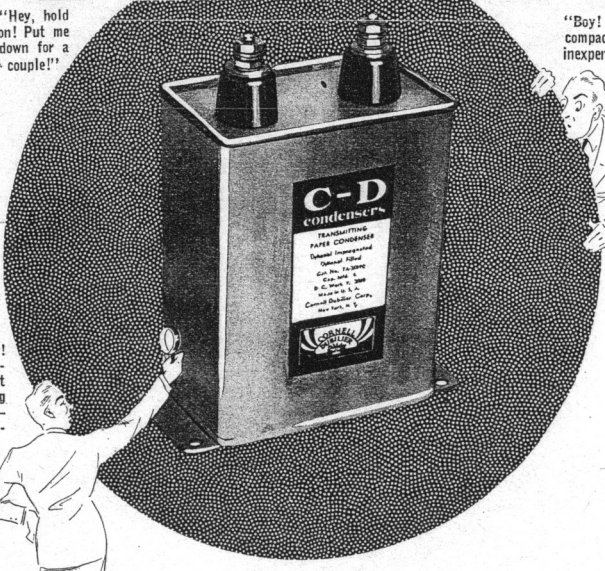

"Boy! That's a compact job, and inexpensive too."

"Good Gosh! Here's a condenser I can't find a thing wrong with—it's got everything."

## A PRODUCT OF CORNELL DUBILIER

Nation's leading jobbers are featuring Dykanol transmitting condensers, because of their world-wide acceptance.

Broadcasting stations depend on C-D Dykanol transmitting condensers, government departments specify them in their blueprints, and the largest manufacturers of transmitting equipment incorporate Dykanol condensers in their design.

- Dykanol condensers can be operated continuously at voltages up to 10% above their rating.
- Dykanol is non-flammable, eliminating all fire hazards.
- Dykanol condensers are hermetically sealed in steel containers.
- Dykanol oil impregnated and oil filled condensers are most inexpensive.

Get the detailed dope on these condensers from your local C-D jobber or write for descriptive catalog #128.

## CORNELL-DUBILIER

C O R P O R A T I O N

4372 BRONX BOULEVARD  
NEW YORK

## CALL TRIMM

when you need help with your Ear-  
phone problems. A phone for every  
conceivable use. Impedance values  
from 1 to 100,000 ohms.

Your Jobber Can Supply You

**TRIMM** RADIO MFG. CO.  
1528 Armitage, Chicago, Ill.

REPLACEMENTS FOR  
**REGULATORS!**

There's an  
**AMPERITE**  
CURRENT OR VOLTAGE  
**REGULATOR**  
for every current or  
voltage problem ...  
in any set.

Write for CHART CV 2

**AMPERITE Co.** 561 BROADWAY NEW YORK

FORMS CLOSE ON THE 10th OF MONTH

RATES 10¢ PER WORD PAYABLE IN ADVANCE

**CLASSIFIED**  
**RADIOADS**

**TRANSFORMERS:** Power and modulation, filter chokes, etc., to order. Guaranteed 12 months. Reasonable. California Radio Laboratories, W6CYQ, 2523 South Hill Street, Los Angeles, California.

National SW-5, complete \$10.00. Oscillator—Amplifier 210's final xtal controlled, complete \$25.00. Adams, 236 Landis, Vineland, N. J.

QSL'S! SWL'S! SEND FOR SAMPLES! REDUCED PRICES! B. & B. PRESS, 2009 FREMONT ST., CHICAGO.

JONES 5-Meter Superheterodyne, 7 tubes, AC operated, with built-in loudspeaker, black crackle metal cabinet, complete with built-in power supply and tubes, will sell for \$39.00, which represents net wholesale cost of parts. Also 4-tube Jones Super Gainer crystal superheterodyne, as described in this issue of "RADIO", complete with tubes, but without power supply, cabinet or crystal. Laboratory model, with coils for any two bands selected, exactly as shown in this issue, \$20.00. 60-watt 75-meter Grid Modulated phone transmitter, with two W.E. 211-D tubes in final, complete with tubes, but less power supply and crystal. Described in September issue of "RADIO" by Henry Williams, will sell for \$30.00. One 4 stage speech amplifier and modulator, using four 46s in final, to plate modulate 160 watts of RF, and capable of supplying over 75 watts of audio on speech when used with two-button mike. Best parts used throughout. Will sell for \$39.00, which does not include power pack or microphone, but including all tubes. Frank C. Jones, 2037 Durant Avenue, Berkeley, California.

## MILLIONS IN USE

- Two Year Guarantee
- Low Power Factor
- Long Life
- Self Healing
- Efficient and Compact
- Patented and Patents Pending



The superior quality and performance of millions of Duco Condensers are recognized all over the world.

NOW GUARANTEED FOR 2 YEARS

Manufactured by

**DUMONT ELECTRIC COMPANY, Inc.**

514 Broadway New York, N. Y.

Write for free Catalogs, Sales and Jobber Territory

## new! KELLOGG TRANSCIEVER HANDSET

A better all-around Transceiver Handset! Highly efficient single-button Kellogg microphone, super-sensitive Kellogg receiver. Easy to hold. Fits the face. • Microphone has greater sensitivity and "flatter" response curve than the usual "mike" of this type. Precision built, as are all Kellogg products. Gold plated diaphragm. Especially processed carbon. • Receiver is the product of 35 years experience building telephone apparatus. Bi-polar magnet of cobalt steel. Cadmium plated diaphragm. Small, compact, easy on the ear. • Simply and ruggedly constructed and light weight. Cast aluminum triangular handle. Baked black enamel finish. Has 6-foot, 4-conductor, 18-strand tinsel cord of telephone quality. • You will be proud to own this unit. Better yet, it's not expensive. Code No. 38-A, 70 ohm receiver, list price \$10.00. Code No. 38-B, 2000 ohm receiver, list price \$11.

**KELLOGG SWITCHBOARD & SUPPLY CO.**  
1070 W. Adams St. CHICAGO, ILLINOIS



# HAMMARLUND

## XP-53 FORMS

- 1 NEW XP-53 DIELECTRIC—  
NATURAL COLOR—  
LOW LOSS
- 2 GROOVE RIBS—  
AIR SPACED WINDINGS—  
CORRECT FORM FACTOR
- 3 GREATER SIGNAL  
STRENGTH—MORE  
SELECTIVITY
- 4 FLANGE GRIPS—METER  
INDEXES—EASY DRILLING
- 5 4, 5 AND 6 PRONGS
- 6 LOW COST!

Write Dept. PR-10  
For General Catalog

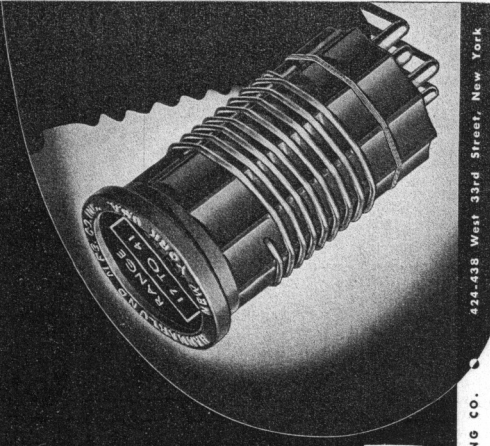

HAMMARLUND MANUFACTURING CO.

CANADIAN OFFICE, 41 WEST AVENUE, NORTH HAMILTON, ONTARIO  
424-438 West 33rd Street, New York

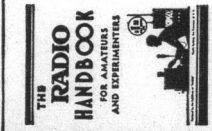

This Handbook by  
"RADIO" is Your Guide  
to Better Radio

It begins at the beginning, tells you how to make the most of your equipment, the SOUND system. Tells how to build any kind of an amateur or short-wave receiver, from a 1 tube to a 12 tube de luxe crystal filter superheterodyne. Tells how to build any kind of a c.w. or phone transmitter. Tells how to build a dozen kinds of ultra-high frequency transmitters, receivers, transmitters, Many charts, tables, formulae. New tube characteristics. Data on metal tubes. Laboratory test equipment. 300 pages.

### YOUR NEW AUTHORITY

The Handbook by "RADIO"  
300 PAGES

Largest, Newest, Most Complete Book of Its Kind

AMATEURS everywhere are talking about the great, new Handbook by "RADIO" for amateurs. "It's the best thing I've ever seen," says one. "Something different, something NEW . . . something modern!" "It's the latest word," they say. The new high-power pentode transmitters are shown . . . the new theory on radio and electricity is creating wide comment . . . the complete chapters on antennas, radiotelephony, modern c.w., transmitters, ultra-high frequency receivers, etc., etc. So, if you've ever thought an advance of considerable value to you, your dealer cannot supply you, order direct from the publisher.

Immediate Deliveries  
SEND YOUR ORDER TODAY!

**\$1.00** PER COPY  
POSTPAID

—RADIO—  
Pacific Building • San Francisco, Calif.

## O. K. Silver!

● Congratulations on the Silver 'RADIO' with Aladdin Polyiron IF Coils, Types 5A and 5B—

★ ★ ★

Three tubes do the work of five in the

"SUPER GAINER 3" due to an Aladdin Polyiron High Gain IF Transformer

Jobbers—Dealers—Amateurs,  
Write for full details!

Radio **Aladdin** Industries  
TRADE MARK

466 W. SUPERIOR ST. CHICAGO, ILL.





THE **NEW** in RADIO • AND **ALL** THAT IS **NEW!**

*The New 1936*  
**CROSLEY** *Line*

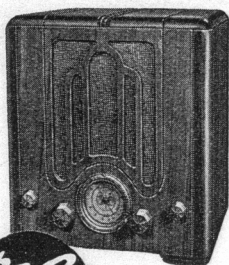

**\$19.99**

**THE CROSLEY FIVER**  
Table and Console

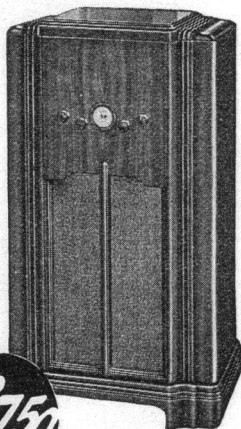

**\$37.50**

**CHASSIS**—Five-tube superheterodyne. Two bands—Standard and police, amateur, aviation broadcasts. Illuminated full-vision airplane type dial—5 to 1 ratio drive. Tone control. New 6B5 Triple-Twin output tube. Full floating moving coil electro-dynamic speaker.

**CABINETS**—Half an eye can see their beauty and charm—equal in every way to their superb tone. Between these and the Constitution models are a full range of receivers for every purse and type of use.

From the Fiver, giving standard, police, aviation, amateur reception for \$19.99 to the **CONSTITUTION** five-band metal tube all-wave that gets virtually all that's on the air . . . the new Crosley 1936 Line leads the field. In every price range the Crosley gives more for the money in beauty, performance, selectivity . . . in everything that makes for radio satisfaction.

**FEATURES!** Innovations! Master-strokes of engineering. In this new 1936 radio line Crosley has tapped all the resources of experience dating back to the pioneering stage; all the creativeness and inventiveness of today. Never has a line so stepped out to capture the imagination of a country. Never a line with so many "want-able" features. Never a line with equal value for the radio dollar.

The beauty of the line is alone an eye-stopper anywhere. But the more you explain the in-built quality, the new features, the reason for the extraordinary tone, selectivity, truthfulness of reproduction . . . the more your customers will select—from this line—the set that best fits their means and their wants.

Everywhere the groundwork of SALES is being laid with this line. Get in on this from the start by getting in touch with your Crosley distributor.

**THE CROSLEY RADIO CORPORATION**

CINCINNATI POWEL CROSLEY, Jr., President  
Home of "the Nation's Station"—WLW—500,000 watts  
—most powerful in the world—70 on your dial.

Prices in Florida, Rocky Mountain States and West slightly higher.

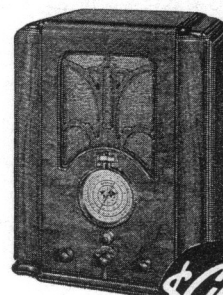

**\$19.99**

**THE CROSLEY CONSTITUTION**  
Table and Console

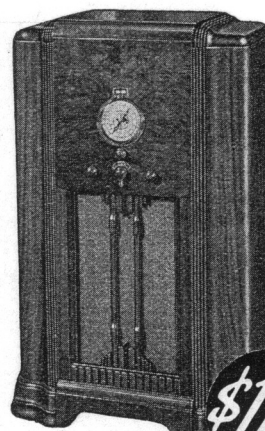

**\$77.50**

**CHASSIS**

This all-wave 10-tube superheterodyne using all-metal tubes, commands the air. Five bands, receiving American, foreign, weather, amateur, police, aviation broadcasts. Shadow tuning. Automatic volume control. Full-vision airplane type dial. Tone control. Dual ratio tuning control. Full floating moving coil electro-dynamic speaker.

**AMONG THE FEATURES...**

Three-gang tuning condenser with many notable improvements.

New velvet action two-speed dial—planetary ball-bearing drive.

New high-wattage, metal-to-metal tone control—far superior to conventional tone control.

New triple-tuned I. F. transformer—far better selectivity, higher fidelity.

New H-Q-4-layer bank wound Litzendraht broadcast coils—providing better signal-to-noise ratio.

All-metal tube and all-glass tube models—a set for every need.

NEW SHADOW TUNING. NEW 5-COLOR AIRPLANE DIAL.

NEW COLOR-BAND DESIGNATION.

*You're there* WITH **CROSLEY**



# UTC sets a new precedent for Wide Range High Fidelity Transformers

LINEAR STANDARD and HIPERM ALLOY audio transformers individually calibrated and guaranteed to be  $\pm 1$  db from 30 cycles to 20,000 cycles.

All pertinent technical data and frequency response in db indelibly imprinted on outer transformer shield for customer's protection.

## LINEAR STANDARD AUDIO COMPONENTS



The LS-10, illustrated, is an input transformer designed to match variable input lines of 500, 333, 250, 200, 125 or 50 ohms to a single grid. Overall impedance of secondary windings 60,000 ohms, impedance of each winding 15,000 ohms. The multiple tap windings used on the LS-10 input coil are an original and exclusive UTC coil structure development. A wide combination of impedance connections is made possible without impairing the audio range or efficiency of each unit. UTC was first to develop the hum bucking coil structure used on the LS-10. All linear standard audio units are housed in heavy high permeability shields which afford a ratio of shielding (permeability) which is five times as great as the usual cast iron housings used for shielding input coils. All UTC LS units are designed so that they may be fastened to chassis or rack panel with lugs at top or bottom.

## HIGH FIDELITY HIPERM ALLOY AUDIO COMPONENTS

This new group of transformers, specifically designed for portable use, are extremely compact and light in weight. These high fidelity units are the smallest quality transformers of their class and have only been made possible through the development of HIPERM ALLOY, a nickel iron alloy having extremely high initial permeability. This alloy is not only used for the core material, but also for the inner shield surrounded by the outer case, thus affording a maximum of shielding with a minimum of size and weight. The average weight of each unit is 2 lbs. Another unique feature developed to make possible the small size of these units is the elimination of all extended mounting flanges or feet. These are replaced by simple threaded metal inserts in the case allowing mounting with terminals either up or down, so that the units can be mounted either on a rack panel or metal chassis with no waste space.



UTC HIPERM ALLOY Audio Transformers used in the new

## WOR

30B Portable Amplifiers, specially built for use in remote Pickup broadcasts in conjunction with the WOR high fidelity 50,000 watt transmitter.

## WOR

is also installing the 30B portable amplifier in many celebrated public address installations throughout the New York Metropolitan area.

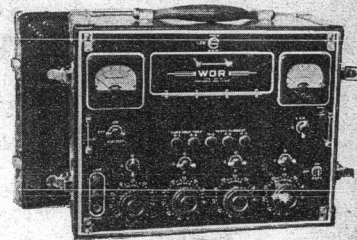

# UNITED TRANSFORMER CORP.

72-78 SPRING STREET

Export Division, 15 Laight St., New York, N. Y.

NEW YORK, N. Y.

Exclusive UTC distributors carrying a complete stock of UTC products.

Goldhamer's, Inc.	610 Huron Road, Cleveland, Ohio	Hall's	35 So. Cameron, Harrisburgh, Penna.
Wholesale Radio Service Co., Inc.	100 Sixth Ave., New York, N. Y.	Herbach & Rademan	438 Market St., Philadelphia, Penna.
Wholesale Radio Service Co., Inc.	219 Central Ave., Newark, N. J.	Cameradio Company	603 Grant Street, Pittsburgh, Pa.
Wholesale Radio Service Co., Inc.	430 W. Peachtree St. N. W., Atlanta, Ga.	W. H. Edwards & Co.	32 Bway, Providence, R. I.
Wholesale Radio Service Co., Inc.	911 Jackson Blvd., Chicago, Ill.	Seattle Radio Supply, Inc.	2319 Second Ave., Seattle, Wash.
Sun Radio	227 Fulton Street, New York, N. Y.	Portland Radio Supply Co.	1300 W. Burnside, Portland, Ore.
Gross Radio, Inc.	51 Vesey Street, New York City	Spokane Radio Co., Inc.	611 First Ave., Spokane, Wash.
Leads	45 Vesey Street, New York City	San Francisco Radio Exchange	1284 Market St., San Francisco, Calif.
South West Radio Supply	107 South St. Paul St., Dallas, Texas		
Mohawk Electric Co.	1335 State St., Schenectady, N. Y.		
Walter Ashe	1100 Pine St., St. Louis, Mo.		
Radio Shack	46 Brattle St., Boston, Mass.		
Harvey's Radio	105 W. 43rd St., New York, N. Y.		
United Radio Service	616 Main St., Hartford, Conn.		
Hatry & Young	203 Ann St., Hartford, Conn.		
Marine Radio Co.	124-13 101st Avenue, Richmond Hill, N. Y.		

### SOUTHERN CALIFORNIA

Pacific Radio Exchange Inc.	729 S. Main St., Los Angeles
Radio Supply Co.	912-14 S. Broadway, Los Angeles
Coast Electric Co.	744 G. St., San Diego
Frest & Dean Radio Co.	400 American Avenue, Long Beach
Radio Television Supply Co.	1701 S. Grand Ave., Los Angeles, Calif.
Radio Specialties Co.	1516 West 8th St., Los Angeles, Calif.