

No. 173

20p

Practical Transistor Audio Amplifiers for the Home Constructor

Book 1

by

CLIVE SINCLAIR

Full Circuits for Preamplifiers and Power Amplifiers.

Thirty-two Diagrams and Plans.

Complete Building Data.

Design Suggestions.

Biasing and Power Supplies.

BERNARDS RADIO MANUALS

**Practical Transistor
Audio Amplifiers
for the Home Constructor**

Book 1

by

CLIVE SINCLAIR

**BERNARDS (PUBLISHERS) LTD.
THE GRAMPIANS
WESTERN GATE
LONDON W.6**

FIRST PUBLISHED OCTOBER 1961
REPRINTED FEBRUARY 1962
REPRINTED MARCH 1963
REPRINTED SEPTEMBER 1964
REPRINTED APRIL 1965
REPRINTED MAY 1967
REPRINTED NOVEMBER 1968
REPRINTED JANUARY 1970
REPRINTED AUGUST 1971
REPRINTED NOVEMBER 1972

We invite all authors, whether new or well established, to submit manuscripts for publication. The manuscripts may deal with any facet of electronics but should always be practical. Any circuit diagrams that may be included should have been thoroughly checked by the author. If you are considering trying your hand at writing this type of book we suggest that you let us have a short summary of the subject you intend to cover. We will then be able to let you know the size of book required and perhaps give you some advice on presentation.

I.S.B.N. 0 900162 19 8

© 1961

Printed by Krisson Printing Limited, 184 Acton Lane, London N.W.10
for Bernards (Publishers) Ltd., The Grampians, Western Gate, London, W.6

LIST OF ILLUSTRATIONS

CONTENTS

Chapter 1	Biassing and Stabilization
Chapter 2	Interstage Coupling
Chapter 3	Transistor Preamplifiers
Chapter 4	Power Output Stages

CHAPTER 1

Biasing and Stabilization

A transistor has to be supplied with the correct power if it is to operate efficiently and provide maximum gain with minimum distortion. Since the parameters of a transistor vary with temperature and tune the power supply must normally be designed to be self compensating, that is to say, the circuit must be stabilized. The need for stabilization is increased by the fact that two transistors of a given type can differ very considerably in their parameters.

A transistor may be operated in any of three modes these being known as common base, common emitter and common collector. In each case the electrode referred to is common to both the input and the output. Since the common emitter mode gives the greatest power gain and does not involve difficult coupling problems it is used most frequently. The common base mode is sometimes used, as far as A.F. amplifiers are concerned, when a high voltage gain is required or when matching a very low to a high impedance. The common collector mode is used mainly as a match between a high output impedance and a low input impedance; it may therefore be used as a matching component between two common emitter stages.

Biasing is normally done as if the transistor were in the common emitter mode, even if it acts as a common base amplifier to A.C. signals, so, to save space and because this subject is so well covered elsewhere, I will concentrate on common emitter biasing.

The simplest form of bias circuit is shown in Fig. 1. The collector current is governed by the values of R_1 and V and the current gain and leakage current of the transistor. Since the resistance between the base and emitter is extremely small, being that of a forward biased junction diode, the current flowing from the base to the emitter is V/R_1 plus the leakage current, the latter being the small current flowing from collector to base which is similar to the current flowing in a reverse biased junction diode. The collector current will then be the base-emitter current multiplied by the current gain or beta of the transistor.

The equation for obtaining the collector current is, therefore :

$$I_c = \frac{BV + I'_{co}}{R_1}$$

Where I_c is the collector current, I'_{co} is the leakage current and B is the common emitter current gain of the amplifier.

Now the trouble with this circuit is that any change in the value of B or I'_{co} will result in a corresponding change in the collector current. At normal room temperature the value of I_{co} is usually small enough to be neglected but as the temperature rises it increases considerably and, in fact, doubles for every rise of about 10°C . This causes a considerable increase in the collector current.

The values of B for two transistors of the same type may differ by as much as 3 : 1 or more. For example, the B of an OC71 might be anything from about 20 to 70. This variation means that changing transistors in the circuit of Fig. 1 without altering the value of R_1 may result in a considerable change in the collector current.

It will be seen then that the type of circuit shown in Fig. 1 can only be used when selection is made for the value of R_1 for each transistor or when the collector current is not at all critical. Such a situation may occur when a simple, low power preamplifier is required in which the gain is not very important but even in this type of case the temperature range which the transistor is subjected to must be limited.

A very simple form of stabilized circuit is shown in Fig. 2. Although the degree of stabilization is insufficient for many applications the circuit is very useful where space is limited and the number of components used must be kept to a minimum. It also has the advantage of being economical but this is not normally significant because of the small number of components involved.

The circuit differs from that of Fig. 1 only in that R_1 is connected to the collector of the transistor instead of to the negative side of the battery. Now if the collector current tends to increase, for

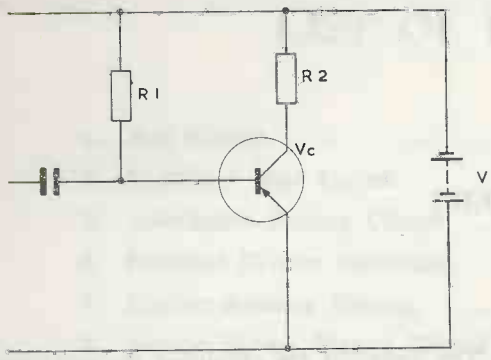

Fig. 1.

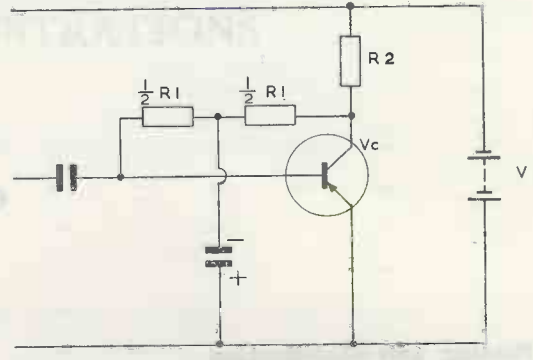

Fig. 3.

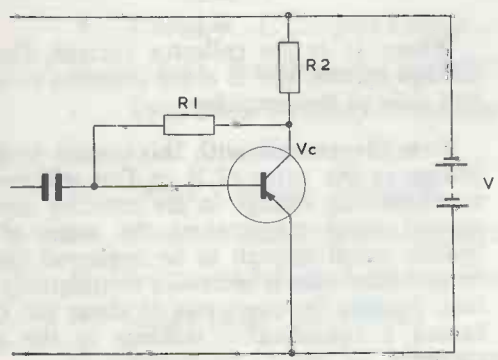

Fig. 2.

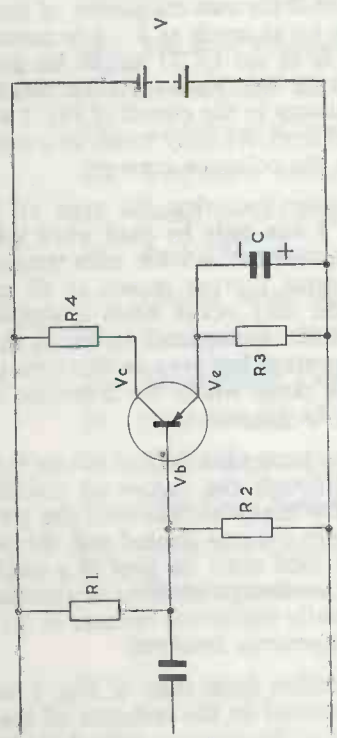
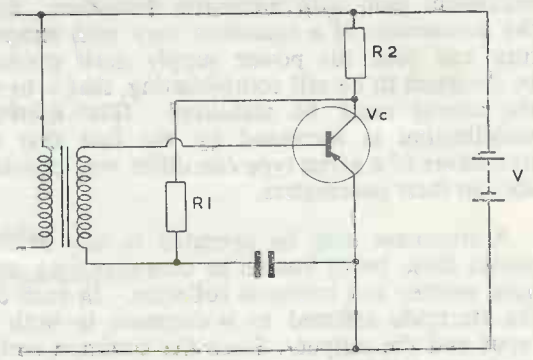

Fig. 4.

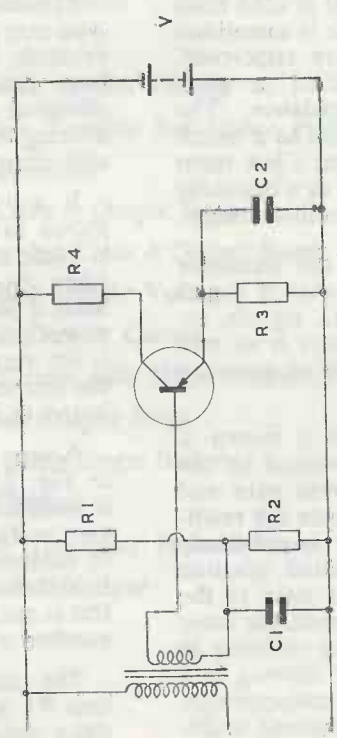
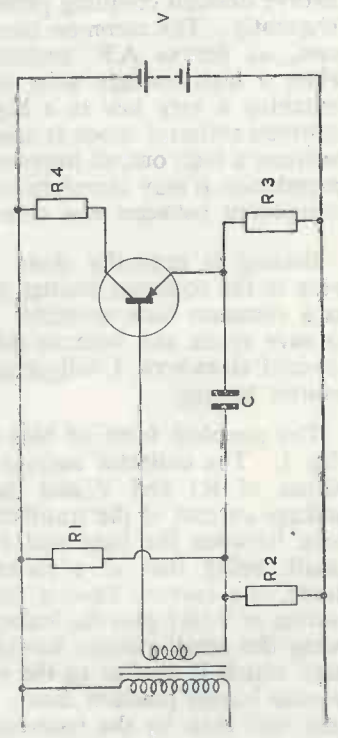

Fig. 5.



any of the reasons given above, V_c will drop, the base emitter current will be lowered proportionately and the collector current will tend to return to its previous value. In other words, although changes in B or I_{co} will still affect the collector current the effect will be considerably less than it would be in Fig. 1 due to the negative feedback between collector and base. This negative feedback, however, applies to an A.C. signal just as much as to D.C. and the gain of the circuit is therefore reduced by an amount proportional to the degree of stabilization achieved. This may be overcome by splitting R_1 into two halves and grounding the junction point to earth, as far as A.F. signals are concerned, by a large value capacitor C . In this case however, the circuit loses much of its attraction because it is no longer noticeably more economical than the conventional form of stabilization described below.

The collector current of the transistors in Fig. 1 and Fig. 2 is given by:

$$I_c = \frac{B(V + I_{co}R_1)}{R_1 + BR_2}$$

The higher the value of R_2 and the lower the value of R_1 the greater will be the stability. In general, the stability of Fig. 2 may twice as great as that of Fig. 1 or, in other words, the change in collector current will be only half as great for a given change in the operating conditions. Even this, however, is insufficient for many circuits and these must use some form of the emitter resistor and potential divider method.

Fig. 4 shows the normal emitter resistor and potential divider method of stabilization. Because of the high degree of stability possible and because of the relative independence of the collector current on the B of the transistor used, this circuit is the one used most frequently.

The base voltage V_b of the transistor is determined by the potential divider across the battery formed by R_1 and R_2 . The value of V_e will always be very nearly that of V_b because if it tended to be much lower the collector and emitter currents would have to be large and this in turn means a high value of V_e . Similarly if V_e were much above V_b the transistor would be reverse biased, the collector and emitter currents would be low and V_e would also be low. For the purposes of calculations, therefore, V_e can be assumed to be the same as V_b . But if the emitter current can easily be determined by Ohm's law if both V_e and R_3 are known and since the collector current is greater than the emitter current only by I_{co} , normally a negligible amount, we can calculate I_c . The significant point about this being that no mention has been made about the current gain of the transistor so that this circuit is virtually independent of it and a very high degree of stability is possible. If we assume that $V_b = V_e$ and

$I_c = I_e$ we obtain the following equations:

$$V_e = V_b = \frac{R_2 V}{R_1 + R_2} \text{ and } I_c = I_E = \frac{V_e}{R_3}$$

combining these results in:

$$I_c = \frac{R_2 V}{R_3(R_1 + R_2)}$$

This equation is not completely accurate, of course, because of the assumptions made, but it is quite sufficient for normal usage.

Since R_3 is in both the input and the output circuits for A.F. as well as D.C. it must be bypassed by a large value capacitor C to prevent negative feedback at audio frequencies.

For maximum stability R_3 should be as high as possible to provide considerable negative D.C. feedback and R_1 and R_2 should be as low as possible to stabilize the base voltage. The limit to R_3 is set by the amount of power one can afford to waste on it. Since R_1 and R_2 are effectively in parallel with the input they cannot be made very low without significant loss of signal. Low values of R_1 and R_2 also cause unnecessary battery drain.

In arriving at approximate values for R_1 , R_2 and R_3 in a circuit the following steps may be taken.

1. Decide what collector current is required and how large V_e may be. V_e will be determined by V and by the required collector swing.
2. From V_e and I_c calculate the value of R_3 .
3. Assuming V_e to be equal to V_b calculate the ratio of R_1 to R_2 . This is obtained from:

$$\frac{V}{V_e} = \frac{R_1 + R_2}{R_2}$$

4. Decide how small $R_1 + R_2$ can be without draining the battery unduly and on the degree of stabilization required. The value of R_2 should lie somewhere between twice and ten times that of R_3 , the former giving the maximum stability.

Fig. 5 shows the emitter resistor method of biasing applied to a transformer coupled stage. The considerations given above in relation to Fig. 4 also apply to this circuit except that since R_1 and R_2 are not connected to the base of the transistor there is no shunting of the input. This means that R_1 and R_2 can be made smaller without loss of gain although, of course, the battery drain will still be increased.

In Fig. 6 a capacitor has been saved by coupling the bottom of the transformer to the emitter. The input signal is then floating but the performance of the circuit is identical to that of Fig. 5.

CHAPTER 2

Interstage Coupling

The coupling between two transistor stages may be made in one of four ways: R-C (resistor - capacitor) coupling, transformer coupling, L-C (choke - capacitor) coupling or direct coupling. Each of these methods has its own particular advantages and disadvantages and to give an impression of these they are listed below.

R - C Coupling

- | | |
|---------------|---|
| Advantages | <ol style="list-style-type: none"> 1. Low distortion. 2. Simple to design. 3. Compact. 4. Economical. |
| Disadvantages | <ol style="list-style-type: none"> 1. Much lower gain than transformer coupling. 2. Higher battery voltage required than with transformer coupling. |

Transformer Coupling

- | | |
|---------------|---|
| Advantages | <ol style="list-style-type: none"> 1. Maximum possible gain. 2. Minimum voltage required. 3. Good stability. |
| Disadvantages | <ol style="list-style-type: none"> 1. Rather high distortion unless a large transformer is used. 2. Bulky. 3. High cost of transformers. |

L - C Coupling

- | | |
|---------------|--|
| Advantages | <ol style="list-style-type: none"> 1. Higher gain than R - C coupling. 2. Lower battery voltage may be used. |
| Disadvantages | <ol style="list-style-type: none"> 1. Higher distortion than R - C coupling. 2. Bulky. 3. More expensive than R - C coupling. |

Direct Coupling

- | | |
|---------------|--|
| Advantages | <ol style="list-style-type: none"> 1. Very economical on components. 2. Very compact. 3. Minimum battery drain. |
| Disadvantages | <ol style="list-style-type: none"> 1. Often tricky to design. 2. Sometimes less stable than other forms of coupling. |

R - C coupling and transformer coupling are used far more frequently than the other two forms and, for this reason, the latter are often neglected. This is undesirable since in certain types of circuits they are better.

Fig. 9 illustrates an ordinary two stage, R-C coupled circuit. There is considerable loss of gain between stages because the output impedance of one stage is 20 times higher than the input impedance of the next and there are no matching components. Losses also occur in the collector resistors, R1 and R2, and in the coupling capacitors C3 and C5 but these are smaller amounting to only 3dB or so per stage. For a transistor having a beta of 30 the power gain per stage will be $\left(\frac{30}{2}\right)^2$ or about 24dB taking into account all losses.

The value of the coupling capacitor C3 will depend upon the lowest frequency the amplifier has to handle. Assuming that the lowest frequency must only be attenuated by 3dB with respect to the higher frequencies, the reactance of C3 at this frequency will be the same as the source impedance which is, in this case, the value of R1. For example, if R1 is 2K and the lowest required frequency is 100 c/s the value of C3 should be 1 microfarad. The value of C4, the decoupling capacitor should be B times the value of C3 which, if B = 30, is 30 microfarads. Naturally, both these capacitors may be made larger than necessary without any ill effects.

When more than two stages are used they should be decoupled from the battery at some point between stages. Rd and Cd form the decoupling components in Fig. 9 and they would be necessary if Tr1 was preceded by one or more similar stages. These components are needed because the internal resistance of the battery rises with age and forms a common load to all stages. When more than two stages are used the common load will result in positive feedback from each stage to the transistor two stages before it. This positive feedback normally causes "motorboat" oscillations but even if actual oscillation does not occur the performance of the amplifier will be degraded because the frequency response is adversely affected by positive feedback. The circumstance under which the decoupling components can be safely omitted is when the battery is composed of mercury cells which have a very low internal resistance which does not increase greatly until the end of the battery's useful life.

A two stage transformer coupled amplifier is shown in Fig. 10. The increased gain of this type of circuit over that of Fig. 9 is due to the fact that the high output impedance of Tr1, about 20K ohms, is efficiently matched to the much lower input impedance of Tr2, about 1 K ohms. This

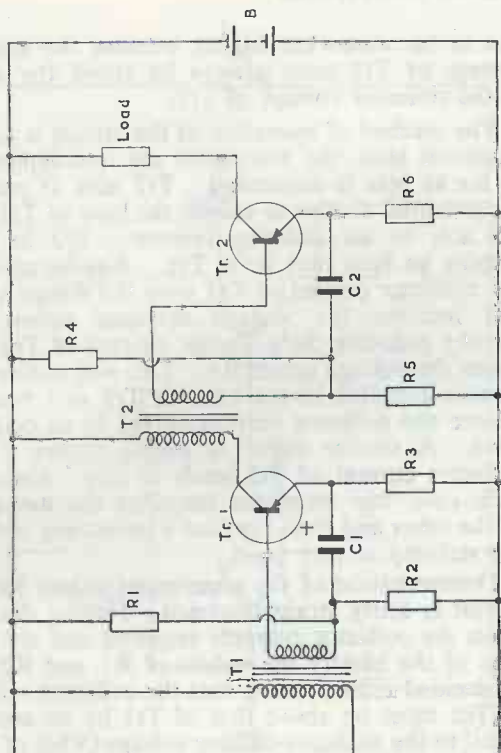

Fig. 10

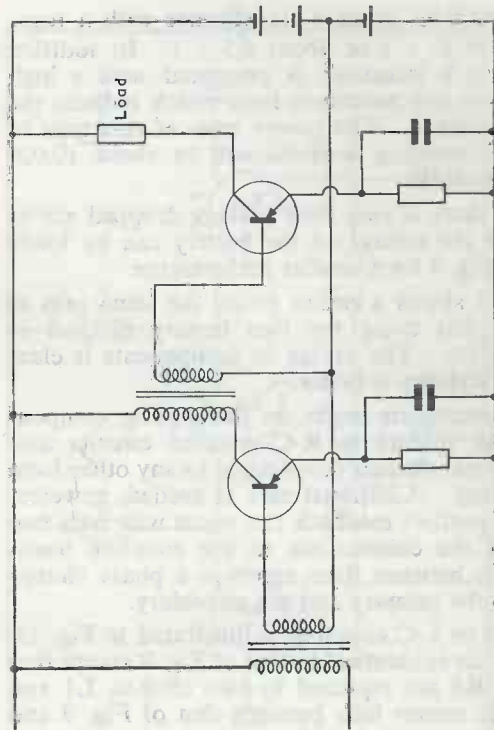

Fig. 11

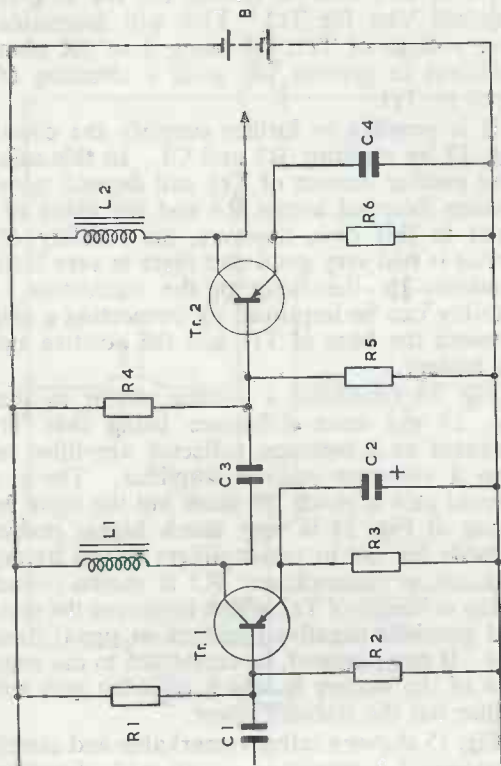

Fig. 12

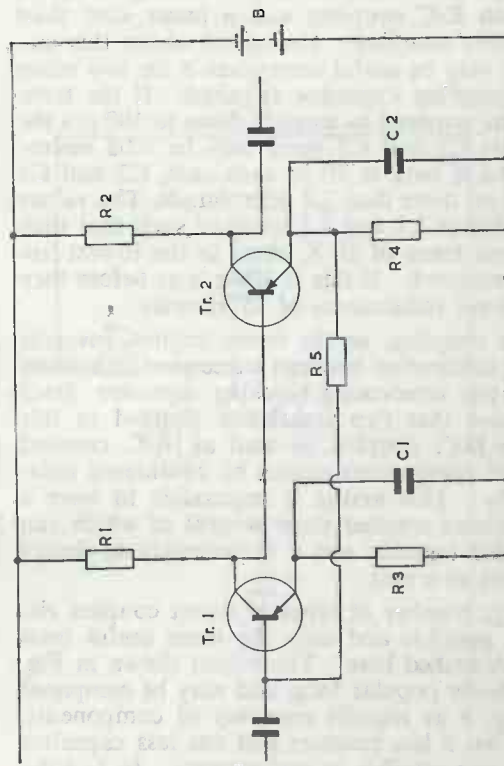

Fig. 13

is achieved by using a transformer with a turns ratio of $\sqrt{20} : 1$ or about 4.5 : 1. In addition to this each transistor is presented with a high impedance low resistance load which reduces the losses incurred. The power gain of this type of stage, assuming a B of 30, will be about 10,000 times or 40dB.

Since there is very little voltage dropped across the load the voltage of the battery can be lower than in Fig. 9 for a similar performance.

Fig. 11 shows a circuit giving the same gain as Fig. 10 but using the two battery method of stabilization. The saving in components is clear and the stability is better.

The comments made on decoupling components with respect to R-C coupled circuits also apply to transformer coupling or to any other form of coupling. Additional care is needed, however, because positive feedback can occur with only two stages if the connections to the coupling transformer in between them result in a phase change between the primary and the secondary.

Choke or L-C coupling is illustrated in Fig. 12. This circuit is identical to that of Fig. 9 except that R1 and R3 are replaced by two chokes, L1 and L2. The circuit falls between that of Fig. 9 and Fig. 10 in cost and performance having a higher gain than R-C coupling and a lower cost than transformer coupling. One point about this circuit that may be useful sometimes is the low value of the coupling capacitor required. If the transistors are required to amplify down to 100 c/s the capacitors C1 and C3 need only be 0.08 microfarad and if beta is 30 in each case, C2 and C4 need be no more than 2.4 microfarads. The values of the chokes L1 and L2 must be such that they offer a reactance of 20 K ohms to the lowest frequency required. If this is 100 c/s as before they should have inductances of 35 Henries.

Direct coupling, as the name implies, involves a direct connection between successive transistors without any intervening blocking capacitor. Since this means that two transistors coupled in this way are D.C. coupled as well as A.C. coupled their bias components cannot be considered independently. This makes it impossible to have a typical direct coupled stage several of which can be coupled together and it is necessary to design the circuit as a unit.

A large number of types of direct coupled circuit are possible and only the more useful ones can be described here. The circuit shown in Fig. 13 is a fairly popular form and may be compared with Fig. 9 as regards economy of components. Fig. 13 has 3 less resistors and one less capacitor without any sacrifice in performance. In fact the gain is slightly higher since the losses in the coupling components are less and the frequency response is better. The battery voltage, however,

has to be somewhat higher because the emitter voltage of Tr2 must always be about the same as the collector voltage of Tr1.

The method of operation of the circuit is rather ingenious since the transistors are interdependent as far as bias is concerned. Tr2 acts as part of the potential divider to supply the base of Tr1 and R5 acts as an isolating resistor. Tr2 in turn obtains its base bias from Tr1. Any increase in the collector current of Tr1 over the design value will increase the voltage dropped across R1 thereby reducing the collector current of Tr2 and hence the voltage across R4. This will reduce the current supplied to the base of Tr1 and tend to restore the collector current of Tr1 to its original level. A similar chain of events occurs if the collector current of Tr2 tends to rise. Since, in each case, one transistor amplifies the deviation of the other and then supplies a correcting voltage the stability is very good.

Determination of the component values for the circuit is fairly straightforward. Having decided upon the collector currents required and the voltage of the battery the values of R1 and R2 can be decided remembering that the collector voltage of Tr2 must be above that of Tr1 by an amount equal to the collector-emitter voltage (V_{be}) of Tr2. A value can now be chosen for R4 to give the required V_{be} for Tr2. This will determine the base voltage of Tr1, R5 being 2 or 3K ohms or sufficient to prevent too great a shunting of the input to Tr1.

It is possible to further simplify the circuit of Fig. 13 by omitting R3 and C1. In this case the base emitter current of Tr1 will depend upon the voltage dropped across R4 and the value of R5. Even in this case, however, the stability of the circuit is still very good and there is very little dependence on the Betas of the transistors. The stability can be improved by connecting a resistor between the base of Tr1 and the positive side of the battery.

Fig. 14 illustrates a similar circuit to that of Fig. 13 the main difference being that Tr1 is operated as a common collector amplifier rather than a common emitter amplifier. The overall current gain is much the same but the input impedance of Fig. 14 is very much higher making it suitable for use in preamplifiers driven by crystal pick-ups or microphones. R3 is shown connected to the collector of Tr2 which improves the stability and provides negative feedback at signal frequencies. It may, instead, be connected to the negative side of the battery in which case the gain will be higher but the stability lower.

Fig. 15 shows a rather remarkable and extremely economical 3 transistor circuit with direct coupling between each stage. The 3 transistors are biased as if they were a single unit by the method shown in Fig. 3. This is possible because there

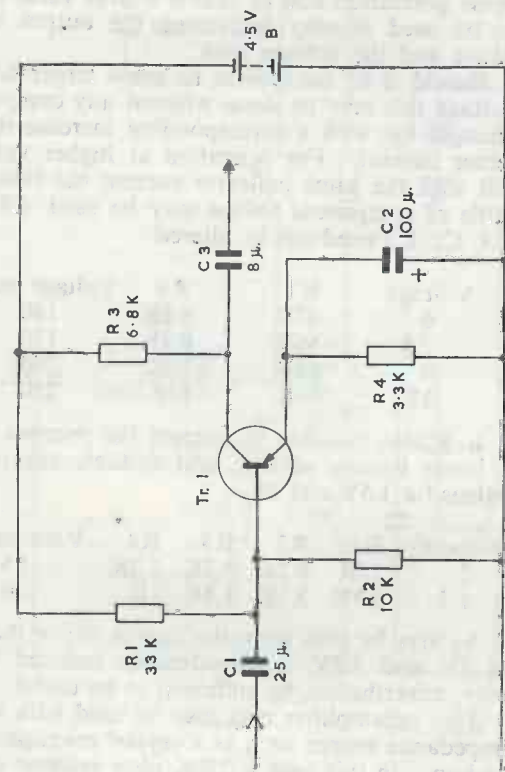

Fig. 16
Single Stage Preamplifier.

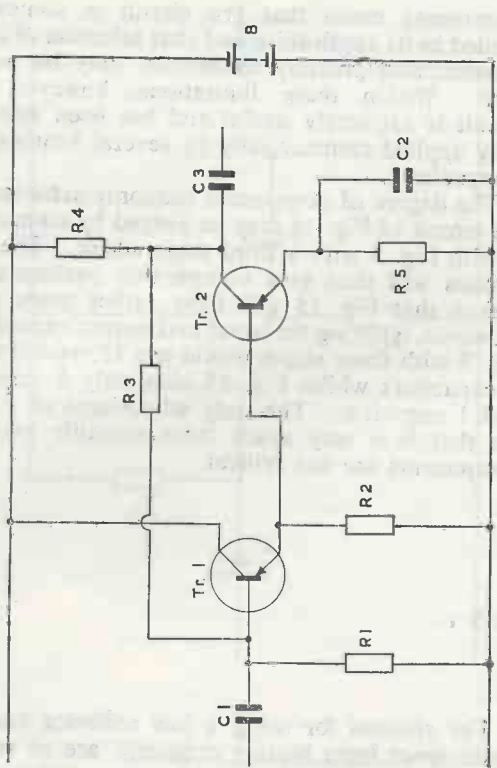

Fig. 14

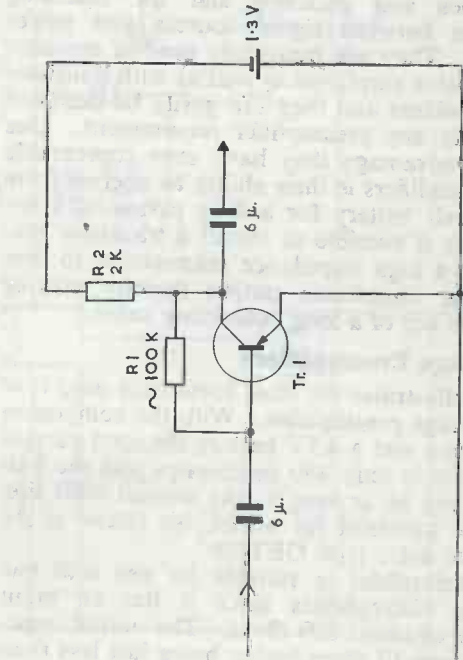

Fig. 17
Simplified Circuit for Microphones.

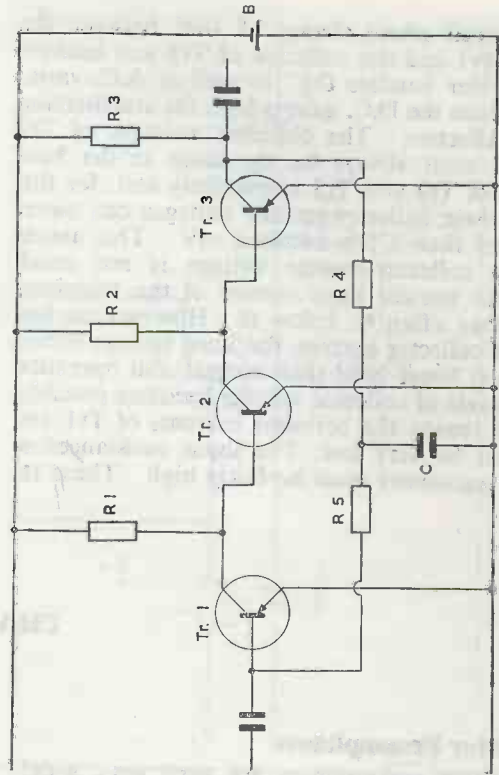

Fig. 15

is an overall phase change of 180° between the base of Tr1 and the collector of Tr3 and because the amplifier handles D.C. as well as A.C. variations. Since the D.C. gain is high the stabilization is very effective. The collector voltages of Tr1 and Tr2 must always be the same as the base voltages of Tr2 and Tr3 respectively and, for this reason, their collector-emitter voltages can never be greater than a few hundred mV. This means that the collector-emitter voltage is not much above the normal knee voltage of the transistor and it may often be below it. However, at low levels of collector current, the knee voltage occurs at a much lower level than normal and operation at low levels of collector voltage becomes possible. For this reason the collector currents of Tr1 and Tr2 must be very low. The input resistances of these 2 transistors must be fairly high. These re-

quirements mean that the circuit is somewhat limited in its application and that selection of components, and possibly transistors, may be necessary. Within these limitations, however, the circuit is extremely useful and has been successfully applied commercially by several hearing aid companies.

The degree of component economy achieved by the circuit of Fig. 15 may be judged by comparing it with Fig. 9 with a third stage added. The two circuits will then give comparable performances except that Fig. 15 will have rather more gain. However, ignoring the input and output capacitors, Fig. 9 with three stages would use 12 resistors and 5 capacitors whilst Fig. 15 uses only 5 resistors and 1 capacitor. The only advantages of Fig. 9 are that it is very much more versatile and the components are not critical.

CHAPTER 3

Transistor Preamplifiers

Transistor preamplifiers are used very widely for such purposes as boosting the signals from microphones and pick-ups and for matching impedances between signal sources and power amplifiers. They are frequently used in conjunction with valve amplifiers as well as with transistor power amplifiers and they can easily be designed for virtually any preamplifier requirement. One particular advantage they have over comparable valve preamplifiers is their ability to operate from a very small battery for a long period of time. This makes it possible to install a transistor pream. inside a high impedance microphone to provide a low impedance output thereby making feasible the use of a long connecting cable.

Single Stage Preamplifiers

Fig. 16 illustrates the most commonly used type of single stage preamplifier. With the component values shown and a 4.5V battery the total current consumption is only 400 microamps and the battery life may be as long as the normal shelf life. A suitable transistor for use in this circuit is the G.E.C. low noise type GET106.

This preamplifier is suitable for use with low impedance microphones since it has an input impedance of about 600 ohms. The output impedance is some 10 times higher being just less than the collector load of 6.8K ohms. The voltage gain is about 140 and the frequency response is 30 c/s to 40 Kc/s $\pm \frac{1}{2}$ dB. The base response may be extended by increasing the values of C1, C2 and C3.

The reasons for using a low collector current, quite apart from battery economy, are to reduce noise generation and to enable a large value of R3 to be used thereby increasing the output impedance and the voltage gain.

Should it be convenient to use a larger battery voltage this may be done without any component changes but with a corresponding increase in collector current. For operation at higher voltages but with the same collector current the following table of component values may be used. C1, R2, R4, C2, C3 need not be altered.

Voltage	R1	R3	Voltage gain
6	47K	6.8K	140
7.5	56K	8.2K	170
9	68K	10K	200
12	10K	12K	250

It is also possible to operate the preamp. from a lower battery voltage and suitable component values for 1.5V and 3V.

Voltage	R1	R2	R3	R4	Voltage gain
3	27K	8.2K	3.3K	2.2K	65
1.5	6.8K	3.3K	1.5K	1K	30

As may be seen from the figures above the gain at 3V and 1.5V is considerably reduced but it may, nevertheless, be sufficient to be useful.

This preamplifier may also be used with a high impedance source such as a crystal microphone or pickup. In this case a 250K ohm resistor should be connected in series with C1 which may be reduced to 0.1 microfarad.

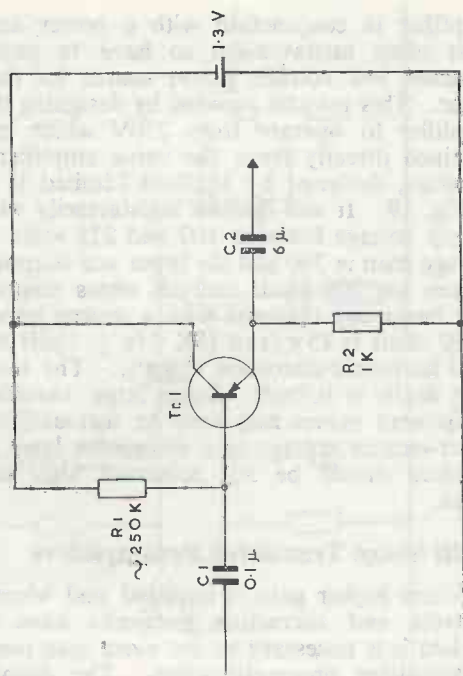

Fig. 18
Common Collector Preamplifier.

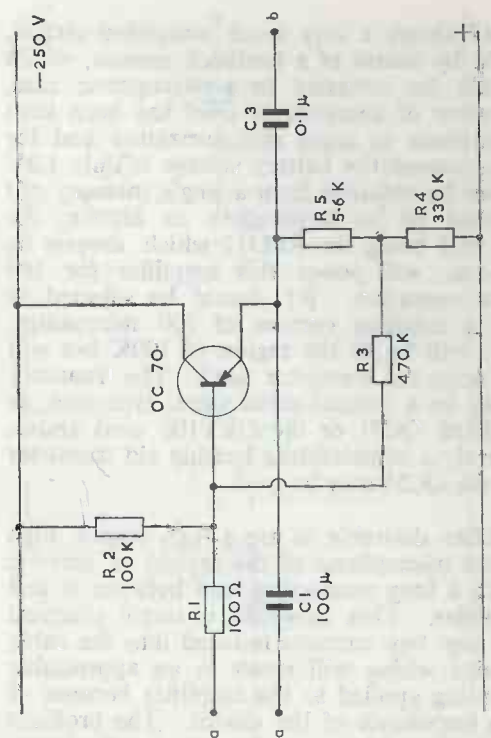

Fig. 19
250 Volt. Preamplifier.

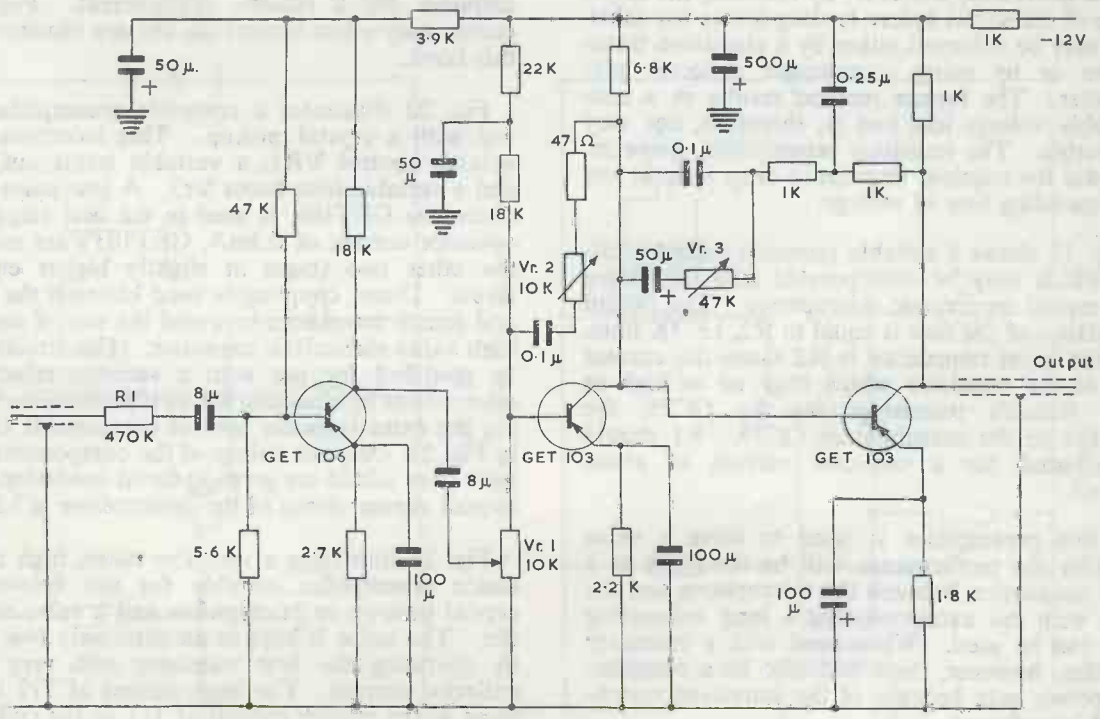

Fig. 20

Preamplifier for use with Crystal Pick-up (Courtesy G.E.C.)

Fig. 17 shows a very much simplified circuit, stabilized by means of a feedback resistor, which is suitable for inclusion in a microphone case. The number of components used has been kept to a minimum to assist miniaturization and for the same reason the battery voltage is only 1.3V which can be obtained from a single mercury cell which need be no larger than an aspirin; the smallest cell being the RM312 which, despite its minute size, will power this amplifier for 100 hours of operation. R1 should be selected to provide a collector current of 300 microamps. Its value will be in the region of 100K but will depend upon the transistor used. The transistor itself may be a normal small signal type such as the Mullard OC71 or the GET106 used above, alternatively a subminiature hearing aid transistor such as the OC59 may be used.

It is often desirable to use a high output, high impedance microphone of the crystal or ceramic type with a long connecting lead between it and the amplifier. This, however, is rarely practical because any tiny currents induced into the cable from mains wiring will result in an appreciable voltage being applied to the amplifier because of the high impedance of the circuit. The problem can be overcome, however, by reducing the impedance of the signal before feeding it into the cable. This may be achieved either by a stepdown transformer or by using a common collector pre-amplifier. The former method results in a considerable voltage loss and is, therefore, not very acceptable. The transistor preamplifier, however, provides the required impedance drop without any corresponding loss of voltage.

Fig. 18 shows a suitable common collector circuit which may be incorporated into the casing of a crystal or ceramic microphone. The output impedance of the unit is equal to R2, i.e. 1K ohm, and the input impedance is R2 times the current gain of the transistor which may be as high as 100. Suitable transistors are the OC75, the GET113 or the subminiature OC59. R1 should be adjusted for a collector current of about 1/3 mA.

If this preamplifier is used to drive a valve amplifier the performance will be the same as a direct connection between the microphone and the valve with the exception that a long connecting cable can be used. When used with a transistor amplifier, however, there will also be a considerable power gain because of the improved matching of impedances.

When using a single stage transistor pre-

amplifier in conjunction with a power amplifier it is often inconvenient to have to provide a separate, low voltage, power source for the transistor. This may be avoided by designing the pre-amplifier to operate from 250V which may be obtained directly from the valve amplifier. Such a circuit, designed by Mullard Limited is shown in Fig. 19. It will operate satisfactorily with any supply voltage between 100 and 275 volts. The voltage gain is 330 and the input and output impedances are 200 ohms and 5K ohms respectively. The frequency response with a source impedance of 50 ohms is 15 c/s to 13K c/s $\pm 1\frac{1}{2}$ dB and the total harmonic distortion is 0.4%. The total current drain is 0.7mA. Since large variations in component values may tend to increase the collector-emitter voltage to a dangerous level all the resistors should be 5% tolerance high stability types.

Multi Stage Transistor Preamplifiers

Where higher gain is required and where tone controls and correction networks have to be applied it is necessary to use more than one stage of transistor preamplification. The number of circuits that may be employed is virtually unlimited and it is normal to design each pre-amplifier for a specific requirement. For this reason only a few typical circuits are illustrated in this book.

Fig. 20 illustrates a complete preamplifier for use with a crystal pickup. This incorporates a volume control VR1, a variable treble cut, Vr2 and a variable bass boost Vr3. A low noise transistor, the GET106, is used in the first stage at a collector current of 0.3mA, GET103's are used in the other two stages at slightly higher current levels. Direct coupling is used between the third and fourth transistors to avoid the use of another high value electrolytic capacitor. The circuit may be modified for use with a variable reluctance microphone by changing R1 to 10K ohms and adding the extra response control components shown in Fig. 21. Only the values of the components that have been added are given to avoid confusion. The overall current drain of the preamplifier is 3.5mA.

Fig. 22 illustrates a very low noise, high impedance preamplifier suitable for use between a crystal pick-up or microphone and a valve amplifier. The noise is kept to an extremely low level by operating the first transistor with very little collector current. The base current of Tr2 is the same as the emitter current of Tr1 so the collector current of Tr2 is that of Tr1 times the current gain of Tr2.

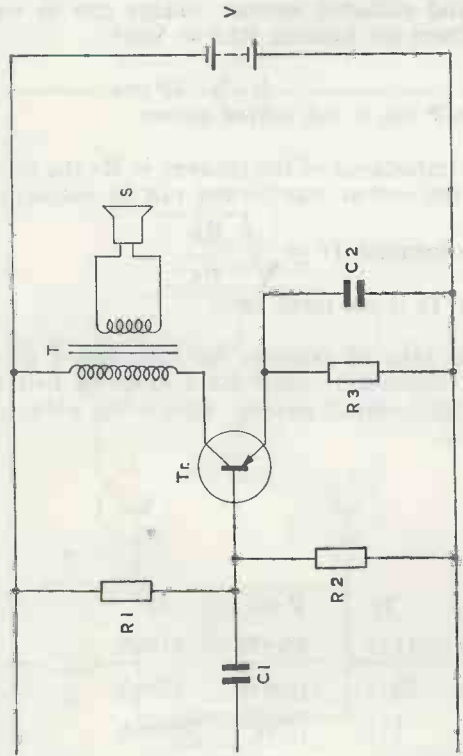

Fig. 23
Basic R-C coupled class A output stage.

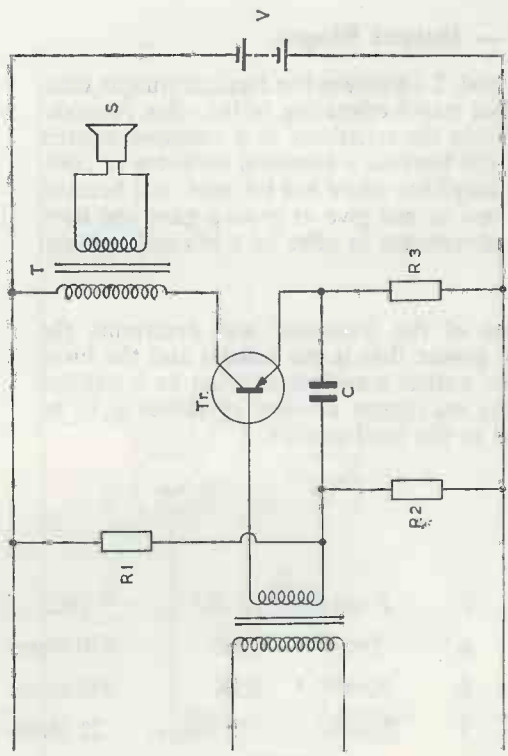

Fig. 24
Basic Transformer coupled class A output stage.

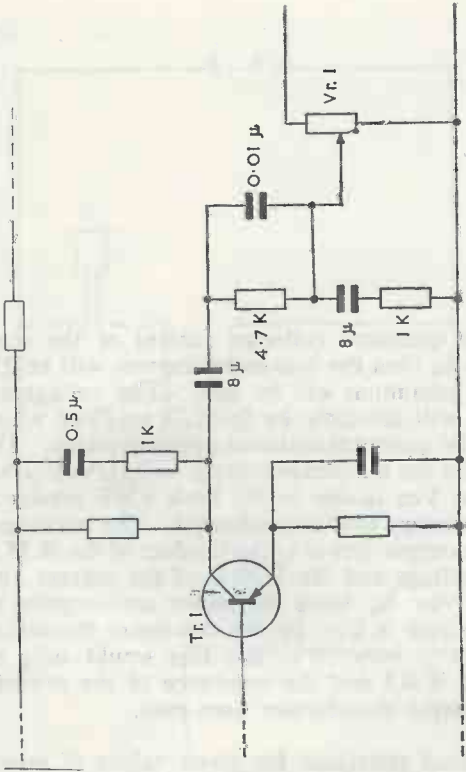

Fig. 21
Additional Circuitry for Variable Reluctance Pick-up.

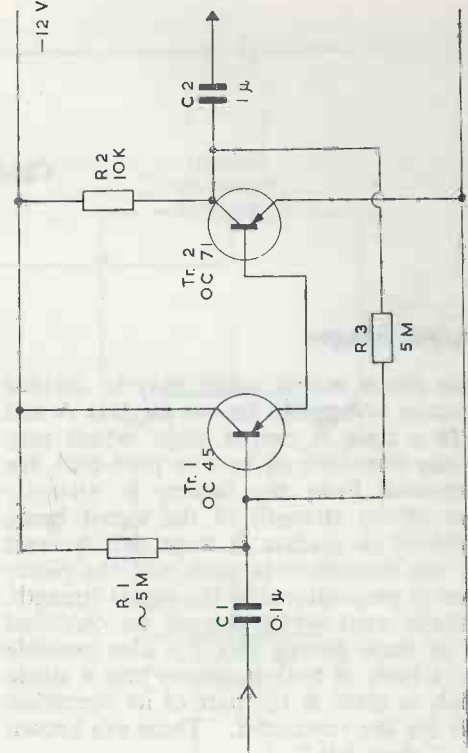

Fig. 22
Very low noise Preamplifier.

CHAPTER 4

Power Output Stages

Transistor power output stages may be divided into two groups commonly known as class A and class B. In a class A output stage, which may consist of one transistor or two in push-pull, the power consumed from the battery is virtually independent of the strength of the signal being amplified whilst in a class B stage, which must always use two transistors in push-pull, the power consumption is proportional to the signal strength. Output circuits exist which cannot be classified into either of these groups and it is also possible to combine a little of both functions into a single circuit which is class A for part of its operation and class B for the remainder. These are known by the term "class AB".

Class A — Output Stages

Figs. 1 and 2 illustrate the basic forms of transistor output stages operating in the class A mode. They both use the transistor as a common emitter amplifier, not because a common collector or common base amplifier could not be used, but because the latter two do not give as great a gain and have no other advantages to offer in a normal application.

The bias of the transistor will determine the amount of power that it can handle and the turns ratio of the output transformer must be a definite value if the maximum amount of power is to be transferred to the loudspeaker.

If the quiescent collector current of the transistor is I_q then the maximum current will be $2I_q$ and the minimum will be zero. The voltage excursion will similarly be from 0 to $2V_{ce}$ where V_{ce} is the quiescent collector emitter voltage. The reason for the maximum voltage being $2V_{ce}$ rather than just V_{ce} is due to the back EMF produced by the primary of the transformer. The maximum possible output power is the product of the R.M.S. of the voltage and the R.M.S. of the current, this being $\frac{1}{2} V_{ce} \cdot I_q$. Since the power consumption of the transistor is $V_{ce} \cdot I_q$, the maximum theoretical efficiency is only 50% and this would only be achieved if R_3 and the resistance of the primary of the output transformer were zero.

The load resistance for given values of power output and collector emitter voltage can be calculated from the formula $R_{L2} = \frac{2P_{out}}{V_{ce}^2}$

$$2P_{out}$$

Where P_{out} is the output power.

If the impedance of the speaker is R_s the turns ratio of the output transformer can be calculated

from the formula
$$Tr = \sqrt{\frac{R_L}{R_s}}$$

Where Tr is the turns ratio.

For the sake of example the table below gives suitable component values for a range of battery voltages and output powers. P_{dis} is the collector dissipation.

V	P out	R1	R2	R3	Tr	P dis	Ic
6	20mW	5.6K	470 ohms	47 ohms	12:1	55mW	11mA
6	50mW	3.3K	470 ohms	47 ohms	10:1	110mW	22mA
9	750mW	220 ohms	22 ohms	5 ohms	3:1	1.7W	300mA
12	2W	50 ohms	6 ohms	1 ohm	2.5:1	4.8W	700mA
9	3W	68 ohms	8 ohms	1 ohm	1.5:1	7W	1A

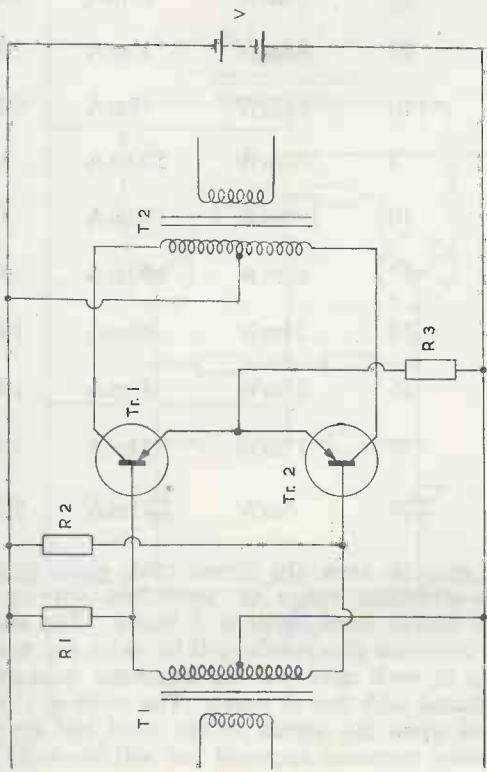

Fig. 27 Transformer having a circuit suitable for use with high secondary resistance.

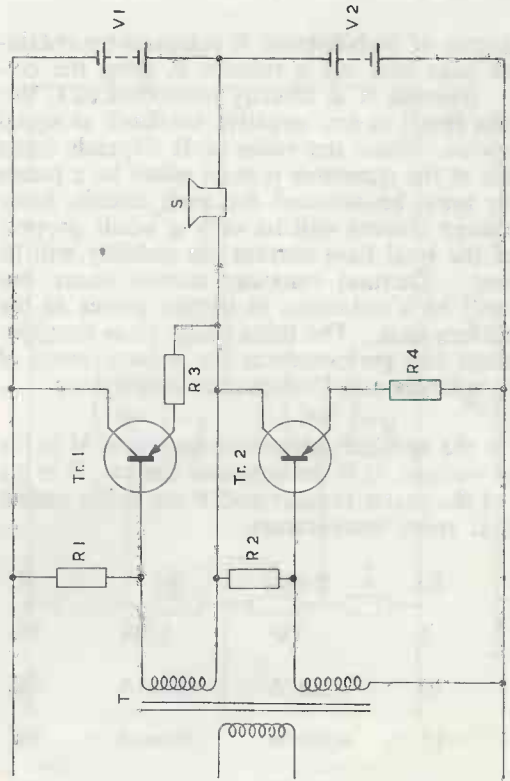

Fig. 28 Typical single ended push-pull output stage.

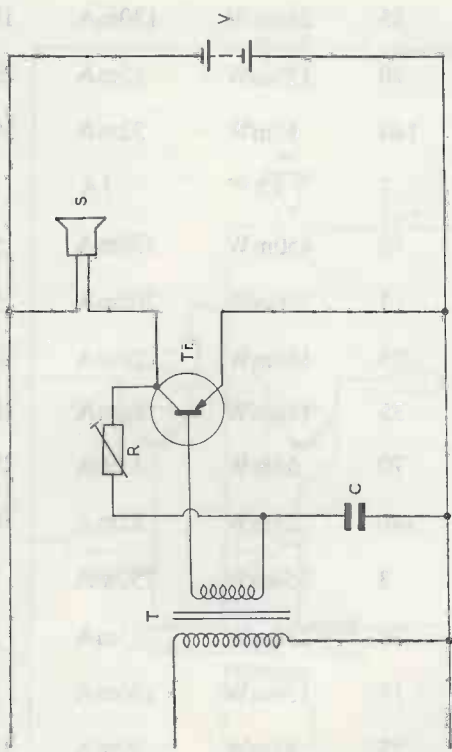

Fig. 25. Basic circuit of output stage using half-supply voltage principle.

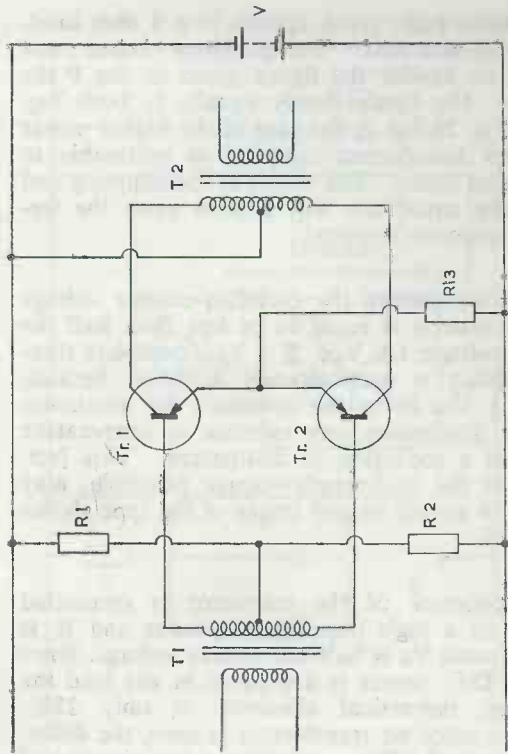

Fig. 26 Symmetrical push-pull output circuit.

PRACTICAL TRANSISTOR AUDIO AMPLIFIERS

The turns ratio given applies to a 3 ohm loudspeaker in each case. The transistor chosen must be able to handle the figure given in the P dis column. The figures apply equally to both Fig. 23 and Fig. 26 but in the case of the higher power amplifiers transformer coupling is preferable to avoid input losses. The values of the coupling and decoupling capacitors will depend upon the frequency response required.

In circuits where the collector-emitter voltage of the transistor is equal to or less than half the battery voltage, i.e. $V_{ce} \leq \frac{1}{2} V_{cc}$, complete thermal stability is automatically achieved because $V_{ce} = \frac{1}{2} V_{cc}$ being the condition for maximum collector dissipation, any increase in temperature results in a reduction in dissipation. This fact, known as the half-supply-voltage principle, may be used in simple output stages of the type shown in Fig. 25.

The collector of the transistor is connected directly to a high impedance speaker and R is adjusted until V_c is half the battery voltage. Since half the D.C. power is dissipated in the load the maximum theoretical efficiency is only 25%. However, since no transformer is used, the difference in overall efficiency between this circuit and that of Fig. 24 would only be very slight.

A degree of stabilization is achieved by obtaining the base bias via a resistor R from the collector. Because R is directly connected to C this does not result in any negative feedback at signal frequencies. Since the value of R depends upon the gain of the transistor it must either be a preset type or must be selected for each circuit. Since the leakage current will be only a small proportion of the total base current the stability will be sufficient. Thermal runaway cannot occur but there will be a reduction in output power as the temperature rises. The table below gives component values and performances for a large range of battery voltages and loudspeaker impedances.

R_s is the speaker impedance in ohms, V is the battery voltage, I_c is the collector current, R is the value of the preset resistor and P out is the output power at room temperature.

V	R_s	P out	I_c	R
9	3	3W	1.5A	1K
9	10	800mW	450mA	5K
9	15	600mW	300mA	5K
9	25	350mW	180mA	10K

9	35	250mW	130mA	10K
9	70	125mW	65mA	20K
9	140	65mW	32mA	50K
6	3	1.5W	1A	1K
6	10	450mW	300mA	5K
6	15	300mW	200mA	5K
6	25	160mW	120mA	10K
6	35	110mW	86mA	10K
6	70	55mW	43mA	20K
6	140	27mW	22mA	50K
4.5	3	750mW	750mA	1K
4.5	10	230mW	225mA	5K
4.5	15	150mW	150mA	5K
4.5	25	85mW	90mA	10K
4.5	35	70mW	65mA	10K
4.5	70	35mW	33mA	20K
4.5	140	16mW	17mA	50K
3	3	350mW	500mA	1K
3	10	100mW	150mA	5K
3	15	60mW	100mA	5K
3	25	35mW	60mA	10K
3	35	25mW	43mA	10K
3	70	12mW	22mA	20K
3	140	6mW	11mA	50K

As may be seen, the above table gives figures for a complete range of amplifiers varying in power output from 6mW to 3 Watts. The maximum collector dissipation will be twice the power output in each case and the transistor used must be selected with this in mind. The value of C will depend upon the circuit values used and on the frequency response required but will normally be about 100 microfarads.

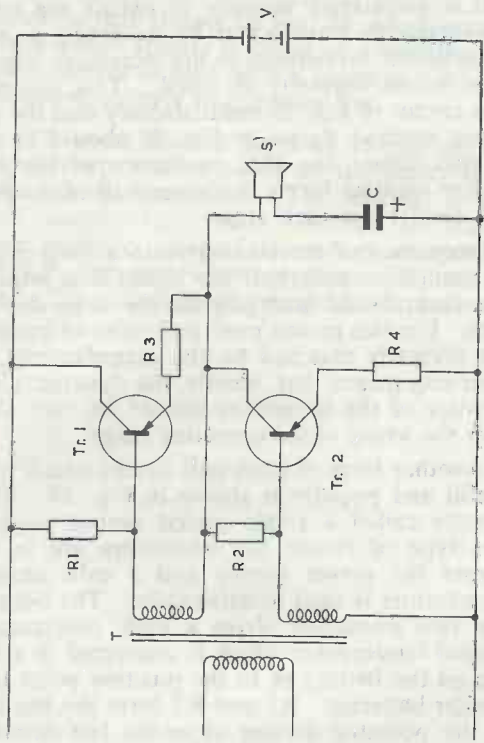

Fig. 29

Single ended Circuit using only one Battery

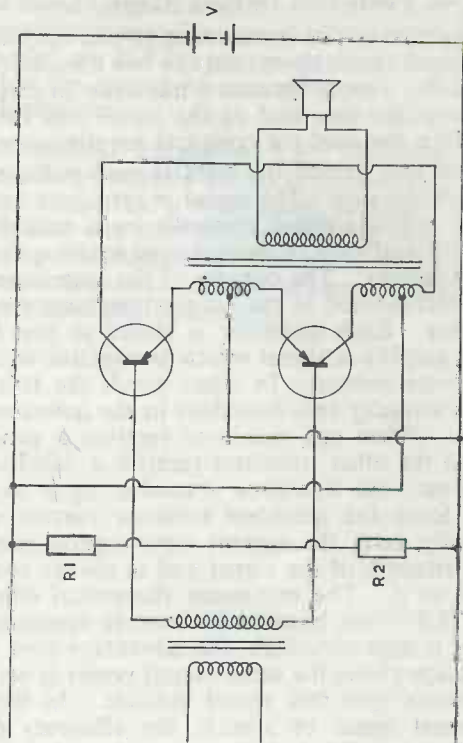

Fig. 30

Split load push-pull Circuit.

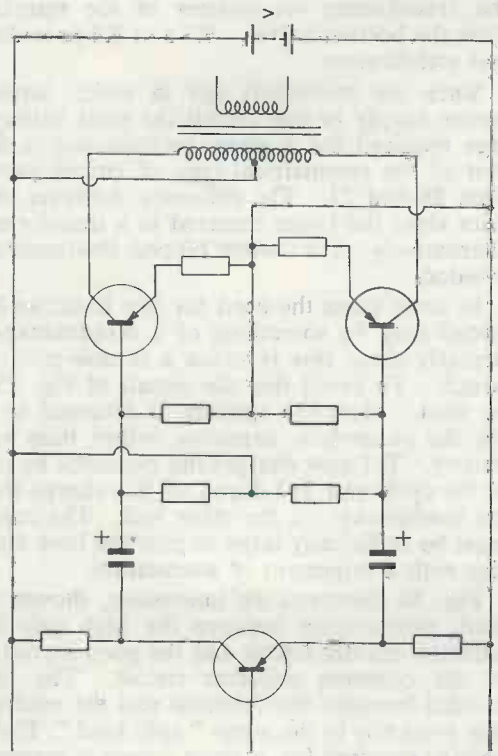

Fig. 31

Push-pull stage using a Transistor phase-splitter.

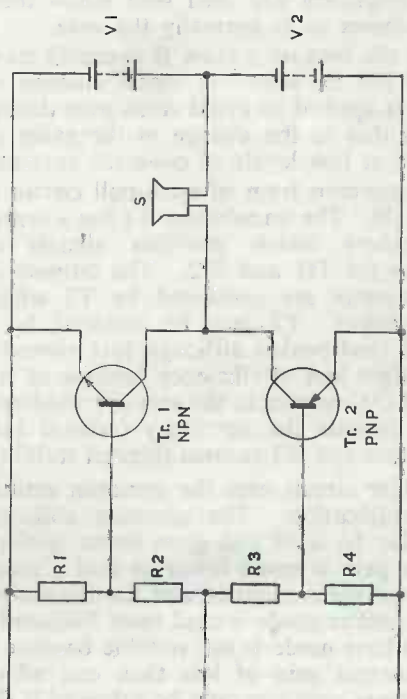

Fig. 32

Transformerless push-pull output using principle of complementary symmetry.

Class B — Push-Pull Output Stage

As was stated in the introduction to this chapter class B output stages always require two transistors in push-pull. This is because a transistor in class B only amplifies one half of the signal and two are therefore required for complete amplification.

The principle behind the class B push-pull circuit is a simple one. The signal is split into two signals of opposite phase, normally by a suitable transformer, and each of these is used to drive one of the transistors. The outputs of the transistors are then recombined in the output transformer or loudspeaker. Each transistor is biased so that it will only amplify a signal which is negative with respect to its emitter. In other words the transistor has virtually zero base bias in the quiescent condition. When one transistor receives a positive signal the other transistor receives a negative one thus only one transistor is conducting at any instant. Since the quiescent collector current is theoretically zero, the current consumption rises with the strength of the signal and is always proportional to it. The maximum theoretical efficiency is 78.5% but, because the average operating efficiency is also very high, the advantage over a class A stage giving the same output power is very much greater than this would indicate. In fact, with normal music or speech, the efficiency of a class B stage is likely to be as much as 5 times as high as a class A stage and may be considerably more if the amplifiers are used well below their maximum volumes as is normally the case.

In practice the bias on a class B operated transistor should not be zero. A small amount of forward bias is applied to avoid cross over distortion which is due to the change in the gains of the transistors at low levels of collector currents.

The most common form of push-pull circuit is shown in Fig. 26. The transformer T1 has a centre tapped secondary which provides signals of opposite phase for Tr1 and Tr2. The outputs of the two transistors are combined by T2 which drives the speaker. T2 may be replaced by a centre tapped loudspeaker although this normally results in a slight loss of efficiency because of the dissipation of D.C. power in the speaker windings. R1 and R2 provide the necessary forward bias to the transistors and R3 ensures thermal stability.

This amplifier circuit uses the common emitter mode of amplification. The common collector mode may also be used and gives better quality. However, the gain is much lower so that a much higher drive voltage is required and for this reason the common emitter mode is used most frequently. The common base mode is not suitable because it provides a current gain of less than one which means that power gain can only be achieved if the output impedance is greater than the input impedance. This is not practical with normal battery voltages.

It is sometimes possible to reduce the cost of the interstage transformer by accepting a higher value of D.C. resistance in the secondary windings than would normally be used. This makes the bias circuit of Fig. 26 unsatisfactory and the alternative method shown in Fig. 27 should be used. In this circuit the D.C. resistance of the transformer winding forms the lower half of the potential divider for each stage.

Since each of the transistors in a push-pull circuit amplifies only half the signal it is important that they should both provide the same degree of gain. For this reason push-pull pairs of transistors are normally matched by the manufacturer. This matching means that, ideally, the dynamic characteristics of the transistors should be very similar over the whole of the operating range.

Another form of push-pull circuit which is both useful and popular is shown in Fig. 28. This is usually called a single ended output stage. In this type of circuit the transistors are in series across the power supply and a split secondary transformer is used to drive them. The outputs of the two transistors drive a high resistance, untapped loudspeaker which is connected to a centre tap on the battery or to the junction point of two similar batteries. R1 and R2 form the top halves of the potential divider as in the last circuit and the transformer secondaries of the transformer form the bottom halves. R3 and R4 provide thermal stabilization.

Since the transistors are in series across the power supply in this circuit the total battery voltage required for a given performance is double that of the symmetrical type of circuit shown in Figs. 26 and 27. The efficiency, however, is superior since the losses incurred in a transformer or, alternatively, in a centre tapped loudspeaker are avoided.

In some cases the need for two batteries in this circuit may be something of a disadvantage particularly since this involves a double-pole on-off switch. To avoid this the circuit of Fig. 29 may be used. Here the speaker is returned to earth via the electrolytic capacitor rather than via the battery. Tr1 now charges the capacitor on its half of the cycle and Tr2 draws off this charge through the loudspeaker on the other half. The capacitor must be sufficiently large to pass the base frequencies with a minimum of attenuation.

Fig. 30 illustrates an interesting, though rarely used, compromise between the high gain of the common emitter circuit and the good reproduction of the common collector circuit. The load is divided between the collector and the emitter and this gives rise to the name "split load". The drive voltage required for a given output is greater than in a common emitter circuit but the crossover distortion that arises when the battery voltage drops is less.

PRACTICAL TRANSISTOR AUDIO AMPLIFIERS

Another rarely used but perfectly feasible type of circuit is that shown in Fig. 31 which uses a transistor phase splitter in place of a transformer. If a loudspeaker is used with a centre tap the circuit becomes entirely transformer free.

Fig. 32 shows another form of transformerless push-pull output stage based on the principle of complementary symmetry. The circuit is extremely simple but rather difficult to realise because matched pairs of transistors comprising one P.N.P. and one N.P.N. type are still hard to obtain. The principle of operation of the circuit

is based on the fact that a cut off P.N.P. transistor requires a negative signal to cause it to conduct whilst an N.P.N. type requires a positive signal thus the output transistors form a phase splitter themselves.

Practical Transistor A.F. Amplifiers Book 2 contains complete circuit diagrams, with component values, for a wide range of amplifiers. It is divided into four sections dealing with amplifiers of up to 10mW, 100mW, 1 watt and 20 watts output respectively. There is also a chapter dealing with available transistors.

FORTHCOMING NEW BOOKS IN THIS SERIES

- Second Book of Hi-Fi Loudspeaker Enclosures
By B. B. Babani Price 60p (approx.)
- Handbook of Integrated Circuits (I.C's) Equivalents
and Substitutes
By B. B. Babani Price 60p (approx.)
- Handbook of Electronic Circuits For The Amateur
Photographer
By B. B. Babani Price 50p (approx.)
- Constructors Manual of Electronic Circuits for
The Home
By B. B. Babani Price 50p (approx.)
- How To Build Your Own Aerials For Colour and
Monochrome T.V. (Bands 4 and 5)
By B. B. Babani Price 40p (approx.)
- Gadget Construction Handbook Using I.C's (Integrated
Circuits)
By B. B. Babani Price 60p (approx.)
- Hints And Tips For Hi-Fi Users And Enthusiasts Price 50p (approx.)
- Transistorised Sub-Miniature Radio Control
Construction Manual No. 1
By L. Pericone Price 75p (approx.)
- Transistorised Sub-Miniature Radio Control
Construction Manual No. 2
By L. Pericone Price 75p (approx.)
- Practical Handbook Of Electronic Musical Novelties
By B. B. Babani Price 50p (approx.)
- Aerials Design Handbook For Long Distance Reception
On All Wave Bands
By B. B. Babani Price 50p (approx.)
- Short Wave Listeners Giant Data Chart
By B. B. Babani Price 35p (approx.)
- Constructors Chart of Transistors, Diodes, FET's
and Thyristor Bases and Connections
By M. H. Babani Price 25p (approx.)
- Handbook of Diode Equivalents and Substitutes including
Zener Diodes, Thyristors, Diacs, Triacs, Rectifiers
and Photo Diodes etc.
By B. B. Babani Price 60p (approx.)
- 21 Elementary Practical Electronic Circuits for Boys
By B. B. Babani Price 40p (approx.)
- 29 Practical Novelties and Accessories for Hi-Fi
Equipment
By B. B. Babani Price 60p (approx.)

BERNARDS AND BABANI PRESS RADIO BOOKS

BP1	First Book of Transistor Equivalents and Substitutes	40p
BP2	Handbook of Radio, TV and Industrial Tube and Valve Equiv.	40p
BP3	Handbook of Tested Transistor Circuits	40p
BP4	International Handbook of the Worlds Short Wave, Med and Long Wave Radio Stations & FM & TV Listings	35p
BP5	Handbook of Simple Transistor Circuits	35p
BP6	Engineers and Machinists Reference Tables	20p
BP7	Radio and Electronic Colour Codes and Data Chart	15p
BP8	Sound and Loudspeaker Manual	50p
BP9	38 Practical Tested Diode Circuits for the Home Constructor	35p
BP10	Modern Crystal Set Circuits for Beginners	35p
BP11	Practical Transistor Novelty Circuits	40p
BP12	Hi-Fi, P.A., Guitar & Discotheque Amplifier Design Handbook	75p
BP13	Electronic Novelties for the Motorist-Published Sept. 1972	50p
BP14	Second Book of Transistor Equivalents-Published Oct. 1972	75p
96	Crystal Set Construction	8p
100	A Comprehensive Radio Valve Guide, Book 1	30p
121	A Comprehensive Radio Valve Guide, Book 2	30p
126	Boys Book of Crystal Sets and Simple Circuits	18p
129	Universal Gram-Motor Speed Indicator	8p
138	How to Make F.M. and T.V. Aerials, Bands 1, 2, 3	18p
141	Radio Servicing for Amateurs	20p
143	A Comprehensive Radio Valve Guide, Book 3	30p
146	High Fidelity Loudspeaker Enclosures	40p
147	Practical Tape Recording Handbook	30p
149	Practical Stereo Handbook	30p
150	Practical Radio Inside Out	40p
156	Transistor Circuits Manual, No. 1	15p
157	A Comprehensive Radio Valve Guide, Book 4	30p
160	Coil Design and Construction Manual	30p
161	Radio, T.V. and Electronics Data Book	25p
163	Transistor Circuits Manual, No. 2	15p
168	Transistor Circuits Manual, No. 4	15p
170	Transistor Circuits for Radio Controlled Models	40p
173	Practical Transistor Audio Amplifiers, Book 1	20p
174	Transistor Subminiature Receivers	32½p
175	Transistor Test Equipment and Servicing Manual	25p
176	Manual Transistor Audio Amplifiers	40p
177	Modern Transistor Circuits for Beginners	40p
178	A Comprehensive Radio Valve Guide, Book 5	30p
183	How to Receive Foreign TV Programmes on your set by Simple Modifications	32½p
185	Tested Shortwave Receiver Circuits using MAT's	30p
187	The TSL Mark '4' Valved F.M. Tuner and its construction	20p
191	Practical Car Radio Handbook	30p
195	High Fidelity 14 Watt Amplifier Design Chart	15p
196	AF - RF Reactance-Frequency Chart for Constructors	15p
197	Inexpensive Push-Pull Amplifier Construction Chart	15p
RCC	Resistor Colour Code Disc Calculator	10p

BABANI PRESS AND BERNARDS (PUBLISHERS) LTD
 The Grampians, Western Gate, Shepherds Bush Road,
 London W6 7NF Tel: 01-603 2581/7296