

trade information

for radio, television & electrical dealers

WIRELESS & ELECTRICAL TRADER is the foremost trade journal of the radio, television and domestic electrical industries, and is available by subscription to bona fide dealers only. It supplies up-to-date information on: new products; trade activities—personalities, social events, exhibitions, etc.; financial matters—new companies, wage agreements, prices, liquidations; publicity—sales promotion, advertising and display; the equipping of premises and workshops; and the latest technical advances in receivers and equipment. Another useful technical feature presents hints and problems contributed by dealers and service engineers in the light of their working experience. Each issue contains a separate Service Sheet on a British radio or television receiver, often covering a whole range of models.

EVERY SATURDAY. £2 15s. per annum
(£1 13s. Subscription plus £1 2s. postage)

Wireless & Electrical
TRADER

Trader Publishing Co. Ltd., Dorset House, Stamford Street, London, S.E.1.

Transistors

CIRCUITS AND SERVICING

B.R.A. BETTRIDGE, A.M.BRIT.I.R.E.

Published by Trader Publishing Co. Ltd
Dorset House, Stamford Street London S.E.1

TWO SHILLINGS AND SIXPENCE

Transistors

Circuits and Servicing

INTRODUCTION

THE transistor has now passed from the stage of being a scientific curiosity to being a component found in an increasing number of pieces of apparatus likely to come into the hands of service engineers.

If one can judge from the trend of events in the U.S.A., where published figures show a greater sale of transistors in the first six months of 1956 than in the whole of the two previous years, this process is likely to continue at an accelerated pace in this country too. It is not too soon, therefore, for service engineers to make themselves familiar with transistor circuitry in preparation for the jobs they will have to tackle, and that is the purpose of this booklet.

The physics and fundamental operation of transistors have already been well covered in various publications, but this kind of information, although of great interest, is by no means essential, or even helpful, to a service engineer confronted with the task of dealing with a piece of equipment employing transistors. The emphasis is therefore placed on the behaviour of these devices in circuits and on the detailed examination and explanation of typical circuits. Point-contact transistors will be regarded as being unlikely to be met with in any domestic equipment.

The booklet begins with general information about the devices themselves, the terms and symbols used in connection with them, and their electrical characteristics. Where it is helpful, their behaviour is compared and contrasted with that of thermionic valves and it will be found that, treated in

this way, most transistor circuitry is not difficult to follow.

From the circuit designer's point of view it might be preferable to start from scratch and think purely in terms of transistors and their particular properties, but the service engineer will understand transistor circuits more readily by regarding them as developments of the valve circuits with which he is already familiar.

Power Supplies

The provision of H.T. and bias supplies to the electrodes is examined, with particular reference to the elaborations necessary to stabilize bias against temperature variations—an important point that is not met with in valve circuitry.

Audio frequency amplifying and output

Six transistors from the Brimar range, with an ordinary ruler below them for comparison.

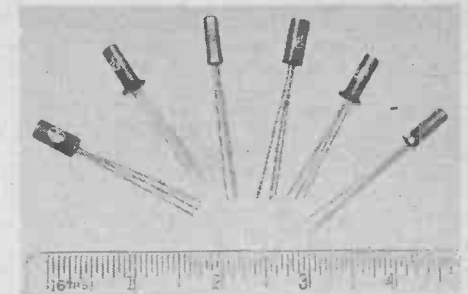

stages are dealt with individually and illustrated by reference to a typical gramophone amplifier circuit. This information will, of course, apply equally to the A.F. end of radio receivers.

The higher frequency end of radio sets is then described, starting with I.F. amplifiers, continuing with detectors, and leading on to methods of achieving automatic gain control. Finally, frequency changing stages of various kinds are also discussed.

Since "hybrid" sets using both valves and transistors are likely to be fairly common for some time to come owing to frequency limitations of existing transistors, it is necessary also to describe transistor D.C. convertors, which enable H.T. for the thermionic valve stages to be obtained from the low-voltage supply used for the valve filaments and transistor H.T.

Fault Tracing

With the circuit aspect thoroughly covered, the booklet is completed by giving information about signal tracing, fault finding, precautions to be taken against damage when making measurements and simple methods of testing transistors.

By putting the facts clearly and simply, this little booklet will enable any service engineer at present competent to deal with valve equipment to feel equally at home with transistorized gear. It is quite possible that some service engineers previously taking an interest in this subject have been dismayed and discouraged by the almost exclusively theoretical approach of much of the existing literature. Prospective readers may rest assured that the approach in this booklet will be made against a practical background throughout, the author having personally built radio sets and amplifiers using circuits of the types to be described and analysed.

There is one point about transistor circuits which is of such importance that it is worth while to mention it in advance of the context of future articles to drive it home. This is that the transistor is a current-operated device, and thinking in terms of a signal voltage at the control electrode, as in the case of the thermionic valve, will only mislead.

From the start, therefore, the reader should get into the habit of considering the current to the control electrode, instead of the voltage. It will be necessary to come back to this point on numerous occasions, and the sooner it is accepted and its implications realized, the sooner will transistor circuits seem as clear and logical as valve circuits.

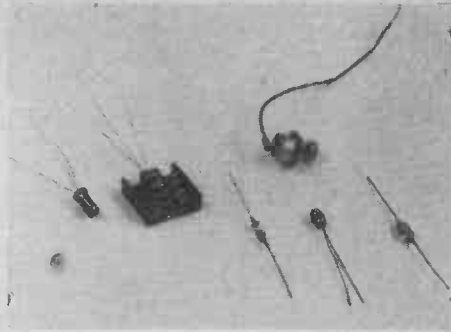

Shown above are G.E.C. germanium junction transistors, and junction and point contact diodes.

Pye Newmarket intermediate power transistor.



A single example of the Ediswan Mazda range of transistors, which include R.F. and A.F. types.

Below is a selection of Mullard semi-conductors, including diodes, transistors, and a photo-transistor, compared with ordinary matches.

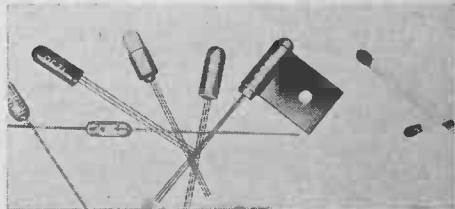

THE NATURE OF THE TRANSISTOR

ALTHOUGH point-contact transistors are unlikely to have any practical application in domestic equipment, the junction transistor which is now beginning to be widely used derives from the point-contact transistor, and consequently a brief description of its nature and the manner in which it functions will be found useful as a lead-in to a treatment of the junction transistor.

Physical and Electrical Properties

The point-contact transistor may be regarded as an elaboration of the germanium crystal diode which consists of a piece of germanium with a pointed, springy wire (a "cat's whisker") in contact with its surface. This combination acts as a rectifier, its electrical resistance being low in one direction and high in the other.

With the whisker made positive, current flows easily from it to the germanium, but when it is made negative the resistance is high so that only a minute current passes. If a second whisker is placed on the surface of the germanium within a few thousandths of an inch of the first to form a second rectifying contact, it is found that current in one rectifier can affect the characteristics of the other.

The nature of the effect is that forward current in one rectifier (that is with the whisker positive) reduces the high resistance which the other whisker would normally exhibit when made negative. Thus, current in one circuit may be made to influence current in a separate circuit and, in suitable circumstances, amplification can be achieved. This two whisker device constitutes the point-contact transistor.

The symbol used for the point-contact transistor is given in Fig. 1(a) and it will be seen to follow naturally from the struc-

ture of the device. The piece of germanium, which is called the base, is represented by the horizontal line, and the two whiskers are represented by the sloping lines. That which passes forward current bears an arrow-head and is called the emitter, whilst the other, which passes reverse current, bears no arrow-head and is called the collector. These terms, incidentally, have a significance relating to the operation of the device, as will be seen later.

The junction transistor is similar to the point-contact type in that it, too, consists of two rectifiers so devised that forward current in one modifies the reverse resistance of the other. So that, although the construction is quite different, the same symbol is used for it, and the same terms are employed to describe its electrodes.

More Complex Types

Junction transistors having more than these three electrodes have been devised, but they will certainly not be widely used in equipment during the next year or two and will therefore not be considered here. Excluding these more complex types there are still many varieties of junction transistors in existence, and readers who have seen reference to such types as alloy, grown, rate grown, surface barrier, diffused, etc., may feel that the subject has already become difficult to follow.

Fortunately, the complication is more apparent than real. These various terms are, in fact, descriptions of methods of manufacture which affect details of behaviour rather than the fundamental mode of operation. Similarly, the effect of using another substance such as silicon in place of germanium is mainly to raise the permissible operating temperature, leaving its general behaviour unaltered.

So that, from the point of view of examining their operation in circuits, there is no need to deal with many types separately; a single typical case will suffice to illustrate them all, and for this purpose a p-n-p germanium alloy type transistor will be chosen.

The Junction Transistor

Before dealing with the electrical characteristics of junction transistors it is desirable to have a little background knowledge of their basic structure. To understand that it is necessary to know what is meant by n-type and p-type semi-conductor material, and the case of germanium will serve to illustrate the matter.

The metal germanium in a state of absolute purity is virtually a non-conductor, but the admixture of a minute proportion of other elements confers a limited conductance, and the material then becomes a semi-conductor. Conduction can take place in two different ways according to the nature of the added impurity.

If arsenic or antimony is added, electrons are made available to carry current, and the material is described as n-type, the "n" signifying the negative polarity of the current carriers. The addition of indium or gallium leads to the production of current carriers whose polarity is positive, and the material is known as p-type.

The carriers are in fact positive "holes", but their precise nature need not be discussed here since, for our purposes, we may quite conveniently treat them as if they were electrons having a positive instead of a negative charge.

A p-n-p transistor consists of a sandwich of n-type material between two regions of p-type material. This is made in the case of the germanium alloy type by taking a thin wafer of n-type germanium and alloying indium into it from either side, so that two zones of p-type material are formed, separated by a narrow zone of the unaltered n-type material.

Fig. 1.—The standard symbol for a transistor in a circuit diagram: (a) the p-n-p (and point-contact) transistor; (b) the n-p-n transistor. The arrow on the emitter points in the direction of conventional current flow, not electron flow.

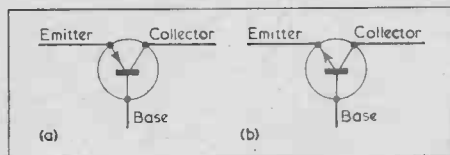

Contacts are then made to each region, the n-type material becoming the base, whilst one of the p-type zones becomes the emitter and the other the collector. The question of which zone is used for the emitter and which for the collector is settled as part of the manufacturing process. In fact transistors may be used connected so that the electrode coded as collector functions as emitter and vice versa, but with the conventionally made device amplification suffers under these conditions.

The n-p-n Transistor

By starting with p-type material and alloying n-type impurity to either side, transistors may be made which are known as n-p-n type. They are not commonly available in this country, but some American and Japanese radio sets using them have found their way over here and it is advisable to know something about them.

Actually, all that need be said is that they behave in the same way as p-n-p transistors, but the polarities of H.T. and bias supplies have to be different. All circuit illustrations based on p-n-p types will therefore be equally applicable to n-p-n types provided that the polarity signs are reversed. The symbol for the n-p-n type is the same as that for the p-n-p type, except that the arrow on the emitter points away from the base, as shown in Fig. 1 (b).

By varying the dimensions of the basic sandwich, the ratings of transistors may be modified, a scaling down giving improved frequency performance, and an increase in size resulting in higher power-handling capacity.

High Degree of Purity

The chemical purity of the materials used for the transistor assembly has to be controlled to fantastically close limits, and it is therefore not surprising that it should be extremely sensitive to contamination. One of the major problems in transistor manufacture is the provision of suitable encapsulation (casing) to give effective hermetic sealing without sacrificing the essential small size and robustness of the device, and at present individual manufacturers favour different solutions.

There is as yet no standard technique for envelopes as there is in the case of thermionic valves, for instance, some makers using glass, and others metal in conjunction with glass, ceramic or plastic. With the higher-power types there is the further problem of obtaining satisfactory heat conduction from the system to the outside.

This state of affairs has resulted in little standardization of shape, size or connection, and manufacturers' literature should always be consulted regarding the last point.

Valve Analogy

There is some common practice in that the collector connection is usually singled out for special identification either by a colour code or by different spacing. The smaller transistors are essentially wire-in

components, but those in which the wires are brought out in line can alternatively be fitted into holders.

When dealing with electrical behaviour, there are sufficient points of similarity between transistors and thermionic valves to make comparisons and analogies extremely helpful, and this is particularly true when transistors are being used to perform functions already familiar in valve practice.

The electrodes of a transistor are analogous to those of a thermionic triode, with the emitter corresponding to the cathode, the base to the grid and the collector to the anode. Fig. 2 shows, how, like the valve, the transistor may be used in three different circuit configurations. The first and most used shown at (a) is the "common emitter", sometimes called "grounded emitter", in which the signal is fed in between base and emitter and taken out between collector and emitter, so that the emitter is common to both input and output circuits. This corresponds to the most usual arrangement in valve practice, where the cathode is earthy, the grid the input electrode and the anode the output electrode.

Other Modes of Use

The second at (b) is the "common base" circuit, where the input is between emitter and base and the output between collector and base. This corresponds to the grounded grid valve circuit, more correctly called common grid, which is used mainly in U.H.F. pre-amplifiers. Finally at (c) there is the "common collector" use, where the base and collector constitute the input terminals and the output is taken between emitter and collector. This is analogous to the valve cathode follower circuit. The collector (or anode) is, of course, earthy. It will be noticed that in (a) and (c) the transistor symbol is turned on its side, and this is standard practice in such cases.

Fig. 2.—Basic transistor circuit configurations compared with conventional thermionic valve circuits of similar kinds, with bias details omitted. (a) Common emitter transistor and common cathode valve; (b) common base transistor and common (or grounded grid) valve; (c) common collector transistor and cathode-follower (or common anode) valve. The H.T. positive line is earthy.

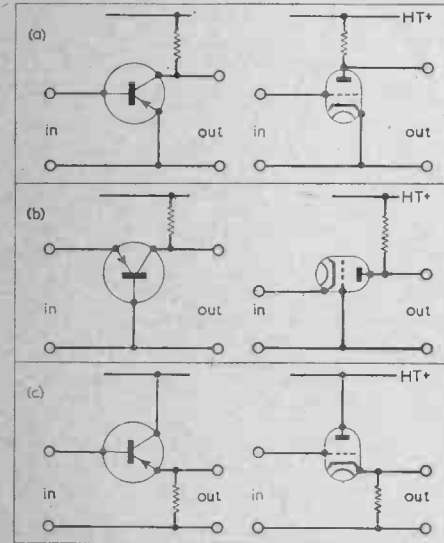

COMMON (OR EARTHED) BASE OPERATIONS

IN explaining the operation of the thermionic valve the common cathode arrangement is always taken, and the less frequently used configurations follow easily from this. In the case of the transistor, the common emitter mode, though normally used, is not the best starting point and the most straightforward appreciation of the relationship of currents in the various electrodes arises from first looking at the common base circuit.

Earthed Base Operation

A consideration of the currents flowing under various conditions in the set-up shown in Fig. 3 will illustrate the most important facts about the common base operation of transistors. The circuit, which is easily made up by any reader interested in trying out matters for himself, consists of a general-purpose p-n-p transistor such as a type GET3 connected via suitable meters to tapped batteries supplying current to the emitter and collector.

It will be noted that the supply to the collector is of negative polarity, as opposed to the positive supply required by the corresponding electrode, that is the anode, of a thermionic valve. This means, of course, that one can no longer take for granted that the H.T. line in a radio set is positive. If the set is transistorized, H.T. polarity will depend on the type of transistor in use, being positive with n-p-n types and negative with the more common p-n-p types. This question of polarity must always be kept in mind since in certain cases damage to both transistor and measuring instrument may result from reversal.

The first measurements are taken with the emitter circuit left open and with the meter in the collector circuit set to a 0.50 microampere (0.50 μ A) range. When the collector circuit is closed by connecting to

the -1.5V tap a current of about 4 μ A flows which increases to a minor degree only, perhaps to 5 μ A, when the voltage is increased to -6V. Under these conditions the collector-base junction is behaving as a rectifier connected in its reverse direction so that the current consists of the inevitable leakage current of such a device.

This collector current, in the absence of any emitter current, is called I_{CO} , and although so small it is of considerable importance in circuits to be described later. Its value is highly dependent on the temperature of the transistor, and it approximately doubles itself for every 10 deg. C rise, so that a value of 5 μ A measured at a normal room temperature of 20 deg. C would rise to about 40 μ A at 50 deg. C. It should be remembered that such a rise in temperature might be brought about by dissipation in the device itself, quite apart from any increase in the surrounding (ambient) temperature.

Dangerous Voltages

No damage can result to the transistor under the conditions just described for the measurement of I_{CO} , but it is convenient at this stage to mention two departures from them which can cause trouble. The first is the application of a voltage of the correct polarity but beyond the makers' rating. This causes a sharp rise in I_{CO} , and the consequent heat produced leads to a further increase in I_{CO} , which in its turn causes more heat with still higher I_{CO} , so that "run-away" conditions are set up and the device is destroyed by the heating effect of the excessive current. With sufficiently high voltage there is immediate breakdown of the junction without the intervention of thermal run-away.

The second danger is the application of a voltage of incorrect polarity. In this case the collector-base junction behaves as

a rectifier with forward voltage applied so that its resistance is very low and, in the absence of any limiting resistance, current high enough to destroy both transistor and meter flows in the circuit.

Current-limiting Resistance

For the next measurements, the range of the collector meter must be increased to 0.5 milliamps (0.5mA) with the collector voltage V_C still remaining at -6V. The emitter circuit is first completed by plugging into the +1.5V tap. The presence of the 1,500 Ω resistor is necessary since the emitter-base junction is also a rectifier and +1.5V applied directly between emitter and base would cause excessive current to pass. In this part of the circuit a reversal of polarity would do no harm, correct polarity with no limiting resistance being the dangerous condition.

The current in the emitter circuit I_e will not differ measurably from 1mA, which is the value to be expected from 1.5V across 1,500 Ω , showing that the emitter-base contribution to the total resistance is negligible. In fact, for this type of transistor it is in the neighbourhood of 25 Ω .

With this I_e of 1mA it is found that the collector current I_C is also 1mA, or very close indeed to it. A very accurate measurement would show it to be 985 μ A, consisting of the initial 5 μ A, due to I_{CO} plus a further 980 μ A brought about by the passage of emitter current. Leaving the emitter circuit unchanged, and changing the collector voltage back to 1.5V, would cause negligible change in collector current, showing that the impedance of this circuit is very high. Refined methods of measurement show that a typical value is in excess of 1 megohm.

A change in the tap to the emitter battery to +3V causes 2mA to flow in the emitter circuit, and the collector current increases by a further 980 μ A to nearly 2mA. Each further increase of 1mA in the emitter circuit brought about by moving the tap another 1.5V in the positive direction results in an increase of nearly 1mA (actually 0.98mA) in the collector circuit.

Current Gain

The ratio of the corresponding current change in the collector to a change of current in the emitter is therefore 0.98, and although this is a little less than unity it is called the current gain of the transistor and is designated by the Greek letter alpha (α). We are more concerned here with the use that can be made of this behaviour than the reason for it, so it will

suffice to say that the increase in collector current is due to collection by the negatively polarized collector of most of the positive holes injected into the base region by the passage of emitter current. If it could collect all of them the current gain alpha would be unity.

How it Amplifies

It is not obvious at first sight how a device, which has already been described as current operated, should be able to amplify if the current change in the output circuit is slightly less than that causing it in the input circuit. The matter becomes clear when it is appreciated that amplification cannot properly be defined purely in terms either of current gain or voltage gain except when measured between identical impedances.

The fact that this is often ignored in valve amplifiers should not be allowed to obscure the basic fact that amplification is a raising of power level and should

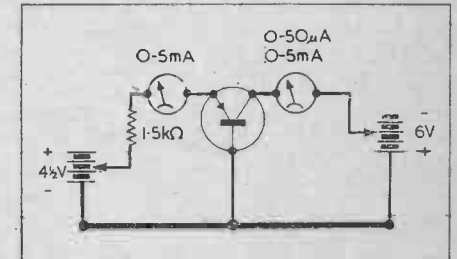

Fig 3.—The circuit described in the text for the measurement of the common base, or earthed base, characteristics of a p-n-p transistor. The 1.5k Ω resistor limits the emitter current to a safe value.

therefore be measured in terms of power gain. Approached from this direction, there is no difficulty in seeing how the common base transistor amplifies since a current change in its low impedance emitter represents a much lower power level than a similar change in its high impedance collector.

To obtain gain in a practical transistor amplifier, input and output circuits have to be matched to the impedances of emitter and collector, and the way this is done is illustrated in Fig. 4, which shows the circuit diagram of a two-stage I.F. amplifier. It should be mentioned at this point that at intermediate frequencies the impedance figures already mentioned no longer hold good, and the emitter impedance may have risen to about 200 Ω , while that of the collector may have fallen

to as little as 30,000Ω. The appropriate ratio of a transformer for matching purposes is therefore given by taking the square root of 30,000 divided by 200, which is approximately 12:1.

Stage Gain

T1 is an I.F. transformer with a step-down turns ratio of 12:1 whose primary winding L1 is tuned by C1 and fed from the F.C. stage. Its secondary winding L2 which is closely coupled to L1 is untuned and feeds into the emitter of TR1, the first I.F. amplifying transistor. The function of this transformer is to match the high impedance of the F.C. output to the low impedance of the emitter of TR1 and in the process a current step-up of twelve times takes place between the I.F. signal in L1 and that induced in L2.

There is, of course, no true amplification here because we have lost in voltage to the same extent as we have gained in current. However, this increased signal current in the emitter circuit of TR1 causes a signal at almost the same current level (actually $\times 0.98$) to flow in the collector and its external circuit consisting of L3, the primary winding of T2. We therefore have a current gain of twelve between the tuned circuits L1, C1 and L3, C3, and if we take their impedances as being equal this represents a power gain, too, of twelve.

A similar step-up of current results between L3 and L4 followed by transfer in the transistor of this current to the higher impedance of L5. The output transformer T3 is of suitable ratio to match into the detector circuit.

Returning for a moment to the circuit in Fig. 3, and reversing the polarity of the battery feeding the emitter, we should find

negligible current flowing in the emitter circuit and no change in collector current upon adjusting the emitter bias; in fact, the situation is similar to when a valve has its anode current cut off by negative bias so that further bias can have no effect.

It is clear from this that a signal simply applied between emitter and base of a transistor would be rectified, and only the positive half-cycles would affect the collector current. To allow both halves of the signal to be passed on it is necessary to pass a steady bias current into the emitter which can be added to or diminished by the positive and negative half-cycles of the signal.

In the practical circuit in Fig. 4 bias current is provided for the emitter of TR1 from a positive tap on the battery via R1 and L2, a low impedance return path to earth for I.F. being provided by the capacitor C2. To avoid coupling between the two emitter circuits, TR2 is supplied through a separate resistor R2 decoupled by C4. The normal bias for such a circuit lies between 0.5 and 1.0mA, and in the particular case shown is about 0.7mA. A higher value is merely wasteful of current, but a lower one reduces gain due to a property of the transistor not yet described, but which is briefly as follows.

Emitter-base Resistance

We have seen that the emitter-base path has the low resistance value of 25Ω when 1mA is flowing and this low value is maintained for higher values of I_e. For lower values of I_e, however, the emitter resistance increases appreciably so that at 0.25mA it is 100Ω and at 0.025mA it is 1,000Ω. A corresponding rise takes place in the already

higher figures we have mentioned as occurring at intermediate frequencies.

This higher input impedance with reduced bias means that the input transformer, which incidentally no longer gives correct matching from the previous stage, cannot drive so much signal current into the emitter and gain is accordingly diminished. Variation of emitter bias thus constitutes a method of controlling gain, and this is the basic factor in most A.G.C. systems. These will not be considered in detail until later, after certain other points have been covered.

D.C. Measurements

Making D.C. measurements in the circuit in Fig. 4 is straightforward, collector voltages being read directly between collector and base leads, and collector currents by breaking into the circuit at points x and y. If there is no current despite the presence of voltage, either the transistor is faulty or it is not receiving emitter bias.

By breaking the circuit at the junction of L2 and R1 it is possible first to make certain that bias current is available, by connecting a milliammeter between R1 and earth, and then to check whether the transistor will pass it, by inserting the meter between R1 and L2. If the transistor will not pass any emitter bias it means that its

emitter is open-circuited, while emitter current with no corresponding collector current means the collector is open-circuited. Care is necessary when checking this circuit, because short-circuiting either of the bias resistors R1 or R2 results in excessive bias, with collector currents high enough to destroy the transistors.

Operating Frequency

In choosing a replacement transistor for an I.F. amplifier the most important characteristic to take into consideration is the frequency cut-off figure usually symbolized by f_{α} . Owing to the artificial conditions under which it is convenient to measure this parameter it represents a frequency considerably higher than that at which useful gain can still be obtained. In fact a transistor should be chosen with a f_{α} figure not less than two or three times the required operating frequency.

One final point should be noticed regarding the circuit in Fig. 3; both I_e and I_c flow in the base lead of the transistor, but in opposite directions, so that the net base current is the small difference between them. This small order of base current, which is associated with emitter and collector currents perhaps 50 times as large as itself, should be noted for future reference.

Fig. 4.—A practical circuit diagram of a two-stage transistorized I.F. amplifier using earthed-based operation with p-n-p transistors, which is not a common method. It serves to illustrate the author's explanation of how stage gain is achieved, and how bias can be applied.

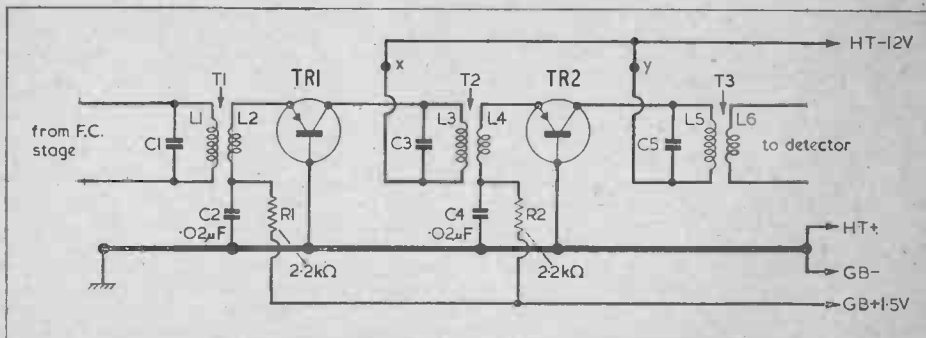

COMMON (OR EARTHED) EMITTER OPERATION

FROM a practical point of view, common emitter operation of transistors is most conveniently illustrated by examination of their behaviour in such a circuit as that shown in Fig. 5. However, a more complete understanding results if, in the first place, an approach is made from what has already been learned about common base operation where currents were considered in two separate branches, each supplied from its own battery.

Current Relationships

In this case current in the emitter was determined almost solely by the voltage of the emitter battery and the value of the series resistance, whilst current in the collector consisted of a constant leakage current called I_{co} plus an amount equal to emitter current multiplied by a factor slightly less than unity called alpha. Current in the base lead was noted as being small and equal to the difference between I_e and I_c , but it was not considered in detail.

This can now be investigated by tabulating a set of values for these various currents in a typical transistor which, to give easily handled figures, will be taken as having $I_{co} = 5\mu A$ and $a = 0.98$. All currents are expressed in micro-amps, and the positive or negative sign indicates whether they are flowing into or out of the transistor.

When expressed in this convention, the algebraic sum of I_e , I_c and I_b must always be zero, since the total inward current must always equal the total outward current.

This table shows that each change in base current of $5\mu A$ corresponds to a change in collector current of $245\mu A$, that is to say, 49 times as large. This leads to the idea that by using the base as control electrode, advantage might be taken of this current gain between base and collector circuits. A further point to be noted is that at $I_e = 250\mu A$ the base current is zero so that under these conditions the current may be regarded as flowing into the emitter and out of the collector from the two batteries in series. This leads naturally to the kind of circuit shown in Fig. 5, where there is only one battery connected between collector and

emitter. In this circuit a definite current I_b may be fed to the base via a high resistance taken to H.T. negative.

In such a circuit as Fig. 5 the condition shown in the table where $I_b = \text{zero}$ could not exist unless $R1$ were made infinite (open circuit), and the condition $I_b = +5\mu A$ could never occur in any case.

Common Emitter Operation

Although the currents are now fed into the electrodes differently, the relationship between them must still follow the same fundamental rules, and the figures in the table still hold good. If, therefore, $R1$ is chosen to give a base current of $-5\mu A$, I_e and I_c must take up values of 500 and $-495\mu A$ respectively. And if $R1$ is adjusted to vary I_b , corresponding variations 49 times as large must take place in I_c .

This large ratio between current changes in collector and base can in fact be shown

to be equal to $\frac{a}{1-a}$ but it is of great

importance in the common emitter circuit and is usually given a symbol in its own right. Unfortunately, there is as yet no standard practice in this respect and various articles of literature refer to it as α' , β or α_{cb} so that the reader must be prepared for the present to recognize any of these symbols as signifying the same thing.

Transistor Characteristic Table

I_e	$-I_e \times .98$	I_{co}	Total I_c	I_b
0	0	-5	-5	+5
+250	-245	-5	-250	0
+500	-490	-5	-495	-5
+750	-735	-5	-740	-10
+1,000	-980	-5	-985	-15

α = common base current gain factor (alpha).

I_e = emitter current.

I_c = collector current.

I_{co} = collector leakage current.

I_b = base current.

All currents quoted in μA . Ambient temperature assumed to be 20-25 deg C.

A further alternative, and one that may possibly supersede all the others is h_{fe} , the "e" denoting common emitter. If this convention is adopted, h_{fb} will be used for common base current gain in place of the present symbol α .

Valve Analogy

It is interesting to compare the common emitter transistor amplifier in Fig. 5 with a corresponding one using a valve. In the valve case, current in the anode circuit is controlled by a voltage applied to the grid and a voltage bias is provided so that positive and negative half-cycles of the input signal may be dealt with. In the absence of bias the anode current is high, and when a negative bias is applied it reduces it.

In the case of the transistor, current in the collector circuit is controlled by current supplied to the base, and a current bias is provided to achieve correct amplifying conditions. In the absence of bias current the collector current is very low, and bias is supplied to increase it. There is little point in comparing polarity of supplies since in the transistor case they depend on whether a p-n-p or an n-p-n type is used.

As might be expected from this comparison, if due allowance is made for the current control of transistors, as opposed to the voltage control of valves, there is a great degree of similarity between transistor and valve circuits.

Before considering the circuit of Fig. 5 in detail it is necessary to mention input and output impedances, which differ considerably from those given for common base operation. Precise values depend on a number of factors which will not be gone into here, but it may be taken that for a small general purpose transistor the input impedance is about 1,000 ohms, whilst that of the output approximates to 50,000 ohms.

Fig. 5.—Simple transistor A.F. amplifier circuit using the common emitter mode of operation. Positive base bias is applied via $R1$.

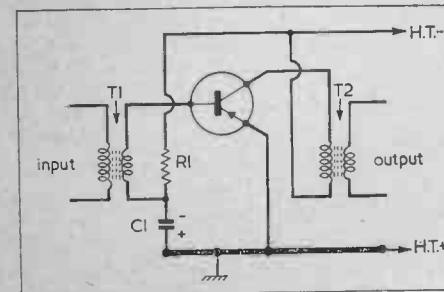

Bearing in mind what has already been said about the effect of impedance levels when determining amplification, it is apparent that amplification in a common emitter transistor when properly matched is due both to the current gain α_{cb} between base and collector and to the impedance transformation between input and output.

If no other consideration than optimum gain is taken into account the input transformer T1 must have a ratio matching the input to 1,000 ohms, so that if the previous stage is a common emitter transistor with an output impedance of 50,000 ohms the correct ratio would be $\sqrt{\frac{50,000}{1,000}}$ or 7:1 approximately.

A lower ratio than this is frequently used in the interests of low distortion, 4.5:1 being typical. This deliberate mis-match lowers gain somewhat by feeding the transistor from too high an impedance, but at the same time it tends to mask variation in input impedance and so gives better linearity.

These variations are of the same nature as those mentioned in the common base amplifier, in that there is a great rise in the value of input impedance when low current is flowing. Avoidance of this effect is not easy to achieve in portable equipment, since current economy is usually important, and even where higher current operation is permissible it is difficult to make very small transformers capable of passing the current without saturation.

Matching the Load

The ratio of the output transformer T2 depends on the nature of the load. Obviously, if this stage is feeding into another similar one the remarks above apply, but if it is operating as an output stage feeding headphones or a loud-speaker the ratio must be chosen not for optimum gain but for maximum power.

The method of calculation in the case of a transistor class "A" output stage is simple and needs no reference to characteristic curves and drawing of load lines. Suppose the transistor has a maximum collector dissipation of 60 mW and that it is to be run at this figure. If the H.T. supply is 6V, the bias must be adjusted to give a collector current of 10mA, and the correct load will then be $\frac{6 \times 1,000 \text{ ohms}}{10}$ that is 600 ohms, and the output power will be very close indeed to 30 mW which represents an efficiency of 50 per cent and is the maximum theoretically obtained in a class A stage.

Incidentally, the value of the bias resistor to give 10mA collector current would be 30,000 ohms approximately because the base current has to be about 1/50 of the collector current, which is 0.2mA, and this flows when 6V is applied to 30,000 ohms.

The same output would be obtained with a 12V H.T. supply by biasing the base through a 120,000 ohm resistor to give a collector current of 5mA, making the output load $\frac{12 \times 1,000}{5}$ ohms, i.e. 2,400 ohms.

Effect of Temperature

The biasing arrangement shown in Fig. 5 has a serious limitation in that it is only satisfactory in equipment operating in a very small range of temperatures, and a more complicated circuit is nearly always needed. The trouble is due to the increase of I_{CO} with temperature, which has been mentioned as doubling for every rise of 10 degrees C.

In the common emitter arrangement of Fig. 5 this current augments the intentional bias current and alters the working point of the transistor. Suppose, for example, that the transistor is working at a temperature of 20 degrees C and its collector current is held at about 1mA by the provision of 15 μ A base current as shown in the table. If the temperature rises to 40 degrees C, I_{CO} rises from 5 μ A to 20 μ A, making the total base current 30 μ A and causing the collector current to become nearly 1.75mA.

The increase will not stop here, because the higher collector current means higher dissipation, which raises the temperature of the transistor still more so that a further rise in current occurs. In some conditions this effect can become cumulative and the transistor will "run away" and destroy itself. Of the several methods of combating

Fig. 6.—Common emitter A.F. amplifier using a stabilized bias supply circuit. Base bias is derived from R1, R2 and emitter bias from R3.

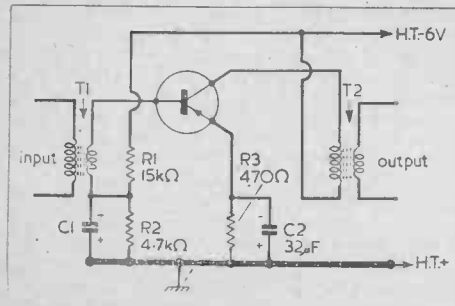

this effect and achieving bias stability, the one shown in Fig. 6 is the most usual for transformer-coupled circuits. In this a voltage divider R1, R2 is connected across the H.T. supply, and R3 is inserted in the emitter lead. It is by-passed by C2 to prevent A.F. degeneration.

A detailed analysis of the working of this arrangement is not possible here and it will suffice to say that a high value of R3 combined with a low total value of R1, R2 gives the greatest degree of stabilization, but since R3 reduces the effective collector voltage, and R1, R2 increase the H.T. current drain, some compromise is necessary in practice, and the values shown in the figure are fairly typical.

In this circuit the base is maintained by the voltage divider 1—1.5V negative to earth line, and since under operating conditions there is a potential difference of less than 0.2V between base and emitter, the transistor will take sufficient current to cause its emitter also to be in the neighbourhood of 1—1.5V negative to earth line by virtue of the drop across R3. Any increase in current due to temperature rise will be offset by the increased voltage drop across R3 tending to lower the base-to-emitter potential, thus reducing emitter and collector currents.

Servicing Danger

When making measurements in this type of circuit it is most important that R3 should never be short-circuited, since this would lead to very heavy emitter and collector currents and almost certain damage. It is also inadvisable to short-circuit R1, since the transistor would then pass sufficient current, in other words about 12mA, to drop nearly the whole of the H.T. voltage across R3.

There is little danger to the transistor initially in this latter case because dissipation is negligible owing to all the H.T. being dropped across the resistor instead of the transistor. If, however, the decoupling capacitor is damaged by the extra voltage across R3 and forms a short-circuit across the resistor, immediate destruction of the transistor results from the application of the full H.T. voltage across the emitter-base junction in the direction of good (forward) conduction.

This examination of the basic points of common emitter operation will enable the analysis of practical radio and amplifier circuits in succeeding articles to be easily understood. The common collector arrangement, which is less frequently used, will be dealt with as a particular case when it arises in a practical circuit.

LOW FREQUENCY TRANSISTOR AMPLIFIER CIRCUITS

IN the last chapter a detailed examination of the current relationships in the three electrodes led to a simplified way of looking at transistor operation in the common emitter connection. In this, two currents only were considered, one flowing between base and emitter, the other between collector and emitter, and changes in the first current were shown to cause larger changes in the second, the ratio between them being the current gain α_{cb} .

In analysing practical circuits it is convenient to continue treating the operation in these terms which, amongst other advantages, make for easy comparison with corresponding valve circuits. Only when examining D.C. bias conditions is it necessary to give consideration to separate emitter and collector currents, and here no appreciable error is introduced by regarding the emitter current as of the same magnitude as the collector current.

In this context, it is perhaps appropriate to mention again the important fact that under the conditions of use met with in A.F. amplifiers and radio receivers the potential difference between base and emitter is small and rarely exceeds 200mV.

Practical A.F. Amplifiers

With these reminders, we can proceed to an examination of the circuit in Fig. 7 which, with slight variations, can be used to illustrate most of the features likely to be encountered in the products of individual manufacturers in their gramophone amplifiers and the A.F. portions of their portable radios.

The circuit shows an amplifier in which the first stage is R.C.-coupled to a second stage driving a class "B" output stage via a phase-splitting transformer. Negative feedback is taken from the speech coil to the base of the driver transistor. The use

of p-n-p transistors operating from a 6V negative H.T. line is typical.

The first stage is biased in the manner described in Chapter 3 so as to be reasonably independent of temperature changes. A voltage divider, R2, R3 holds the base a little less than 1.5V negative to earth line, and the transistor must take sufficient current (actually about 0.3mA) to produce a voltage of almost the same value across R4+R5 in its emitter lead. This value of current keeps noise low without appreciable effect on gain.

Analogy With the Valve

Resistance in the emitter lead produces negative feedback in the same way as resistance in the cathode lead of a valve, and to restore full A.F. gain it must be shunted by a capacitor of low impedance. In this particular case, 100 ohms is left unshunted to give a small degree of negative feedback which has the dual effect of improving the linearity and raising the input impedance.

When the signal comes from a low impedance source it is fed to the base via C1, but in the case of a high impedance source, such as a crystal pick-up, it is necessary also to include R1. The upper limit to the gain which can be achieved by this stage in the absence of help from a matching transformer is set by the current gain factor of the transistor itself. This is analogous to the R.C.-coupled valve case, where the voltage magnification factor μ sets the upper limit.

The coupling arrangement is similar to that used in the valve circuit, but in arriving at appropriate values for the components different considerations have to be borne in mind. In the valve case the requirement is to develop maximum voltage across the grid circuit of the following stage, whilst

in the transistor case it is to drive maximum current into the base circuit of the following stage.

With a valve, this leads to a load impedance that is high in comparison with the internal impedance of the valve, and this load is provided mainly by the anode feed resistance shunted to as small a degree as possible by the succeeding grid leak.

Matching the Load

With the transistor, a low load impedance relative to its internal impedance is required, and this is provided mainly by the input impedance of the following stage, shunted to as small a degree as possible by the resistance feeding the collector and by the bias network of TR2.

Thus R6 needs to be high in comparison with the input impedance of TR2, but not with the output impedance of TR1. The value of the coupling capacitor in the valve circuit is evaluated on the basis that its impedance at the lowest required frequency should be much lower than that of the succeeding grid leak. In the transistor case the impedance of C3 must be low compared with the output impedance of the preceding stage.

The unusual connection of the volume control VR1 is adopted to avoid altering bias conditions for TR2. As the slider moves towards the earth line, an increasing

proportion of the signal current goes straight to earth instead of flowing in the base circuit of TR2, but there is no disturbance to D.C. conditions as there would be if the slider were connected to the base.

Bias for the driver stage follows conventional lines, the base being held at slightly more than -1.5V above earth line by R7 and VR1, and with 750 ohms total emitter resistance the transistor current stabilises at approximately 2mA. This value is adequate to drive the output stage, taking into account the current step-up of the transformer T1. The whole of the emitter resistance is shunted by C4 to prevent negative feed-back at this point.

The Output Stage

The output stage consists of two transistors in class "B" push-pull. Ideally they would be completely cut off, but in a practical case this is not possible because it would introduce intolerable "cross-over" distortion. This type of distortion is caused by the large variation in input impedance which has already been mentioned as taking place over the lower range of emitter currents, and one way of avoiding it is to operate with a standing current of a milliamp or more, so that for small signals the transistors work in class "A".

This necessitates the provision of bias, but the conventional bias circuit is not

suitable because the average current in a transistor under class "B" conditions varies with the amplitude of the signal, and the capacitors needed to provide a low impedance path for the signal would charge up and cause "blocking". A low resistance bias network without capacitors is therefore essential, even though this has an adverse effect on temperature stabilizing.

In the diagram of Fig. 7 the bases are held at 140mV negative to earth line by the drop across R10, and emitter resistances of only 3.3 ohms are used. It is possible to reduce bias variations with temperature by replacing R10 by a combination of a resistor and a thermistor having a negative temperature coefficient.

A Compromise

To clear up any remaining "cross-over" distortion it is usual to select a ratio for the driver transformer T1 lower than that which would give perfect matching. For instance, in the circuit shown the ratio of T1 is 3:1, which transforms the output impedance of the driver transistor to one-third squared ($\frac{1}{3} \times \frac{1}{3}$) of its actual value, making it about 5,000 ohms. Thus the output transistors are driven from a sufficiently high impedance to mask minor variations in their own input resistance, which is approximately 1,000 ohms.

The output transformer is chosen so as to present a load to each collector which will cause neither the collector dissipation nor the maximum peak current of the transistors to be exceeded. In the circuit of Fig. 7 the collector load impedance is arranged to be 66 ohms for each transistor, so that the peak current with a 6V supply is $\frac{6 \times 1,000}{66} = 90\text{mA}$ (approximately). This corresponds to a power output of $\frac{90 \times 6}{2} = 270\text{mW}$ for the pair.

High Efficiency Output Stage

For this comparatively large output, owing to the high efficiency of the class "B" system, the max dissipation in each transistor will be about 60mW, which is not beyond their rating. On ordinary programme material the mean value of output power, and consequently the dissipation, will be greatly reduced, so that in normal operation there is a generous margin of safety.

This margin is increased still more when the apparatus is working, as it usually will be, at temperatures lower than the 45 degrees C at which dissipation ratings are normally quoted.

Feed-back from the speech coil to the base of TR2 takes place via R11. This

Fig. 7.—Several features that have been described will be recognized in this diagram, which shows the circuit arrangement of a transistorized A.F. amplifier.

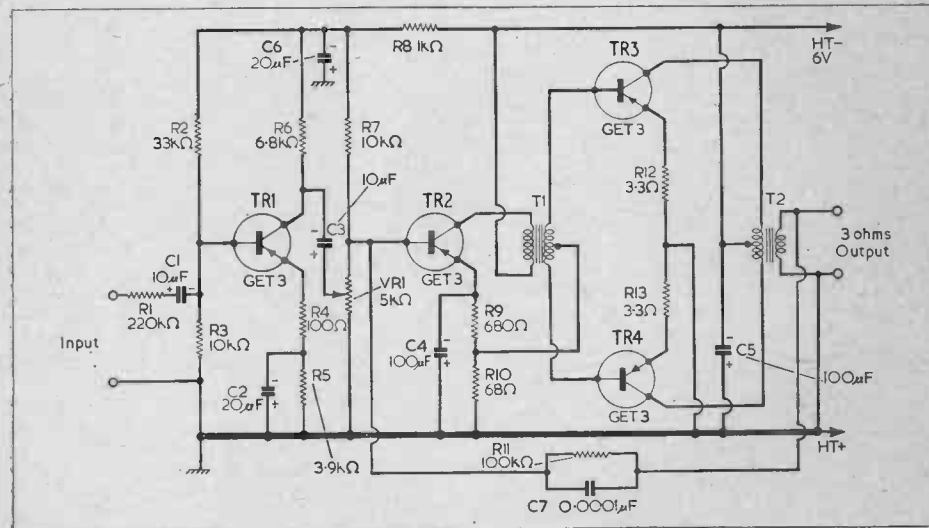
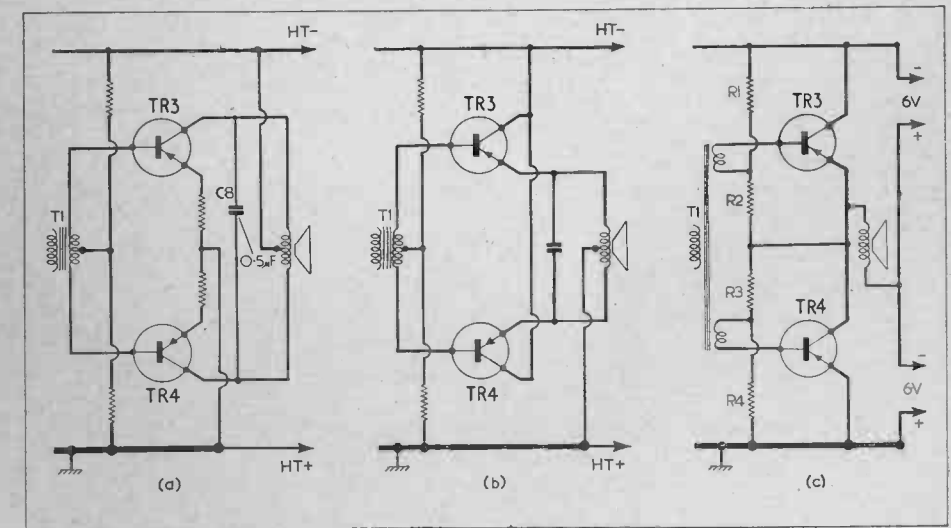

Fig. 8.—Three kinds of output circuit that can be used to couple the output from a pair of transistors in push-pull to the speech coil of a speaker.



reduces distortion and at the same time lowers the output impedance of the amplifier. The capacitor C7 introduces a measure of phase correction and prevents positive feed-back with possible oscillation at higher frequencies. Since with a class "B" output stage, the current from the battery varies with the signal, good decoupling is essential, and this is provided by the large capacitor C5 across the battery and the decoupling combination R8, C6, which feeds all supplies to the first stage and the bias current to the second stage.

Output Circuits

Several methods are possible for coupling to the speaker, and output arrangements are shown in Fig. 8. At (a) the output transformer is omitted and the two halves of a centre-tapped speech coil constitute the collector loads. The design of such a loudspeaker does not present great difficulty because the impedance required is low. A disadvantage of this arrangement is the difficulty of applying negative feed-back, but it simplifies the circuit and saves a major component. The capacitor C8 is necessary to limit the rise in high note response which occurs when a loudspeaker is fed from a high impedance source.

In Fig. 8(b) centre-tapped speech coil is again employed, but in this case the transistors are used in common collector connection, with the load in the emitter leads. This circuit has inherent feed-back, which gives it an advantage over the arrangement in Fig. 8(a), but the stage gain is smaller and the feed-back does nothing to reduce distortion in the driver stage which has to provide higher power than in the common emitter case.

In Fig. 8(c) series connection of the transistors across the H.T. supply and a centre tap on the latter enables push-pull operation to be employed without either output transformer or tapped speech coil. In addition there is no difficulty in taking negative feed-back from the speech coil to earlier stages, using the same method as is shown in Fig. 7. Bias is supplied by the voltage divider R1, R2, R3, R4, so that under no-signal conditions each transistor draws a small current.

Provided that the transistors are matched, the junction point of the emitter of TR3 and the collector of TR4 will be at the same potential as the centre tap of the battery, and no current will flow in the speech coil. On applying a signal from the driver stage, TR3 and TR4 will be driven alternately to pass a higher current, which will in each case pass through the speech coil.

Although, as the speech coil is in its emitter lead, at first sight it may appear that TR3 is operated with common collector, it will be realized that this is actually common emitter operation, because the input signal is applied between base and emitter and the output is taken between collector and emitter. The strangeness of their appearance in the diagram is due to the battery position on the collector side of the load.

Amplifiers with far higher power than 250mW are now being made, but since they operate on similar principles to those illustrated above a separate analysis would cover no new points and will not therefore be pursued here. The earlier stages of radio sets do, however, raise a number of new points, and these will be examined in the next chapter.

A COMPLETE TRANSISTOR RECEIVER

PRACTICALLY all the essential features of transistor radio circuitry may be explained by the thorough examination of one single receiver and a consideration of possible variants. The set selected for this purpose is the American "Regency" receiver which was the first commercially available transistorized pocket radio in the world, and since a few of these sets have found their way into this country, this circuit information may be of direct use to service engineers who may be asked to deal with faults that develop in them.

A Commercial Receiver

The circuit is shown in Fig. 9 and it employs four transistors. The first is a self-oscillating frequency-changer, the second and third are I.F. amplifiers and the fourth is a common-emitter class "A" output stage. Detection and A.G.C. are provided by a crystal diode. The transistors are of n-p-n type so that the H.T. line, which is supplied from a 22.5V hearing aid battery, is positive. The use of a circuit with n-p-n transistors for our illustration will serve to remind readers of the existence of the alternative type, and it underlines the fact that, apart from polarities, circuits are identical in the two cases.

The A.F. signal is fed via C14 to the base of the output transistor TR4, and the output signal is taken from the collector through the matching transformer T4 to the loud speaker. Biasing arrangements are conventional, the voltage divider R12, R13 supplying the base, and R14 producing the necessary D.C. feed-back to give stability against temperature changes. R14 is shunted by C15 to prevent reduction of gain due to A.F. feed-back.

The collector current for this stage is about 2.5mA, so that the emitter is about 2.5V positive to earth line, and it will be noticed that this voltage is used to feed the base of a previous stage, with consequent saving of two resistors. As a result

of this voltage drop the effective H.T. voltage on TR4 is 20V, so that the load for maximum output is $\frac{20 \times 1,000}{2.5} = 8,000$ ohms, derived as explained previously on page 11 in Chapter 3, when discussing class "A" stages. This high value of load enables high gain to be realized in this stage compared with the class "B" stages described in the last chapter, but the output power is small, in the neighbourhood of 25mW. A.F. feed-back through the resistance of the H.T. battery is minimized by shunting it with C16.

The secondary of the I.F. transformer T3 feeds the signal to the crystal diode detector D1, whose load consists of the volume control VR3. The A.F. modulation is developed across VR3, while the I.F. component is shunted to earth via C13. The parallel path for some of the rectified current through R11 will be considered later when examining the A.G.C. arrangements, but in the meantime it should be noted that a slight positive bias is provided from the H.T. positive line via R11 and R4 which improves the sensitivity of the diode to weak signals.

Low Intermediate Frequency

TR3 functions as a common emitter amplifier at an I.F. of 262Kc/s, the input and output transformers having tuned primary windings and closely coupled untuned secondaries with a step-down turns ratio. H.T. to the collector is obtained via R10, and C11 provides decoupling to the emitter.

As already mentioned, base bias to this stage is derived from the emitter resistance of TR4 instead of from the more usual voltage divider. This places the base about 2.5V positive with respect to earth line, so that to establish its emitter at the correct potential, TR3 passes a little less than 1mA through its 2.7k Ω emitter resistance R8. The earthy end of the secondary of T2 is

provided with a low-impedance I.F. path to emitter by C10.

Neutralized Amplifiers

The final point to consider in this stage is the neutralizing carried out by C9 and R9. This technique used to be common in valve receivers when triodes were used for R.F. purposes, and it is still current practice in some special receiving circuits and in transmitters. It is made necessary by the coupling existing between input and output circuits due to internal grid-anode capacitance.

Transistors have somewhat more complex internal couplings, so that complete elimination of their effects requires more than a single capacitance, and in this particular case capacitance and resistance in series are used. In most cases, however, it is sufficient to take account of collector-base capacitance only, and neutralizing is then accomplished by adding capacitance between the base of the transistor and the secondary of the transformer, which is in its collector circuit.

The value required is the capacitance of the collector-base multiplied by the ratio of the transformer, and it is essential for the windings to be connected in the correct sense. Since the capacitance of transistors varies between fairly wide limits, it is customary for the makers of the "Regency" set

when supplying replacement transistors to supply with them a neutralizing capacitor of appropriate size, in the range 100-200 pF. Incorrect neutralizing can result in a reduction of gain or instability, and it always causes difficulty in lining up I.F. circuits because their tuning becomes interdependent.

A minor variation of this I.F. circuit that may be encountered is the tapping down of the collector into the transformer primary. Less likely is the use of double-tuned transformers, but in this case the base would be fed from a tapping on the tuned secondary winding. The use of intermediate frequencies lower than the standard 470kc/s in transistor receivers is brought about by limitations in high frequency performance of the transistors used and the desire to achieve maximum gain and selectivity. It seems certain that improvements in transistors will be followed by a move towards use of the standard frequency.

Automatic Gain Control

The first I.F. stage built around TR2 is identical with the one just described, with the important exception of the bias arrangements. The essential difference is that the lower end of the divider feeding the base, instead of going to the earth line, goes to the diode load. The net effect of this is for the bias to the base of TR2 to be reduced when a signal is rectified by D1. This can

be regarded either as being due to negative bias current being fed via R11 to the base, in opposition to the positive bias via R4; or as being due to the lower end of the voltage divider being lowered in potential by the rectifier signal current so that the base too is pulled down.

As was explained in Chapter 2, a reduction in bias causes a rise in input impedance, so that less drive current flows in the circuit and gain falls, and since the reduction in bias is dependent on the magnitude of the signal, the arrangement constitutes an automatic gain control system. It will be noted that a low value of emitter resistance is used for TR2 since the same action which reduces bias changes with temperature variations also tends to offset deliberate efforts to change bias for A.G.C. purposes.

Although alternative methods of obtaining A.G.C. have been described, the only one which has been adopted generally is that given above, and the variants likely to be encountered concern themselves with the way in which the signal is made to vary the bias.

In one particular case, that of the Pam Model 710, a transistor detector is employed operating in a manner analogous to an anode bend valve detector. Some resistance is included in the emitter circuit so that when a signal causes current through the transistor to rise, its emitter becomes more negative with respect to the earth line. It should be mentioned, incidentally, to avoid confusion, that this receiver uses p-n-p type transistors. By connection via a suitable network, the emitter of the I.F. transistor may be made to follow the D.C. potential of the detector emitter so that its bias decreases as the signal increases thus giving rise to A.G.C.

The Frequency Changer

The frequency changer TR1 is of the self-oscillating type. H.T. is supplied to the collector of TR1 via R3, which is decoupled by C4; base bias is provided from the H.T. line through R1, and temperature compensation is achieved by the emitter resistance R2. The emitter, as far as R.F. is concerned, is tapped via C2 into L3 which is tuned by one section VC2 of the tuning gang in series with the tracker C3. The winding L4 in the collector circuit is coupled to L3 and produces the feed-back necessary to make the transistor oscillate.

L1, which is wound on a ferrite rod, is tuned to the signal frequency by VC1, and the low impedance winding L2 couples the signal via C1 into the base of TR1. The I.F. signal produced by the mixing in TR1 of the signal and the local oscillation is fed

into the tuned primary of T1, whose secondary feeds the base of the first I.F. amplifier TR2.

All self-oscillating frequency-changer circuits are basically similar to this one, and variants consist of such things as a separate emitter winding instead of a tap on the tuned circuit, or the inclusion of resistance to level out the amplitude of oscillation over the tuning range and so prevent "squegging".

Greater scope for variety occurs when two transistors are used to separate the functions of oscillation and mixing, since both the oscillator circuit and the method of injecting the oscillation into the mixer can take several different forms, but little difficulty should be experienced in following their mode of operation.

In the "Regency" set a class "A" output stage is used, so that the mean H.T. current does not vary with the audio signal and decoupling of the frequency-changer is comparatively elementary, with no detriment to performance. In the case of class "B" output, however, decoupling of the frequency changer stage has to be much more thorough, since otherwise variations of the H.T. potential brought about by the varying load will cause the oscillator frequency to vary in sympathy and create a severe form of distortion.

Transistor D.C. Converter

One final circuit requires mention to complete this review of the radio use of transistors, and that is the D.C. converter used in hybrid valve-transistor sets to provide H.T. for valve stages from the valve L.T. supply. The basic circuit of all such converters is the same, in that the transistor is made to behave as an off-on switch to provide pulses of current to the primary of a transformer so that current in the secondary may be rectified to produce D.C. at a higher voltage.

This switching action is invariably brought about by use of a blocking oscillator circuit similar to those already familiar to readers from their use in television time-bases. The circuit in Fig. 10 serves to illustrate the action. When the supply is first connected to the transistor, current starts to build up in L2, and in doing so it induces current in L1 in such a direction as to drive the base negative and so increase the collector current further.

This process continues until a condition of saturation is reached, and there is no further rise in current and therefore no further drive communicated to the base via L1. During the whole of this period the transistor collector voltage is very low, since all the voltage appears across the induct-

Fig. 9.—Complete circuit diagram of the Regency pocket portable, the first American all-transistor radio receiver to be marketed. It employs n-p-n transistors, as indicated by the direction of the arrowhead in each emitter symbol, and consequently the high-potential H.T. line is positive. The circuit would be identical for p-n-p transistors, but all the polarity signs would be reversed.

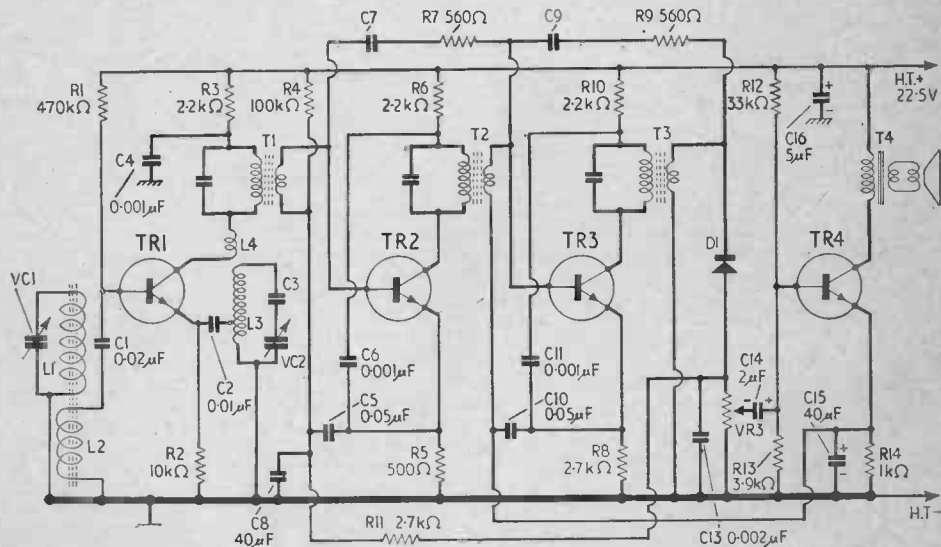

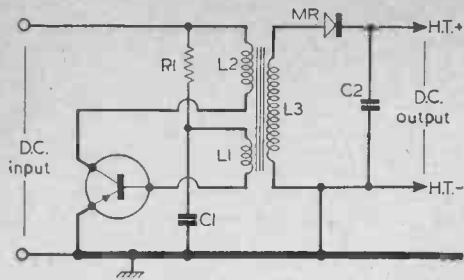

Fig. 10.—Basic circuit of a transistor D.C. convertor. Driven from a 1.5V battery, an output of 20-30V can be obtained. With higher driving voltages, there is no difficulty in obtaining 90V H.T. for all-dry valves.

ance L2 and there is little power loss in the transistor. As soon as base drive ceases, the current through L2 begins to decrease, and in doing so it starts to drive the base

positive, thus decreasing collector current still more and driving the base more positive, so that the transistor is cut off.

The transistor remains cut off for a period determined mainly by the time-constant of R1 and C1, and when it starts to conduct again the whole cycle of events repeats itself, so producing regular pulses of current in L2. While the transistor is cut off there is again little dissipation in the transistor, so that practically all the energy from the battery goes into the transformer, and very high efficiency can be obtained.

Rectified Output

A similar pulsating current at a higher voltage is induced in the winding L3, and is peak rectified by the rectifier MR and capacitor C2 to give the required D.C. output. Possible variations to this circuit would be the returning of R1 to the opposite side of the D.C. input circuit, or the inclusion of the drive winding in the emitter circuit instead of the base circuit.

GENERAL SERVICING NOTES

THE basic similarity between valve and transistor circuits has been demonstrated in previous chapters and it is therefore not surprising to find that fault finding and servicing routines for transistor equipment follow the same general lines as those already familiar for valve equipment. In view of this fact, it will not be necessary in this final chapter to describe procedures in detail and we shall be able instead to concentrate on points where they differ from standard practice or where special precautions are desirable to avoid possible damage.

As in the case of valve-operated equipment, fault finding methods may be varied according to the available test apparatus, but the majority of problems can be tackled successfully with nothing more elaborate than a good multi-range meter. Having ensured that the H.T. supply voltage is correct, operation of the equipment is then checked by a stage-by-stage measurement of currents and voltages.

Taking Measurements

The direct measurement of current usually means breaking into the circuit, which is particularly inconvenient in the case of the printed wiring likely to be used in much transistorized equipment, so wherever possible currents should be deduced from voltage readings across resistors in the circuit.

For instance, there is nearly always a resistor in the emitter circuit as part of the bias stabilizing arrangements, and the voltage across this enables the emitter current to be calculated. This voltage is unlikely to be more than a volt or so, and to avoid upsetting circuit conditions the internal resistance of the meter used should be at least 10,000Ω per volt. In class B output stages, emitter resistances are either not used or are of such low value as to necessitate use of a milli-voltmeter, and in this case current measurement may be the only practicable method.

Although more mechanically robust than

a valve, a transistor is more easily damaged by electrical overload, and in carrying out these tests it is most important to avoid accidental short-circuits with the meter probes or clips.

Possible Causes of Damage

Two mistakes which can cause damage are a direct connection from H.T. line to transistor base and short-circuiting of the emitter resistance; in each case bias current, and consequently collector current, rises to an excessive value so that the transistor is either burnt out or its characteristics permanently impaired.

A third, less obvious, source of danger is a momentary short-circuit between earth and the collector of an output transistor. While the short-circuit is taking place, no harm comes to the transistor but a very heavy current passes through the primary of the output transformer. The damage is done when this heavy current is interrupted by the removal of the short-circuit, with production of a high-voltage surge.

Yet another possible source of danger is the use of an unearthed electric soldering iron. Irons often have a very slight leak when hot, and the resulting current can be sufficient to damage a new transistor while its leads are being soldered to a piece of earthed equipment, and the cause might not be even suspected.

It is not intended to suggest by this that the transistor is an unduly difficult device to handle, but merely to underline the fact that its ratings must be respected and, like all other miniature components, its capacity to withstand overload is restricted. It might be mentioned in passing that the vast majority of failures of crystal diodes in T.V. equipment are due to carelessness or faults in other components rather than to defects in the crystal themselves.

It is presumed that in most cases a service manual will be available so that readings may be checked against the current values, but for guidance in other cases some typical

currents are quoted below. Frequency-changer, I.F. and low-level A.F. stages usually take a collector current (and therefore an emitter current too) of 0.5 to 1.0mA. Driver or small class A output stages take 3.0 to 6.0mA. 200mW class B output transistors under no-signal conditions take about 1.0mA apiece.

However, in car radio or in public address amplifiers much higher currents flow in the power transistors employed, quiescent currents of 10.0mA or more being possible in class B stages, whilst class A output stages may take as much as 300mA.

If the current in any stage differs by a considerable margin from the expected value, the cause may obviously be due either to a fault in the components feeding the transistor or in the transistor itself. In any case the next step must be to take the transistor out of the circuit since, apart from the possibility of its being damaged, its presence is almost certain to result in misleading values being obtained when testing the other components.

This is because, unlike the thermionic valve, whose electrodes in the absence of a heater supply can take no current, the electrodes of the transistor provide non-linear resistance paths. In removing the transistor care should be taken not to overheat it by prolonged application of the soldering-iron, and the use of a heat shunt is to be recommended in all cases. A further point to be watched when checking the values of resistors *in situ* is to take account of the presence of the low voltage electrolytic capacitors which are extensively used in transistor circuits.

Transistor Faults

The transistor itself should be tested as described later in this chapter, but even if it is found to be faulty a replacement should not be put in circuit until all associated components have been checked, since it is quite likely that the transistor fault has been caused by failure of other components.

It may be appropriate, at this stage, to consider some of the faults that may occur in transistors and the way in which they may be caused. The majority of transistor failures will come under one of the following headings: (a) electrodes open-circuited, (b) electrodes short-circuited, (c) excessive I_{CO} , (d) low gain.

Fault (a) could be caused by bad welding in manufacture, but this is very rare indeed in modern transistors and the cause is much more likely to be gross electrical overload. Extreme carelessness with a soldering iron is a possible but less likely cause. Fault (b) is unlikely to be due to a manufacturing

defect, and overheating due to excessive dissipation or careless soldering is the most probable reason for it. A breakdown of the junction by a high voltage surge may also cause this fault.

Failures in categories (c) and (d) frequently occur together. They often develop over a period, and their cause is not easy to determine. Ingress of moisture through faulty sealing is one reason, moderate overload for a long time is another, and any overheating not sufficient to cause faults (a) and (b) may cause this form of deterioration.

Signal Tracing

Signal tracing through the set may be used in addition to the stage-by-stage measurement of operating currents, but since general procedure does not differ from that used with valve sets, only a few special points will be mentioned here. Signals should never be fed into the set in such a way as to disturb D.C. conditions, and coupling through a capacitor or inductive loop should be employed.

When injecting an A.F. signal, a series resistance of 10,000 ohms or so should be used in addition to a capacitor in order to avoid distortion of the input current waveform by the non-linear input characteristic of the transistor. It must be remembered that the transistor is a current-operated device and therefore it is the current waveform that is important.

For this same reason it is useless to check distortion by examination of the waveform of the voltage at the base electrode of the output transistor, where the required sinusoidal current produces a far from sinusoidal voltage. The correct point at which to check waveform is across the

Fig. 11.—This simple diagram shows the circuit arrangement for testing p-n-p transistors. Collector current is measured by the 0.5mA meter, and base current by the 0.50μA meter. For n-p-n transistors the circuit is identical but all polarity signs are reversed.

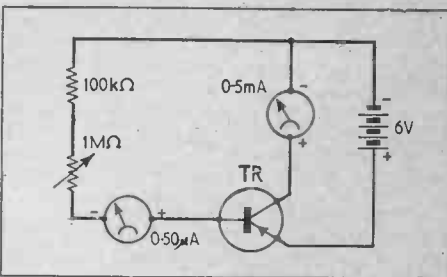

output load, where current and voltage waveforms correspond.

Specific faults in transistor sets arise from similar reasons to those in the case of valve apparatus. A.F. instability, for instance, is often caused by defective decoupling of the H.T. supply, but besides collector decoupling, that to the base bias network should also be checked. Instability at I.F., too, may be due to decoupling faults, or it can be caused by incorrect neutralizing. This latter trouble might arise if the capacitor became open-circuited, or if its value needed changing to suit a replacement transistor.

A.F. distortion is most likely to arise through wrong bias conditions, or from one transistor of a class B output pair being defective. Less probable causes are faults in the negative feed-back loop, or failure of A.G.C. allowing severe overloading of the final I.F. stage.

Testing Transistors

The testing of transistors for all characteristics is quite a complex business, but a very good idea of their condition may be gained by measuring I_{CO} and current gain in the common emitter connection by means of the set-up given in Fig. 11. The values given in the diagram are suitable for small A.F. types, such as GET3, OC71, etc.

When used for testing power type transistors they should be modified by increasing meter current ranges and decreasing resistance values by a factor of ten times. No limiting resistance is included in the collector circuit of Fig. 11, since a good transistor does not pass excessive current and one that is faulty does not require protection. However, the meter in this circuit should incorporate some form of overload protection.

The first reading is taken with the base not connected to anything. The collector current is then the collector junction leakage current times the current gain, its value lying typically in the range 0.2 to 0.5mA, and it is sometimes designated I_{CO} . No current at all would indicate an electrode disconnection, while a figure in excess of 1.0mA would suggest that deterioration had taken place.

The current gain is found by supplying

current to the base and seeing how many times greater is the resultant change in collector current than the change in base current reading. If no 0.50 microammeter is available, an approximate figure may be obtained by connecting the base to H.T. negative through 220,000 ohms, so that approximately 27μA of base current flows, and then dividing 27 into the resulting increase in collector current in microamps.

Use of a meter as shown in the circuit diagram is preferable in the interests of accuracy since it removes errors due to variations of the resistor from its nominal value and also allows the gain to be measured between specific values of collector current.

By adjustment of the variable resistance the collector current is first set to 1.0mA and the value of base current is noted; a further adjustment of the resistance is then made to bring the collector current up to 2.0mA, and the new value of base current is noted. The difference in micro-amperes between the two values of base current, divided into 1,000 (the 1mA increase in collector current in micro-amps), gives the current gain of the transistor, which can then be compared with the figure in the manufacturers' literature.

Similar measurements may be taken at higher values of collector current to correspond to actual test points quoted by manufacturers, but they will not be found to differ a great deal from those obtained over the current range given above, and difficulty may be experienced with "climbing" current due to the appreciable temperature rise caused by the greater dissipation.

When testing power type transistors they should be mounted in an appropriate "heat sink" to conduct away the heat and minimize temperature rise. From what has been said previously it will be clear that this test set-up as described is intended for the more common n-p-n type transistor, but for the p-n-p type it is only necessary to reverse battery and meter polarities.

In conclusion, it should be emphasized that the most important requisite when dealing with faults in transistor equipment is the knowledge of how the transistor operates, and this knowledge should be possessed by any reader who has carefully followed the earlier chapters in this booklet

