

AMPEREX

*complete series
of tubes for*

Hi Fi

audio equipment

*Amperex
30 tubes*

Represented by
SHEPARD-WINTERS CO.
7559 Melrose Ave., L. A. 46, Calif.
WE. 8-2996

AMPEREX ELECTRONIC CORPORATION
230 Duffy Avenue
Hicksville, L. I., New York

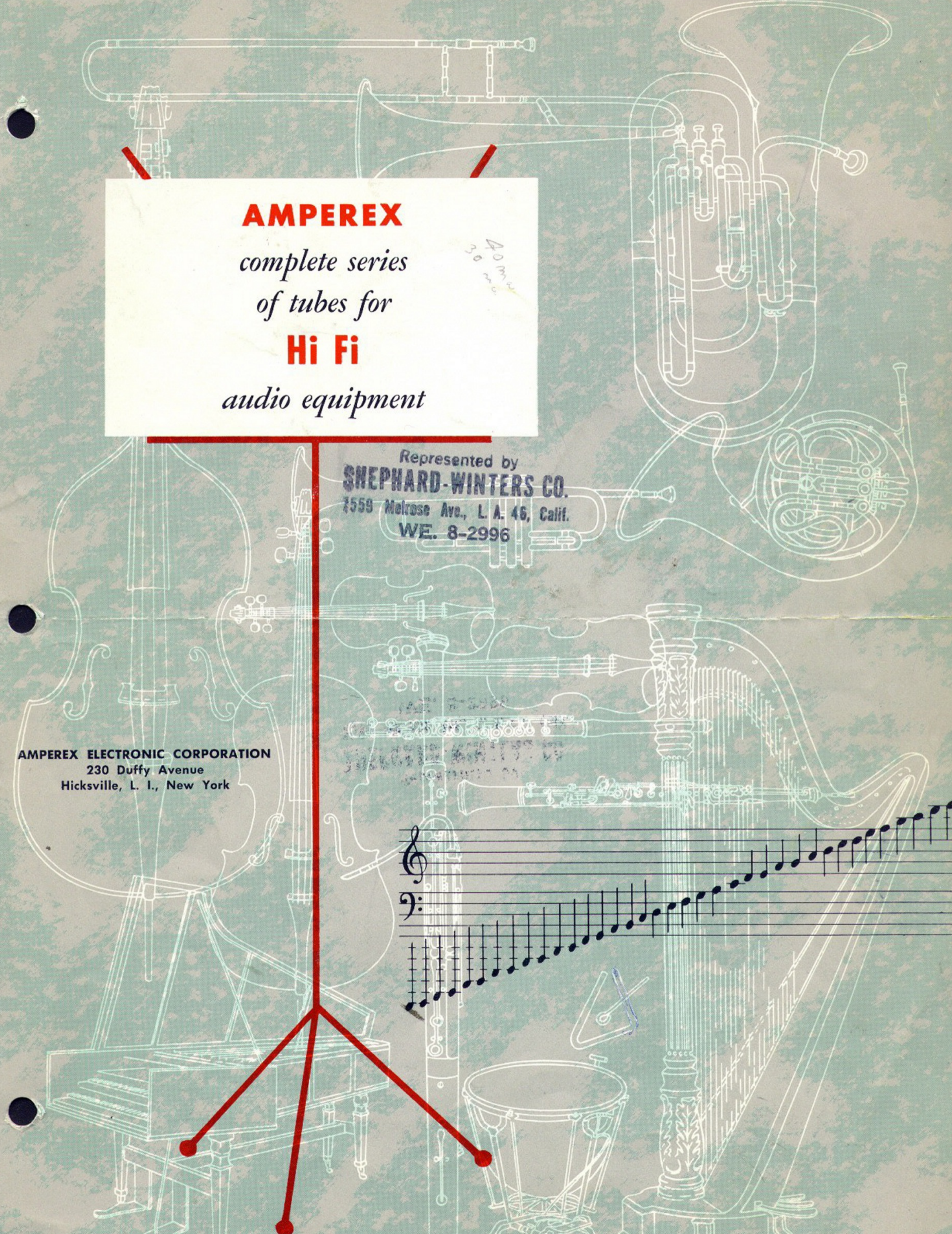
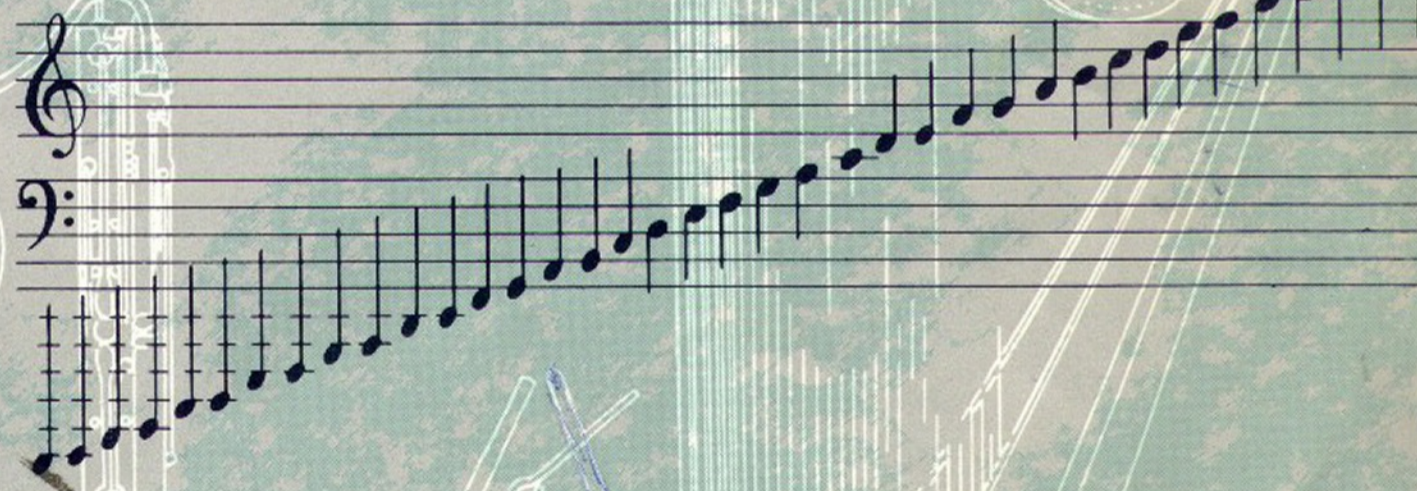



Amperex ELECTRONIC CORPORATION is proud to offer to its customers the unique developments of its affiliate, one of the largest tube manufacturers in the world, PHILIPS of the Netherlands.

We are pleased to introduce this line of tubes specifically designed for use in high quality audio equipment. Some of the design features of these tubes and performance possibilities are described in this folder.

Manufactured and tested under the highest standards, the complete series of Hi-Fi tubes have gained a world-wide reputation for superior performance under the most exacting conditions.

In addition to maintaining adequate stocks of these tubes in our Hicksville plant, the services and extensive experience of the Amperex Application Engineering Laboratory are available to the users of these tubes.

For further information communicate with AMPEREX ELECTRONIC CORPORATION, Semiconductor and Special Purpose Tube Department.

In addition to the AMPEREX tube types listed in this brochure, the following are also available. (Detailed data on request.)

VOLTAGE AMPLIFIER TYPES

ECC 81—Medium-gain dual triode with low hum, noise and microphonics. Replaces the 12AT7 without circuit changes.

ECC 82—Low-gain dual triode with low hum, noise and microphonics.* Replaces the 12AU7 without circuit changes.

**Maximum levels specified and guaranteed.*

RECTIFIER TYPE

EZ 80—Indirectly heated, full-wave rectifier with 6.3 v., 0.6 amp. heater, 90 ma. output capacity and 9-pin miniature construction.

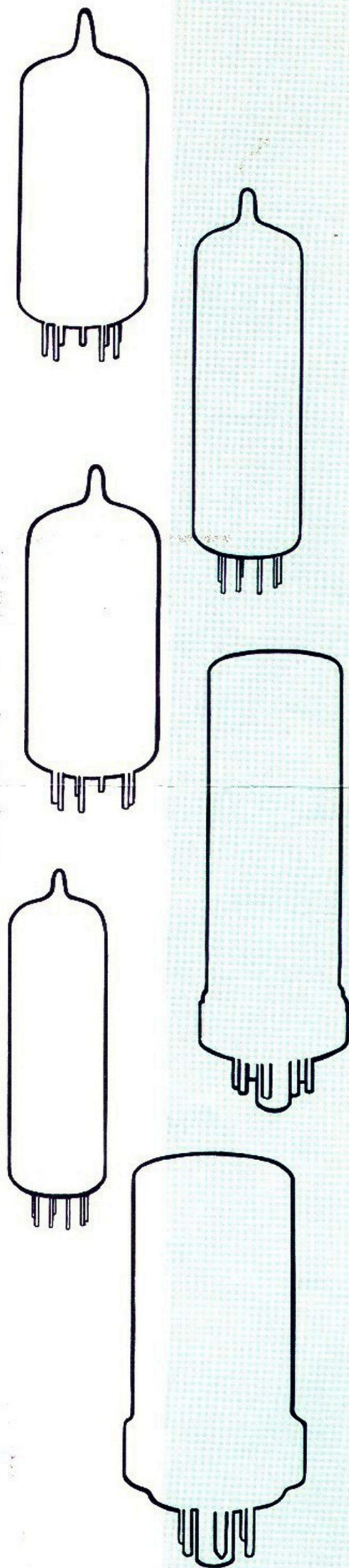

A high-gain pentode of special design, the EF 86 is particularly suitable for preamplifier and input stages, in which hum, noise and microphony must be kept to a minimum. The low-frequency noise generated by the tube is equivalent to a voltage of 2 μ V on the control grid for a bandwidth from 25 to 10,000 c/s. The electrode structure has been made particularly rigid to keep the microphony of the tube at a very low level. There are no appreciable internal resonances below 1000 c/s, the vibration at higher frequencies being effectively damped out by the chassis and the tube holder.

Hum is kept to a minimum by winding the heater as a bifilar twisted pair of wires, with the magnetic field of the one wire opposed to that of the other. Effective internal screening reduces the internal tube capacitances through which hum can be transferred to the output. The screening also shields the electrode structure from the alternating fields set up by transformers, etc., which otherwise would induce a.c. line frequency voltages in them.

HEATER

Filament Voltage	6.3	V
Filament Current	0.2	A
Can operate with other tube filaments in series or parallel, A.C. or D.C.		

CHARACTERISTICS

Plate Voltage	250	V
Grid No. 3 Voltage	0	V
Grid No. 2 Voltage	140	V
Plate Current	3	mA
Grid No. 2 Current	0.6	mA
Grid No. 1 Voltage	-2	V
Transconductance	2000	micromhos
Plate Resistance	2.5	M Ω
Amplification Factor (Grid No. 1 to Grid No. 2)	38	

DESIGN CENTER MAXIMUM

Plate Voltage	300	V
Plate Dissipation	1.0	W
Screen Dissipation	0.2	W
Screen Voltage	200	V
Cathode Current	6.0	mA
Grid Resistance (Plate Diss. > 0.2W)	3.0	M Ω
Grid Resistance (Plate Diss. < 0.2W)	10	M Ω
Filament to Cathode Voltage (cath. pos.)	100	V
Filament to Cathode Voltage (cath. neg.)	50	V
Filament to Cathode Resistance max.**	20	K Ω

**When used as a phase inverter immediately preceding the output stage, filament to cathode resistance max. may be 120 K Ω .

TYPICAL OPERATING CONDITIONS

Operating Conditions as R. C. Coupled A. F. Amplifier

PENTODE CONNECTION

E_b (V)	R_1 (k Ω)	I_k (mA)	R_{g2} (M Ω)	R_k (k Ω)	Voltage Gain	E_o (V _{rms})	d_{tot} (%)	R_{g1}^\ddagger (k Ω)
400	100	3.3	0.39	1.0	124	87	5.0	330
350	100	2.85	0.39	1.0	120	75	5.0	330
300	100	2.45	0.39	1.0	116	64	5.0	330
250	100	2.05	0.39	1.0	112	50	5.0	330
200	100	1.65	0.39	1.0	106	40	5.0	330
100	100	1.0	0.47	1.5	95	22	5.0	330
400	220	1.55	1.0	2.2	200	73	5.0	680
350	220	1.4	1.0	2.2	196	63	5.0	680
300	220	1.1	1.0	2.2	188	54	5.0	680
250	220	0.9	1.0	2.2	180	46	5.0	680
200	220	0.75	1.0	2.2	170	36	5.0	680
100	220	0.55	1.0	2.7	150	24.5	5.0	680

TRIODE CONNECTION (g_2 to pl: g_3 to k)

E_b (V)	R_p (k Ω)	I_p (mA)	R_k (k Ω)	Voltage Gain	E_o^* (V _{rms})	d_{tot}^* (%)	R_{g1}^\ddagger (k Ω)
400	220	1.05	3.9	32	74	3.8	680
350	220	0.9	3.9	31.5	62	3.7	680
300	220	0.8	3.9	31	51	3.7	680
250	220	0.65	3.9	30.5	39	3.5	680
200	220	0.5	3.9	30.5	28	3.1	680

*Output voltage and distortion at start of positive grid current. At lower output voltages the distortion is approximately proportional to the voltage.

‡Grid resistor of following tube.

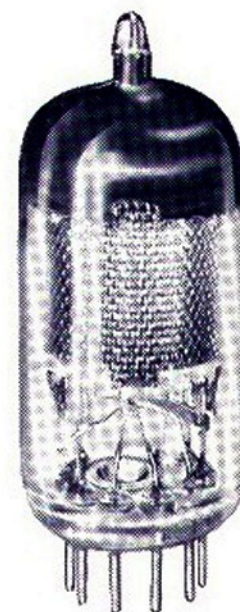

EF86

(6267)

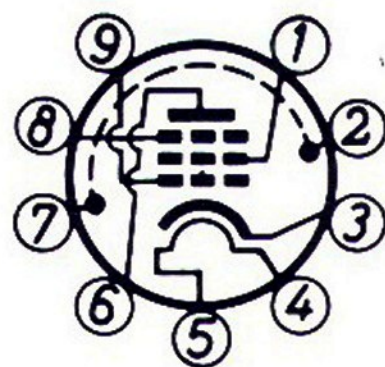

R.C. coupled amplifiers or phase splitters can conveniently be built around a high- μ double triode with separate cathodes such as the ECC 83. The amplification factor of this tube is 100, so that adequate gain can be obtained in the cathode-coupled type of phase splitter used for the AMPEREX-designed 5-tube 10-W amplifier and the 20-W amplifier using 6CA7 output tubes.

HEATER

Can operate with other tube filaments in series or parallel, A.C. or D.C.

The heater is center-tapped and the two sections may be operated in series or in parallel.

Series: Filament voltage applied between pins 4 and 5.

Parallel: Filament voltage applied between pin 9 and pins 4 and 5 connected together.

	Series	Parallel	
Filament Voltage	12.6	6.3	V
Filament Current	0.15	0.3	A

CHARACTERISTICS (each section)

Plate Voltage	100	250	V
Plate Current	0.5	1.2	mA
Grid No. 1 Voltage	-1.0	-2.0	V
Transconductance	1250	1600	micromhos
Amplification Factor	100	100	
Plate Resistance	80	62.5	K Ω

DESIGN CENTER MAXIMUM (each section)

Plate Voltage	300	V
Plate Dissipation	1.0	W
Cathode Current	8.0	mA
Grid Resistance**	2	M Ω
Filament to Cathode Voltage	180	V
Filament to Cathode Resistance††	20	K Ω

**With grid current biasing max. grid resistance = 22 M Ω .

††When used as a phase inverter immediately preceding the output stage, filament to cathode resistance max. may be 150 K Ω .

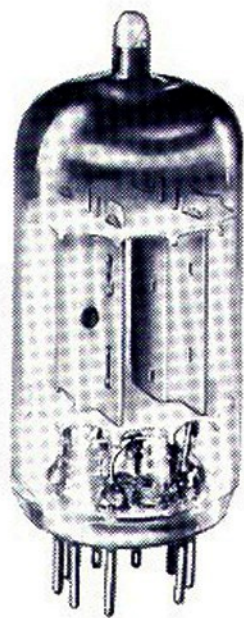

ECC83

(12AX7)

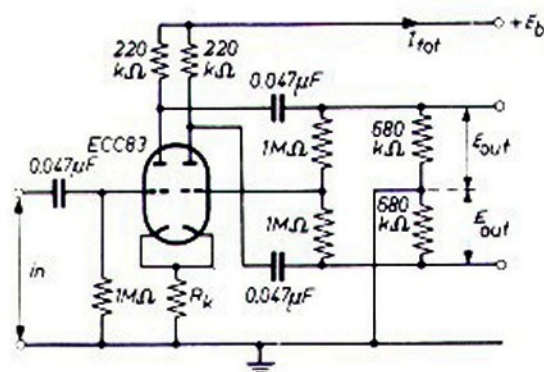
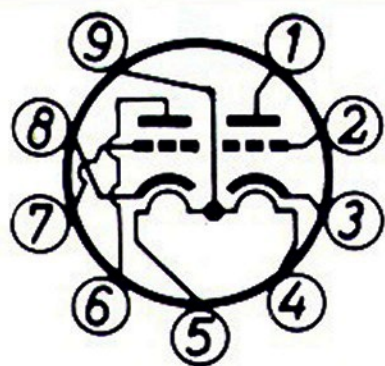

Circuit A

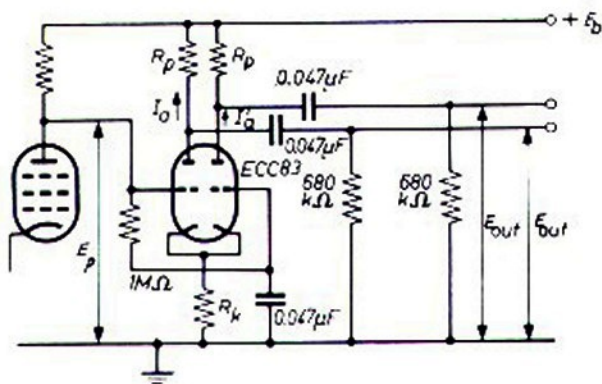

Circuit B

TYPICAL OPERATING CONDITIONS

Operating Conditions as R. C. Coupled A. F. Amplifier

(with cathode bias)

E_b (V)	R_p (k Ω)	I_k (mA)	R_k (Ω)	Voltage Gain	E_o^* (V _{rms})	d_{tot}^* (%)	$R_{g1} \ddagger$ (k Ω)
400	47	2.45	680	44	37	3.6	150
350	47	1.98	820	42.5	33	4.4	150
300	47	1.55	1000	40	26	5.0	150
250	47	1.18	1200	37.5	23	7.0	150
200	47	0.86	1500	34	18	8.5	150
400	100	1.72	820	63	38	1.7	330
350	100	1.40	1000	61	36	2.2	330
300	100	1.11	1200	57	30	2.7	330
250	100	0.86	1500	54.5	26	3.9	330
200	100	0.65	1800	50	20	4.8	330
400	220	1.02	1200	76.5	38	1.1	680
350	220	0.85	1500	75.5	37	1.6	680
300	220	0.63	2200	72	36	2.6	680
250	220	0.48	2700	66.5	28	3.4	680
200	220	0.36	3300	56	24	4.6	680

*Output voltage and distortion at start of positive grid current. At lower output voltages the distortion is approximately proportional to the voltage.

‡Grid resistor of following tube.

Typical Operating Conditions as a Phase Inverter

CIRCUIT A

E_b (V)	I_{tot} (mA)	R_k (Ω)	E_o^* (V _{rms})	Voltage Gain	d_{tot}^* (%)
250	1.08	1200	35	58	5.5
250	1.08	1200	7	58	1.1
350	1.7	820	45	62	3.5
350	1.7	820	7	62	0.7

CIRCUIT B

$E_b \ddagger E_p$ (approx.) (V)	$I_p + I_p'$ (mA)	R_k (k Ω)	R_p (k Ω)	E_o^* (V _{rms})	Voltage Gain	d_{tot}^* (%)
250	65	68	100	20	25	1.8
250	65	68	100	9	25	0.6
350	90	82	150	35	27	1.8
350	90	82	150	10	27	0.5

*Output voltage and distortion at start of positive grid current. At lower output voltages the distortion is approximately proportional to the voltage.

‡(Approx) E_p should be adjusted so that $I_p + I_p' = 1.0\text{mA}$ at $E_b = 250\text{V}$ and 1.2mA at $E_b = 350\text{V}$.

NOTES

MICROPHONICS The tube can be used without special precautions against microphonic effect in amplifiers in which the input voltage is higher than 50 millivolts when the tube is mounted in the near vicinity of a 5 watt loud speaker with an acoustical efficiency of 5%.

HUM The hum and noise level will be better than -60 db when the grid circuit impedance is less than 0.5 megohms (at 60 cps), the center tap of the heater is grounded and the cathode resistor is decoupled by a capacitor of at least 100 uf.

When operated in a single-ended output stage, the EL84 can deliver an output of up to 5.7 watts at 10% total harmonic distortion, and two EL84's in pentode push-pull yield an output of up to 17 watts at 4% distortion. As these figures suggest, this tube makes available the higher peak powers and low distortion required in medium power amplifiers used as present day high-fidelity phonograph components.

The true pentode characteristics of this tube reduce distortion at low instantaneous plate voltages which allow larger A.C. swings and increased undistorted output as compared with beam power tubes in the same power class.

HEATER

Filament Voltage	6.3	V
Filament Current	0.76	A

CHARACTERISTICS

Plate Voltage	250	V
Grid No. 2 Voltage	250	V
Plate Current	48	mA
Grid No. 2 Current	5.5	mA
Grid No. 1 Voltage	-7.3	V
Transconductance	11,300	micromhos
Plate Resistance	38	K Ω
Amplification Factor (Grid No. 1 to Grid No. 2)	19	

DESIGN CENTER MAXIMUM

Plate Voltage	300	V
Plate Dissipation	12	W
Grid No. 2 Voltage	300	V
Grid No. 2 Dissipation (zero signal)	2.0	W
Grid No. 2 Dissipation (max. signal)	4.0	W
Cathode Current	65	mA
Grid Resistance (cathode bias)	1.0	M Ω
Grid Resistance (fixed bias)	300	K Ω
Filament to Cathode Voltage	100	V

TYPICAL OPERATING CONDITIONS

Operating conditions as single tube Class "A" Amplifier

Plate Voltage	250	250	V
Grid No. 2 Voltage	250	250	V
Plate Load Resistance	5.2	4.5	K Ω
Cathode Resistor	135	135	Ω
Grid No. 1 Voltage	-7.3	-7.3	V
Plate Current	48	48	mA
Grid No. 2 Current	5.5	5.5	mA
Input (rms) Signal Voltage (output power = 50 mW)	0.3	0.3	V
Output Power ($d_{tot}=10\%$) \ddagger	5.7	5.7	W
Input (rms) Signal Voltage ($d_{tot}=10\%$)	4.3	4.4	V
Percent 3rd Harmonic Distortion	9.5	8.0	%
Percent 2nd Harmonic Distortion	2.0	5.0	%

\ddagger Output power and d_{tot} are measured at fixed bias and therefore represent the power output available during the reproduction of speech and music. When a sustained sine wave is applied to the control grid, the bias across the cathode resistor will readjust itself as a result of the increased plate and screen-grid currents. This will result in approximately 10% reduction in power output.

Operating conditions for two tubes in class "AB" Push-Pull

(See Figs. 2 and 3)

Plate Voltage	250	300	V
Grid No. 2 Voltage	250	300	V
Common Cathode Resistance	130	130	Ω
Plate to Plate Load Resistance	8.0	8.0	K Ω
Zero Signal Plate Current	2 x 31	2 x 36	mA
Max. Signal Plate Current	2 x 37.5	2 x 46	mA
Zero Signal Grid No. 2 Current	2 x 3.5	2 x 4.0	mA
Max. Signal Grid No. 2 Current	2 x 7.5	2 x 11	mA
Input Signal Voltage (rms)	8	10	V
Power Output	11	17	W
Percent Distortion	3.0	4.0	%

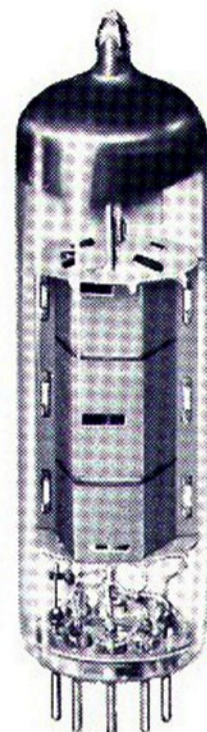

EL84

(6BQ5)



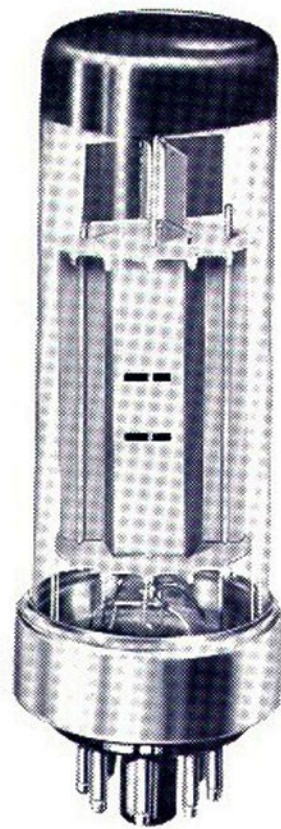

6CA7

(EL34)

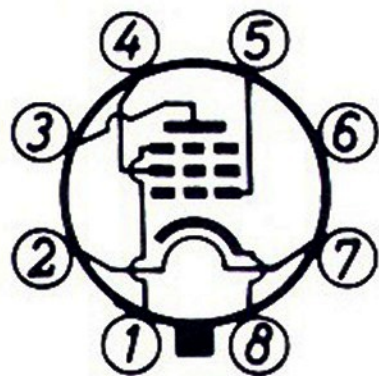

Amplifiers which provide a nominal output of 20 W to handle music with high reserve peak powers or even higher powers for public address equipment, can include an output stage equipped with two 6CA7's in push-pull.

An interesting method of connecting the push-pull output stage (Fig. 1) has been used in a recently published amplifier design. The screen grids of the 6CA7 are connected to taps on the primary of the output transformer, so that the operating conditions lie somewhere between those of a triode ("tap" connected to plate) and those of a pentode (screen grid connected to primary centertap). Thus the low distortion of a triode is combined with the high sensitivity of a pentode. The tubes are said to be operated with distributed load. Two 6CA7's in the output stage illustrated can yield an output of 20 W at 0.8% total harmonic distortion, or 37 W at 1.3% distortion, with 430 V between each plate and ground.

For public address equipment, line voltages of up to 800 V can be used, and two 6CA7's in pentode push-pull with fixed bias give an output of up to 100 W.

The maximum plate dissipation of the 6CA7 is 25 W, and it has a high mutual conductance of 11,000 micromhos.

HEATER

Filament Voltage	6.3	V
Filament Current	1.5	A

CHARACTERISTICS

Plate Voltage	250	V
Grid No. 2 Voltage	250	V
Grid No. 3 Voltage	0	V
Plate Current	100	mA
Grid No. 2 Current	14.9	mA
Grid No. 1 Voltage	-13.5	V
Transconductance	11,000	micromhos
Plate Resistance	15	K Ω
Amplification Factor (Grid No. 1 to Grid No. 2)	11	

DESIGN CENTER MAXIMUM

Plate Voltage	800	V
Plate Dissipation	25	W
Plate Dissipation (max. signal speech & music)	27.5	W
Grid No. 2 Voltage	425	V
Grid No. 2 Dissipation	8.0	W
Cathode Current	150	mA
Grid Resistance (cathode bias)	700	K Ω
Grid Resistance (fixed bias)	500	K Ω
Filament to Cathode Voltage	100	V

TYPICAL OPERATING CONDITIONS

Operating Conditions for Two Tubes in Push-Pull

Distributed load conditions with screen-grid tapping at 43% of primary turn (see fig. 1)

Plate Voltage ($V_p + V_{Rk}$)	430	430	V
Grid No. 2 Resistor (R_{g2}) (per tube)	1	1	K Ω
Screen Voltage ($V_{g2} + V_{Rk}$)	425	425	V
Plate Current (zero signal)	2 x 62.5	2 x 62.5	mA
Plate Current (max. signal)	2 x 65	2 x 70	mA
Grid No. 2 Current (zero signal)	2 x 5.0	2 x 5.0	mA
Grid No. 2 Current (max. signal)	2 x 5.1	2 x 7.5	mA
Cathode Resistor (R_k) (per tube)	470	470	Ω
Signal Input Voltage (rms)	16	26	V
Plate to Plate Load Resistance	6.6	6.6	K Ω
Power Output	20	37	W
Percent Distortion	0.8	1.3	%

These operating conditions \ddagger apply with stabilized line voltages and allow for a 25 V drop in the primary winding of the output transformer at maximum signal. If there is an additional drop of 25 V in the line voltages at maximum signal, power output = 90 W. The optimum plate-to-plate load under these conditions is 11 K Ω .

Plate Supply Voltage	800	V
Grid No. 2 Supply Voltage	400	V
Grid No. 2 Resistor (R_{g2})*	750	Ω
Grid No. 3 Voltage	0	V
Zero Signal Plate Current	2 x 25	mA
Max. Signal Plate Current	2 x 91	mA
Zero Signal Grid No. 2 Current	2 x 3.0	mA
Max. Signal Grid No. 2 Current	2 x 19	mA
Grid No. 1 Voltage	-39	V
Plate to Plate Load Resistance	11	K Ω
Input Signal Voltage (rms)	23.4	V
Power Output	100	W
Percent Distortion	5.0	%

*Common to both tubes.

\ddagger With separate screen-grid supply and fixed bias.

HEATER

Filament Voltage	6.3	V
Filament Current	1.0	A

DESIGN CENTER MAXIMUM

A. C. Supply (plate to plate) Voltage (rms)	700	V
Peak Inverse Voltage	1.0	KV
Peak Plate Current	450	mA
D. C. Output Current	150	mA
Max. Capacity (condenser input filter)	50	μ f
Cathode to Filament Voltage*	500	V

*Heater negative

TYPICAL OPERATION

A. C. Supply (plate to plate) Voltage (rms)	500	600	700	V
D. C. Output Current	150	150	150	mA
Max. Capacity (condenser input filter)	50	50	50	μ f
Limiting Resistor (min.) \ddagger	150	200	240	Ω
D. C. Output Voltage	245	293	347	V

\ddagger Per plate

These two tubes are full-wave rectifiers. The EZ 81 has a noval base and a 6.3 volt, 1 amp heater. It can supply output currents of up to 150 milliamps, and is therefore suitable for the AMPEREX 5-tube 10-watt amplifier circuit when the circuit is arranged for normal or low loading (plate to plate load 8000 Ω or 6000 Ω), with or without a radio feeder unit. The GZ 34 is mounted on an octal base and has a 5 volt, 1.9 amp heater. It can supply output currents of up to 250 milliamps.

HEATER

Filament Voltage	5.0	V
Filament Current	1.9	A

DESIGN CENTER MAXIMUM

A. C. Supply (plate to plate) Voltage (rms)	1100	V
Peak Inverse Voltage	1.5	KV
Peak Plate Current	750	mA
D. C. Output Current	250	mA
Max. Capacity (condenser input filter)	60	μ f

TYPICAL OPERATION

A. C. Supply (plate to plate) Voltage (rms)	600	900	1100	V
D. C. Output Current	250	250	160	mA
Max. Capacity (condenser input filter)	60	60	60	μ f
Limiting Resistor (min.) \ddagger	50	125	175	Ω
D. C. Output Voltage	300	450	610	V

\ddagger Per Plate

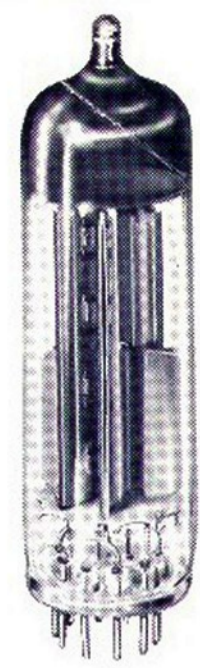

EZ81

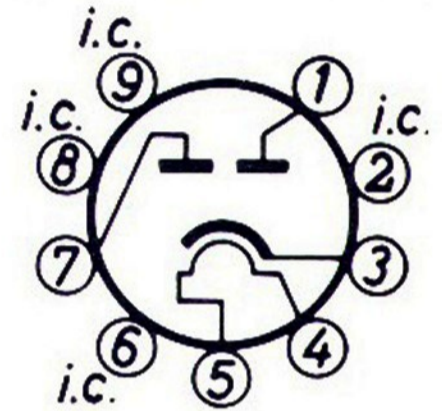

GZ34

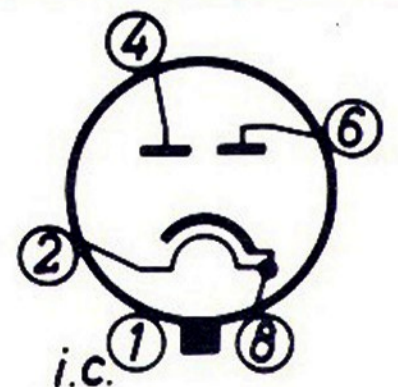
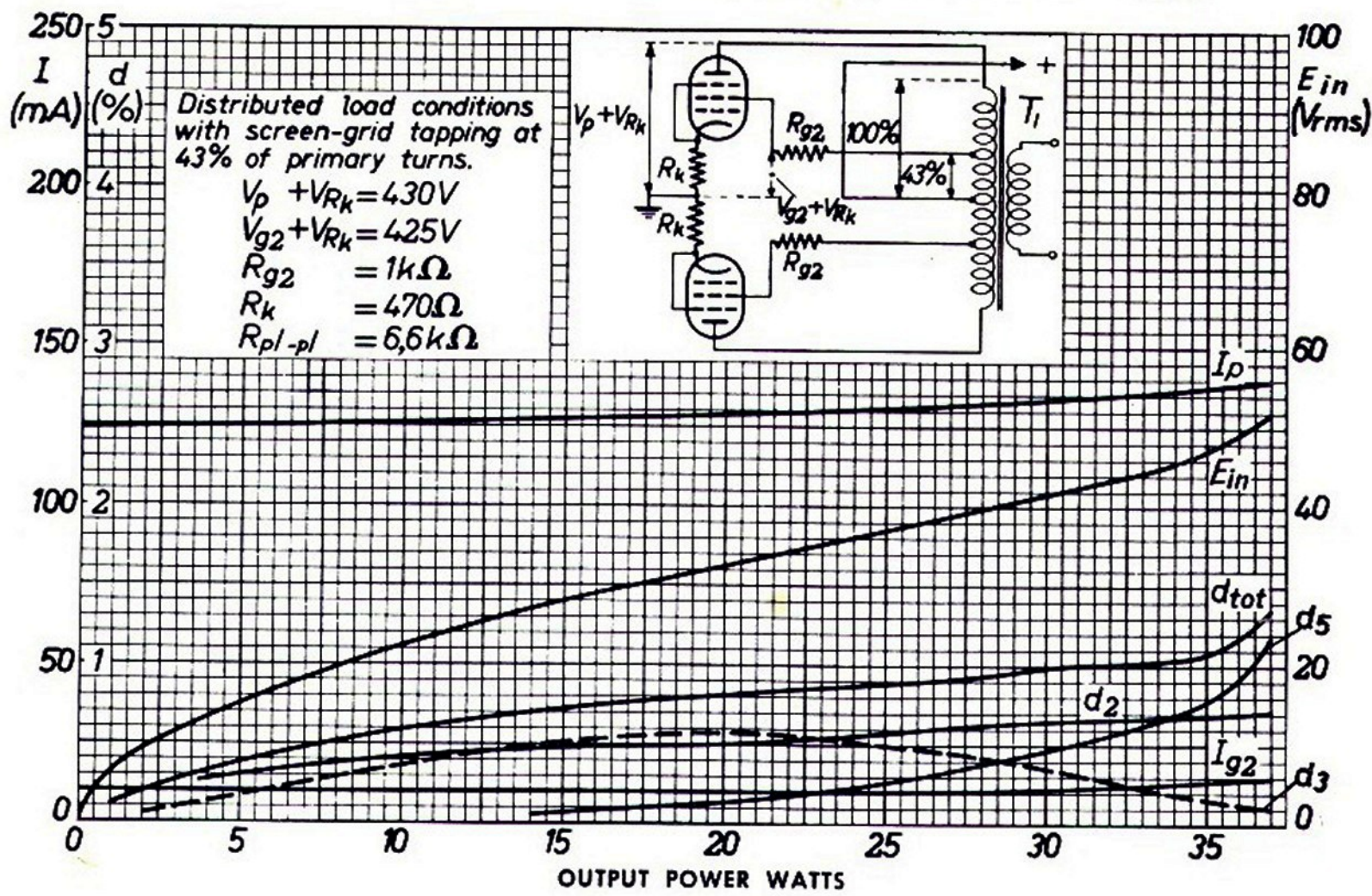

FIG. 1 PERFORMANCE OF TWO 6CA7 IN PUSH-PULL WITH DISTRIBUTED LOAD CONDITIONS. SCREEN-GRID TAPPING AT 43% OF PRIMARY TURNS



*Ti- DYNACO MODEL A-430
ACRO MODEL TO-300

6CA7

PERFORMANCE OF TWO EL 84 IN CLASS "AB" PUSH-PULL

EL84

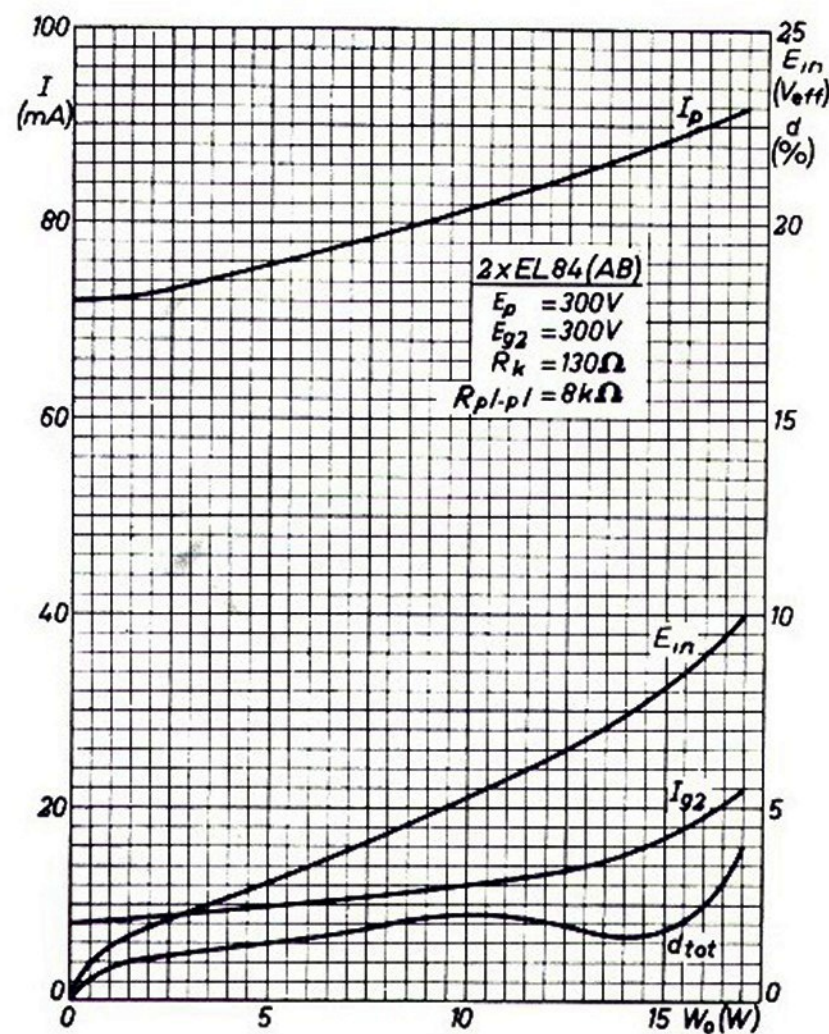
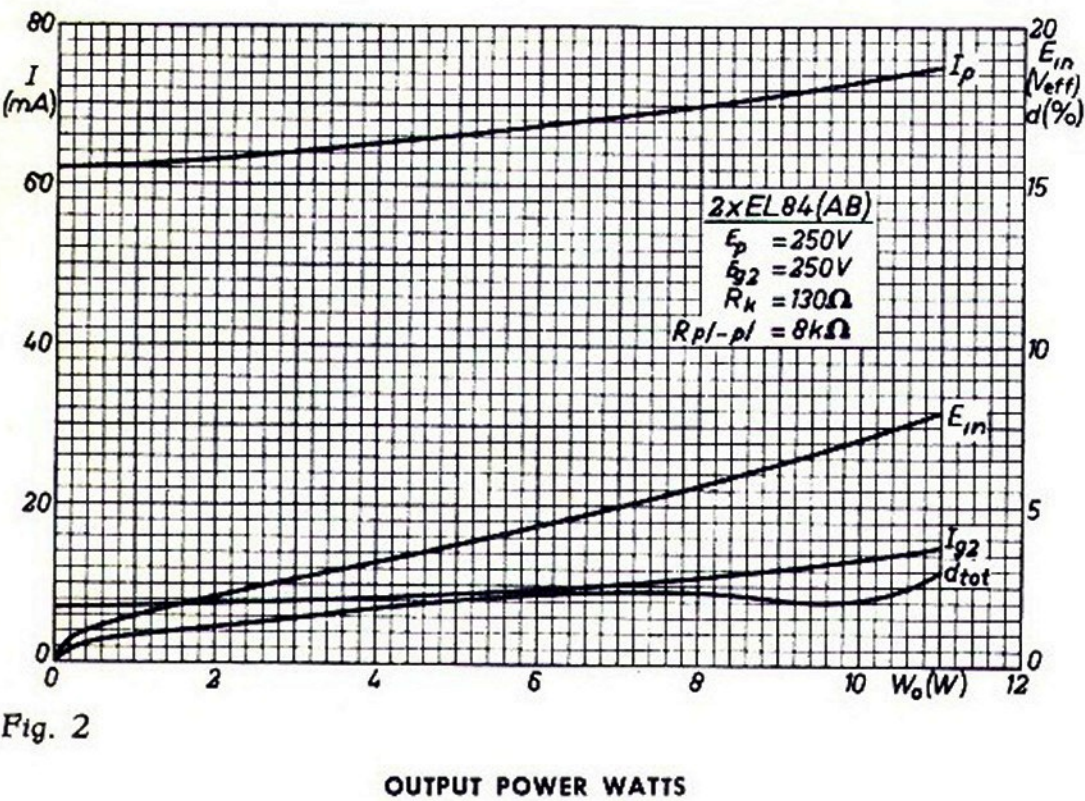

Fig. 2

Fig. 3

OUTPUT POWER WATTS