

# RCA RECEIVING TUBE MANUAL

\$1.00  
Suggested  
List Price

TECHNICAL SERIES RC-21

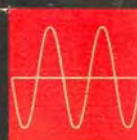

**RADIO CORPORATION OF AMERICA**  
ELECTRON TUBE DIVISION HARRISON, N. J.

# Contents

	PAGE
<b>ELECTRONS, ELECTRODES, AND ELECTRON TUBES</b> . . . . .	3
Electrons, Cathodes, Generic Tube Types, Diodes, Triodes, Pentodes, Beam Power Tubes, Multi-Electrode and Multi-Unit Types, Receiving Tube Structure, Television Picture Tubes	
<b>ELECTRON TUBE CHARACTERISTICS</b> . . . . .	11
<b>ELECTRON TUBE APPLICATIONS</b> . . . . .	13
Amplification, Rectification, Detection, Automatic Volume or Gain Control, Tuning Indication with Electron-Ray Tubes, Oscillation, Deflection Circuits, Frequency Conversion, Automatic Frequency Control	
<b>ELECTRON TUBE INSTALLATION</b> . . . . .	55
Filament and Heater Power Supply, Heater-to-Cathode Connection, Plate Voltage Supply, Grid Voltage Supply, Screen-Grid Voltage Supply, Shielding, Dress of Circuit Leads, Filters, Output-Coupling Devices, High-Voltage Considerations for Television Picture Tubes, Picture-Tube Safety Considerations	
<b>INTERPRETATION OF TUBE DATA</b> . . . . .	65
<b>RECEIVING TUBE CHART</b> . . . . .	71
<b>TUBE TYPES—TECHNICAL DATA</b> . . . . .	77
<b>PICTURE-TUBE CHARACTERISTICS CHART</b> . . . . .	427
<b>ELECTRON TUBE TESTING</b> . . . . .	431
<b>RESISTANCE-COUPLED AMPLIFIERS</b> . . . . .	434
<b>CIRCUITS</b> . . . . .	444
<b>OUTLINES</b> . . . . .	466
<b>INDEX</b> . . . . .	472
<b>READING LIST</b> . . . . .	480

## KEY: BASING DIAGRAMS (*Bottom Views*)

• Gas-Type Tube	F <sup>-</sup> Filament	LC Limited Connection—Do Not
BC Base Sleeve	(negative only)	Use, Except As
BS Base Shell	F <sub>M</sub> Filament Tap	Specified in
C External Conductive Coating	G Grid	Data
CL Collector	H Heater	NC No Connection—
DJ Deflecting Electrode	H <sub>L</sub> Heater Tap for Panel Lamp	May Be Used
ES External Shield	H <sub>M</sub> Heater Tap	As Tie Point
F Filament	IC Internal Connection	P Plate (Anode)
F <sup>+</sup> Filament (positive only)	—Do Not Use	RC Ray-Control Electrode
	IS Internal Shield	S Shell
	K Cathode	TA Target

*Subscripts for multi-unit types: B, beam unit; D, diode unit; HP, heptode unit; HX, hexode unit; P, pentode unit; T, triode unit; TR, tetrode unit.*

# RCA Receiving Tube Manual

**THIS NEW EDITION**, like previous editions, has been prepared to assist those who work or experiment with electron tubes and circuits. It will prove interesting and valuable to engineers, service technicians, educators, experimenters, radio amateurs, hobbyists, students, and many others technically concerned with electron tubes.

This edition has been augmented and revised to keep pace with our rapidly changing technology. Many tube types widely used in the design of new electronic equipment only a few years ago are now chiefly of interest for renewal purposes; in their place, new advanced types are being used. As a result, you will find that the information in the Tube Types Section for many older types has been limited to basic essential data; the information for the newer and more important types has been given in greater detail.

Many tube types are available in addition to the home-entertainment types described in this manual. For industrial and specialized applications, the Electron Tube Division of Radio Corporation of America offers small receiving-type tubes, such as premium tubes, *Special Red* tubes, computer tubes, and voltage regulator tubes. Other lines of RCA electron devices include:

## **POWER TUBES**

*Transmitting and  
Industrial Types*

## **TELEVISION CAMERA TUBES**

*Image Orthicons,  
Vidicons, and  
Monoscopes*

## **PHOTOTUBES**

*Single-Unit, Twin-Unit,  
and Multiplier Types*

## **PHOTOCELLS**

*Photoconductive and  
Photojunction Types*

## **MICROWAVE TUBES**

*Magnetrons, Traveling-Wave  
Tubes, Pencil Tubes*

## **CATHODE-RAY TUBES**

*Special-Purpose Kinescopes,  
Storage Tubes, and  
Oscillograph Types*

## **SPECIAL TYPES**

*Vacuum Gauge Tubes,  
Image Converters*

## **SEMICONDUCTOR DEVICES**

*Germanium and Silicon  
Transistors, Silicon Rectifiers*

## **THYRATRONS and IGNITRONS**

For sales information,  
write to *Sales*

For technical information, write  
to *Commercial Engineering*

**RADIO CORPORATION OF AMERICA**

ELECTRON TUBE DIVISION

HARRISON, N. J.

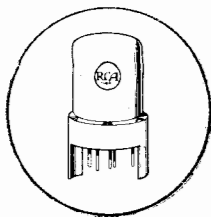

## NUVISTOR TRIODE

CATHODE

HEATER

PLATE

GRID

METAL

SHELL

CERAMIC

BASE WAFER

INDEXING LUGS

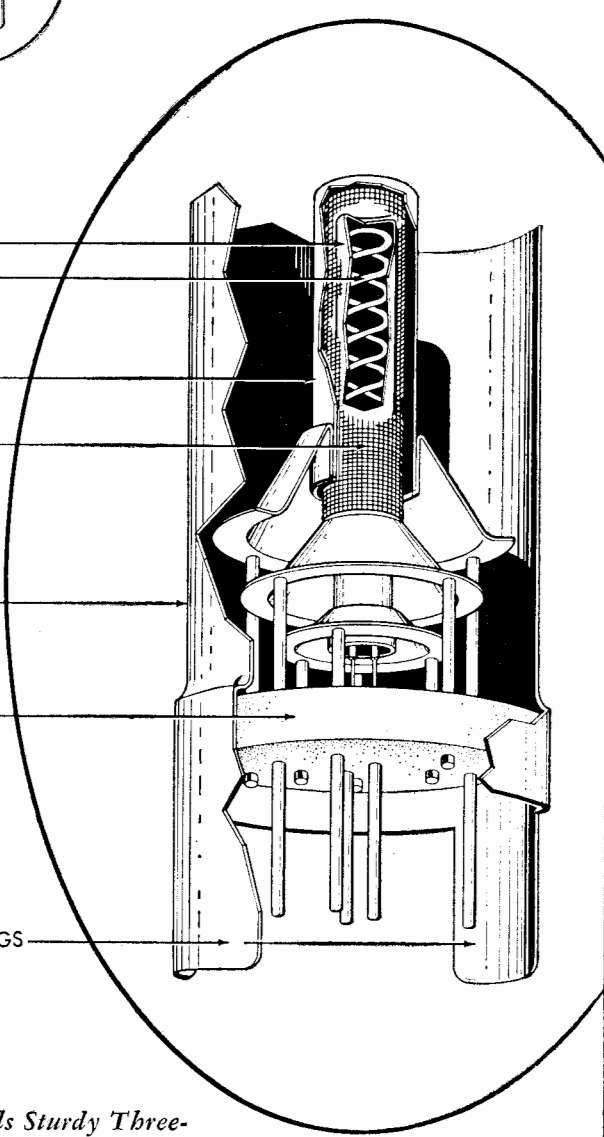

*Cut-Away Reveals Sturdy Three-Point Support Of Cylindrical Electrodes*



# RCA Receiving Tube Manual

## Electrons, Electrodes, and Electron Tubes

The electron tube is a marvelous device. It makes possible the performing of operations, amazing in conception, with a precision and a certainty that are astounding. It is an exceedingly sensitive and accurate instrument—the product of coordinated efforts of engineers and craftsmen. Its construction requires materials from every corner of the earth. Its use is world-wide. Its future possibilities, even in the light of present-day accomplishments, are but dimly foreseen; for each development opens new fields of design and application.

The importance of the electron tube lies in its ability to control almost instantly the flight of the millions of electrons supplied by the cathode. It accomplishes this control with a minimum of energy. Because it is almost instantaneous in its action, the electron tube can operate efficiently and accurately at electrical frequencies much higher than those attainable with rotating machines.

### Electrons

All matter exists in the solid, liquid, or gaseous state. These three forms consist entirely of minute divisions known as molecules, which, in turn, are composed of atoms. Atoms have a nucleus which is a positive charge of electricity, around which revolve tiny charges of negative electricity known as **electrons**. Scientists have estimated that electrons weigh only 1/30-billion, billion, billion, billionths of an ounce, and that they may travel at speeds of thousands of miles per second.

Electron movement may be accelerated by the addition of energy. Heat is one form of energy which can be conveniently used to speed up the electron. For example, if the temperature of a metal is gradually raised, the electrons

in the metal gain velocity. When the metal becomes hot enough, some electrons may acquire sufficient speed to break away from the surface of the metal. This action, which is accelerated when the metal is heated in a vacuum, is utilized in most electron tubes to produce the necessary electron supply.

An electron tube consists of a cathode, which supplies electrons, and one or more additional electrodes, which control and collect these electrons, mounted in an evacuated envelope. The envelope may be made of glass, metal, ceramic, or a combination of these materials.

### Cathodes

A cathode is an essential part of an electron tube because it supplies the electrons necessary for tube operation. When energy in some form is applied to the cathode, electrons are released. Heat is the form of energy generally used. The method of heating the cathode may be used to distinguish between the different forms of cathodes. For example, a directly heated cathode, or filament-cathode, is a wire heated by the passage of an electric current. An indirectly heated cathode, or heater-cathode, consists of a filament, or heater, enclosed in a metal sleeve. The sleeve carries the electron-emitting material on its outside surface and is heated by radiation and conduction from the heater.

A **filament, or directly heated cathode**, such as that shown in Fig. 1 may be further classified by identifying the filament or electron-emitting material. The materials in regular use are tungsten, thoriated tungsten, and metals which have been coated with alkaline-earth oxides. Tungsten filaments are made from the pure metal. Because they must operate at high temperatures (a

dazzling white) to emit sufficient electrons, a relatively large amount of filament power is required.

Thoriated-tungsten filaments are made from tungsten impregnated with thorium oxide. Due to the presence of thorium, these filaments liberate electrons at a more moderate temperature of about 1700°C (a bright yellow) and are, therefore, much more economical of filament power than are pure tungsten filaments.

Alkaline earths are usually applied as a coating on a nickel-alloy wire or ribbon. This coating, which is dried in a relatively thick layer on the filament, requires only a relatively low temperature of about 700-750°C (a dull red) to produce a copious supply of electrons. Coated filaments operate very efficiently and require relatively little filament power. However, each of these cathode materials has special advantages which determine the choice for a particular application.

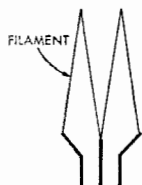

Fig. 1

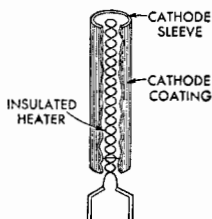

Fig. 2

Directly heated filament-cathodes require comparatively little heating power. They are used in almost all of the tube types designed for battery operation because it is, of course, desirable to impose as small a drain as possible on the batteries. Examples of battery-operated filament types are the 1R5, 1U4, 1U5, and 3V4. AC-operated types having directly heated filament-cathodes include the 2A3 and 5Y3-GT.

An **indirectly heated cathode**, or **heater-cathode**, consists of a thin metal sleeve coated with electron-emitting material such as alkaline-earth oxides. Within the sleeve is a heater which is insulated from the sleeve, as shown in Fig. 2. The heater is made of tungsten or tungsten-alloy wire and is used only for the purpose of heating the cathode sleeve

and sleeve coating to an electron-emitting temperature. Useful emission does not take place from the heater wire.

The heater-cathode construction is well adapted for use in electron tubes intended for operation from ac power lines and from storage batteries. The use of separate parts for emitter and heater functions, the electrical insulation of the heater from the emitter, and the shielding effect of the sleeve may all be utilized in the design of the tube to minimize the introduction of hum from the ac heater supply and to minimize electrical interference which might enter the tube circuit through the heater-supply line. From the viewpoint of circuit design, the heater-cathode construction offers advantages in connection flexibility because of the electrical separation of the heater from the cathode.

Another advantage of the heater-cathode construction is that it makes practical the design of a rectifier tube having close spacing between its cathode and plate, and of an amplifier tube having close spacing between its cathode and grid. In a close-spaced rectifier tube, the voltage drop in the tube is low, and, therefore, the regulation is improved. In an amplifier tube, the close spacing increases the gain obtainable from the tube. Because of the advantages of the heater-cathode construction, almost all present-day receiving tubes designed for ac operation have heater-cathodes.

### Generic Tube Types

Electrons are of no value in an electron tube unless they can be put to work. Therefore, a tube is designed with the parts necessary to utilize electrons as well as those required to produce them. These parts consist of a cathode and one or more supplementary electrodes. The electrodes are enclosed in an evacuated envelope having the necessary connections brought out through air-tight seals. The air is removed from the envelope to allow free movement of the electrons and to prevent injury to the emitting surface of the cathode.

When the cathode is heated, electrons leave the cathode surface and form an invisible cloud in the space around it. Any positive electric potential within the evacuated envelope offers a strong

attraction to the electrons (unlike electric charges attract; like charges repel). Such a positive electric potential can be supplied by an **anode** (positive electrode) located within the tube in proximity to the cathode.

### Diodes

The simplest form of electron tube contains two electrodes, a cathode and an anode (plate), and is often called a diode, the family name for a two-electrode tube. In a diode, the positive potential is supplied by a suitable electrical source connected between the plate terminal and a cathode terminal, as shown in Fig. 3. Under the influence of the positive plate potential, electrons flow from the cathode to the plate and return through the external plate-battery circuit to the cathode, thus completing the circuit. This flow of electrons is known as the **plate current**.

If a negative potential is applied to the plate, the free electrons in the space surrounding the cathode will be forced back to the cathode and no plate current will flow. If an alternating voltage is applied to the plate, the plate is alternately made positive and negative. Because plate current flows only during the time when the plate is positive, current flows through the tube in only one direction and is said to be **rectified**. Fig. 4 shows the rectified output current produced by an alternating input voltage.

Diode rectifiers are used in ac receivers to convert the ac supply voltage to dc voltage for the electrodes of the other tubes in the receiver. Rectifier tubes having only one plate and one

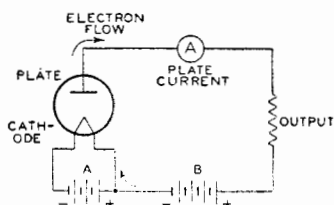

Fig. 3

cathode, such as the 35W4, are called **half-wave rectifiers**, because current can flow only during one-half of the alternating-current cycle. When two plates and one or more cathodes are

used in the same tube, current may be obtained on both halves of the ac cycle. The 6X4, 5Y3-GT, and 5U4-GB are examples of this type and are called **full-wave rectifiers**.

Not all of the electrons emitted by the cathode reach the plate. Some return

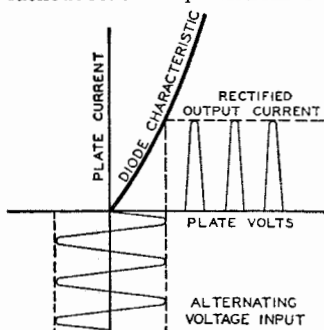

Fig. 4

to the cathode while others remain in the space between the cathode and plate for a brief period to produce an effect known as **space-charge**. This charge has a repelling action on other electrons which leave the cathode surface and impedes their passage to the plate. The extent of this action and the amount of space-charge depend on the cathode temperature, the distance between the cathode and the plate, and the plate potential. The higher the plate potential, the less is the tendency for electrons to remain in the space-charge region and repel other electrons. This effect may be noted by applying increasingly higher plate voltages to a tube operating at a fixed heater or filament voltage. Under these conditions, the maximum number of available electrons is fixed, but increasingly higher plate voltages will succeed in attracting a greater proportion of the free electrons.

Beyond a certain plate voltage, however, additional plate voltage has little effect in increasing the plate current because all of the electrons emitted by the cathode are already being drawn to the plate. This maximum current, illustrated in Fig. 5, is called **saturation current**. Because it is an indication of the total number of electrons emitted, it is also known as **emission current** or simply **emission**.

Although tubes are sometimes tested

by measurement of their emission current, it is generally not advisable to measure the full value of emission because this value would be sufficiently large to cause change in the tube's characteristics or even to damage the tube. Consequently, while the test value of emission current is somewhat larger than

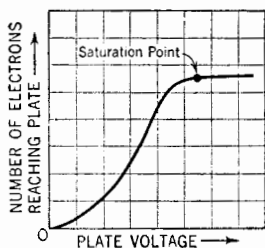

Fig. 5

the maximum current which will be required from the cathode in the use of the tube, it is ordinarily less than the full emission current. The emission test, therefore, is used to indicate whether the cathode can supply a sufficient number of electrons for satisfactory operation of the tube.

If space charge were not present to repel electrons coming from the cathode, the same plate current could be produced at a lower plate voltage. One way to make the effect of space charge small is to make the distance between plate and cathode small. This method is used in rectifier types having heater-cathodes, such as the 5V4-GA and the 6AX5-GT. In these types the radial distance between cathode and plate is only about two hundredths of an inch.

Another method of reducing space-charge effect is utilized in **mercury-vapor rectifier tubes**. When such tubes are operated, a small amount of mercury contained in the tube is partially vaporized, filling the space inside the bulb with mercury atoms. These atoms are bombarded by electrons on their way to the plate. If the electrons are moving at a sufficiently high speed, the collisions tear off electrons from the mercury atoms. The mercury atom is then said to be "ionized," *i.e.*, it has lost one or more electrons and, therefore, has a positive charge. Ionization is evidenced

by a bluish-green glow between the cathode and plate. When ionization occurs, the space charge is neutralized by the positive mercury atoms so that increased numbers of electrons are made available. Mercury-vapor tubes are used primarily for power rectifiers.

**Ionic-heated-cathode rectifier tubes**, such as the 0Z4 and 0Z4-G, also depend on gas ionization for their operation. These tubes are of the full-wave design and contain two anodes and a coated cathode sealed in a bulb containing a reduced pressure of inert gas. The cathode in each of these types becomes hot during tube operation, but the heating effect is caused by bombardment of the cathode by ions within the tube rather than by heater or filament current from an external source.

The internal structure of an ionic-heated-cathode tube is designed so that when sufficient voltage is applied to the tube, ionization of the gas occurs between the anode which is instantaneously positive and the cathode. Under normal operating voltages, ionization does not take place between the anode that is negative and the cathode so that the requirements for rectification are satisfied. The initial small flow of current through the tube is sufficient to raise the cathode temperature quickly to incandescence whereupon the cathode emits electrons. The voltage drop in such tubes is slightly higher than that of the usual hot-cathode gas rectifiers because energy is taken from the ionization discharge to keep the cathode at operating temperature. Proper operation of these rectifiers requires a minimum flow of load current at all times in order to maintain the cathode at the temperature required to supply sufficient emission.

### Triodes

When a third electrode, called the **grid**, is placed between the cathode and plate, the tube is known as a triode, the family name for a three-electrode tube. The grid usually consists of relatively fine wire wound on two support rods and extending the length of the cathode. The spaces between turns are comparatively large so that the passage of electrons from cathode to plate is practically unobstructed by the grid wires. The pur-

pose of the grid is to control the flow of plate current. When a tube is used as an amplifier, a negative dc voltage is usually applied to the grid. Under this condition the grid does not draw appreciable current.

The number of electrons attracted to the plate depends on the combined effect of the grid and plate polarities, as shown in Fig. 6. When the plate is positive, as is normal, and the dc grid voltage is made more and more negative, the plate is less able to attract electrons to it and plate current decreases. When the grid is made less and less negative (more and more positive), the plate more readily attracts electrons to it and plate current increases. Hence, when the voltage on the grid is varied in accordance with a signal, the plate current varies with the signal. Because a small voltage applied to the grid can control a comparatively large amount of plate current, the signal is amplified by the tube. Typical three-electrode tube types are the 6C4 and 6AF4-A.

The grid, plate, and cathode of a triode form an electrostatic system, each electrode acting as one plate of a small capacitor. The capacitances are those existing between grid and plate, plate and cathode, and grid and cathode.

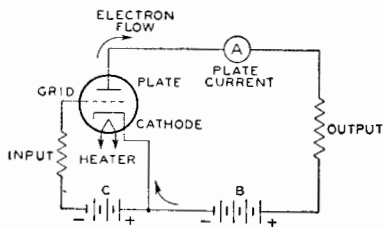

Fig. 6

These capacitances are known as **inter-electrode capacitances**. Generally, the capacitance between grid and plate is of the most importance. In high-gain radio-frequency amplifier circuits, this capacitance may act to produce undesired coupling between the **input circuit**, the circuit between grid and cathode, and the **output circuit**, the circuit between plate and cathode. This coupling is undesirable in an amplifier because it may cause instability and unsatisfactory performance.

### Tetrodes

The capacitance between grid and plate can be made small by mounting an additional electrode, called the **screen grid** (grid No. 2), in the tube. With the addition of the grid No. 2, the tube has four electrodes and is, accordingly, called a tetrode. The screen grid or grid No. 2 is mounted between the grid No. 1 (**control grid**) and the plate, as shown in Fig. 7, and acts as an electrostatic shield between them, thus reducing the grid-to-plate capacitance. The effectiveness of

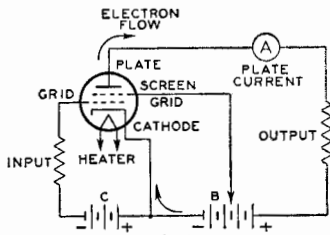

Fig. 7

this shielding action is increased by a bypass capacitor connected between screen grid and cathode. By means of the screen grid and this bypass capacitor, the grid-plate capacitance of a tetrode is made very small. In practice, the grid-plate capacitance is reduced from several micromicrofarads ( $\mu\mu f$ ) for a triode to 0.01  $\mu\mu f$  or less for a screen-grid tube.

The screen grid has another desirable effect in that it makes plate current practically independent of plate voltage over a certain range. The screen grid is operated at a positive voltage and, therefore, attracts electrons from the cathode. However, because of the comparatively large space between wires of the screen grid, most of the electrons drawn to the screen grid pass through it to the plate. Hence the screen grid supplies an electrostatic force pulling electrons from the cathode to the plate. At the same time the screen grid shields the electrons between cathode and screen grid from the plate so that the plate exerts very little electrostatic force on electrons near the cathode.

So long as the plate voltage is higher than the screen-grid voltage, plate current in a screen-grid tube depends to a great degree on the screen-grid voltage and very little on the plate voltage. The fact that plate current in a screen-grid

tube is largely independent of plate voltage makes it possible to obtain much higher amplification with a tetrode than with a triode. The low grid-plate capacitance makes it possible to obtain this high amplification without plate-to-grid feedback and resultant instability. In receiving-tube applications, the tetrode has been replaced to a considerable degree by the pentode.

### Pentodes

In all electron tubes, electrons striking the plate may, if moving at sufficient speed, dislodge other electrons. In two- and three-electrode types, these dislodged electrons usually do not cause trouble because no positive electrode other than the plate itself is present to attract them. These electrons, therefore, are drawn back to the plate. Emission caused by bombardment of an electrode by electrons from the cathode is called **secondary emission** because the effect is secondary to the original cathode emission.

In the case of screen-grid tubes, the proximity of the positive screen grid to the plate offers a strong attraction to these secondary electrons and particularly so if the plate voltage swings lower than the screen-grid voltage. This effect lowers the plate current and limits the useful plate-voltage swing for tetrodes.

The effects of secondary emission are minimized when a fifth electrode is placed within the tube between the screen grid and plate. This fifth electrode is known as the **suppressor grid** (grid No.3) and is usually connected to the cathode, as shown in Fig. 8. Because of

The family name for a five-electrode tube is "pentode". In power-output pentodes, the suppressor grid makes possible higher power output with lower grid-driving voltage; in radio-frequency amplifier pentodes the suppressor grid makes possible high voltage amplification at moderate values of plate voltage. These desirable features result from the fact that the plate-voltage swing can be made very large. In fact, the plate voltage may be as low as, or lower than, the screen-grid voltage without serious loss in signal-gain capability. Representative pentodes used for power amplification are the 3V4 and 6K6-GT; representative pentodes used for voltage amplification are the 1U4, 6AU6, 12SK7, and 6BA6.

### Beam Power Tubes

A beam power tube is a tetrode or pentode in which directed electron beams are used to increase substantially the power-handling capability of the tube. Such a tube contains a cathode, a control grid (grid No.1), a screen grid (grid No.2), a plate, and, optionally, a suppressor grid (grid No.3). When a beam power tube is designed without an actual suppressor grid, the electrodes are so spaced that secondary emission from the plate is suppressed by space-charge effects between screen grid and plate. The space charge is produced by the slowing up of electrons traveling from a high-potential screen grid to a lower-potential plate. In this low-velocity region, the space charge produced is sufficient to repel secondary electrons emitted from the plate and to cause them to return to the plate.

Beam power tubes of this design employ beam-confining electrodes at cathode potential to assist in producing the desired beam effects and to prevent stray electrons from the plate from returning to the screen grid outside of the beam. A feature of a beam power tube is its low screen-grid current. The screen grid and the control grid are spiral wires wound so that each turn of the screen grid is shaded from the cathode by a grid turn. This alignment of the screen grid and control grid causes the electrons to travel in sheets between the turns of the screen grid so that very few of them strike the screen grid. Because of the

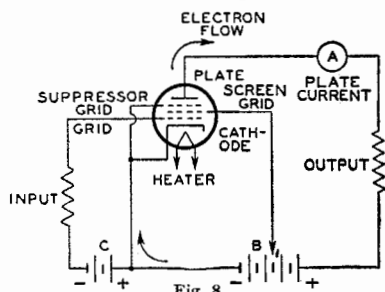

its negative potential with respect to the plate, the suppressor grid retards the flight of secondary electrons and diverts them back to the plate.

effective suppressor action provided by space charge and because of the low current drawn by the screen grid, the beam power tube has the advantages of high power output, high power sensitivity, and high efficiency.

Fig. 9 shows the structure of a beam power tube employing space-charge suppression and illustrates how the electrons

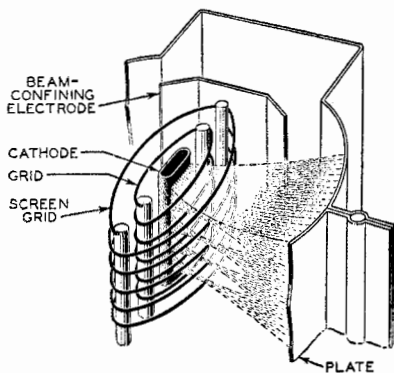

Fig. 9

are confined to beams. The beam condition illustrated is that for a plate potential less than the screen-grid potential. The high-density space-charge region is indicated by the heavily dashed lines in the beam. Note that the edges of the beam-confining electrodes coincide with the dashed portion of the beam. In this way the space-charge potential region is extended beyond the beam boundaries and stray secondary electrons are prevented from returning to the screen grid outside of the beam. The space-charge effect may also be obtained by use of an actual suppressor grid. Examples of beam power tubes are 6AQ5-A, 6L6-GB, 6V6-GT, and 50C5.

### Multi-Electrode and Multi-Unit Tubes

Early in the history of tube development and application, tubes were designed for general service; that is, a single tube type—a triode—was used as a radio-frequency amplifier, an intermediate-frequency amplifier, an audio-frequency amplifier, an oscillator, or a detector. Obviously, with this diversity of application, one tube did not meet all requirements to the best advantage.

Later and present trends of tube design are the development of "specialty" types. These types are intended either to give optimum performance in a particular application or to combine in one bulb functions which formerly required two or more tubes. The first class of tubes includes such examples of specialty types as the 6CB6 and 6BY6. Types of this class generally require more than three electrodes to obtain the desired special characteristics and may be broadly classed as multi-electrode types. The 6BY6 is an especially interesting type in this class. This tube has an unusually large number of electrodes, namely seven, exclusive of the heater. Plate current in the tube is varied at two different frequencies at the same time. The tube is designed primarily for use as a combined sync separator and sync clipper in television receivers.

The second class includes multi-unit tubes such as the twin-diode triodes 6BF6 and 6AV6, as well as triode-pentodes such as the 6U8-A and 6X8. This class also includes class A twin triodes such as the 6CG7 and 12AX7, and types such as the 6CM7 containing dissimilar triode units used primarily as combined vertical oscillators and vertical deflection amplifiers in television receivers. Full-wave rectifiers are also multi-unit types.

A third class of tubes combines features of each of the other two classes. Typical of this third class are the pentagrid-converter types 1R5, 6BE6, and 6SA7. These tubes are similar to the multi-electrode types in that they have seven electrodes, all of which affect the electron stream; and they are similar to the multi-unit tubes in that they perform simultaneously the double function of oscillator and mixer in superheterodyne receivers.

### Receiving Tube Structure

Receiving tubes generally utilize a glass or metal envelope and a base. Originally, the base was made of metal or molded phenolic material. Types having a glass envelope and a molded phenolic base include the "octal" types such as the 5U4-GB and the 6SN7-GTB. Types having a metal envelope and molded phenolic octal base include the



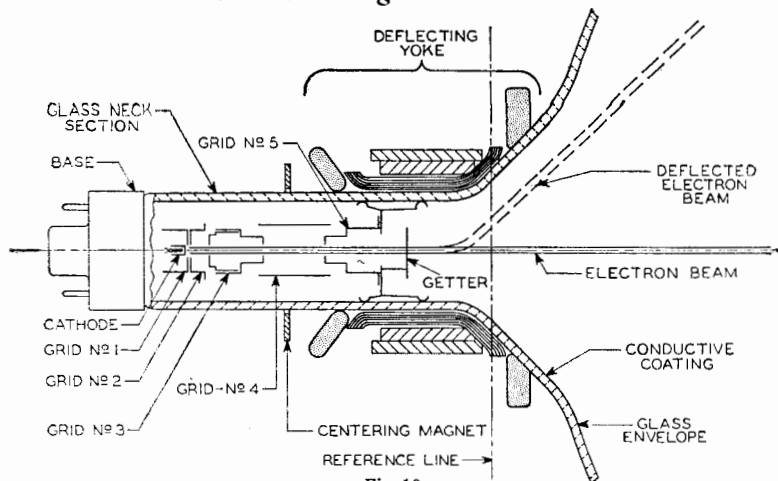

Fig. 10

6AC7 and the 6AG7. Many modern types utilize integral glass bases. Present-day conventional tube designs utilizing glass envelopes and integral glass bases include the seven-pin **miniature** types, the nine-pin miniature types, and the **novar** types. Examples of the seven-pin miniature types are the 6AU6-A and 6BN6. Examples of the nine-pin miniature types are the 12AU7-A and 6EA8. Examples of the novar types are the 6BH3 and 7868. The nine-pin base for the novar types has a relatively large pin-circle diameter and long pins to insure firm retention of the tube in its socket.

The **nuvistor** concept provided a new approach to electron tube design. Nuvistor tubes utilize a light-weight cantilever-supported cylindrical electrode structure housed in a ceramic-metal envelope (see page 2 for cutaway view.) These tubes combine new materials, processes, and fabrication techniques. Examples of the nuvistor are the 2CW4 and the 6CW4.

### Television Picture Tubes

The picture tube, or kinescope, is a multi-electrode tube used principally in television receivers for picture display. It consists essentially of an electron gun, a glass or metal-and-glass envelope and face-plate combination, and a fluorescent screen.

The electron gun includes a cathode for the production of free electrons, one or more control electrodes for accelerating the electrons in the beam, and,

optionally, a device for "trapping" unwanted ions out of the electron beam.

Focusing of the beam is accomplished either electromagnetically by means of a focusing coil placed on the neck of the tube, or electrostatically, as shown in Fig. 10, by means of a focusing electrode (grid No. 4) within the envelope of the tube. The screen is a white-fluorescing phosphor P4 of either the silicate or the sulfide type.

Deflection of the beam is accomplished either electrostatically by means of deflecting electrodes within the envelope of the tube, or electromagnetically by means of a deflecting yoke placed on the neck of the tube. Fig. 10 shows the structure of the gun section of a picture tube and illustrates how the electron beam is formed and how the beam is deflected by means of an electromagnetic deflecting yoke. In this type of tube, ions in the beam are prevented from damaging the fluorescent screen by an aluminum film on the gun side of the screen. This film not only "traps" unwanted ions, but also improves picture contrast. In many types of non-aluminized tubes, ions are separated from the electron beam by means of a tilted-gun and ion-trap-magnet arrangement.

The color kinescope 21FBP22 consists of three electron guns and an aluminized, tricolor, phosphor-dot screen on the inner surface of the spherical filter-glass faceplate. It utilizes magnetic convergence, electrostatic focus, and magnetic deflection.

# Electron Tube Characteristics

The term "characteristics" is used to identify the distinguishing electrical features and values of an electron tube. These values may be shown in curve form or they may be tabulated. When the characteristics values are given in curve form, the curves may be used for the determination of tube performance and the calculation of additional tube factors.

Tube characteristics are obtained from electrical measurements of a tube in various circuits under certain definite conditions of voltages. Characteristics may be further described by denoting the conditions of measurements. For example Static Characteristics are the values obtained with different dc potentials applied to the tube electrodes, while Dynamic Characteristics are the values obtained with an ac voltage on a control grid under various conditions of dc potentials on the electrodes. The dynamic characteristics, therefore, are indicative of the performance capabilities of a tube under actual working conditions.

**Static characteristics** may be shown by plate characteristics curves and transfer (mutual) characteristics curves. These curves present the same information, but in two different forms to increase its usefulness. The plate characteristic curve is obtained by varying plate voltage and measuring plate current for different grid bias voltages, while the transfer-characteristic curve is obtained by varying grid bias voltage and measuring plate current for different plate voltages. A plate-characteristic family of curves is illustrated by Fig. 11. Fig. 12 gives the transfer-characteristic family of curves for the same tube.

**Dynamic characteristics** include amplification factor, plate resistance, control-grid--plate transconductance, and certain detector characteristics, and may be shown in curve form for variations in tube operating conditions.

The **amplification factor**, or  $\mu$ , is the ratio of the change in plate voltage to a change in control-electrode voltage in the opposite direction, under the condition that the plate current remains unchanged and that all other electrode

voltages are maintained constant. For example, if, when the plate voltage is made 1 volt more positive, the control-electrode (grid-No.1) voltage must be made 0.1 volt more negative to hold plate current unchanged, the amplification factor is 1 divided by 0.1, or 10. In other words, a small voltage variation in the grid circuit of a tube has the same effect on the plate current as a large

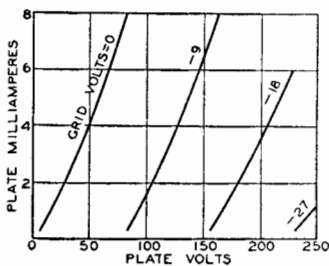

Fig. 11

plate-voltage change—the latter equal to the product of the grid-voltage change and amplification factor. The  $\mu$  of a tube is often useful for calculating stage gain. This use is discussed in the ELECTRON TUBE APPLICATIONS SECTION.

**Plate resistance** ( $r_p$ ) of an electron tube is the resistance of the path between

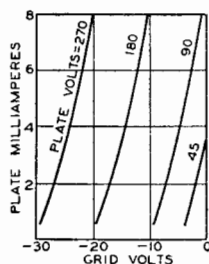

Fig. 12

cathode and plate to the flow of alternating current. It is the quotient of a small change in plate voltage divided by the corresponding change in plate current and is expressed in ohms, the unit of resistance. Thus, if a change of 0.1 milliampere (0.0001 ampere) is produced by a plate voltage variation of 1 volt, the plate resistance is 1 divided by 0.0001, or 10000 ohms.

**Control-grid—plate transconductance**, or simply **transconductance** ( $g_m$ ), is a factor which combines in one term the amplification factor and the plate resistance, and is the quotient of the first divided by the second. This term has also been known as **mutual conductance**. Transconductance may be more strictly defined as the quotient of a small change in plate current (amperes) divided by the small change in the control-grid voltage producing it, under the condition that all other voltages remain unchanged. Thus, if a grid-voltage change of 0.5 volt causes a plate-current change of 1 milliampere (0.001 ampere), with all other voltages constant, the transconductance is 0.001 divided by 0.5, or 0.002 mho. A "mho" is the unit of conductance and was named by spelling ohm backwards. For convenience, a millionth of a mho, or a micromho ( $\mu\text{mho}$ ), is used to express transconductance. Thus, in the example, 0.002 mho is 2000 micromhos.

**Conversion transconductance** ( $g_c$ ) is a characteristic associated with the mixer (first detector) function of tubes

and may be defined as the quotient of the intermediate-frequency (if) current in the primary of the if transformer divided by the applied radio-frequency (rf) voltage producing it; or more precisely, it is the limiting value of this quotient as the rf voltage and if current approach zero. When the performance of a frequency converter is determined, conversion transconductance is used in the same way as control-grid—plate transconductance is used in single-frequency amplifier computations.

The **plate efficiency** of a power amplifier tube is the ratio of the ac power output ( $P_o$ ) to the product of the average dc plate voltage ( $E_b$ ) and dc plate current ( $I_b$ ) at full signal, or

$$\text{Plate efficiency (\%)} = \frac{P_o \text{ watts}}{E_b \text{ volts} \times I_b \text{ amperes}} \times 100$$

The **power sensitivity** of a tube is the ratio of the power output to the square of the input signal voltage ( $E_{in}$ ) and is expressed in mhos as follows:

$$\text{Power sensitivity (mhos)} = \frac{P_o \text{ watts}}{(E_{in, \text{ rms}})^2}$$

# Electron Tube Applications

The diversified applications of an electron receiving tube have, within the scope of this section, been treated under seven headings. These are: Amplification, Rectification, Detection, Automatic Volume or Gain Control, Oscillation, Frequency Conversion, and Automatic Frequency Control. Although these operations may take place at either radio or audio frequencies and may involve the use of different circuits and different supplemental parts, the general considerations of each kind of operation are basic.

## Amplification

The amplifying action of an electron tube was mentioned under **Triodes** in the section on **ELECTRONS, ELECTRODES, and ELECTRON TUBES**. This action can be utilized in electronic circuits in a number of ways, depending upon the results desired. Four classes of amplifier service recognized by engineers are covered by definitions standardized by the Institute of Radio Engineers. This classification depends primarily on the fraction of input cycle during which plate current is expected to flow under rated full-load conditions. The classes are class A, class AB, class B, and class C. The term "cutoff bias" used in these definitions is the value of grid bias at which plate current is some very small value.

### Classes of Service

A **class A amplifier** is an amplifier in which the grid bias and alternating grid voltages are such that plate current in a specific tube flows at all times.

A **class AB amplifier** is an amplifier in which the grid bias and alternating grid voltages are such that plate current in a specific tube flows for appreciably more than half but less than the entire electrical cycle.

A **class B amplifier** is an amplifier in which the grid bias is approximately equal to the cutoff value, so that the plate current is approximately zero when no exciting grid voltage is applied, and so that plate current in a specific

tube flows for approximately one-half of each cycle when an alternating grid voltage is applied.

A **class C amplifier** is an amplifier in which the grid bias is appreciably greater than the cutoff value, so that the plate current in each tube is zero when no alternating grid voltage is applied, and so that plate current flows in a specific tube for appreciably less than one-half of each cycle when an alternating grid voltage is applied.

The suffix 1 may be added to the letter or letters of the class identification to denote that grid current does not flow during any part of the input cycle. The suffix 2 may be used to denote that grid current flows during some part of the cycle.

For radio-frequency (rf) amplifiers which operate into a selective tuned circuit, as in radio transmitter applications, or under requirements where distortion is not an important factor, any of the above classes of amplifiers may be used, either with a single tube or a push-pull stage. For audio-frequency (af) amplifiers in which distortion is an important factor, only class A amplifiers permit single-tube operation. In this case, operating conditions are usually chosen so that distortion is kept below the conventional 5 per cent for triodes and the conventional 7 to 10 per cent for tetrodes or pentodes. Distortion can be reduced below these figures by means of special circuit arrangements such as that discussed under **inverse feedback**. With class A amplifiers, reduced distortion with improved power performance can be obtained by using a push-pull stage for audio service. With class AB and class B amplifiers, a balanced amplifier stage using two tubes is required for audio service.

### Class A Voltage Amplifiers

As a class A voltage amplifier, an electron tube is used to reproduce grid-voltage variations across an impedance or a resistance in the plate circuit. These variations are essentially of the same form as the input signal voltage impressed on the grid, but their amplitude

is increased. This increase is accomplished by operation of the tube at a suitable grid bias so that the applied grid input voltage produces plate-current variations proportional to the signal swings. Because the voltage variation obtained in the plate circuit is much larger than that required to swing the grid, amplification of the signal is obtained.

Fig. 13 gives a graphical illustration of this method of amplification and

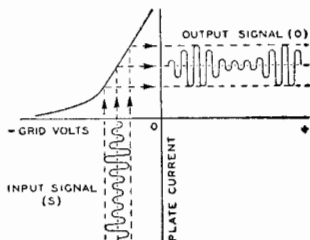

Fig. 13

shows, by means of the grid-voltage vs. plate-current characteristics curve, the effect of an input signal (S) applied to the grid of a tube. The output signal (O) is the resulting amplified plate-current variation.

The plate current flowing through the load resistance (R) of Fig. 14 causes a voltage drop which varies directly with the plate current. The ratio of this voltage variation produced in the load

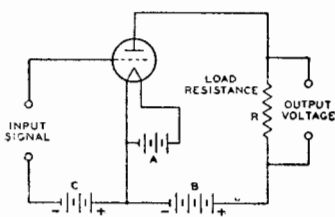

Fig. 14

resistance to the input signal voltage is the voltage amplification, or **gain**, provided by the tube. The voltage amplification due to the tube is expressed by the following convenient formulas:

$$\text{Voltage amplification} = \frac{\mu \times R_L}{R_L + r_p}$$

$$\text{or } \frac{g_m \times r_p \times R_L}{1000000 \times (r_p + R_L)}$$

where  $\mu$  is the amplification factor of the tube,  $R_L$  is the load resistance in

ohms,  $r_p$  is the plate resistance in ohms, and  $g_m$  is the transconductance in micromhos.

From the first formula, it can be seen that the gain actually obtainable from the tube is less than the tube's amplification factor but that the gain approaches the amplification factor when the load resistance is large compared to the tube's plate resistance. Fig. 15 shows graphically how the gain approaches the amplification factor of the tube as the load resistance is increased. From the curve it can be seen that a high value of load resistance should be used to obtain high gain in a voltage amplifier.

In a resistance-coupled amplifier, the load resistance of the tube is approximately equal to the resistance of the plate resistor in parallel with the grid resistor of the following stage. Hence, to obtain a large value of load resistance, it is necessary to use a plate resistor and a grid resistor of large resistance. However, the plate resistor should not be too large because the flow of plate current through the plate resistor produces a voltage drop which reduces the plate voltage applied to the tube. If the plate resistor is too large, this drop will be too large, the plate voltage on the tube will be too small, and the voltage output of the tube will be too small. Also, the grid resistor of the following stage should not be too large, the actual maximum value being dependent on the particular tube type. This precaution is necessary because all tubes contain minute amounts of residual gas which cause a minute flow of current through the grid resistor. If the grid resistor is too large, the positive bias developed by the flow of this current through the resistor decreases the normal negative bias and produces an increase in the plate current. This increased current may overheat the tube and cause liberation of more gas which, in turn, will cause further decrease in bias. The action is cumulative and results in a runaway condition which can destroy the tube.

A higher value of grid resistance is permissible when cathode-resistor bias is used than when fixed bias is used. When cathode-resistor bias is used, a loss in bias due to gas or grid-emission

effects is almost completely offset by an increase in bias due to the voltage drop across the cathode resistor. Typical values of plate resistor and grid resistor for tube types used in resistance-coupled circuits, and the values of gain obtainable, are shown in the RESISTANCE-COUPLED AMPLIFIER SECTION.

The **input impedance** of an electron tube (that is, the impedance between grid and cathode) consists of (1) a reactive component due to the capacitance

frequencies to affect appreciably the gain and selectivity of a preceding stage. Tubes such as the "acorn" and "pencil" types and the high-frequency miniatures have been developed to have low input capacitances, low electron-transit time, and low lead inductance so that their input impedance is high even at the ultra-high radio frequencies. **Input admittance** is the reciprocal of input impedance.

A **remote-cutoff amplifier tube** is

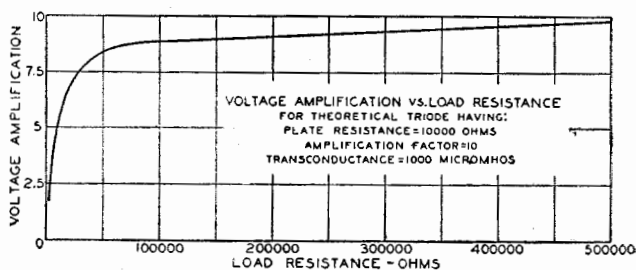

Fig. 15

between grid and cathode, (2) a resistive component resulting from the time of transit of electrons between cathode and grid, and (3) a resistive component developed by the part of the cathode lead inductance which is common to both the input and output circuits. Components (2) and (3) are dependent on the frequency of the incoming signal. The input impedance is very high at audio frequencies when a tube is operated with its grid biased negative. In a class  $A_1$  or  $AB_1$  transformer-coupled audio amplifier, therefore, the loading imposed by the grid on the input transformer is negligible. As a result, the secondary impedance of a class  $A_1$  or class  $AB_1$  input transformer can be made very high because the choice is not limited by the input impedance of the tube; however, transformer design considerations may limit the choice.

At the higher radio frequencies, the input impedance may become very low even when the grid is negative, due to the finite time of passage of electrons between cathode and grid and to the appreciable lead reactance. This impedance drops very rapidly as the frequency is raised, and increases input-circuit loading. In fact, the input impedance may become low enough at very high radio

a modified construction of a pentode or a tetrode type designed to reduce modulation-distortion and cross-modulation in radio-frequency stages. **Cross-modulation** is the effect produced in a radio or television receiver by an interfering station "riding through" on the carrier of the station to which the receiver is tuned. **Modulation-distortion** is a distortion of the modulated carrier and appears as audio-frequency distortion in the output. This effect is produced by a radio-frequency amplifier stage operating on an excessively curved characteristic when the grid bias has been increased to reduce volume. The offending stage for cross-modulation is usually the first radio-frequency amplifier, while for modulation-distortion the cause is usually the last intermediate-frequency stage. The characteristics of remote-cutoff types are such as to enable them to handle both large and small input signals with minimum distortion over a wide range of signal strength.

Fig. 16 illustrates the construction of the grid No.1 (control grid) in a remote-cutoff tube. The remote-cutoff action is due to the structure of the grid which provides a variation in amplification factor with change in grid bias. The grid No.1 is wound with open spacing at

the middle and with close spacing at the ends. When weak signals and low grid bias are applied to the tube, the effect of the non-uniform turn spacing of the grid on cathode emission and tube characteristics is essentially the same as for uniform spacing. As the grid bias is made more negative to handle larger input

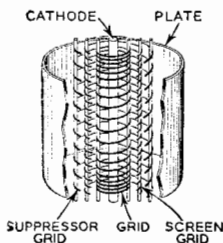

Fig. 16

signals, the electron flow from the sections of the cathode enclosed by the ends of the grid is cut off. The plate current and other tube characteristics are then dependent on the electron flow through the open section of the grid. This action changes the gain of the tube so that large signals may be handled with minimum distortion due to cross-modulation and modulation-distortion.

Fig. 17 shows a typical plate-current vs. grid-voltage curve for a remote-cutoff type compared with the curve for a type having a uniformly spaced grid. It will be noted that while the curves are similar at small grid-bias voltages, the plate current of the remote-cutoff tube drops quite slowly with large values of bias voltage. This slow change makes it

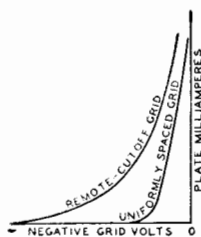

Fig. 17

possible for the tube to handle large signals satisfactorily. Because remote-cutoff types can accommodate large and small signals, they are particularly suitable for use in sets having automatic volume control. Remote-cutoff tubes also are known as variable- $\mu$  types.

### Class A Power Amplifiers

As a class A power amplifier, an electron tube is used in the output stage of a radio or television receiver to supply a relatively large amount of power to the loudspeaker. For this application, large power output is of more importance than high voltage amplification; therefore, gain possibilities are sacrificed in the design of power tubes to obtain power-handling capability.

Triodes, pentodes, and beam power tubes designed for power amplifier service have certain inherent features for each structure. Power tubes of the triode type for class A service are characterized by low power sensitivity, low plate-power efficiency, and low distortion. Power tubes of the pentode type are characterized by high power sensitivity, high plate-power efficiency and, usually, somewhat higher distortion than class A triodes. Beam power tubes have higher

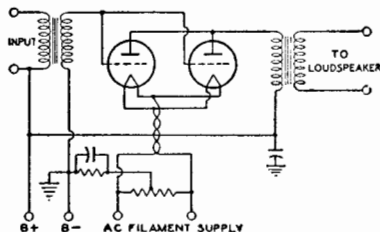

Fig. 18

power sensitivity and efficiency than triode or conventional pentode types.

A class A power amplifier is also used as a driver to supply power to a class  $AB_2$  or a class B stage. It is usually advisable to use a triode, rather than a pentode, in a driver stage because of the lower plate impedance of the triode.

Power tubes connected in either **parallel** or **push-pull** may be employed as class A amplifiers to obtain increased output. The parallel connection (Fig. 18) provides twice the output of a single tube with the same value of grid-signal voltage. With this connection, the effective transconductance of the stage is doubled, and the effective plate resistance and the load resistance required are halved as compared with single-tube values.

The push-pull connection (Fig. 19), although it requires twice the grid-signal



voltage, provides increased power and has other important advantages over single-tube operation. Distortion caused by even-order harmonics and hum caused

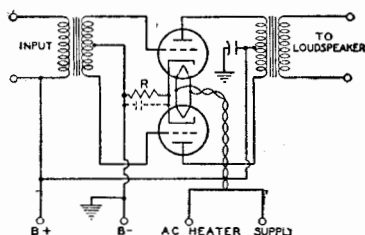

Fig. 19

by plate-voltage-supply fluctuations are either eliminated or decidedly reduced through cancellation. Because distortion for push-pull operation is less than for single-tube operation, appreciably more than twice single-tube output can be obtained with triodes by decreasing the load resistance for the stage to a value approaching the load resistance for a single tube.

For either parallel or push-pull class A operation of two tubes, all electrode currents are doubled while all dc electrode voltages remain the same as for single-tube operation. If a cathode resistor is used, its value should be about one-half that for a single tube. If oscillations occur with either type of connection, they can often be eliminated by the use of a non-inductive resistor of approximately 100 ohms connected in series with each grid at the socket terminal.

Operation of power tubes so that

### Power-Output Calculations

Calculation of the power output of a triode used as a class A amplifier with either an output transformer or a choke having low dc resistance can be made without serious error from the plate family of curves by assuming a resistance load. The proper plate current, grid bias, optimum load resistance, and per-cent second-harmonic distortion can also be determined. The calculations are made graphically and are illustrated in Fig. 20 for given conditions. The procedure is as follows:

(1) Locate the zero-signal bias point P by determining the zero-signal bias  $E_{c0}$  from the formula:

$$\text{Zero-signal bias } (E_{c0}) = -(0.68 \times E_b) / \mu$$

where  $E_b$  is the chosen value in volts of dc plate voltage at which the tube is to be operated, and  $\mu$  is the amplification factor of the tube. This quantity is shown as negative to indicate that a negative bias is used.

(2) Locate the value of zero-signal plate current,  $I_0$ , corresponding to point P.

(3) Locate the point  $2I_0$ , which is twice the value of  $I_0$  and corresponds to the value of the maximum-signal plate current  $I_{max}$ .

(4) Locate the point X on the dc bias curve at zero volts,  $E_c = 0$ , corresponding to the value of  $I_{max}$ .

(5) Draw a straight line XY through X and P.

Line XY is known as the load resistance line. Its slope corresponds to

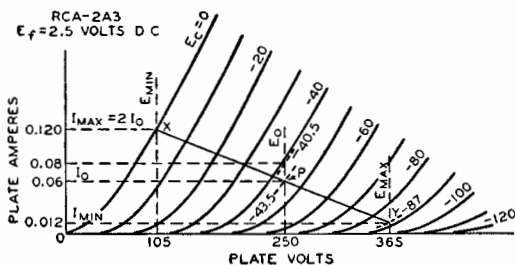

Fig. 20

the grids run positive is inadvisable except under conditions such as those discussed in this section for class AB and class B amplifiers.

the value of the load resistance. The load resistance in ohms is equal to  $(E_{max} - E_{min}) / (I_{max} - I_{min})$ , where  $E$  is in volts and  $I$  is in amperes.

It should be noted that in the case of filament types of tubes, the calculations are given on the basis of a dc-operated filament. When the filament is ac-operated, the calculated value of dc bias should be increased by approximately one-half the filament voltage rating of the tube.

The value of zero-signal plate current  $I_0$  should be used to determine the plate dissipation, an important factor influencing tube life. In a class A amplifier under zero-signal conditions, the plate dissipation is equal to the power input, *i.e.*, the product of the dc plate voltage  $E_0$  and the zero-signal dc plate current  $I_0$ . If it is found that the plate-dissipation rating of the tube is exceeded with the zero-signal bias  $E_{c0}$  calculated above, it will be necessary to increase the bias by a sufficient amount so that the actual plate dissipation does not exceed the rating before proceeding further with the remaining calculations.

For power-output calculations, it is assumed that the peak alternating grid voltage is sufficient (1) to swing the grid from the zero-signal bias value  $E_{c0}$  to zero bias ( $E_c = 0$ ) on the positive swing and (2) to swing the grid to a value twice the zero-signal bias value on the negative swing. During the negative swing, the plate voltage and plate current reach values of  $E_{max}$  and  $I_{min}$ ; during the positive swing, they reach values of  $E_{min}$  and  $I_{max}$ . Because power is the product of voltage and current, the power output  $P_0$  as shown by a wattmeter is given by

$$P_0 = \frac{(I_{max} - I_{min}) \times (E_{max} - E_{min})}{8}$$

where  $E$  is in volts,  $I$  is in amperes, and  $P_0$  is in watts.

In the output of power amplifier triodes, some distortion is present. This distortion is due predominantly to second harmonics in single-tube amplifiers. The percentage of second-harmonic distortion may be calculated by the following formula:

$$\% \text{ distortion} = \frac{I_{max} + I_{min} - I_0}{I_{max} - I_{min}} \times 100$$

where  $I_0$  is the zero-signal plate current in amperes. If the distortion is excessive, the load resistance should be increased or, occasionally, decreased slightly and

the calculations repeated.

**Example:** Determine the load resistance, power output, and distortion of a triode having an amplification factor of 4.2, a plate-dissipation rating of 15 watts, and plate characteristics curves as shown in Fig. 20. The tube is to be operated at 250 volts on the plate.

**Procedure:** For a first approximation, determine the operating point P from the zero-signal bias formula,  $E_{c0} = -(0.68 \times 250) / 4.2 = -40.5$  volts. From the curve for this voltage, it is found that the zero-signal plate current  $I_0$  at a plate voltage of 250 volts is 0.08 ampere and, therefore, the plate-dissipation rating is exceeded ( $0.08 \times 250 = 20$  watts). Consequently, it is necessary to reduce the zero-signal plate current to 0.06 ampere at 250 volts. The grid bias is now seen to be -43.5 volts. Note that the curve was taken with a dc filament supply; if the filament is to be operated on an ac supply, the bias must be increased by about one-half the filament voltage, or to -45 volts, and the circuit returns made to the mid-point of the filament circuit.

Point X can now be determined. Point X is at the intersection of the dc bias curve at zero volts with  $I_{max}$ , where  $I_{max} = 2I_0 = 2 \times 0.06 = 0.12$  ampere. Line XY is drawn through points P and X.  $E_{max}$ ,  $E_{min}$ , and  $I_{min}$  are then found from the curves. Substituting these values in the power-output formula, we obtain

$$P_0 = \frac{(0.12 - 0.012) \times (365 - 105)}{8} = 3.52 \text{ watts}$$

The resistance represented by load line XY is

$$\frac{(365 - 105)}{(0.12 - 0.012)} = 2410 \text{ ohms}$$

When the values from the curves are substituted in the distortion formula, we obtain

$$\% \text{ distortion} = \frac{0.12 + 0.012 - 0.06}{0.12 - 0.012} \times 100 = 5.5\%$$

It is customary to select the load resistance so that the distortion does not exceed five per cent. When the method shown is used to determine the slope of the load resistance line, the second-harmonic distortion generally does not exceed five per cent. In the example, however, the distortion is excessive and it is desirable, therefore, to use a slightly

higher load resistance. A load resistance of 2500 ohms will give a distortion of about 4.9 per cent. The power output is reduced only slightly to 3.5 watts.

Operating conditions for **triodes in push-pull** depend on the type of operation desired. Under class A conditions, distortion, power output, and efficiency are all relatively low. The operating bias can be anywhere between that specified for single-tube operation and that equal to one-half the grid-bias voltage required to produce plate-current cutoff at a plate voltage of  $1.4E_0$ , where  $E_0$  is the operating plate voltage. Higher bias than this value requires higher grid-signal voltage and results in class AB<sub>1</sub> operation which is discussed later.

The method for calculating maximum power output for **triodes in push-pull class A operation** is as follows: Erect a vertical line at  $0.6 E_0$  (see Fig. 21), intersecting the  $E_c=0$  curve at the

plate dissipation rating of the tube is 15 watts. Then, for class A operation, the operating bias can be equal to, but not more than, one-half the grid bias for cutoff with a plate voltage of  $1.4 \times 300 = 420$  volts. (Since cutoff bias is approximately -115 volts at a plate voltage of 420 volts, one-half of this value is -57.5 volts bias.) At this bias, the plate current is found from the plate family to be 0.054 ampere and, therefore, the plate dissipation is  $0.054 \times 300$  or 16.2 watts. Since -57.5 volts is the limit of bias for class A operation of these tubes at a plate voltage of 300 volts, the dissipation cannot be reduced by increasing the bias and it, therefore, becomes necessary to reduce the plate voltage.

If the plate voltage is reduced to 250 volts, the bias will be found to be -43.5 volts. For this value, the plate current is 0.06 ampere, and the plate dissipation is 15 watts. Then, following the

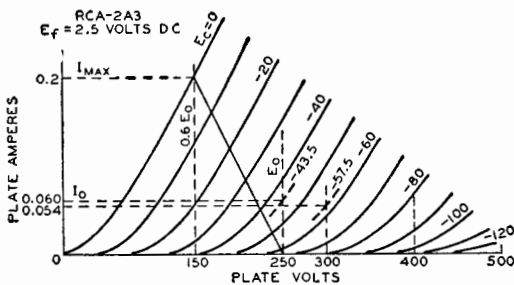

Fig. 21

point  $I_{max}$ . Then,  $I_{max}$  is determined from the curve for use in the formula

$$P_o = (I_{max} \times E_o) / 5$$

If  $I_{max}$  is expressed in amperes and  $E_o$  in volts, power output is in watts.

The method for determining the proper load resistance for triodes in push-pull is as follows: Draw a load line through  $I_{max}$  on the zero-bias curve and through the  $E_0$  point on the zero-current axis. Four times the resistance represented by this load line is the plate-to-plate load ( $R_{pp}$ ) for two triodes in a class A push-pull amplifier. Expressed as a formula,

$$R_{pp} = 4 \times (E_o - 0.6E_o) / I_{max}$$

where  $E_o$  is expressed in volts,  $I_{max}$  in amperes, and  $R_{pp}$  in ohms.

**Example:** Assume that the plate voltage ( $E_o$ ) is to be 300 volts, and the

method for calculating power output, erect a vertical line at  $0.6E_0 = 150$  volts. The intersection of the line with the curve  $E_c = 0$  is  $I_{max}$  or 0.2 ampere. When this value is substituted in the power formula, the power output is  $(0.2 \times 250) / 5 = 10$  watts. The load resistance is determined from the load formula: Plate-to-plate load ( $R_{pp}$ ) =  $4 \times (250 - 150) / 0.2 = 2000$  ohms.

**Power output for a pentode or a beam power tube as a class A amplifier** can be calculated in much the same way as for triodes. The calculations can be made graphically from a special plate family of curves, as illustrated in Fig. 22.

From a point A at or just below the knee of the zero-bias curve, draw arbitrarily selected load lines to intersect the zero-plate-current axis. These lines should be on both sides of the operating

point P whose position is determined by the desired operating plate voltage,  $E_0$ , and one-half the maximum-signal plate current. Along any load line, say  $AA_1$ , measure the distance  $AO_1$ . On the same line, lay off an equal distance,  $O_1A_1$ . For optimum operation, the change in bias from A to  $O_1$  should be nearly equal to the change in bias from  $O_1$  to  $A_1$ . If this condition can not be met with one line,

$$\% \text{ total (2nd and 3rd) harmonic distortion} = \frac{\sqrt{(\%2nd)^2 + (\%3rd)^2}}$$

### Conversion Factors

Operating conditions for voltage values other than those shown in the published data can be obtained by the use of the **nomograph** shown in Fig. 23 when all electrode voltages are changed simultaneously in the same ratio. The

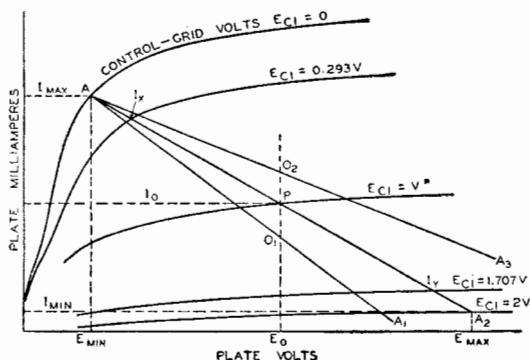

Fig. 22

as is the case for the line first chosen, then another should be chosen. When the most satisfactory line has been selected, its resistance may be determined by the following formula:

$$\text{Load resistance } (R_L) = \frac{E_{max} - E_{min}}{I_{max} - I_{min}}$$

The value of  $R_L$  may then be substituted in the following formula for calculating power output.

$$P_o = \frac{[I_{max} - I_{min} + 1.41 (I_x - I_y)]^2 R_L}{32}$$

In both of these formulas,  $I$  is in amperes,  $E$  is in volts,  $R_L$  is in ohms, and  $P_o$  is in watts.  $I_x$  and  $I_y$  are the current values on the load line at bias voltages of  $E_{c1} = V - 0.707V = 0.293V$  and  $E_{c1} = V + 0.707V = 1.707V$ , respectively.

Calculations for distortion may be made by means of the following formulas. The terms used have already been defined.

$$\% \text{ 2nd-harmonic distortion} = \frac{I_{max} + I_{min} - 2 I_o}{I_{max} - I_{min} + 1.41 (I_x - I_y)} \times 100$$

$$\% \text{ 3rd-harmonic distortion} = \frac{I_{max} - I_{min} - 1.41 (I_x - I_y)}{I_{max} - I_{min} + 1.41 (I_x - I_y)} \times 100$$

nomograph includes conversion factors for current ( $F_i$ ), power output ( $F_p$ ), plate resistance or load resistance ( $F_r$ ), and transconductance ( $F_{gm}$ ) for voltage ratios between 0.5 and 2.0. These factors are expressed as functions of the ratio between the desired or new voltage for any electrode ( $E_{des}$ ) and the published or original value of that voltage ( $E_{pub}$ ). The relations shown are applicable to triodes and multigrid tubes in all classes of service.

To use the nomograph, simply place a straight-edge across the page so that it intersects the scales for  $E_{des}$  and  $E_{pub}$  at the desired values. The desired conversion factor may then be read directly or estimated at the point where the straight-edge intersects the  $F_i$ ,  $F_p$ ,  $F_r$ , or  $F_{gm}$  scale.

For example, suppose it is desired to operate two 6L6-GB's in class A<sub>1</sub> push-pull, fixed bias, with a plate voltage of 200 volts. The nearest published operating conditions for this class of service are for a plate voltage of 250 volts. The operating conditions for the new plate voltage can be determined as follows:

The voltage conversion factor,  $F_v$ ,

is equal to  $200/250$  or  $0.8$ . The dashed lines on the nomograph of Fig. 23 indicate that for this voltage ratio  $F_i$  is approximately  $0.72$ ,  $F_p$  is approximately

Because contact-potential effects become noticeable only at very small dc grid-No.1 (bias) voltages, they are generally negligible in power tubes. Secondary

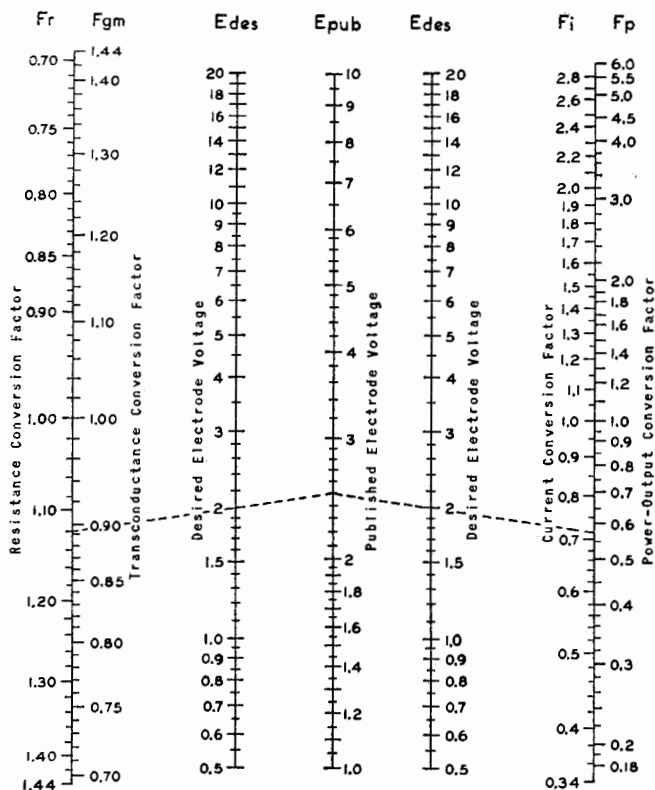

Fig. 23

$0.57$ ,  $F_r$  is  $1.12$ , and  $F_{gm}$  is approximately  $0.892$ . These factors may be applied directly to operating values shown in the tube data, or to values calculated by the methods described previously.

Because this method for conversion of characteristics is necessarily an approximation, the accuracy of the nomograph decreases progressively as the ratio  $E_{des}/E_{pub}$  departs from unity. In general, results are substantially correct when the value of the ratio  $E_{des}/E_{pub}$  is between  $0.7$  and  $1.5$ . Beyond these limits, the accuracy decreases rapidly, and the results obtained must be considered rough approximations.

The nomograph does not take into consideration the effects of contact potential or secondary emission in tubes.

emission may occur in conventional tetrodes, however, if the plate voltage swings below the grid-No.2 voltage. Consequently, the conversion factors shown in the nomograph apply to such tubes only when the plate voltage is greater than the grid-No.2 voltage. Because secondary emission may also occur in certain beam power tubes at very low values of plate current and plate voltage, the conversion factors shown in the nomograph do not apply when these tubes are operated under such conditions.

### Class AB Power Amplifiers

A class AB power amplifier employs two tubes connected in push-pull with a higher negative grid bias than is

used in a class A stage. With this higher negative bias, the plate and screen-grid voltages can usually be made higher than for class A amplifiers because the increased negative bias holds plate current within the limit of the tube's plate-dissipation rating. As a result of these higher voltages, more power output can be obtained from class AB operation.

Class AB amplifiers are subdivided into class AB<sub>1</sub> and class AB<sub>2</sub>. In class AB<sub>1</sub> there is no flow of grid current. That is, the peak signal voltage applied to each grid is not greater than the negative grid-bias voltage. The grids therefore are not driven to a positive potential and do not draw current. In class AB<sub>2</sub>, the peak signal voltage is greater than the bias so that the grids are driven positive and draw current.

Because of the flow of grid current in a class AB<sub>2</sub> stage there is a loss of

fluctuations in the voltage output of the power supply, with the result that power output is decreased and distortion is increased. To obtain satisfactory regulation it is usually advisable to use a low-drop rectifier, such as the 5V4-GA, with a choke-input filter. In all cases, the resistance of the filter choke and power transformers should be as low as possible.

### Class AB<sub>1</sub> Power Amplifiers

In class AB<sub>1</sub> push-pull amplifier service using triodes, the operating conditions may be determined graphically by means of the plate family if E<sub>0</sub>, the desired operating plate voltage, is given. In this service, the dynamic load line does not pass through the operating point P as in the case of the single-tube amplifier, but through the point D in Fig. 24. Its position is not affected by the operating grid bias provided the

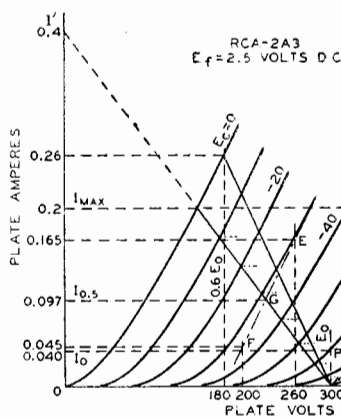

Fig. 24

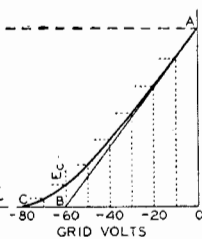

Fig. 25

power in the grid circuit. The sum of this loss and the loss in the input transformer is the total driving power required by the grid circuit. The driver stage should be capable of a power output considerably larger than this required power in order that distortion introduced in the grid circuit be kept low. The input transformer used in a class AB<sub>2</sub> amplifier usually has a step-down turns ratio.

Because of the large fluctuations of plate current in a class AB<sub>2</sub> stage, it is important that the plate power supply should have good regulation. Otherwise the fluctuations in plate current cause

plate-to-plate load resistance remains constant.

Under these conditions, grid bias has no appreciable effect on the power output. Grid bias cannot be neglected, however, since it is used to find the zero-signal plate current and, from it, the zero-signal plate dissipation. Because the grid bias is higher in class AB<sub>1</sub> than in class A service for the same plate voltage, a higher signal voltage may be used without grid current being drawn and, therefore, higher power output is obtained than in class A service.

In general, for any load line through point D, Fig. 24, the plate-to-plate load

resistance in ohms of a push-pull amplifier is  $R_{pp} = 4E_0/I'$ , where  $I'$  is the plate current value in amperes at which the load line as projected intersects the plate current axis, and  $E_0$  is in volts. This formula is another form of the one given under push-pull class A amplifiers,  $R_{pp} = 4(E_0 - 0.6E_0)/I_{max}$ , but is more general. Power output =  $(I_{max}/\sqrt{2})^2 \times R_{pp}/4$ , where  $I_{max}$  is the peak plate current at zero grid volts for the load chosen. This formula simplified is  $(I_{max})^2 \times R_{pp}/8$ . The maximum-signal average plate current is  $2I_{max}/\pi$  or  $0.636 I_{max}$ ; the maximum-signal average power input is  $0.636 I_{max} \times E_0$ .

It is desirable to simplify these formulas for a first approximation. This simplification can be made if it is assumed that the peak plate current,  $I_{max}$ , occurs at the point of the zero-bias curve corresponding approximately to  $0.6 E_0$ , the condition for maximum power output. The simplified formulas are:

$$P_o \text{ (for two tubes)} = (I_{max} \times E_0)/5$$

$$R_{pp} = 1.6E_0/I_{max}$$

where  $E_0$  is in volts,  $I_{max}$  is in amperes,  $R_{pp}$  is in ohms, and  $P_o$  is in watts.

It may be found during subsequent calculations that the distortion or the plate dissipation is excessive for this approximation; in that case, a different load resistance must be selected using the first approximation as a guide and the process repeated to obtain satisfactory operating conditions.

**Example:** Fig. 24 illustrates the application of this method to a pair of 2A3's operated at  $E_0 = 300$  volts. Each tube has a plate-dissipation rating of 15 watts. The method is to erect a vertical line at  $0.6E_0$ , or at 180 volts, which intersects the  $E_c = 0$  curve at the point  $I_{Dmax} = 0.26$  ampere. Using the simplified formulas, we obtain

$$R_{pp} = (1.6 \times 300)/0.26 = 1845 \text{ ohms}$$

$$P_o = (0.26 \times 300)/5 = 15.6 \text{ watts}$$

At this point, it is well to determine the plate dissipation and to compare it with the maximum rated value. From the average plate current formula ( $0.636 I_{max}$ ) mentioned previously, the maximum-signal average plate current is 0.166 ampere. The product of this current and the operating plate voltage is 49.8 watts, the average input to the two tubes. From this value, subtract the

power output of 15.6 watts to obtain the total dissipation for both tubes which is 34.2 watts. Half of this value, 17 watts, is in excess of the 15-watt rating of the tube and it is necessary, therefore, to assume another and higher load resistance so that the plate-dissipation rating will not be exceeded.

It will be found that at an operating plate voltage of 300 volts the 2A3's require a plate-to-plate load resistance of 3000 ohms. From the formula for  $R_{pp}$ , the value of  $I'$  is found to be 0.4 ampere. The load line for the 3000-ohm load resistance is then represented by a straight line from the point  $I' = 0.4$  ampere on the plate-current ordinate to the point  $E_0 = 300$  volts on the plate-voltage abscissa. At the intersection of the load line with the zero-bias curve, the peak plate current,  $I_{max}$ , can be read at 0.2 ampere.

$$\begin{aligned} \text{Then } P_o &= (I_{max}/\sqrt{2})^2 \times R_{pp}/4 \\ &= (0.2/1.41)^2 \times 3000/4 \\ &= 15 \text{ watts} \end{aligned}$$

Proceeding as in the first approximation, we find that the maximum-signal average plate current,  $0.636 I_{max}$ , is 0.127 ampere, and the maximum-signal average power input is 38.1 watts. This input minus the power output is  $38.1 - 15 = 23.1$  watts. This value is the dissipation for two tubes; the value per tube is 11.6 watts, a value well within the rating of this tube type.

The operating bias and the zero-signal plate current may now be found by use of a curve which is derived from the plate family and the load line. Fig. 25 is a curve of instantaneous values of plate current and dc grid-bias voltages taken from Fig. 24. Values of grid bias are read from each of the grid-bias curves of Fig. 24 along the load line and are transferred to Fig. 25 to produce the curved line from A to C. A tangent to this curve, starting at A, is drawn to intersect the grid-voltage abscissa. The point of intersection, B, is the operating grid bias for fixed-bias operation. In the example, the bias is -60 volts. Refer back to the plate family at the operating conditions of plate volts = 300 and grid bias = -60 volts; the zero-signal plate current per tube is seen to be 0.04 ampere.

This procedure locates the operating point for each tube at P. The plate cur-



rent must be doubled, of course, to obtain the zero-signal plate current for both tubes. Under maximum-signal conditions, the signal voltage swings from zero-signal bias voltage to zero bias for each tube on alternate half cycles. Hence, in the example, the peak of signal voltage per tube is 60 volts, or the grid-to-grid value is 120 volts.

As in the case of the push-pull class A amplifier, the second-harmonic distortion in a class AB<sub>1</sub> amplifier using triodes is very small and is largely canceled by virtue of the push-pull connection. Third-harmonic distortion, however, which may be larger than permissible, can be found by means of composite characteristic curves. A complete family of curves can be plotted, but for the present purpose only the one corresponding to a grid bias of one-half the peak grid-voltage swing is needed. In the example, the peak grid voltage per tube is 60 volts, and the half value is 30 volts. The composite curve, since it is nearly a straight line, can be constructed with only two points (see Fig. 24). These two points are obtained from deviations above and below the operating grid and plate voltages.

In order to find the curve for a bias of -30 volts, we have assumed a deviation of 30 volts from the operating grid voltage of -60 volts. Next assume a deviation from the operating plate voltage of, say, 40 volts. Then at  $300 - 40 = 260$  volts, erect a vertical line to intersect the  $(-60) - (-30) = -30$ -volt bias curve and read the plate current at this intersection, which is 0.167 ampere; likewise, at the intersection of a vertical line at  $300 + 40 = 340$  volts and the  $(-60) + (-30) = -90$ -volt bias curve, read the plate current. In this example, the plate current is estimated to be 0.002 ampere. The difference of 0.165 ampere between these two currents determines the point E on the  $300 - 40 = 260$ -volt vertical. Similarly, another point F on the same composite curve is found by assuming the same grid-bias deviation but a larger plate-voltage deviation, say, 100 volts.

We now have points at 260 volts and 0.165 ampere (E), and at 200 volts and 0.045 ampere (F). A straight line through these points is the composite curve for a bias of -30 volts, shown as a

long-short dash line in Fig. 24. At the intersection of the composite curve and the load line, G, the instantaneous composite plate current at the point of one-half the peak signal swing is determined. This current value, designated  $I_{0.5}$  and the peak plate current,  $I_{max}$ , are used in the following formula to find peak value of the third-harmonic component of the plate current.

$$I_{h_3} = (2I_{0.5} - I_{max})/3$$

In the example, where  $I_{0.5}$  is 0.097 ampere and  $I_{max}$  is 0.2 ampere,  $I_{h_3} = (2 \times 0.097 - 0.2)/3 = (0.194 - 0.2)/3 = -0.006/3 = -0.002$  ampere. (The fact that  $I_{h_3}$  is negative indicates that the phase relation of the fundamental (first-harmonic) and third-harmonic components of the plate current is such as to result in a slightly peaked wave form.  $I_{h_3}$  is positive in some cases, indicating a flattening of the wave form.)

The peak value of the fundamental or first-harmonic component of the plate current is found by the following formula:

$$I_{h_1} = 2/3 \times (I_{max} + I_{0.5})$$

In the example,  $I_{h_1} = 2/3 \times (0.2 + 0.097) = 0.198$  ampere. Thus, the percentage of third-harmonic distortion is  $(I_{h_3}/I_{h_1}) \times 100 = (0.002/0.198) \times 100 = 1$  per cent approx.

### Class AB<sub>2</sub> Power Amplifiers

A class AB<sub>2</sub> amplifier employs two tubes connected in push-pull as in the case of class AB<sub>1</sub> amplifiers. It differs in that it is biased so that plate current flows for somewhat more than half the electrical cycle but less than the full cycle, the peak signal voltage is greater than the dc bias voltage, grid current is drawn, and consequently, power is consumed in the grid circuit. These conditions permit high power output to be obtained without excessive plate dissipation.

The sum of the power used in the grid circuit and the losses in the input transformer is the total driving power required by the grid circuit. The driver stage should be capable of a power output considerably larger than this required power in order that distortion introduced in the grid circuit be kept low. In addition, the internal impedance of the driver stage as reflected into or as

effective in the grid circuit of the power stage should always be as low as possible in order that distortion may be kept low. The input transformer used in a class  $AB_2$  stage usually has a step-down ratio adjusted for this condition.

Load resistance, plate dissipation, power output, and distortion determinations are similar to those for class AB. These quantities are interdependent with peak grid-voltage swing and driving power; a satisfactory set of operating conditions involves a series of approximations. The load resistance and signal swing are limited by the permissible grid current and power, and the distortion. If the load resistance is too high or the signal swing is excessive, the plate-dissipation rating will be exceeded, distortion will be high, and the driving power will be unnecessarily high.

### Class B Power Amplifiers

A class B amplifier employs two tubes connected in push-pull, so biased that plate current is almost zero when no signal voltage is applied to the grids. Because of this low value of no-signal plate current, class B amplification has the same advantage as class  $AB_2$ , *i.e.*, large power output can be obtained without excessive plate dissipation. Class B operation differs from class  $AB_2$  in that plate current is cut off for a larger portion of the negative grid swing, and the signal swing is usually larger than in class  $AB_2$  operation.

Because certain triodes used as class B amplifiers are designed to operate very close to zero bias, the grid of each tube is at a positive potential during all or most of the positive half-cycle of its signal swing. In this type of triode operation, considerable grid current is drawn and there is a loss of power in the grid circuit. This condition imposes the same requirement in the driver stage as in a class  $AB_2$  stage; *i.e.*, the driver should be capable of delivering considerably more power output than the power required for the grid circuit of the class B amplifier so that distortion will be low. Similarly, the interstage transformer between the driver and the class B stage usually has a step-down turns ratio. Because of the high dissipations involved in class B operation at zero bias, it is not

feasible to use tetrodes or pentodes in this type of class B operation.

Determination of load resistance, plate dissipation, power output, and distortion is similar to that for a class  $AB_2$  stage.

Power amplifier tubes designed for class A operation can be used in class  $AB_2$  and class B service under suitable operating conditions. There are several tube types designed especially for class B service. The characteristic common to all of these types is a high amplification factor. With a high amplification factor, plate current is small even when the grid bias is zero. These tubes, therefore, can be operated in class B service at a bias of zero volts so that no bias supply is required. A number of class B amplifier tubes consist of two triode units mounted in one tube. The two units can be connected in push-pull so that only one tube is required for a class B stage. An example of a twin triode used in class B service is the 6N7.

### Cathode-Drive Circuits

The preceding text has discussed the use of tubes in the conventional **grid-drive** type of amplifier—that is, where the cathode is common to both the input and output circuits. Tubes may also be employed as amplifiers in circuit arrangements which utilize the grid or plate as the common terminal. Probably the most important of these amplifiers are the cathode-drive circuit, which is discussed below, and the cathode-follower circuit, which will be discussed later in connection with inverse feedback.

A typical **cathode-drive** circuit is shown in Fig. 26. The load is placed in

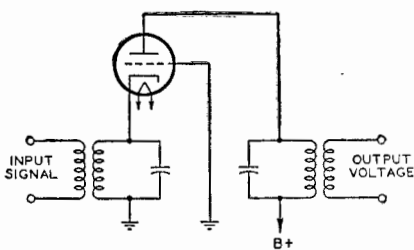

the plate circuit and the output voltage is taken off between the plate and ground

as in the grid-drive method of operation. The grid is grounded, and the input voltage is applied across an appropriate impedance in the cathode circuit. The cathode-drive circuit is particularly useful for vhf and uhf applications, in which it is necessary to obtain the low-noise performance usually associated with a triode, but where a conventional grid-drive circuit would be unstable because of feedback through the grid-to-plate capacitance of the tube. In the cathode-drive circuit, the grounded grid serves as a capacitive shield between plate and cathode and permits stable operation at frequencies higher than those in which conventional circuits can be used.

The input impedance of a cathode-drive circuit is approximately equal to  $1/g_m$  when the load resistance is small compared to the  $r_p$  of the tube. A certain amount of power is required, therefore, to drive such a circuit. However, in the type of service in which cathode-drive circuits are normally used, the advantages of the grounded-grid connection usually outweigh this disadvantage.

### Inverse Feedback

An inverse-feedback circuit, sometimes called a **degenerative** circuit, is one in which a portion of the output voltage of a tube is applied to the input of the same or a preceding tube in opposite phase to the signal applied to the tube. Two important advantages of feedback are: (1) reduced distortion from each stage included in the feedback circuit and (2) reduction in the variations in gain due to changes in line voltage, possible differences between tubes of the same type, or variations in the values of circuit constants included in the feedback circuit.

Inverse feedback is used in audio amplifiers to reduce distortion in the output stage where the load impedance on the tube is a loudspeaker. Because the impedance of a loudspeaker is not constant for all audio frequencies, the load impedance on the output tube varies with frequency. When the output tube is a pentode or beam power tube having high plate resistance, this variation in plate load impedance can, if not corrected, produce considerable frequency distortion. Such frequency distortion

can be reduced by means of inverse feedback. Inverse-feedback circuits are of the **constant-voltage** type and the **constant-current** type.

The application of the **constant-voltage** type of inverse feedback to a power output stage using a single beam power tube is illustrated by Fig. 27. In this circuit,  $R_1$ ,  $R_2$ , and  $C$  are connected as a voltage divider across the output of the tube. The secondary of the grid-input transformer is returned to a point on this voltage divider. Capacitor  $C$  blocks the dc plate voltage from the grid. However, a portion of the tube's af output voltage, approximately equal to the output voltage multiplied by the fraction  $R_2/(R_1 + R_2)$ , is applied to the grid. This voltage lowers the source impedance of the circuit and a decrease in distortion results which is explained in the curves of Fig. 28.

Consider first the amplifier without the use of inverse feedback. Suppose that when a signal voltage  $e_s$  is applied to the grid the af plate current  $i'_p$  has an irregularity in its positive half-cycle. This irregularity represents a departure from the waveform of the input signal and is, therefore, distortion. For this

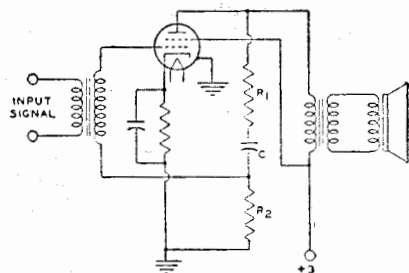

Fig. 27

plate-current waveform, the af plate voltage has a waveform shown by  $e'_p$ . The plate-voltage waveform is inverted compared to the plate-current waveform because a plate-current increase produces an increase in the drop across the plate load. The voltage at the plate is the difference between the drop across the load and the supply voltage; thus, when plate current goes up, plate voltage goes down; when plate current goes down, plate voltage goes up.

Now suppose that inverse feedback is applied to the amplifier. The voltage

fed back to the grid has the same waveform and phase as the plate voltage, but is smaller in magnitude. Hence, with a plate voltage of waveform shown by

verse feedback to an amplifier requires that more driving voltage be applied to obtain full power output, but this output is obtained with less distortion.

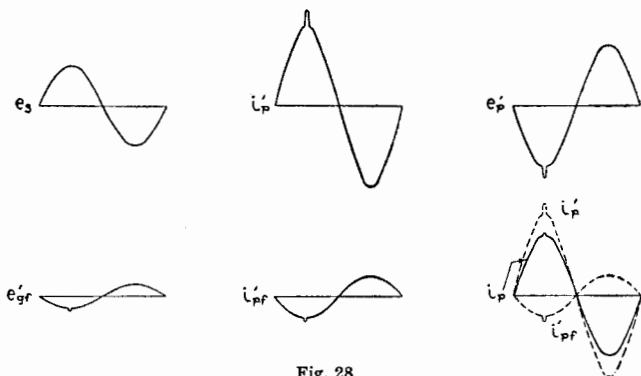

Fig. 28

$e'_p$ , the feedback voltage appearing on the grid is as shown by  $e'_{gf}$ . This voltage applied to the grid produces a component of plate current  $i'_{pf}$ . It is evident that the irregularity in the waveform of this component of plate current would act to cancel the original irregularity and thus reduce distortion.

After inverse feedback has been applied, the relations are as shown in the curve for  $i_p$ . The dotted curve shown by  $i'_{pf}$  is the component of plate current due to the feedback voltage on the grid. The dotted curve shown by  $i'_p$  is the component of plate current due to the signal voltage on the grid. The algebraic sum of these two components gives the resultant plate current shown by the solid curve of  $i_p$ . Since  $i'_p$  is the plate current that would flow without inverse feedback, it can be seen that the application of inverse feedback has reduced the irregularity in the output current. In this manner inverse feedback acts to correct any component of plate current that does not correspond to the input signal voltage, and thus reduces distortion.

From the curve for  $i_p$ , it can be seen that, besides reducing distortion, inverse feedback also reduces the amplitude of the output current. Consequently, when inverse feedback is applied to an amplifier there is a decrease in gain or power sensitivity as well as a decrease in distortion. Hence, the application of in-

verse feedback may also be applied to resistance-coupled stages as shown in Fig. 29. The circuit is conventional except that a feedback resistor,  $R_3$ , is connected between the plates of tubes  $T_1$  and  $T_2$ . The output signal voltage of  $T_1$  and a portion of the output signal voltage of  $T_2$  appears across  $R_2$ . Because the distortion generated in the plate circuit of  $T_2$  is applied to its grid out of phase with the input signal, the distortion in the output of  $T_2$  is comparatively low. With sufficient inverse feedback of the constant-voltage type in a power-output stage, it is not necessary to employ a network of resistance and capacitance in the output circuit to reduce response at high audio frequencies. Inverse-feedback circuits can also be applied to push-pull class A and class AB<sub>1</sub> amplifiers.

**Constant-current** inverse feedback is usually obtained by omitting the bypass capacitor across a cathode resistor.

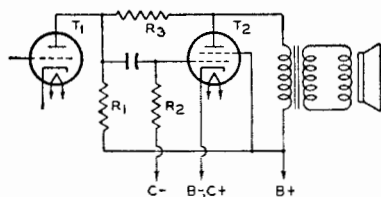

Fig. 29

This method decreases the gain and the distortion but increases the source im-

pedance of the circuit. Consequently, the output voltage rises at the resonant frequency of the loudspeaker and accentuates hangover effects.

Inverse feedback is not generally applied to a triode power amplifier, such as the 2A3, because the variation in speaker impedance with frequency does not produce much distortion in a triode stage having low plate resistance. It is sometimes applied in a pentode stage but is not always convenient. As has been shown, when inverse feedback is used in an amplifier, the driving voltage must be increased in order to give full power output. When inverse feedback is used with a pentode, the total driving voltage required for full power output may be inconveniently large, although still less than that required for a triode. Because a beam power tube gives full power output on a comparatively small driving voltage, inverse feedback is especially applicable to beam power tubes. By means of inverse feedback, the high efficiency and high power output of beam power tubes can be combined with freedom from the effects of varying speaker impedance.

### Cathode-Follower Circuits

Another important application of inverse feedback is in the cathode-follower circuit, an example of which is given in Fig. 30. In this application, the load has been transferred from the plate circuit to the cathode circuit of the tube. The input voltage is applied between the grid and ground and the output voltage is obtained between the cathode and ground. The voltage amplification (V.A.) of this circuit is always less than unity and may be expressed by the following convenient formulas.

For a triode:

$$V. A. = \frac{\mu \times R_L}{r_p + [R_L \times (\mu + 1)]}$$

For a pentode:

$$V. A. = \frac{g_m \times R_L}{1 + (g_m \times R_L)}$$

In these formulas,  $\mu$  is the amplification factor,  $R_L$  is the load resistance in ohms,  $r_p$  is the plate resistance in ohms, and  $g_m$  is the transconductance in mhos.

The use of the cathode follower permits the design of circuits which have high input resistance and high output

voltage. The output impedance is quite low and very low distortion may be obtained. Cathode-follower circuits may be used for power amplifiers or as impedance transformers designed either to match a transmission line or to produce a relatively high output voltage at a low impedance level.

In a power amplifier which is transformer coupled to the load, the same output power can be obtained from the tube as would be obtained in a conventional grid-drive type of amplifier. The output impedance is very low and provides excellent damping to the load, with the result that very low distortion can be obtained. The peak-to-peak signal voltage, however, approaches  $1\frac{1}{2}$  times the plate supply voltage if maximum power output is required from the tube. Some problems may be encountered, therefore, in the design of an ade-

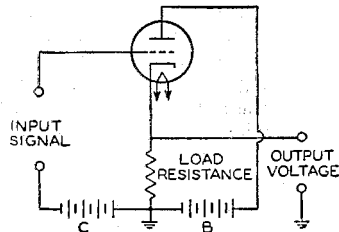

Fig. 30

quate driver stage for a cathode-follower output system.

When a cathode-follower circuit is used as an impedance transformer, the load is usually a simple resistance in the cathode circuit of the tube. With relatively low values of cathode resistor, the circuit may be designed to supply significant amounts of power and to match the impedance of the device to a transmission line. With somewhat higher values of cathode resistor, the circuit may be used to lower the output impedance sufficiently to permit the transmission of audio signals along a line in which appreciable capacitance is present.

The cathode follower may also be used as an isolation device to provide extremely high input resistance and low input capacitance as might be required in the probe of an oscilloscope or vacuum-tube voltmeter. Such circuits can be designed to provide effective impedance transformation with no significant loss

of voltage.

Selection of a suitable tube and its operating conditions for use in a cathode-follower circuit having a specified output impedance ( $Z_o$ ) can be made, in most practical cases, by the use of the following formula to determine the approximate value of the required tube transconductance.

$$\text{Required } g_m (\mu\text{mhos}) = \frac{1,000,000}{Z_o (\text{ohms})}$$

Once the required transconductance is obtained, a suitable tube and its operating conditions may be determined from the technical data given in the TUBE TYPES SECTION. The tube selected should have a value of transconductance slightly lower than that obtained from the above expression to allow for the shunting effect of the cathode load resistance. The conversion nomograph given in Fig. 23 may be used for calculation of operating conditions for values of transconductance not included in the tabulated data. After the operating conditions have been determined, the approximate value of the required cathode load resistance may be calculated from the following formulas.

For triode:

$$\text{Cathode } R_L = \frac{Z_o \times r_p}{r_p - [Z_o \times (1 + \mu)]}$$

For pentode:

$$\text{Cathode } R_L = \frac{Z_o}{1 - (g_m \times Z_o)}$$

Resistance and impedance values are in ohms; transconductance values are in mhos.

If the value of the cathode load resistance calculated to give the required output impedance does not give the required operating bias, the basic cathode-follower circuit can be modified in a number of ways. Two of the more common modifications are given in Figs. 31 and 32.

In Fig. 31 the bias is increased by adding a bypassed resistance between the cathode and the unbypassed load resistance and returning the grid to the low end of the load resistance. In Fig. 32 the bias is reduced by adding a bypassed resistance between the cathode and the unbypassed load resistance but, in this case, the grid is returned to the junction of the two cathode resistors so that the bias voltage is only the dc voltage drop across the added resistance. The size of

the bypass capacitor should be large enough so that it has negligible reactance at the lowest frequency to be handled. In both cases the B-supply should be in-

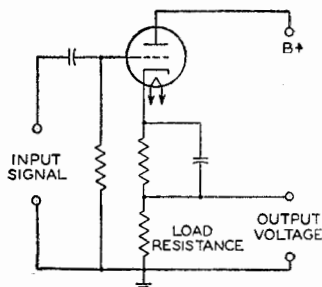

Fig. 31

creased to make up for the voltage taken for biasing.

**Example:** Select a suitable tube and determine the operating conditions and circuit components for a cathode-follower circuit having an output impedance that will match a 500-ohm transmission line. **Procedure:** First, determine the approximate transconductance required.

$$\text{Required } g_m = \frac{1,000,000}{500} = 2000 \mu\text{mhos}$$

A survey of the tubes that have a transconductance in this order of magnitude shows that type 12AX7 is among the tubes to be considered. Referring to the characteristics given in the technical data section for one triode unit of high-mu twin triode 12AX7, we find that for a plate voltage of 250 volts and a bias of -2 volts, the transconductance is 1600

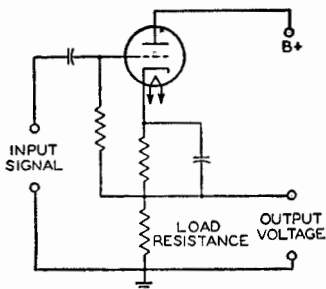

Fig. 32

micromhos, the plate resistance is 62500 ohms, the amplification factor is 100, and the plate current is 0.0012 ampere.

When these values are used in the expression for determining the cathode load resistance, we obtain

$$\text{Cathode } R_L = \frac{500 \times 62500}{62500 - 500 \times (100 + 1)} = 2600 \text{ ohms}$$

The voltage across this resistor for a plate current of 0.0012 ampere is  $2600 \times 0.0012 = 3.12$  volts. Because the required bias voltage is only -2 volts, the circuit arrangement given in Fig. 32 is employed. The bias is furnished by a resistance that will have a voltage drop of 2 volts when it carries a current of 0.0012 ampere. The required bias resistance, therefore, is  $2/0.0012 = 1670$  ohms. If 60 cycles per second is the lowest frequency to be passed, 20 microfarads is a suitable value for the bypass capacitor. The B-supply, of course, is increased by the voltage drop across the cathode resistance which, in this example, is approximately 5 volts. The B-supply, therefore, is  $250 + 5 = 255$  volts.

Because it is desirable to eliminate, if possible, the bias resistor and bypass capacitor, it is worthwhile to try other tubes and other operating conditions to obtain a value of cathode load resistance which will also provide the required bias. If the triode section of twin diode—high- $\mu$  triode 6AT6 is operated under the conditions given in the technical data section with a plate voltage of 100 volts and a bias of -1 volt, it will have an amplification factor of 70, a plate resistance of 54000 ohms, a transconductance of 1300 micromhos, and a plate current of 0.0008 ampere.

Then,

$$\text{Cathode } R_L = \frac{500 \times 54000}{54000 - 500 \times (70 + 1)} = 1460 \text{ ohms}$$

The bias voltage obtained across this resistance is  $1460 \times 0.0008 = 1.17$  volts. Since this value is for all practical purposes close enough to the required bias, no additional bias resistance will be required and the grid may be returned directly to ground. There is no need to adjust the B-supply voltage to make up for the drop in the cathode resistor. The voltage amplification (V.A.) for the cathode-follower circuit utilizing the triode section of type 6AT6 is

$$\text{V.A.} = \frac{70 \times 1460}{54000 + 1460 \times (70 + 1)} = 0.65$$

For applications in which the cathode follower is used to isolate two circuits—for example, when it is used between a circuit being tested and the input stage of an oscilloscope or a vacuum-tube voltmeter—voltage output and not impedance matching is the primary consideration. In such applications it is desirable to use a relatively high value of cathode load resistance, such as 50,000 ohms, in order to get the maximum voltage output. In order to obtain proper bias, a circuit such as that of Fig. 32 should be used. With a high value of cathode resistance, the voltage amplification will approximate unity.

### Corrective Filters

A corrective filter can be used to improve the frequency characteristic of an output stage using a beam power tube or a pentode when inverse feedback is not applicable. The filter consists of a resistor and a capacitor connected in series across the primary of the output transformer. Connected in this way, the filter is in parallel with the plate load impedance reflected from the voice-coil by the output transformer. The magnitude of this reflected impedance increases with increasing frequency in the middle and upper audio range. The impedance of the filter, however, decreases with increasing frequency. It follows that by use of the proper values for the resistance and the capacitance in the filter, the effective load impedance on the output tubes can be made practically constant for all frequencies in the middle and upper audio range. The result is an improvement in the frequency characteristic of the output stage.

The resistance to be used in the filter for a push-pull stage is 1.3 times the recommended plate-to-plate load resistance; or, for a single-tube stage, is 1.3 times the recommended plate load resistance. The capacitance in the filter should have a value such that the voltage gain of the output stage at a frequency of 1000 cycles or higher is equal to the voltage gain at 400 cycles.

A method of determining the proper value of capacitance for the filter is to make two measurements of the output voltage across the primary of the output transformer: first, when a 400-cycle sig-



nal is applied to the input, and second, when a 1000-cycle signal of the same voltage as the 400-cycle signal is applied to the input. The correct value of capacitance is the one which gives equal output voltages for the two signal inputs. In practice, this value is usually found to be in the order of 0.05 microfarad.

### Volume Expanders

A volume expander can be used in a phonograph amplifier to make more natural the reproduction of music which has a very large volume range. For instance, in the music of a symphony orchestra, the sound intensity of the loud passages is very much higher than that of the soft passages. When this music is recorded, it may not be feasible to make the ratio of maximum amplitude to minimum amplitude as large on the record as it is in the original music. The recording process may therefore be monitored so that the volume range of the original is compressed on the record. To compensate for this compression, a volume-expander amplifier has a variable gain which is greater for a high-amplitude signal than for a low-amplitude signal. The volume expander, therefore, amplifies loud passages more than soft passages.

A volume expander circuit is shown in Fig. 33. In this circuit, the gain of the 6L7 as an audio amplifier can be varied

grid of the 6J5, is amplified by the 6J5, and is rectified by the 6H6. The rectified voltage developed across  $R_5$ , the load resistor of the 6H6, is applied as a positive bias voltage to grid No. 3 of the 6L7. Then, when the amplitude of the signal input increases, the voltage across  $R_5$  increases, and the bias on grid No. 3 of the 6L7 is made less negative. Because this reduction in bias increases the gain of the 6L7, the gain of the amplifier increases with increase in signal amplitude and thus produces volume expansion of the signal. The voltage gain of the expander varies from 5 to 20.

Grid No. 1 of the 6L7 is a variable-mu grid and, therefore, will produce distortion if the input signal voltage is too large. For that reason, the signal input to the 6L7 should not exceed a peak value of 1 volt. The no-signal bias voltage on grid No. 3 is controlled by adjustment of contact P. This contact should be adjusted initially to give a no-signal plate current of 0.15 milliampere in the 6L7. No further adjustment of contact P is required if the same 6L7 is always used. If it is desired to delay volume expansion until the signal input reaches a certain amplitude, the delay voltage can be inserted as a negative bias on the 6H6 plates at the point marked X in the diagram. All terminal points on the power-supply voltage divider should be adequately bypassed.

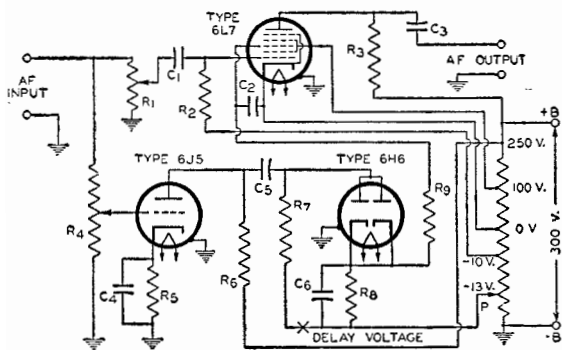

Fig. 33

- $C_1, C_3, C_5 = 0.1 \mu f$
- $C_2, C_4, C_6 = 0.5 \mu f$
- $R_1 = 1\text{-Megohm Potentiometer (Volume Control)}$
- $R_2 = 1 \text{ Megohm}$
- $R_3, R_6 = 100,000 \text{ ohms, } 1 \text{ watt}$
- $R_4 = 1\text{-Megohm Potentiometer (Expansion Control)}$
- $R_5 = 10,000 \text{ ohms, } 0.1 \text{ watt}$
- $R_7 = 100,000 \text{ ohms, } 0.1 \text{ watt}$
- $R_8 = 250,000 \text{ ohms, } 0.1 \text{ watt}$
- $R_9 = 500,000 \text{ ohms, } 0.1 \text{ watt}$

by changing the bias on grid No. 3. When the bias on grid No. 3 is made less negative, the gain of the 6L7 increases. The signal to be amplified is applied to grid No. 1 of the 6L7 and is amplified by the 6L7. The signal is also applied to the

### Phase Inverters

A phase inverter is a circuit used to provide resistance coupling between the output of a single-tube stage and the input of a push-pull stage. The necessity for a phase inverter arises because the

signal-voltage inputs to the grids of a push-pull stage must be 180 degrees out of phase and approximately equal in amplitude with respect to each other. Thus, when the signal voltage input to a push-pull stage swings the grid of one tube in a positive direction, it should swing the grid of the other tube in a negative direction by a similar amount. With transformer coupling between stages, the out-of-phase input voltage to the push-pull stage is supplied by means of the center-tapped secondary. With resistance coupling, the out-of-phase input voltage is obtained by means of the inverter action of a tube.

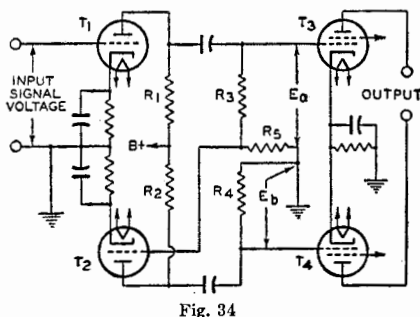

Fig. 34

Fig. 34 shows a push-pull power amplifier, resistance-coupled by means of a phase-inverter circuit to a single-stage triode  $T_1$ . Phase inversion in this circuit is provided by triode  $T_2$ . The output voltage of  $T_1$  is applied to the grid of triode  $T_3$ . A portion of the output voltage of  $T_1$  is also applied through the resistors  $R_3$  and  $R_6$  to the grid of  $T_2$ . The output voltage of  $T_2$  is applied to the grid of triode  $T_4$ .

When the output voltage of  $T_1$  swings in the positive direction, the plate current of  $T_2$  increases. This action increases the voltage drop across the plate resistor  $R_2$  and swings the plate of  $T_2$  in the negative direction. Thus, when the output voltage of  $T_1$  swings positive, the output voltage of  $T_2$  swings negative and is, therefore, 180° out of phase with the output voltage of  $T_1$ .

In order to obtain equal voltages at  $E_a$  and  $E_b$ ,  $(R_3+R_6)/R_5$  should equal the voltage gain of  $T_2$ . Under the conditions where a twin-type tube or two tubes having the same characteristics are used at  $T_1$  and  $T_2$ ,  $R_4$  should be equal to

the sum of  $R_3$  and  $R_6$ . The ratio of  $R_3+R_6$  to  $R_5$  should be the same as the voltage gain ratio of  $T_2$  in order to apply the correct value of signal voltage to  $T_2$ . The value of  $R_5$  is, therefore, equal to  $R_4$  divided by the voltage gain of  $T_2$ ;  $R_3$  is equal to  $R_4$  minus  $R_6$ . Values of  $R_1$ ,  $R_2$ ,  $R_3$  plus  $R_6$ , and  $R_4$  may be taken from the chart in the RESISTANCE-COUPLED AMPLIFIER SECTION. In the practical application of this circuit, it is convenient to use a twin-triode tube combining  $T_1$  and  $T_2$ .

### Tone Controls

A tone control is a variable filter (or one in which at least one element is adjustable) by means of which the user may vary the frequency response of an amplifier to suit his own taste. In radio receivers and home amplifiers, the tone control usually consists of a resistance-capacitance network in which the resistance is the variable element.

The simplest form of tone control is a fixed tone-compensating or "equalizing" network such as that shown in Fig. 35. This type of network is often used to equalize the low- and high-frequency response of a crystal phonograph pickup. At low frequencies the attenuation of this network is 20.8 db. As

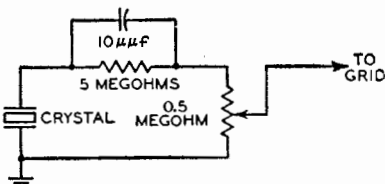

Fig. 35

the frequency is increased, the 100-microfarad capacitor serves as a bypass for the 5-megohm resistor, and the combined impedance of the resistor-capacitor network is lowered. Thus, more of the crystal output appears across the 0.5-megohm resistor at high frequencies than at low frequencies, and the frequency response at the grid is reasonably flat over a wide frequency range. Fig. 36 shows a comparison between the output of the crystal (curve A) and the output of the equalizing network (curve B.) The response curve can be "flattened" still more if the attenuation at low fre-

quencies is increased by changing the 0.5-megohm resistor to 0.125 megohm.

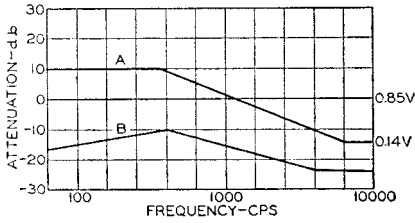

Fig. 36

The tone-control network shown in Fig. 37 has two stages with completely separate bass and treble controls. Fig. 38 shows simplified representations of the bass control of this circuit when the

parallel combination is shifted so that  $C_1$  bypasses  $R_3$ , causing more high-frequency than low-frequency output. Essentially, the network is a variable-frequency voltage divider. With proper values for the components, it may be made to respond to changes in the  $R_3$  potentiometer setting for only low frequencies (below 1000 cycles).

Fig. 39 shows extreme positions of the treble control. The attenuation of the two circuits is approximately the same at 1000 cycles. The treble "boost" circuit is similar to the crystal-equalizing network shown in Fig. 35. In the treble "cut" circuit, the parallel RC elements serve to attenuate the signal voltage further because the capacitor bypasses the resistance across the output.

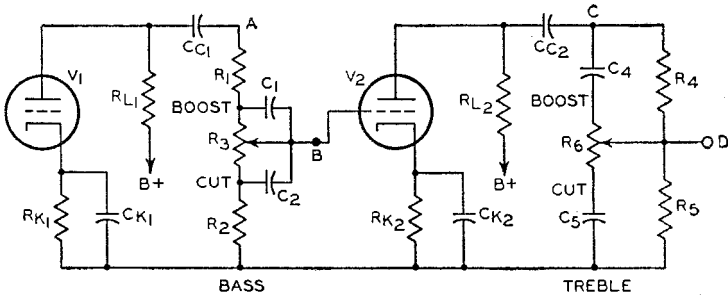

Fig. 37

potentiometer is turned to its extreme variations (usually labeled "Boost" and "Cut"). In this network, as in the crystal-equalizing network shown in Fig. 35, the parallel RC combination is the controlling factor. For bass "boost", the capacitor  $C_2$  bypasses resistor  $R_2$  so that

The effect of the capacitor is negligible at low frequencies; beyond 1000 cycles, the signal voltage is attenuated at a maximum rate of 6 db per octave.

The location of a tone-control network is of considerable importance. In a typical radio receiver, it may be inserted

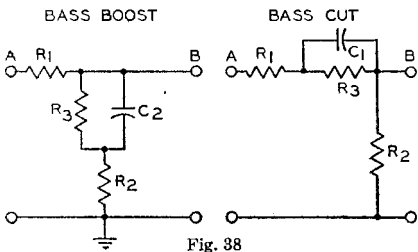

Fig. 38

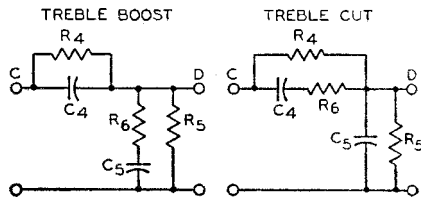

Fig. 39

less impedance is placed across the output to grid B at high frequencies than at low frequencies. For bass "cut," the

in the plate circuit of the power tube, the coupling circuit between the first af amplifier tube and the power tube, or

the grid circuit of the first tube. In an amplifier using a beam power tube or pentode power amplifier without negative feedback, it is desirable to connect a resistance-capacitance filter across the primary of the output transformer. This filter may be fixed, with a supplementary tone control elsewhere, or it may form the tone control itself. If the amplifier incorporates negative feedback, the tone control may be inserted in the feedback network or else should be connected to a part of the amplifier which is external to the feedback loop. The over-all gain of a well designed tone-control network should be approximately unity.

### *Limiters*

An amplifier may also be used as a limiter. One use of a limiter is in receivers designed for the reception of frequency-modulated signals. The limiter in FM receivers has the function of eliminating amplitude variations from the input to the detector. Because in an FM system amplitude variations are primarily the result of noise disturbances, the use of a limiter prevents such disturbances from being reproduced in the audio output. The limiter usually follows the last if stage so that it can minimize the effects of disturbances coming in on the rf carrier and those produced locally.

The limiter is essentially an if voltage amplifier designed for saturated operation. Saturated operation means that an increase in signal voltage above a certain value produces very little increase in plate current. A signal voltage which is never less than sufficient to cause saturation of the limiter, even on weak signals, is supplied to the limiter input by the preceding stages. Any change in amplitude, therefore, such as might be produced by noise voltage fluctuation, is not reproduced in the limiter output. The limiting action, of course, does not interfere with the reproduction of frequency variations.

Plate-current saturation of the limiter may be obtained by the use of grid-No.1-resistor-and-capacitor bias with plate and grid-No.2 voltages which are low compared with customary if-amplifier operating conditions.

As a result of these design features, the limiter is able to maintain its output voltage at a constant amplitude over a wide range of input-signal voltage variations. The output of the limiter is frequency-modulated if voltage, the mean frequency of which is that of the if amplifier. This voltage is impressed on the input of the detector.

The reception of FM signals without serious distortion requires that the response of the receiver be such that satisfactory amplification of the signal is provided over the entire range of frequency deviation from the mean frequency. Since the frequency at any instant depends on the modulation at that instant, it follows that excessive attenuation toward the edges of the band, in the rf or if stages, will cause distortion. In a high-fidelity receiver, therefore, the amplifiers must be capable of amplifying, for the maximum permissible frequency deviation of 75 kilocycles, a band 150 kilocycles wide. Suitable tubes for this purpose are the 6BA6 and 6BJ6.

### *Television RF Amplifiers*

All amplifier stages generate a certain amount of noise as a result of thermal agitation of electrons in resistors or other components, minute variations in the cathode emission of tubes (shot effect), and minute grid currents in the amplifier tubes. In a radio or television receiver, noise generated in the first amplifier stage is often the controlling factor in determining the over-all sensitivity of the receiver. The "front end" of a receiver, therefore, is designed with special attention to both gain and noise characteristics.

Tuner input circuits of vhf television receivers use either a triode or a pentode in the rf amplifier stage. Such stages are required to amplify signals ranging from 55 to 216 Mc and having a bandwidth of 4.5 Mc, although the tuner is usually aligned for a bandwidth of 6 Mc to assure complete coverage of the band. In the early rf tuners, pentodes rather than triodes were used because the grid-plate capacitance of triodes created stability problems. The use of twin triodes in direct-coupled cathode-drive circuits makes it possible to obtain stable opera-

tion along with the low-noise characteristics of triodes.

Pentodes or tetrodes do not provide the sensitivity of triodes because of the "partition noise" introduced by the screen grid. The direct-coupled cathode-drive circuit provides both the gain and the stability capabilities of the pentode and a low-noise triode input stage. Because the cathode-drive stage provides a low-impedance load to the grounded-cathode stage, its gain is very low and there is no necessity for neutralizing the grid-plate capacitance. An interstage impedance, usually an inductance in series with the plate of the first stage and the cathode of the second stage, is often used at higher frequencies to provide a degree of impedance matching between the units. The cathode-drive portion of the circuit is matched to the input network and provides most of the stage gain. Because the feedback path of the cathode-drive circuit is the plate-cathode capacitance, which in most cases is very small, excellent isolation is provided between the antenna and the local oscillator.

Development of single triodes having low grid-plate capacitance has made possible the design of a neutralized triode rf circuit. The 6BN4 has been used commercially in neutralized triode circuits. Tubes such as the 6GK5 and 6CW4, now in common usage, were specially designed to minimize grid-plate capacitance to permit easier neutralization of a grounded-cathode circuit over the wide frequency band. The bridge-neutralized rf amplifier circuit has become widely used in television tuners. In this arrangement, a portion of the output signal is returned to the grid out of phase with the feedback signal from the grid-plate capacitance. This circuit provides excellent gain and noise performance with stable operation across the band.

### Video Amplifiers

The video amplifier stage in a television receiver usually employs a pentode-type tube specially designed to amplify the wide band of frequencies contained in the video signal and, at the same time, to provide high gain per stage. Pentodes are more useful than

triodes in such stages because they have high transconductance (to provide high gain) together with low input and output interelectrode capacitances (to permit the broadband requirements to be satisfied). An approximate "figure of merit" for a particular tube for this application can be determined from the ratio of its transconductance,  $g_m$ , to the sum of its input and output capacitances,  $C_{in}$  and  $C_{out}$ , as follows:

$$\text{Figure of Merit} = \frac{g_m}{C_{in} + C_{out}}$$

Typical values for this figure are in the order of  $500 \times 10^6$  or greater.

A typical video amplifier stage, such as that shown in Fig. 40, is connected between the second detector of the television receiver and the picture

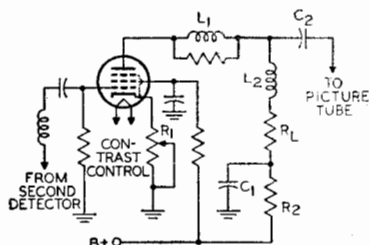

Fig. 40

tube. The contrast control,  $R_1$ , in this circuit controls the gain of the video amplifier tube. The inductance,  $L_2$ , in series with the load resistor,  $R_L$ , maintains the plate load impedance at a relatively constant value with increasing frequency. The inductance  $L_1$  isolates the output capacitance of the tube so that only stray capacitance is placed across the load. As a result, a higher-value load resistor is used to provide higher gain without affecting frequency response or phase relations. The decoupling circuit,  $C_1R_2$ , is used to improve the low-frequency response. Tubes used as video amplifiers include types 6CL6 and 12BY7-A, or the pentode sections of types 6AW8-A and 6AN8.

The luminance amplifier in a color-television receiver is a conventional video amplifier having a bandwidth of approximately 3.5 Mc. In a color receiver, the portion of the output of the second detector which lies within the frequency

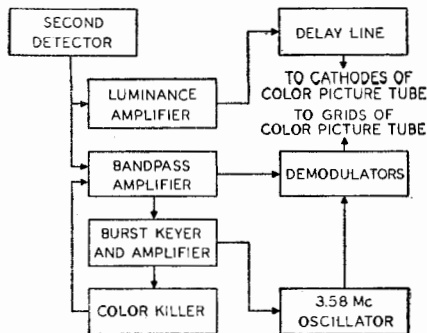

Fig. 41

band from approximately 2.4 to 4.5 Mc is fed to a bandpass amplifier, as shown in the block diagram in Fig. 41. The color synchronizing signal, or "burst," contained in this signal may then be fed to a "burst-keyer" tube. At the same time, a delayed horizontal pulse may be applied to the keyer tube. The output of the keyer tube is applied to the burst amplifier tube and the signal is then fed to the 3.58-Mc oscillator and to the "color-killer" stage.

The color killer applies a bias voltage to the bandpass amplifier in the absence of burst so that the color section, or chrominance channel, of the receiver remains inoperative during black-and-white broadcasts. A threshold control varies the bias and controls the burst level at which the killer stage operates.

The output of the 3.58-Mc oscillator and the output of the bandpass amplifier are fed into phase and amplitude demodulator circuits. The output of each demodulator circuit is an electrical representation of a color-difference signal, *i.e.*, an actual color signal minus the black-and-white, or luminance, signal. The two color-difference signals are combined to produce the third color-difference signal; each of the three signals then represents one of the primary colors.

The three color-difference signals are usually applied to the grids of the three electron guns of the color picture tube, in which case the black-and-white signal from the luminance amplifier may be applied simultaneously to the cathodes. The chrominance and luminance signals then combine to produce the color picture. In the absence of trans-

mitted color information, the chrominance channel is cut off by the color killer, as described above, and only the luminance signal is applied to the picture tube, producing a black-and-white picture.

### Television Sync Circuits

In addition to picture information, the composite video signal supplied to a television receiver contains information to assure that the picture produced on the receiver is synchronized with the picture being viewed by the camera or pickup tube. The "sync" pulses, which have a greater amplitude than the video signal, trigger the scanning generators of the receiver when the electron beam of the pickup tube ends each trace.

The sync pulses in the composite video signal may be separated from the video information in the output of the second or video detector by means of the triode circuit shown in Fig. 42. In this circuit, the time constant of the network

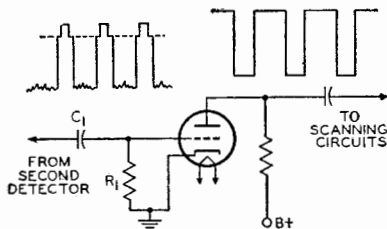

Fig. 42

$R_1C_1$  is long with respect to the interval between pulses. During each pulse, the grid is driven positive and draws current, thereby charging capacitor  $C_1$ . Consequently, the grid develops a bias which is slightly greater than the cutoff voltage of the tube. Because plate current flows only during the sync-pulse period, only the amplified pulse appears in the output. This sync-separator stage discriminates against the video information. Because the bias developed on the grid is proportional to the strength of the incoming signal, the circuit also has the advantage of being relatively independent of signal fluctuations.

Because the electron beam scans the face of the picture tube at different rates in the vertical and horizontal directions, the receiver incorporates two different scanning generators. The repe-

tion rate of the vertical generator is 60 cycles per second, and the rate of the horizontal generator is approximately 15,750 cycles per second. The composite video signal includes information which enables each generator to derive its correct triggering. One horizontal sync pulse is supplied at the end of each horizontal line scan. At the end of each frame, several pulses of longer duration than the horizontal sync pulses are supplied to actuate the vertical generator. The vertical information is separated from the horizontal information by differentiating and integrating circuits.

In fringe areas, two conditions complicate the process of sync separation. First, the incoming signal available at the antenna is weak and susceptible to fading and other variations; second, the receiver is operating at or near maximum gain which makes it extremely susceptible to interference from pulse-type noise generated by certain types of electrical equipment, ignition systems, switches, or the like. Some type of **noise-immunity** provision is almost essential for acceptable performance. Noise may be reduced or eliminated from the sync and agc circuits by gating or by a combination of gating, inversion, and cancellation. An example, of the latter method is shown in Fig. 43. In this circuit the 6GY6, which has two independent control grids, serves the dual function of agc amplifier and noise inverter. Because the sync tips of the video signal at grid No.1 of the 6GY6 drive the tube near its cutoff region, any noise signal extending above the tip level will appear inverted across the grid-No.2 load resistor R. This inverted noise signal is re-combined with the video signal and fed to the sync separator at point "A" Fig. 43 where noise cancellation takes place. This process leaves the sync pulses relatively free of disturbing noise and results in a stable picture. To prevent reduction of receiver gain due to the effect of noise on the agc amplifier, a portion of the inverted noise signal is fed to the second control grid, grid No.3, of the 6GY6 to cut off or gate the AGC amplifier when a noise pulse occurs.

### Rectification

The rectifying action of a diode

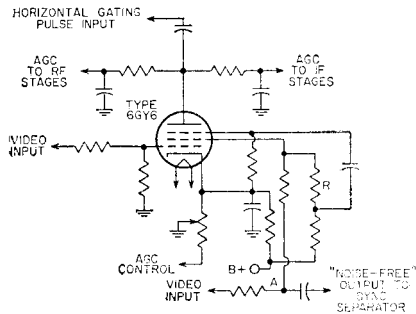

Fig. 43

finds important applications in supplying a receiver with dc power from an ac line and in supplying high dc voltage from a high-voltage pulse. A typical arrangement for converting ac to dc includes a rectifier tube, a filter, and a voltage divider. The rectifying action of the tube is explained briefly under *Diodes*, in the **ELECTRONS, ELECTRODES, and ELECTRON TUBE SECTION**. High-voltage pulse rectification is described later under *Horizontal Output Circuits*.

The function of a filter is to smooth out the ripple of the tube output, as indicated in Fig. 44, and to increase rectifier efficiency. The action of the filter is explained in **ELECTRON TUBE INSTALLATION SECTION** under *Filters*. The voltage divider is used to cut down the output voltage to the values required by the plates and the other electrodes of the tubes in the receiver.

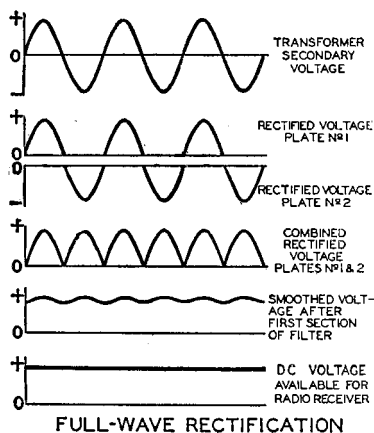

Fig. 44

A half-wave rectifier and a full-wave rectifier circuit are shown in Fig. 45. In the half-wave circuit, current flows through the rectifier tube to the filter on every other half-cycle of the ac input voltage when the plate is positive with respect to the cathode. In the full-wave circuit, current flows to the filter on every half-cycle, through plate No. 1 on one half-cycle when plate No. 1 is

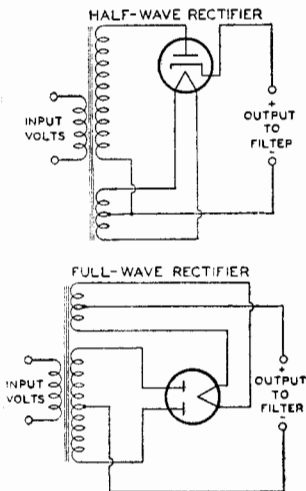

Fig. 45

positive with respect to the cathode, and through plate No. 2 on the next half-cycle when plate No. 2 is positive with respect to the cathode.

Because the current flow to the filter is more uniform in the full-wave circuit than in the half-wave circuit, the output of the full-wave circuit requires less filtering. Rectifier operating information and circuits are given under each rectifier tube type and in the CIRCUIT SECTION, respectively.

**Parallel operation** of rectifier tubes furnishes an output current greater than that obtainable with the use of one tube. For example, when two full-wave rectifier tubes are connected in parallel, the plates of each tube are connected together and each tube acts as a half-wave rectifier. The allowable voltage and load conditions per tube are the same as for full-wave service but the total load-handling capability of the complete rectifier is approximately doubled.

When mercury-vapor rectifier tubes are connected in parallel, a stabilizing resistor of 50 to 100 ohms should be connected in series with each plate lead in order that each tube will carry an equal share of the load. The value of the resistor to be used will depend on the amount of plate current that passes through the rectifier. Low plate current requires a high value; high plate current, a low value. When the plates of mercury-vapor rectifier tubes are connected in parallel, the corresponding filament leads should be similarly connected. Otherwise, the tube drops will be considerably unbalanced and larger stabilizing resistors will be required.

Two or more vacuum rectifier tubes can also be connected in parallel to give correspondingly higher output current and, as a result of paralleling their internal resistances, give somewhat increased voltage output. With vacuum types, stabilizing resistors may or may not be necessary depending on the tube type and the circuit.

A voltage-doubler circuit of simple form is shown in Fig. 46. The circuit derives its name from the fact that its dc voltage output can be as high as twice the peak value of ac input. Basically, a voltage doubler is a rectifier circuit arranged so that the output voltages of two half-wave rectifiers are in series.

The action of a voltage doubler can be described briefly as follows. On the positive half-cycle of the ac input, that is, when the upper side of the ac input line is positive with respect to the lower side, the upper diode passes current and feeds a positive charge into the upper capacitor. As positive charge accumulates on the upper plate of the capacitor,

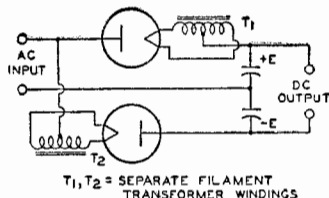

T<sub>1</sub>, T<sub>2</sub> = SEPARATE FILAMENT TRANSFORMER WINDINGS

Fig. 46

a positive voltage builds up across the capacitor. On the next half-cycle of the ac input, when the upper side of the line is negative with respect to the lower



side, the lower diode passes current so that a negative voltage builds up across the lower capacitor.

So long as no current is drawn at the output terminals from the capacitor, each capacitor can charge up to a voltage of magnitude  $E$ , the peak value of

because of the high ac potential between the heaters and cathodes of the tubes.

The half-wave voltage-doubler circuit in Fig. 47 overcomes this difficulty by making one side of the ac line common with the negative side of the dc load circuit. In this circuit, one half of

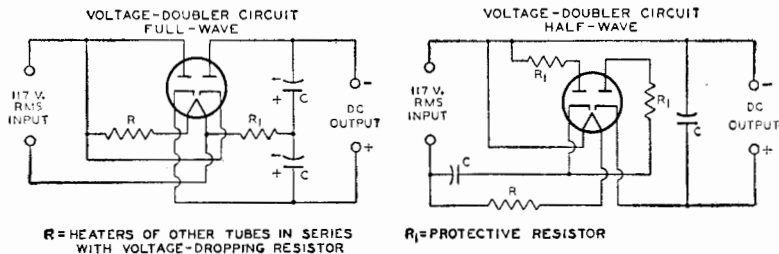

Fig. 47

the ac input. It can be seen from the diagram that with a voltage of  $+E$  on one capacitor and  $-E$  on the other, the total voltage across the capacitors is  $2E$ . Thus the voltage doubler supplies a no-load dc output voltage twice as large as the peak ac input voltage. When current is drawn at the output terminals by the load, the output voltage drops below  $2E$  by an amount that depends on the magnitude of the load current and the capacitance of the capacitors. The arrangement shown in Fig. 46 is called a full-wave voltage doubler because each rectifier passes current to the load on each half of the ac input cycle.

Two rectifier types especially designed for use as voltage doublers are the 25Z6 and 117Z6-GT. These tubes combine two separate diodes in one tube. As voltage doublers, the tubes are used in "transformerless" receivers. In these receivers, the heaters of all tubes in the set are connected in series with a voltage-dropping resistor across the line. The connections for the heater supply and the voltage-doubling circuit are shown in Fig. 47.

With the full-wave voltage-doubler circuit in Fig. 47, it will be noted that the dc load circuit can not be connected to ground or to one side of the ac supply line. This circuit presents certain disadvantages when the heaters of all the tubes in the set are connected in series with a resistance across the ac line. Such a circuit arrangement may cause hum

the tube is used to charge a capacitor which, on the following half cycle, discharges in series with the line voltage through the other half of the tube. This circuit is called a half-wave voltage doubler because rectified current flows to the load only on alternate halves of the ac input cycle. The voltage regulation of this arrangement is somewhat poorer than that of the full-wave voltage doubler.

### Detection

When speech, music, or video information is transmitted from a radio or television station, the station radiates a radio-frequency (rf) wave which is of either of two general types. In one type, the wave is said to be amplitude modulated when its frequency remains constant and the amplitude is varied. In the other type, the wave is said to be frequency modulated when its amplitude remains essentially constant but its frequency is varied.

The function of the receiver is to reproduce the original modulating wave from the modulated rf wave. The receiver stage in which this function is performed is called the demodulator or detector stage.

### AM Detection

The effect of amplitude modulation on the waveform of the rf wave is shown in Fig. 48. There are three different basic circuits used for the detection of amplitude-modulated waves: the di-

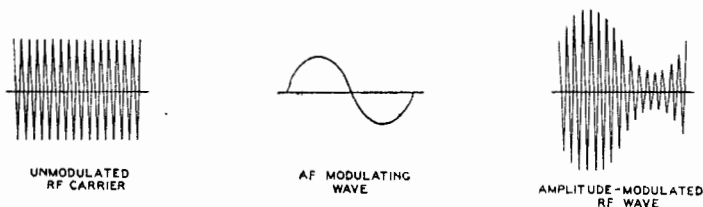

Fig. 48

ode detector, the grid-bias detector, and the grid-resistor detector. These circuits are alike in that they eliminate, either partially or completely, alternate half-cycles of the rf wave. With alternate half-cycles removed, the audio variations of the other half-cycles can be amplified to drive headphones or a loudspeaker.

A diode-detector circuit is shown in Fig. 49. The action of this circuit when a modulated rf wave is applied is illustrated by Fig. 50. The rf voltage applied to the circuit is shown in light line; the output voltage across capacitor C is shown in heavy line.

Between points (a) and (b) on the first positive half-cycle of the applied rf voltage, capacitor C charges up to the peak value of the rf voltage. Then as the applied rf voltage falls away from its peak value, the capacitor holds the cathode at a potential more positive than the voltage applied to the anode. The capacitor thus temporarily cuts off current

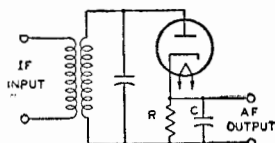

Fig. 49

through the diode. While the diode current is cut off, the capacitor discharges from (b) to (c) through the diode load resistor R.

When the rf voltage on the anode rises high enough to exceed the potential at which the capacitor holds the cathode, current flows again and the capacitor charges up to the peak value of the second positive half-cycle at (d). In this way, the voltage across the capacitor follows the peak value of the applied rf voltage and reproduces the af modulation.

The curve for voltage across the capacitor, as drawn in Fig. 50, is somewhat jagged. However, this jaggedness, which represents an rf component in the voltage across the capacitor, is exaggerated in the drawing. In an actual circuit the rf component of the voltage across the capacitor is negligible. Hence, when the voltage across the capacitor is amplified, the output of the amplifier reproduces the speech or music originating at the transmitting station.

Another way to describe the action of a diode detector is to consider the circuit as a half-wave rectifier. When the

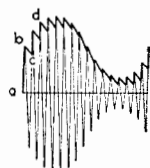

Fig. 50

rf signal on the plate swings positive, the tube conducts and the rectified current flows through the load resistance R. Because the dc output voltage of a rectifier depends on the voltage of the ac input, the dc voltage across C varies in accordance with the amplitude of the rf carrier and thus reproduces the af signal. Capacitor C should be large enough to smooth out rf or if variations but should not be so large as to affect the audio variations. Two diodes can be connected in a circuit similar to a full-wave rectifier to give full-wave detection. However, in practice, the advantages of this connection generally do not justify the extra circuit complication.

The diode method of detection produces less distortion than other methods because the dynamic characteristics of a diode can be made more linear than those of other detectors. The disadvantages of a diode are that it does not

amplify the signal, and that it draws current from the input circuit and therefore reduces the selectivity of the input circuit. However, because the diode method of detection produces less distortion and because it permits the use of simple avc circuits without the necessity for an additional voltage supply, the diode method of detection is most widely used in broadcast receivers.

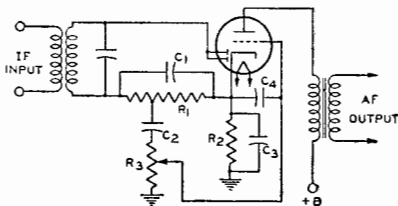

Fig. 51

A typical diode-detector circuit using a twin-diode triode tube is shown in Fig. 51. Both diodes are connected together.  $R_1$  is the diode load resistor. A portion of the af voltage developed across this resistor is applied to the triode grid through the volume control  $R_3$ . In a typical circuit, resistor  $R_1$  may be tapped so that five-sixths of the total af voltage across  $R_1$  is applied to the volume control. This tapped connection reduces the af voltage output of the detector circuit slightly but it reduces audio distortion and improves the rf filtering.

DC bias for the triode section is provided by the cathode-bias resistor  $R_2$  and the audio bypass capacitor  $C_3$ . The function of capacitor  $C_2$  is to block the dc bias of the cathode from the grid. The function of capacitor  $C_4$  is to bypass any rf voltage on the grid to cathode. A twin-diode pentode may also be used in this circuit. With a pentode, the af output should be resistance-coupled rather than transformer-coupled.

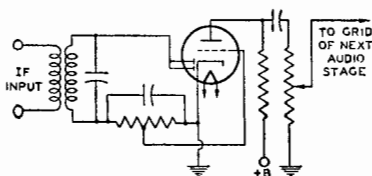

Fig. 52

Another diode-detector circuit, called a diode-biased circuit, is shown in Fig. 52. In this circuit, the triode grid is connected directly to a tap on the diode load resistor. When an rf signal voltage is applied to the diode, the dc voltage at the tap supplies bias to the triode grid. When the rf signal is modulated, the af voltage at the tap is applied to the grid and is amplified by the triode.

The advantage of the circuit shown in Fig. 52 over the self-biased arrangement shown in Fig. 51 is that the diode-biased circuit does not employ a capacitor between the grid and the diode load resistor, and consequently does not produce as much distortion of a signal having a high percentage of modulation.

However, there are restrictions on the use of the diode-biased circuit. Because the bias voltage on the triode depends on the average amplitude of the rf voltage applied to the diode, the average amplitude of the voltage applied to the diode should be constant for all values of signal strength at the antenna. Otherwise there will be different values of bias on the triode grid for different signal strengths and the triode will produce distortion. Because there is no bias applied to the diode-biased triode when no rf voltage is applied to the diode, sufficient resistance should be included in the plate circuit of the triode to limit its zero-bias plate current to a safe value.

These restrictions mean, in practice, that the receiver should have a separate-channel automatic-volume-control (avc) system. With such an avc system, the average amplitude of the signal voltage applied to the diode can be held within very close limits for all values of signal strength at the antenna.

The tube used in a diode-biased circuit should be one which operates at a fairly large value of bias voltage. The variations in bias voltage are then a small percentage of the total bias and hence produce small distortion. Tubes taking a fairly large bias voltage are types such as the 6BF6 or 6SR7 having a medium- $\mu$  triode. Tube types having a high- $\mu$  triode or a pentode should not be used in a diode-biased circuit.

A grid-bias detector circuit is shown in Fig. 53. In this circuit, the grid is biased almost to cutoff, *i.e.*, operated

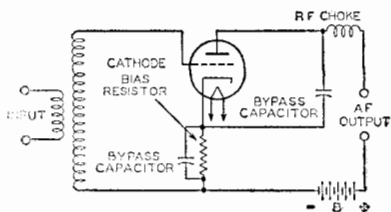

Fig. 53

so that the plate current with zero signal is practically zero. The bias voltage can be obtained from a cathode-bias resistor, a C-battery, or a bleeder tap. Because of the high negative bias, only the positive half-cycles of the rf signal are amplified by the tube. The signal is, therefore, detected in the plate circuit. The advantages of this method of detection are that it amplifies the signal, besides detecting it, and that it does not draw current from the input circuit and therefore does not lower the selectivity of the input circuit.

The **grid-resistor-and-capacitor method**, illustrated by Fig. 54, is somewhat more sensitive than the grid-bias method and gives its best results on weak signals. In this circuit, there is no negative dc bias voltage applied to the grid. Hence, on the positive half-cycles of the rf signal, current flows from grid to cathode. The grid and cathode thus act as a diode detector, with the grid resistor as the diode load resistor and the grid capacitor as the rf bypass capacitor. The voltage across the capacitor then reproduces the af modulation in the same manner as has been explained for the diode detector. This voltage appears between the grid and cathode and is therefore amplified in the plate circuit.

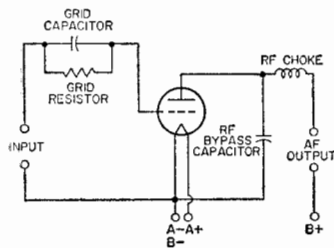

Fig. 54

The output voltage thus reproduces the original af signal.

In this detector circuit, the use of a

high-resistance grid resistor increases selectivity and sensitivity. However, improved af response and stability are obtained with lower values of grid-circuit resistance. This detector circuit amplifies the signal, but draws current from the input circuit and therefore lowers the selectivity of the input circuit.

### FM Detection

The effect of frequency modulation on the waveform of the rf wave is shown in Fig. 55. In this type of transmission,

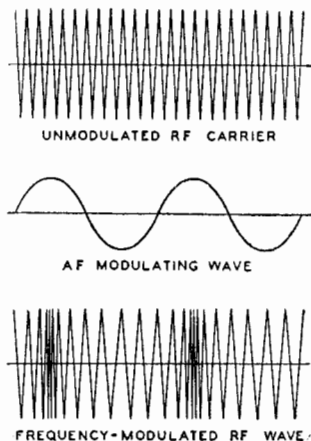

Fig. 55

the frequency of the rf wave deviates from a mean value, at an af rate depending on the modulation, by an amount that is determined in the transmitter and is proportional to the amplitude of the af modulation signal.

For this type of modulation, a detector is required to discriminate between deviations above and below the mean frequency and to translate those deviations into a voltage whose amplitude varies at audio frequencies. Since the deviations occur at an audio frequency, the process is one of demodulation, and the degree of frequency deviation determines the amplitude of the demodulated (af) voltage.

A simple circuit for converting frequency variations to amplitude variations is a circuit which is tuned so that the mean radio frequency is on one slope of its resonance characteristic, as at A of Fig. 56. With modulation, the frequency swings between B and C, and

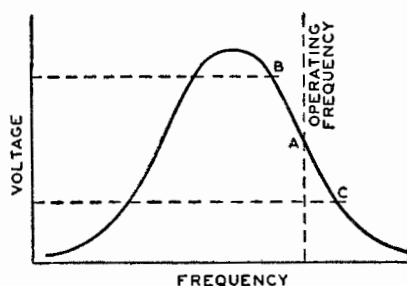

Fig. 56

the voltage developed across the circuit varies at the modulating rate. In order that no distortion will be introduced in this circuit, the frequency swing must be restricted to the portion of the slope which is effectively straight. Since this portion is very short, the voltage developed is low. Because of these limitations, this circuit is not commonly used but it serves to illustrate the principle.

The faults of the simple circuit are overcome in a push-pull arrangement, sometimes called a **discriminator circuit**, such as that shown in Fig. 57. Be-

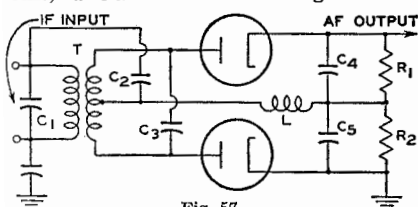

Fig. 57

cause of the phase relationships between the primary and each half of the secondary of the input transformer (each half of the secondary is connected in series with the primary through capacitor  $C_2$ ), the rf voltages applied to the diodes become unequal as the rf signal swings from the resonant frequency in each direction.

Since the swing occurs at audio

frequencies (determined by the af modulation), the voltage developed across the diode load resistors,  $R_1$  and  $R_2$  connected in series, varies at audio frequencies. The output voltage depends on the difference in amplitude of the voltages developed across  $R_1$  and  $R_2$ . These voltages are equal and of opposite sign when the rf carrier is not modulated and the output is, therefore, zero. When modulation is applied, the output voltage varies as indicated in Fig. 58.

Because this type of FM detector is sensitive to amplitude variations in the

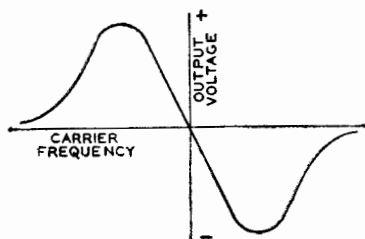

Fig. 58

rf carrier, a limiter stage is frequently used to remove most of the amplitude modulation from the carrier. (See *Limiters under Amplification*.)

Another form of detector for frequency-modulated waves is called a **ratio detector**. This FM detector, unlike the previous one which responds to a difference in voltage, responds only to changes in the ratio of the voltage across two diodes and is, therefore, insensitive to changes in the differences in the voltages due to amplitude modulation of the rf carrier.

The basic ratio detector is given in Fig. 59. The plate load for the final af amplifier stage is the parallel resonant circuit consisting of  $C_1$  and the primary transformer  $T$ . The tuning and coupling of the transformer is practically the

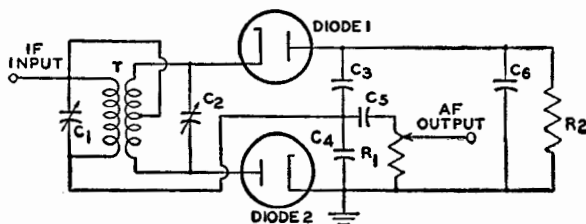

Fig. 59

same as in the previous circuit and therefore, the rf voltages applied to the diodes depend upon how much the rf signal swings from the resonant frequency in each direction. At this point the similarity ends.

Diode 1,  $R_2$ , and diode 2 complete a series circuit fed by the secondary of the transformer T. The two diodes are connected in series so that they conduct on the same rf half-cycle. The rectified current through  $R_2$  causes a negative voltage to appear at the plate of diode 1. Because  $C_5$  is large, this negative voltage at the plate of diode 1 remains constant even at the lowest audio frequencies to be reproduced.

The rectified voltage across  $C_3$  is proportional to the voltage across diode 1, and the rectified voltage across  $C_4$  is proportional to the voltage across diode 2. Since the voltages across the two diodes differ according to the instantaneous frequency of the carrier, the voltages across  $C_3$  and  $C_4$  differ proportionately, the voltage across  $C_3$  being the larger of the two voltages at carrier frequencies below the intermediate frequency and the smaller at frequencies above the intermediate frequency.

These voltages across  $C_3$  and  $C_4$  are additive and their sum is fixed by the constant voltage across  $C_6$ . Therefore, while the ratio of these voltages varies at an audio rate, their sum is always constant. The voltage across  $C_4$  varies at an audio rate when a frequency-modulated rf carrier is applied to the ratio detector; this audio voltage is extracted and fed to the audio amplifier. For a complete circuit utilizing this type of detector, refer to the **CIRCUIT SECTION**.

### Automatic Volume or Gain Control

The chief purposes of automatic volume control (**avc**) or automatic gain control (**agc**) in a radio or television receiver are to prevent fluctuations in loudspeaker volume or picture brightness when the audio or video signal at the antenna is fading in and out.

An **automatic volume control** circuit regulates the receiver rf and if gain so that this gain is less for a strong signal than for a weak signal. In this way, when the signal strength at the antenna

changes, the avc circuit reduces the resultant change in the voltage output of the last if stage and consequently reduces the change in the speaker output volume.

The avc circuit reduces the rf and if gain for a strong signal usually by increasing the negative bias of the rf, if, and frequency-mixer stages when the signal increases. A simple avc circuit is shown in Fig. 60. On each positive half-cycle of the signal voltage, when the diode plate is positive with respect to the cathode, the diode passes current.

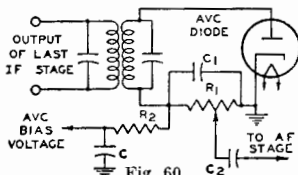

Because of the flow of diode current through  $R_1$ , there is a voltage drop across  $R_1$  which makes the left end of  $R_1$  negative with respect to ground. This voltage drop across  $R_1$  is applied, through the filter  $R_2$  and  $C$ , as negative bias on the grids of the preceding stages. When the signal strength at the antenna increases, therefore, the signal applied to the avc diode increases, the voltage drop across  $R_1$  increases, the negative bias voltage applied to the rf and if stages increases, and the gain of the rf and if stages is decreased. Thus the increase in signal strength at the antenna does not produce as much increase in the output of the last if stage as it would produce without avc.

When the signal strength at the antenna decreases from a previous steady value, the avc circuit acts, of course, in the reverse direction, applying less negative bias, permitting the rf and if gain to increase, and thus reducing the decrease in the signal output of the last if stage. In this way, when the signal strength at the antenna changes, the avc circuit acts to reduce change in the output of the last if stage, and thus acts to reduce change in loudspeaker volume.

The filter,  $C$  and  $R_2$ , prevents the avc voltage from varying at audio frequency. The filter is necessary because the voltage drop across  $R_1$  varies with the modulation of the carrier being re-



peak value of the incoming signal.

The diode detector receives the incoming signal from the last if stage of the television receiver through the capacitor  $C_1$ . The resistor  $R_1$  provides the

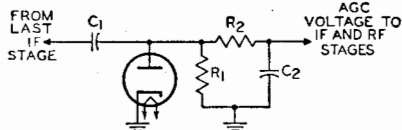

Fig. 62

load for the diode. The diode conducts only when its plate is driven positive with respect to its cathode. Electrons then flow from the cathode to the plate and thence into capacitor  $C_1$ , where the negative charge is stored. Because of the low impedance offered by the diode during conduction,  $C_1$  charges up to the value of the peak applied voltage.

During the negative excursion of the signal, the diode does not conduct, and  $C_1$  discharges through resistor  $R_1$ . Because of the large time constant of  $R_1C_1$ , however, only a small percentage of the voltage across  $C_1$  is lost during the interval between horizontal sync pulses. During succeeding positive cycles, the incoming signal must overcome the negative charge stored in  $C_1$  before the diode conducts, and plate current flows only at the peak of each positive cycle. The voltage across  $C_1$ , therefore, is determined by the level of the peaks of the positive cycles, or the sync pulses.

The negative voltage developed across resistor  $R_1$  by the sync pulses is filtered by resistor  $R_2$  and capacitor  $C_2$  to remove the 15,750-cycle ripple of the horizontal sync pulse. The dc output is then fed to the if and rf amplifiers as an agc voltage.

This agc system may be expanded to include amplification of the agc signal before detection of the peak level, or amplification of the dc output, or both. A direct-coupled amplifier must be used for amplification of the dc signal. The addition of amplification makes the system more sensitive to changes in carrier level.

A "keyed" agc system such as that shown in Fig. 63 is used to eliminate flutter and to improve noise immunity in weak signal areas. This system provides more rapid action than the conventional

agc circuits because the filter circuit can employ lower capacitance and resistance values.

In the keyed agc system, the negative output of the video detector is fed directly to the grid No.1 of the first video amplifier. The positive output of the video amplifier is, in turn, fed directly to the grid No.1 of the keyed agc amplifier. The video stage increases the gain of the agc system and, in addition, provides noise clipping. The plate voltage for the agc amplifier is a positive pulse obtained from a small winding on the horizontal output transformer which is in phase with the horizontal sync pulse obtained from the video amplifier. The polarity of this pulse is such that the plate of the agc amplifier tube is positive during the retrace time. The tube is

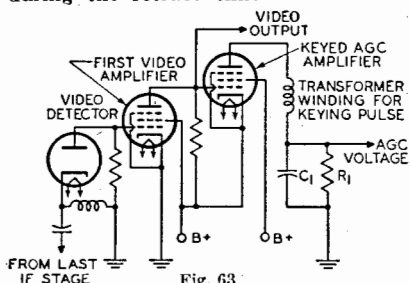

Fig. 63

biased so that current flows only when the grid No.1 and the plate are driven positive simultaneously. The amount of current flow depends on the grid-No.1 potential during the pulse. These pulses are smoothed out in the RC network in the plate circuit ( $R_1C_1$ ). Because the dc voltage developed across  $R_1$  is negative, it is suitable for application to the grids of the rf and if tubes as an agc voltage.

### Tuning Indication With Electron-Ray Tubes

Electron-ray tubes are designed to indicate visually by means of a fluorescent target the effects of a change in controlling voltage. One application of them is as tuning indicators in radio receivers. Types such as the 6U5, 6E5, and the 6AB5/6N5 contain two main parts: (1) a triode which operates as a dc amplifier and (2) an electron-ray indicator which is located in the bulb as shown in Fig. 64. The target is operated at a positive voltage and, therefore, attracts electrons from the cathode. When



the electrons strike the target they produce a glow on the fluorescent coating of the target. Under these conditions, the target appears as a ring of light.

A ray-control electrode is mounted between the cathode and target. When the potential of this electrode is less positive than the target, electrons flowing to the target are repelled by the electrostatic field of the electrode, and do not

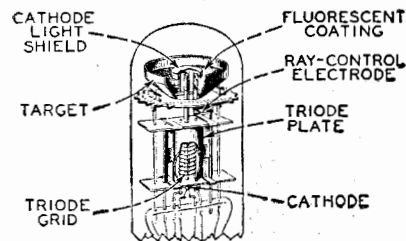

Fig. 64

reach that portion of the target behind the electrode. Because the target does not glow where it is shielded from electrons, the control electrode casts a shadow on the glowing target. The extent of this shadow varies from approximately 100° of the target when the control electrode is much more negative than the target to 0° when the control electrode is at approximately the same potential as the target.

In the application of the electron-ray tube, the potential of the control electrode is determined by the voltage on the grid of the triode section, as can be seen in Fig. 65. The flow of the triode plate current through resistor R produces

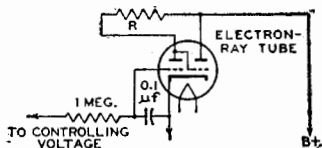
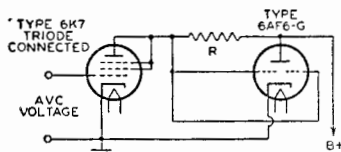

Fig. 65

a voltage drop which determines the potential of the control electrode. When the voltage of the triode grid changes in the positive direction, plate current increases, the potential of the control electrode goes down because of the increased drop across R, and the shadow angle widens. When the potential of the triode grid changes in the negative direction, the shadow angle narrows.

Another type of indicator tube is

the 6AF6-G. This tube contains only an indicator unit but employs two ray-control electrodes mounted on opposite sides of the cathode and connected to individual base pins. It employs an external dc amplifier. (See Fig. 66.) Thus, two symmetrically opposite shadow angles



R: TYPICAL VALUE IS 0.5 MEGOHM  
Fig. 66

may be obtained by connecting the two ray-control electrodes together; or, two unlike patterns may be obtained by individual connection of each ray-control electrode to its respective amplifier.

In radio receivers, avc voltage is applied to the grid of the dc amplifier. Because avc voltage is at maximum when the set is tuned to give maximum response to a station, the shadow angle is at minimum when the receiver is tuned to resonance with the desired station.

The choice between electron-ray tubes depends on the avc characteristic of the receiver. The 6E5 contains a sharp-cutoff triode which closes the shadow angle on a comparatively low value of avc voltage. The 6AB5/6N5 and 6U5 each have a remote-cutoff triode which closes the shadow on a larger value of avc voltage than the 6E5. The 6AF6-G may be used in conjunction with dc amplifier tubes having either remote- or sharp-cutoff characteristics.

### Oscillation

As an oscillator, an electron tube can be employed to generate a continuously alternating voltage. In present-day radio broadcast receivers, this application is limited practically to super-

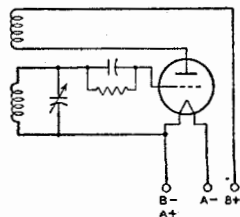

Fig. 67

heterodyne receivers for supplying the heterodyning frequency. Several circuits (represented in Figs. 67 and 68) may be utilized, but they all depend on feeding more energy from the plate circuit to the grid circuit than is required to equal the power loss in the grid circuit. Feedback may be produced by electrostatic or

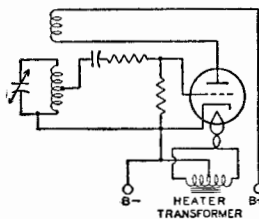

Fig. 68

electromagnetic coupling between the grid and plate circuits. When sufficient energy is fed back to more than compensate for the loss in the grid circuit, the tube will oscillate. The action consists of regular surges of power between the plate and the grid circuit at a frequency dependent on the circuit constants of inductance and capacitance. By proper choice of these values, the frequency may be adjusted over a very wide range.

### Multivibrators

Relaxation oscillators, which are widely used in present-day electronic equipment, are used to produce non-sinusoidal waveshapes such as rectangular and sawtooth pulses. Probably the most common relaxation oscillator is the multivibrator, which may be considered as a two-stage resistance-coupled amplifier in which the output of each tube is coupled into the input of the other tube.

Fig. 69 is a basic multivibrator circuit of the free-running type. In this circuit, oscillations are maintained by the

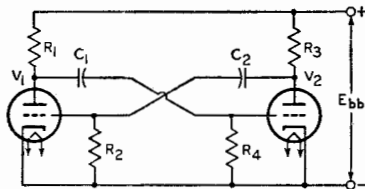

Fig. 69

alternate shifting of conduction from one tube to the other. The cycle usually starts with one tube,  $V_1$ , at zero bias, and the other,  $V_2$ , at cutoff or beyond.

At this point, the capacitor  $C_1$  is charged sufficiently to cut off  $V_2$ .  $C_1$  then begins to discharge through the resistor  $R_4$ , and the voltage on the grid of  $V_2$  rises until  $V_2$  begins to conduct. The voltage on the plate of  $V_2$  then decreases, causing  $V_1$  to conduct less and less. At the same time, the plate voltage of  $V_1$  begins to rise, causing  $V_2$  to conduct still more heavily. Because of the amplification, this cumulative effect builds up extremely fast, and conduction switches from  $V_1$  to  $V_2$  within a few microseconds, depending on the circuit components.

In this circuit, therefore, conduction switches from  $V_1$  to  $V_2$  over the interval during which  $C_1$  discharges from the voltage across  $R_4$  to the cutoff voltage for  $V_2$ . The actual transfer of conduction does not occur until cutoff is reached. Conduction switches back to  $V_1$  through a similar process to complete the cycle. The plate waveform is essentially rectangular in shape, and may be adjusted as to symmetry, frequency, and amplitude by proper choice of circuit constants, tubes, and voltages.

Although this type of multivibrator is free-running, it may be triggered by pulses of a given amplitude and frequency to provide a frequency-stabilized output. Multivibrator circuits may also be designed so that they are not free-running, but must be triggered externally to shift conduction from one tube to the other. Depending on the type of circuit, conduction may shift back to the first tube after a given time interval, or the second tube may continue conducting until another trigger signal is applied.

### Synchroguide Circuits

The "synchroguide" is a controlled type of oscillator used in television receivers to generate and control the synchronized sawtooth voltage necessary for adequate line- or horizontal-frequency scanning. A simplified synchroguide circuit is shown in Fig. 70. This circuit provides stable, noise-free control of a blocking oscillator which generates a horizontal-frequency signal. It permits comparison of the received sync pulses and the generated sawtooth voltages so that properly locked-in horizontal scanning results.

The triode  $V_2$  in Fig. 70 is a conven-

tional blocking oscillator which enables a sawtooth voltage to be developed

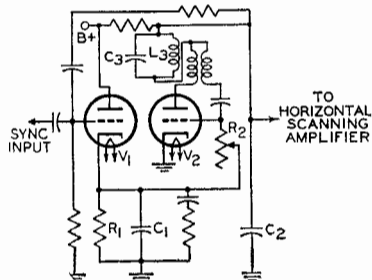

Fig. 70

across the capacitor  $C_2$ . A portion of this sawtooth is fed back to the grid of the control tube,  $V_1$ . The positive sync pulses are also applied to the grid of  $V_1$ . The waveforms shown in Fig. 71 illustrate the sawtooth and sync pulses (A and B) and their proper "in-sync" combination (C). The sync pulse occurs partly during the portion of the sawtooth voltage in which the triode  $V_1$  draws current. Any shift in sync pulse as it is superimposed

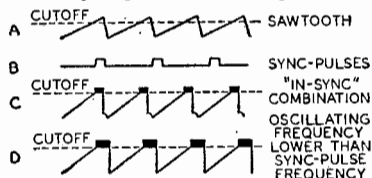

Fig. 71

on the sawtooth, therefore, will affect the amount of conduction of the control tube. A change in control-tube conduction ultimately affects the bias on the oscillator-tube grid by changing the voltage to which the capacitor  $C_1$  in the cathode circuit may charge. An increase in the positive bias increases the frequency of oscillation.

For example, waveform D in Fig. 71 illustrates a condition in which the sawtooth voltage is advanced in phase with respect to the sync-pulses. The widening of the pulse which occurs at the corner of the sawtooth waveform allows the control tube to conduct more current and, consequently, allows the capacitor  $C_1$  to charge to a higher voltage. This increased reference voltage also appears in the grid circuit of  $V_2$  and makes the grid more positive. The increased grid voltage then speeds up the

frequency of oscillations until proper synchronization results.

The blocking oscillator can be made more immune to changes in frequency and noise if  $V_2$  is brought out of cutoff very sharply. This effect is obtained by sine-wave stabilization. The tuned circuit  $L_3-C_3$  in the plate circuit of Fig. 70 superimposes a shock-excited sine wave on the plate and grid waveforms, as shown in Fig. 72.

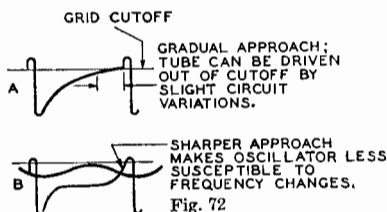

Fig. 72

### Deflection Circuits

#### Vertical Output Circuits

A modified multivibrator in which the vertical output tube is part of the oscillator circuit is used in the vertical deflection stage of many television receivers. This stage supplies the deflection energy required for vertical deflection of the picture-tube beam. A simplified combined vertical-oscillator-output stage is shown in Fig. 73. Waveforms at critical points of the circuit are included to illustrate the development of the desired current through the vertical output transformer and deflecting yoke.

The current waveform through the deflecting yoke and output transformer should be a sawtooth to provide the desired deflection. The grid and plate voltage waveforms of the output tube could also be sawtooth except for the effect of the inductive components in the yoke and transformer. The effect of these inductive components must be taken into consideration, however, particularly during retrace. The fast rate of current change during retrace time (which is approximately 1/15 as long as trace time) causes a high-voltage pulse at the plate which could give a trapezoidal waveshape to the plate voltage and cause increased plate current, excess damping, and lengthened retrace time. However, the grid voltage is made sufficiently negative during retrace to keep

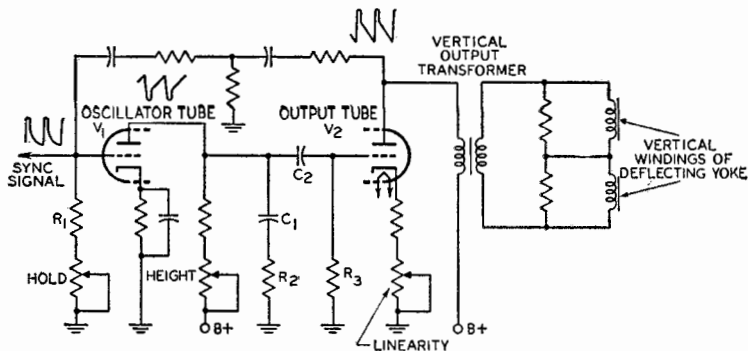

Fig. 73

the tube close to cutoff, as described below.

The frequency, and the relative deviation of the positive and negative portions of each cycle, are dependent on the values of resistors  $R_1$  and  $R_3$  and the RC combination  $R_2C_2$ , as explained previously in the section on multivibrators. The desired trapezoidal waveshape at the grid of  $V_2$  is created by capacitor  $C_1$  and resistor  $R_2$ . If  $R_2$  were equal to zero,  $C_1$  would cause the grid-voltage waveshape to take the form shown in Fig. 74(a). When  $R_2$  is sufficiently large,  $C_1$



Fig. 74

does not discharge completely when  $V_1$  conducts. When  $V_1$  is cut off, therefore, the voltage on the grid of  $V_2$  immediately rises to the voltage across  $C_1$ . The resulting waveshape is shown in Fig. 74(b). The negative-going pulse of the grid-voltage waveshape prevents the high plate pulse from causing excess conduction, and thereby prevents overdamping.

This vertical deflection stage utilizes twin-triode tubes such as the 6DR7 and 6EM7. The 6EM7 is particularly suitable for this application because it incorporates dissimilar units to provide for the different operating requirements of the oscillator and output sections.

**Horizontal Output Circuits**

Fig. 75 shows a typical horizontal-output-and-deflection circuit used in television receivers. In addition to supplying the deflection energy required for horizontal deflection of the picture-tube beam, this circuit provides the high dc

voltage required for the ultor of the picture tube and the "boosted" B voltage for other portions of the receiver. The horizontal-output tube is usually a beam power tube such as the 6DQ6-B, 6CD6-GA, or 6GW6.

In this circuit, a sawtooth voltage from the horizontal-oscillator tube is applied to the grid No.1 of the horizontal-output tube. When this voltage rises above the cutoff point of the output tube, the tube conducts a sawtooth of plate current which is fed through the autotransformer to the horizontal-deflecting yoke. At the end of the horizontal-scanning cycle, which lasts for 63.4 microseconds, the sawtooth voltage on the grid suddenly cuts off the output tube. This sudden change sets up an oscillation of about 50 to 70 Kc in the output circuit, which may be considered as an inductor shunted by the stray capacitance of the circuit. During the first half of this oscillation, a positive voltage appears across the transformer. In the sec-

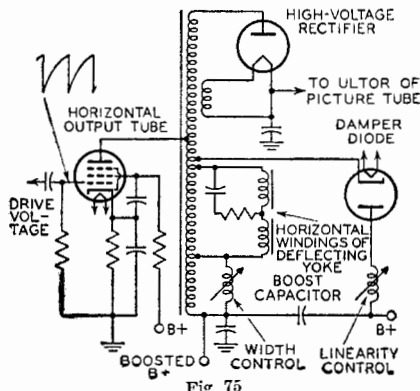

Fig 75

ond half of the cycle, the voltage swings below the plate supply voltage, and the damper diode conducts, damping out the oscillation. At the same time, the current through the deflecting yoke reverses and reaches its negative peak. As the damper-diode current decays exponentially to zero, the output tube begins to conduct again. The yoke current, therefore, is composed of current resulting from damper-diode conduction followed by output-tube conduction.

When the output tube is suddenly cut off, the high-voltage pulse produced by shock excitation of the load circuit is increased by means of an extra winding on the transformer. This high-voltage pulse charges a high-voltage capacitor through the high-voltage rectifier. The output of this circuit is the dc high-voltage supply for the picture tube. The high-voltage rectifier also obtains its filament power through a separate winding on the horizontal-output transformer.

Current flowing through the damper diode charges the "boost" capacitor through the damper portion of the transformer winding. The polarity of the charge on the capacitor is such that the voltage at the low end of the winding is increased above the plate supply voltage, or B+. This higher voltage or "boost" is used for the output-tube plate supply, and may also supply the deflection oscillators and the vertical-output circuit provided the current drain is not excessive.

### High-Voltage Regulator Circuit

In color-television receivers, it is very important to regulate the high-voltage supply to the picture tube. A suitable circuit using the 6BK4 for regulation of the output of a high-voltage, high-impedance supply is shown in Fig. 76. In this circuit, the cathode is held at a fixed positive potential with respect to ground. Because the grid potential is kept slightly less positive by the voltage drop across resistor  $R_2$ , the tube operates in the negative grid region and no grid current is drawn.

When the output voltage,  $e_o$ , rises as a result of a decrease in load current, a small fraction of the additional voltage is applied to the grid of the tube by the voltage-divider circuit consisting of

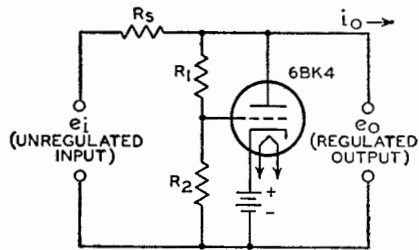

Fig. 76

$R_1$  and  $R_2$ . This increased grid voltage causes the tube to draw an increased current from the unregulated supply. The increased current, in turn, causes a voltage drop across the high internal impedance of the unregulated supply,  $R_s$ , which tends to counteract the original rise of the voltage. If desired, the grid may be connected to a variable point on the voltage divider to allow some adjustment of the output-voltage level.

The circuit shown in Fig. 76 compensates for both load-current and line-voltage variations. The output of a regulated 25,000-volt supply using this circuit does not drop more than 500 volts as the load current increases from 0 to 1 milliamperes. Variations in output voltage may be kept within  $\pm 1$  per cent for input-voltage changes of  $\pm 10$  per cent. If desired, the compensation for input-voltage changes may be eliminated while compensation for load-current changes is maintained.

### Frequency Conversion

Frequency conversion is used in superheterodyne receivers to change the frequency of the rf signal to an intermediate frequency. To perform this change in frequency, a frequency-converting device consisting of an oscillator and a frequency mixer is employed. In such a device, shown diagrammatically in Fig. 77, two voltages of different frequency, the rf signal voltage and the voltage generated by the oscillator, are

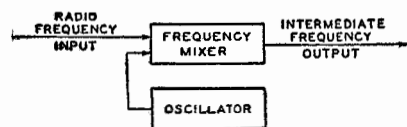

FREQUENCY CONVERTER

Fig. 77

applied to the input of the frequency mixer. These voltages beat, or heterodyne, within the mixer tube to produce a plate current having, in addition to the frequencies of the input voltages, numerous sum and difference frequencies.

The output circuit of the mixer stage is provided with a tuned circuit which is adjusted to select only one beat frequency, *i.e.*, the frequency equal to the difference between the signal frequency and the oscillator frequency. The selected output frequency is known as the intermediate frequency, or *if*. The output frequency of the mixer tube is kept constant for all values of signal frequency by tuning the oscillator to the proper frequency.

Important advantages gained in a receiver by the conversion of signal frequency to a fixed intermediate frequency are high selectivity with few tuning stages and a high, as well as stable, overall gain for the receiver.

Several methods of frequency conversion for superheterodyne receivers are of interest. These methods are alike in that they employ a frequency-mixer tube in which plate current is varied at a combination frequency of the signal frequency and the oscillator frequency. These variations in plate current produce across the tuned plate load a voltage of the desired intermediate frequency. The methods differ in the types of tubes employed and in the means of supply input voltages to the mixer tube.

A method widely used before the availability of tubes especially designed for frequency-conversion service and currently used in many FM, television, and standard broadcast receivers, employs as mixer tube either a triode, a tetrode, or a pentode, in which oscillator voltage and signal voltage are applied to the same grid. In this method, coupling between the oscillator and mixer circuits is obtained by means of inductance or capacitance.

A second method employs a tube having an oscillator and frequency mixer combined in the same envelope. In one form of such a tube, coupling between the two units is obtained by means of the electron stream within the tube. Because five grids are used, the tube is called a pentagrid converter.

Grids No. 1 and No. 2 and the cathode are connected to an external circuit to act as a triode oscillator. Grid No. 1 is the grid of the oscillator and grid No. 2 is the anode. These and the cathode can be considered as a composite cathode which supplies to the rest of the tube an electron stream that varies at the oscillator frequency.

This varying electron stream is further controlled by the *rf* signal voltage on grid No. 4. Thus, the variations in plate current are due to the combination of the oscillator and the signal frequencies. The purpose of grids No. 3 and No. 5, which are connected together within the tube, is to accelerate the electron stream and to shield grid No. 4 electrostatically from the other electrodes.

Pentagrid-converter tubes of this design are good frequency-converting devices at medium frequencies. However, their performance is better at the lower frequencies because the output of the oscillator drops off as the frequency is raised and because certain undesirable effects produced by interaction between oscillator and signal sections of the tube increase with frequency.

To minimize these effects, several of the pentagrid-converter tubes are designed so that no electrode functions alone as the oscillator anode. In these tubes, grid No. 1 functions as the oscillator grid, and grid No. 2 is connected within the tube to the screen grid (grid No. 4). The combined two grids, Nos. 2 and 4, shield the signal grid (grid No. 3) and act as the composite anode of the oscillator triode. Grid No. 5 acts as the suppressor grid.

Converter tubes of this type are designed so that the space charge around the cathode is unaffected by electrons from the signal grid. Furthermore, the electrostatic field of the signal grid also has little effect on the space charge. The result is that *rf* voltage on the signal grid produces little effect on the cathode current. There is, therefore, little detuning of the oscillator by *avc* bias because changes in *avc* bias produce little change in oscillator transconductance or in the input capacitance of grid No. 1.

Examples of the pentagrid converters discussed in the preceding paragraph are the single-ended types 1R5 and

6BE6. A schematic diagram illustrating the use of the 6BE6 with self-excitation is given in Fig. 78; the 6BE6 may also

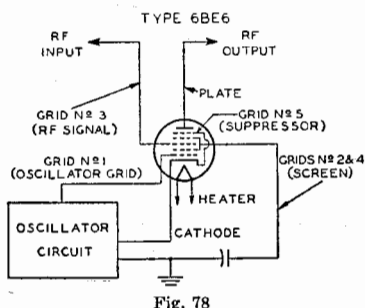

Fig. 78

be used with separate excitation. A complete circuit is shown in the **CIRCUIT SECTION**.

Another method of frequency conversion utilizes a separate oscillator having its grid connected to the No. 1 grid of a mixer hexode. The cathode, triode grid, and triode plate form the oscillator unit of the tube. The cathode, hexode mixer grid (grid No. 1), hexodescreen grids (grids Nos. 2 and 4), hexode signal grid (grid No. 3), and hexode plate constitute the mixer unit. The internal shields are connected to the shell of the tube and act as a suppressor grid for the hexode unit.

The action of this tube in converting a radio-frequency signal to an intermediate frequency depends on (1) the generation of a local frequency by the triode unit, (2) the transferring of this frequency to the hexode grid No. 1, and (3) the mixing in the hexode unit of this frequency with that of the rf signal applied to the hexode grid No. 3. The tube is not critical to changes in oscillator-plate voltage or signal-grid bias and, therefore, finds important use in all-wave receivers to minimize frequency-shift effects at the higher frequencies.

A further method of frequency conversion employs a tube called a pentagrid mixer. This type has two independent control grids and is used with a separate oscillator tube. RF signal voltage is applied to one of the control grids and oscillator voltage is applied to the other. It follows, therefore, that the variations in plate current are due to the combination of the oscillator and signal frequencies.

The tube contains a heater-cathode, five grids, and a plate. Grids Nos. 1 and 3 are control grids. The rf signal voltage is applied to grid No. 1. This grid has a remote-cutoff characteristic and is suited for control by a bias voltage. The oscillator voltage is applied to grid No. 3. This grid has a sharp-cutoff characteristic and produces a comparatively large effect on plate current for a small amount of oscillator voltage. Grids Nos. 2 and 4 are connected together within the tube. They accelerate the electron stream and shield grid No. 3 electrostatically from the other electrodes. Grid No. 5, connected within the tube to the cathode, functions similarly to the suppressor grid in a pentode.

In the converter or mixer stage of a television receiver, stable oscillator operation is most readily obtained when separate tubes or tube sections are used for the oscillator and mixer functions. A typical television mixer-oscillator circuit is shown in Fig. 79. In such circuits, the oscillator voltage is applied to the mixer grid by inductive coupling, capacitive coupling, or a combination of the two.

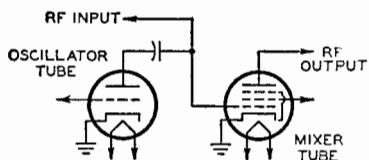

Fig. 79

Tubes containing electrically independent oscillator and mixer units in the same envelope, such as the 6U8-A and 6X8, are designed especially for this application.

### Automatic Frequency Control

An automatic frequency control (afc) circuit provides a means of correcting automatically the intermediate frequency of a superheterodyne receiver when, for any reason, it drifts from the frequency to which the if stages are tuned. This correction is made by adjusting the frequency of the oscillator. Such a circuit will automatically compensate for slight changes in rf carrier or oscillator frequency as well as for inaccurate manual or push-button tuning.

An afc system requires two sections: a frequency detector and a variable re-

actance. The detector section may be essentially the same as the FM detector illustrated in Fig. 57 and discussed under *Detection*. In the afc system, however, the output is a dc control voltage, the magnitude of which is proportional to the amount of frequency shift. This dc control voltage is used to control the grid bias of an electron tube which comprises the variable reactance section (Fig. 80).

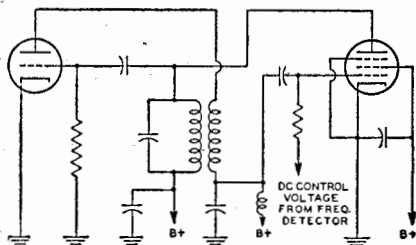

Fig. 80

The plate current of the reactance tube is shunted across the oscillator tank circuit. Because the plate current and plate voltage of the reactance tube are almost  $90^\circ$  out of phase, the control tube affects the tank circuit in the same manner as a reactance. The grid bias of the tube determines the magnitude of the effective reactance and, consequently, a control of this grid bias can be used to control the oscillator frequency.

Automatic frequency control is also used in television receivers to keep the horizontal oscillator in step with the horizontal-scanning frequency (15,750 cps) at the transmitter. A widely used horizontal afc circuit is shown in Fig. 81. This circuit, which is often referred to as a **balanced-phase-detector** or **phase-discriminator** circuit, is usually employed to control the frequency of a multivibrator-type horizontal-oscillator circuit. The 6AL5 detector supplies a dc control voltage to the grid of the horizontal-oscillator tube which counteracts changes in its operating frequency. The magnitude and polarity of the control voltages are determined by phase relationships in the afc circuit at a given moment.

The horizontal sync pulses obtained from the sync-separator circuit are fed

through a single-triode phase-inverter or phase-splitter circuit to the two diode units of the 6AL5. Because of the action of the phase-inverter circuit, the signals applied to the two diode units are equal in amplitude but  $180^\circ$  out of phase. A reference sawtooth voltage obtained from the horizontal output circuit is also applied simultaneously to both units. Any change in the oscillator frequency alters the phase relationship between the reference sawtooth and the incoming horizontal sync pulses, causing one diode unit of the 6AL5 to conduct more heavily than the other, and thus producing a correction signal. The system remains balanced at all times, therefore, because momentary changes in oscillator frequency are instantaneously corrected by the action of the control voltage.

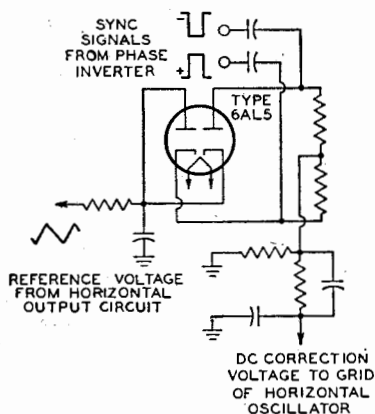

Fig. 81

The diode units of the 6AL5 are biased so that conduction takes place only during the tips of the sync pulses. The relative position of the sync pulses on the retrace portion of the sawtooth waveform at any given instant determines which diode unit conducts more heavily, and thereby establishes the magnitude and polarity of the control voltage. The network between the diode units and the grid of the horizontal-oscillator tube is essentially a low-pass filter which prevents the horizontal sync pulses from affecting the horizontal-oscillator performance.



# Electron Tube Installation

The installation of electron tubes requires care if high-quality performance is to be obtained from the associated circuits. Installation suggestions and precautions which are generally common to all types of tubes are covered in this section. Careful observance of these suggestions will do much to help the experimenter and electronic technician obtain the full performance capabilities of radio tubes and circuits. Additional pertinent information is given under each tube type and in the CIRCUIT SECTION.

## Filament and Heater Power Supply

The design of electron tubes allows for some variation in the voltage and current supplied to the filament or heater, but most satisfactory results are obtained from operation at the rated values. When the voltage is low, the temperature of the cathode is below normal, with the result that electron emission is limited. The limited emission may cause unsatisfactory operation and reduced tube life. On the other hand, high cathode voltage may cause rapid evaporation of cathode material and shorten tube life.

To insure proper tube operation, it is important that the filament or heater voltage be checked at the socket terminals by means of a high-resistance voltmeter while the equipment is in operation. In the case of series operation of heaters or filaments, correct adjustment can be checked by means of an ammeter in the heater or filament circuit.

The filament or heater voltage supply may be a direct-current source (a battery or a dc power line) or an alternating-current power line, depending on the type of service and type of tube. Frequently, a resistor (either variable or fixed) is used with a dc supply to permit compensation for battery voltage variations or to adjust the tube voltage at the socket terminals to the correct value. Ordinarily, a step-down transformer is used with an ac supply to provide the proper filament or heater voltage. Receivers intended for operation on both dc and ac power lines have the heaters connected in series with a suit-

able resistor and supplied directly from the power line.

**DC filament or heater operation** should be considered on the basis of the source of power. In the case of the battery supply for the 1.4-volt filament tubes, it is unnecessary to use a voltage-dropping resistor in series with the filament and a single dry-cell; the filaments of these tubes are designed to operate satisfactorily over the range of voltage variations that normally occur during the life of a dry-cell. Likewise, no series resistor is required when the 1.25-volt filament subminiatures are operated from a single 1.5-volt flashlight-type dry-cell, when the 2-volt filament type tubes are operated from a single storage cell, or when the 6.3-volt series are operated from a 6-volt storage battery.

In the case of dry-battery supply for 2-volt filament tubes, a variable resistor in series with the filament and the battery is required to compensate for battery variations. Turning the set on and off by means of the rheostat is advised to prevent over-voltage conditions after an off-period because the voltage of dry-cells rises during off-periods.

In the case of storage-battery supply, air-cell-battery supply, or dc power supply, a non-adjustable resistor of suitable value may be used. It is well to check initial operating conditions, and thus the resistor value, by means of a voltmeter or ammeter.

**AC filament or heater operation** should be considered on the basis of either a parallel or a series arrangement of filaments and/or heaters. In the case of the parallel arrangement, a step-down transformer is employed. Precautions should be taken to see that the line voltage is the same as that for which the primary of the transformer is designed. The line voltage may be determined by measurement with an ac voltmeter (0-150 volts).

If the line voltage measures in excess of that for which the transformer is designed, a resistor should be placed in series with the primary to reduce the line voltage to the rated value of the transformer primary. Unless this is done,

the excess input voltage will cause proportionally excessive voltage to be applied to the tubes. Any electron tube may be damaged or made inoperative by excessive operating voltages.

If the line voltage is consistently below that for which the primary of the transformer is designed, it may be necessary to install a booster transformer between the ac outlet and the transformer primary. Before such a transformer is installed, the ac line fluctuations should be very carefully noted. Some radio sets are equipped with a line-voltage switch which permits adjustment of the power transformer primary to the line voltage. When this switch is properly adjusted, the series-resistor or booster-transformer method of controlling line voltage is seldom required.

In the case of the series arrangements of filaments and/or heaters, a voltage-dropping resistance in series with the heaters and the supply line is usually required. This resistance should be of such value that, for normal line voltage, tubes will operate at their rated heater or filament current. The method for calculating the resistor value is given below.

When the filaments of battery-type tubes are connected in series, the total filament current is the sum of the current due to the filament supply and the plate and grid-No.2 currents (cathode current) returning to B(-) through the tube filaments. Consequently, in a series filament string it is necessary to add shunt resistors across each filament section to bypass this cathode current in order to maintain the filament voltage at its rated value.

The filament or heater resistor required when filaments and/or heaters are operated in parallel can be determined easily by a simple formula derived from Ohm's law.

$$\text{Required resistance (ohms)} = \frac{\text{supply volts} - \text{rated volts of tube type}}{\text{total rated filament current (amperes)}}$$

Thus, if a receiver using two IT4's, one IR5, one IU5, and one 3V4 is to be operated from a storage battery, the series resistor is equal to 2 volts (the voltage from a single storage cell) minus 1.4 volts (voltage rating for these tubes)

divided by 0.3 ampere (the sum of  $4 \times 0.05$  ampere +  $1 \times 0.1$  ampere), *i.e.*, approximately 2 ohms. Since this resistor should be variable to allow adjustment for battery depreciation, it is advisable to obtain the next larger commercial size, although any value between 2 and 3 ohms will be quite satisfactory.

Where much power is dissipated in the resistor, the wattage rating should be sufficiently large to prevent overheating. The power dissipation in watts is equal to the voltage drop in the resistor multiplied by the total filament current in amperes. Thus, for the example above,  $0.6 \times 0.3 = 0.18$  watt. In this case, the value is so small that any commercial rheostat with suitable resistance will be adequate.

For the case where the heaters and/or filaments of several tubes are operated in series, the resistor value is calculated by the following formula, also derived from Ohm's law.

$$\text{Required resistance (ohms)} = \frac{\text{supply volts} - \text{total rated volts of tubes}}{\text{rated amperes of tubes}}$$

Thus, if a receiver having one 6BE6, one 6BA6, one 6AT6, one 25L6-GT, and one 25Z6-GT is to be operated from a 117-volt power line, the series resistor is equal to 117 volts (the supply voltage) minus 68.9 volts (the sum of  $3 \times 6.3$  volts +  $2 \times 25$  volts) divided by 0.3 ampere (current rating of these tubes), *i.e.*, approximately 160 ohms. The wattage dissipation in the resistor will be 117 volts minus 68.9 volts times 0.3 ampere, or approximately 14.4 watts. A resistor having a wattage rating in excess of this value should be chosen.

When the series-heater connection is used in ac/dc receivers, it is usually advisable to arrange the heaters in the circuit so that the tubes most sensitive to hum disturbances are at or near the ground potential of the circuit. This arrangement reduces the amount of ac voltage between the heaters and cathodes of these tubes and minimizes the hum output of the receiver. The order of heater connection, by tube function, from chassis to the rectifier-cathode side of the ac line is shown in Fig. 82.

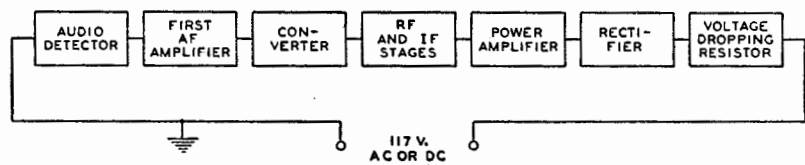

Fig. 82

### Heater-to-Cathode Connection

The cathodes of heater-type tubes, when operated from ac, should be connected to the mid-tap on the heater supply winding, to the mid-tap of a 50-ohm (approximate) resistor shunted across the winding, or to one end of the heater supply winding depending on circuit requirements. If none of these methods is used, it is important to keep the heater-cathode voltage within the ratings given in the TUBE TYPES SECTION.

Hum from ac-operated heater tubes used in high-gain audio amplifiers may frequently be reduced to a negligible value by employing a 15- to 40-volt bias between the heater and cathode elements of the tubes. The bias should be connected so that the tube heater is positive with respect to its cathode. Such bias can be obtained from the regular plate-supply rectifier of the amplifier.

If a large resistor is used between heater and cathode, it should be bypassed by a suitable capacitor or objectionable hum may develop. The hum is due to the fact that even a minute pulsating leakage current flowing between the heater and cathode will develop a small voltage across any resistance in the circuit. This hum voltage is amplified by succeeding stages.

### Plate Voltage Supply

The plate voltage for electron tubes is obtained from batteries, rectifiers, direct-current power lines, and small local generators. The maximum plate-voltage value for any tube type should not be exceeded if most satisfactory performance is to be obtained. Plate voltage should not be applied to a tube unless the corresponding recommended voltage is also supplied to the grid.

It is recommended that the primary circuit of the power transformer be fused to protect the rectifier tube(s), the power transformer, filter capacitor, and chokes in case a rectifier tube fails.

### Grid Voltage Supply

The recommended grid voltages for different operating conditions have been carefully determined to give the most satisfactory performance. Grid voltage may be obtained from a fixed source such as a separate C-battery or a tap on the voltage divider of the high-voltage dc supply, from the voltage drop across a resistor in the cathode circuit, or from the voltage drop across a resistor in the grid circuit. The first method is called "fixed bias"; the second is called "cathode bias" or "self bias"; the third is called "grid-resistor bias" and is sometimes incorrectly referred to in receiving-tube practice as "zero-bias operation."

In any case, the object is to make the grid negative with respect to the cathode by the specified voltage. When a C-battery is used, the negative terminal is connected to the grid return and the positive terminal is connected to the negative filament socket terminal, or to the cathode terminal if the tube is of the heater-cathode type. If the filament is supplied with alternating current, this connection is usually made to the center-tap of a low resistance (20-50 ohms) shunted across the filament terminals. This method reduces hum disturbances caused by the ac supply. If bias voltages are obtained from the voltage divider of a high-voltage dc supply, the grid return is connected to a more negative tap than the cathode.

The **cathode-biasing** method utilizes the voltage drop produced by the cathode current flowing through a resistor connected between the cathode and the negative terminal of the B-supply. (See Fig. 83.) The cathode current is, of course, equal to the plate current in the case of a triode, or to the sum of the plate and grid-No.2 currents in the case of a tetrode, pentode, or beam power tube. Because the voltage drop along the resistance is increasingly nega-

tive with respect to the cathode, the required negative grid-bias voltage can be obtained by connecting the grid return to the negative end of the resistance.

The value of the resistance for cathode-biasing a single tube can be determined from the following formula:

$$\text{Resistance (ohms)} = \frac{\text{desired grid-bias voltage} \times 1000}{\text{rated cathode current in milliamperes}}$$

Thus, the resistance required to produce 9 volts bias for a triode which operates at 3 milliamperes plate current is  $9 \times 1000/3 = 3000$  ohms. If the cathode current of more than one tube passes through

change appreciably with plate current. When such a tube having a separate suppressor-grid connection is used as an rf amplifier, these changes may be minimized by leaving a certain portion of the cathode-bias resistor unbypassed. In order to minimize feedback when this method is used, the external grid-No.1-to-plate (wiring) capacitances should be kept to a minimum, the grid No.2 should be bypassed to ac ground, and the grid No.3 should be connected to ac ground.

The use of a cathode resistor to obtain bias voltage is not recommended for amplifiers in which there is appreciable shift of electrode currents with the

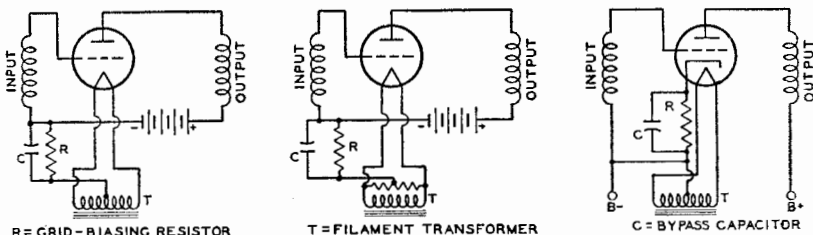

Fig. 83

the resistor, or if the tube or tubes employ more than three electrodes, the total current determines the size of the resistor.

**Bypassing** of the cathode-bias resistor depends on circuit-design requirements. In rf circuits the cathode resistor usually is bypassed. In af circuits the use of an unbypassed resistor will reduce distortion by introducing degeneration into the circuit. However, the use of an unbypassed resistor decreases gain and power sensitivity. When bypassing is used, it is important that the bypass capacitor be sufficiently large to have negligible reactance at the lowest frequency to be amplified.

In the case of power-output tubes having high transconductance such as the beam power tubes, it may be necessary to shunt the bias resistor with a small mica capacitor (approximately  $0.001\mu\text{f}$ ) in order to prevent oscillations. The usual af bypass may or may not be used, depending on whether or not degeneration is desired. In tubes having high values of transconductance, such as the 6BA6, 6CB6, and 6AC7, input capacitance and input conductance

application of a signal. In such amplifiers, a separate fixed supply is recommended.

The **grid-resistor biasing** method is also a self-bias method because it utilizes the voltage drop across the grid resistor produced by small amounts of grid current flowing in the grid-cathode circuit. This current is due to (1) an electromotive potential difference between the materials comprising the grid and cathode and (2) grid rectification when the grid is driven positive. A large value of resistance is required in order to limit this current to a very small value and to avoid undesirable loading effects on the preceding stage.

Examples of this method of bias are given in circuits 21-1 and 21-4 in the **CIRCUIT SECTION**. In both of these circuits, the audio amplifier type 1U5 or 12AV6 has a 10-megohm resistor between the grid and the negative filament or cathode to furnish the required bias which is usually less than 1 volt. This method of biasing is used principally in the early voltage amplifier stages (usually employing high- $\mu$  triodes) of audio amplifier circuits, where the tube dissi-

pation will not be excessive under zero-signal conditions.

A grid resistor is also used in many oscillator circuits for obtaining the required bias. In these circuits, the grid voltage is relatively constant and its magnitude is usually in the order of 5 volts or more. Consequently, the bias voltage is obtained only through grid rectification. A relatively low value of resistor, 0.1 megohm or less, is used. Oscillator circuits employing this method of bias are given in circuits 21-1 and 21-4 in the CIRCUIT SECTION.

**Grid-bias variation** for the rf and if amplifier stages is a convenient and frequently used method for controlling receiver volume. The variable voltage supplied to the grid may be obtained: (1) from a variable cathode resistor as shown in Figs. 84 and 85; (2) from a

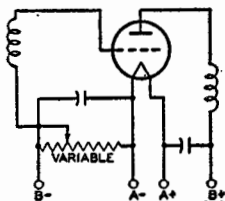

Fig. 84

bleeder circuit by means of a potentiometer as shown in Fig. 86; or (3) from a bleeder circuit in which the bleeder current is varied by a tube used for automatic volume control. The latter circuit is shown in Fig. 60.

In all cases it is important that the control be arranged so that at no time

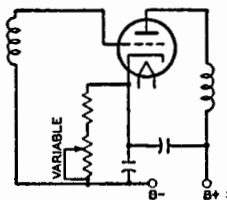

Fig. 85

will the bias be less than the recommended minimum grid-bias voltage for the particular tubes used. This requirement can be met by providing a fixed stop on the potentiometer, by connecting a fixed resistance in series with the variable resistance, or by connecting a fixed

cathode resistance in series with the variable resistance used for regulation. Where receiver gain is controlled by grid-bias variation, it is advisable to have the control voltages extend over a wide range in order to minimize cross-modulation and modulation-distortion.

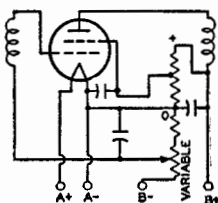

Fig. 86

A remote-cutoff type of tube should, therefore, be used in the controlled stages.

In most tubes employing a unipotential cathode, a positive grid current begins to flow when the grid is slightly negative and increases rapidly as the grid is made more positive, as shown in Fig. 87. The value of grid voltage at which positive grid current starts to flow is generally referred to as **contact potential**. Contact potential is caused by

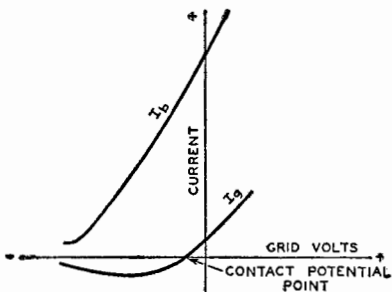

Fig. 87

the initial velocity of emission of electrons from the cathode and an electro-thermal effect due to the differences in temperature and in material composition of the grid and the cathode.

The value of the contact-potential voltage may be as high as  $1\frac{1}{2}$  volts. If the operating bias of the tube is less than the contact potential, it is found that two effects are present. Direct current flows in the grid circuit, and the dynamic input resistance of the tube may be relatively low. It is generally desir-

able to supply the tube with a value of bias sufficiently high so that the tube is not operating within the contact-potential region. When a tube must be operated within this region, care should be taken to avoid undesirable effects in the grid circuit due to grid current or low input resistance.

### Screen-Grid Voltage Supply

The positive voltage for the screen grid (grid No.2) of screen-grid tubes may be obtained from a tap on a voltage divider, from a potentiometer, or from a series resistor connected to a high-voltage source, depending on the particular tube type and its application. The screen-grid voltage for tetrodes should be obtained from a voltage divider or a potentiometer rather than through a series resistor from a high-voltage source because of the characteristic screen-grid current variations of tetrodes. Fig. 88 shows a tetrode with its screen-grid voltage obtained from a potentiometer.

When pentodes or beam power tubes are operated under conditions where a large shift of plate and screen-grid currents does not take place with the application of the signal, the screen-grid voltage may be obtained through a series resistor from a high-voltage source. This method of supply is possible because of

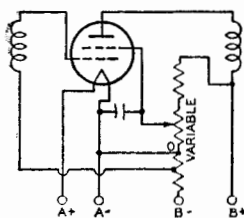

Fig. 88

the high uniformity of the screen-grid current characteristic in pentodes and beam power tubes. Because the screen-grid voltage rises with increase in bias and resulting decrease in screen-grid current, the cutoff characteristic of a pentode is extended by this method of supply.

This method is sometimes used to increase the range of signals which can be handled by a pentode. When used in resistance-coupled amplifier circuits employing pentodes in combination with

the cathode-biasing method, it minimizes the need for circuit adjustments. Fig. 89 shows a pentode with its screen-grid voltage supplied through a series resistor.

When power pentodes and beam power tubes are operated under conditions such that there is a large change in plate and screen-grid currents with the application of signal, the series-resistor method of obtaining screen-grid voltage should not be used. A change in screen-grid current appears as a change

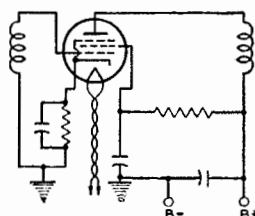

Fig. 89

in the voltage drop across the series resistor in the screen-grid circuit; the result is a change in the power output and an increase in distortion. The screen-grid voltage should be obtained from a point in the plate-voltage-supply filter system having the correct voltage, or from a separate source.

It is important to note that the plate voltage of tetrodes, pentodes, and beam power tubes should be applied before or simultaneously with the screen-grid voltage. Otherwise, with voltage on the screen grid only, the screen-grid current may rise high enough to cause excessive screen-grid dissipation.

Screen-grid voltage variation for the rf amplifier stages has sometimes been used for volume control in older-type receivers. Reduced screen-grid voltage lowers the transconductance of the tube and results in reduced gain per stage. The voltage variation is obtained by means of a potentiometer shunted across the screen-grid voltage supply. (See Fig. 88.) When the screen-grid voltage is varied, it must never exceed the rating of the tube. This requirement can be met by providing a fixed stop on the potentiometer.

### Shielding

In high-frequency stages having

high gain, the output circuit of each stage must be shielded from the input circuit of that stage. Each high-frequency stage also must be shielded from the other high-frequency stages. Unless shielding is employed, undesired feedback may occur and may produce many harmful effects on receiver performance.

To prevent this feedback, it is a desirable practice to shield separately each unit of the high-frequency stages. For instance, in a superheterodyne receiver, each if and rf coil may be mounted in a separate shield can. Baffle plates may be mounted on the ganged tuning capacitor to shield each section of the capacitor from the other section. The oscillator coil may be especially well shielded by being mounted under the chassis.

The shielding precautions required in a receiver depend on the design of the receiver and the layout of the parts. In all receivers having high-gain high-frequency stages, it is necessary to shield separately each tube in high-frequency stages. When metal tubes, and in particular the single-ended types, are used, complete shielding of each tube is provided by the metal shell which is grounded through its grounding pin as the socket terminal. The grounding connection should be short and sturdy. Many modern tubes of glass construction have internal shields, usually connected to the cathode; where present, these shields are indicated in the socket diagram.

### Dress of Circuit Leads

At high frequencies such as are encountered in FM and television receivers, lead dress, that is, the location and arrangement of the leads used for connections in the receiver, is very important. Because even a short lead provides a large impedance at high frequencies, it is necessary to keep all high-frequency leads as short as possible. This precaution is especially important for ground connections and for all connections to bypass capacitors and high-frequency filter capacitors. The ground connections of plate and screen-grid bypass capacitors of each tube should be kept short and made directly to cathode ground.

Particular care should be taken

with the lead dress of the input and output circuits of high-frequency stages so that the possibility of stray coupling is minimized. Unshielded leads connected to shielded components should be dressed close to the chassis. As the frequency increases, the need for careful lead dress becomes increasingly important.

In high-gain audio amplifiers, these same precautions should be taken to minimize the possibility of self-oscillation.

### Filters

Feedback effects also are caused in radio or television receivers by coupling between stages through common voltage-supply circuits. Filters find an important use in minimizing such effects. They should be placed in voltage-supply leads to each tube in order to return the signal current through a low-impedance path direct to the tube cathode rather than by way of the voltage-supply circuit. Fig. 90 illustrates several forms of filter circuits. Capacitor C forms the

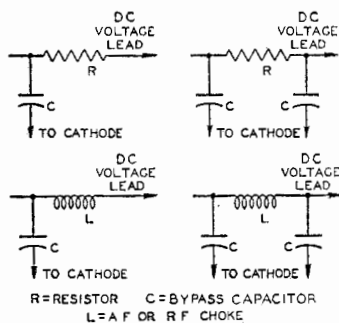

Fig. 90

low-impedance path, while the choke or resistor assists in diverting the signal through the capacitor by offering a high impedance to the power-supply circuit.

The choice between a resistor and a choke depends chiefly upon the permissible dc voltage drop through the filter. In circuits where the current is small (a few milliamperes), resistors are practical; where the current is large or regulation important, chokes are more suitable.

The minimum practical size of the capacitors may be estimated in most cases by the following rule: The impedance of the capacitor at the lowest fre-

frequency amplified should not be more than one-fifth of the impedance of the filter choke or resistor at that frequency. Better results will be obtained in special cases if the ratio is not more than one-tenth.

Radio-frequency circuits, particularly at high frequencies, require high-quality capacitors. Mica or ceramic capacitors are preferable. Where stage shields are employed, filters should be placed within the shield.

Another important application of filters is to smooth the output of a rectifier tube. See *Rectification*. A smoothing

down is to be avoided. When the input-choke method is used, the available dc output voltage will be somewhat lower than with the input-capacitor method for a given ac plate voltage. However, improved regulation together with lower peak current will be obtained.

Mercury-vapor and gas-filled rectifier tubes occasionally produce a form of local interference in radio receivers through direct radiation or through the power line. This interference is generally identified in the receiver as a broadly tunable 120-cycle buzz (100 cycles for 50-cycle supply line, etc.). It is usually

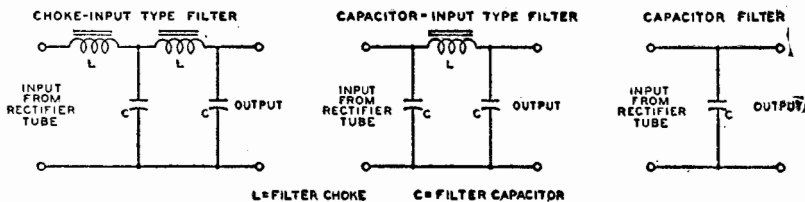

Fig. 91

filter usually consists of capacitors and iron-core chokes. In any filter-design problem, the load impedance must be considered as an integral part of the filter because the load is an important factor in filter performance. Smoothing effect is obtained from the chokes because they are in series with the load and offer a high impedance to the ripple voltage. Smoothing effect is obtained from the capacitors because they are in parallel with the load and store energy on the voltage peaks; this energy is released on the voltage dips and serves to maintain the voltage at the load substantially constant. Smoothing filters are classified as choke-input or capacitor-input according to whether a choke or capacitor is placed next to the rectifier tube. See Fig. 91.

The **CIRCUIT SECTION** gives a number of examples of rectifier circuits with recommended filter constants.

If an input capacitor is used, consideration must be given to the instantaneous peak value of the ac input voltage. This peak value is about 1.4 times the rms value as measured by an ac voltmeter. Filter capacitors, therefore, especially the input capacitor, should have a rating high enough to withstand the instantaneous peak value if break-

caused by the formation of a steep wave front when plate current within the tube begins to flow on the positive half of each cycle of the ac supply voltage.

There are several ways of eliminating this type of interference. One is to shield the tube. Another is to insert an rf choke having an inductance of one millihenry or more between each plate and transformer winding and to connect high-voltage, rf bypass capacitors between the outside ends of the transformer winding and the center tap. (See Fig. 92.) The rf chokes should be placed within the shielding of the tube. The rf bypass

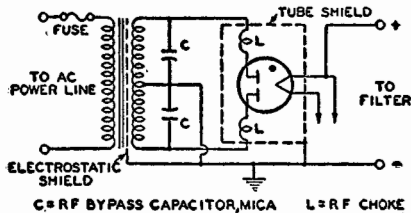

Fig. 92

capacitors should have a voltage rating high enough to withstand the peak voltage of each half of the secondary, which is approximately 1.4 times the rms value.

Transformers having electrostatic shielding between primary and second-



ary are not likely to transmit rf disturbances to the line. Often the interference may be eliminated simply by making the plate leads of the rectifier extremely short. In general, the particular method of interference elimination must be selected by experiment for each installation.

### Output-Coupling Devices

An output-coupling device is used in the plate circuit of a power output tube to keep the comparatively high dc plate current from the winding of an electromagnetic speaker and, also, to transfer power efficiently from the output stage to a loudspeaker of either the electromagnetic or dynamic type.

Output-coupling devices are of two types, (1) choke-capacitor and (2) transformer. The choke-capacitor type includes an iron-core choke having an inductance of not less than 10 henries which is placed in series with the plate and B-supply. The choke offers a very low resistance to the dc plate current component of the signal voltage but opposes the flow of the fluctuating component. A bypass capacitor of 2 to 6 microfarads supplies a path to the speaker winding for the signal voltage. The choke-coil output coupling device, however, is now only of historical interest.

The transformer type is constructed with two separate windings, a primary and a secondary wound on an iron core. This construction permits designing each winding to meet the requirements of its position in the circuit. Typical arrangements of each type of coupling device are shown in Fig. 93. Examples of transformers for push-pull stages are shown

### High-Voltage Considerations for Television Picture Tubes

Like other high-voltage devices, television picture tubes require that certain precautions be observed to minimize the possibility of failure caused by humidity, dust, and corona.

**Humidity Considerations.** When humidity is high, a continuous film of moisture may form on the glass bulb immediately surrounding the ultor cavity cap of all-glass picture tubes or on the glass part of the envelope of metal picture tubes. This film may permit sparking to take place over the glass surface to the external conductive coating or to the metal shell. Such sparking may introduce noise into the receiver. To prevent such a possibility, the uncoated bulb surface around the cap and the glass part of the envelope of metal picture tubes should be kept clean and dry.

**Dust Considerations.** The accumulation of dust on the uncoated area of the bulb around the ultor cap of all-glass picture tubes or on the glass part of the envelope or insulating supports for metal picture tubes will decrease the insulating qualities of these parts. The dust usually consists of fibrous materials and may contain soluble salts. The fibers absorb and retain moisture; the soluble salts provide electrical leakage paths that increase in conductivity as the humidity increases. The resulting high leakage currents may overload the high-voltage power supply.

It is recommended, therefore, that the uncoated bulb surface of all-glass picture tubes and the coated glass surface and insulating supports for metal picture tubes be kept clean and free from dust or other contamination such as finger-prints. The frosted Filterglass faceplate of the metal picture tubes may be cleaned with a soapless detergent, such as Dreft, then rinsed with clean water, and immediately dried.

**Corona Considerations.** A high-voltage system may be subject to corona, especially when the humidity is high, unless suitable precautions are taken. Corona, which is an electrical discharge appearing on the surface of a conductor when the voltage gradient exceeds the breakdown value of air, causes deterior-

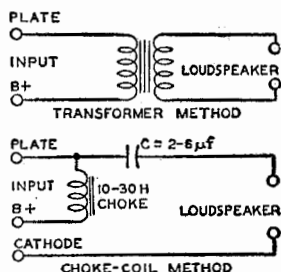

Fig. 93

in several of the circuits given in the **CIRCUIT SECTION.**

ration of organic insulating materials through formation of ozone, and induces arc-over at points and sharp edges. Sharp points or other irregularities on any part of the high-voltage system may increase the possibility of corona and should be avoided.

In the metal-shell picture tubes, the metal lip at the maximum diameter has rounded edges to prevent corona. Adequate spacing between the lip and any grounded element in the receiver, or between the small end of the metal shell and any grounded element, should be provided to preclude the possibility of corona. Such spacing should not be less than 1 inch of air. Similarly, an air space of 1 inch, or equivalent, should be provided around the body of the metal shell. As a further precaution to prevent corona, the deflecting-yoke surface on the end adjacent to the shell should present a smooth electrical surface with respect to the small end of the metal shell or the ultor terminal of all-glass tubes.

### **Picture-Tube Safety Considerations**

**Tube Handling.** Breakage of picture tubes, which contain a high vacuum, may result in injury from flying glass. Do not strike or scratch the tube or subject it to more than moderate pressure when installing it in or removing it from electronic equipment.

**High-Voltage Precautions.** In picture-tube circuits, high voltages may appear at normally low-potential points in the circuit because of capacitor breakdown or incorrect circuit connections. Therefore, before any part of the circuit is touched the power-supply switch should be turned off, the power plug disconnected, and both terminals of any capacitors grounded.

**X-Ray Radiation Precautions.** All types of picture tubes may be operated at voltages (if ratings permit) up to 16 kilovolts without producing harmful x-ray radiation or danger of personal injury on prolonged exposure at close range. Above 16 kilovolts, special x-ray shielding precautions may be necessary.

# Interpretation of Tube Data

The tube data given in the following TUBE TYPES SECTION include ratings, typical operation values, characteristics, and characteristic curves.

The values for grid-bias voltages, other electrode voltages, and electrode supply voltages are given with reference to a specified datum point as follows: For types having filaments heated with dc, the negative filament terminal is taken as the datum point to which other electrode voltages are referred. For types having filaments heated with ac, the mid-point (i.e., the center tap on the filament-transformer secondary, or the mid-point on a resistor shunting the filament) is taken as the datum point. For types having unipotential cathodes indirectly heated, the cathode is taken as the datum point.

Ratings are established on electron tube types to help equipment designers utilize the performance and service capabilities of each tube type to best advantage. Ratings are given for those characteristics which careful study and experience indicate must be kept within certain limits to insure satisfactory performance.

Three rating systems are in use by the electron-tube industry. The oldest is known as the Absolute Maximum system, the next as the Design Center system, and the latest and newest as the Design Maximum system. Definitions of these systems have been formulated by the Joint Electron Tube Engineering Council (JETEC)\* and standardized by the National Electrical Manufacturers Association (NEMA) and the Electronic Industries Association (EIA) as follows:

**Absolute Maximum** ratings are limiting values which should not be exceeded with any tube of the specified type under any condition of operation. These ratings are used only in rare instances for receiving types, but are generally used for transmitting and industrial types.

**Design Center** ratings are limiting values which should not be exceeded with a tube of the specified type having characteristics equal to the published

\*Now identified as the Joint Electron Device Engineering Council (JEDEC).

values under normal operating conditions. These ratings, which include allowances for normal variations in both tube characteristics and operating conditions, were used for most receiving tubes prior to 1957. Unless specified otherwise, ratings given in the TUBE TYPES SECTION are based on the Design Center System.

**Design Maximum** ratings are limiting values which should not be exceeded with a tube of the specified type having characteristics equal to the published values under any conditions of operation. These ratings include allowances for normal variations in tube characteristics, but do not provide for variations in operating conditions. Design Maximum ratings were adopted for receiving tubes in 1957.

Electrode voltage and current ratings are in general self-explanatory, but a brief explanation of other ratings will aid in the understanding and interpretation of tube data.

**Heater warm-up time** is defined as the time required for the voltage across the heater to reach 80 per cent of the rated value in the circuit shown in Fig. 94. The heater is placed in series with a

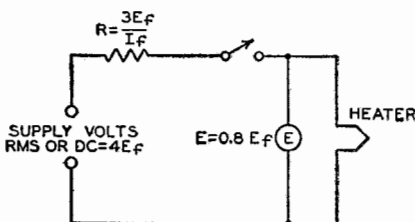

$E_f$  = RATED HEATER VOLTAGE  
 $I_f$  = RATED HEATER CURRENT

Fig. 94

resistance having a value 3 times the nominal heater operating resistance ( $R = 3 E_f / I_f$ ), and a voltage having a value 4 times the rated heater voltage ( $V = 4 E_f$ ) is then applied. The warm-up time is determined when  $E = 0.8 E_f$ .

**Plate dissipation** is the power dissipated in the form of heat by the plate as a result of electron bombardment. It is the difference between the power supplied to the plate of the tube and the power delivered by the tube to the load.

**Grid-No.2 (Screen-grid) Input** is the power applied to the grid-No. 2 electrode and consists essentially of the power dissipated in the form of heat by grid No.2 as a result of electron bombardment. With tetrodes and pentodes, the power dissipated in the screen-grid circuit is added to the power in the plate circuit to obtain the total B-supply input power.

When the screen-grid voltage is supplied through a series voltage-dropping resistor, the maximum screen-grid voltage rating may be exceeded, provided the maximum screen-grid dissipation rating is not exceeded at any signal condition, and the maximum screen-grid voltage rating is not exceeded at the maximum-signal condition. Provided these conditions are fulfilled, the screen-grid supply voltage may be as high as, but not above, the maximum plate voltage rating.

For certain voltage amplifier types, as listed in the data section, the maximum permissible screen-grid (grid-No.2) input varies with the screen-grid voltage, as shown in Fig. 95. (This curve cannot be assumed to apply to types other than those for which it is specified in the data section.) Full rated screen-grid input is

permissible at screen-grid voltages up to 50 per cent of the maximum rated screen-grid supply voltage. From the 50-per cent point to the full rated value of supply voltage, the screen-grid input must be decreased. The decrease in allowable screen-grid input follows a curve of the parabolic form. This rating chart is useful for applications utilizing either a fixed screen-grid voltage or a series screen-grid voltage-dropping resistor. When a fixed voltage is used, it is necessary only to determine that the screen-grid input is within the boundary of the operating area on the chart at the selected value of screen-grid voltage to be used. When a voltage-dropping resistor is used, the minimum value of resistor that will assure tube operation within the boundary of the curve can be determined from the following relation:

$$R_{g2} \geq \frac{E_{c2} (E_{cc2} - E_{c2})}{P_{c2}}$$

where  $R_{g2}$  is the minimum value for the voltage-dropping resistor in ohms,  $E_{c2}$  is the selected screen-grid voltage in volts,  $E_{cc2}$  is the screen-grid supply voltage in volts, and  $P_{c2}$  is the screen-grid input in watts corresponding to  $E_{c2}$ .

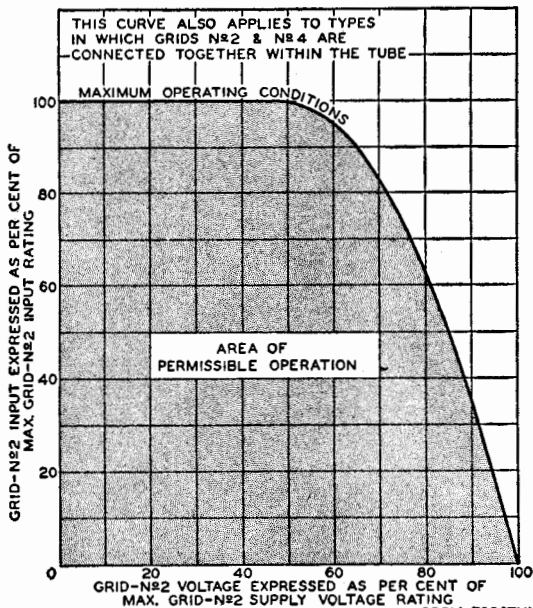

Fig. 95

**Peak heater-cathode voltage** is the highest instantaneous value of voltage that a tube can safely stand between its heater and cathode. This rating is applied to tubes having a separate cathode terminal and used in applications where excessive voltage may be introduced between heater and cathode.

**Maximum dc output current** is the highest average plate current which can be handled continuously by a rectifier tube. Its value for any rectifier tube type is based on the permissible plate dissipation of that type. Under operating con-

ditions involving a rapidly repeating duty cycle (steady load), the average plate current may be measured with a dc meter.

Curves of average plate characteristics for several half-wave vacuum rectifiers are given in Figs. 96 and 97. These curves are shown solid up to the maximum average or dc plate-current rating of each type. The curves in Fig. 96 are for high-voltage types having pulsed rectifier ratings. The curves in Fig. 97 are for damper tubes.

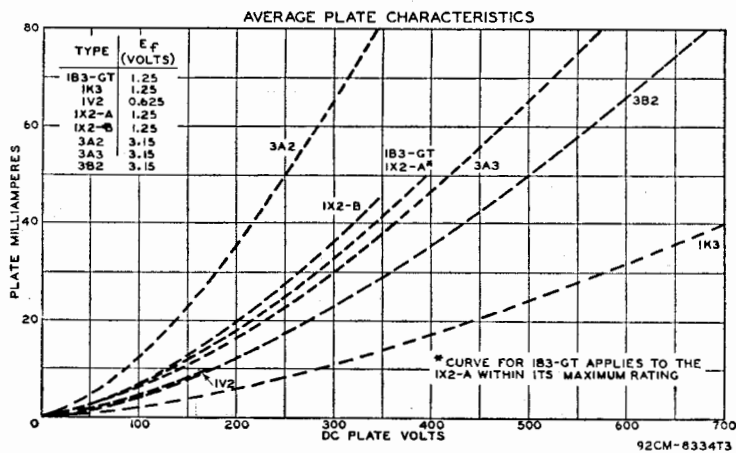

Fig. 96

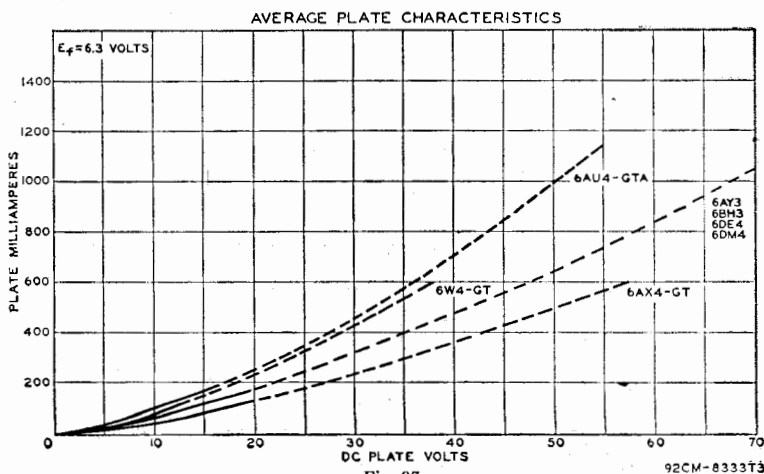

Fig. 97

**Maximum peak plate current** is the highest instantaneous plate current that a tube can safely carry recurrently in the direction of normal current flow. The safe value of this peak current in hot-cathode types of rectifier tubes is a function of the electron emission available and the duration of the pulsating current flow from the rectifier tube in each half-cycle.

The value of peak plate current in a given rectifier circuit is largely determined by filter constants. If a large choke is used at the filter input, the peak plate current is not much greater than the load current; but if a large capacitor is used as the filter input, the peak current may be many times the load current. In order to determine accurately the peak plate current in any rectifier circuit, measure it with a peak-indicating meter or use an oscillograph.

**Maximum peak inverse plate voltage** is the highest instantaneous plate voltage which the tube can withstand recurrently in the direction opposite to that in which it is designed to pass current. For mercury-vapor tubes and gas-filled tubes, it is the safe top value to prevent arc-back in the tube operating within the specified temperature range.

Referring to Fig. 98, when plate A of a full-wave rectifier tube is positive, current flows from A to C, but not from B to C, because B is negative. At the instant plate A is positive, the filament is positive (at high voltage) with respect to plate B. The voltage between the positive filament and the negative plate B is

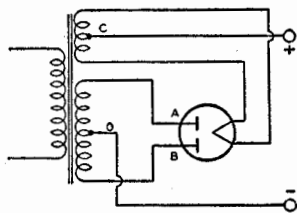

Fig. 98

in inverse relation to that causing current flow. The peak value of this voltage is limited by the resistance and nature of the path between plate B and filament. The maximum value of this volt-

age at which there is no danger of breakdown of the tube is known as maximum peak inverse voltage.

The relations between peak inverse voltage, rms value of ac input voltage, and dc output voltage depend largely on the individual characteristics of the rectifier circuit and the power supply. The presence of line surges or any other transient, or wave-form distortion, may raise the actual peak voltage to a value higher than that calculated for sine-wave voltages. Therefore, the **actual** inverse voltage, and not the calculated value, should be such as not to exceed the rated maximum peak inverse voltage for the rectifier tube. A calibrated cathode-ray oscillograph or a peak-indicating electronic voltmeter is useful in determining the actual peak inverse voltage.

In single-phase, full-wave circuits with sine-wave input and with no capacitor across the output, the peak inverse voltage on a rectifier tube is approximately 1.4 times the rms value of the plate voltage applied to the tube. In single-phase, half-wave circuits with sine-wave input and with capacitor input to the filter, the peak inverse voltage may be as high as 2.8 times the rms value of the applied plate voltage. In polyphase circuits, mathematical determination of peak inverse voltage requires the use of vectors.

The **Rating Chart** for full-wave rectifiers presents graphically the relationships between maximum ac voltage input and maximum dc output current derived from the fundamental ratings for conditions of capacitor-input and choke-input filters. This graphical presentation provides for considerable latitude in choice of operating conditions.

The **Operation Characteristics** for a full-wave rectifier with capacitor-input filter show by means of boundary line the limiting current and voltage relationships presented in the Rating Chart.

The **Operation Characteristics** for a full-wave rectifier with choke-input filter not only show by means of boundary line the limiting current and voltage relationships presented in the Rating Chart, but also give some information as to the effect on regulation of various

sizes of chokes. The solid-line curves show the dc voltage outputs which would be obtained if the filter chokes had infinite inductance. The long-dash lines radiating from the zero position are boundary lines for various sizes of chokes as indicated. The intersection of one of these lines with a solid-line curve indicates the point on the curve at which the choke no longer behaves as though it had infinite inductance. To the left of the choke boundary line, the regulation curves depart from the solid-line curves as shown by the representative short-dash regulation curves.

**Typical Operation Values.** Values for typical operation are given for many types in the TUBE TYPES SECTION. These typical operating values are given to show concisely some guiding information for the use of each type. These values should not be confused with ratings, because a tube can be used under any suitable conditions within its maximum ratings, according to the application.

The power output value for any operating condition is an approximate tube output—that is, plate input minus plate loss. Circuit losses must be subtracted from tube output in order to determine the useful output.

**Characteristics** are covered in the ELECTRON TUBE CHARACTERISTICS SECTION and such data should be interpreted in accordance with the definitions given in that section. **Characteristic curves** represent the characteristics of an average tube. Individual tubes, like any manufactured product, may have characteristics that range above or below the values given in the characteristic curves.

Although some curves are extended well beyond the maximum ratings of the tube, this extension has been made only for convenience in calculations. Do NOT operate a tube outside of its maximum ratings.

**Interelectrode capacitances** are direct capacitances measured between specified elements or groups of elements in electron tubes. Unless otherwise indicated in the data, all capacitances are measured with filament or heater cold, with no direct voltages present, and with no external shields. All electrodes other than those between which capacitance

is being measured are grounded. In twin or multi-unit types, inactive units are also grounded.

The capacitance between the input electrode and all other electrodes, except the output electrode, connected together is commonly known as the input capacitance. The capacitance between the output electrode and all other electrodes, except the input electrode, connected together is known as the output capacitance.

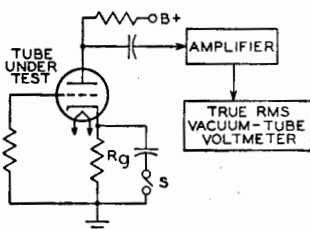

Fig. 99

**Hum and noise characteristics** of high-fidelity audio amplifier tube types such as the 7025 and the 7199 are tested in an amplifier circuit such as that shown in Fig. 99. The output of the test circuit is fed into a low-noise amplifier. The bandwidth of this amplifier depends on the characteristic being measured. If hum alone is being tested, a relatively narrow bandwidth is used to include both the line frequency and the major harmonics generated by the tube under test. In noise or combination hum-and-noise measurements, the bandwidth is defined in the registration of the tube type.

The amplifier gain is calibrated so that the vacuum-tube voltmeter measures hum and noise in microvolts referenced to the grid of the tube under test. A pentode can also be evaluated in this manner by the addition of a screen-grid supply adequately bypassed at the tube screen-grid pin connection. Power-supply ripple at the plate of the tube under test must be negligible compared to its hum and noise output. Extraordinary shielding of both the test socket and the associated operating circuit is required to minimize capacitances between heater leads and high-impedance connections.

The test-circuit components are determined by the tube type being tested and the type of hum to be controlled.

Heater-cathode hum can be eliminated from the measurement by closing  $S_1$ . The circuit can also be made more or less sensitive to heater-grid hum by in-

creasing or decreasing the grid resistance  $R_g$ . No circuit changes affect the component of magnetic hum generated by the tube.

## TYPICAL TUBE-PART MATERIALS

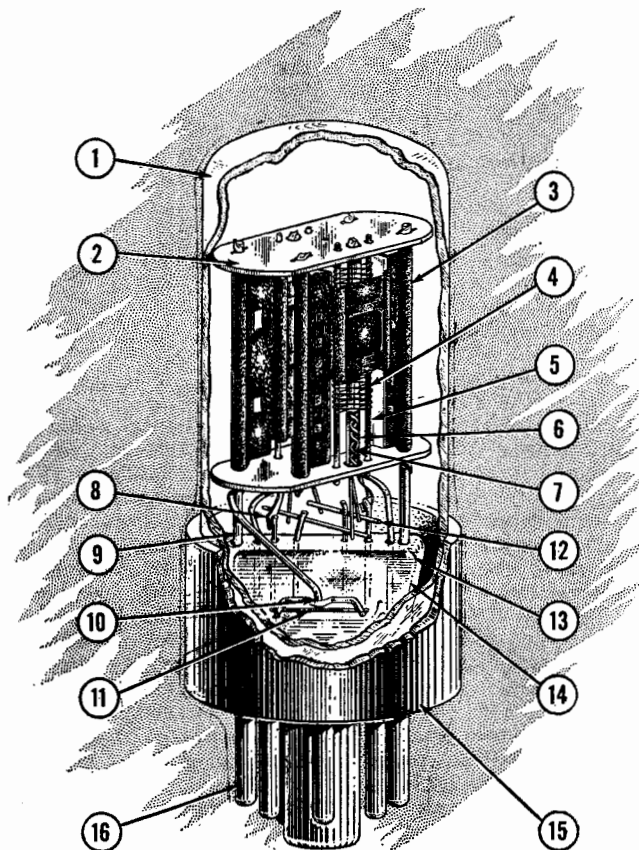

- |   |  |
|---|--|
| <p>1. <b>ENVELOPE</b>—Lime glass</p> <p>2. <b>SPACER</b>—Mica sprayed with magnesium oxide</p> <p>3. <b>PLATE</b>—Carbonized nickel or nickel-plated steel</p> <p>4. <b>GRID WIRES</b>—Manganese-nickel or molybdenum</p> <p>5. <b>GRID SIDE-RODS</b>—Chrome copper, nickel, or nickel-plated iron</p> <p>6. <b>CATHODE</b>—Nickel coated with barium-calcium-strontium carbonates</p> <p>7. <b>HEATER</b>—Tungsten or tungsten-molybdenum alloy with insulating coating of alundum</p> | <p>8. <b>CATHODE TAB</b>—Nickel</p> <p>9. <b>MOUNT SUPPORT</b>—Nickel or nickel-plated iron</p> <p>10. <b>GETTER SUPPORT AND LOOP</b>—Nickel or nickel-plated iron</p> <p>11. <b>GETTER</b>—Barium-magnesium alloys</p> <p>12. <b>HEATER CONNECTOR</b>—Nickel or nickel-plated iron</p> <p>13. <b>STEM LEAD-IN WIRES</b>—Nickel, dumet, copper</p> <p>14. <b>PRESSED STEM</b>—Lead glass</p> <p>15. <b>BASE</b>—Bakelite</p> <p>16. <b>BASE PINS</b>—Nickel-plated brass</p> |
|---|--|



# RCA Receiving Tube Chart

In the accompanying chart, RCA receiving tubes are classified in two ways, (a) by function, and (b) by structure (diode, triode, etc.). The functional classification covers the 18 principal types of application. These applications are listed below for your convenience in using the chart.

Tube types are grouped by structure under each classification; they are also keyed to indicate whether they are miniature, octal, nuvistor, or noval types.

Triodes are designated as *low-*, *medium-*, or *high-mu* on the following basis: *low-mu*— $\mu$  less than 10; *medium-mu*— $\mu$  10 or more, but less than 50; *high-mu*— $\mu$  50 or more. Where applicable, tubes are designated as *sharp-*, *semi-remote-*, or *remote-cutoff* on the basis of

the ratio, in per cent, of the negative control-grid voltage to the screen-grid voltage (or, for triodes, the plate voltage) as given in the characteristics or typical operation values. These terms are defined as follows: *sharp-cutoff*—less than 10 per cent; *semiremote-cutoff*—10 or more but less than 20 per cent; *remote-cutoff*—20 per cent, or more.

For more complete data on these types, refer to the TUBE TYPES TECHNICAL DATA SECTION. When choosing a tube type, refer to the listing of *Types Not Recommended for New Equipment Design* on the inside back cover.

For information on picture tubes, refer to the RCA PICTURE TUBE CHARACTERISTICS CHART.

## APPLICATIONS:

- |                       |   |                             |
|-----------------------|---|-----------------------------|
| 1. Voltage Amplifiers | 7. Mixers                                     | 13. Relay-Control           |
| 2. Power Amplifiers   | 8. Electron-Ray Tubes                         | 14. Television Deflection   |
| 3. Converters         | 9. Gated Amplifiers                           | 15. Power-Supply Rectifiers |
| 4. Mixer-Oscillators  | 10. Complex-Wave Generators                   | 16. High-Voltage Rectifiers |
| 5. UHF Oscillators    | 11. Regulators (High-Voltage,<br>Low Current) | 17. Dampner Tubes           |
| 6. HF Oscillators     | 12. FM Detectors                              | 18. Detector Diodes         |

## 1. VOLTAGE AMPLIFIERS

### Low-Mu Triodes

#### Single Unit

• 12B4-A      27

#### With Twin Diodes

• 12FK6

#### With Medium-Mu Triode

• 12AE7

#### With Pentode

◦ 6AD7-G      6F7

### Medium-Mu Triodes

#### Single Unit

• 1LE3	• 6BC4	◦ 6J5
• 2BN4	• 6BN4	◦ 6J5-GT
• 2BN4-A	• 6BN4-A	7A4
• 3BN4	◦ 6C5	◦ 12J5-GT
• 3BN4-A		

### Twin Unit

• 4BC8	◦ 6C8-G	• 8FQ7
• 4BQ7-A	• 6CG7	• 9AU7
• 4BS8	◦ 6F8-G	◦ 12AH7-GT
• 4BZ7	• 6FQ7	• 12AU7-A
• 5BK7-A	• 6FW8	• 12AV7
• 5BQ7-A	• 6J6	• 12AY7
• 5J6	• 6J6-A	• 12BH7-A
• 6BC8	◦ 6SN7-GTB	◦ 12SN7-GT
• 6BK7-B	7AF7	◦ 12SN7-GTA
• 6BQ7-A	• 7AU7	• 12U7
• 6BS8	7F8	14AF7
• 6BZ7	7N7	14F8
• 6BZ8	• 8CG7	• 19J6

### With Twin Diodes

• 6BF6	◦ 6R7	• 12BF6
• 6BJ8	◦ 6SR7	• 12FM6
• 6BV8	• 12AE6-A	◦ 12SR7

### With Low-Mu Triode

• 12AE7

### With High-Mu Triode

• 12DW7      • 7247

• Miniature   ◦ Octal   ▷ Nuvistor   ▶ Novar   • Miniature   ◦ Octal   ▷ Nuvistor   ▶ Novar

**VOLTAGE AMPLIFIERS (cont'd)**

**Medium-Mu Triodes (cont'd)**

*With Tetrode*

- 5CL8-A      • 6CQ8      • 12DY8
- 5CQ8      • 9CL8      • 19CL8-A
- 6CL8-A

*With Pentode*

- 5AT8      • 6AU8      • 6EH8
- 5AV8      • 6AU8-A    • 6EU8
- 5B8      • 6AX8      • 6U8-A
- 5BE8      • 6AZ8      • 6X8
- 5BR8      • 6BA8-A    • 8AU8
- 5CG8      • 6BH8      • 8BA8-A
- 5EA8      • 6BR8      • 8BH8
- 5EU8      • 6BR8-A    • 8CX8
- 5U8      • 6CG8-A    • 9U8-A
- 5X8      • 6CH8      • 12CT8
- 6AN8      • 6CU8      • 12EC8
- 6AN8-A    • 6CX8      • 19EA8
- 6AT8-A    • 6EA8      • 7199

*With Pentode and Diode*

- 12FR8

**High-Mu Triodes**

*Single Unit*

- ▷ 2CW4      ▷ 6DS4      • 6GK5
- 2ER5      • 6ER5      • 6SF5
- 6AB4      • 6ES5      • 6SF5-GT
- 6AM4      • 6F5      • 7B4
- 6AN4      • 6FH5      • 12SF5
- ▷ 6CW4

*Twin Unit*

- 6AQ8      • 12AT7      • 12DT8
- 6DT8      • 12AX7      • 12SC7
- 6EU7      • 12AX7-A    • 12SL7-GT
- 6SC7      • 12AZ7      • 14F7
- 6SL7-GT    • 12AZ7-A    • 20EZ7
- 7F7      • 12BZ7      • 7025

*Triple Unit*

- 6EZ8      • 6GY8

*With Diode*

- 1H5-GT      1LH4

*With Twin Diodes*

- 3AV6      • 6SQ7      • 12AV6
- 4AV6      • 6SQ7-GT    • 12BR7
- 6AQ6      • 7B6      • 12EL6
- 6AQ7-GT    • 7C6      • 12Q7-GT
- 6AT6      • 7K7      • 12SQ7
- 6AV6      • 7X7      • 12SQ7-GT
- 6BN8      • 8BN8      • 14B6
- 6CN7      • 8CN7      • 14GT8
- 6FM8      • 9BR7      • 18FY6
- 6Q7      • 12AJ6      • 18FY6-A
- 6Q7-GT    • 12AT6      • 75

*With Triple Diodes*

- 5T8      • 6T8-A      • 19T8
- 6S8-GT

*With Medium-Mu Triode*

- 12DW7      • 7247

*With Pentode*

- 5CM8      • 6GN8      • 8GN8
- 5DH8      • 6HF8      • 10C8
- 6AW8-A    • 8AW8-A    • 10HF8
- 6CM8      • 8EB8      • 35DZ8
- 6EB8

**Variable-Mu Triodes**

*Twin Unit*

- 4ES8      • 6ES8

**Sharp-Cutoff Tetrodes**

*Single Unit*

- 2CY5      • 4CY5      • 6EV5
- 3CY5      • 6CY5      • 6FV6
- 3EA5      • 6EA5      • 24-A

*With Triode*

- 5CL8-A    • 6CL8-A      • 9CL8
- 5CQ8      • 6CQ8      • 19CL8-A

**Sharp-Cutoff Pentodes**

*Single Unit*

- 1LN5      • 6AK5      • 6SJ7-GT
- 1N5-GT    • 6AU6      • 7AG7
- 1U4      • 6AU6-A    • 7AH7
- 3AU6      • 6BC5      • 7C7
- 3BC5      • 6BH6      • 7G7
- 3CB6      • 6C6      • 7V7
- 3CE5      • 6CB6      • 7W7
- 3CF6      • 6CB6-A    • 12AU6
- 3DK6      • 6CE5      • 12AW6
- 4AU6      • 6CF6      • 12BV7
- 4BC5      • 6DC6      • 12BY7-A
- 4CB6      • 6DE6      • 12J7-GT
- 4DE6      • 6DK6      • 12SJ7
- 4EW6      • 6EW6      • 12SH7
- 5EW6      • 6J7      • 14C7
- 6AB7      • 6J7-GT    • 18GD6-A
- 6AC7      • 6SH7      • 5879
- 6AG5      • 6SJ7      • 7543
- 6AH6

*Twin Unit*

- 3BU8      • 4GS8/4BU8 • 6HS8
- 4BU8      • 6BU8

*With Diode*

- 1LD5      • 5AM8      • 6AS8
- 1S5      • 5AS8      • 6BY8
- 1U5      • 6AM8-A

• Miniature    • Octal    ▷ Nuvistor    ▷ Novar      • Miniature    • Octal    ▷ Nuvistor    ▷ Novar

# Receiving Tube Chart

## With Twin Diodes

- 5BT8            • 6BW8            • 8ET7
- 5BW8

## With Triode

- 5AN8            • 6AU8-A            • 6GN8
- 5AT8            • 6AW8-A            • 6HF8
- 5AV8            • 6AZ8                • 6U8-A
- 5B8             • 6BA8-A            • 6X8
- 5BE8            • 6BH8                • 8AU8
- 5BR8            • 6BR8                • 8AW8-A
- 5CG8            • 6BR8-A            • 8BA8-A
- 5CM8            • 6CG8-A            • 8BH8
- 5DH8            • 6CH8                • 8CX8
- 5EA8            • 6CM8                • 8EB8
- 5EU8            • 6CU8                • 8GN8
- 5FV8            • 6CX8                • 9U8-A
- 5U8             • 6EA8                • 10C8
- 5X8             • 6EB8                • 10HF8
- 6AN8            • 6EH8                • 12CT8
- 6AN8-A         • 6EU8                • 19EA8
- 6AT8-A         • 6FV8                • 7199
- 6AU8

## Semiremote-Cutoff Pentodes

### Single Unit

- 3BZ6            • 6BZ6                7H7
- 4BZ6            • 6GM6                • 12BZ6
- 5GM6            ◦ 6SG7                ◦ 12SG7

### With Diode

- 1DN5

### With Twin Diodes

- 6B8             ◦ 12C8

### With Triode

- 6AX8            • 12EC8

## Remote-Cutoff Pentodes

### Single Unit

- 1LGS            ◦ 6SK7-GT            • 12DZ6
- 1T4             ◦ 6SS7                • 12EA6
- 3BA6            7A7                    • 12EK6
- 6BA6            7B7                    ◦ 12K7-GT
- 6BD6            • 12AC6                ◦ 12SK7
- 6BJ6            • 12AF6                ◦ 12SK7-GT
- 6D6             • 12BA6                14A7
- 6K7             • 12BD6                • 18FW6
- 6K7-GT        • 12BL6                • 18FW6-A
- 6S7             • 12CN5                78
- 6SK7            • 12CX6

### With Diode

- 6CR6            • 12CR6                ◦ 12SF7
- 6EQ7            • 12DE8                • 20EQ7
- 6SF7            • 12EQ7

## With Twin Diodes

- 7E7              • 12F8                14R7
- 7R7

## With Triode

- 6F7

## With Triode and Diode

- 12FR8

## Pentagrid

- 12EG6

## Beam Tubes

### Single Unit

- 3BN6            • 4BN6                • 6BN6

## 2. POWER AMPLIFIERS

### Low-Mu Triodes

#### Single Unit

- 2A3

### Medium-Mu Triodes

#### Single Unit

- 6C4

#### Twin Unit

- 6J6              ◦ 6N7                 ◦ 6N7-GT
- 6J6-A

### High-Mu Triodes

#### Single Unit

- 6AC5-GT

### Tetrodes

#### Single Unit

- 12K5

#### With Diode

- 12EM6

#### With Twin Diode

- 12DK7            • 12DS7                • 12DV8
- 12DL8            • 12DU7                • 12J8

#### With Triode

- 12AL8

• Miniature    ◦ Octal    ▷ Nuvistor    ▶ Novar    • Miniature    ◦ Octal    ▷ Nuvistor    ▶ Novar

**Beam Power Tubes**

*Single Unit*

- |           |              |           |
|-----------|--------------|-----------|
| 3LF4      | ○ 6V6-GT     | ● 25C5    |
| ○ 3Q5-GT  | ○ 6V6-GTA    | ● 25CA5   |
| ● 5AQ5    | ○ 6W6-GT     | ○ 25L6    |
| ○ 5V6-GT  | ○ 6Y6-G      | ○ 25L6-GT |
| ● 6AQ5-A  | ○ 6Y6-GA     | ● 34GD5   |
| ● 6AS5    | 7A5          | ● 34GD5-A |
| ● 6BF5    | 7C5          | 35A5      |
| ● 6BK5    | ● 12AB5      | ● 35B5    |
| ● 6CA5    | ● 12AQ5      | ● 35C5    |
| ● 6CM6    | ● 12BK5      | ● 35GL6   |
| ● 6CU5    | ● 12CA5      | ○ 35L6-GT |
| ● 6DB5    | ● 12CU5/12CS | 50A5      |
| ○ 6DG6-GT | ● 12DB5      | ● 50B5    |
| ● 6DS5    | ● 12ED5      | ● 50C5    |
| ○ 6FE5    | ○ 12L6-GT    | ○ 50FE5   |
| ○ 6L6     | ○ 12V6-GT    | ○ 50L6-GT |
| ○ 6L6-GB  | ○ 12W6-GT    | ○ 5881    |
| ○ 6L6-GC  | ● 25BK5      | ● 6973    |
| ○ 6V6     |              | ○ 7027-A  |

*With Diode*

- |                         |            |            |
|-------------------------|------------|------------|
| ○ 70L7-GT               | ○ 117N7-GT | ○ 117P7-GT |
| ○ 117L7-GT/<br>117M7-GT |            |            |

**Pentodes**

*Single Unit*

- |          |          |         |
|----------|----------|---------|
| ○ 1A5-GT | ● 6EH5   | ● 32ET5 |
| ○ 1CS-GT | ○ 6F6    | ● 35EH5 |
| 1LB4     | ○ 6F6-G  | 41      |
| ● 1S4    | ○ 6F6-GT | 42      |
| ● 3Q4    | ○ 6G6-G  | 43      |
| ● 3S4    | ○ 6K6-GT | 47      |
| ● 3V4    | 7B5      | ● 50EH5 |
| ○ 6AG7   | ● 8BQ5   | ● 50FK5 |
| ● 6AR5   | ● 12DQ7  | ● 60FX5 |
| ● 6BQ5   | ● 12EH5  | ● 7189  |
| ● 6CL6   | ● 25EH5  | ▷ 7868  |

*Twin Unit*

- 6DZ7

*With Triode*

- 6AD7-G      ● 35DZ8

**3. CONVERTERS**

**Pentagrid**

*Single Unit*

- |          |           |            |
|----------|-----------|------------|
| ○ 1A7-GT | ○ 6A8-GT  | ● 12AD6    |
| ● 1L6    | ● 6BA7    | ● 12BA7    |
| 1LA6     | ● 6BE6    | ● 12BE6    |
| 1LC6     | ○ 6SA7    | ● 12GA6    |
| ● 1R5    | ○ 6SA7-GT | ○ 12SA7    |
| ● 3BE6   | ○ 6SB7-Y  | ○ 12SA7-GT |
| 6A7      | 7B8       | 14Q7       |
| ○ 6A8    | 7Q7       | ● 18FX6    |
| ○ 6A8-G  | ○ 12A8-GT | ● 18FX6-A  |

*With Triode*

- 12FX8

**Octode**

- 7A8

**4. MIXER-OSCILLATORS**

**Triode-Tetrodes**

- |          |          |           |
|----------|----------|-----------|
| ● 5CL8-A | ● 6CL8-A | ● 9CL8    |
| ● 5CQ8   | ● 6CQ8   | ● 19CL8-A |

**Triode-Pentodes**

- |        |          |         |
|--------|----------|---------|
| ● 5AT8 | ● 5X8    | 6F7     |
| ● 5B8  | ● 6AT8-A | ● 6U8-A |
| ● 5BE8 | ● 6BR8   | ● 6X8   |
| ● 5BR8 | ● 6BR8-A | ● 9U8-A |
| ● 5CG8 | ● 6CG8-A | ● 12EC8 |
| ● 5EA8 | ● 6EA8   | ● 19EA8 |
| ● 5EU8 | ● 6EH8   | ● 19X8  |
| ● 5U8  | ● 6EU8   |         |

**Triode-Hexodes**

- 6K8      ○ 12K8

**Triode-Heptodes**

- 7J7

**5. UHF OSCILLATORS**

**Triodes**

*Single Unit*

- |          |          |          |
|----------|----------|----------|
| ● 2AF4-A | ● 3AF4-A | ● 6AF4-A |
| ● 2AF4-B | ● 6AF4   | ● 6T4    |

**6. HF OSCILLATORS**

**Triodes**

*Single Unit*

- 6C4

*Twin Unit*

- 6J6      ● 6J6-A

**7. MIXERS**

**Twin Triodes**

- 19J6

**Pentagrid**

- 6L7

### 8. ELECTRON-RAY TUBES

#### Single Indicator

*With Triode*

- 6AB5, 6NS, 6U5, 6E5, EM84/6FG6

#### Twin Indicator

- 6AF6-G

#### Triple Indicator

- 6AL7-GT

### 9. GATED AMPLIFIERS

#### Pentode

- 6GY6

#### Pentagrid

- 3BY6, • 4CS6, • 6CS6, • 3CS6, • 6BY6

### 10. COMPLEX-WAVE GENERATORS

#### Diode—Sharp-Cutoff Twin-Plate Tetrode

- 6FA7

#### Medium-Mu Triode—Three-Plate Tetrode

- 6FH8

#### High-Mu Twin Double-Plate Triode

- 12FQ8

### 11. REGULATORS

(High-Voltage, Low-Current)

#### Beam Triode

- 6BK4

### 12. FM DETECTOR

#### Pentodes

- 3DT6, • 4DT6-A, • 6DT6-A, • 3DT6-A, • 6DT6, • 6GX6, • 4DT6

### 13. RELAY-CONTROL

#### Twin Triodes

- 6EV7

#### Tetrode (*With Triode*)

- 12DY8

### 14. TELEVISION DEFLECTION

#### Horizontal-Deflection Oscillators

##### Medium-Mu Twin Triodes

- 6CG7, • 8CG7, • 12AU7-A, • 6FQ7, • 8FQ7, • 12BH7-A, ◦ 6SN7-GTB, • 9AU7, ◦ 12SN7-GTA, • 7AU7

##### Medium-Mu Triode—Sharp-Cutoff Pentode

- 5GH8, • 6GH8

#### Horizontal-Deflection Amplifiers

##### Beam Power Tubes (*Single Unit*)

- 6AU5-GT, ▶ 6GT5, ◦ 17DQ6-B, ◦ 6AV5-GA, ◦ 6GW6, ▶ 17GJ5, ◦ 6BG6-G, ◦ 12AV5-GA, ▶ 17GT5, ◦ 6BG6-GA, ◦ 12BQ6-GTB, ◦ 17GW6, ◦ 6BQ6-GTB/, 12CU6, ◦ 18A5, 6CU6, ◦ 12DQ6-A, ◦ 19BG6-GA, ◦ 6CB5-A, ◦ 12DQ6-B, ◦ 21EX6, ◦ 6CD6-GA, ◦ 12GC6, ◦ 25AV5-GA, ◦ 6DN6, ▶ 12GJ5, ◦ 25BQ6-GTB/, ◦ 6DQ5, ▶ 12GT5, 25CU6, ◦ 6DQ6-A, ◦ 12GW6, ◦ 25CD6-GB, ◦ 6DQ6-B, ◦ 17BQ6-GTB, ◦ 25DN6, ◦ 6EX6, ◦ 17DQ6-A, ◦ 25EC6, ▶ 6GJ5

#### Vertical-Deflection

##### Oscillators and Amplifiers

##### Medium-Mu Twin Triodes

- 6BL7-GTA, • 7AU7, • 12BH7-A, ◦ 6BX7-GT, • 9AU7, ◦ 12SN7-GTA, ◦ 6SN7-GTB, • 12AU7-A

##### Medium-Mu Dual Triodes

- 6CM7, ◦ 6DN7, • 8CM7, • 6CS7

##### Medium-Mu Triode—Low-Mu Triode

- 6DE7, • 10DE7, 10EW7, 6EW7, • 10EG7, • 13DE7

##### High-Mu Triode—Low-Mu Triode

- 6CY7, ◦ 6EM7, • 11CY7, • 6DR7, • 10DR7, • 13DR7, • 6EA7, ◦ 10EM7, ◦ 13EM7

##### Hi-Mu Triode—Sharp-Cutoff Pentode

- 10C8

#### Vertical-Deflection Oscillators

##### Triode With Pentode

- 5FV8, • 6FV8

• Miniature   ◦ Octal   ▶ Nuvistor   ▶ Novar   • Miniature   ◦ Octal   ▶ Nuvistor   ▶ Novar



# RCA Tube Types—Technical Data

This section contains technical descriptions of RCA tubes used in standard broadcast, FM, and television receivers, in audio amplifiers, and in many other diverse applications. It includes data on current types, as well as information on those RCA discontinued types in which there may still be some interest. *Unless specified otherwise*, the ratings given are based on the **Design Center** system. Information on picture tubes is shown at the end of this section.

In choosing tube types for the design of new electronic equipment, the designer should refer to the inside back cover for a listing of **RCA Tube Types Not Recommended for New Equipment Design**.

Tube types are listed in this section according to the numerical-alphabetical-numerical sequence of their type designations. For **Key: Basing Diagrams**, see inside front cover.

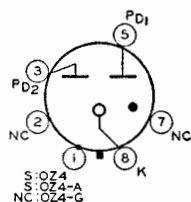

## FULL-WAVE GAS RECTIFIER

Metal types OZ4 and OZ4-A and glass octal type OZ4-G are used in vibrator-type B-supply units. Both have ionically heated cathodes, require octal sockets, and may be mounted in any position. OZ4 and OZ4-A, Outline 2, **OUTLINES SECTION**. OZ4-G dimensions: maximum overall length, 2-5/8 inches; maximum diameter, 1-1/16 inches; T-7 bulb; dwarf-shell octal 5-pin base. Base of OZ4-G has no pin No. 2. Shell of OZ4

**OZ4**  
**OZ4-A**  
**OZ4-G**

and OZ4-A and external shield of OZ4-G should be grounded. Filters may be necessary to eliminate objectionable noise. Ratings for full-wave rectifier service: **OZ4 and OZ4-G**, peak starting supply volts (per plate), 300 *min*; peak inverse plate voltage (per plate), 880 *max*; dc output ma. (per plate), 270 *max*; dc output ma., 90 *max*, 30 *min*; dc output volts, 275; tube voltage drop for plate ma. = 90 (per plate), 24 volts. For **OZ4-A**, peak starting supply volts (per plate), 300 *min*; peak inverse plate voltage (per plate), 880 *max*; peak plate ma. (per plate), 330 *max*; dc output ma., 110 *max*, 30 *min*; dc output volts, 310 *max*; tube voltage drop for plate ma. = 110 (per plate), 24 volts. These types are used principally for renewal purposes.

## DIODE

Miniature type used as detector tube in portable FM receivers and in portable high-frequency measuring equipment. Outline 11, **OUTLINES SECTION**. Tube requires miniature seven-contact socket. Heater volts (ac/dc) 1.4; amperes, 0.15.

**1A3**

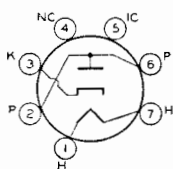

### Maximum Ratings:

	330 <i>max</i>	volts
PEAK INVERSE PLATE VOLTAGE.....	5 <i>max</i>	ma
PEAK PLATE CURRENT.....	0.5 <i>max</i>	ma
DC OUTPUT CURRENT.....	140 <i>max</i>	volts
PEAK HEATER-CATHODE VOLTAGE.....		

### HALF-WAVE RECTIFIER

### Typical Operation (With Capacitor-Input Filter):

AC Plate-Supply Voltage (rms).....	117	volts
Filter-Input Capacitor.....	2	$\mu$ f
Minimum Total Effective Plate-Supply Impedance.....	0	ohms

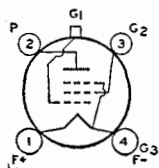

## REMOTE-CUTOFF PENTODE

Glass type used in battery-operated receivers as rf or if amplifier. This type is similar electrically to type 1D5-GP. Outline 40, **OUTLINES SECTION**. Tube requires four-contact socket. Filament volts (dc), 2.0; amperes, 0.06. Type 1A4-P is a **DISCONTINUED** type listed for reference only.

**1A4-P**

**POWER PENTODE**

**1A5-GT**

Glass octal type used in output stage of battery-operated receivers. Outline 22, OUTLINES SECTION. This type may be supplied with pin No.1 omitted. Tube requires octal socket and may be mounted in any position. For filament considerations, refer to type 1U4. Filament volts (dc), 1.4; amperes, 0.05. Typical operation as class A<sub>1</sub> amplifier: plate and grid-No.2 volts, 90 (110 *max*); grid-No.1 volts, -4.5; peak af grid-

No.1 volts, 4.6; plate ma., 4.0; grid-No.2 ma., 1.1; plate resistance (approx.), 0.3 megohm; transconductance, 850  $\mu$ mhos; load resistance, 25000 ohms; power output, 115 milliwatts. Type 1A5-GT is used principally for renewal purposes.

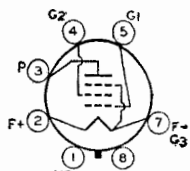

**PENTAGRID CONVERTER**

**1A6**

Glass type used in battery-operated receivers. This type is identical electrically with type 1D7-G, except for interelectrode capacitances. Outline 40, OUTLINES SECTION. Tube requires six-contact socket. Filament volts (dc), 2.0; amperes, 0.06. Type 1A6 is a DISCONTINUED type listed for reference only.

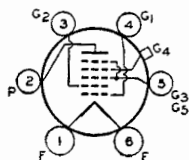

**PENTAGRID CONVERTER**

**1A7-GT**

Glass octal type used in superheterodyne circuits having battery power supplies. Outline 23, OUTLINES SECTION. Tube requires octal socket and may be mounted in any position. Filament volts (dc), 1.4; amperes, 0.05. Typical operation as converter: plate and grid-No.2 volts, 90 (110 *max*); grids-No.3-and-No.5 supply volts, 110 *max*; grids-No.3-and-No.5 volts, 45 (60 *max*); grid-No.4 volts, 0; grid-No.1 resistor, 0.2 meg-

ohm; plate resistance (approx.), 0.6 megohm; plate ma., 0.6; grids-No.3-and-No.5 ma., 0.7; grid-No.2 ma., 1.2; grid-No.1 ma., 0.035; total cathode ma., 2.5 (4 *max*); conversion transconductance, 250  $\mu$ mhos. This type is used principally for renewal purposes.

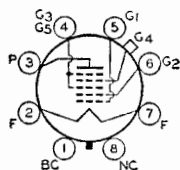

**POWER PENTODE**

**1AC5**

Subminiature type used in output stage of small, compact, battery-operated receivers for the standard AM broadcast band. Outline 8, OUTLINES SECTION. Tube requires subminiature eight-contact socket. Filament volts (dc), 1.25; amperes, 0.04. Filament voltage should never exceed 1.6 volts. Typical operation as Class A<sub>1</sub> amplifier: plate and grid-No.2 volts, 67.5 *max*; grid-No.1 volts, -4.5; peak af grid-

No.1 volts, 4.5; zero-signal plate ma., 2; zero-signal grid-No.2 ma., 0.4; cathode ma., 4 *max*; plate resistance, 0.15 megohm; transconductance, 750  $\mu$ mhos; load resistance, 25000 ohms; total harmonic distortion, 10 per cent; maximum-signal power output, 50 milliwatts. This is a DISCONTINUED type listed for reference only.

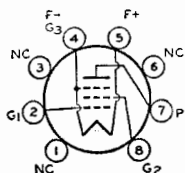

**SHARP-CUTOFF PENTODE**

**1AD5**

Subminiature type used as rf or if amplifier in stages not controlled by avc in small, compact, battery-operated receivers for the standard AM broadcast band. Outline 8, OUTLINES SECTION. Tube requires subminiature eight-contact socket. Filament volts (dc), 1.25; amperes, 0.04. Filament voltage should never exceed 1.6 volts. Characteristics as class A<sub>1</sub> amplifier: plate and grid-No.2 volts, 67.5 *max*;

grid-No.1 volts, 0; plate resistance, 0.7 megohm; transconductance, 735  $\mu$ mhos; total cathode ma., 4 *max*; plate ma., 1.85; grid-No.2 ma., 0.75. This is a DISCONTINUED type listed for reference only.

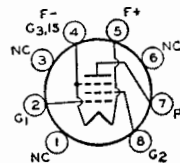



### HALF-WAVE VACUUM RECTIFIER

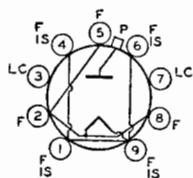

Miniature type used as rectifier of high-voltage pulses produced in the scanning systems of television receivers. Outline 17, OUTLINES SECTION. Tube requires miniature nine-contact socket. Socket terminals 3 and 7 may be connected to the filament, or used as tie points for the filament-dropping resistor; otherwise they should not be used. Filament volts (ac), 1.4; amperes, 0.65. Maximum ratings as pulsed rectifier in 525-line, 30-frame system: peak inverse plate volts (*absolute maximum*), 25000 *max* (dc 20000 *max*); peak plate ma., 45 *max*; average plate ma., 0.5 *max*. For filament and high-voltage considerations, refer to type 1B3-GT. Type 1AX2 is used principally for renewal purposes.

## 1AX2

rectifier in 525-line, 30-frame system: peak inverse plate volts (*absolute maximum*), 25000 *max* (dc 20000 *max*); peak plate ma., 45 *max*; average plate ma., 0.5 *max*. For filament and high-voltage considerations, refer to type 1B3-GT. Type 1AX2 is used principally for renewal purposes.

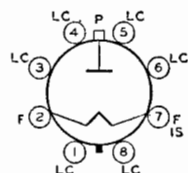

### HALF-WAVE VACUUM RECTIFIER

Glass octal type used in high-voltage, low-current applications such as the rectifier in a high-voltage, rf-operated power supply or as a rectifier of high-voltage pulses produced in television scanning systems. For curve of average plate characteristics, see page 67.

## 1B3-GT

scanning systems. For curve of average plate characteristics, see page 67.

FILAMENT VOLTAGE (AC/DC) .....	1.25*	volts
FILAMENT CURRENT .....	0.2	ampere
DIRECT INTERELECTRODE CAPACITANCE (Approx.):		
Plate to Filament and Internal Shield .....	1.3	$\mu$ f

\* Under no circumstances should the filament voltage be less than 1.05 volts or greater than 1.45 volts.

#### PULSED RECTIFIER

*For operation in a 525-line, 30-frame system*

Maximum Ratings, (Design-Maximum Values):

PEAK INVERSE PLATE VOLTAGE* .....	26000* <i>max</i>	volts
PEAK PLATE CURRENT .....	50 <i>max</i>	ma
AVERAGE PLATE CURRENT .....	0.5 <i>max</i>	ma

#### RADIO-FREQUENCY RECTIFIER

Maximum Ratings, (Design-Maximum Values):

PEAK INVERSE PLATE VOLTAGE .....	33000 <i>max</i>	volts
PEAK PLATE CURRENT .....	35 <i>max</i>	ma
AVERAGE PLATE CURRENT .....	1.1 <i>max</i>	ma
FREQUENCY RANGE OF SUPPLY VOLTAGE .....	1.5 to 100	Kc

\* The duration of the voltage pulse must not exceed 15 per cent of one horizontal scanning cycle. In a 525-line, 30-frame system, 15 per cent of one horizontal scanning cycle is 10 microseconds.

\* The dc component must not exceed 22000 volts.

### INSTALLATION AND APPLICATION

Type 1B3-GT requires an octal socket and may be mounted in any position. Plate connection is cap at top of bulb. Socket terminals 1, 3, 4, 5, 6, and 8 may be connected to socket terminal 7 or to a corona shield which is connected to socket terminal 7. Socket terminals 4 and 6 may be used as tie points for components at or near filament potential. This type may be supplied with pins 1, 4, and/or 6 omitted. Outline 32, OUTLINES SECTION.

The high voltages at which the 1B3-GT is operated are very dangerous. Great care should be taken to prevent coming in contact with these high voltages. In those circuits where the filament circuit is not grounded, the filament circuit operates at dc potentials which can cause fatal shock. Extreme precautions must be taken when the filament voltage is measured. These precautions must include safeguards which definitely eliminate all hazards to personnel. The filament transformer, whether it is of the iron-core or the air-core type, must be sufficiently insulated.

The voltages employed in some television receivers and other high-voltage equipment may be sufficiently high to cause high-voltage rectifier tubes such as the 1B3-GT to produce soft X-rays which can constitute a health hazard unless the tubes are adequately shielded. Relatively simple shielding should prove adequate, but the need for this precaution should be considered.

**SHARP-CUTOFF PENTODE**

**1B4-P**

Glass type used as rf amplifier or detector in battery-operated receivers. Outline 40, OUTLINES SECTION. Tube requires four-contact socket. For typical operating conditions and maximum ratings as a class A<sub>1</sub> amplifier, refer to type 1E5-GP. Filament volts (dc), 2.0; amperes, 0.06. Type 1B4-P is a DISCONTINUED type listed for reference only.

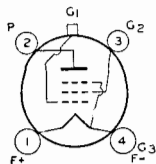

**TWIN DIODE—MEDIUM-MU TRIODE**

**1B5/25S**

Glass type used as combined detector, amplifier, and avc tube in battery-operated receivers. Outline 34 or 35, OUTLINES SECTION. Tube requires six-contact socket. Filament volts (dc), 2.0 amperes, 0.06. Typical operation as class A<sub>1</sub> amplifier: plate volts, 135 max; grid volts, -3; plate ma., 0.8; plate resistance, 35000 ohms; amplification factor, 20; transconductance, 575 μmhos. This is a DISCONTINUED type listed for reference only.

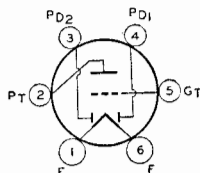

**PENTAGRID CONVERTER**

**1B7-GT**

Glass octal type used in superheterodyne circuits having battery power supply. Outline 23, OUTLINES SECTION. Filament volts (dc), 1.4; amperes, 0.1. This is a DISCONTINUED type listed for reference only. The 1B7-GT may be replaced by the 1A7-GT if circuit adjustment is made for lower filament current of type 1A7-GT.

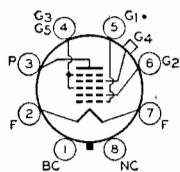

**POWER PENTODE**

**1C5-GT**

Glass octal type used in output stage of battery-operated receivers. Outline 22, OUTLINES SECTION. This type may be supplied with pin No.1 omitted. Tube requires octal socket. Filament volts (dc), 1.4; amperes, 0.1. Typical operation as class A<sub>1</sub> amplifier: plate and grid-No.2 volts, 90 (110 max); grid-No.1 volts, -7.5; peak af grid-No.1 volts, 7.5; plate ma., 7.8; grid-No.2 ma., 3.5; plate resistance (approx.), 115000 ohms; transconductance, 1550 μmhos; load resistance, 8000 ohms; power output, 240 milliwatts. Type 1C5-GT is used principally for renewal purposes.

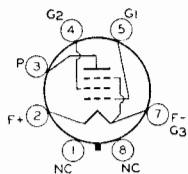

**PENTAGRID CONVERTER**

**1C6**

Glass type used in battery-operated receivers. Similar electrically to type 1C7-G except for interelectrode capacitances. Outline 40, OUTLINES SECTION. Tube requires six-contact socket. Filament volts (dc), 2.0; amperes, 0.12. Type 1C6 is a DISCONTINUED type listed for reference only.

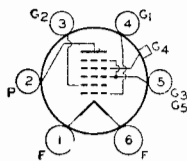

**PENTAGRID CONVERTER**

**1C7-G**

Glass octal type used in battery-operated receivers. Outline 39, OUTLINES SECTION. Tube requires octal socket. Filament volts (dc), 2.0; amperes, 0.12. Typical operation as converter: plate volts, 180 max; grids-No.3-and-No.5 (screen-grid) volts, 67.5 max; grid-No.2 (anode-grid) supply volts, 180 (applied through 20000-ohm dropping resistor bypassed by 0.01-μf capacitor); grid-No.4 (control-grid) volts, -3; grid-No.1 (oscillator-grid) resistor, 50000 ohms; plate ma., 1.5; grids-No.3-and-No.5 ma., 2; grid-No.2 ma., 4; grid-No.1 ma., 0.2. This is a DISCONTINUED type listed for reference only.

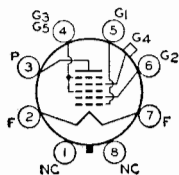

### REMOTE-CUTOFF PENTODE

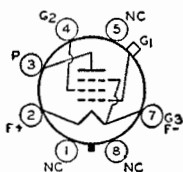

Glass octal type used in battery-operated receivers as rf or if amplifier. Outline 39, OUTLINES SECTION. Tube requires octal socket. Filament volts (dc), 2.0; amperes, 0.06. Typical operation as class A<sub>1</sub> amplifier: plate volts, 180 *max*; grid-No.2 (screen-grid) volts, 67.5 *max*; grid-No.1 volts, -3 *min*; plate ma., 2.3; grid-No.2 ma., 0.8; plate resistance (approx.), 1.0 megohm; transconductance, 750  $\mu$ mhos; transconductance at bias of -15 volts, 15  $\mu$ mhos. This is a DISCONTINUED type listed for reference only.

**1D5-GP**

### REMOTE-CUTOFF TETRODE

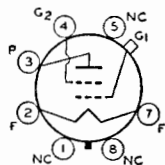

Glass octal type used in battery-operated receivers as rf or if amplifier. Outline 39, OUTLINES SECTION. Filament volts (dc), 2.0; amperes, 0.06. This is a DISCONTINUED type listed for reference only. It is similar electrically to type 1D5-GP.

**1D5-GT**

### PENTAGRID CONVERTER

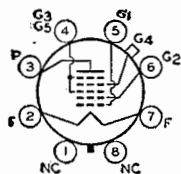

Glass octal type used in battery-operated receivers. Outline 39, OUTLINES SECTION. Tube requires octal socket. Filament volts (dc), 2.0; amperes, 0.06. Typical operation as converter: plate volts, grids-No.3-and-No.5 volts, grid-No.2 supply volts, grid-No.4 volts, and grid-No.1 resistor are same as for type 1C7-G; plate ma., 1.3; grids-No.3-and-No.5 ma., 2.4; grid-No.2 ma., 2.8; grid-No.1 ma., 0.2. This is a DISCONTINUED type listed for reference only.

**1D7-G**

### DIODE—TRIODE—POWER PENTODE

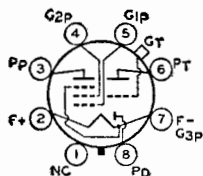

Glass octal type used in compact battery-operated receivers. Diode unit is used as detector or avc tube, triode as first audio amplifier, and pentode as power output tube. Outline 21, OUTLINES SECTION. Tube requires octal socket. Filament volts (dc), 1.4; amperes, 0.1. Typical operation of pentode unit as class A<sub>1</sub> amplifier: plate and grid-No.2 volts, 90 (110 *max*); grid-No.1 volts, -9; plate ma., 5; grid-No.2 ma., 1; transconductance, 925  $\mu$ mhos; load resistance, 12000 ohms; total harmonic distortion, 10 per cent; power output, 200 milliwatts. Characteristics of triode unit as class A<sub>1</sub> amplifier: plate volts, 90 (110 *max*); grid volts, 0; amplification factor, 25; plate resistance (approx.), 43500 ohms; transconductance, 575  $\mu$ mhos; plate ma., 1.1. This is a DISCONTINUED type listed for reference only.

**1D8-GT**

### DIODE— SEMIREMOTE-CUTOFF PENTODE

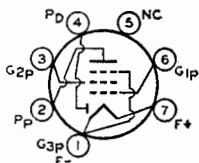

Miniature type used in battery-operated portable radio receivers as combined AM detector and af voltage amplifier. Outline 11, OUTLINES SECTION. Tube requires miniature seven-contact socket and may be mounted in any position. Filament volts (dc), 1.4; amperes, 0.05. This type is used principally for renewal purposes.

**1DN5**

**Maximum Ratings:**

PLATE VOLTAGE.....	90 <i>max</i>	volts
GRID-No.2 (SCREEN-GRID) VOLTAGE.....	90 <i>max</i>	volts
GRID-No.1 (CONTROL-GRID) VOLTAGE:		
Negative bias value.....	-50 <i>max</i>	volts
Positive bias value.....	0 <i>max</i>	volts
CATHODE CURRENT.....	3 <i>max</i>	ma

**PENTODE UNIT AS CLASS A<sub>1</sub> AMPLIFIER**

90 <i>max</i>	volts
90 <i>max</i>	volts
-50 <i>max</i>	volts
0 <i>max</i>	volts
3 <i>max</i>	ma

**Characteristics:**

Plate Voltage .....	67.5	volts
Grid-No.2 Voltage .....	67.5	volts
Grid-No.1 Voltage .....	0	volts
Plate Resistance (Approx.) .....	0.6	megohm
Transconductance .....	630	$\mu$ mhos
Grid-No.1 Voltage (Approx.) for transconductance of 10 $\mu$ mhos. ....	-11.5	volts
Plate Current .....	2.1	ma
Grid-No.2 Current .....	0.55	ma

**Maximum Circuit Value:**

Grid-No.1-Circuit Resistance .....	3.3	megohms
------------------------------------	-----	---------

**Maximum Rating:**

**DIODE UNIT**

PLATE CURRENT .....	0.25	max	ma
---------------------	------	-----	----

**SHARP-CUTOFF PENTODE**

Glass octal type used as rf amplifier or detector in battery-operated receivers. Outline 39, OUTLINES SECTION. Tube requires octal socket. Filament volts (dc), 2.0; amperes, 0.06. Characteristics as class A<sub>1</sub> amplifier: plate volts, 180 *max*; grid-No.2 volts, 67.5 *max*; grid-No.1 volts, -3; plate ma., 1.7; grid-No.2 ma., 0.6; plate resistance, 1.5 megohms; transconductance, 650  $\mu$ mhos. This is a DISCONTINUED type listed for reference only.

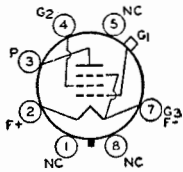

**1E5-GP**

**TWIN POWER PENTODE**

Glass octal type used in push-pull output stage of battery-operated receivers. Outline 22, OUTLINES SECTION. Tube requires octal socket. Filament volts (dc), 2.0; amperes, 0.24. Typical operation as push-pull class A<sub>1</sub> amplifier: plate and grid-No.2 volts, 135 *max*; grid-No.1 volts, -7.5; plate ma., 10.5; grid-No.2 ma., 3.5; output watts, 0.575. This is a DISCONTINUED type listed for reference only.

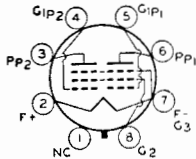

**1E7-GT**

**PENTAGRID CONVERTER**

Subminiature type used in small, compact, battery-operated receivers for the standard AM broadcast band. Outline 8, OUTLINES SECTION. Tube requires subminiature eight-contact socket. Filament volts (dc), 1.25; amperes, 0.04. Typical operation as converter: plate volts and grids-No.2-and-No.4 supply volts, 67.5 *max*; grids-No.2-and-No.4 resistor, 20000 ohms; grid-No.3 volts, 0; grid-No.1 resistor, 0.1 megohm;

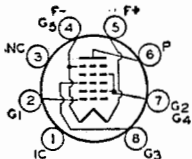

**1E8**

plate resistance (approx.), 0.4 megohm; conversion transconductance, 150  $\mu$ mhos; total cathode ma., 2.5 (4 *max*); plate ma., 1; grids-No.2-and-No.4 ma., 1.5; grid-No.1  $\mu$ a., 70. This is a DISCONTINUED type listed for reference only.

**POWER PENTODE**

Glass type used in output stage of battery-operated receivers. Outline 43, OUTLINES SECTION. Tube requires five-contact socket. Filament volts (dc), 2.0; amperes, 0.12. Type 1F4 is similar electrically to type 1F5-G. Type 1F4 is a DISCONTINUED type listed for reference only.

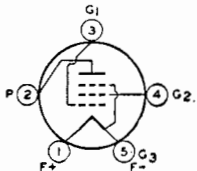

**1F4**

**POWER PENTODE**

Glass octal type used in output stage of battery-operated receivers. Outline 42, OUTLINES SECTION. Tube requires octal socket. Filament volts (dc), 2.0; amperes, 0.12. Typical operation as class A<sub>1</sub> amplifier: plate and grid-No.2 (screen-grid) volts, 135 (180 *max*); grid-No.1 volts, -4.5; plate ma., 8; grid-No.2 ma., 2.4; cathode resistor, 432 ohms; output watts, 0.31. This is a DISCONTINUED type listed for reference only.

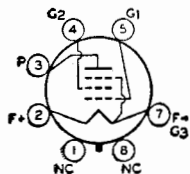

**1F5-G**

**TWIN DIODE—  
SHARP-CUTOFF PENTODE**

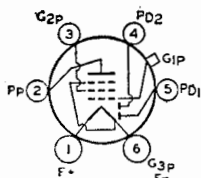

Glass type used as combined detector, amplifier, and avc tube in battery-operated receivers. Outline 39, OUTLINES SECTION. Tube requires six-contact socket. Filament volts (dc), 2.0; amperes, 0.06. Typical operation of pentode unit as class A<sub>1</sub> amplifier: plate volts, 180 *max*; grid-No.2 (screen-grid) volts, 67.5 *max*; grid-No.1 volts, -1.5; plate ma., 2.2; grid-No.2 ma., 0.7. This is a DISCONTINUED type listed for reference only.

1F6

**TWIN DIODE—  
SHARP-CUTOFF PENTODE**

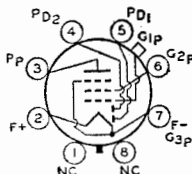

Glass octal type used as combined detector, amplifier, and avc tube in battery-operated receivers. Outline 39, OUTLINES SECTION. Tube requires octal socket. Filament volts (dc), 2.0; amperes, 0.06. Similar electrically to type 1F6 except for interelectrode capacitances. Type 1F7-G is a DISCONTINUED type listed for reference only.

1F7-G

**HALF-WAVE VACUUM RECTIFIER**

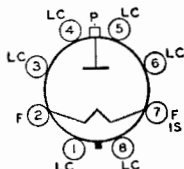

Glass octal type used in high-voltage, low-current applications such as the rectifier in a high-voltage, rf-operated power supply or as a rectifier of high-voltage pulses produced in television scanning systems. Outline 28, OUTLINES SECTION. This type may be supplied with pins 1, 4, and/or 6 omitted. Tube requires octal socket and may be mounted in any position. Except for physical dimensions, this type is identical with glass octal type 1B3-GT.

1G3-GT/  
1B3-GT

**MEDIUM-MU TRIODE**

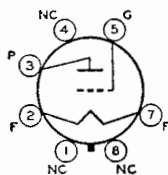

Glass octal type used in battery-operated receivers as detector or voltage amplifier. Outline 22, OUTLINES SECTION. Tube requires octal socket. Filament volts (dc), 1.4; amperes, 0.05. Typical operation and characteristics as class A<sub>1</sub> amplifier: plate volts, 90 (100 *max*); grid volts, -6; plate ma., 2.3; plate resistance, 10700 ohms; amplification factor, 8.8; transconductance, 825  $\mu$ mos. This is a DISCONTINUED type listed for reference only.

1G4-GT

**POWER PENTODE**

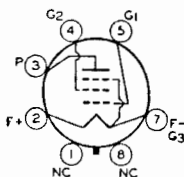

Glass octal type used in output stage of battery-operated receivers. Outline 42, OUTLINES SECTION. Tube requires octal socket. Filament volts (dc), 2.0; amperes, 0.12. Typical operation as class A<sub>1</sub> amplifier: plate and grid-No.2 (screen-grid) volts, 135 *max*; grid-No.1 volts, -13.5; plate ma., 9.7; output watts, 0.55. This is a DISCONTINUED type listed for reference only.

1G5-G

**HIGH-MU TWIN POWER TRIODE**

Glass octal type used in output stage of battery-operated receivers. Outline 22, OUTLINES SECTION. Tube requires octal socket. Filament volts (dc), 1.4; amperes, 0.1. Typical operation as class B amplifier: plate volts, 90 (110 max); dc grid volts, 0; peak af grid-to-grid volts, 48; effective grid-circuit impedance per unit, 2530 ohms; plate ma. (zero signal), 2, (maximum signal), 11; peak grid ma. per unit, 6; output watts (approx.), 0.35. This is a DISCONTINUED type listed for reference only.

1G6-GT

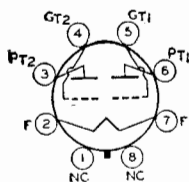

**MEDIUM-MU TRIODE**

Glass octal type used as detector or voltage amplifier in battery-operated receivers. Outline 36, OUTLINES SECTION. Tube requires octal socket. Filament volts (dc), 2.0; amperes, 0.06. Typical operation as class A<sub>1</sub> amplifier: plate volts, 180 max; grid volts, -13.5; amplification factor, 9.3; plate resistance, 10300 ohms; transconductance, 900 μmhos; plate ma., 3.1. This is a DISCONTINUED type listed for reference only.

1H4-G

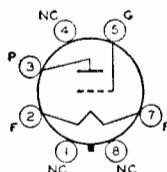

**DIODE—HIGH-MU TRIODE**

Glass octal type used as combined detector and amplifier in battery-operated receivers. Outline 23, OUTLINES SECTION. Tube requires octal socket. Filament volts (dc), 1.4; amperes, 0.05. Characteristics of triode unit as class A<sub>1</sub> amplifier: plate volts, 90 (110 max); grid volts, 0; plate ma., 0.15; plate resistance (approx.), 24000 ohms; amplification factor, 65; transconductance, 275 μmhos. Diode is located at negative end of filament. This type is used principally for renewal purposes.

1H5-GT

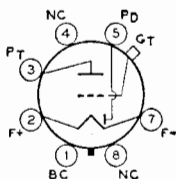

**TWIN DIODE—MEDIUM-MU TRIODE**

Glass octal type used as combined detector, amplifier, and avc tube in battery-operated receivers. Outline 36, OUTLINES SECTION. Tube requires octal socket. Filament volts (dc) 2.0; amperes, 0.06. Type 1H6-G is similar electrically to type 1B5/25S. Type 1H6-G is a DISCONTINUED type listed for reference only.

1H6-G

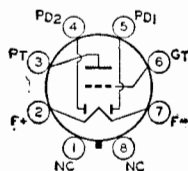

**HALF-WAVE VACUUM RECTIFIER**

Glass octal type used as a rectifier of high-voltage pulses produced in the scanning systems of black-and-white television receivers. Outline 32, OUTLINES SECTION. Except for

1J3

physical dimensions, this type is identical with glass octal type 1K3.

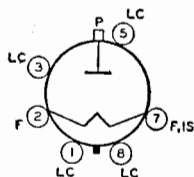

**POWER PENTODE**

Glass octal type used in output stage of battery-operated receivers. Outline 42, OUTLINES SECTION. Tube requires octal socket. Filament volts (dc), 2.0; amperes, 0.12. Typical operation as class A<sub>1</sub> amplifier: plate and grid-No.2 (screen-grid) volts, 135 max; grid-No.1 volts, -16.5; plate ma., 7.0; grid-No.2 ma., 2.0; plate resistance, 105000 ohms; load resistance, 13500 ohms; output watts, 0.45. This is a DISCONTINUED type listed for reference only.

1J5-G

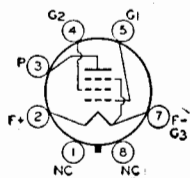

### HIGH-MU TWIN POWER TRIODE

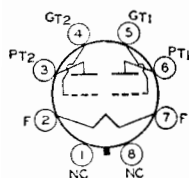

Glass octal types used in output stage of battery-operated receivers. Type 1J6-G, Outline 36; type 1J6-GT, Outline 26, OUTLINES SECTION. Tubes require octal socket. Filament volts (dc), 2.0; amperes, 0.24. Typical operation as class B power amplifier: plate volts, 135 *max*; peak plate ma. per plate, 50 *max*; grid volts, 0; zero-signal plate ma. per plate, 5; effective plate-to-plate load resistance, 10000

**1J6-G**  
**1J6-GT**

ohms; average input watts, 0.17; output watts, 2.1. These are DISCONTINUED types listed for reference only.

### HALF-WAVE VACUUM RECTIFIER

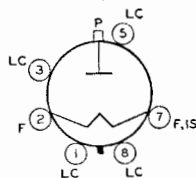

Glass octal type used as a rectifier of high-voltage pulses produced in the scanning systems of black-and-white television receivers. For curve of average plate characteristics, see page 67.

**1K3**

FILAMENT VOLTAGE (AC/DC)	1.25*	volts
FILAMENT CURRENT	0.2	ampere
DIRECT INTERELECTRODE CAPACITANCE (Approx.):		
Plate to Filament and Internal Shield	1.6	$\mu$ f

\* Under no circumstances should the filament voltage be less than 1.05 volts or greater than 1.45 volts.

### PULSED RECTIFIER

For operation in a 525-line, 30-frame system

Maximum Ratings, (Design-Maximum Values):

PEAK INVERSE PLATE VOLTAGE*	26000 • <i>max</i>	volts
PEAK PLATE CURRENT	50 <i>max</i>	ma
AVERAGE PLATE CURRENT	0.5 <i>max</i>	ma

\*The duration of the voltage pulse must not exceed 15 per cent of one horizontal scanning cycle. In a 525-line, 30-frame system, 15 per cent of one horizontal scanning cycle is 10 microseconds.

• The dc component must not exceed 22000 volts.

### INSTALLATION AND APPLICATION

Type 1K3 requires an octal socket and may be mounted in any position. Plate connection is cap at top of bulb. Socket terminals 1, 3, 4, 5, 6, and 8 may be connected to socket terminal 7 or to a corona shield which is connected to socket terminal 7. Socket terminals 4 and 6 may be used as tie points for components at or near filament potential. Outline 28, OUTLINES SECTION. For high-voltage considerations, see type 1B3-GT.

### PENTAGRID CONVERTER

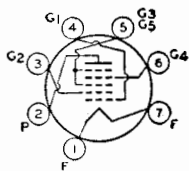

Miniature type used in low-drain battery-operated receivers. Outline 11, OUTLINES SECTION. Tube requires miniature seven-contact socket and may be mounted in any position. Filament volts (dc), 1.4; amperes, 0.05. Typical operation as converter: plate and grid-No.2 volts, 90 (110 *max*); grids-No.3-and-No.5 supply volts, 110 *max*; grids-No.3-and-No.5 volts, 45 (65 *max*); grid-No.4 volts, 0; grid-No.1

**1L6**

resistor, 0.2 megohm; plate resistance (approx.), 0.65 megohm; plate ma., 0.5; grids-No.3-and-No.5 ma., 0.6; grid-No.2 ma., 1.2; grid-No.1 ma., 0.035; total cathode ma., 2.35 (4 *max*); conversion transconductance, 300  $\mu$ mhos. This type is used principally for renewal purposes.

### POWER PENTODE

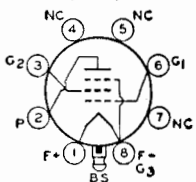

Glass lock-in type used in output stage of battery-operated receivers. Outline 15, OUTLINES SECTION. Tube requires lock-in socket. Filament volts (dc), 1.4; amperes, 0.05. For electrical characteristics and typical operation, refer to glass-octal type 1A5-GT. Type 1LA4 is a DISCONTINUED type listed for reference only.

**1LA4**

1LA6

**PENTAGRID CONVERTER**

Glass lock-in type used in battery-operated receivers. Outline 15, OUTLINES SECTION. Tube requires lock-in socket. Filament volts (dc), 1.4; amperes, 0.05. Typical operation as converter is the same as for type 1A7-GT except that grid-No.2 volts is 65 *max*, total cathode ma. is 4.0 *max*, plate resistance is 0.75 megohm, and conversion transconductance for a grid-No.4 bias of -3 volts is 10  $\mu$ mhos. This type is used principally for renewal purposes.

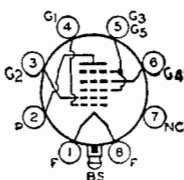

1LB4

**POWER PENTODE**

Glass lock-in type used in output stage of battery-operated receivers. Outline 15, OUTLINES SECTION. Tube requires lock-in socket. Filament volts (dc), 1.4; amperes, 0.05. For electrical characteristics, refer to pentode unit of glass-octal type 1D8-GT. Type 1LB4 is used principally for renewal purposes.

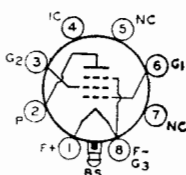

1LC5

**SHARP-CUTOFF PENTODE**

Glass lock-in type used as rf or if amplifier in battery-operated receivers. Outline 15, OUTLINES SECTION. Tube requires lock-in socket. Filament volts (dc), 1.4; amperes, 0.05. Typical operation as class A<sub>1</sub> amplifier: plate volts, 90 (110 *max*); grid-No.2 (screen-grid) volts, 45 *max*; grid-No.1 volts, 0; plate resistance (approx.), greater than 1 megohm; transconductance, 775  $\mu$ mhos; plate ma., 1.15; grid-No.2 ma., 0.3. This is a DISCONTINUED type listed for reference only.

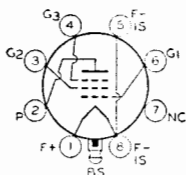

1LC6

**PENTAGRID CONVERTER**

Glass lock-in type used in battery-operated receivers. Outline 15, OUTLINES SECTION. Tube requires lock-in socket. Filament volts (dc), 1.4; amperes, 0.05. Typical operation as converter: plate volts, 90 (110 *max*); grids-No.3-and-No.5 volts, 35 (45 *max*); grid-No.2 volts, 45; grid-No.1 volts, 0; plate resistance, 0.65 megohm; plate ma., 0.75; grids-No.3-and-No.5 ma., 0.70; grid-No.2 ma., 1.4; total cathode ma., 2.9; conversion transconductance (zero bias), 275  $\mu$ mhos. This type is used principally for renewal purposes.

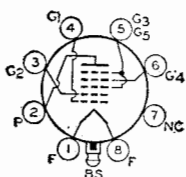

1LD5

**DIODE—SHARP-CUTOFF PENTODE**

Glass lock-in type used as combined detector and af voltage amplifier in battery-operated receivers. Outline 15, OUTLINES SECTION. Tube requires lock-in socket. Filament volts (dc), 1.4; amperes, 0.05. Characteristics of pentode unit: plate volts, 90 (110 *max*); grid-No.2 volts, 45; grid-No.1 volts, 0; plate ma., 0.6; grid-No.2 ma., 0.1; plate resistance, 0.75 megohm; transconductance, 575  $\mu$ mhos. This type is used principally for renewal purposes.

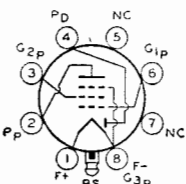

1LE3

**MEDIUM-MU TRIODE**

Glass lock-in type used as detector or voltage amplifier in battery-operated receivers. Outline 15, OUTLINES SECTION. Tube requires lock-in socket. Filament volts (dc), 1.4; amperes, 0.05. Typical operation as class A<sub>1</sub> amplifier: plate volts, 90 (110 *max*); grid volts, -3; plate ma., 1.4; plate resistance, 19000 ohms; transconductance, 760  $\mu$ mhos; amplification factor, 14.5. This type is used principally for renewal purposes.

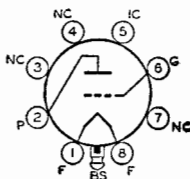



### REMOTE-CUTOFF PENTODE

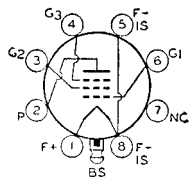

Lock-in type used as rf or if amplifier in battery-operated receivers. Outline 15, OUTLINES SECTION. Tube requires lock-in socket. Filament volts (dc), 1.4; amperes, 0.05. Typical operation as class A<sub>1</sub> amplifier: plate volts, 90 (110 max); grid-No.2 volts, 45 (110 max); grid-No.1 volts, 0; plate resistance (approx.), greater than 1 megohm; transconductance, 800 μmhos; plate ma., 1.7; grid-No.2 ma., 0.4. This type is used principally for renewal purposes.

1L65

### DIODE—HIGH-MU TRIODE

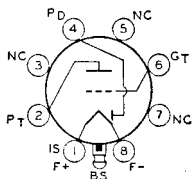

Glass lock-in type used as combined detector and amplifier in battery-operated receivers. Outline 15, OUTLINES SECTION. Tube requires lock-in socket. Filament volts (dc), 1.4; amperes, 0.05. For electrical characteristics, refer to glass-octal type 1H5-GT. Type 1LH4 is used principally for renewal purposes.

1LH4

### SHARP-CUTOFF PENTODE

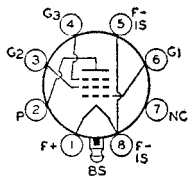

Glass lock-in type used as rf or if amplifier in battery-operated receivers. Outline 15, OUTLINES SECTION. Tube requires lock-in socket. Filament volts (dc), 1.4; amperes, 0.05. Typical operation as class A<sub>1</sub> amplifier: plate and grid-No.2 (screen-grid) volts, 90 (110 max); grid-No.1 volts, 0; plate ma., 1.6; grid-No.2 ma., 0.35; plate resistance (approx.), 1.1 megohms; transconductance, 800 μmhos. This type is used principally for renewal purposes.

1LN5

### HALF-WAVE VACUUM RECTIFIER

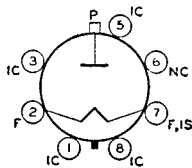

Glass octal type used as high-voltage rectifier in television receivers. Maximum over-all length, 3.9/16 inches; maximum seated length, 3 inches; maximum diameter, 1.9/16 inches. Tube

1N2-A

requires octal socket and may be operated in any position. For installation and application considerations, refer to type 1B3-GT.

FILAMENT VOLTAGE (AC) .....	1.25*	volts
FILAMENT CURRENT .....	0.2	ampere
DIRECT INTERELECTRODE CAPACITANCE:		
Plate to Filament and Internal Shield .....	1.4	μf

#### PULSED RECTIFIER

*For operation in a 525-line, 30-frame system*

Maximum Ratings, (Design-Maximum Values):

PEAK INVERSE PLATE VOLTAGE <sup>o</sup> .....	28000 max	volts
PEAK PLATE CURRENT .....	50 max	ma
AVERAGE PLATE CURRENT .....	0.5 max	ma

Characteristics:

Plate Current for plate volts= 100 .....	7 <sup>■</sup>	ma
--	----------------	----

\* Under no circumstances should the filament voltage be less than 1.05 volts or greater than 1.45 volts.  
<sup>o</sup> The duration of the voltage pulse must not exceed 15 per cent of one horizontal scanning cycle. In a 525-line, 30-frame system, 15 per cent of one horizontal scanning cycle is 10 microseconds.

■ The dc component must not exceed 24000 volts.

• Instantaneous test value.

# 1N5-GT

## SHARP-CUTOFF PENTODE

Glass octal type used as rf or if amplifier in battery-operated receivers. Outline 23, OUTLINES SECTION. Tube requires octal socket and may be mounted in any position. When used

in avc circuits, the 1N5-GT should be only partially controlled to avoid excessive reduction in receiver sensitivity with large signal input. Filament volts (dc), 1.4; amperes, 0.05. Characteristics as class A<sub>1</sub> amplifier: plate and grid-No.2 volts, 90 (110 max); grid-No.1 volts, 0; plate resistance (approx.), 1.5 megohms; transconductance, 750 μmhos; plate ma., 1.2; grid-No.2 ma., 0.3.

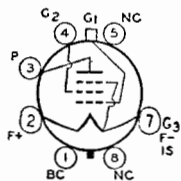

# 1N6-G

## DIODE—POWER PENTODE

Glass octal type used as combined detector and power output tube in battery-operated receivers. Maximum over-all length, 4 inches; maximum diameter, 1-3/16 inches. Filament volts (dc), 1.4; amperes, 0.05. Typical operation of pentode unit as class A<sub>1</sub> amplifier: plate and grid-No.2 (screen-grid) volts, 90 (110 max); grid-No.1 volts, -4.5; plate ma., 3.1; grid-No.2 ma. (zero-signal), 0.6; plate resistance (approx.),

0.3 megohm; transconductance, 800 μmhos; load resistance, 25000 ohms; output watts, 0.1. This is a DISCONTINUED type listed for reference only.

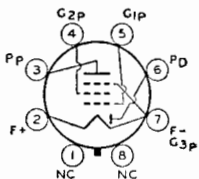

## REMOTE-CUTOFF PENTODE

Glass octal type used as rf or if amplifier in battery-operated receivers. Outline 23, OUTLINES SECTION. Tube requires octal socket. Filament volts (dc), 1.4; amperes, 0.05. Typical operation as class A<sub>1</sub> amplifier: plate volts, 90 (110 max); grid-No.2 (screen-grid) volts, 90 (110 max); grid-No.1 volts, 0; plate resistance (approx.), 0.8 megohm; transconductance, 750 μmhos; plate ma., 2.3; grid-No.2 ma., 0.7. This is a DISCONTINUED type listed for reference only.

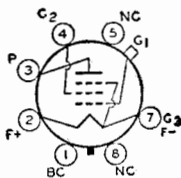

# 1P5-GT

## BEAM POWER TUBE

Glass octal type used in the output stage of battery-operated receivers. Outline 22, OUTLINES SECTION. Tube requires octal socket. Filament volts (dc), 1.4; amperes, 0.1. For electrical characteristics and ratings, refer to type 3Q5-GT with parallel filament arrangement. Type 1P5-GT is a DISCONTINUED type for reference only.

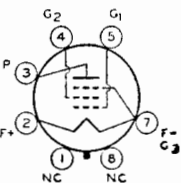

# 1Q5-GT

## PENTAGRID CONVERTER

Miniature type used in light-weight, portable, compact, battery-operated receivers. Outline 11, OUTLINES SECTION. Tube requires miniature seven-contact socket and

may be mounted in any position. For general discussion of pentagrid types, see *Frequency Conversion* in ELECTRON TUBE APPLICATIONS SECTION.

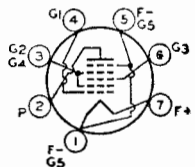

# 1R5

FILAMENT VOLTAGE (DC) .....	1.4	volts
FILAMENT CURRENT .....	0.05	ampere
DIRECT INTERELECTRODE CAPACITANCES:		
Grid No.3 to All Other Electrodes (RF Input) .....	7	7
Plate to All Other Electrodes (Mixer Output) .....	7.5	12
Grid No.1 to All Other Electrodes (Oscillator Input) .....	3.8	3.8
Grid No.3 to Plate .....	0.4 max	0.3 max
Grid No.3 to Grid No.1 .....	0.2 max	0.2 max
Grid No.1 to Plate .....	0.1 max	0.1 max

External shield connected to pin 1.

**Maximum Ratings:**

**CONVERTER**

PLATE VOLTAGE.....	90 <i>max</i>	volts
GRIDS-NO.2-AND-NO.4 (SCREEN-GRID) VOLTAGE.....	67.5 <i>max</i>	volts
GRIDS-NO.2-AND-NO.4 SUPPLY VOLTAGE.....	90 <i>max</i>	volts
GRID-NO.3 (CONTROL-GRID) VOLTAGE, Positive Bias Value.....	0 <i>max</i>	volts
TOTAL ZERO-SIGNAL CATHODE CURRENT.....	5.5 <i>max</i>	ma

**Characteristics, (Separate Excitation)\*:**

Plate Voltage.....	45	67.5	90	volts
Grids-No.2 and No.4 Voltage.....	45	67.5	67.5	volts
Grid No.3 Voltage.....	0	0	0	volts
RMS Grid-No.1 (Oscillator-Grid) Voltage.....	15	25	25	volts
Grid-No.1 Resistor.....	0.1	0.1	0.1	megohm
Plate Resistance (Approx.).....	0.5	0.4	0.4	megohm
Conversion Transconductance.....	210	280	280	$\mu$ mhos
Grid-No.3 Voltage (Approx.) for conversion transconductance of:				
10 $\mu$ mhos.....	-7	-13	-13	volts
100 $\mu$ mhos.....	-2.2	-4.9	-5	volts
Plate Current.....	0.7	1.4	1.5	ma
Grids-No.2 and No.4 Current.....	2.1	3.5	3.5	ma
Grid-No.1 Current.....	150	250	250	$\mu$ a
Total Cathode Current.....	3	5.2	5.3	ma

**Oscillator Characteristics (Not Oscillating):<sup>§</sup>**

Plate and Grids-No.2 and No.4 Voltage.....	7.5	volts
Grid-No.3 Voltage.....	0	volts
Grid-No.1 Voltage.....	0	volts
Amplification Factor <sup>§</sup> .....	6.5	
Oscillator Transconductance <sup>§</sup> .....	1400	$\mu$ mhos
Grid-No.1 Voltage (Approx.) for plate current of 10 $\mu$ a.....	-17	volts
Cathode Current.....	9	ma

\* The characteristics shown with separate excitation correspond very closely with those obtained in a self-excited oscillator circuit operating with zero bias.

§ With grids No.2 and No.4 connected to plate.

§ Between grid No.1 and grids No.2 and No.4 connected to plate.

**POWER PENTODE**

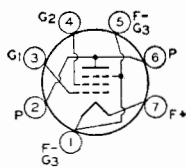

Miniature type used in output stage of lightweight, compact, portable, battery-operated equipment. Types 1S4 and 3S4 are identical except for filament arrangement. Outline 11, OUTLINES SECTION. Type 1S4 requires miniature seven-contact socket and may be mounted in any position. For ratings and typical operation, refer to type 3S4 with parallel filament arrangement. Filament volts (dc), 1.4; amperes, 0.1. This type is used principally for renewal purposes.

**1S4**

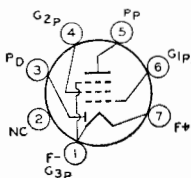

**DIODE—  
SHARP-CUTOFF PENTODE**

Miniature type used in light-weight, compact, portable, battery-operated receivers as combined detector and af voltage amplifier. Outline 11,

**1S5**

OUTLINES SECTION. Filament volts (dc), 1.4; amperes, 0.05. Tube requires miniature seven-contact socket and may be mounted in any position. For electrical characteristics and application, refer to type 1U5.

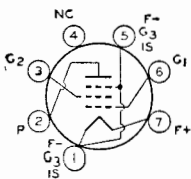

**REMOTE-CUTOFF PENTODE**

Miniature type used in light-weight, compact, portable, battery-operated receivers as rf or if amplifier. Because of internal shielding feature, an external bulb shield is not needed,

**1T4**

but socket shielding is essential if minimum grid-No.1-to-plate capacitance is to be obtained. Outline 11, OUTLINES SECTION. Tube requires miniature seven-contact socket and may be mounted in any position.

FILAMENT VOLTAGE (DC) .....	1.4	volts
FILAMENT CURRENT .....	0.05	ampere
DIRECT INTERELECTRODE CAPACITANCES:*		
Grid No.1 to Plate .....	0.01 <i>max</i>	$\mu\mu\text{f}$
Grid No.1 to Filament, Grid No.2, Grid No.3, and Internal Shield .....	3.6	$\mu\mu\text{f}$
Plate to Filament, Grid No.2, Grid No.3, and Internal Shield .....	7.5	$\mu\mu\text{f}$

\* With or without external shield connected to negative filament terminal.

### Maximum Ratings:

### CLASS A<sub>1</sub> AMPLIFIER

PLATE VOLTAGE .....	90 <i>max</i>	volts
GRID-NO.2 (SCREEN-GRID) VOLTAGE .....	90 <i>max</i>	volts
GRID-NO.1 (CONTROL-GRID) VOLTAGE, Positive Bias Value .....	0 <i>max</i>	volts
TOTAL CATHODE CURRENT .....	5.5 <i>max</i>	ma

### Characteristics:

Plate Voltage .....	45	67.5	90	90	volts
Grid-No.2 Voltage .....	45	67.5	45	67.5	volts
Grid-No.1 Voltage .....	0	0	0	0	volts
Plate Resistance (Approx.) .....	0.35	0.25	0.8	0.5	megohm
Transconductance .....	700	875	750	900	$\mu\text{mhos}$
Grid-No.1 Voltage for transconductance of 10 $\mu\text{mhos}$ .....	-10	-16	-10	-16	volts
Plate Current .....	1.7	3.4	1.8	3.5	ma
Grid-No.2 Current .....	0.7	1.5	0.65	1.4	ma

### BEAM POWER TUBE

Glass octal type used in output stage of battery-operated receivers. Outline 22, OUTLINES SECTION. Tube requires octal socket. Filament volts (dc), 1.4; amperes, 0.05. Typical operation as class A<sub>1</sub> amplifier: plate and grid-No.2 volts, 90 (110 *max*); grid-No.1 volts, -6; peak af grid-No.1 volts, 6; plate ma., 6.5; grid-No.2 ma. (zero-signal), 0.8; grid-No.2 ma. (maximum signal), 1.5; plate resistance, 0.25

megohm; transconductance, 1150  $\mu\text{mhos}$ ; load resistance, 14000 ohms; total harmonic distortion, 7.5 per cent; output watts, 0.17. This is a DISCONTINUED type listed for reference only.

## 1T5-GT

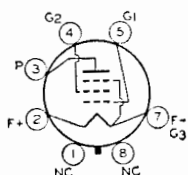

### DIODE—SHARP-CUTOFF PENTODE

Subminiature type used as combined detector and audio amplifier in small, compact, battery-operated receivers for the standard AM broadcast band. Outline 8, OUTLINES SECTION. Tube requires subminiature eight-contact socket. Filament volts (dc), 1.25; amperes, 0.04. Filament voltage should never exceed 1.6 volts. Typical operation of pentode unit as class A<sub>1</sub> amplifier: plate and grid-No.2 volts, 67.5 *max*;

grid-No.1 volts, 0; plate resistance (approx.), 0.4 megohm; transconductance, 600  $\mu\text{mhos}$ ; plate ma., 1.6; grid-No.2 ma., 0.4; total cathode ma., 2.0 *max*. Maximum diode plate ma., 0.25. This is a DISCONTINUED type listed for reference only.

## 1T6

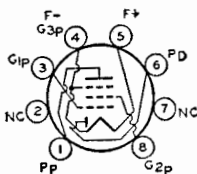

### SHARP-CUTOFF PENTODE

Miniature type used as rf or if amplifier in stages not controlled by avc in lightweight, compact, portable, battery-operated equipment. Outline 11, OUTLINES SECTION. Tube requires miniature seven-contact socket and may be mounted in any position. Because the grid No.2 can be operated at the same voltage as the plate, a voltage-dropping resistor is not needed. For typical operation as a resistance-coupled amplifier, refer to Chart 2, RESISTANCE-COUPLED AMPLIFIER SECTION.

requires miniature seven-contact socket and may be mounted in any position. Because the grid No.2 can be operated at the same voltage as the plate, a voltage-dropping resistor is not needed. For typical operation as a resistance-coupled amplifier, refer to Chart 2, RESISTANCE-COUPLED AMPLIFIER SECTION.

FILAMENT VOLTAGE (DC) .....	1.4	volts
FILAMENT CURRENT .....	0.05	ampere
DIRECT INTERELECTRODE CAPACITANCES:*		
Grid No.1 to Plate .....	0.01 <i>max</i>	$\mu\mu\text{f}$
Grid No.1 to Filament, Grid No.2, Grid No.3, and Internal Shield .....	3.6	$\mu\mu\text{f}$
Plate to Filament, Grid No.2, Grid No.3, and Internal Shield .....	7.5	$\mu\mu\text{f}$

\* With or without external shield connected to negative filament terminal.

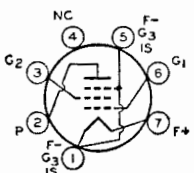

**CLASS A<sub>1</sub> AMPLIFIER**

**Maximum Ratings, (Design-Maximum Values):**

PLATE VOLTAGE.....	120 max	volts
GRID-NO.2 (SCREEN-GRID) VOLTAGE.....	120 max	volts
GRID-NO.1 (CONTROL-GRID) VOLTAGE, Positive bias value.....	0 max	volts
TOTAL CATHODE CURRENT.....	6.6 max	

**Characteristics:**

Plate Voltage.....	90	volts
Grid-No.2 Voltage.....	90	volts
Grid-No.1 Voltage.....	0	volts
Plate Resistance (Approx.).....	1.0	megohm
Transconductance.....	900	μmhos
Grid-No.1 Voltage for plate current of 10 μa.....	-4	volts
Plate Current.....	1.6	ma
Grid-No.2 Current.....	0.5	ma

**DIODE—SHARP-CUTOFF  
PENTODE**

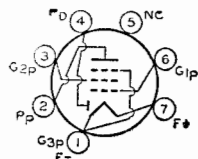

Miniature type used in light-weight, compact, portable, battery-operated receivers as combined detector and af voltage amplifier. The 1U5 is similar to the 1S5 but utilizes an im-

**1U5**

proved structure which greatly reduces any tendency toward microphonic effects. In addition, the diode unit is effectively shielded from the pentode unit to prevent "play-through." Outline 11, OUTLINES SECTION. Tube requires miniature seven-contact socket and may be mounted in any position. For typical operation as a resistance-coupled amplifier, refer to Chart 1, RESISTANCE-COUPLED AMPLIFIER SECTION.

FILAMENT VOLTAGE (DC).....	1.4	volts
FILAMENT CURRENT.....	0.05	ampere

**PENTODE UNIT AS CLASS A<sub>1</sub> AMPLIFIER**

**Maximum Ratings, (Design-Maximum Values):**

PLATE VOLTAGE.....	100 max	volts
GRID-NO.2 (SCREEN-GRID) VOLTAGE.....	100 max	volts
GRID-NO.1 (CONTROL-GRID) VOLTAGE, Positive bias value.....	0 max	volt
TOTAL CATHODE CURRENT.....	3.3 max	ma

**Characteristics:**

Plate Voltage.....	67.5	volts
Grid-No.2 Voltage.....	67.5	volts
Grid-No.1 Voltage.....	0	volts
Plate Resistance.....	0.6	megohm
Transconductance.....	625	μmhos
Grid-No.1 Voltage for plate current of 10 μa.....	-5	volts
Plate Current.....	1.6	ma
Grid-No.2 Current.....	0.4	ma

**DIODE UNIT**

**Maximum Rating:**

PLATE CURRENT.....	0.28 max	ma
--------------------	----------	----

Diode unit is located at negative end of filament and is independent of the pentode except for the common filament.

**HALF-WAVE VACUUM RECTIFIER**

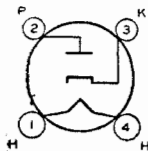

Glass type used in ac/dc or automobile receivers. Outline 34 or 35, OUTLINES SECTION. Tube requires four-contact socket. Heater volts (ac/dc), 6.3; amperes, 0.3. Maximum ratings as half-wave rectifier: peak inverse plate volts, 1000; peak plate ma., 270; peak heater-cathode volts, 500; dc output ma., 45. This type is used principally for renewal purposes.

**1-v**

### HALF-WAVE VACUUM RECTIFIER

# 1V2

Miniature type used in high-voltage, low-current applications such as the rectifier in high-voltage, pulse-operated voltage-doubling power supplies for kinescopes. The very low power

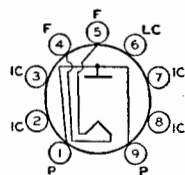

required by the filament permits the use of a rectifier transformer having small size and light weight. For curve of average plate characteristics, see page 67.

FILAMENT VOLTAGE (AC).....	0.625	volt
FILAMENT CURRENT.....	0.3	ampere
DIRECT INTERELECTRODE CAPACITANCE:		
Plate to Filament (Approx.).....	0.8	μf

■ Under no circumstances should the filament voltage be less than 0.525 volt or greater than 0.725 volt.

### PULSED RECTIFIER

For operation in a 525-line, 30-frame system

Maximum Ratings, (Design-Maximum Values):

PEAK INVERSE PLATE VOLTAGE*	8250	max	volts
PEAK PLATE CURRENT.....	11	max	ma
AVERAGE PLATE CURRENT.....	0.6	max	ma

\* The duration of the voltage pulse must not exceed 15 per cent of one horizontal scanning cycle. In a 525-line, 30-frame system, 15 per cent of one horizontal scanning cycle is 10 microseconds.

• The dc component must not exceed 7000 volts.

### INSTALLATION AND APPLICATION

Type 1V2 requires a miniature nine-contact socket and may be mounted in any position. The socket should be made of material having low leakage and should have adequate insulation between its filament and plate terminals to withstand the maximum peak inverse plate voltage. To provide the required insulation in miniature nine-contact sockets designed with a cylindrical center shield, it is necessary to remove the center shield. In addition, socket terminals 2, 3, 7, and 8 shall not be used. Socket terminal 6 may be used as a tie point for components at or near filament potential. Outline 14, OUTLINES SECTION.

The filament is of the coated type and is designed for operation at 0.625 volt. The filament windings on the pulse transformer should be adjusted to provide the rated voltage under average line-voltage conditions. When the filament voltage is measured, it is recommended that an rms voltmeter of the thermal type be used. The meter and its leads must be insulated to withstand 15000 volts and the stray capacitances to ground should be minimized.

The high voltages at which the 1V2 is operated are very dangerous. Great care should be taken to prevent coming in contact with these high voltages. Particular care against fatal shock should be taken in measuring the filament voltage in those circuits where the filament is not grounded. Precautions must include safeguards which definitely eliminate all hazards to personnel.

### HALF-WAVE VACUUM RECTIFIER

# 1X2-A 1X2-B

Miniature types used in high-voltage, low-current applications such as the rectifier in a high-voltage, rf-operated power supply, or as the rectifier of high-voltage pulses produced in tele-

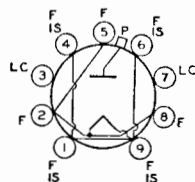

vision scanning systems. Outlines 16 and 17, respectively, OUTLINES SECTION. Tubes require miniature nine-contact socket and may be mounted in any position. Socket terminals 3 and 7 may be used as tie points for components at or near filament potential. For high-voltage considerations, refer to type 1B3-GT. For curve of average plate characteristics, see page 67. Type 1X2-A is used principally for renewal purposes.

## Technical Data

FILAMENT VOLTAGE (AC) .....	1.25*	volts
FILAMENT CURRENT .....	0.2	ampere
DIRECT INTERELECTRODE CAPACITANCE:		
Plate to Filament and Internal Shield (Approx.) .....	1.0	$\mu\text{f}$

\* Under no circumstances should the filament voltage be less than 1.05 volts or greater than 1.45 volts.

### PULSED RECTIFIER

*For operation in a 525-line, 30-frame system*

Maximum Ratings:	1X2-A	1X2-B	
	Design-Center Values <sup>‡</sup>	Design-Maximum Values	
PEAK INVERSE PLATE VOLTAGE <sup>‡</sup> .....	20000 <sup>max</sup>	22000 <i>max</i>	volts
PEAK PLATE CURRENT .....	45 <i>max</i>	45 <i>max</i>	ma
AVERAGE PLATE CURRENT .....	0.5 <i>max</i>	0.5 <i>max</i>	ma

‡ *Absolute Maximum.* Under no circumstances should this absolute value be exceeded.

# Except as noted.

■ The dc component must not exceed 16000 volts for 1X2-A, 18000 volts for 1X2-B.

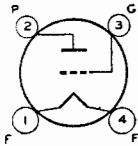

### POWER TRIODE

Glass type used in output stage of radio receivers and amplifiers. As a class A<sub>1</sub> power amplifier, the 2A3 is usable either singly or in push-pull combination.

# 2A3

FILAMENT VOLTAGE (AC/DC) .....	2.5	volts
FILAMENT CURRENT .....	2.5	amperes
DIRECT INTERELECTRODE CAPACITANCES (Approx.):		
Grid to Plate .....	16.5	$\mu\text{f}$
Grid to Filament .....	7.5	$\mu\text{f}$
Plate to Filament .....	5.5	$\mu\text{f}$

### CLASS A<sub>1</sub> AMPLIFIER

Maximum Ratings:		
PLATE VOLTAGE .....	300 <i>max</i>	volts
PLATE DISSIPATION .....	15 <i>max</i>	watts

#### Typical Operation:

Plate Voltage .....	250	volts
Grid Voltage <sup>#</sup> .....	-45	volts
Plate Current .....	60	ma
Amplification Factor .....	4.2	
Plate Resistance .....	800	ohms
Transconductance .....	5250	$\mu\text{mhos}$
Load Resistance .....	2500	ohms
Second Harmonic Distortion .....	5	per cent
Power Output .....	3.5	watts

### PUSH-PULL CLASS AB<sub>1</sub> AMPLIFIER

Maximum Ratings:		
PLATE VOLTAGE .....	300 <i>max</i>	volts
PLATE DISSIPATION .....	15 <i>max</i>	watts

#### Typical Operation (Values Are For Two Tubes):

	Fixed Bias	Cathode Bias	
Plate Supply Voltage .....	300	300	volts
Grid Voltage .....	-62*	-	volts
Cathode-Bias Resistor .....	-	780	ohms
Peak AF Grid-to-Grid Voltage .....	124	156	volts
Zero-Signal Plate Current .....	80	80	ma
Maximum-Signal Plate Current .....	147	100	ma
Effective Load Resistance (Plate-to-plate) .....	3000	5000	ohms
Total Harmonic Distortion .....	2.5	5.0	per cent
Power Output .....	15	10	watts

#### Maximum Circuit Values:

Grid-Circuit Resistance:		
For fixed-bias operation .....	0.05 <i>max</i>	megohm
For cathode-bias operation .....	0.5 <i>max</i>	megohm

\* Grid voltage referred to mid-point of filament transformer.

‡ When a single 2A3 is operated cathode-biased, the cathode-biasing resistor value should be 750 ohms.

### INSTALLATION AND APPLICATION

Type 2A3 requires a four-contact socket and may be mounted in any position. Outline 51, OUTLINES SECTION. It is especially important that this tube, like other power-handling tubes, be adequately ventilated.

The values recommended for push-pull operation are different from the conventional ones usually given on the basis of characteristics for a single tube. The values shown for Push-Pull Class AB<sub>1</sub> operation cover operation with fixed bias and with cathode bias, and have been determined on the basis of no grid current flow during the most positive swing of the input signal and of cancellation of second-harmonic distortion by virtue of the push-pull circuit. The cathode resistor should preferably be shunted by a suitable filter network to minimize grid-bias variations produced by current surges in the cathode resistor.

When 2A3's are operated in push-pull, it is desirable to provide means for adjusting the bias on each tube independently. This requirement is a result of the very high transconductance of these tubes (5250 micromhos). This very high value makes the 2A3 somewhat critical as to grid-bias voltage, since a very small bias-voltage change produces a very large change in plate current. It is obvious, therefore, that the difference in plate current between two tubes may be sufficient to unbalance the system seriously. To avoid this possibility, simple methods of independent cathode-bias adjustment may be used, such as (1) input transformer with two independent secondary windings, or (2) filament transformer with two independent filament windings. With either of these methods, each tube can be biased separately so as to obtain circuit balance.

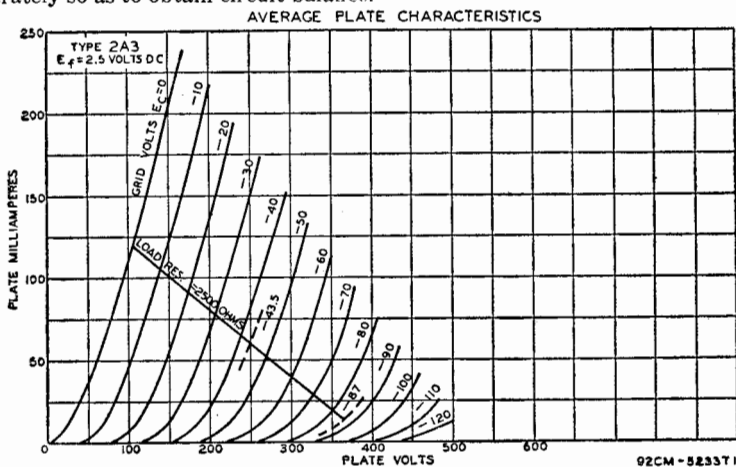

#### POWER PENTODE

Glass type used in output stage of ac-operated receivers. Outline 43, OUTLINES SECTION. Tube requires six-contact socket. Except for its heater rating (2.5 volts ac/dc; 1.75 amperes), the 2A5 has electrical characteristics identical with type 6F6. Type 2A5 is a DISCONTINUED type listed for reference only.

**2A5**

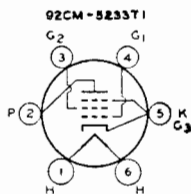

#### TWIN DIODE—HIGH-MU TRIODE

Glass type used in ac-operated receivers chiefly as a combined detector, amplifier, and avc tube. Outline 40, OUTLINES SECTION. Tube requires six-contact socket. Except for its heater rating (2.5 volts ac/dc; 0.8 ampere), and within its 250-volt maximum plate rating, the 2A6 has electrical characteristics identical with type 6SQ7. Type 2A6 is a DISCONTINUED type listed for reference only.

**2A6**

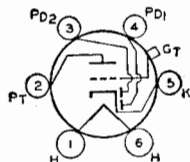



**PENTAGRID CONVERTER**

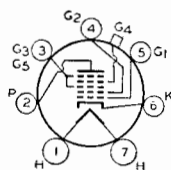

Glass type used in ac-operated receivers. Outline 40, OUTLINES SECTION. Tube requires small seven-contact (0.75-inch, pin-circle diameter) socket. Except for its heater rating (2.5 volts ac/dc; 0.8 ampere) and its interelectrode capacitances, the 2A7 has electrical characteristics identical with type 6A8. Complete shielding of this tube is generally necessary. Type 2A7 is a DISCONTINUED type listed for reference only.

**2A7**

**MEDIUM-MU TRIODE**

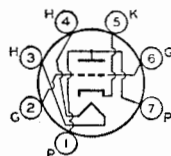

Miniature types used as local oscillator in uhf television receivers employing series-connected heater strings. Outline 9, OUTLINES SECTION. Heater volts (ac/dc), 2.35; amperes,

**2AF4-A**  
**2AF4-B**

0.6; warm-up time (average), 11 seconds. Type 2AF4-B only, maximum rating (design maximum), peak heater-cathode volts, 180 *max*. When the heater is positive with respect to the cathode, the dc component of the heater-cathode voltage must not exceed 100 volts. Typical operation of 2AF4-B as oscillator at 1000 Mc: plate ma., 17.5; grid ma. (approx.), 700. Except for heater ratings noted, these types are identical with miniature type 6AF4-A.

**TWIN DIODE—  
REMOTE-CUTOFF PENTODE**

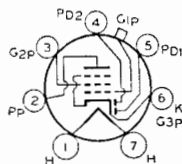

Glass type used as combined detector, avc tube, and amplifier. Outline 40, OUTLINES SECTION. Tube requires small seven-contact (0.75-inch, pin-circle diameter) socket. Except for its heater rating (2.5 volts ac/dc; 0.8 ampere) and its interelectrode capacitances, the 2B7 has electrical characteristics identical with type 6B8-G. Type 2B7 is a DISCONTINUED type listed for reference only.

**2B7**

**MEDIUM-MU TRIODE**

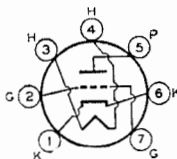

Miniature types used as rf amplifier in vhf television tuners employing series-connected heater strings. Outline 11, OUTLINES SECTION. Heater volts (ac/dc), 2BN4: 2.3, 2BN4-A: 2.35; amperes, 0.6; warm-up time (average), 11 seconds. Except for heater rating, these types are identical with miniature types 6BN4 and 6BN4-A, respectively. Types 2BN4 and 2BN4-A are used principally for renewal purposes.

**2BN4**  
**2BN4-A**

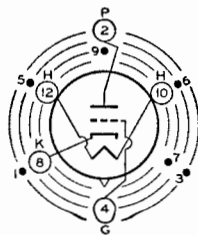

**HIGH-MU TRIODE**

Nuvistor type used as a grounded-cathode, neutralized rf amplifier in vhf tuners of television and FM receivers employing series-connected heater strings. Outline 53, OUTLINES SECTION. Heater volts (ac/dc), 2.1; amperes, 0.45; warm-up time (average), 11

**2CW4**

seconds. Except for heater rating, this type is identical with nuvistor type 6CW4.

INDEX=LARGE LUG  
●=PIN CUT OFF

## 2CY5

### SHARP-CUTOFF TETRODE

Miniature type used as rf amplifier in vhf tuners of television receivers employing series-connected heater strings. Outline 11, OUTLINES SECTION. Heater volts (ac/dc), 2.4; amperes, 0.6; warm-up time (average), 11 seconds. Except for heater rating, this type is identical with miniature type 6CY5.

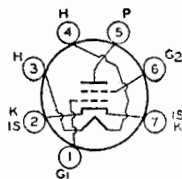

## 2E5

### ELECTRON-RAY TUBE

Glass type with triode unit used to indicate visually by means of a fluorescent target the effects of a change in a controlling voltage. It is used as a convenient means of indicating accurate radio receiver tuning. Outline 34 or 35, OUTLINES SECTION. Tube requires six-contact socket. Except for its heater rating (2.5 volts ac/dc; 0.8 ampere), the 2E5 has electrical characteristics identical with type 6E5. Type 2E5 is a DISCONTINUED type listed for reference only.

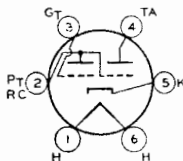

## 2EN5

### TWIN DIODE

Miniature type used as a horizontal phase detector in television receivers. Outline 11, OUTLINES SECTION. Tube requires miniature seven-contact socket and may be mounted in any position. Heater volts (ac/dc), 2.1; amperes, 0.45; warm-up time (average), 11 seconds. Maximum ratings (*design maximum*) as half-wave rectifier: dc output ma. per plate, 5 max; peak heater-cathode volts, 200 max. When the heater is positive with respect to cathode, the dc component of the heater-cathode voltage must not exceed 100 volts. Type 2EN5 is used principally for renewal purposes.

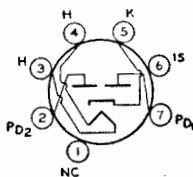

## 2ER5

### SHARP-CUTOFF TRIODE

Miniature type used in vhf tuners of television receivers. Outline 11, OUTLINES SECTION. Heater volts (ac/dc), 2.3; amperes, 0.6. Except for heater rating, this type is identical with miniature type 6ER5.

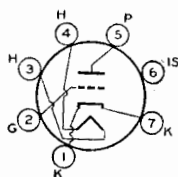

## 2FH5

### SHARP-CUTOFF TRIODE

Miniature type used as an rf amplifier in vhf tuners of television receivers employing series-connected heater strings. Outline 11, OUTLINES SECTION. Heater volts (ac/dc), 2.35; amperes, 0.6; warm-up time (average), 11 seconds. Except for heater rating, this type is identical with miniature type 6FH5.

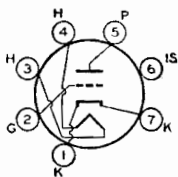

### HALF-WAVE VACUUM RECTIFIER

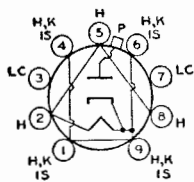

**3A2**

Miniature type used as rectifier of high-voltage pulses produced in scanning systems of color-television receivers. Outline 16, OUTLINES SECTION. Tube requires miniature 9-contact socket and may be mounted in any position. Socket terminals 3 and 7 may be connected to the heater. Heater volts (ac), 3.15; amperes, 0.22. Maximum ratings as pulsed rectifier in 525-line, 30-frame system: peak inverse plate volts,

18000 max; peak plate ma., 80 max; average plate ma., 1.5 max. For curve of average plate characteristics, see page 67. For high-voltage considerations, see type 1B3-GT. Type 3A2 is used principally for renewal purposes.

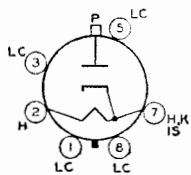

### HALF-WAVE VACUUM RECTIFIER

**3A3**

Glass octal type used as rectifier of high-voltage pulses produced in the scanning systems of color television receivers. Outline 32, OUTLINES SECTION. Tube requires octal socket

and may be mounted in any position. Socket terminals 1, 3, 4, 5, 6, and 8 may be connected to socket terminal 7. Socket terminals 4 and 6 may be used as tie points for components at or near heater potential. For curve of average plate characteristics, see page 67. For high-voltage considerations, see type 1B3-GT.

HEATER VOLTAGE (AC) .....	3.15 <sup>23</sup>	volts
HEATER CURRENT .....	0.22	ampere
DIRECT INTERELECTRODE CAPACITANCE (Approx.):		
Plate to Heater, Cathode, and Internal Shield .....	1.5	$\mu$ fd

\* Under no circumstances should the heater voltage be less than 2.65 volts or greater than 3.65 volts.

### PULSED RECTIFIER

For operation in a 525-line, 30-frame system

Maximum Ratings, (Design-Maximum Values):

PEAK INVERSE PLATE VOLTAGE <sup>24</sup> .....	30000 max	volts
PEAK PLATE CURRENT .....	88 max	ma
AVERAGE PLATE CURRENT .....	1.7 max	ma

<sup>24</sup> The duration of the voltage pulse must not exceed 15 per cent of one horizontal scanning cycle. In a 525-line, 30-frame system, 15 per cent of one horizontal scanning cycle is 10 microseconds.

### DIODE—TRIODE—PENTODE

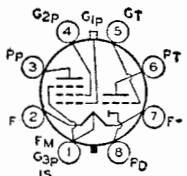

**3A8-GT**

Glass octal type used as combined detector, af amplifier, and rf amplifier in battery-operated receivers. Maximum over-all length, 3-7/16 inches; maximum diameter, 1-5/16 inches. Filament volts, 1.4 (parallel), 2.8 (series); amperes, 0.1 (parallel), 0.05 (series). Typical operation as class A<sub>1</sub> amplifier: triode unit—plate volts, 90 (110 max); grid volts, 0; amplification factor, 65; plate resistance, 0.2 megohm; transconductance,

325  $\mu$ hos; plate ma., 0.2; pentode unit—plate and grid-No.2 volts, 90 (110 max); grid-No.1 volts, 0; plate resistance, 0.8 megohm; transconductance, 750  $\mu$ hos; plate ma., 1.5; grid-No.2 ma., 0.5. This is a DISCONTINUED type listed for reference only.

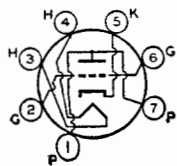

### MEDIUM-MU TRIODE

**3AF4-A**

Miniature type used as local oscillator in uhf television receivers covering the frequency range of 470 to 890 megacycles per second and employing series-connected heater strings. Outline 9, OUTLINES SECTION. Heater volts (ac/dc), 3.15; amperes, 0.45; warm-up time (average), 11 seconds. Except for heater rating, this type is identical with miniature type 6AF4-A.

line 9, OUTLINES SECTION. Heater volts (ac/dc), 3.15; amperes, 0.45; warm-up time (average), 11 seconds. Except for heater rating, this type is identical with miniature type 6AF4-A.

**TWIN DIODE**

**3AL5**

Miniature type having high-perveance used as detector in television receivers employing series-connected heater strings. Outline 9, OUTLINES SECTION. Heater volts (ac/dc), 3.15; amperes, 0.6; warm-up time (average), 11 seconds. Except for heater rating, this type is identical with miniature type 6AL5.

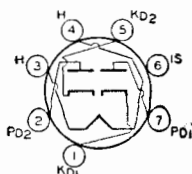

**SHARP-CUTOFF PENTODE**

**3AU6**

Miniature type used as rf amplifier in television receivers employing series-connected heater strings. Outline 11, OUTLINES SECTION. Heater volts (ac/dc), 3.15; amperes, 0.6; warm-up time (average), 11 seconds. Peak heater-cathode volts, 200 max. When the heater is positive with respect to the cathode, the dc component of the heater-cathode voltage must not exceed 100 volts. Except for heater and heater-cathode ratings, this type is identical with miniature type 6AU6.

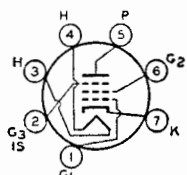

**TWIN DIODE—HIGH-MU TRIODE**

**3AV6**

Miniature type used as combined detector, amplifier, and avc tube in television receivers employing series-connected heater strings. Outline 11, OUTLINES SECTION. Heater volts (ac/dc), 3.15; amperes, 0.6; warm-up time (average), 11 seconds. Peak heater-cathode volts, 200 max. When the heater is positive with respect to the cathode, the dc component of the heater-cathode voltage must not exceed 100 volts. Except for heater and heater-cathode ratings, this type is identical with miniature type 6AV6.

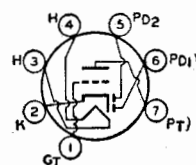

**HALF-WAVE VACUUM RECTIFIER**

**3B2**

Glass octal type used as rectifier of high-voltage pulses produced in the scanning systems of television receivers. Outline 47, OUTLINES SECTION. Tube requires octal socket and may be mounted in any position. Low-potential circuits should not be connected to any of the socket terminals. Any or all of the following socket-terminal connections are permissible and may aid in corona reduction: socket terminals 1, 3, 5, and 7 may be connected together; socket terminals 2, 6, and 8 may be connected together; socket terminal 4 may be connected to socket terminals 2 or 7, or may be used as a tie point for a heater-voltage dropping resistor. Heater volts (ac/dc), 3.15; amperes, 0.22. Maximum ratings as pulsed rectifier in 525-line, 30-frame system: peak inverse plate volts (absolute maximum), 35000 max (dc 25000 max); peak plate ma., 80 max; average plate ma., 1.1 max. For curve of average plate characteristics, see page 67. For high-voltage considerations, see type 1B3-GT. Type 3B2 is used principally for renewal purposes.

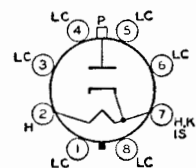

**REMOTE-CUTOFF PENTODE**

**3BA6**

Miniature type used as rf amplifier in standard broadcast and FM receivers, as well as in wide-band, high-frequency applications; for use in equipment employing series-connected heater strings. Outline 11, OUTLINES SECTION. Heater volts (ac/dc), 3.15; amperes, 0.6; warm-up time (average), 11 seconds. Except for heater ratings, this type is identical with miniature type 6BA6.

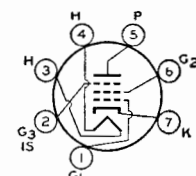

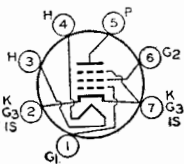

### SHARP-CUTOFF PENTODE

**3BC5**

Miniature type used as rf or if amplifier in television receivers employing series-connected heater strings. Outline 11, OUTLINES SECTION.

Heater volts (ac/dc), 3.15; amperes, 0.6; warm-up time (average), 11 seconds. Peak heater-cathode volts, 200 *max*. When the heater is positive with respect to the cathode, the dc component of the heater-cathode voltage must not exceed 100 volts. Except for heater and heater-cathode ratings, this type is identical with miniature type 6BC5.

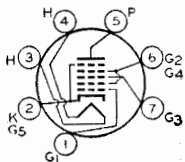

### PENTAGRID CONVERTER

**3BE6**

Miniature type used as converter in superheterodyne circuits in both the standard broadcast and FM bands in equipment employing series-connected heater strings. Outline 11, OUTLINES SECTION.

Heater volts (ac/dc), 3.15; amperes, 0.6; warm-up time (average), 11 seconds. Except for heater ratings, this type is identical with miniature type 6BE6.

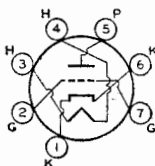

### MEDIUM-MU TRIODE

**3BN4  
3BN4-A**

Miniature types used as rf amplifier in grid-drive circuits of vhf television tuners. The double base-pin connections for both cathode and grid reduce effective lead inductance and

lead resistance with consequent reduction in input conductance. In addition, the basing arrangement facilitates isolation of input and output circuits and permits short, direct connections to base-pin terminals. Outline 11, OUTLINES SECTION. Heater volts (ac/dc), 3; amperes, 0.45; warm-up time (average), 11 seconds. Except for heater ratings, the 3BN4 and 3BN4-A are identical with miniature types 6BN4 and 6BN4-A, respectively.

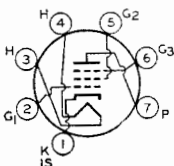

### BEAM TUBE

**3BN6**

Miniature type used as combined limiter, discriminator, and af voltage amplifier in intercarrier television and FM receivers employing series-connected heater strings. Outline 13,

OUTLINES SECTION. Heater volts (ac/dc), 3.15; amperes, 0.6; warm-up time (average), 11 seconds. Except for heater rating, this type is identical with miniature type 6BN6.

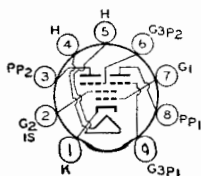

### SHARP-CUTOFF TWIN PENTODE

**3BU8**

Miniature type used as combined sync separator, sync clipper, and age amplifier tube in television receivers employing series-connected heater strings. Outline 14, OUTLINES SECTION.

Heater volts (ac/dc), 3.15; amperes, 0.6; warm-up time (average), 11 seconds. Except for heater rating, this type is identical with miniature type 6BU8.

**PENTAGRID AMPLIFIER**

**3BY6**

Miniature type used as gated amplifier in television receivers employing series-connected heater strings. Outline 11, OUTLINES SECTION.

Heater volts (ac/dc), 3.15; amperes, 0.6; warm-up time (average), 11 seconds. Except for heater rating, this type is identical with miniature type 6BY6.

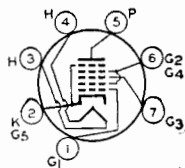

**SEMIREMOTE-CUTOFF PENTODE**

**3BZ6**

Miniature type used in gain-controlled video if stages of television receivers employing series-connected heater strings. Outline 11, OUTLINES SECTION. Heater volts (ac/dc), 3.15;

amperes, 0.6; warm-up time (average), 11 seconds. Peak heater-cathode volts when heater is negative with respect to cathode, 300 *max* (the dc component must not exceed 200 volts). Except for heater and heater-cathode ratings, this type is identical with miniature type 6BZ6.

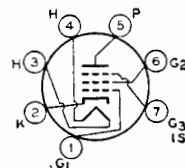

**SHARP-CUTOFF PENTODE**

**3CB6**

Miniature type used as rf or if amplifier in television receivers employing series-connected heater strings. Outline 11, OUTLINES SECTION. Heater volts (ac/dc), 3.15; amperes,

0.6; warm-up time (average), 11 seconds. Peak heater-cathode volts: heater negative with respect to cathode, 300 *max*; heater positive with respect to cathode, 200 *max* (the dc component must not exceed 100 volts). Except for heater and heater-cathode ratings, this type is identical with miniature type 6CB6.

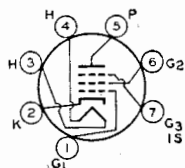

**SHARP-CUTOFF PENTODE**

**3CE5**

Miniature type used as rf and if amplifier in vhf television receivers employing series-connected heater strings. Outline 11, OUTLINES SECTION. Heater volts, 3.15; amperes, 0.6; heater

warm-up time (average), 11 seconds. Except for heater rating, this type is identical with miniature type 6CE5.

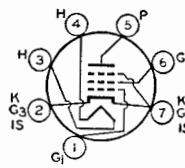

**SHARP-CUTOFF PENTODE**

**3CF6**

Miniature type used as rf or if amplifier in television receivers employing series-connected heater strings. Outline 11, OUTLINES SECTION. Heater volts (ac/dc), 3.15; amperes,

0.6; warm-up time (average), 11 seconds. Peak heater-cathode volts: heater negative with respect to cathode, 300 *max*; heater positive with respect to cathode, 200 *max* (the dc component must not exceed 100 volts). Except for heater and heater-cathode ratings, this type is identical with miniature type 6CF6.

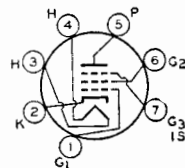

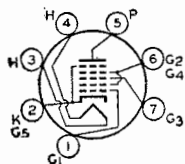

### PENTAGRID AMPLIFIER

Miniature type used as gated amplifier in television receivers employing series-connected heater strings. Outline 11, OUTLINES SECTION.

## 3CS6

Heater volts (ac/dc), 3.15; amperes, 0.6; warm-up time (average), 11 seconds. Except for heater rating, this type is identical with miniature type 6CS6.

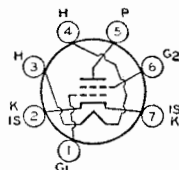

### SHARP-CUTOFF TETRODE

Miniature type used as rf amplifier in vhf tuners of television receivers employing series-connected heater strings. Outline 11, OUTLINES SECTION.

## 3CY5

Heater volts (ac/dc), 2.9; amperes, 0.45; warm-up time (average), 11 seconds. Except for heater rating, this type is identical with miniature type 6CY5.

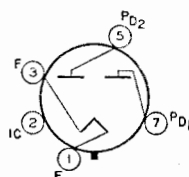

### FULL-WAVE VACUUM RECTIFIER

Glass octal type used as power supply in television receivers and other equipment having high dc requirements. Outline 44, OUTLINES SECTION. Tube requires octal socket and

## 3DG4

may be operated in any position. It is especially important that this tube, like other power-handling tubes, be adequately ventilated. For discussion of Rating Chart, refer to INTERPRETATION OF TUBE DATA.

FILAMENT VOLTAGE (AC/DC).....	3.3	volts
FILAMENT CURRENT.....	3.8	amperes

#### FULL-WAVE RECTIFIER

Maximum Ratings, (Design-Maximum Values):

PEAK INVERSE PLATE VOLTAGE.....	1050 max	volts
PEAK PLATE CURRENT (Per Plate).....	1.2 max	amperes
HOT-SWITCHING TRANSIENT PLATE CURRENT (Per Plate).....	6.5 max	amperes
AC PLATE SUPPLY VOLTAGE (Per Plate, rms).....	See Rating Chart	
DC OUTPUT CURRENT (Per Plate).....	See Rating Chart	
BULB TEMPERATURE (at hottest point on bulb surface).....	200 max	°C

RATING CHART

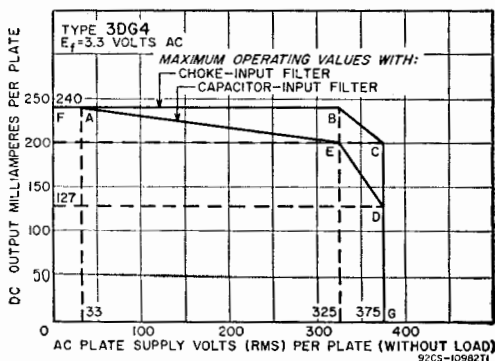

**Typical Operation with Capacitor Input to Filter:**

AC Plate-to-Plate Supply Voltage (rms).....	550	volts
Filter-Input Capacitor <sup>a</sup> .....	40	μf
Effective Plate-Supply Impedance per Plate.....	32	ohms
DC Output Voltage at Input to Filter (Approx.):		
At full-load current of 350 ma.....	300	volts

**Characteristics:**

Tube Voltage Drop for plate ma. =350 per plate.....	25	volts
---	----	-------

<sup>a</sup> Higher values of capacitance than indicated may be used, but the effective plate-supply impedance may have to be increased to prevent exceeding the maximum rating for peak plate current.

**SHARP-CUTOFF PENTODE**

**3DK6**

Miniature types used as intermediate-frequency amplifier in television receivers. Outline 11, OUTLINES SECTION. Heater volts (ac/dc), 3.15, amperes, 0.6; warm-up time (average),

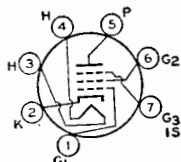

11 seconds, Peak heater-cathode volts: heater negative with respect to cathode, 300 *max*; heater positive with respect to cathode, 200 *max* (the dc component must not exceed 100 volts). Except for heater and heater-cathode ratings, this type is identical with miniature type 6DK6.

**SHARP-CUTOFF PENTODE**

**3DT6  
3DT6-A**

Miniature types used as FM detector in television receivers employing series-connected heater strings. Outline 11, OUTLINES SECTION. Heater volts (ac/dc), 3.15; amperes, 0.6;

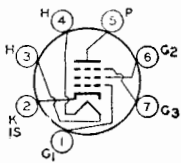

warm-up time (average), 11 seconds. Except for heater rating, these types are identical with miniature types 6DT6 and 6DT6-A, respectively.

**SHARP-CUTOFF PENTODE**

**3EA5**

Miniature type used as rf amplifier in vhf tuners of television receivers having series-connected heater strings. Outline 11, OUTLINES SECTION. Heater volts (ac/dc) 2.9; amperes,

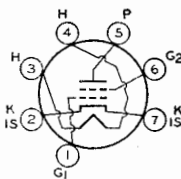

0.45; warm-up time (average), 11 seconds. Except for heater rating, this type is identical with miniature type 6EA5.

**BEAM POWER TUBE**

**3LF4**

Glass lock-in type used in output stage of ac/dc/battery portable receivers. Outline 15, OUTLINES SECTION. Tube requires lock-in socket. Filament volts (dc), 1.4 (parallel), 2.8 (series); amperes, 0.1 (parallel), 0.05 (series). For electrical characteristics, refer to glass-octal type 3Q5-GT. Type 3LF4 is used principally for renewal purposes.

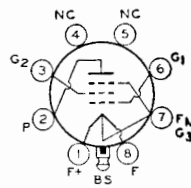

**POWER PENTODE**

**3Q4**

Miniature type used in output stage of lightweight, compact, portable battery-operated equipment. Outline 11, OUTLINES SECTION. Except for terminal connections, types 3Q4 and 3V4 are identical. Refer to type 3V4 for ratings and typical operation. Type 3Q4 is used principally for renewal purposes.

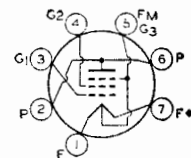



**BEAM POWER TUBE**

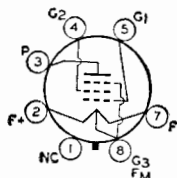

**3Q5-GT**

Glass octal type used in output stage of ac/dc battery portable receivers. Outline 22, OUTLINES SECTION. This type may be supplied with pin 1 omitted. Filament volts (dc), 2.8 in series filament arrangement and 1.4 in parallel arrangement; amperes, 0.05 (series), 0.1 (parallel). Typical operation as Class A<sub>1</sub> amplifier: plate and grid-No.2 volts, 110 max; grid-No.1 volts, -6.6; peak af grid-No.1 volts,

5.1 (series), 5.4 (parallel); plate ma., 8.5 (series), 10 (parallel); grid-No.2 ma., 1.1 (series), 1.4 (parallel); total cathode ma., 6 max for each 1.4-volt filament section; plate resistance (approx.), 0.11 megohm (series), 0.1 megohm (parallel); transconductance, 2000 μmhos (series), 2200 μmhos (parallel); load resistance, 8000 ohms; total harmonic distortion, 8.5 per cent (series), 6 per cent (parallel); max.-signal power output, 330 mw (series), 400 mw (parallel). This type is used principally for renewal purposes.

**POWER PENTODE**

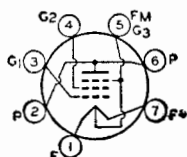

**3S4**

Miniature type used in output stage of lightweight, compact, portable, battery-operated equipment. Outline 11, OUTLINES SECTION. Tube requires miniature seven-contact socket

and may be mounted in any position. Types 3S4 and 1S4 are identical except for filament arrangement. Type 3S4 features a filament mid-tap so that tube may be used either with a 1.4-volt battery supply or in series with other miniature tubes having 0.050-ampere filaments.

FILAMENT ARRANGEMENT:	Series	Parallel	
FILAMENT VOLTAGE (DC).....	2.8	1.4	volts
FILAMENT CURRENT.....	0.05	0.1	ampere

**CLASS A<sub>1</sub> AMPLIFIER**

Maximum Ratings:	Series	Parallel	
PLATE VOLTAGE.....	90 max	90 max	volts
GRID-NO.2 (SCREEN-GRID) VOLTAGE.....	67.5 max	67.5 max	volts
TOTAL CATHODE CURRENT.....	6*max	12 max	ma

\* For each 1.4-volt filament section.

Typical Operation:	Series	Parallel	
Plate Voltage.....	67.5	90	volts
Grid-No. 2 Voltage.....	67.5	67.5	volts
Grid-No. 1 (Control-Grid) Voltage.....	-7	-7	volts
Peak AF Grid-No. 1 Voltage.....	7	7	volts
Zero-Signal Plate Current.....	6.0	6.1	ma
Zero-Signal Grid-No. 2 Current.....	1.2	1.1	ma
Plate Resistance.....	0.1	0.1	megohm
Transconductance.....	1400	1425	μmhos
Load Resistance.....	5000	8000	ohms
Total Harmonic Distortion.....	12	13	per cent
Maximum-Signal Power Output.....	160	235	mw

**Maximum Circuit Values:**

Grid-No.1-Circuit Resistance:	
For fixed-bias operation.....	2.2 max megohms
For cathode-bias operation.....	2.2 max megohms

**POWER PENTODE**

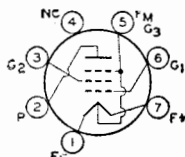

**3V4**

Miniature type used in output stage of lightweight, compact, portable, battery-operated equipment. Outline 11, OUTLINES SECTION. Tube requires miniature seven-contact socket

and may be mounted in any position. Except for terminal connections, types 3V4 and 3Q4 are identical. Both feature filament mid-tap so that tubes may be used either with a 1.4-volt battery supply or in series with other miniature tubes having 0.05-ampere filaments. For series filament arrangement, filament voltage is applied between pins 1 and 7 and grid-No.1 voltage is referred to F-. For parallel filament arrangement, filament voltage is applied between pin 5 and pins 1 and 7 connected together and grid-No.1 voltage is referred to F<sub>m</sub>, the filament mid-tap.

<b>FILAMENT ARRANGEMENT:</b> .....	<i>Series</i>	<i>Parallel</i>	
FILAMENT VOLTAGE (DC).....	2.8	1.4	volts
FILAMENT CURRENT.....	0.05	0.1	ampere
<b>DIRECT INTERELECTRODE CAPACITANCES (Approx.):</b>			
Grid No. 1 to Plate.....		0.2	$\mu\mu\text{f}$
Grid No. 1 to Filament, Grid No. 2, and Grid No. 3.....		5.5	$\mu\mu\text{f}$
Plate to Filament, Grid No. 2, and Grid No. 3.....		3.8	$\mu\mu\text{f}$

**CLASS A<sub>1</sub> AMPLIFIER**

<b>Maximum Ratings, (Design-Maximum Values):</b>			
PLATE VOLTAGE.....	<i>Series</i>	<i>Parallel</i>	
GRID-NO. 2 (SCREEN-GRID) VOLTAGE.....	100 <i>max</i>	100 <i>max</i>	volts
TOTAL CATHODE CURRENT.....	100 <i>max</i>	100 <i>max</i>	volts
# For each 1.4-volt filament section.	6 # <i>max</i>	12 <i>max</i>	ma

<b>Typical Operation:</b>			
Plate Voltage.....	<i>Series</i>	<i>Parallel</i>	
Grid-No. 2 Voltage.....	90	85 90	volts
Grid-No. 1 (Control-Grid) Voltage.....	90	85 90	volts
Peak AF Grid-No. 1 Voltage.....	-4.5	-5 -4.5	volts
Zero-Signal Plate Current.....	4.5	5 4.5	volts
Zero-Signal Grid-No. 2 Current.....	7.7	6.9 9.5	ma
Plate Resistance (Approx.).....	1.7	1.5 2.1	ma
Transconductance.....	0.12	0.12 0.1	megohm
Load Resistance.....	2000	1975 2150	$\mu\text{mhos}$
Maximum Harmonic Distortion.....	10000	10000 10000	ohms
Maximum-Signal Power Output.....	7	10 7	per cent
	240	250 270	mw

**Maximum Circuit Values:**

Grid-No. 1-Circuit Resistance:		2.2 <i>max</i> megohms
For fixed-bias operation.....		2.2 <i>max</i> megohms
For cathode-bias operation.....		

**SHARP-CUTOFF PENTODE**

## 4AU6

Miniature type used as rf amplifier in television receivers employing series-connected heater strings. Outline 11, OUTLINES SECTION. Heater volts (ac/dc), 4.2; amperes, 0.45;

warm-up time (average), 11 seconds. Peak heater-cathode volts: heater negative with respect to cathode, 200 *max*; heater positive with respect to cathode, 200 *max* (the dc component must not exceed 100 volts). Except for heater and heater-cathode ratings, this type is identical with miniature type 6AU6.

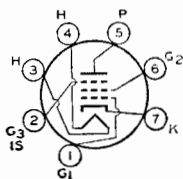

**TWIN DIODE—HIGH-MU TRIODE**

## 4AV6

Miniature type used as combined detector, amplifier, and avc tube in automobile and ac-operated radio receivers employing series-connected heater strings. Outline 11, OUTLINES

SECTION. Heater volts (ac/dc), 4.2; amperes, 0.45; warm-up time (average), 11 seconds. Except for heater rating, this type is identical with miniature type 6AV6.

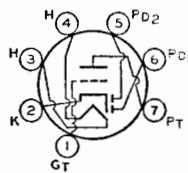

**SHARP-CUTOFF PENTODE**

## 4BC5

Miniature type used in compact radio equipment as an rf or if amplifier at frequencies up to 400 megacycles per second. Outline 11, OUTLINES SECTION. Heater volts (ac/dc), 4.2;

amperes, 0.45; warm-up time (average), 11 seconds. Peak heater-cathode volts: heater negative with respect to cathode, 200 *max*; heater positive with respect to cathode, 200 *max* (the dc component must not exceed 100 volts). Except for heater and heater-cathode rating, this type is identical with miniature type 6BC5.

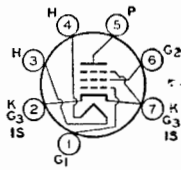

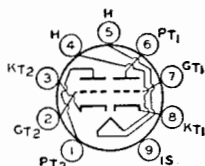

**MEDIUM-MU TWIN TRIODE**

Miniature type used in direct-coupled cathode-drive rf amplifier circuits of vhf television tuners employing series-connected heater strings. Outline 12, OUTLINES SECTION.

**4BC8**

Heater volts (ac/dc), 4.2; amperes, 0.6; warm-up time (average), 11 seconds. Except for heater rating, this type is identical with miniature type 6BC8.

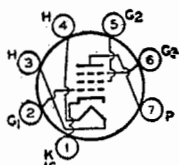

**BEAM TUBE**

Miniature type used as combined limiter, discriminator, and audio-voltage amplifier in intercarrier television and FM receivers employing series-connected heater strings. Outline 13,

**4BN6**

OUTLINES SECTION. Heater volts (ac/dc), 4.2; amperes, 0.45; warm-up time (average), 11 seconds. Peak heater-cathode volts, 200 *max*. When the heater is positive with respect to the cathode, the dc component of the heater-cathode voltage must not exceed 100 volts. Except for heater and heater-cathode ratings, this type is identical with miniature type 6BN6.

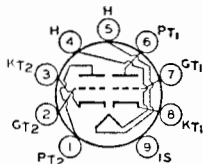

**MEDIUM-MU TWIN TRIODE**

Miniature type used in direct-coupled cathode-drive rf amplifier circuits of vhf television tuners employing series-connected heater strings. Outline 12, OUTLINES SECTION.

**4BQ7-A**

Heater volts (ac/dc), 4.2; amperes, 0.6; warm-up time (average), 11 seconds. Except for heater rating, this type is identical with miniature type 6BQ7-A.

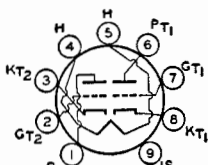

**MEDIUM-MU TWIN TRIODE**

Miniature type used in direct-coupled cathode-drive rf amplifier circuits of vhf television tuners employing series-connected heater strings. Outline 12, OUTLINES SECTION.

**4BS8**

Heater volts (ac/dc), 4.5; amperes, 0.6; warm-up time (average), 11 seconds. Except for heater rating, this type is identical with miniature type 6BS8.

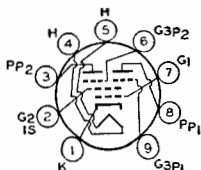

**SHARP-CUTOFF TWIN PENTODE**

Miniature type used as combined sync separator, sync clipper, and agc amplifier tube in television receivers employing series-connected heater strings. Outline 14, OUTLINES SECTION.

**4BU8**

Heater volts (ac/dc), 4.2; amperes, 0.45; warm-up time (average), 11 seconds. Except for heater rating, this type is identical with miniature type 6BU8.

**SEMIREMOTE-CUTOFF PENTODE**

**4BZ6**

Miniature type used in gain-controlled video if stages of television receivers employing series-connected heater strings. Outline 11, OUTLINES SECTION. Heater volts (ac/dc), 4.2;

amperes, 0.45; warm-up time (average), 11 seconds. Except for heater rating, this type is identical with miniature type 6BZ6.

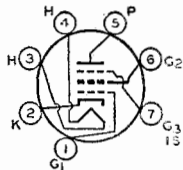

**MEDIUM-MU TWIN TRIODE**

**4BZ7**

Miniature type used in direct-coupled cathode-drive rf amplifier circuits of vhf television tuners employing series-connected heater strings. Outline 12, OUTLINES SECTION.

Heater volts (ac/dc), 4.2; amperes, 0.6; warm-up time (average), 11 seconds. Except for heater rating, this type is identical with miniature type 6BZ7.

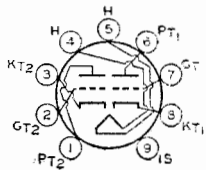

**SHARP-CUTOFF PENTODE**

**4CB6**

Miniature type used as if and as rf amplifier in television receivers employing series-connected heater strings. Outline 11, OUTLINES SECTION.

Heater volts (ac/dc), 4.2; amperes, 0.45; warm-up time (average), 11 seconds. Peak heater-cathode volts: heater negative with respect to cathode, 300 max (the dc component must not exceed 200 volts); heater positive with respect to cathode, 200 max (the dc component must not exceed 100 volts). Except for heater and heater-cathode ratings, this type is identical with miniature type 6CB6-A.

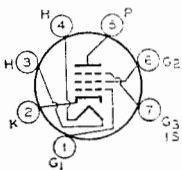

**PENTAGRID AMPLIFIER**

**4CS6**

Miniature type used as a gated amplifier in television receivers. In such service, it may be used as a combined sync separator and sync clipper. Outline 11, OUTLINES SECTION.

Heater volts (ac/dc), 4.2; amperes, 0.45; warm-up time (average), 11 seconds. Except for heater rating, this type is identical with miniature type 6CS6.

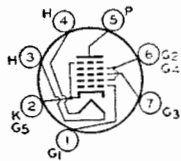

**SHARP-CUTOFF TRIODE**

**4CY5**

Miniature type used as rf amplifier in vhf tuners of television receivers employing series-connected heater strings. Outline 11, OUTLINES SECTION. Heater volts (ac/dc), 4.5 am-

peres, 0.3; warm-up time (average), 11 seconds. Except for heater rating, this type is identical with miniature type 6CY5.

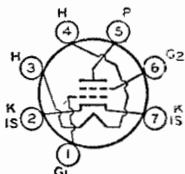

### SHARP-CUTOFF PENTODE

## 4DE6

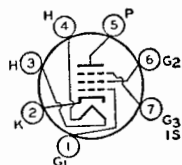

Miniature type used in the gain-controlled picture if stages of television receivers utilizing an intermediate frequency in the order of 40 megacycles per second. Also used as an rf amplifier

in vhf television tuners. Outline 11, OUTLINES SECTION. Heater volts (ac/dc), 4.2; amperes, 0.45; warm-up time (average), 11 seconds. Except for heater rating, this tube is identical with miniature type 6DE6.

### SHARP-CUTOFF PENTODE

## 4DT6 4DT6-A

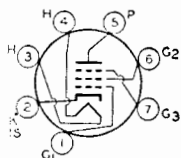

Miniature types used as FM detector in television receivers employing series-connected heater strings. Outline 11, OUTLINES SECTION. Heater volts (ac/dc), 4.2; amperes, 0.45;

warm-up time (average), 11 seconds. Except for heater rating, these types are identical with miniature types 6DT6 and 6DT6-A, respectively.

### VARIABLE-MU TWIN TRIODE

## 4ES8

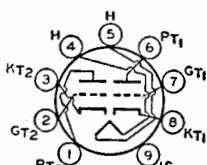

Miniature type used in direct-coupled cathode-drive rf amplifier circuits of television receivers employing series-connected heater strings. Outline 12, OUTLINES SECTION.

Heater volts (ac/dc), 4; amperes, 0.6; warm-up time (average), 11 seconds. Except for heater rating, this type is identical with miniature type 6ES8.

### SHARP-CUTOFF PENTODE

## 4EW6

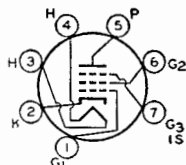

Miniature type used in the gain-controlled picture-if stages of vhf television receivers operating at an intermediate frequency in the order of 40 megacycles per second. Outline 11,

OUTLINES SECTION. Heater volts (ac/dc), 4.2; amperes, 0.6; warm-up time (average), 11 seconds. Except for heater rating, this type is identical with miniature type 6EW6.

### SHARP-CUTOFF TWIN PENTODE

## 4GS8 /4BU8

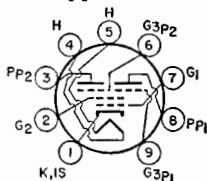

Miniature type used as combined sync separator, sync clipper, and age amplifier tube in television receivers employing series-connected heater strings. Outline 14, OUTLINES SECTION.

Tube requires miniature nine-contact socket and may be mounted in any position.

HEATER VOLTAGE (AC/DC).....	4.2	volts
HEATER CURRENT.....	0.45	ampere
HEATER WARM-UP TIME (Average).....	11	seconds
DIRECT INTERELECTRODE CAPACITANCES:		
Grid No.3 to Plate (Each Unit).....	2	$\mu\text{f}$
Grid No.1 to All Other Electrodes.....	6	$\mu\text{f}$
Grid No.3 to All Other Electrodes (Each Unit).....	3.8	$\mu\text{f}$
Plate to All Other Electrodes (Each Unit).....	3.2	$\mu\text{f}$
Grid No.3 of Unit No.1 to Grid No.3 of Unit No.2.....	0.015 max	$\mu\text{f}$

**CLASS A<sub>1</sub> AMPLIFIER**

**Maximum Ratings, (Design-Maximum Values):**

PLATE VOLTAGE (Each Unit).....	300 <i>max</i>	volts
GRID-NO.3 (SUPPRESSOR-GRID) VOLTAGE (Each Unit):		
Peak positive value.....	50 <i>max</i>	volts
DC negative value.....	-50 <i>max</i>	volts
DC positive value.....	3 <i>max</i>	volts
GRID-NO.2 (SCREEN-GRID) VOLTAGE.....	150 <i>max</i>	volts
GRID-NO.1 (CONTROL-GRID) VOLTAGE, Negative bias value.....	-50 <i>max</i>	volts
CATHODE CURRENT.....	12 <i>max</i>	ma
GRID-NO.2 INPUT.....	0.75 <i>max</i>	watt
PLATE DISSIPATION (Each Unit).....	1.1 <i>max</i>	watts
PEAK HEATER-CATHODE VOLTAGE:		
Heater negative with respect to cathode.....	200 <i>max</i>	volts
Heater positive with respect to cathode.....	200 <i>max</i>	volts

**Characteristics:**

*With Both Units Operating*

Plate Voltage (Each Unit).....	100	100	volts
Grid-No.3 Voltage (Each Unit).....	-10	0	volts
Grid-No.2 Voltage.....	67.5	67.5	volts
Grid-No.1 Voltage.....	■	■	volts
Plate Current (Each Unit).....	-	2	ma
Grid-No.2 Current.....	6	3.6	ma
Cathode Current.....	6.1	7.7	ma

*With One Unit Operating\**

Plate Voltage.....	100	100	volts
Grid-No.3 Voltage.....	0	0	volts
Grid-No.2 Voltage.....	67.5	67.5	volts
Grid-No.1 Voltage.....	0	■	volts
Grid-No.3 Transconductance.....	-	270	μmbos
Grid-No.1 Transconductance.....	1200	-	μmbos
Plate Current.....	-	2	ma
Grid-No.3 Voltage (Approx.) for plate current of 100 μa.....	-	-3.7	volts
Grid-No.1 Voltage (Approx.) for plate current of 100 μa.....	-	-2	volts

**Maximum Circuit Values:**

Grid-No.3-Circuit Resistance (Each Unit).....	0.5 <i>max</i>	megohm
Grid-No.1-Circuit Resistance.....	0.5 <i>max</i>	megohm

- \* The dc component must not exceed 100 volts.
- Adjusted to give a dc grid-No.1 current of 100 microamperes.
- With plate and grid No.3 of the other unit connected to ground.

**DIODE—SHARP-CUTOFF  
PENTODE**

**5AM8**

Miniature type used in diversified applications in television receivers employing series-connected heater strings. The pentode unit is used as an amplifier and the high-perveance diode as a

detector or dc restorer. Outline 12, OUTLINES SECTION. Heater volts (ac/dc), 4.7; amperes, 0.6; warm-up time (average), 11 seconds. Except for heater rating, this type is identical with miniature type 6AM8-A.

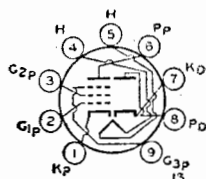

**MEDIUM-MU TRIODE—  
SHARP-CUTOFF PENTODE**

**5AN8**

Miniature type used in a wide variety of applications in television receivers employing series-connected heater strings. The pentode unit is used as an amplifier and the triode unit is

used in oscillator or sync circuits. Outline 12, OUTLINES SECTION. Heater volts (ac/dc), 4.7; amperes, 0.6; warm-up time (average), 11 seconds. Except for heater rating, this type is identical with miniature type 6AN8.

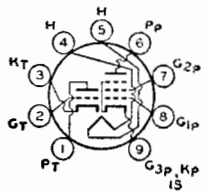

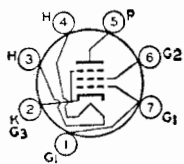

**BEAM POWER TUBE**

Miniature type used as audio amplifier in television receivers employing series-connected heater strings. Outline 13, OUTLINES SECTION. Heater volts (ac/dc), 4.7; amperes, 0.6;

**5A9Q5**

warm-up time (average), 11 seconds. Except for heater rating, this type is identical with miniature type 6A9Q5-A.

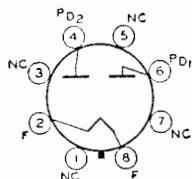

**FULL-WAVE VACUUM RECTIFIER**

Glass octal types used in power supply of television receivers having high dc requirements. Outlines 48 and 38, respectively, OUTLINES SECTION. Type 5AS4-A may be supplied with pins 3, 5, and 7 omitted. Tubes

**5AS4  
5AS4-A**

require octal socket. Vertical mounting is preferred, but horizontal mounting is permissible if pins 1 and 4 are in vertical plane. It is especially important that these tubes, like other power-handling tubes, be adequately ventilated. Heater volts (ac), 5.0; amperes, 3.0. For maximum ratings, typical operation, and curves, refer to type 5U4-GB. Type 5AS4 is a DISCONTINUED type listed for reference only.

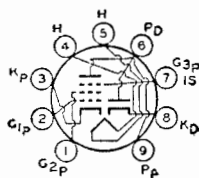

**DIODE—SHARP-CUTOFF  
PENTODE**

Miniature type used in diversified applications in television receivers employing series-connected heater strings. The pentode unit is used as an amplifier and the high-perveance diode as a

**5AS8**

detector or dc restorer. Outline 12, OUTLINES SECTION. Heater volts (ac/dc), 4.7; amperes, 0.6; warm-up time (average), 11 seconds. Except for heater rating, this type is identical with miniature type 6AS8.

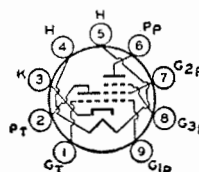

**MEDIUM-MU TRIODE—  
SHARP-CUTOFF PENTODE**

Miniature type used as combined oscillator and mixer tube in television receivers employing series-connected heater strings. Outline 12, OUTLINES SECTION. Heater volts (ac/dc), 4.7;

**5AT8**

amperes, 0.6; warm-up time (average), 11 seconds. Except for heater rating, this type is identical with miniature type 6AT8-A.

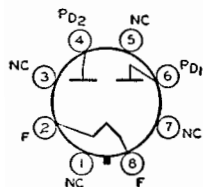

**FULL-WAVE VACUUM RECTIFIER**

Glass octal type used as power supply in television receivers and other equipment having high dc requirements. Maximum dimensions: over-all length, 4-3/4 inches; seated height,

**5AU4**

4-3/16 inches; diameter, 1-11/16 inches. Tube requires octal socket and must be used in vertical position; horizontal operation is permissible only if pins 2 and 4 are in vertical plane. It is especially important that this tube, like other power-handling tubes, be adequately ventilated. Filament volts (ac/dc), 5; amperes, 3.75. For discussion of Rating Chart, refer to INTERPRETATION OF TUBE DATA.

## FULL-WAVE RECTIFIER

### Maximum Ratings:

PEAK INVERSE PLATE VOLTAGE .....	1400 max	volts
PEAK PLATE CURRENT (Per Plate) .....	1075 max	ma
HOT-SWITCHING TRANSIENT PLATE CURRENT (Per Plate), maximum duration 0.2 second .....	5.25 max	amperes
AC PLATE SUPPLY VOLTAGE (Per Plate, rms) .....	See Rating Chart	
DC OUTPUT CURRENT (Per Plate) .....	See Rating Chart	

### Typical Operation:

Filter Input	Capacitor		Choke	
AC Plate-to-Plate Supply Voltage (rms) .....	600	800	1000	volts
Filter-Input Capacitor .....	40	40	-	$\mu$ f
Effective Plate Supply Impedance per Plate .....	30	50	-	ohms
Filter-Input Choke .....	-	-	10	henries
DC Output Current .....	350	325	325	ma
DC Output Voltage at Input to Filter (Approx.) .....	275	395	395	volts

### Characteristics:

Tube Voltage Drop for plate ma=350 (Per Plate) .....	50	volts
--	----	-------

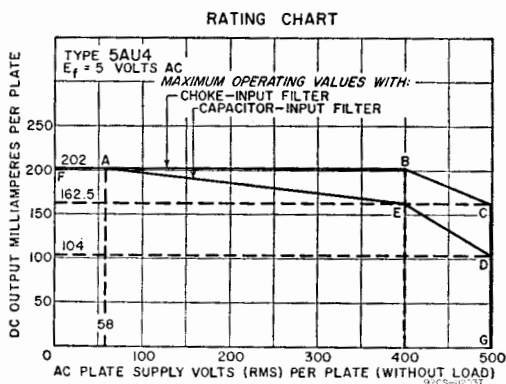

## MEDIUM-MU TRIODE— SHARP-CUTOFF PENTODE

# 5AV8

Miniature type used in a wide variety of applications in television receivers employing series-connected heater strings. Outline 12, **OUTLINES SECTION**. Tube requires miniature nine-contact socket and may be mounted in any position.

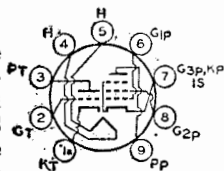

HEATER VOLTAGE (AC/DC) .....	4.7	volts
HEATER CURRENT .....	0.6	ampere
HEATER WARM-UP TIME (Average) .....	11	seconds
<b>DIRECT INTERELECTRODE CAPACITANCES:</b>		
Triode Unit:		
Grid to Plate .....	1.5	$\mu$ f
Grid to Cathode and Heater .....	2.0	$\mu$ f
Plate to Cathode and Heater .....	0.34	$\mu$ f
Pentode Unit:		
Grid No.1 to Plate .....	0.04 max	$\mu$ f
Grid No.1 to Cathode, Heater, Grid No.2, Grid No.3, and Internal Shield .....	7	$\mu$ f
Plate to Cathode, Heater, Grid No.2, Grid No.3, and Internal Shield .....	3.0	$\mu$ f
Triode Grid to Pentode Plate .....	0.005	$\mu$ f
Pentode Grid No.1 to Triode Plate .....	0.006	$\mu$ f
Pentode Plate to Triode Plate .....	0.045	$\mu$ f



**CLASS A<sub>1</sub> AMPLIFIER**

**Maximum Ratings:**

	<i>Triode Unit</i>	<i>Pentode Unit</i>	
PLATE VOLTAGE .....	300 <i>max</i>	300 <i>max</i>	volts
GRID No.2 SUPPLY VOLTAGE .....	-	300 <i>max</i>	volts
GRID -No. 2 (SCREEN-GRID) VOLTAGE .....	-	See curve page 66	
GRID-No.1 (CONTROL-GRID) VOLTAGE, Positive bias value .....	0 <i>max</i>	0 <i>max</i>	volts
PLATE DISSIPATION .....	2.5 <i>max</i>	2 <i>max</i>	watts
GRID-No.2 INPUT:			
For grid-No.2 voltages up to 150 volts .....	-	0.5 <i>max</i>	watt
For grid-No.2 voltages between 150 and 300 volts .....	-	See curve page 66	
PEAK HEATER-CATHODE VOLTAGE:			
Heater negative with respect to cathode .....	200 <i>max</i>	200 <i>max</i>	volts
Heater positive with respect to cathode .....	200 <sup>o</sup> <i>max</i>	200 <sup>o</sup> <i>max</i>	volts

**Characteristics:**

Plate Supply Voltage .....	200	200	volts
Grid-No.2 Supply Voltage .....	-	150	volts
Grid-No.1 Voltage .....	-6	-	volts
Cathode-Bias Resistor .....	-	180	ohms
Amplification Factor .....	19	-	ohms
Plate Resistance (Approx.) .....	5750	300000	ohms
Transconductance .....	3300	6200	μmhos
Grid-No.1 Voltage (Approx.) for plate current of 10 μa .....	-19	-8	volts
Plate Current .....	13	9.5	ma
Grid-No.2 Current .....	-	2.8	ma
Grid-No.1-Circuit Resistance:* .....			
For fixed-bias operation .....	0.5 <i>max</i>	0.25 <i>max</i>	megohm
For cathode-bias operation .....	1.0 <i>max</i>	1.0 <i>max</i>	megohm

<sup>o</sup> The dc component must not exceed 100 volts.

\* If either unit is operating at maximum rated conditions, grid-No.1-circuit resistance for both units should not exceed the stated values.

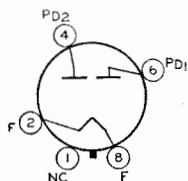

**FULL-WAVE VACUUM RECTIFIER**

Glass octal type used in power supplies of radio and television receivers having high dc requirements. Maximum dimensions: over-all length, 5-3/16 inches; seated length, 4-5/8 inches;

5AW4

diameter, 1-9/16 inches. Tube requires octal socket and may be operated in any position. It is especially important that this tube, like other power-handling tubes, be adequately ventilated. Filament volts (ac/dc), 5; amperes, 3.7. For discussion of Rating Chart, refer to INTERPRETATION OF TUBE DATA.

**FULL-WAVE RECTIFIER**

**Maximum Ratings:**

PEAK INVERSE PLATE VOLTAGE .....	1550 <i>max</i>	volts
PEAK PLATE CURRENT (Per Plate) .....	750 <i>max</i>	ma
HOT-SWITCHING TRANSIENT PLATE CURRENT (Per Plate) maximum duration 0.2 second .....	4 <i>max</i>	amperes
AC PLATE SUPPLY VOLTAGE (Per Plate, rms) .....	See Rating Chart	
DC OUTPUT CURRENT .....	See Rating Chart	

**Typical Operation:**

<i>Filter Input</i>	<i>Capacitor</i>	<i>Choke</i>	
AC Plate-to-Plate Supply Voltage (rms) .....	900	1100	volts
Filter-Input Capacitor .....	10	-	μf
Effective Plate Supply Impedance per Plate .....	153	-	ohms
Filter-Input Choke .....	-	10	henries
DC Output Current .....	250	250	ma
DC Putput Voltage at Input to Filter (Approx.) .....	422	440	volts

**Characteristics:**

Tube Voltage Drop for plate ma = 250 (Per Plate) .....	50	volts
--	----	-------

RATING CHART

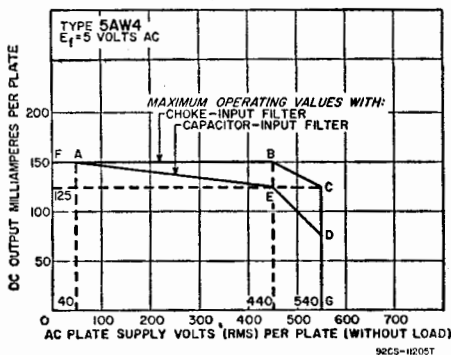

**FULL-WAVE VACUUM RECTIFIER**

**5A4Z**

Lock-in type used in power supply of radio equipment having moderate dc requirements. Outline 20, OUTLINES SECTION. Tube requires lock-in socket. Filament volts (ac), 5.0; amperes, 2.0. Maximum ratings as full-wave rectifier: peak inverse plate volts, 1400 *max*; peak plate ma. (per plate), 375 *max*; dc output ma., 125 *max*. This type is used principally for renewal purposes.

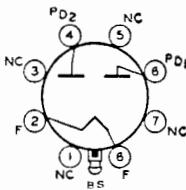

**Typical Operation:**

Filter Input	Capacitor	Choke	
AC Plate-to-Plate Supply Voltage (rms) .....	700	1000	volts
Filter-Input Capacitor .....	4	-	$\mu$ f
Total Effective Plate-Supply Impedance Per Plate† .....	50	-	ohms
Filter-Input Choke .....	-	5	henries
DC Output Current .....	125	125	ma
DC Output Voltage at Input to Filter (Approx.):			
At half-load current (62.5 ma.) .....	392.5	405	volts
At full-load current (125 ma.) .....	340	382	volts
Voltage Regulation (Approx.):			
Half-load to full-load current .....	52.5	23	volts

† When a filter-input capacitor larger than 40  $\mu$ f is used, it may be necessary to use more plate-supply impedance than the value shown in order to limit the peak plate current to the rated value.

**MEDIUM-MU TRIODE—  
SHARP-CUTOFF PENTODE**

**5B8**

Miniature type used as combined vhf oscillator and mixer in television receivers employing series-connected heater strings. Outline 12, OUTLINES SECTION. Tube requires miniature nine-contact socket and may be mounted in any position.

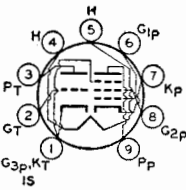

HEATER VOLTAGE (AC/DC) .....	4.7	volts
HEATER CURRENT .....	0.6	ampere
HEATER WARM-UP TIME (Average) .....	11	seconds

**Maximum Ratings:**

	Triode Unit	Pentode Unit	
PLATE VOLTAGE .....	300 <i>max</i>	300 <i>max</i>	volts
GRID-NO.2 (SCREEN-GRID) SUPPLY VOLTAGE .....	-	300 <i>max</i>	volts
GRID-NO.2 VOLTAGE .....	-	See curve page 66	
GRID-NO.1 (CONTROL-GRID) VOLTAGE, Positive bias value .....	0 <i>max</i>	0 <i>max</i>	volts
PLATE DISSIPATION .....	2.5 <i>max</i>	2 <i>max</i>	watts
Grid No.2 INPUT:			
For grid-No.2 voltages up to 150 volts .....	-	0.5 <i>max</i>	watt
For grid-No.2 voltages between 150 and 300 volts .....	-	See curve page 66	
PEAK HEATER-CATHODE VOLTAGE:			
Heater negative with respect to cathode .....	200 <i>max</i>	200 <i>max</i>	volts
Heater positive with respect to cathode .....	200 <i>max</i>	200 <i>max</i>	volts

## CLASS A<sub>1</sub> AMPLIFIER

Characteristics:	<i>Triode Unit</i>	<i>Pentode Unit</i>	
Plate Supply Voltage	200	200	volts
Grid-No.2 Supply Voltage	-	150	volts
Grid Voltage	-6	-	volts
Cathode-Bias Resistor	-	180	ohms
Amplification Factor	19	-	
Plate Resistance (Approx.)	5750	300000	ohms
Transconductance	3300	6200	$\mu$ mhos
Plate Current	13	9.5	ma
Grid-No.2 Current	-	2.8	ma
Grid-No.1 Voltage (Approx.) for plate current of 10 $\mu$ a	-19	-8	volts

### Maximum Circuit Values:

Grid-No.1-Circuit Resistance*:			
For fixed-bias operation	0.5 max	0.25 max	megohms
For cathode-bias operation	1.0 max	1.0 max	megohms

■ The dc component must not exceed 100 volts.

\* If either unit is operated at maximum rated conditions, grid-No.1-circuit resistance for both units should not exceed the stated values.

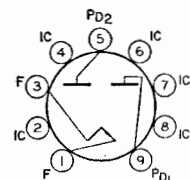

## FULL-WAVE VACUUM RECTIFIER

Novar type used in power supplies of radio equipment and television receivers having high dc requirements. Outline 54, OUTLINES SECTION.

# 5BC3

Tube requires novar nine-contact

socket. Vertical operation is preferred, but tube may be operated in horizontal position if pins 2 and 7 are in vertical plane. It is especially important that this tube, like other power-handling tubes, be adequately ventilated.

FILAMENT VOLTAGE(AC)	5	volts
FILAMENT CURRENT	3	amperes

## FULL-WAVE RECTIFIER

### Maximum Ratings, (Design-Maximum Values):

PEAK INVERSE PLATE VOLTAGE	1700 max	volts
PEAK PLATE CURRENT (Per Plate)	1 max	ampere
HOT-SWITCHING TRANSIENT PLATE CURRENT (Per Plate) <sup>o</sup>	5 max	amperes
AC PLATE-SUPPLY VOLTAGE (Per Plate, rms)	See Rating Chart	
DC OUTPUT CURRENT (Per Plate)	See Rating Chart	

### Typical Operation with Capacitor Input to Filter:

AC Plate-to-Plate Supply Voltage (rms)	600	900	1100	volts
Filter-Input Capacitor <sup>■</sup>	40	40	40	$\mu$ l
Total Effective Plate-Supply Impedance per Plate	21	67	97	ohms
DC Output Voltage at Input to Filter (Approx.):				
At load current of:				
300 ma	290	-	-	volts
275 ma	-	460	-	volts
162 ma	-	-	630	volts
150 ma	335	-	-	volts
137.5 ma	-	520	-	volts
81 ma	-	-	680	volts

### Typical Operation with Choke Input to Filter:

AC Plate-to-Plate Supply Voltage (rms)	900	1100	volts
Filter-Input Choke	10	10	henries
DC Output Voltage at Input to Filter (Approx.):			
At load current of:			
348 ma	340	-	volts
275 ma	-	440	volts
174 ma	355	-	volts
137.5 ma	-	455	volts

<sup>o</sup> If hot switching is regularly required in operation, the use of choke-input circuits is recommended. Such circuits limit the hot-switching current to a value no higher than that of the peak plate current. When capacitor-input circuits are used, a maximum peak current value per plate of 5 amperes during the initial cycles of the hot-switching transient should not be exceeded.

■ Higher values of capacitance than indicated may be used, but the effective plate-supply impedance may have to be increased to prevent exceeding the maximum rating for peak plate current.

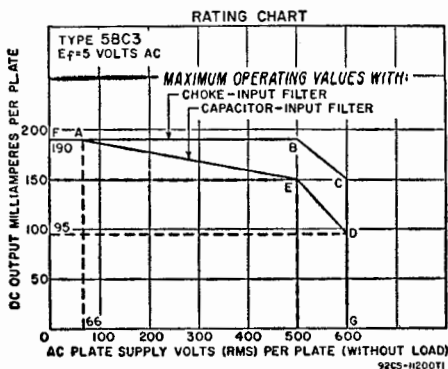

**MEDIUM-MU TRIODE—  
SHARP-CUTOFF PENTODE**

**5BE8**

Miniature type used as a combined vhf oscillator and mixer tube in television receivers employing a series-connected heater string. Outline 12, OUTLINES SECTION. Heater volts (ac/dc), 4.7; amperes, 0.6; warm-up time (average), 11 seconds. Tube requires miniature nine-contact socket and may be operated in any position. This type is used principally for renewal purposes.

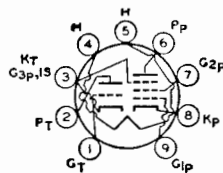

**CLASS A<sub>1</sub> AMPLIFIER**

**Maximum Ratings:**

PLATE VOLTAGE .....	300 max	300 max	volts
GRID-NO.2 (SCREEN-GRID) SUPPLY VOLTAGE .....	-	300 max	volts
GRID-NO.2 VOLTAGE .....	-	See curve page 66	
GRID-NO.1 (CONTROL-GRID) VOLTAGE, Positive bias value .....	0 max	0 max	volts
PLATE DISSIPATION .....	2.5 max	2.8 max	watts
GRID-NO.2 INPUT:			
For grid-No.2 voltages up to 150 volts .....	-	0.5 max	watt
For grid-No.2 voltages between 150 and 300 volts .....	-	See curve page 66	
PEAK HEATER-CATHODE VOLTAGE:			
Heater negative with respect to cathode .....	200 max	200 max	volts
Heater positive with respect to cathode .....	200 <sup>■</sup> max	200 <sup>■</sup> max	volts

<i>Triode</i>	<i>Pentode</i>	
<i>Unit</i>	<i>Unit</i>	
300 max	300 max	volts
-	300 max	volts
-	See curve page 66	
0 max	0 max	volts
2.5 max	2.8 max	watts
-	0.5 max	watt
-	See curve page 66	
200 max	200 max	volts
200 <sup>■</sup> max	200 <sup>■</sup> max	volts

**Characteristics:**

Plate Supply Voltage .....	150	250	volts
Grid-No.2 Supply Voltage .....	-	110	volts
Cathode-Bias Resistor .....	56	68	ohms
Amplification Factor .....	40	-	
Plate Resistance (Approx.) .....	0.005	0.4	megohm
Transconductance .....	8500	5200	μmhos
Grid-No.1 Voltage (Approx.) for plate current of 10 μa .....	-12	-10	volts
Plate Current .....	18	10	ma
Grid-No.2 Current .....	-	3.5	ma

**Maximum Circuit Values:**

Grid-No.1-Circuit Resistance:		
For fixed-bias operation .....	0.5 max	0.25 max
For cathode-bias operation .....	1 max	1 max

0.25 max	megohm
1 max	megohm

■ The dc component must not exceed 100 volts.

**MEDIUM-MU TWIN TRIODE**

**5BK7-A**

Miniature type used in direct-coupled cathode-drive rf amplifier circuits of vhf television tuners utilizing series-connected heater strings. Outline 12, OUTLINES SECTION.

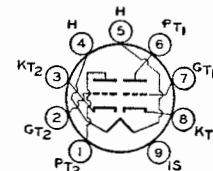

Heater volts (ac/dc), 4.7; amperes, 0.6; warm-up time (average), 11 seconds. Except for heater rating, this type is identical with miniature type 6BK7-B.

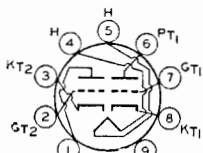

**MEDIUM-MU TWIN TRIODE**

Miniature type used in direct-coupled cathode drive rf amplifier circuits of vhf television tuners employing series-connected heater strings. Outline 12, OUTLINES SECTION.

**5BQ7-A**

Heater volts (ac/dc), 5.6; amperes, 0.45; warm-up time (average), 11 seconds. Except for heater rating, this type is identical with miniature type 6BQ7-A.

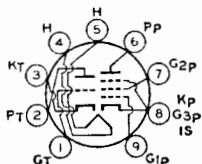

**MEDIUM-MU TRIODE—  
SHARP-CUTOFF PENTODE**

Miniature type used in a wide variety of applications in color and black-and-white television receivers employing series-connected heater strings. Outline 12, OUTLINES SECTION.

**5BR8**

Heater volts (ac/dc), 4.7; amperes, 0.6; warm-up time (average), 11 seconds. Except for heater rating, this type is identical with miniature type 6BR8-A.

**TWIN DIODE—  
SHARP-CUTOFF PENTODE**

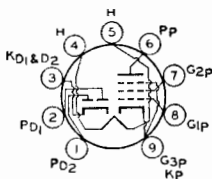

Miniature type used in a variety of applications in television receivers connected heater strings. The pentode unit is used as an if amplifier, video amplifier, age amplifier, or reactance tube. The diode unit is used in automatic-frequency-control and detector circuits. Outline 12, OUTLINES SECTION. Heater volts (ac/dc), 4.7; amperes, 0.6; warm-up time (average), 11 seconds. Tube requires

**5BT8**

miniature nine-contact socket and may be operated in any position. This type is used principally for renewal purposes.

**PENTODE UNIT AS CLASS A<sub>1</sub> AMPLIFIER**

<b>Maximum Ratings:</b>		
PLATE VOLTAGE.....	300 max	volts
GRID-NO.2 (SCREEN-GRID) SUPPLY VOLTAGE.....	300 max	volts
GRID-NO.2 VOLTAGE.....	See curve page 66	
GRID-NO.1 (CONTROL-GRID) VOLTAGE, Positive bias value.....	0 max	volts
GRID-NO.2 INPUT:		
For grid-No.2 voltages up to 150 volts.....	0.5 max	watt
For grid-No.2 voltages between 150 and 300 volts.....	See curve page 66	
PLATE DISSIPATION.....	2 max	watts
PEAK HEATER-CATHODE VOLTAGE:		
Heater negative with respect to cathode.....	200 max	volts
Heater positive with respect to cathode.....	200 max	volts

**Characteristics:**

Plate Supply Voltage.....	200	volts
Grid-No.2 Supply Voltage.....	150	volts
Cathode-Bias Resistor.....	180	ohms
Plate Resistance (Approx.).....	0.3	megohm
Transconductance.....	6200	μmhos
Plate Current.....	9.5	ma
Grid-No.2 Current.....	2.8	ma
Grid-No.1 Voltage (Approx.) for plate current of 10 μa.....	-8	volts

**Maximum Circuit Values:**

Grid-No.1-Circuit Resistance:		
For fixed-bias operation.....	0.25 max	megohm
For cathode-bias operation.....	1.0 max	megohm

**DIODE UNITS**

<b>Maximum Ratings:</b>		
PLATE CURRENT (Each Unit).....	1 max	ma
PEAK HEATER-CATHODE VOLTAGE:		
Heater negative with respect to cathode.....	200 max	volts
Heater positive with respect to cathode.....	200 max	volts

• The dc component must not exceed 100 volts.

**TWIN DIODE—  
SHARP-CUTOFF PENTODE**

**5BW8**

Miniature type used in television receivers employing series-connected heater strings. The pentode unit is used as a sound if amplifier, sound limiter, and agc keyer. The diodes are

used as horizontal phase detectors. Outline 12, OUTLINES SECTION. Heater volts (ac/dc), 4.7; amperes, 0.6; warm-up time (average), 11 seconds. Except for heater rating, this type is identical with miniature type 6BW8

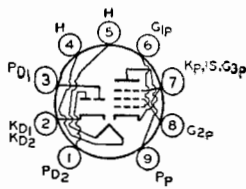

**MEDIUM-MU TRIODE—  
SHARP-CUTOFF PENTODE**

**5CG8**

Miniature type used as combined oscillator and mixer tube in television receivers employing series-connected heater strings. Outline 12, OUTLINES SECTION. Heater volts (ac/dc), 4.7;

amperes, 0.6; warm-up time (average), 11 seconds. Except for heater rating, this type is identical with miniature type 6CG8-A.

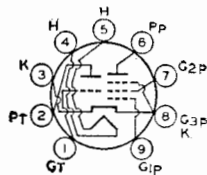

**MEDIUM-MU TRIODE—  
SHARP-CUTOFF TETRODE**

**5CL8  
5CL8-A**

Miniature types used as combined vhf oscillator and mixer in television receivers employing series-connected heater strings. Outline 12, OUTLINES SECTION. Heater volts (ac/dc), 4.7;

amperes, 0.6; warm-up time (average), 11 seconds. Except for heater ratings, types 5CL8 and 5CL8-A are identical with miniature types 6CL8 and 6CL8-A, respectively. Type 5CL8 is a DISCONTINUED type listed for reference only.

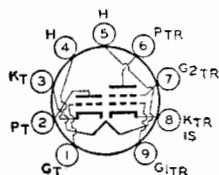

**HIGH-MU TRIODE—  
SHARP-CUTOFF PENTODE**

**5CM8**

Miniature type used in television receivers employing series-connected heater strings. The pentode unit is used as an intermediate-frequency amplifier, a video amplifier, an agc amplifier, or as

a reactance tube. The triode unit is used in sweep-oscillator, sync-separator, sync-clipper, and phase-splitter circuits. Outline 12, OUTLINES SECTION. Heater volts (ac/dc), 4.7; amperes, 0.6. Except for heater rating, this type is identical with miniature type 6CM8.

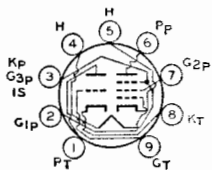

**MEDIUM-MU TRIODE—  
SHARP-CUTOFF TETRODE**

**5CQ8**

Miniature type used in a wide variety of applications in color and black-and-white television receivers employing series-connected heater strings. The tetrode unit is used as a

mixer or amplifier and the triode unit is used in oscillator and rf amplifier circuits. Outline 12, OUTLINES SECTION. Heater volts (ac/dc), 4.7; amperes, 0.6; warm-up time (average), 11 seconds. Except for heater rating, this type is identical with miniature type 6CQ8.

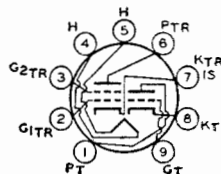

### BEAM POWER TUBE

Miniature type used as vertical deflection amplifier and as audio output tube in television and radio receivers employing series-connected heater strings. Outline 18, OUTLINES SECTION.

## 5CZ5

Heater volts (ac/dc), 4.7; amperes, 0.6; warm-up time (average), 11 seconds. Except for heater rating, this type is identical with miniature type 6CZ5.

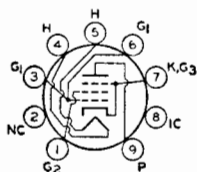

### HIGH-MU TRIODE— SHARP-CUTOFF PENTODE

Miniature type used in television receivers having series-connected heater strings. Pentode used as video or audio if amplifier; triode used as sync amplifier, sync clipper, sync separator, or vertical oscillator. Outline 12, OUTLINES SECTION. Tube requires miniature nine-contact socket and may be operated in any position. Heater volts (ac/dc), 5.2; amperes, 0.6; heater warm-up time (average), 11 seconds.

## 5DH8

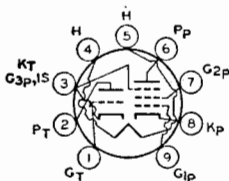

#### CLASS A<sub>1</sub> AMPLIFIER

##### Maximum Ratings, (Design-Maximum Values):

	<i>Triode Unit</i>	<i>Pentode Unit</i>	
PLATE VOLTAGE.....	300 max	300 max	volts
GRID-NO.2 (SCREEN-GRID) SUPPLY VOLTAGE.....	—	300 max	volts
GRID-NO.2 VOLTAGE.....	—	See curve page 66	
GRID-NO.1 (CONTROL-GRID) VOLTAGE			
Positive-bias value.....	0 max	0 max	volts
PLATE DISSIPATION.....	2.0 max	2.2 max	watts
GRID-NO.2 INPUT:			
For grid-No.2 voltages up to 150 volts.....	—	0.55 max	watt
For grid-No.2 voltages between 150 and 300 volts.....	—	See curve page 66	
PEAK HEATER-CATHODE VOLTAGE:			
Heater negative with respect to cathode.....	200 max	200 max	volts
Heater positive with respect to cathode.....	200 <sup>o</sup> max	200 <sup>o</sup> max	volts

##### Characteristics:

	<i>Triode Unit</i>	<i>Pentode Unit</i>	
Plate Voltage.....	250	125	volts
Grid-No.2 Voltage.....	—	125	volts
Grid-No.1 Voltage.....	—	—	
Cathode-Bias Resistor.....	390	56	ohms
Amplification Factor.....	53	—	
Plate Resistance (Approx.).....	0.012	0.15	megohm
Transconductance.....	4400	8600	μmhos
GRID-NO.1 VOLTAGE (Approx.)			
For plate $\mu a = 10$ .....	-10	—	volts
For plate $\mu a = 20$ .....	—	-6	volts

##### Maximum Circuit Values:

Grid-No.1-Circuit Resistance:			
For fixed-bias operation.....	0.5 max	0.25 max	megohm
For cathode-bias operation.....	1.0 max	1.0 max	megohm

#### VERTICAL DEFLECTION OSCILLATOR

*For operation in a 525-line, 30-frame system*

##### Maximum Ratings, (Design-Maximum System):

	<i>Triode Unit</i>	
DC PLATE VOLTAGE.....	300 max	volts
PEAK NEGATIVE-PULSE GRID VOLTAGE.....	400 max	volts
PEAK CATHODE CURRENT.....	35 max	ma
AVERAGE CATHODE CURRENT.....	12 max	ma
PLATE DISSIPATION.....	1 max	watt
PEAK HEATER-CATHODE VOLTAGE:		
Heater negative with respect to cathode.....	200 max	volts
Heater positive with respect to cathode.....	200 <sup>o</sup> max	volts

##### Maximum Circuit Values:

Grid Circuit Resistance:			
For fixed-bias, cathode-bias, or			
grid-resistor-bias operation.....	2.2 max	megohms	

° The dc component must not exceed 100 volts.

**FULL-WAVE VACUUM RECTIFIER**

**5DJ4**

Glass octal type used in power supply of radio and television receivers having high dc requirements. Outline 44, OUTLINES SECTION. Tube requires octal socket; operation in vertical position is preferred, but horizontal operation is permissible if pins 2 and 4 are in vertical plane. It is especially important that this tube, like other power-handling tubes, be adequately ventilated.

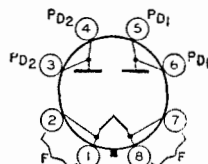

FILAMENT VOLTAGE (AC/DC).....	5	volts
FILAMENT CURRENT.....	3	amperes

**FULL-WAVE RECTIFIER**

Maximum Ratings, (Design-Maximum Values):

PEAK INVERSE PLATE VOLTAGE.....	1700 <i>max</i>	volts
PEAK PLATE CURRENT (Per Plate).....	1 <i>max</i>	ampere
HOT-SWITCHING TRANSIENT PLATE CURRENT (Per Plate).....	5 <i>max</i>	amperes
AC PLATE-SUPPLY VOLTAGE (Per Plate, rms, without load).....	See Rating Chart	
DC OUTPUT CURRENT (Per Plate).....	See Rating Chart	

**Typical Operation:**

Filter Input	Capacitor		Choke	
AC Plate-to-Plate Supply Voltage (rms, without load).....	600	900	1100	volts
Filter-Input Capacitor <sup>o</sup> .....	40	40	-	$\mu$ f
Filter-Input Choke.....	-	-	10	henries
Effective Plate-Supply Impedance per Plate.....	21	67	-	ohms
DC Output Voltage at Input to Filter (Approx.).....	290	460	420	volts
DC Output Current.....	300	275	275	ma

<sup>o</sup> When capacitor values greater than 40  $\mu$ f are used, the effective plate-supply impedance should be increased so that the maximum rating for peak plate current is not exceeded.

**RATING CHART**

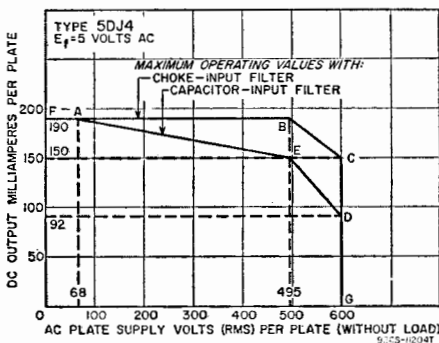

**MEDIUM-MU TRIODE—  
SHARP-CUTOFF PENTODE**

**5EA8**

Miniature type used as combined oscillator and mixer in television receivers employing series-connected heater strings and operating at intermediate frequencies in the order of 40

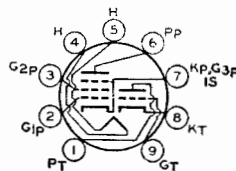

megacycles. Outline 12, OUTLINES SECTION. Heater volts (ac/dc), 4.7; amperes, 0.6; warm-up time (average), 11 seconds. Except for heater rating, this type is identical with miniature type 6EA8.



**MEDIUM-MU TRIODE—  
SHARP-CUTOFF PENTODE**

**5EU8**

Miniature type used as combined oscillator and mixer in television receivers employing series-connected heater strings. Outline 12, OUTLINES SECTION. Heater volts (ac/dc), 4.7;

amperes, 0.6; warm-up time (average), 11 seconds. Cathode warm-up time (time required for the transconductance to reach 6500  $\mu$ mhos when the tube is operated from a cold start with dc plate volts=100, grid volts=0, and heater amperes=0.560), 35 seconds. Except for heater rating and cathode warm-up characteristic, this type is identical with miniature type 6EU8.

**SHARP-CUTOFF PENTODE**

**5EW6**

Miniature type used in the gain-controlled picture-if stages of vhf television receivers operating at an intermediate frequency in the order of 40 megacycles per second. Outline 11,

OUTLINES SECTION. Heater volts (ac/dc), 5.6; amperes, 0.45; warm-up time (average), 11 seconds. Except for heater rating, this type is identical with miniature type 6EW6.

**MEDIUM-MU TRIODE—  
SHARP-CUTOFF PENTODE**

**5FV8**

Miniature type used as combined vertical deflection oscillator and general-purpose or if amplifier in television receivers employing series-connected heater strings. Outline 12, OUTLINES

SECTION. Heater volts (ac/dc), 4.7; amperes, 0.6; warm-up time (average), 11 seconds. Except for heater rating, this type is identical with miniature type 6FV8.

**MEDIUM-MU TRIODE—  
SHARP-CUTOFF PENTODE**

**5GH8**

Miniature type used in multivibrator-type horizontal-deflection circuits in television receivers employing a series heater-string arrangement. Also used for agc-amplifier or sync-separator applications in such receivers. Outline 12, OUTLINES SECTION. Heater

volts (ac/dc), 4.7; amperes, 0.6; warm-up time (average), 11 seconds. Except for heater rating, this type is identical with miniature type 6GH8.

**SEMIREMOTE-CUTOFF PENTODE**

**5GM6**

Miniature type used in gain-controlled picture-if stages of television receivers employing series-connected heater strings and operating at intermediate frequencies in the order of 40

megacycles. Outline 11, OUTLINES SECTION. Heater volts (ac/dc), 5.6; amperes, 0.45; warm-up time (average), 11 seconds. Except for heater rating, this type is identical with miniature type 6GM6.

**MEDIUM-MU TWIN TRIODE**

**5J6**

Miniature type used as combined rf power amplifier and oscillator in television receivers employing series-connected heater strings. Outline 11, OUTLINES SECTION. Heater volts (ac/dc), 4.7; amperes, 0.6; warm-up time (average), 11 seconds. Except for heater rating, this type is identical with miniature type 6J6.

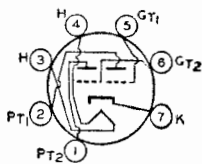

**FULL-WAVE VACUUM RECTIFIER**

**5T4**

Metal type used in power supply of radio equipment having large dc requirements. Outline 7, OUTLINES SECTION. Tube requires octal socket. Vertical tube mounting is preferred but horizontal mounting is permissible if pins 2 and 4 are in vertical plane. Filament volts (ac), 5.0; amperes, 2.0. Maximum ratings as full-wave rectifier: peak inverse plate volts, 1550 max; peak plate ma. (per plate), 675 max; dc output ma., 225 max. This type is used principally for renewal purposes.

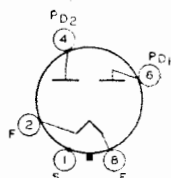

**Typical Operation:**

<i>Filter Input</i>	<i>Capacitor</i>	<i>Choke</i>	
AC Plate-to-Plate Supply Voltage (rms) .....	900	1100	volts
Filter-Input Capacitor .....	4	-	μf
Total Effective Plate-Supply Impedance Per Plate† .....	150	-	ohms
Filter-Input Choke .....	-	10	henries
DC Output Current .....	225	225	ma
<b>DC Output Voltage at Input to Filter (Approx.):</b>			
At half-load current (112.5 ma.) .....	539	465	volts
At full-load current (225 ma.) .....	480	450	volts
<b>Voltage Regulation (Approx.):</b>			
Half-load to full-load current .....	59	15	volts

† When a filter-input capacitor larger than 40 μf is used, it may be necessary to use more plate-supply impedance than the value shown in order to limit the peak plate current to the rated value.

**TRIPLE DIODE—HIGH-MU TRIODE**

**5T8**

Miniature type used as combined AM detector, FM detector, and af voltage amplifier in radio and television receivers employing series-connected heater strings. Outline 12, OUTLINES SECTION. Heater volts (ac/dc), 4.7; amperes, 0.6; warm-up time (average), 11 seconds. Peak heater-cathode volts, 200 max. When the heater is positive with respect to the cathode, the dc component of the heater-cathode voltage must not exceed 100 volts. Except for heater and heater-cathode ratings, this type is identical with miniature type 6T8-A.

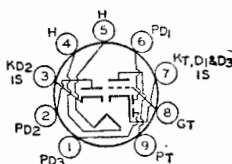

**5U4-G**

**5U4-GB**

**FULL-WAVE VACUUM RECTIFIER**

Glass octal types used in power supplies of radio and television receivers having high dc requirements. 5U4-G Outline 50, 5U4-GB Outline 44, OUTLINES SECTION. Tubes require octal socket. Either type may be supplied with pins 3, 5, and 7 omitted. Vertical mounting is preferred but horizontal mounting is permissible if pins 1 and 4 are in vertical plane. The coated filament is designed to operate from the ac line through a step-down transformer. The voltage at the filament terminals should be 5.0 volts at an average line voltage of 117 volts. It is especially important that these tubes,

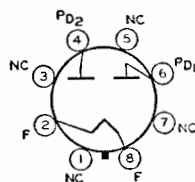

like other power-handling tubes, be adequately ventilated. For discussion of Rating Chart and Operation Characteristics, refer to INTERPRETATION OF TUBE DATA. Maximum ratings for type 5U4-G as full-wave rectifier: peak inverse plate volts, 1550 *max*; peak plate amperes per plate, 0.8 *max* (transient, 4.0 *max*). Type 5U4-G is used principally for renewal purposes.

FILAMENT VOLTAGE (AC) .....	5.0	volts
FILAMENT CURRENT .....	3.0	amperes

<b>Maximum Ratings:</b>	<b>FULL-WAVE RECTIFIER</b>	<b>5U4-GB</b>
PEAK INVERSE PLATE VOLTAGE .....	1550 <i>max</i>	volts
PEAK PLATE CURRENT (Per Plate) .....	1.0 <i>max</i>	ampere
HOT-SWITCHING TRANSIENT PLATE CURRENT (Per Plate) .....	#	
AC PLATE SUPPLY VOLTAGE (Per Plate, rms) .....		See Rating Chart
DC OUTPUT CURRENT (Per Plate) .....		See Rating Chart

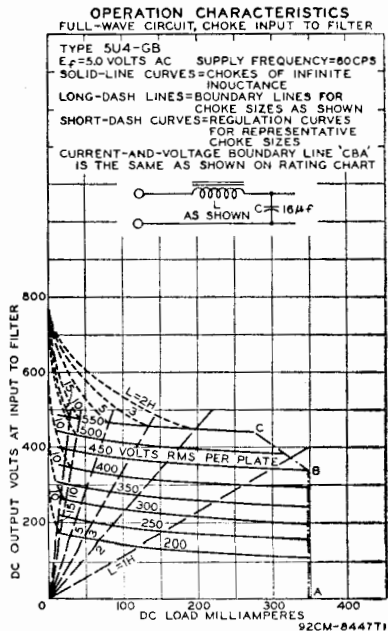
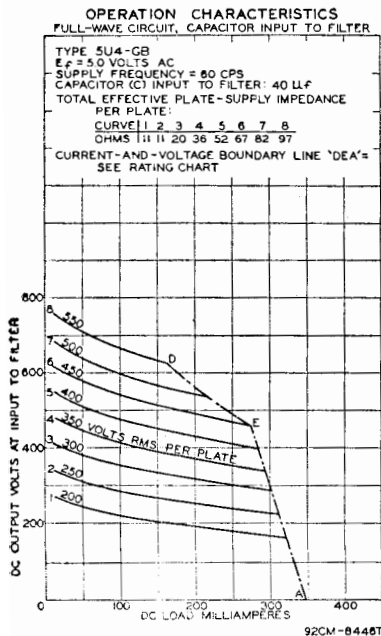
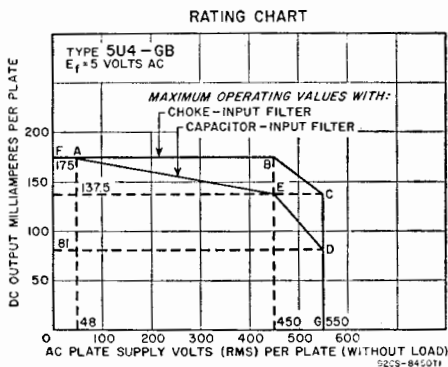

**Typical Operation of 5U4-GB with Capacitor Input to Filter:**

AC Plate-to-Plate Supply Voltage (rms).....	600	900	1100	volts
Filter-Input Capacitor*.....	40	40	40	μf
Total Effective Plate-Supply Impedance per Plate....	21	67	97	ohms
DC Output Voltage at Input to Filter (Approx.):				
At half-load current of	{ 150 ma.....	335	-	-
	{ 137.5 ma.....	-	520	-
	{ 81 ma.....	-	-	680
At full-load current of	{ 300 ma.....	290	-	-
	{ 275 ma.....	-	460	-
	{ 162 ma.....	-	-	630
Voltage Regulation (Approx.):				
Half-load to full-load current.....	45	60	50	volts

**Typical Operation of 5U4-GB with Choke Input to Filter:**

AC Plate-to-Plate Supply Voltage (rms).....	900	1100	volts	
Filter-Input Choke.....	10	10	henries	
DC Output Voltage at Input to Filter (Approx.):				
At half-load current of	{ 174 ma.....	355	-	-
	{ 137.5 ma.....	-	455	-
At full-load current of	{ 348 ma.....	340	-	-
	{ 275 ma.....	-	440	-
Voltage Regulation (Approx.):				
Half-load to full-load current.....	15	15	volts	

‡ If hot switching is regularly required in operation, the use of choke-input circuits is recommended. Such circuits limit the hot-switching current to a value no higher than that of the peak plate current. When capacitor-input circuits are used, a maximum peak current value per plate of 4.6 amperes during the initial cycles of the hot-switching transient should not be exceeded.

\* Higher values of capacitance than indicated may be used, but the effective plate-supply impedance may have to be increased to prevent exceeding the maximum rating for peak plate current.

**MEDIUM-MU TRIODE—  
SHARP-CUTOFF PENTODE**

**5U8**

Miniature type used as combined oscillator and mixer tube in AM FM receivers and television receivers employing series-connected heater strings. Outline 12, OUTLINES SECTION.

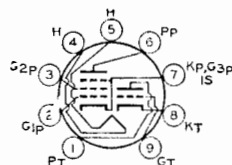

Heater volts (ac/dc), 4.7; amperes, 0.6; warm-up time (average), 11 seconds. Except for heater rating, this type is identical with miniature type 6U8-A.

**FULL-WAVE VACUUM RECTIFIER**

**5V3  
5V3-A**

Glass octal types used as power supply in color television receivers and other equipment having high dc requirements. Outline 44, OUTLINES SECTION. Tubes require octal socket.

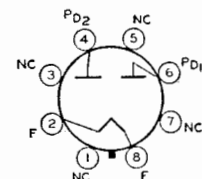

Vertical mounting is preferred, but horizontal mounting is permissible if pins 2 and 4 are in vertical plane. It is especially important that these tubes, like other power-handling tubes, be adequately ventilated. For discussion of Rating Chart, refer to INTERPRETATION OF TUBE DATA.

	<b>5V3</b>	<b>5V3-A</b>	
FILAMENT VOLTAGE (AC/DC).....	5.0	5.0	volts
FILAMENT CURRENT.....	3.8	3	amperes

**FULL-WAVE RECTIFIER**

	<b>5V3</b>	<b>5V3-A</b>	
	<i>Design-Center Values</i>	<i>Design-Maximum Values</i>	
PEAK INVERSE PLATE VOLTAGE.....	1400 max	1550 max	volts
PEAK PLATE CURRENT (Per Plate).....	1.2 max	1.4 max	amperes
HOT-SWITCHING TRANSIENT PLATE CURRENT (Per Plate).....	5.5 max	6.6 max	amperes
AC PLATE-SUPPLY VOLTAGE (Per Plate, rms, without load)....	See Rating Chart	550 max	volts
DC OUTPUT CURRENT (Per Plate).....	Chart	415 <sup>o</sup> max	ma

<sup>o</sup> With capacitor-input filter for ac plate-supply volts (rms, per plate, without load) = 470.

### Typical Operation:

Filter Input	5V3		5V3-A		
	Capacitor Choke		Capacitor Choke		
AC Plate-to-Plate Supply Voltage (rms).....	850	1000	850	1000	volts
Filter-Input Capacitor.....	40	-	40	-	$\mu$ f
Effective Plate-Supply Impedance per Plate.....	56	-	50	-	ohms
Minimum Filter-Input Choke.....	-	10	-	10	henries
DC Output Current.....	350	350	350	350	ma
DC Output at Input to Filter (Approx.).....	430	385	440	390	volts

### Characteristics:

	5V3	5V3-A	
Tube Voltage Drop, for plate ma = 350 (per plate).....	47	42	volts

■ When capacitor values greater than 40  $\mu$ f are used, the effective plate-supply impedance should be increased so that the maximum rating for peak plate current is not exceeded.

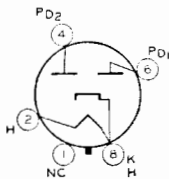
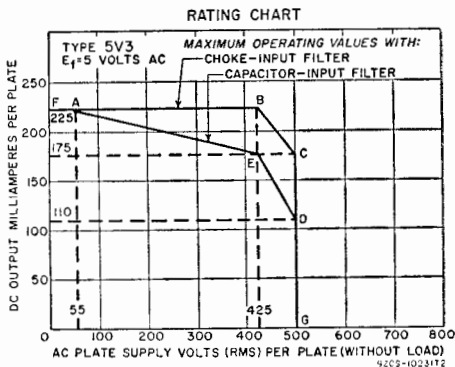

## FULL-WAVE VACUUM RECTIFIER

Glass octal types used in full-wave power supplies having high dc requirements. Outlines 42 and 31, respectively, OUTLINES SECTION. Tubes require octal socket and may be

mounted in any position. The heater is designed to operate from the ac line through a step-down transformer. The voltage at the heater terminals should be 5.0 volts under operating conditions at an average line voltage of 117 volts. It is especially important that these tubes, like other power-handling tubes, be adequately ventilated.

HEATER VOLTAGE (AC/DC).....	5.0	volts
HEATER CURRENT.....	2.0	ampere

# 5V4-G 5V4-GA

### FULL-WAVE RECTIFIER

#### Maximum Ratings:

PEAK INVERSE PLATE VOLTAGE.....	1400 max	volts
AC PLATE-SUPPLY VOLTAGE (Per Plate, rms):		
With capacitor-input filter.....	375 max	volts
With choke-input filter.....	500 max	volts
PEAK PLATE CURRENT (Per Plate).....	525 max	ma
DC OUTPUT CURRENT.....	175 max	ma

### Typical Operation:

Filter Input	Capacitor	Choke	
AC Plate-to-Plate Supply Voltage (rms).....	750	1000	volts
Filter-Input Capacitor.....	10	-	$\mu$ f
Total Effective Plate-Supply Impedance per Plate.....	100	-	ohms
Filter-Input Choke.....	-	4	henries
DC Output Voltage at Input to Filter (Approx.) for dc output current of 175 ma.....	410	410	volts

⊗ Higher values of capacitance than indicated may be used, but the effective plate-supply impedance may have to be increased to prevent exceeding the maximum rating for peak plate current.



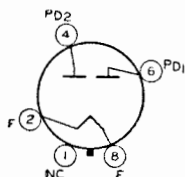

### FULL-WAVE VACUUM RECTIFIER

Glass octal types used in power supply of radio equipment having moderate dc requirements. Type 5Y3-G, Outline 42; type 5Y3-GT, Outline 25, OUTLINES SECTION. Tubes require

**5Y3-G**  
**5Y3-GT**

octal socket. Vertical tube mounting is preferred, but horizontal mounting is permissible if pins 2 and 8 are in horizontal plane. It is especially important that these tubes, like other power-handling tubes, be adequately ventilated. For discussion of Rating Chart and Operation Characteristics, refer to INTERPRETATION OF TUBE DATA. Maximum ratings for type 5Y3-G as full-wave rectifier: peak inverse-plate volts, 1400 *max*; peak plate ma. per plate, 375 *max*. Type 5Y3-G is a DISCONTINUED type listed for reference only.

FILAMENT VOLTAGE (AC).....	5.0	volts
FILAMENT CURRENT.....	2.0	amperes

#### FULL-WAVE RECTIFIER

<b>Maximum Ratings:</b>		<i>5Y3-GT</i>	
PEAK INVERSE PLATE VOLTAGE.....	1400 <i>max</i>	volts	
PEAK PLATE CURRENT (Per Plate).....	440 <i>max</i>	ma	
HOT-SWITCHING TRANSIENT PLATE CURRENT (Per Plate).....	2.5 <i>max</i>	amperes	
AC PLATE SUPPLY VOLTAGE (Per Plate, rms).....		See Rating Chart	
DC OUTPUT CURRENT (Per Plate).....		See Rating Chart	

#### Typical Operation of 5Y3-GT with Capacitor Input to Filter:

AC Plate-to-Plate Supply Voltage (rms).....	700	1000	volts
Filter Input Capacitor*.....	20	10	$\mu$
Effective Plate-Supply Impedance per Plate.....	50	140	ohms
DC Output Voltage at Input to Filter (Approx.):			
At half-load current of { 62.5 ma .....	390	-	volts
42 ma .....	-	610	volts
At full-load current of { 125 ma .....	360	-	volts
84 ma .....	-	560	volts
Voltage Regulation (Approx.):			
Half-load to full-load current.....	40	50	volts

#### RATING CHART

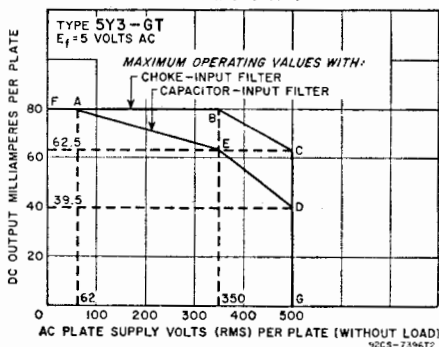

#### Typical Operation of 5Y3-GT with Choke Input to Filter:

AC Plate-to-Plate Supply Voltage (rms).....	700	1000	volts
Filter Input Choke#.....	10	10	henries
DC Output Voltage at Input to Filter (Approx.):			
At half-load current of { 75 ma .....	270	-	volts
62.5 ma .....	-	405	volts
At full-load current of { 150 ma .....	245	-	volts
125 ma .....	-	380	volts
Voltage Regulation (Approx.): Half-load to full-load current.....	25	15	volts

\* Higher values of capacitance than indicated may be used but the effective plate supply impedance may have to be increased to prevent exceeding the maximum rating for hot-switching transient plate current.

# This value is adequate to maintain optimum regulation in the region to the right of line L=10H on curve OPERATION CHARACTERISTICS with Choke Input to Filter, provided the load currents are not less than 35 ma., and 50 ma., respectively, for Plate-to-Plate supply voltages of 700 and 1000 volts (rms).

OPERATION CHARACTERISTICS  
FULL-WAVE CIRCUIT, CAPACITOR INPUT TO FILTER

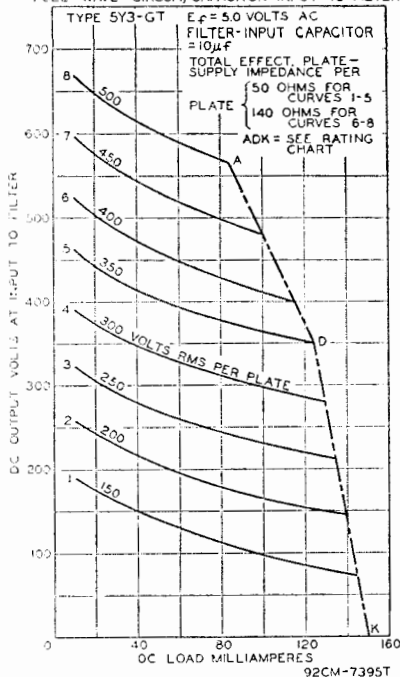

OPERATION CHARACTERISTICS  
FULL-WAVE CIRCUIT, CHOKE INPUT TO FILTER

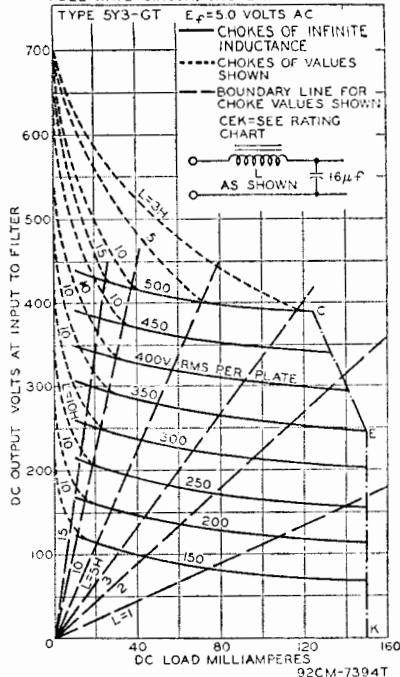

**5Y4-G**  
**5Y4-GA**  
**5Y4-GT**

**FULL-WAVE VACUUM RECTIFIER**

Glass octal types used in power supplies of radio equipment having moderate DC requirements. Outlines 42, 25 and 44, respectively, OUTLINES SECTION. Tubes require octal socket. Type 5Y4-GT is supplied with pins 4

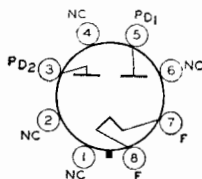

and 6 missing. Vertical tube mounting is preferred, but horizontal mounting is permissible: if pins 2 and 7 are in horizontal plane (5Y4-G); if pins 1 and 4 are in vertical plane (5Y4-GA); if pins 2 and 3 are in vertical plane (5Y4-GT). It is especially important that these tubes, like other power handling tubes, be adequately ventilated. For discussion of Rating Chart, refer to INTERPRETATION OF TUBE DATA. Maximum ratings for type 5Y4-G as full-wave rectifier: peak inverse plate volts, 1400 *max*; peak plate ma. per plate, 375 *max* (transient amperes, 2.2 *max*). Type 5Y4-G is a DISCONTINUED type listed for reference only.

FILAMENT VOLTAGE (AC/DC) .....	5.0	volts
FILAMENT CURRENT .....	2.0	amperes

**FULL-WAVE RECTIFIER**

<b>Maximum Ratings:</b>		
PEAK INVERSE PLATE VOLTAGE .....	1400 <i>max</i>	volts
PEAK PLATE CURRENT (Per Plate) .....	400 <i>max</i>	ma
HOT-SWITCHING TRANSIENT PLATE CURRENT .....	2.2 <i>max</i>	amperes
AC PLATE SUPPLY VOLTAGE (Per Plate, rms) .....	See Rating Chart	
DC OUTPUT CURRENT (Per Plate) .....	See Rating Chart	

5Y4-GA  
 5Y4-GT



**Typical Operation of 5Y4-GA & 5Y4-GT:**

<i>Filter Input</i>	<i>Capacitor</i>	<i>Choke</i>	
AC Plate-to-Plate Supply Voltage (rms) .....	700	1000	volts
Filter-Input Capacitor <sup>2</sup> .....	10	-	$\mu$ f
Total Effective Plate-Supply Impedance per Plate .....	50	-	ohms
Filter-Input Choke .....	-	10	henries
DC Output Current .....	125	125	ma
DC Output Voltage at Input to Filter (Approx.):			
At full-load current (125 ma.) .....	350	390	volts

**Characteristics, Instantaneous Test Condition:**

Tube Voltage Drop for plate ma = 125 (per plate) .....

60	volts
----	-------

<sup>2</sup> Values of capacitance greater than 20  $\mu$ f may be used, provided the plate-supply impedance is increased to prevent exceeding the maximum peak-plate-current rating.

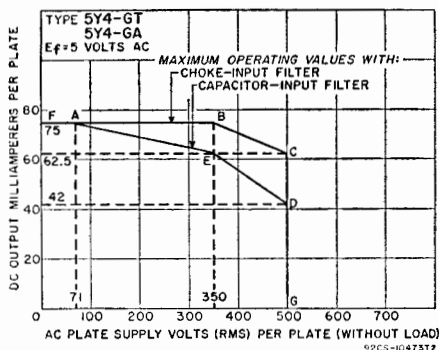

**FULL-WAVE VACUUM RECTIFIER**

Glass type used in power supply of radio equipment having large dc requirements. Outline 51, OUTLINES SECTION. Tube requires four-contact socket. Vertical mounting is preferred but horizontal mounting is permissible if pins 1 and 4 are in horizontal plane. Filament volts (ac), 5.0; amperes, 3.0. Maximum ratings as full-wave rectifier: peak inverse plate volts, 1550 *max*; peak plate ma. per plate, 675 *max*. Type 5Z3 is used principally for renewal purposes.

**5Z3**

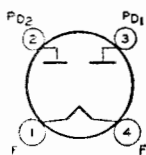

**FULL-WAVE VACUUM RECTIFIER**

Metal type used in power supply of radio equipment having moderate dc requirements. Outline 6, OUTLINES SECTION. Tube requires octal socket and may be mounted in

**5Z4**

any position. Heater volts (ac), 5.0; amperes, 2.0. Maximum ratings: peak inverse plate volts, 1400 *max*; peak plate ma. per plate, 375 *max*. Typical operation as full-wave rectifier with capacitor-input filter: ac plate-to-plate supply volts (rms), 700; total effective plate-supply impedance per plate, 50 ohms; dc output ma., 125. Typical operation with choke-input filter: ac plate-to-plate supply volts, 1000; minimum filter-input choke, 5 henries; dc output ma., 125.

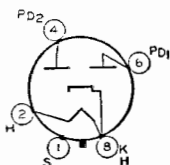

**POWER TRIODE**

Glass type used in output stage of radio receivers. Outline 51, OUTLINES SECTION. Tube requires four-contact socket. Filament volts (ac/dc), 6.3; amperes, 1.0. This type is identical electrically with type 6B4-G. Type 6A3 is a DISCONTINUED type listed for reference only.

**6A3**

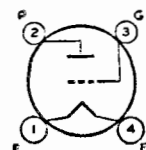

**HIGH-MU TWIN POWER TRIODE**

Glass type used in output stage of ac-operated receivers as a class B power amplifier or with units in parallel as a class A<sub>1</sub> amplifier to drive a 6A6 as class B amplifier. Outline 43, OUTLINES SECTION. Tube requires medium seven-contact (0.855-inch, pin-circle diameter) socket. Filament volts (ac/dc), 6.3; amperes, 0.8. This type is electrically identical with type 6N7. Type 6A6 is a DISCONTINUED type listed for reference only.

**6A6**

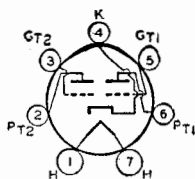

**PENTAGRID CONVERTER**

Glass types used in superheterodyne circuits. Outline 40, OUTLINES SECTION. These types require the small seven-contact (0.75-inch, pin-circle diameter) socket. Except for interelectrode capacitances, the 6A7 is identical electrically with type 6A8. Type 6A7S, now DISCONTINUED, has the external shield connected to cathode. In general, its electrical characteristics are similar to those of the 6A7, but

**6A7**

**6A7S**

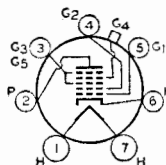

the two types are usually not directly interchangeable. Type 6A7 is used principally for renewal purposes.

**PENTAGRID CONVERTER**

Metal type 6A8 and glass octal types 6A8-G and 6A8-GT used in superheterodyne circuits. 6A8 Outline 4, 6A8-G Outline 39, 6A8-GT Outline 23, OUTLINES SECTION. Tubes require octal socket. Heater volts (ac/dc), 6.3; amperes, 0.3. Maximum ratings: plate, grids-No.3-and-No.5-supply, and grid-No.2-supply volts, 300 *max*; grids-No.3-and-No.5 (screen-grid) volts, 100 *max*; grid-No.2 (anode-grid)

**6A8**  
**6A8-G**  
**6A8-GT**

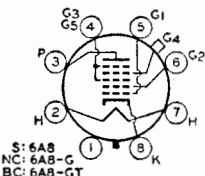

volts, 200 *max*; grid-No.4 (control-grid) volts, 0 *max*; plate dissipation, 1 *max* watt; grids-No.3-and-No.5 input, 0.3 *max* watt; grid-No.2 input, 0.75 *max* watt; total cathode ma., 14 *max*; peak heater-cathode volts, 90 *max*. These types are used principally for renewal purposes.

Characteristics:	CONVERTER		
Plate Voltage . . . . .	100	250	volts
Grids-No. 3-and-No. 5 Voltage . . . . .	50	100	volts
Grid-No. 2 Voltage . . . . .	100	-	volts
Grid-No. 2 Supply Voltage . . . . .	-	250*	volts
Grid-No. 4 Voltage . . . . .	-1.5	-3	volts
Grid-No. 1 (Oscillator-Grid) Resistor . . . . .	50000	50000	ohms
Plate Resistance (Approx.) . . . . .	0.6	0.36	megohm
Conversion Transconductance . . . . .	360	550	μmhos
Plate Current . . . . .	1.1	3.5	ma
Grids-No. 3-and-No. 5 Current . . . . .	1.3	2.7	ma
Grid-No. 2 Current . . . . .	2	4	ma
Grid-No. 1 Current . . . . .	0.25	0.4	ma
Total Cathode Current . . . . .	4.6	10.6	ma

\* Grid-No. 2 supply voltages in excess of 200 volts require use of 20000-ohm voltage-dropping resistor bypassed by 0.1-μf capacitor.

**HIGH-MU TRIODE**

Miniature type used as cathode-drive amplifier, frequency converter, or oscillator at frequencies up to about 300 megacycles per second particularly in television and FM receivers. Outline

**6AB4**

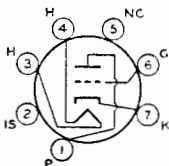

11, OUTLINES SECTION. Tube requires miniature seven-contact socket and may be mounted in any position. Heater volts (ac/dc), 6.3; amperes, 0.15. For maximum ratings, characteristics, and curves, refer to type 12AT7.

### ELECTRON-RAY TUBE

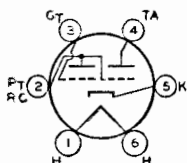

Glass type with triode unit used to indicate visually by means of a fluorescent target the effects of a change in a controlling voltage. It is used as a convenient means of indicating accurate radio-receiver tuning. Outline 34, OUTLINES SECTION. Tube requires six-contact socket. Heater volts (ac/dc), 6.3; amperes, 0.15. Maximum ratings in indicator service: triode-plate supply volts, 180 *max*; fluorescent-target volts, 180 *max*, 125 *min*. This type is used principally for renewal purposes.

6AB5/  
6N5

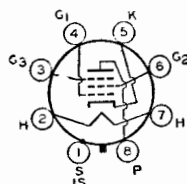

### SHARP-CUTOFF PENTODE

Metal type used in rf and if stages of picture amplifier of television receivers particularly those employing automatic-gain control. Outline 3, OUTLINES SECTION. Tube requires octal socket. Heater volts (ac/dc), 6.3; amperes, 0.45. Maximum ratings as class A<sub>1</sub> amplifier: plate and grid-No.2 supply volts, 300 *max*; grid No.3, connect to cathode at socket; grid-

6AB7

No.2 volts, 200 *max*; plate dissipation, 3.75 *max* watts; grid No.2 input, 0.65 *max* watt. Typical operation: plate and grid-No.2 supply volts, 300; grid-No.3 volts, 0; grid-No.2 series resistor, 30000 ohms; grid-No.1 volts, -3; plate resistance (approx.), 0.7 megohm; transconductance, 5000  $\mu$ hos; grid-No.1 volts for transconductance of 50  $\mu$ hos, -22.5; plate ma., 12.5; grid-No.2 ma., 3.2. This type is used principally for renewal purposes.

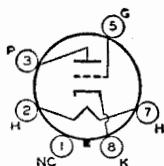

### HIGH-MU POWER TRIODE

Glass octal type used in single-ended or push-pull audio-frequency power amplifiers of the direct-coupled type in which a driver tube develops positive grid bias for the 6AC5-GT output stage. Outline 22, OUTLINES SECTION. This type may be supplied with pin No. 1 omitted. Tube requires octal socket. Heater

6AC5-GT

volts (ac/dc), 6.3; amperes, 0.4. Maximum ratings as push-pull class B power amplifier: plate volts, 250 *max*; peak plate ma., 110 *max*; average plate dissipation, 10 *max* watts. This type is used principally for renewal purposes.

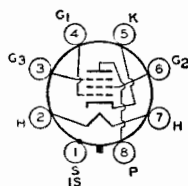

### SHARP-CUTOFF PENTODE

Metal type used in rf and if stages of picture amplifier and the first stages of the video amplifier of television receivers. It is also used as a mixer or oscillator tube in low-frequency appli-

6AC7

cations. Outline 3, OUTLINES SECTION. Tube requires octal socket. When tube is used as a high-gain audio amplifier, heater should be operated from a battery source.

HEATER VOLTAGE (AC/DC) .....	6.3	volts
HEATER CURRENT .....	0.45	ampere

**Maximum Ratings:**

**CLASS A<sub>1</sub> AMPLIFIER**

PLATE VOLTAGE .....	300 <i>max</i>	volts
GRID No.3 (SUPPRESSOR GRID) .....	Connect to cathode at socket	
GRID-No.2 (SCREEN-GRID) VOLTAGE .....	See curve page 66	
GRID-No.2 SUPPLY VOLTAGE .....	300 <i>max</i>	volts
PLATE DISSIPATION .....	3 <i>max</i>	watts
GRID-No.2 INPUT:		
For grid-No.2 voltages up to 150 volts .....	0.4 <i>max</i>	watt
For grid-No.2 voltages between 150 and 300 volts .....	See curve page 66	
PEAK HEATER-CATHODE VOLTAGE:		
Heater negative with respect to cathode .....	90 <i>max</i>	volts
Heater positive with respect to cathode .....	90 <i>max</i>	volts

**Characteristics:**

Plate Supply Voltage .....	300	300	volts
Grid No.3 .....	Connected to cathode at socket		
Grid-No. 2 Supply Voltage .....	150	300	volts
Grid-No. 2 Series Resistor .....	-	60000	ohms
Min. Cathode-Bias Resistor .....	160	160	ohms
Plate Resistance (Approx.) .....	1	1	megohm
Transconductance .....	9000	9000	μmhos
Plate Current .....	10	10	ma
Grid-No. 2 Current .....	2.5	2.5	ma

**Maximum Circuit Values:**

Grid-No.1-Circuit Resistance:			
For cathode-bias operation with fixed grid-No.2 voltage .....	0.25	max	megohm
For cathode-bias operation with series grid-No.2 resistor .....	0.50	max	megohm

**ELECTRON-RAY TUBE**

Glass octal type used to indicate visually, by means of two shadows on the fluorescent target, the effects of changes in the controlling voltages. It is a twin-indicator type and is used as a convenient means of indicating accurate radio-receiver tuning. Maximum over-all length, 2-7/8 inches; maximum diameter, 1-5/16 inches. Heater volts (ac/dc), 6.3; amperes, 0.15. Maximum target volts, 150. This is a DISCONTINUED type listed for reference only.

**6AD6-G**

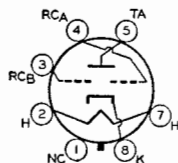

**LOW-MU TRIODE — POWER PENTODE**

Glass octal type used in a push-pull amplifier circuit in conjunction with type 6F6-G. Triode unit serves as phase inverter. Outline 42, OUTLINES SECTION. Tube requires octal socket. Heater volts (ac/dc), 6.3; amperes, 0.85. For typical operation of pentode unit, refer to type 6F6-G. Maximum ratings of pentode unit as class A<sub>1</sub> or push-pull class AB<sub>1</sub> amplifier: plate volts, 375 max; grid-No. 2 volts, 285 max; plate dissipation, 8.5 max watts; grid-No.2 input, 2.7 max watts. Maximum ratings of triode unit as class A<sub>1</sub> amplifier: plate volts, 285 max; plate dissipation, 1.0 max watt. This type is used principally for renewal purposes.

**6AD7-G**

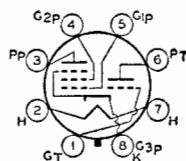

**LOW-MU TRIODE**

Glass octal type used as class A<sub>1</sub> amplifier in ac/dc radio receivers. Outline 22, OUTLINES SECTION. Heater volts (ac/dc), 6.3; amperes, 0.3. Maximum ratings as class A<sub>1</sub> amplifier: plate volts, 300 max; plate dissipation, 2.5 max watts. This is a DISCONTINUED type listed for reference only.

**6AE5-GT**

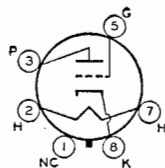

**TWIN-PLATE CONTROL TUBE**

Glass octal type used as a control tube for twin-indicator type electron-ray tubes. Outline 36, OUTLINES SECTION. Contains two triodes with different cutoff characteristics. If ac voltage is applied to the common control grid in suitable circuit, one triode section operates on weak signals while the other operates on strong signals. Heater voltage (ac/dc), 6.3; amperes, 0.15. This is a DISCONTINUED type listed for reference only.

**6AE6-G**

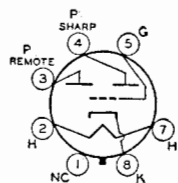

**TWIN-INPUT TRIODE**

Glass octal type used as a voltage amplifier or as a driver for two type 6AC5-GT tubes in dynamic-coupled, push-pull amplifiers. In the latter service, type 6AE7-GT replaces two tubes ordinarily required as drivers. Outline 22, OUTLINES SECTION. Heater volts (ac/dc), 6.3; amperes, 0.5. This is a DISCONTINUED type listed for reference only.

**6AE7-GT**

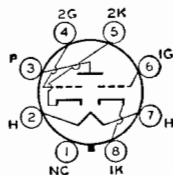

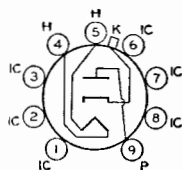

## HALF-WAVE VACUUM RECTIFIER

# 6AF3

Miniature type used as a damper tube in horizontal deflection circuits of television receivers. Outline 17, OUTLINES SECTION, except all vertical dimensions of this type are  $\frac{1}{8}$  inch

greater. Tube requires miniature nine-contact socket and may be mounted in any position. Socket terminals 1, 2, 3, 6, 7, and 8 should not be used as tie points. It is especially important that this tube, like other power-handling tubes, be adequately ventilated.

HEATER VOLTAGE (AC/DC) .....	6.3	volts
HEATER CURRENT .....	1.2	amperes

### DAMPER SERVICE

*For operation in a 525-line, 30-frame system*

Maximum Ratings, (Design-Maximum Values):

PEAK INVERSE PLATE VOLTAGE <sup>‡</sup> .....	4500 <i>max</i>	volts
PEAK PLATE CURRENT .....	750 <i>max</i>	ma
AVERAGE PLATE CURRENT .....	185 <i>max</i>	ma
PEAK HEATER CATHODE VOLTAGE:		
Heater negative with respect to cathode .....	4500 <sup>*</sup> <i>max</i>	volts
Heater positive with respect to cathode .....	300 <sup>‡</sup> <i>max</i>	volts
BULB TEMPERATURE (At hottest point) .....	210 <i>max</i>	°C

<sup>\*</sup> The duration of the voltage pulse must not exceed 15 per cent of one horizontal scanning cycle. In a 525-line, 30-frame system, 15 per cent of one horizontal scanning cycle is 10 microseconds.

<sup>‡</sup> The dc component must not exceed 1000 volts.

<sup>‡</sup> The dc component must not exceed 100 volts.

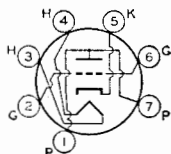

## MEDIUM-MU TRIODE

# 6AF4

## 6AF4-A

Miniature types used as local oscillators in uhf television receivers covering the frequency range of 470 to 890 megacycles per second. 6AF4 Outline 11, 6AF4-A Outline 9, OUTLINES

SECTION. Tubes require miniature seven-contact socket and may be mounted in any position.

HEATER VOLTAGE (AC/DC) .....	6.3	volts
HEATER CURRENT .....	0.225	ampere
DIRECT INTERELECTRODE CAPACITANCES: <sup>*</sup>		
Grid to Plate .....	1.9	μf
Grid to Cathode and Heater .....	2.2	μf
Plate to Cathode and Heater .....	1.4	μf
Heater to Cathode <sup>**</sup> .....	2.2	μf

<sup>\*</sup> With external shield connected to cathode, except as noted.

<sup>\*\*</sup> With external shield connected to plate.

### Characteristics:

### CLASS A<sub>1</sub> AMPLIFIER

Plate Supply Voltage .....	80	volts
Cathode-Bias Resistor .....	150	ohms
Amplification Factor .....	13.5	
Plate Resistance (Approx.) .....	2100	ohms
Transconductance .....	6500	μmhos
Plate Current .....	17.5	ma

### UHF OSCILLATOR

Maximum Ratings, (Design-Maximum Values):

PLATE VOLTAGE .....	150 <i>max</i>	volts
GRID VOLTAGE, Negative-bias value .....	-50 <i>max</i>	volts
GRID CURRENT .....	2 <i>max</i>	ma
PLATE DISSIPATION .....	2.5 <i>max</i>	watts
DC CATHODE CURRENT .....	24 <i>max</i>	ma
PEAK HEATER-CATHODE VOLTAGE:		
Heater negative with respect to cathode .....	50 <i>max</i>	volts
Heater positive with respect to cathode .....	50 <sup>‡</sup> <i>max</i>	volts

**Typical Operation as Oscillator at 1000 Mc:**

Plate Supply Voltage.....	100	volts
Plate Resistor.....	220	ohms
Grid Resistor.....	10000	ohms
Plate Current.....	17	ma
Grid Current (Approx.).....	750	$\mu$ a

**Maximum Circuit Values:**

Grid-Circuit Resistance:	
For fixed-bias operation.....	Not recommended
For cathode-bias operation.....	0.5 <i>max</i> megohm

\*The dc component must not exceed 25 volts.

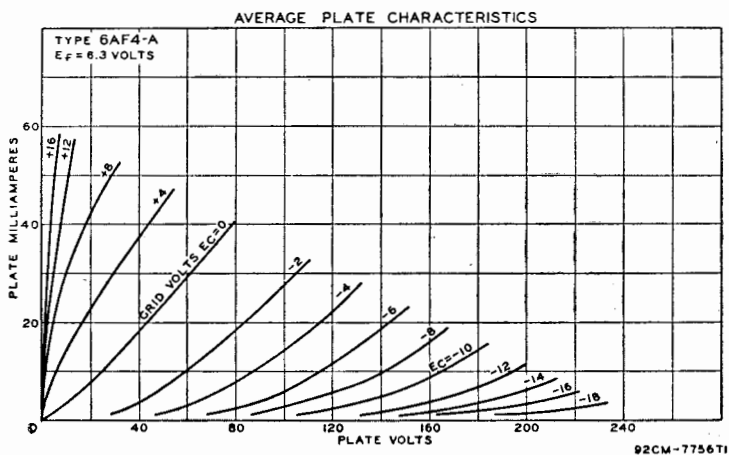

**ELECTRON-RAY TUBE**

**6AF6-G**

Glass octal type used to indicate visually, by means of two shadows on the fluorescent target, the effects of changes in the controlling voltages. It is a twin-indicator type and is used as

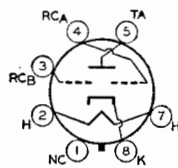

a convenient means of indicating accurate radio-receiver tuning. Maximum overall length, 2-5/16 inches; maximum diameter, 1-5/16 inches. This type may be supplied with pin No.1 omitted. Tube requires octal socket. Heater volts (ac/dc), 6.3; amperes, 0.15. Maximum ratings in indicator service; fluorescent-target volts, 250 *max*, 125 *min*; ray-control-electrode supply volts, 250 *max*; peak heater-cathode volts, 90 *max*. Typical operation: fluorescent-target volts, 250; fluorescent-target ma., 3.75; ray-control-electrode volts (approx. for 0° shadow angle), 155; ray-control-electrode volts (approx. for 100° shadow angle), 0.

**SHARP-CUTOFF PENTODE**

**6AG5**

Miniature type used in compact radio equipment as an rf or if amplifier up to 400 megacycles per second. Outline 11, OUTLINES SECTION.

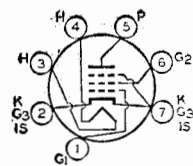

Tube requires miniature seven-contact socket and may be mounted in any position. Except for slightly different characteristics, this type is similar electrically to miniature type 6BC5. Heater volts (ac/dc), 6.3; amperes, 0.3. For typical operation as a resistance-coupled amplifier, refer to RESISTANCE-COUPLED AMPLIFIER SECTION.

## CLASS A<sub>1</sub> AMPLIFIER

### Characteristics:

	Triode <sup>a</sup> Connection		Pentode Connection			
	180	250	100	125	250	
Plate Supply Voltage	180	250	100	125	250	volts
Grid-No.2 Supply Voltage	-	-	100	125	150	volts
Cathode-Bias Resistor	330	820	180	100	180	ohms
Amplification Factor	45	42	-	-	-	
Plate Resistance (Approx.)	0.008	0.01	0.6	0.5	0.8	megohm
Transconductance	5700	3800	4500	5100	5000	μmhos
Grid-No.1 Voltage (Approx.) for plate current of 10 μa	-	-	-5	-6	-8	volts
Plate Current	7	5.5	4.5	7.2	6.5	ma
Grid-No.2 Current	-	-	1.4	2.1	2	ma

<sup>a</sup> Grid No.2 connected to plate.

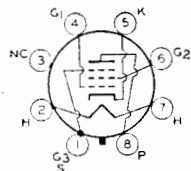

## POWER PENTODE

Metal type used in output stage of video amplifier of television receivers. Outline 6, OUTLINES SECTION. Tube requires octal socket. Heater volts (ac/dc), 6.3; amperes, 0.65. Maximum ratings as class A<sub>1</sub> amplifier: plate volts, 300 max; grid No.3 and shell, connect to cathode at socket; grid-No.2 volts, 300 max; grid-No.1 volts, positive-bias value, 0 max; plate dissipation, 9.0 max watts; grid-No.2 input, 1.5 max watts. Typical operation as a class A<sub>1</sub> amplifier: plate volts, 300; grid-No.2 volts, 150; grid-No.1 volts, -3; peak af grid-No.1 volts, 3; zero-signal plate ma., 30; maximum-signal plate ma., 30.5; zero-signal grid-No.2 ma., 7; maximum-signal grid-No.2 ma., 9; plate resistance (approx.), 0.13 megohm; transconductance, 11000 μmhos; load resistance, 10000 ohms; total harmonic distortion, 7 per cent; maximum-signal power output watts, 3.

# 6AG7

Maximum ratings as class A<sub>1</sub> amplifier: plate volts, 300 max; grid No.3 and shell, connect to cathode at socket; grid-No.2 volts, 300 max; grid-No.1 volts, positive-bias value, 0 max; plate dissipation, 9.0 max watts; grid-No.2 input, 1.5 max watts. Typical operation as a class A<sub>1</sub> amplifier: plate volts, 300; grid-No.2 volts, 150; grid-No.1 volts, -3; peak af grid-No.1 volts, 3; zero-signal plate ma., 30; maximum-signal plate ma., 30.5; zero-signal grid-No.2 ma., 7; maximum-signal grid-No.2 ma., 9; plate resistance (approx.), 0.13 megohm; transconductance, 11000 μmhos; load resistance, 10000 ohms; total harmonic distortion, 7 per cent; maximum-signal power output watts, 3.

## LOW-MU TRIODE

Glass octal type having high perveance used as vertical deflection amplifier in television receivers. Outline 22, OUTLINES SECTION. Tube requires octal socket and may be mounted in any position. Heater volts (ac/dc), 6.3; amperes, 0.75. Characteristics as class A<sub>1</sub> amplifier: plate volts, 250; grid volts, -23; amplification factor, 8; plate resistance (approx.), 1780 ohms; transconductance, 4500 μmhos; plate ma., 30. This type is used principally for renewal purposes.

# 6AH4-GT

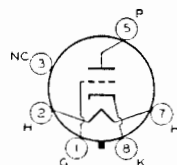

## VERTICAL DEFLECTION AMPLIFIER

*For operation in a 525-line, 30-frame system*

### Maximum Ratings:

DC PLATE VOLTAGE	500 max	volts
PEAK POSITIVE-PULSE PLATE VOLTAGE# (Absolute maximum)	2000 <sup>a</sup> max	volts
PEAK NEGATIVE-PULSE GRID VOLTAGE	-200 max	volts
PEAK CATHODE CURRENT	180 max	ma
AVERAGE CATHODE CURRENT	60 max	ma
PLATE DISSIPATION	7.5 max	watts
<b>PEAK HEATER-CATHODE VOLTAGE:</b>		
Heater negative with respect to cathode	200 max	volts
Heater positive with respect to cathode	200 <sup>b</sup> max	volts

### Maximum Circuit Value:

Grid-Circuit Resistance, 2.2 max megohms

# The duration of the voltage pulse must not exceed 15 per cent of one vertical scanning cycle. In a 525-line, 30-frame system, 15 per cent of one vertical scanning cycle is 2.5 milliseconds.

<sup>a</sup> Under no circumstances should this absolute value be exceeded.

<sup>b</sup> The dc component must not exceed 100 volts.

# 6AH6

## SHARP-CUTOFF PENTODE

Miniature type used as if amplifier in video stages of television receivers. Outline 11, OUTLINES SECTION. Tube requires miniature seven-contact socket and may be mounted in any position.

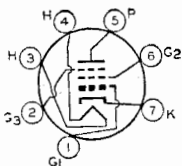

Heater volts (ac/dc), 6.3; amperes, 0.45. Maximum ratings as class A<sub>1</sub> amplifier: plate and grid-No.2 (screen-grid) supply volts, 300 *max*; grid-No.2 volts, see curve page 66; plate dissipation, 3.2 *max* watts; grid-No.2 input, 0.4 *max* watt for grid-No.2 voltages up to 150 volts, see curve page 66 for grid-No.2 voltages between 150 and 300 volts; total cathode current, 13 *max* ma; peak heater-cathode volts, 90 *max*.

### CLASS A<sub>1</sub> AMPLIFIER

**Characteristics:**

	Triode* Connection	Pentode Connection	
Plate Supply Voltage	150	300	volts
Grid No.3 (Suppressor Grid)	-	Connected to cathode at socket	volts
Grid-No.2 Supply Voltage	-	150	volts
Cathode-Bias Resistor	160	160	ohms
Amplification Factor	40	-	
Plate Resistance (Approx.)	3600	50000	ohms
Transconductance	11000	9000	$\mu$ mhos
Grid-No.1 Voltage (Approx.) for plate current of 10 $\mu$ a	-7	-7	volts
Plate Current	12.5	10	ma
Grid-No.2 Current	-	2.5	ma

\* Grid No.2 and Grid No.3 tied to plate.

## SHARP-CUTOFF PENTODE

# 6AK5

Miniature type used as an rf or if amplifier especially in high-frequency wide-band applications. It is useful as an amplifier at frequencies up to 400 megacycles per second. Outline 9,

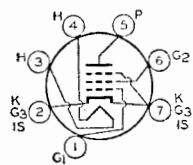

OUTLINES SECTION. Tube requires miniature seven-contact socket and may be mounted in any position.

HEATER VOLTAGE (AC/DC)	6.3	volts
HEATER CURRENT	0.175	ampere
DIRECT INTERELECTRODE CAPACITANCES (Approx.): <sup>■</sup>		
Grid No.1 to Plate	0.02 <i>max</i>	$\mu$ fd
Grid No.1 to Cathode, Heater, Grid No.2, Grid No.3, and Internal Shield	4.0	$\mu$ fd
Plate to Cathode, Heater, Grid No.2, Grid No.3, and Internal Shield	2.8	$\mu$ fd

**Maximum Ratings:**

### CLASS A<sub>1</sub> AMPLIFIER

PLATE VOLTAGE	180 <i>max</i>	volts
GRID-NO.2 (SCREEN-GRID) VOLTAGE	See curve page 66	
GRID-NO.2 SUPPLY VOLTAGE	180 <i>max</i>	volts
GRID-NO.1 VOLTAGE, Positive-bias value	0 <i>max</i>	volts
PLATE DISSIPATION	1.7 <i>max</i>	watts
GRID-NO.2 INPUT:		
For grid-No.2 voltages up to 90 volts	0.5 <i>max</i>	watt
For grid-No.2 voltages between 90 and 180 volts	See curve page 66	
CATHODE CURRENT	18 <i>max</i>	ma
PEAK HEATER-CATHODE VOLTAGE:		
Heater negative with respect to cathode	90 <i>max</i>	volts
Heater positive with respect to cathode	90 <i>max</i>	volts

**Characteristics:**

Plate Supply Voltage	120	180	volts
Grid-No.2 Supply Voltage	120	120	volts
Cathode-Bias Resistor	180	180	ohms
Plate Resistance (Approx.)	0.3	0.5	megohm
Transconductance	5000	5100	$\mu$ mhos
Grid-No.1 Voltage for plate current of 10 $\mu$ a	-8.5	-8.5	volts
Plate Current	7.5	7.7	ma
Grid-No.2 Current	2.5	2.4	ma

<sup>■</sup> With external shield connected to pins 2 or 7.



**TWIN DIODE**

**6AL5**

Miniature, high-perveance type used as detector in FM and television circuits. It is especially useful as a ratio detector in ac-operated FM receivers. Each diode section can be used

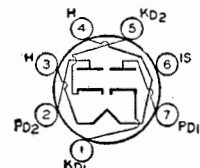

independently of the other, or the two sections can be combined in parallel or full-wave arrangement. Resonant frequency of each unit is approximately 700 megacycles per second. Outline 9, OUTLINES SECTION. Tube requires miniature seven-contact socket and may be mounted in any position.

HEATER VOLTAGE (AC/DC) .....	6.3	volts
HEATER CURRENT .....	0.3	ampere
DIRECT INTERELECTRODE CAPACITANCES:		
Plate No.1 to Cathode No.1, Heater, and Internal Shield .....	2.5	$\mu\text{f}$
Plate No.2 to Cathode No.2, Heater, and Internal Shield .....	2.5	$\mu\text{f}$
Cathode No.1 to Plate No.1, Heater, and Internal Shield .....	3.4	$\mu\text{f}$
Cathode No.2 to Plate No.2, Heater, and Internal Shield .....	3.4	$\mu\text{f}$
Plate No.1 to Plate No.2 .....	0.068 max	$\mu\text{f}$

**HALF-WAVE RECTIFIER**

<b>Maximum Ratings:</b>		
PEAK INVERSE PLATE VOLTAGE .....	330 max	volts
PEAK PLATE CURRENT (Per Plate) .....	54 max	ma
DC OUTPUT CURRENT (Per Plate) .....	9 max	ma
<b>PEAK HEATER-CATHODE VOLTAGE:</b>		
Heater negative with respect to cathode .....	330 max	volts
Heater positive with respect to cathode .....	330 max	volts

**Typical Operation:**

AC Plate Voltage per Plate (rms) .....	117	volts
Min. Total Effective Plate-Supply Impedance per Plate .....	300	ohms
DC Output Current per Plate .....	9	ma

**AVERAGE CHARACTERISTICS  
HALF-WAVE RECTIFICATION-SINGLE DIODE**

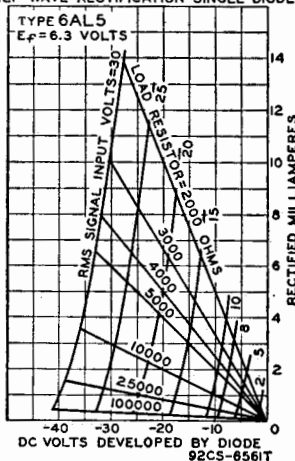

**ELECTRON-RAY TUBE**

**6AL7-GT**

Glass octal type used to indicate visually on a pair of rectangular fluorescent patterns the effects of changes in voltages applied to its grid and three deflecting electrodes. It is especially useful in meeting the requirements for accurate tuning in FM receivers. Outline 22, OUTLINES SECTION, except over-all length is 3-1/16 max inches and seated height is 2-1/2 max inches. Tube requires octal socket and may be

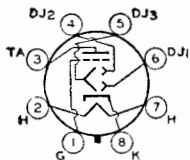

mounted in any position. Heater volts (ac/dc), 6.3; amperes, 0.15. Maximum ratings in indicator service: fluorescent-target volts, 365 max, 220 min; peak heater-cathode volts, 90 max. Typical operation in indicator service: fluorescent-target volts, 315; deflecting electrodes Nos. 1, 2, and 3, volts, 0; cathode resistor (approx.), 3300 ohms; deflection sensitivity (approx.), 1 mm/volt; grid volts for fluorescence cutoff, -7. This type is used principally for renewal purposes.

### HIGH-MU TRIODE

## 6AM4

Miniature type used as mixer and rf amplifier in cathode-drive circuits of uhf television receivers. Outline 10, OUTLINES SECTION. Tube requires miniature nine-contact socket and may be mounted in any position. Heater volts (ac/dc), 6.3; amperes, 0.225. This type is used principally for renewal purposes.

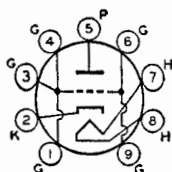

**Maximum Ratings:**

PLATE VOLTAGE	200 <i>max</i>	volts
GRID VOLTAGE, Positive bias value	0 <i>max</i>	volts
PLATE DISSIPATION	2 <i>max</i>	watts
PEAK HEATER-CATHODE VOLTAGE:		
Heater negative with respect to cathode	80* <i>max</i>	volts
Heater positive with respect to cathode	80 <i>max</i>	volts

**CLASS A<sub>1</sub> AMPLIFIER**

**Characteristics:**

Plate-Supply Voltage	200	volts
Cathode-Bias Resistor*	100	ohms
Amplification Factor	85	
Plate Resistance (Approx.)	8700	ohms
Transconductance	9800	μmhos
Plate Current	10	ma
Grid Voltage (Approx.) for plate current of 10 μa	-6.5	volts

\* Under cutoff conditions in direct-coupled cathode-drive circuits, it is permissible for this voltage to be as high as 250 volts.

• Fixed-bias operation is not recommended.

### DIODE—SHARP-CUTOFF PENTODE

## 6AM8 6AM8-A

Miniature types used in diversified applications in television receivers. Type 6AM8-A has a controlled heater warm-up time for use in receivers employing series-connected heaterstrings.

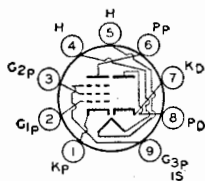

The pentode unit is used as an if amplifier, video amplifier, or age amplifier. The high-perveance diode is used as an audio detector, video detector, or dc restorer. Outline 12, OUTLINES SECTION. Tubes require miniature nine-contact socket and may be mounted in any position. Type 6AM8 is a DISCONTINUED type listed for reference only.

HEATER VOLTAGE (AC/DC)	6.3	volts
HEATER CURRENT	0.45	ampere
HEATER WARM-UP TIME (Average) for 6AM8-A	11	seconds
DIRECT INTERELECTRODE CAPACITANCES:		
Diode Unit:		
Plate to Cathode and Heater	1.8	μf
Cathode to Plate and Heater	3	μf
Pentode Unit:		
Grid No.1 to Plate	0.015 <i>max</i>	μf
Grid No.1 to Cathode, Heater, Grid No.2, No.3 and Internal Shield	6.5	μf
Plate to Cathode, Heater, Grid No.2, Grid No.3, and Internal Shield	2.6	μf
Pentode Grid No.1 to Diode Plate	0.006 <i>max</i>	μf
Pentode Plate to Diode Cathode	0.15 <i>max</i>	μf
Pentode Plate to Diode Plate	0.1 <i>max</i>	μf

**PENTODE UNIT AS CLASS A<sub>1</sub> AMPLIFIER**

**Maximum Ratings, (Design-Maximum Values):**

PLATE VOLTAGE	330 <i>max</i>	volts
GRID No.3 (SUPPRESSOR GRID) AND INTERNAL SHIELD	Connect to cathode at socket	
GRID-No.2 (SCREEN-GRID) SUPPLY VOLTAGE	330 <i>max</i>	volts
GRID-No.2 VOLTAGE	See curve page 66	
GRID-No.1 (CONTROL-GRID) VOLTAGE, Positive bias value	0 <i>max</i>	volts
PLATE DISSIPATION	3.2 <i>max</i>	watts
GRID-No.2 INPUT:		
For grid-No.2 voltages up to 165 volts	0.55 <i>max</i>	watt
For grid-No.2 voltages between 165 and 330 volts	See curve page 66	
PEAK HEATER-CATHODE VOLTAGE:		
Heater negative with respect to cathode	200 <i>max</i>	volts
Heater positive with respect to cathode	200* <i>max</i>	volts

**Characteristics:**

Plate Supply Voltage.....	125	volts
Grid-No.3. and Internal Shield.....	Connected to cathode at socket	
Grid-No.2 Supply Voltage.....	125	volts
Cathode-Bias Resistor.....	56	ohms
Plate Resistance (Approx.).....	0.3	megohm
Transconductance.....	7800	$\mu$ mhos
Grid-No.1 Voltage (Approx.) for plate current of 20 $\mu$ a.....	-6	volts
Grid-No.1 Voltage (Approx.) for plate current of 2 ma. and cathode resistor of 0 ohms.....	-3	volts
Plate Current.....	12.5	ma
Grid-No.2 Current.....	3.2	ma

**Maximum Circuit Values:**

Grid-No.1-Circuit Resistance:		
For fixed-bias operation.....	0.25 max	megohm
For cathode-bias operation.....	1.0 max	megohm

**DIODE UNIT**

**Maximum Ratings, (Design-Maximum Values):**

DC PLATE CURRENT.....	5 max	ma
PEAK HEATER-CATHODE VOLTAGE:		
Heater negative with respect to cathode.....	200 max	volts
Heater positive with respect to cathode.....	200 <sup>o</sup> max	volts

<sup>o</sup>The dc component must not exceed 100 volts.

**AVERAGE CHARACTERISTICS  
PENTODE UNIT**

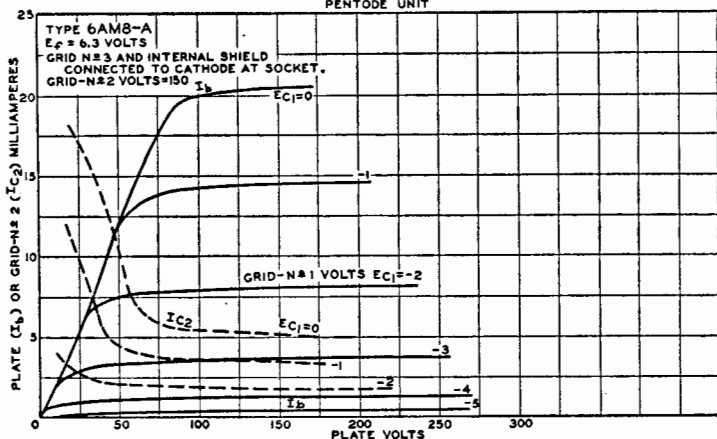

92CM-8503T2

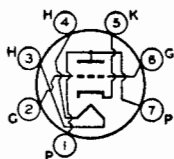

**HIGH-MU TRIODE**

Miniature type used as mixer or rf amplifier in cathode-drive circuits of uhf television tuners covering the frequency range of 470 to 890 megacycles per second. Outline 9, OUT-

**6AN4**

**LINE SECTION.** Tube requires miniature seven-contact socket and may be mounted in any position.

HEATER VOLTAGE (AC/DC).....	6.3	volts
HEATER CURRENT.....	0.225	ampere

**CLASS A<sub>1</sub> AMPLIFIER**

Maximum Ratings:		
PLATE VOLTAGE.....	300 max	volts
PLATE DISSIPATION.....	4 max	watts
CATHODE CURRENT.....	30 max	ma
PEAK HEATER-CATHODE VOLTAGE:		
Heater negative with respect to cathode.....	200 max	volts
Heater positive with respect to cathode.....	200 <sup>o</sup> max	volts

**Characteristics:**

Plate-Supply Voltage .....	200	volts
Cathode-Bias Resistor .....	100	ohms
Amplification Factor .....	70	
Transconductance .....	10000	$\mu$ mhos
Plate Current .....	13	ma
Grid Voltage (Approx.) for plate current of 20 $\mu$ a .....	-7	volts

**Maximum Circuit Values:**

Grid-Circuit Resistance:		
For fixed-bias operation .....	0.1 max	megohm
For cathode-bias operation .....	0.5 max	megohm

• The dc component must not exceed 100 volts.

**MEDIUM-MU TRIODE—  
SHARP-CUTOFF PENTODE**

**6AN8  
6AN8-A**

Miniature types used in a wide variety of applications in color television receivers. The 6AN8-A has a controlled heater warm-up time for use in receivers employing series-connected

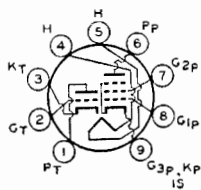

heater strings. The pentode unit is used as an intermediate-frequency amplifier, a video amplifier, an agc amplifier, or as a reactance tube. The triode unit is used in low-frequency oscillator, sync-separator, sync-clipper, and phase-splitter circuits. Outline 12, OUTLINES SECTION. Tubes require miniature nine-contact socket and may be mounted in any position.

HEATER VOLTAGE (AC/DC) .....	6.3	volts
HEATER CURRENT .....	0.45	ampere
HEATER WARM-UP TIME (Average) 6AN8-A .....	11	seconds

**DIRECT INTERELECTRODE CAPACITANCES:**

<b>Triode Unit:</b>		
Grid to Plate .....	1.5	$\mu$ uf
Grid to Cathode and Heater .....	2.0	$\mu$ uf
Plate to Cathode and Heater .....	0.26	$\mu$ uf
<b>Pentode Unit:</b>		
Grid No.1 to Plate .....	0.04 max	$\mu$ uf
Grid No.1 to Cathode, Heater, Grid No.2, Grid No.3, and Internal Shield .....	7	$\mu$ uf
Plate to Cathode, Heater, Grid No.2, Grid No.3, and Internal Shield .....	2.4	$\mu$ uf
Triode Grid to Pentode Plate .....	0.02	$\mu$ uf
Pentode Grid No.1 to Triode Plate .....	0.02	$\mu$ uf
Pentode Plate to Triode Plate .....	0.15	$\mu$ uf

**CLASS A<sub>1</sub> AMPLIFIER**

**Maximum Ratings, (Design-Maximum Values):**

	Triode Unit	Pentode Unit	
PLATE VOLTAGE .....	330 max	330 max	volts
GRID-NO.2 SUPPLY VOLTAGE .....	-	330 max	volts
GRID-NO.2 (SCREEN-GRID) VOLTAGE .....	-	See curve page 66	
GRID-NO.1 (CONTROL-GRID) VOLTAGE, Positive bias value .....	0 max	0 max	volts
PLATE DISSIPATION .....	2.8 max	2.3 max	watts
<b>GRID-NO.2 INPUT:</b>			
For grid-No.2 voltages up to 165 volts .....	-	0.55 max	watt
For grid-No.2 voltages between 165 and 330 volts .....	-	See curve page 66	

**PEAK HEATER-CATHODE VOLTAGE:**

Heater negative with respect to cathode .....	200 max	200 max	volts
Heater positive with respect to cathode .....	200 <sup>a</sup> max	200 <sup>a</sup> max	volts

**Characteristics:**

	Triode Unit	Pentode Unit	
Plate Supply Voltage .....	150	125	volts
Grid-No.2 Supply Voltage .....	-	125	volts
Grid-No.1 Voltage .....	-3	-	volts
Cathode-Bias Resistor .....	-	56	ohms
Amplification Factor .....	21	-	
Plate Resistance (Approx.) .....	4700	170000	ohms
Transconductance .....	4500	7800	$\mu$ mhos
Grid-No.1 Voltage (Approx.) for plate current of 20 $\mu$ a .....	-17	-6	volts
Grid-No.1 Voltage (Approx.) for plate current of 1.6 ma. and cathode resistor of 0 ohms .....	-	-3	volts
Plate Current .....	15	12	ma
Grid-No.2 Current .....	-	3.8	ma

**Maximum Circuit Values:**

Grid-No.1-Circuit Resistance: <sup>*</sup>			
For fixed-bias operation .....	0.5 max	0.25 max	megohm
For cathode-bias operation .....	1.0 max	1.0 max	megohm

<sup>a</sup>The dc component must not exceed 100 volts.

\*If either unit is operating at maximum rated conditions, grid-No.1-circuit resistance for both units should not exceed the stated values.

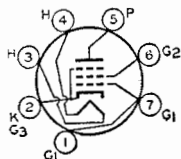

**BEAM POWER TUBE**

Miniature types used as output amplifiers primarily in automobile receivers and in ac-operated receivers and, triode-connected, as vertical deflection amplifiers in television receivers.

**6AQ5**  
**6AQ5-A**

Type 6AQ5-A has a controlled heater warm-up time for use in television receivers employing series-connected heater strings. Outline 13, OUTLINES SECTION. Tubes require miniature seven-contact socket and may be mounted in any position. Within their maximum ratings, the performance of these types is equivalent to that of larger types 6V6 and 6V6-GT. Type 6AQ5 is a DISCONTINUED type listed for reference only.

HEATER VOLTAGE (AC/DC) .....	6.3	volts
HEATER CURRENT .....	0.45	ampere
HEATER WARM-UP TIME (Average) for 6AQ5-A .....	11	seconds
DIRECT INTERELECTRODE CAPACITANCES (Approx.):		
Grid No.1 to Plate .....	0.4	$\mu$ f
Grid No.1 to Cathode, Heater, Grid No.2, and Grid No.3 .....	8	$\mu$ f
Plate to Cathode, Heater, Grid No.2, and Grid No.3 .....	8.5	$\mu$ f
AMPLIFICATION FACTOR* .....	9.5	
PLATE RESISTANCE (Approx.)* .....	1970	ohms
TRANSCONDUCTANCE* .....	4800	$\mu$ mhos
GRID-NO.1 VOLTAGE (Approx.) for plate current of 0.5 ma. ....	-37	volts

\* Grid No.2 connected to plate; plate and grid-No.2 volts, 250; grid-No.1 volts, -12.5; plate ma., 49.5.

**CLASS A<sub>1</sub> AMPLIFIER**

Maximum Ratings, (Design-Maximum Values):

PLATE VOLTAGE .....	275 max	volts
GRID-NO.2 (SCREEN-GRID) VOLTAGE .....	275 max	volts
PLATE DISSIPATION .....	12 max	watts
GRID-NO.2 INPUT .....	2 max	watts
PEAK HEATER-CATHODE VOLTAGE:		
Heater negative with respect to cathode .....	200 max	volts
Heater positive with respect to cathode .....	200 max	volts
BULB TEMPERATURE (At hottest point) .....	250 max	$^{\circ}$ C

■ The dc component must not exceed 100 volts.

**Typical Operation:**

Same as for type 6V6-GT within the limitations of the maximum ratings.

**Maximum Circuit Values:**

Grid-No.1-Circuit Resistance:		
For fixed-bias operation .....	0.1 max	megohm
For cathode-bias operation .....	0.5 max	megohm

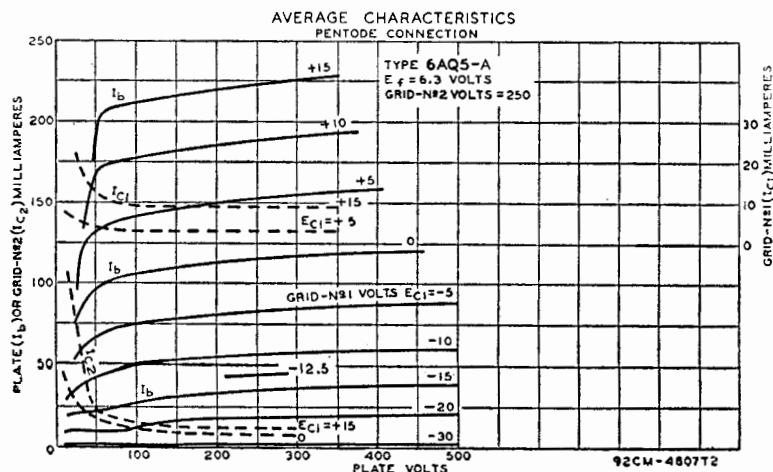

## VERTICAL DEFLECTION AMPLIFIER (Triode Connection)<sup>o</sup>

*For operation in a 525-line, 30-frame system*

**Maximum Ratings, (Design-Maximum Values):**

DC PLATE VOLTAGE.....	275 <i>max</i>	volts
PEAK POSITIVE-PULSE PLATE VOLTAGE†.....	1100 <i>max</i>	volts
PEAK NEGATIVE-PULSE GRID-NO.1 (CONTROL-GRID) VOLTAGE.....	-275 <i>max</i>	volts
PEAK CATHODE CURRENT.....	115 <i>max</i>	ma
PLATE DISSIPATION.....	40 <i>max</i>	ma
PEAK HEATER-CATHODE VOLTAGE:	10 <i>max</i>	watts
Heater negative with respect to cathode.....	200 <i>max</i>	volts
Heater positive with respect to cathode.....	200 <i>max</i>	volts
BULB TEMPERATURE (At hottest point).....	250 <i>max</i>	°C

**Maximum Circuit Value:**

Grid-No.1-Circuit Resistance:

For cathode-bias operation..... 2.2 *max* megohms

<sup>o</sup> Grid No.2 connected to plate.

† The duration of the voltage pulse must not exceed 15 per cent of one vertical scanning cycle. In a 525-line, 30-frame system, 15 per cent of one vertical scanning cycle is 2.5 milliseconds.

■ The dc component must not exceed 100 volts.

AVERAGE CHARACTERISTICS  
TRIODE CONNECTION

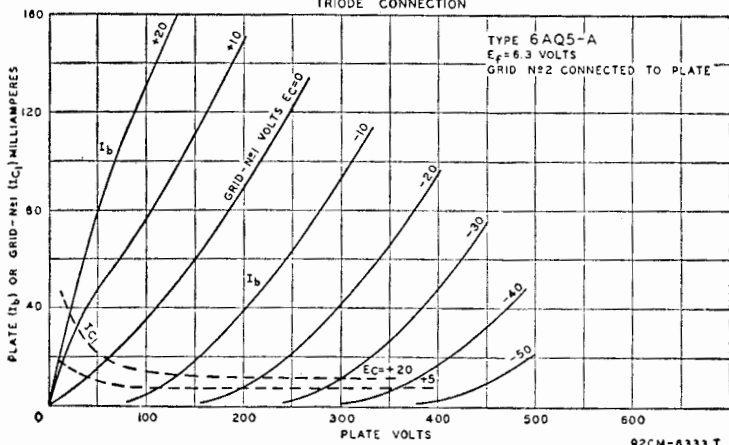

## 6AQ6

### TWIN DIODE—HIGH-MU TRIODE

Miniature type used as a combined detector, amplifier, and avc tube in compact radio receivers. This type is similar to metal type 6Q7 in many of its electrical characteristics. Outline 11,

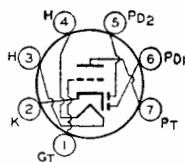

OUTLINES SECTION. Tube requires miniature seven-contact socket and may be mounted in any position. For typical operation as resistance-coupled amplifier, refer to Chart 3, RESISTANCE-COUPLED AMPLIFIER SECTION.

HEATER VOLTAGE (AC/DC).....	6.3	volts
HEATER CURRENT.....	0.15	ampere
DIRECT INTERELECTRODE CAPACITANCES (Triode Unit) <sup>o</sup> :		
Grid to Plate.....	1.8	μf
Grid to Cathode and Heater.....	1.7	μf
Plate to Cathode and Heater.....	1.5	μf

<sup>o</sup>With external shield connected to cathode.

**Maximum Ratings: TRIODE UNIT AS CLASS A<sub>1</sub> AMPLIFIER**

PLATE VOLTAGE.....	300 <i>max</i>	volts
PEAK HEATER-CATHODE VOLTAGE:		
Heater negative with respect to cathode.....	90 <i>max</i>	volts
Heater positive with respect to cathode.....	90 <i>max</i>	volts

**Characteristics:**

Plate Voltage.....	100	250	volts
Grid Voltage.....	-1	-3	volts
Amplification Factor.....	70	70	
Plate Resistance (Approx.).....	61000	58000	ohms
Transconductance.....	1150	1200	$\mu$ hos
Plate Current.....	0.8	1.0	ma

**DIODE UNITS**

Two diode plates are placed around a cathode, the sleeve of which is common to the triode unit. Diode biasing of the triode unit of the 6AQ6 is not suitable. For diode operation curves, refer to type 6AV6.

**TWIN DIODE—HIGH-MU TRIODE**

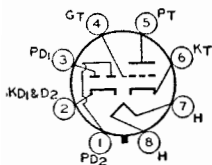

Glass octal type used as FM detector and audio amplifier in circuits which require diode and triode units with separate cathodes. Outline 22, OUTLINES SECTION. Tube requires octal socket. Heater volts (ac/dc), 6.3; amperes, 0.3. Ratings and characteristics of triode unit as class A<sub>1</sub> amplifier: plate volts, 250 max; grid volts, -2; amplification factor, 70; plate resistance (approx.), 44000 ohms; transconductance,

**6AQ7-GT**

1600  $\mu$ hos; plate ma., 2.3. For typical operation as a resistance-coupled amplifier, refer to Chart 5, RESISTANCE-COUPLED AMPLIFIER SECTION. This type is used principally for renewal purposes.

**HIGH-MU TWIN TRIODE**

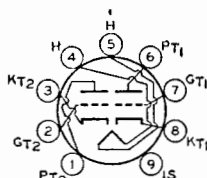

Miniature type used as rf amplifier and self-oscillating mixer in FM/AM radio receivers. Outline 12, OUTLINES SECTION. Tube requires nine-contact socket and may be operated

**6AQ8**

in any position. Heater volts (ac/dc), 6.3; amperes, 0.435. With plate volts of 250 and grid volts of -2.3, class A<sub>1</sub> characteristics of each unit are: plate ma, 10; plate resistance (approx.), 9700 ohms; transconductance, 5900  $\mu$ hos; amplification factor, 57.

**Maximum Ratings, (Each Unit):**

PLATE VOLTAGE with plate ma = 0.....	550 max	volts
PLATE VOLTAGE.....	300 max	volts
GRID VOLTAGE, Negative-bias value.....	-100 max	volts
PLATE DISSIPATION:		
For either plate.....	2.5 max	watts
For both plates with both units operating.....	4.5 max	watts
CATHODE CURRENT.....	15 max	ma
PEAK HEATER-CATHODE VOLTAGE:		
Heater negative with respect to cathode.....	90 max	volts
Heater positive with respect to cathode.....	90 max	volts

**Typical Operation, (Each Unit):**

	RF	Converter	
	Amplifier		
Plate Supply Voltage.....	250	250	volts
Plate Voltage.....	230	-	volts
Plate Resistor.....	1800	12000	ohms
Grid Resistor.....	-	1	megohm
Grid Voltage.....	-2	-	volts
RMS Oscillator Voltage.....	-	3	volts
Cathode Resistor.....	200	-	ohms
Plate Resistance (Approx.).....	9700	22000	ohms
Transconductance.....	6000	-	$\mu$ hos
Conversion Transconductance.....	-	2300	$\mu$ hos
Input Resistance at frequency (Mc) = 100.....	6000	15000	ohms
Plate Current.....	10	5.2	ma
Equivalent Noise Resistance.....	500	-	ohms

**Maximum Circuit Values, (Each Unit):**

Grid-Circuit Resistance.....	1 max	megohm
Resistance between Cathode and Heater.....	20000 max	ohms

**POWER PENTODE**

**6AR5**

Miniature type used as output tube primarily in automobile receivers and ac-operated receivers. Outline 13, OUTLINES SECTION. Tube requires miniature seven-contact socket and may be mounted in any position. Heater volts (ac/dc), 6.3; amperes, 0.4. Maximum ratings as class A<sub>1</sub> amplifier: plate and grid-No.2 (screen-grid) volts, 250 *max*; plate dissipation, 8.5 *max* watts; grid-No.2 input, 2.5 *max* watts;

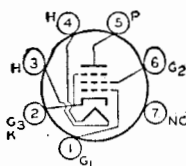

peak heater-cathode volts, 90 *max*. Within its maximum ratings, type 6AR5 is equivalent in performance to glass-octal type 6K6-GT. Type 6AR5 is used principally for renewal purposes.

**BEAM POWER TUBE**

**6AS5**

Miniature type used as output amplifier primarily in automobile and in ac-operated receivers. Outline 13, OUTLINES SECTION. Tube requires miniature seven-contact socket and may be mounted in any position. For curves of average plate characteristics, refer to type 35C5.

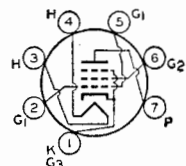

HEATER VOLTAGE (AC/DC).....	6.3	volts
HEATER CURRENT.....	0.8	ampere
DIRECT INTERELECTRODE CAPACITANCES (Approx.):		
Grid No.1 to Plate.....	0.6	μf
Grid No.1 to Cathode, Heater, Grid No.2, and Grid No.3.....	12	μf
Plate to Cathode, Heater, Grid No.2, and Grid No.3.....	9.0	μf

**Maximum Ratings:**

**CLASS A<sub>1</sub> AMPLIFIER**

PLATE VOLTAGE.....	150 <i>max</i>	volts
GRID-NO.2 (SCREEN-GRID) VOLTAGE.....	117 <i>max</i>	volts
PLATE DISSIPATION.....	5.5 <i>max</i>	watts
GRID-NO.2 INPUT.....	1.0 <i>max</i>	watt
PEAK HEATER-CATHODE VOLTAGE:		
Heater negative with respect to cathode.....	100 <i>max</i>	volts
Heater positive with respect to cathode.....	100 <i>max</i>	volts
BULB TEMPERATURE (At hottest point).....	250 <i>max</i>	°C

**Typical Operation:**

Plate Voltage.....	150	volts
Grid-No.2 Voltage.....	110	volts
Grid-No.1 (Control-Grid) Voltage.....	-8.5	volts
Peak AF Grid-No.1 Voltage.....	8.5	volts
Zero-Signal Plate Current.....	35	ma
Maximum-Signal Plate Current.....	36	ma
Zero-Signal Grid-No.2 Current (Approx.).....	2	ma
Maximum-Signal Grid-No.2 Current (Approx.).....	6.5	ma
Transconductance.....	5600	μmhos
Load Resistance.....	4500	ohms
Total Harmonic Distortion.....	10	per cent
Maximum-Signal Power Output.....	2.2	watts

**Maximum Circuit Values:**

Grid-No.1-Circuit Resistance:		
For fixed-bias operation.....	0.1 <i>max</i>	megohm
For cathode-bias operation.....	0.5 <i>max</i>	megohm

**DIODE—**

**SHARP-CUTOFF PENTODE**

**6AS8**

Miniature type used in diversified applications in television and radio receivers. The pentode unit is used as an if amplifier, video amplifier, or age amplifier. The high-perveance diode is

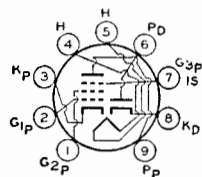

used as an audio detector, video detector, or dc restorer. Outline 12, OUTLINES SECTION. Tube requires miniature nine-contact socket and may be mounted in any position.



HEATER VOLTAGE (AC/DC) .....	6.3	volts
HEATER CURRENT .....	0.45	ampere
DIRECT INTERELECTRODE CAPACITANCES:		
Diode Unit:		
Plate to Cathode, Heater, Pentode Grid No.3, and Internal Shield	3.0	$\mu$ fd
Pentode Unit:		
Grid No.1 to Plate .....	0.03 max	$\mu$ fd
Grid No.1 to Cathode, Heater, Grid No.2, Grid No.3, and Internal Shield	7	$\mu$ fd
Plate to Cathode, Heater, Grid No.2, Grid No.3, and Internal Shield....	2.4	$\mu$ fd
Pentode Grid No.1 to Diode Plate .....	0.005 max	$\mu$ fd
Pentode Plate to Diode Cathode .....	0.15 max	$\mu$ fd
Pentode Plate to Diode Plate .....	0.10 max	$\mu$ fd

### PENTODE UNIT AS CLASS A<sub>1</sub> AMPLIFIER

PLATE VOLTAGE .....	300 max	volts
GRID NO.3 (SUPPRESSOR GRID) AND INTERNAL SHIELD .....	Connect to cathode at socket	
GRID-NO.2 SUPPLY VOLTAGE .....	300 max	volts
GRID-NO.2 (SCREEN-GRID) VOLTAGE .....	See curve page 66	
GRID-NO.1 (CONTROL-GRID) VOLTAGE, Positive bias value .....	0 max	volts
PLATE DISSIPATION .....	2.5 max	watts
GRID-NO.2 INPUT:		
For grid-No.2 voltages up to 150 volts .....	0.5 max	watt
For grid-No.2 voltages between 150 and 300 volts .....	See curve page 66	
PEAK HEATER-CATHODE VOLTAGE:		
Heater negative with respect to cathode .....	200 max	volts
Heater positive with respect to cathode .....	200 <sup>o</sup> max	volts

#### Characteristics:

Plate Supply Voltage .....	200	volts
Grid No.3 and Internal Shield .....	Connected to cathode at socket	
Grid-No.2 Supply Voltage .....	150	volts
Cathode-Bias Resistor .....	180	ohms
Plate Resistance (Approx.) .....	300000	ohms
Transconductance .....	6200	$\mu$ mbars
Grid-No.1 Voltage (Approx.) for plate current of 10 $\mu$ a .....	-8	volts
Plate Current .....	9.5	ma
Grid-No.2 Current .....	3	ma

#### Maximum Circuit Values:

Grid-No.1-Circuit Resistance:		
For fixed-bias operation .....	0.25 max	megohm
For cathode-bias operation .....	1.0 max	megohm
* The dc component must not exceed 100 volts.		

### Maximum Ratings: DIODE UNIT

PEAK INVERSE PLATE VOLTAGE .....	330 max	volts
PEAK PLATE CURRENT .....	50 max	ma
DC PLATE CURRENT .....	5 max	ma
PEAK HEATER-CATHODE VOLTAGE:		
Heater negative with respect to cathode .....	200 max	volts
Heater positive with respect to cathode .....	200 <sup>o</sup> max	volts
* The dc component must not exceed 100 volts.		

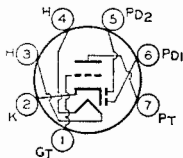

### TWIN DIODE—HIGH-MU TRIODE

Miniature type used as a combined detector, amplifier, and avc tube in automobile and ac-operated radio receivers. Outline 11, OUTLINES SECTION. Tube requires miniature

# 6AT6

seven-contact socket and may be mounted in any position. For typical operation as resistance-coupled amplifier, refer to RESISTANCE-COUPLED AMPLIFIER SECTION.

HEATER VOLTAGE (AC/DC) .....	6.3	volts
HEATER CURRENT .....	0.3	ampere
DIRECT INTERELECTRODE CAPACITANCES:		
Triode Grid to Triode Plate .....	2.0	$\mu$ fd
Triode Grid to Cathode and Heater .....	2.2	$\mu$ fd
Triode Plate to Cathode and Heater .....	0.8	$\mu$ fd
Plate of Diode Unit No.2 to Triode Grid .....	0.04 max	$\mu$ fd

### Maximum Ratings: TRIODE UNIT AS CLASS A<sub>1</sub> AMPLIFIER

PLATE VOLTAGE .....	300 max	volts
PLATE DISSIPATION .....	0.5 max	watt
GRID VOLTAGE, Positive Bias Value .....	0 max	volts
PEAK HEATER-CATHODE VOLTAGE:		
Heater negative with respect to cathode .....	90 max	volts
Heater positive with respect to cathode .....	90 max	volts

**Characteristics:**

Plate Voltage.....	100	250	volts
Grid Voltage.....	-1	-3	volts
Amplification Factor.....	70	70	
Plate Resistance.....	54000	58000	ohms
Transconductance.....	1300	1200	μmhos
Plate Current.....	0.8	1.0	ma

**Maximum Rating:**

**DIODE UNITS**

PLATE CURRENT (EACH UNIT).....	1.0 max	ma
--------------------------------	---------	----

The two diode plates are placed around a cathode, the sleeve of which is common to the triode unit. Each diode plate has its own base pin. For diode operation curves, refer to type 6AV6.

**MEDIUM-MU TRIODE—  
SHARP-CUTOFF PENTODE**

**6AT8  
6AT8-A**

Miniature types used as combined oscillator and mixer tubes in television receivers utilizing an intermediate frequency in the order of 40 megacycles per second. Type 6AT8-A has a controlled heater warm-up time for use in receivers employing series-connected heater strings. Outline 12, OUTLINES SECTION. Except for interelectrode capacitances and basing arrangement, these types are identical with miniature type 6X8. The basing arrangement of the 6AT8 and 6AT8-A is particularly suitable for connection to the coils of certain designs of turret tuners. Type 6AT8 is a DISCONTINUED type listed for reference only.

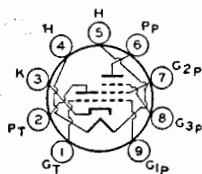

Outline 12, OUTLINES SECTION. Except for interelectrode capacitances and basing arrangement, these types are identical with miniature type 6X8. The basing arrangement of the 6AT8 and 6AT8-A is particularly suitable for connection to the coils of certain designs of turret tuners. Type 6AT8 is a DISCONTINUED type listed for reference only.

HEATER VOLTAGE (AC/DC).....	6.3	volts
HEATER CURRENT.....	0.45	ampere
HEATER WARM-UP TIME (Average) for 6AT8-A.....	11	seconds

**DIRECT INTERELECTRODE CAPACITANCES:**

	Without External Shield	With External Shield <sup>‡</sup>	
<b>Triode Unit:</b>			
Grid to Plate.....	1.5	1.5	μf
Grid to Cathode and Heater.....	2.0	2.4	μf
Plate to Cathode and Heater.....	0.5	1.0	μf
<b>Pentode Unit:</b>			
Grid No.1 to Plate.....	0.06 max	0.03 max	μf
Grid No.1 to Cathode, Heater, Grid No.2, and Grid No.3.....	4.6	4.8	μf
Plate to Cathode, Heater, Grid No.2, and Grid No.3.....	0.9	1.6	μf
Pentode Grid No.1 to Triode Plate.....	0.05 max	0.04 max	μf
Pentode Plate to Triode Plate.....	0.05 max	0.008 max	μf
Heater to Cathode.....	6.0	6.0†	μf

‡ With external shield connected to cathode except as noted.

† With external shield connected to plate.

**HALF-WAVE VACUUM RECTIFIER**

**6AU4-GT  
6AU4-GTA**

Glass octal types used as damper tubes in horizontal-deflection circuits of color television receivers and of television receivers utilizing picture tubes having wide-angle deflection. Outline

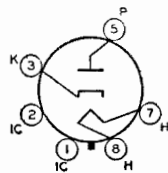

29, OUTLINES SECTION. Tubes require octal socket and may be mounted in any position. These types may be supplied with pin No.1 omitted. Socket terminals 1, 2, 4, and 6 should not be used as tie points. It is especially important that these tubes, like other power-handling tubes, be adequately ventilated. Type 6AU4-GT is a DISCONTINUED type listed for reference only. For curve of average plate characteristics for 6AU4-GTA, see page 67.

HEATER VOLTAGE (AC/DC).....	6.3	volts
HEATER CURRENT.....	1.8	amperes
<b>DIRECT INTERELECTRODE CAPACITANCES (Approx.):</b>		
Plate to Heater and Cathode.....	8.5	μf
Cathode to Heater and Plate.....	11.5	μf
Heater to Cathode.....	4.0	μf

## DAMPER SERVICE

For operation in a 525-line, 30-frame system

Maximum Ratings:	6AU4-GT		6AU4-GTA	
	Design-Center Values <sup>†</sup>	Design-Maximum Values <sup>‡</sup>	Design-Center Values <sup>†</sup>	Design-Maximum Values <sup>‡</sup>
PEAK INVERSE PLATE VOLTAGE†	4500 <sup>o</sup> max	4500 max	4500 max	volts
PEAK PLATE CURRENT	1050 max	1300 max	1300 max	ma
DC PLATE CURRENT	175 max	210 max	210 max	ma
PLATE DISSIPATION	6 max	6.5 max	6.5 max	watts
PEAK HEATER-CATHODE VOLTAGE:				
Heater negative with respect to cathode	4500 <sup>o</sup> *max	4500*max	4500*max	volts
Heater positive with respect to cathode	300 <sup>‡</sup> max	300 <sup>‡</sup> max	300 <sup>‡</sup> max	volts

† Except as noted.

‡ The duration of the voltage pulse must not exceed 15 per cent of one horizontal scanning cycle. In a 525-line, 30-frame system, 15 per cent of one horizontal scanning cycle is 10 microseconds.

<sup>o</sup> Absolute Maximum. Under no circumstances should this absolute value be exceeded.

\* The dc component must not exceed 900 volts.

<sup>‡</sup> The dc component must not exceed 100 volts.

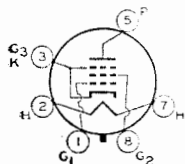

## BEAM POWER TUBE

Glass octal type used as horizontal deflection amplifier in low-cost, high-efficiency deflection circuits of television receivers employing either transformer coupling or direct coupling to the deflecting yoke. Outline 22, OUTLINES SECTION. Tube requires octal socket and may be mounted in any position.

## 6AU5-GT

Tube requires octal socket and may be mounted in any position.

HEATER VOLTAGE (AC/DC)	6.3	volts
HEATER CURRENT	1.25	amperes
DIRECT INTERELECTRODE CAPACITANCES (Approx.):		
Grid No.1 to Plate	0.5	μμf
Grid No.1 to Cathode, Heater, Grid No.2, and Grid No.3	11.3	μμf
Plate to Cathode, Heater, Grid No.2, and Grid No.3	7.0	μμf
TRANSCONDUCTANCE <sup>‡</sup>	5600	μmhos
MU-FACTOR, Grid No.2 to Grid No.1†	5.9	

† For plate volts, 115; grid-No.2 volts, 175; grid-No.1 volts, -20.

‡ For plate volts, 100; grid-No.2 volts, 100; grid-No.1 volts, -4.5.

## HORIZONTAL DEFLECTION AMPLIFIER

For operation in a 525-line, 30-frame system

Maximum Ratings:		
DC PLATE VOLTAGE	550 max	volts
PEAK POSITIVE-PULSE PLATE VOLTAGE* (Absolute Maximum)	5500 <sup>o</sup> max	volts
PEAK NEGATIVE-PULSE PLATE VOLTAGE	-1250 max	volts
DC GRID-NO.2 (SCREEN-GRID) VOLTAGE*	200 max	volts
PEAK NEGATIVE-PULSE GRID-NO.1 (CONTROL-GRID) VOLTAGE	-300 max	volts
PEAK CATHODE CURRENT	400 max	ma
AVERAGE CATHODE CURRENT	110 max	ma
GRID-NO.2 INPUT	2.5 max	watts
PLATE DISSIPATION†	10 max	watts
PEAK HEATER-CATHODE VOLTAGE:		
Heater negative with respect to cathode	200 max	volts
Heater positive with respect to cathode	200 <sup>‡</sup> max	volts
BULB TEMPERATURE (At hottest point)	210 max	°C

Maximum Circuit Value:

Grid-No.1-Circuit Resistance..... 0.47 max megohms

\* The duration of the voltage pulse must not exceed 15 per cent of one horizontal scanning cycle. In a 525-line, 30-frame system, 15 per cent of one horizontal scanning cycle is 10 microseconds.

<sup>o</sup> Under no circumstances should this absolute value be exceeded.

\* Obtained through a series dropping resistor of sufficient magnitude to limit the grid-No.2 input to the rated maximum value.

† An adequate bias resistor or other means is required to protect the tube in the absence of excitation

<sup>‡</sup> The dc component must not exceed 100 volts.

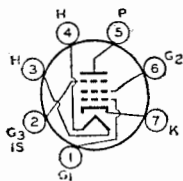

## SHARP-CUTOFF PENTODE

Miniature types used in compact radio equipment as rf amplifier especially in high-frequency, wide-band applications; also used as limiter tube in FM equipment. Type 6AU6-A has a

## 6AU6 6AU6-A

controlled heater warm-up time for use in applications employing series-connected heater strings. Outline 11, OUTLINES SECTION. Tubes require miniature seven-contact socket and may be operated in any position. For a discussion of limiters, refer to ELECTRON TUBE APPLICATIONS SECTION. For typical operation as resistance-coupled amplifier, refer to RESISTANCE-COUPLED AMPLIFIER SECTION.

HEATER VOLTAGE (AC/DC) .....	6.3	volts
HEATER CURRENT .....	0.3	ampere
HEATER WARM-UP TIME (Average) for 6AU6-A .....	11	seconds

DIRECT INTERELECTRODE CAPACITANCES:		<i>Without External Shield</i>	<i>With External Shield<sup>■</sup></i>	
<i>Pentode Connection:</i>				
Grid No.1 to Plate .....	0.0035 max	0.0035 max		$\mu\text{f}$
Grid No.1 to Cathode, Heater, Grid No.2, Grid No.3, and Internal Shield .....	5.5	5.5		$\mu\text{f}$
Plate to Cathode, Heater, Grid No.2, Grid No.3, and Internal Shield .....	5.0	5.0		$\mu\text{f}$
<i>Triode Connection:<sup>†</sup></i>				
Grid No.1 to Plate, Grid No.2, Grid No.3, and Internal Shield .....	2.6	2.6		$\mu\text{f}$
Grid No.1 to Cathode and Heater .....	3.2	3.2		$\mu\text{f}$
Plate, Grid No.2, Grid No.3, and Internal Shield to Cathode and Heater .....	1.2	8.6		$\mu\text{f}$

- With external shield connected to cathode.
- † Grid No.2, grid No.3, and internal shield connected to plate.

**CLASS A<sub>1</sub> AMPLIFIER**

Maximum Ratings, (Design-Maximum Values):		<i>Triode<sup>†</sup> Connection</i>	<i>Pentode Connection</i>	
PLATE VOLTAGE .....		275 max	330 max	volts
GRID NO.3 (SUPPRESSOR GRID) AND INTERNAL SHIELD .....			Connect to cathode at socket	
GRID-NO.2 (SCREEN-GRID) VOLTAGE .....		-	See curve page 66	
GRID-NO.2 SUPPLY VOLTAGE .....		-	330 max	volts
PLATE DISSIPATION .....		3.5 max	3.5 max	watts
GRID-NO.2 INPUT:				
For grid-No.2 voltages up to 165 volts .....		-	0.75 max	watt
For grid-No.2 voltages between 165 and 330 volts .....		-	See curve page 66	
GRID-NO.1 (CONTROL-GRID) VOLTAGE:				
Positive bias value .....		0 max	0 max	volts
PEAK HEATER-CATHODE VOLTAGE:				
Heater negative with respect to cathode .....		200 max	200 max	volts
Heater positive with respect to cathode .....		200 <sup>▲</sup> max	200 <sup>▲</sup> max	volts

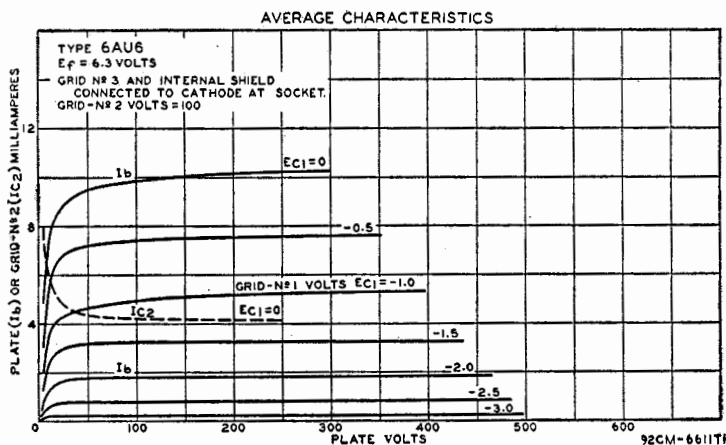

Characteristics:	Triode† Connection		Pentode Connection		
	250	100	250	250	
Plate Supply Voltage	250	100	250	250	volt-
Grid-No.3 and Internal Shield	—	—	Connected to cathode at socket		volt-
Grid-No.2 Supply Voltage	—	100	125	150	ohms
Cathode-Bias Resistor	330	150	100	68	ohms
Amplification Factor	36	—	—	—	—
Plate Resistance (Approx.)	—	0.5	1.5	1.0	megohms
Transconductance	4800	3900	4500	5200	μmhos
Grid-No.1 Voltage for plate current of 10 μa.	—	-4.2	-5.5	-6.5	volts
Plate Current	12.2	5.0	7.6	10.6	ma
Grid-No. 2 Current	—	2.1	3.0	4.3	ma

† Grid No.2, grid No.3, and internal shield connected to plate.

\* The dc component must not exceed 100 volts.

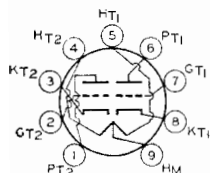

### MEDIUM-MU TWIN TRIODE

Miniature type used as phase inverter or amplifier in television receivers employing series-connected heater strings. Outline 12, OUTLINES SECTION. Heater volts (ac/dc), 6.3 (series), 3.15 (parallel); amperes, 0.3 (series), 0.6 (parallel); warm-up time (average) in parallel arrangement, 11 seconds. Except for heater and heater-cathode ratings, this type is identical with miniature type 12AU7. The 6AU7 is a DISCONTINUED type listed for reference only.

## 6AU7

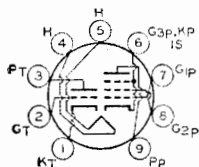

### MEDIUM-MU TRIODE— SHARP-CUTOFF PENTODE

Miniature types used in television receiver applications. Tubes have controlled heater warm-up time for use in series-heater strings. Pentode unit is used as video amplifier, if amplifier,

## 6AU8 6AU8-A

age amplifier. Triode unit is used in sync-amplifier, sync-separator, sync-clipper, and phase-inverter circuits. Outline 14, OUTLINES SECTION. Tubes require nine-contact socket and may be mounted in any position.

HEATER VOLTAGE (AC/DC)	6.3	volt-
HEATER CURRENT	0.6	ampere-
HEATER WARM-UP TIME (Average)	11	seconds

#### DIRECT INTERELECTRODE CAPACITANCES:

Triode Unit:		
Grid to Plate	2.2	μf
Grid to Cathode and Heater	2.6	μf
Plate to Cathode and Heater	0.34	μf
Pentode Unit:		
Grid No.1 to Plate	0.044	μf
Grid No.1 to Plate (6AU8-A)	0.06	μf
Grid No.1 to Cathode, Heater, Grid No.2, Grid No.3, and Internal Shield	7.5	μf
Plate to Cathode, Heater, Grid No.2, Grid No.3, and Internal Shield	2.4	μf
Plate to Cathode, Heater, Grid No.2, Grid No.3, and Internal Shield (6AU8-A)	3.4	μf
Triode Grid to Pentode Plate	0.022 max	μf
Pentode Grid No.1 to Triode Plate	0.006 max	μf
Pentode Plate to Triode Plate	0.12 max	μf

### CLASS A<sub>1</sub> AMPLIFIER

#### Maximum Ratings, 6AU8:

	Triode Unit	Pentode Unit	
PLATE VOLTAGE	300 max	300 max	volts
GRID-NO.2 (SCREEN-GRID) SUPPLY VOLTAGE	—	300 max	volts
GRID-NO.2 VOLTAGE	—	See curve page 66	
GRID-NO.1 (CONTROL-GRID) VOLTAGE, Positive bias value	0 max	0 max	volts
PLATE DISSIPATION	2.5 max	3 max	watts
GRID-NO.2 INPUT:			
For grid-No.2 voltages up to 150 volts	—	1 max	watt
For grid-No.2 voltages between 150 and 300 volts	—	See curve page 66	
PEAK HEATER-CATHODE VOLTAGE:			
Heater negative with respect to cathode	200 max	200 max	volts
Heater positive with respect to cathode	200 max	200 max	volts

**Maximum Ratings, 6A8-A, (Design-Maximum Values):**

	Triode Unit	Pentode Unit	
PLATE VOLTAGE.....	330 max	330 max	volts
GRID-NO.2 (SCREEN-GRID) SUPPLY VOLTAGE.....	-	330 max	volts
GRID-NO.2 VOLTAGE.....	-	See curve page 66	
GRID-NO.1 (CONTROL-GRID) VOLTAGE, Positive bias value.....	0 max	0 max	volts
PLATE DISSIPATION.....	2.8 max	3.3 max	watts
GRID-NO.2 INPUT			
For grid-No.2 voltages up to 165 volts.....	-	1 max	watt
For grid-No.2 voltages between 165 and 330 volts.....	-	See curve page 66	
PEAK HEATER-CATHODE VOLTAGE:			
Heater negative with respect to cathode.....	200 max	200 max	volts
Heater positive with respect to cathode.....	200 max	200 max	volts

Characteristics:	6A8		6A8-A		
	Triode Unit	Pentode Unit	Triode Unit	Pentode Unit	
Plate Supply Voltage.....	150	200	150	200	volts
Grid-No.2 Supply Voltage.....	-	125	-	125	volts
Cathode-Bias Resistor.....	150	82	150	82	ohms
Amplification Factor.....	40	-	43	-	
Plate Resistance (Approx.).....	8200	150000	8100	100000	ohms
Transconductance.....	4900	7000	5300	8000	$\mu$ hos
Grid-No.1 Voltage (Approx.) for plate current of 100 $\mu$ a.....	-6.5	-8	-6.5	-7.5	volts
Plate Current.....	9	15	9.5	17	ma
Grid-No.2 Current.....	-	3.4	-	3.4	ma

**Maximum Circuit Values:**

Grid-No.1-Circuit Resistance:			
For fixed-bias operation.....	0.5 max	0.25 max	megohm
For cathode-bias operation.....	1.0 max	1.0 max	megohm

▪ The dc component must not exceed 100 volts.

**BEAM POWER TUBE**

**6AV5-GA**

**6AV5-GT**

Glass octal types used as horizontal deflection amplifiers in television receivers employing either transformer coupling or direct coupling to the deflecting yoke. 6AV5-GA

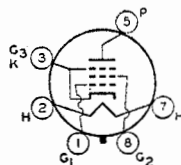

Outline 33, 6AV5-GT Outline 22, OUTLINES SECTION. Tubes require octal socket and may be mounted in any position. Type 6AV5-GT is a **DISCONTINUED** type listed for reference only.

HEATER VOLTAGE (AC/DC).....	6.3	volts
HEATER CURRENT.....	1.2	amperes
TRANSCONDUCTANCE*.....	5900	$\mu$ hos
MU FACTOR, Grid No.2 to Grid No.1**.....	4.3	

\* Plate volts, 250; grid-No.2 volts, 150; grid-No.1 volts, -22.5.

\*\* Triode connected; plate and grid-No.2 volts, 150; grid-No.1 volts, -22.5.

**HORIZONTAL DEFLECTION AMPLIFIER**

*For operation in a 525-line, 30-frame system*

Maximum Ratings:		
DC PLATE VOLTAGE.....	550 max	volts
PEAK POSITIVE-PULSE PLATE VOLTAGE† (Absolute Maximum).....	5500 max	volts
PEAK NEGATIVE-PULSE PLATE VOLTAGE.....	-1250 max	volts
DC GRID-NO.2 (SCREEN-GRID) VOLTAGE.....	175 max	volts
PEAK NEGATIVE-PULSE GRID-NO.1 (CONTROL-GRID) VOLTAGE.....	-300 max	volts
PEAK CATHODE CURRENT.....	400 max	ma
AVERAGE CATHODE CURRENT.....	110 max	ma
GRID-NO.2 INPUT.....	2.5 max	watts
PLATE DISSIPATION††.....	11 max	watts
PEAK HEATER-CATHODE VOLTAGE:		
Heater negative with respect to cathode.....	200 max	volts
Heater positive with respect to cathode.....	200 max	volts
BULB TEMPERATURE (At hottest point).....	210 max	°C

**Maximum Circuit Value:**

Grid-No.1 Circuit Resistance.....	0.47 max	megohm
-----------------------------------	----------	--------

† The duration of the voltage pulse must not exceed 15 per cent of one horizontal scanning cycle. In a 525-line, 30-frame system, 15 per cent of one horizontal scanning cycle is 10 microseconds.

‡ Under no circumstances should this absolute value be exceeded.

†† An adequate bias resistor or other means is required to protect the tube in the absence of excitation.

▪ The dc component must not exceed 100 volts.

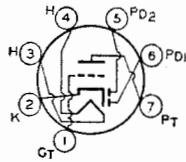

### TWIN DIODE—HIGH-MU TRIODE

Miniature type used as combined detector, amplifier, and avc tube in automobile and ac-operated radio receivers. The 6AV6 may be substituted directly for the 6AT6 in applications where the higher amplification of the 6AV6 is advantageous.

# 6AV6

HEATER VOLTAGE (AC/DC).....	6.3	volts	
HEATER CURRENT.....	0.3	ampere	
	<i>Without External Shield</i>	<i>With External Shield<sup>■</sup></i>	
<b>DIRECT INTERELECTRODE CAPACITANCES:</b>			
Triode Grid to Triode Plate .....	2.0	2.0	$\mu\mu\text{f}$
Triode Grid to Cathode and Heater .....	2.2	2.2	$\mu\mu\text{f}$
Triode Plate to Cathode and Heater .....	0.8	1.2	$\mu\mu\text{f}$
Plate of Diode Unit No.2 to Triode Grid.....	0.04 max	0.04 max	$\mu\mu\text{f}$

■ With external shield connected to cathode.

### TRIODE UNIT AS CLASS A<sub>1</sub> AMPLIFIER

<b>Maximum Rating, (Design-Maximum Value):</b>		
PLATE VOLTAGE.....	330 max	volts
GRID VOLTAGE, Positive Bias Value.....	0 max	volts
PLATE DISSIPATION.....	0.55 max	watt
<b>PEAK HEATER-CATHODE VOLTAGE:</b>		
Heater negative with respect to cathode.....	200 max	volts
Heater positive with respect to cathode.....	200*max	volts

### Characteristics:

Plate Voltage.....	100	250	volts
Grid Voltage.....	-1	-2	volts
Amplification Factor.....	100	100	
Plate Resistance.....	80000	62500	ohms
Transconductance.....	1250	1600	$\mu\text{mhoe}$
Plate Current.....	0.50	1.2	ma

### DIODE UNITS

<b>Maximum Rating, (Design-Maximum Value):</b>		
PLATE CURRENT (Each Unit).....	1.0 max	ma

\* The dc component must not exceed 100 volts.

The two diode plates are placed around a cathode, the sleeve of which is common to the triode unit. Each diode plate has its own base pin. Diode biasing of the triode unit is not recommended.

### INSTALLATION AND APPLICATION

Type 6AV6 requires miniature seven-contact socket and may be mounted in any position. Outline 11, OUTLINES SECTION.

The triode unit of the 6AV6 is recommended for use only in resistance-coupled circuits. Refer to the RESISTANCE-COUPLED AMPLIFIER SECTION for typical operating conditions.

**Grid bias** for the triode unit of the 6AV6 may be obtained from a fixed source, such as a fixed-voltage tap on the dc power supply, or from a cathode-bias resistor. It should not be obtained by the diode-biasing method because of the probability of plate-current cutoff, even with relatively small signal voltages applied to the diode circuit.

AVERAGE DIODE CHARACTERISTICS  
HALF-WAVE RECTIFICATION—SINGLE DIODE UNIT

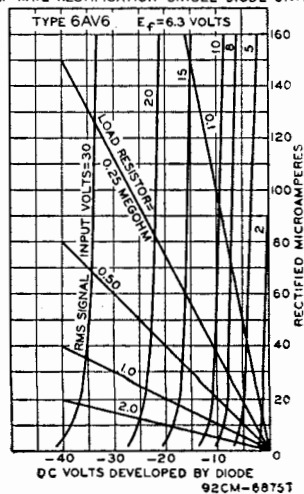

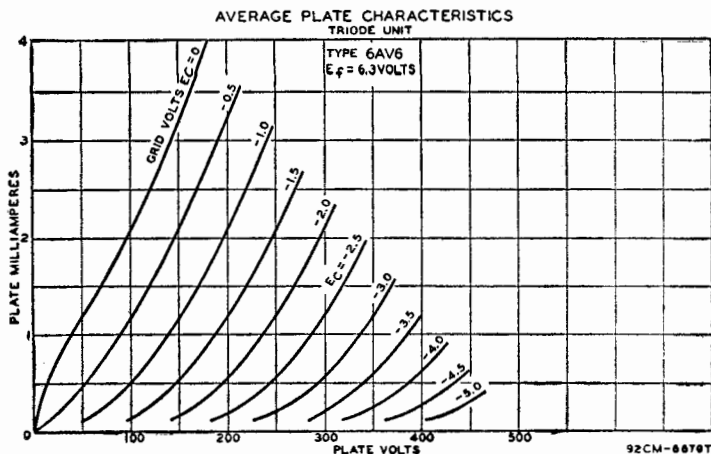

## 6AW8 6AW8-A

### HIGH-MU TRIODE— SHARP-CUTOFF PENTODE

Miniature types used in a wide variety of applications in television receivers. These types have a controlled heater warm-up time for use in receivers employing series-connected

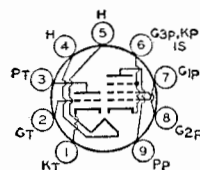

heater strings. The pentode unit is used as an if amplifier, video amplifier, age amplifier, or reactance tube. The triode unit is used in low-frequency oscillator, sync-separator, sync-clipper, and phase-splitter circuits. Outline 14, OUTLINES SECTION. Tubes require miniature nine-contact socket and may be mounted in any position. Type 6AW8 is a discontinued type listed for reference only.

HEATER VOLTAGE (AC/DC) .....	6.3	volts
HEATER CURRENT .....	0.6	ampere
HEATER WARM-UP TIME (AVERAGE) .....	11	seconds

**DIRECT INTERELECTRODE CAPACITANCES:**

**Triode Unit:**

	Without External Shield	With External Shield <sup>■</sup>	
Grid to Plate .....	2.2	2.2	μf
Grid to Cathode, Pentode Cathode, Pentode Grid No.3, Internal Shield, and Heater .....	3.2	3.4	μf
Plate to Cathode, Pentode Cathode, Pentode Grid No.3, Internal Shield, and Heater .....	1.8	3.0	μf

**Pentode Unit:**

Grid No.1 to Plate .....	0.05 max	0.04 max	μf
Grid No.1 to Cathode, Heater, Grid No.2, Grid No.3, and Internal Shield .....	10	10	μf
Plate to Cathode, Heater, Grid No.2, Grid No.3, and In- ternal Shield .....	3.6	4.5	μf
Pentode Grid No.1 to Triode Plate .....	0.008 max	0.005 max	μf
Pentode Plate to Triode Plate .....	0.15 max	0.025 max	μf

<sup>■</sup> With external shield connected to pins 4 and 5.

#### CLASS A<sub>1</sub> AMPLIFIER

**Maximum Ratings, (Design-Maximum Values):**

	Triode Unit	Pentode Unit	
PLATE VOLTAGE .....	330 max	330 max	volts
GRID-NO.2 (SCREEN-GRID) SUPPLY VOLTAGE .....	-	330 max	volts
GRID-NO.2 VOLTAGE .....	-	See curve page 66	
GRID-NO.1 (CONTROL-GRID) VOLTAGE:			
Positive bias value .....	0 max	0 max	volts
PLATE DISSIPATION .....	1.1 max	3.75 max	watts
GRID-NO.2 INPUT:			
For grid-No.2 voltages up to 165 volts .....	-	1.1 max	watts
For grid-No.2 voltages between 165 and 330 volts .....	-	See curve page 66	
PEAK HEATER-CATHODE VOLTAGE:			
Heater negative with respect to cathode .....	200 max	200 max	volts
Heater positive with respect to cathode .....	200 <sup>o</sup> max	200 <sup>o</sup> max	volts



## AVERAGE CHARACTERISTICS

TRIODE UNIT

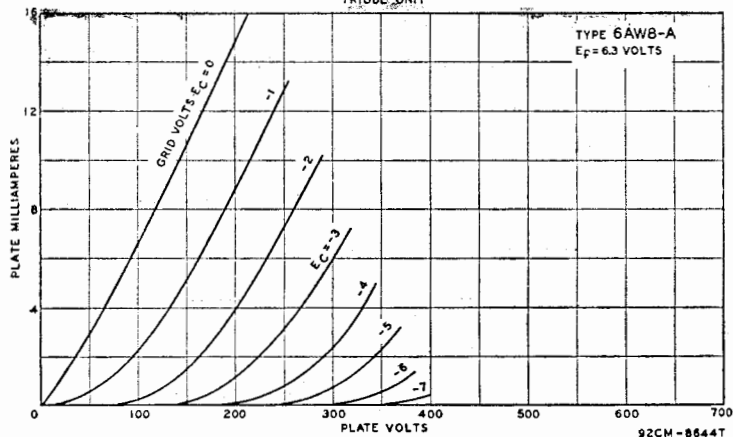

### Characteristics:

	Triode Unit	Pentode Unit	
Plate Supply Voltage.....	200	150	volts
Grid-No.2 Supply Voltage.....	-	150	volts
Grid-No.1 Voltage.....	-2	-	volts
Cathode-Bias Resistor.....	-	150	ohms
Amplification Factor.....	70	-	
Plate Resistance (Approx.).....	-	0.2	megohm
Transconductance.....	4000	9500	μmhos
Grid-No.1 Voltage (Approx.) for plate current of 20 μa....	-5	-8	volts
Plate Current.....	4	15	ma
Grid-No.2 Current.....	-	3.5	ma

### Maximum Circuit Values:

Grid-No.1-Circuit Resistance:			
For fixed-bias operation.....	0.5 max	0.25 max	megohm
For cathode-bias operation.....	1.0 max	1.6 max	megohm

\*The dc component must not exceed 100 volts.

## AVERAGE CHARACTERISTICS

PENTODE UNIT

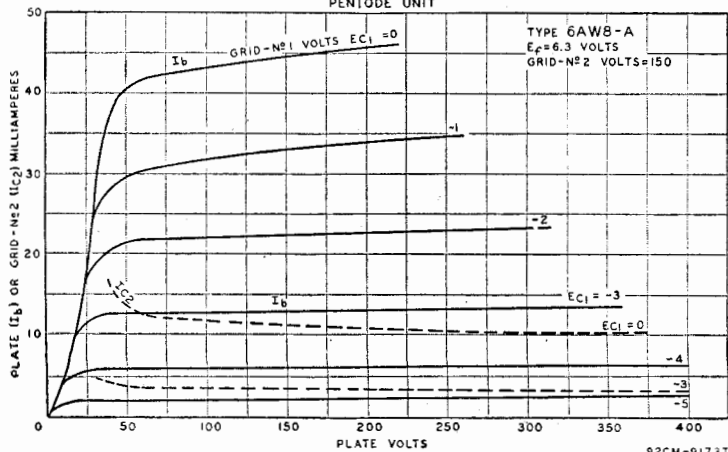

### HALF-WAVE VACUUM RECTIFIER

## 6AX4-GT 6AX4-GTB

Glass octal types used as damper tube in horizontal deflection circuits of television receivers. Outline 22, OUTLINES SECTION. May be supplied with pin No. 1 omitted. Tubes require

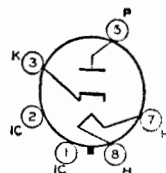

octal socket and may be operated in any position. Socket terminals 1, 2, 4, and 6 should not be used as tie points. It is especially important that these tubes, like other power-handling tubes, be adequately ventilated. For curve of average plate characteristics, see page 67.

HEATER VOLTAGE (AC/DC).....	6.3	volts
HEATER CURRENT.....	1.2	amperes
DIRECT INTERELECTRODE CAPACITANCES (Approx.): <sup>o</sup>		
Cathode to Plate and Heater.....	8.5	$\mu\text{f}$
Plate to Cathode and Heater.....	5	$\mu\text{f}$
Heater to Cathode.....	4	$\mu\text{f}$

#### DAMPER SERVICE

For operation in a 525-line, 30-frame system

#### Maximum Ratings, (Design-Maximum Values):

	6AX4-GT	6AX4-GTB	
PEAK INVERSE PLATE VOLTAGE <sup>o</sup> .....	4400 max	5000 max	volts
PEAK PLATE CURRENT.....	825 max	1000 max	ma
DC PLATE CURRENT.....	137 max	165 max	ma
PLATE DISSIPATION.....	5 max	5.3 max	watts
PEAK HEATER-CATHODE VOLTAGE:			
Heater negative with respect to cathode.....	4400 <sup>o</sup> max	5000 <sup>o</sup> max	volts
Heater positive with respect to cathode.....	300 <sup>o</sup> max	300 <sup>o</sup> max	volts

#### Characteristics, Instantaneous Test Condition:

Tube Voltage Drop for plate ma. =250.....	32	32	volts
---	----	----	-------

<sup>o</sup> Without external shield.

■ The duration of the voltage pulse must not exceed 15 per cent of one horizontal scanning cycle. In a 525-line, 30-frame system, 15 per cent of one horizontal scanning cycle is 10 microseconds.

● The dc component must not exceed 900 volts.

□ The dc component must not exceed 100 volts.

### FULL-WAVE VACUUM RECTIFIER

## 6AX5-GT

Glass octal type used in power supply of radio equipment having moderate dc requirements. Outline 22, OUTLINES SECTION. This type may be supplied with pin No.1 omitted.

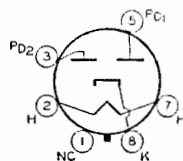

Tube requires octal socket and may be mounted in any position. It is especially important that this tube, like other power-handling tubes, be adequately ventilated.

HEATER VOLTAGE (AC).....	6.3	volts
HEATER CURRENT.....	1.2	amperes

#### FULL-WAVE RECTIFIER

#### Maximum Ratings:

PEAK INVERSE PLATE VOLTAGE.....	1250 max	volts
PEAK PLATE CURRENT (Per Plate).....	375 max	ma
HOT-SWITCHING TRANSIENT PLATE CURRENT		
For duration of 0.2 second maximum.....	2.6 max	amperes
AC PLATE SUPPLY VOLTAGE (Per Plate, rms).....	See Rating Chart	
DC OUTPUT CURRENT (Per Plate, rms).....	See Rating Chart	
PEAK HEATER-CATHODE VOLTAGE:		
Heater negative with respect to cathode.....	450 max	volts
Heater positive with respect to cathode.....	450 max	volts

#### Typical Operation with Capacitor Input to Filter:

AC Plate-to-Plate Supply Voltage (rms).....	700	900	volts
Filter Input Capacitor.....	10	10	$\mu\text{f}$
Effective Plate-Supply Impedance Per Plate.....	50	105	ohms
DC Output Voltage at Input to Filter (Approx.):			
At half-load current of { 62.5 ma.....	395	-	volts
40 ma.....	-	540	volts
At full-load current of { 125 ma.....	350	-	volts
80 ma.....	-	490	volts
Voltage Regulation (Approx.):			
Half-load to full-load current.....	45	50	volts

**Typical Operation with Choke Input to Filter:**

AC Plate-to-Plate Supply Voltage (rms).....	700	900	volts
Filter Input Choke.....	10 #	10 #	henries
DC Output Voltage at Input to Filter (Approx.):			
At half-load current of { 75 ma .....	270		volts
{ 62.5 ma .....		365	volts
At full-load current of { 150 ma .....	250		volts
{ 125 ma .....	-	350	volts
Voltage Regulation (Approx.):			
Half-load to full-load current.....	20	15	volts

\* Higher values of capacitance than indicated may be used but the effective plate-supply impedance may have to be increased to prevent exceeding the maximum rating for hot-switching transient plate current.

‡ This value is adequate to maintain optimum regulation provided the load current is not less than 30 ma. For load currents less than 30 ma, a larger value of inductance is required for optimum regulation.

‡‡ This value is adequate to maintain optimum regulation provided the load current is not less than 35 ma. For load currents less than 35 ma, a larger value of inductance is required for optimum regulation.

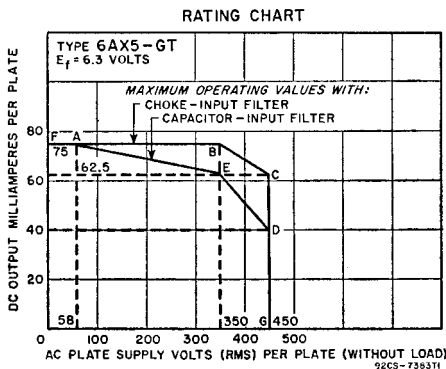

**MEDIUM-MU TRIODE—  
SEMIREMOTE-CUTOFF PENTODE**

6AX8

Miniature type used in television-receiver applications; the pentode unit is used as a video amplifier; the triode unit is used as a sync separator. Outline 12, OUTLINES SECTION. Tube

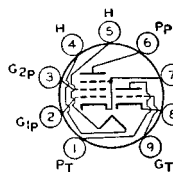

requires miniature nine-contact socket and may be mounted in any position.

HEATER VOLTAGE (AC/DC) .....	6.3	volts
HEATER CURRENT.....	0.45	ampere
DIRECT INTERELECTRODE CAPACITANCES: <sup>o</sup>		
Triode Unit:		
Grid to Plate.....	1.8	$\mu\mu\text{f}$
Grid to Cathode and Heater.....	2.5	$\mu\mu\text{f}$
Plate to Cathode and Heater.....	1	$\mu\mu\text{f}$
Pentode Unit:		
Grid No.1 to Plate.....	0.006 max	$\mu\mu\text{f}$
Grid No.1 to Cathode, Heater, Grid No.2, Grid No.3, and Internal Shield.....	5	$\mu\mu\text{f}$
Plate to Cathode, Heater, Grid No.2, Grid No.3 and Internal Shield ..	3.5	$\mu\mu\text{f}$
Heater to Cathode (Each unit) .....	3.5•	$\mu\mu\text{f}$

**CLASS A<sub>1</sub> AMPLIFIER**

**Maximum Ratings:**

	<i>Triode Unit</i>	<i>Pentode Unit</i>	
PLATE VOLTAGE .....	300 <i>max</i>	300 <i>max</i>	volts
GRID-NO.2 SUPPLY VOLTAGE .....	-	300 <i>max</i>	volts
GRID-NO.2 (SCREEN-GRID) VOLTAGE .....	-	See curve page 66	
GRID-NO.1 (CONTROL-GRID) VOLTAGE .....	0 <i>max</i>	0 <i>max</i>	volts
PLATE DISSIPATION .....	2.7 <i>max</i>	2.8 <i>max</i>	watts
GRID-NO.2 INPUT			
For grid-No.2 voltages up to 150 volts .....	-	0.5 <i>max</i>	watt
For grid-No.2 voltages between 150 and 300 volts .....	-	See curve page 66	
<b>PEAK HEATER-CATHODE VOLTAGE:</b>			
Heater negative with respect to cathode .....	90 <i>max</i>	90 <i>max</i>	volts
Heater positive with respect to cathode .....	90 <i>max</i>	90 <i>max</i>	volts

**Characteristics:**

Plate Supply Voltage .....	150	250	volts
Grid-No.2 Supply Voltage .....	-	110	volts
Cathode-Bias Resistor .....	56	120	ohms
Amplification Factor .....	40	-	
Plate Resistance (Approx.) .....	0.005	0.4	megohm
Transconductance .....	8500	4800	$\mu$ mhos
Grid-No.1 Voltage (Approx.) for plate current of 10 $\mu$ a .....	-12	-12	volts
Plate Current .....	18	10	ma
Grid-No.2 Current .....	-	3.5	ma

**Maximum Circuit Values:**

<b>Grid-No.1 Circuit Resistance:</b>			
For fixed-bias operation .....	0.1 <i>max</i>	0.1 <i>max</i>	megohm
For cathode-bias operation .....	0.5 <i>max</i>	0.5 <i>max</i>	megohm

<sup>o</sup> With external shield connected to cathode of unit under test except as noted.

• With external shield connected to ground.

**HALF-WAVE VACUUM RECTIFIER**

**6AY3**

Novar type used as damper tube in horizontal deflection circuits of black-and-white television receivers. Outline 54, OUTLINES SECTION. Tube requires octal socket and may be operated in any position. Socket terminals 1, 3, 6, and 8 should not be used as tie points. It is especially important that this tube, like other power-handling tubes, be adequately ventilated. For curve of average plate characteristics, see page 67.

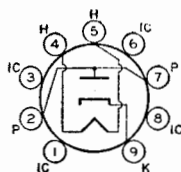

ated in any position. Socket terminals 1, 3, 6, and 8 should not be used as tie points. It is especially important that this tube, like other power-handling tubes, be adequately ventilated. For curve of average plate characteristics, see page 67.

HEATER VOLTAGE (AC/DC) .....	6.3	volts
HEATER CURRENT .....	1.2	amperes
<b>DIRECT INTERELECTRODE CAPACITANCES (Approx.):<sup>o</sup></b>		
Plate to Cathode and Heater .....	6.5	$\mu$ f
Cathode to Plate and Heater .....	9.0	$\mu$ f
Heater to Cathode .....	2.8	$\mu$ f

**DAMPER SERVICE**

*For operation in a 525-line, 30-frame system*

**Maximum Ratings, (Design-Maximum Values):**

PEAK INVERSE PLATE VOLTAGE <sup>■</sup> .....	5000 <i>max</i>	volts
PEAK PLATE CURRENT .....	1100 <i>max</i>	ma
DC PLATE CURRENT .....	175 <i>max</i>	ma
PLATE DISSIPATION .....	6.5 <i>max</i>	watts
<b>PEAK HEATER-CATHODE VOLTAGE:</b>		
Heater negative with respect to cathode .....	5000 <sup>•</sup> <i>max</i>	volts
Heater positive with respect to cathode .....	300 <sup>□</sup> <i>max</i>	volts

<sup>o</sup> Without external shield.

<sup>■</sup> The duration of the voltage pulse must not exceed 15 per cent of one horizontal scanning cycle. In a 525-line, 30-frame system, 15 per cent of one horizontal scanning cycle is 10 microseconds.

<sup>•</sup> The dc component must not exceed 900 volts.

<sup>□</sup> The dc component must not exceed 100 volts.

### MEDIUM-MU TRIODE— SHARP-CUTOFF PENTODE

# 6AZ8

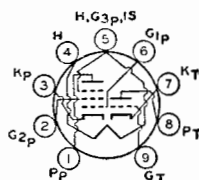

Miniature type used in a wide variety of applications in television receivers. The pentode unit is used as an if amplifier, video amplifier, aac amplifier, or reactance tube. The triode unit is used in low-frequency oscillator, sync-separator, sync-clipper, and phase-splitter circuits. Outline 12, OUTLINES SECTION. Tube requires miniature nine-contact socket and may be mounted in any position.

HEATER VOLTAGE (AC/DC) .....	6.3	volts
HEATER CURRENT .....	0.45	ampere
DIRECT INTERELECTRODE CAPACITANCES:		
Triode Unit:		
Grid to Plate .....	1.7	$\mu\text{f}$
Grid to Cathode, Heater, Pentode Grid No.3, and Internal Shield .....	2	$\mu\text{f}$
Plate to Cathode, Heater, Pentode Grid No.3, and Internal Shield .....	1.7	$\mu\text{f}$
Pentode Unit:		
Grid No.1 to Plate .....	0.02 max	$\mu\text{f}$
Grid No.1 to Cathode, Heater, Grid No.2, Grid No.3, and Internal Shield .....	6.5	$\mu\text{f}$
Plate to Cathode, Heater, Grid No.2, Grid No.3, and Internal Shield .....	2.2	$\mu\text{f}$
Triode Grid to Pentode Plate .....	0.027 max	$\mu\text{f}$
Pentode Grid No.1 to Triode Plate .....	0.020 max	$\mu\text{f}$
Pentode Plate to Triode Plate .....	0.045 max	$\mu\text{f}$

#### CLASS A<sub>1</sub> AMPLIFIER

<b>Maximum Ratings:</b>	<i>Triode Unit</i>	<i>Pentode Unit</i>	
PLATE VOLTAGE .....	300 max	300 max	volts
GRID-NO.2 (SCREEN-GRID) SUPPLY VOLTAGE .....	-	300 max	volts
GRID-NO.2 VOLTAGE .....	-	See curve page 66	
GRID-NO.1 (CONTROL-GRID) VOLTAGE, Positive bias value .....	0 max	0 max	volts
PLATE DISSIPATION .....	2.6 max	2 max	watts
GRID-NO.2 INPUT:			
For grid-No.2 voltages up to 150 volts .....	-	0.5 max	watt
For grid-No.2 voltages between 150 and 300 volts .....	-	See curve page 66	
PEAK HEATER-CATHODE VOLTAGE:			
Heater negative with respect to cathode .....	200 max	▲	volts
Heater positive with respect to cathode .....	200 max	▲	volts

#### Characteristics:

Plate Supply Voltage .....	200	200	volts
Grid-No.2 Voltage .....	-	150	volts
Grid-No.1 Voltage .....	-6	-	volts
Cathode-Bias Resistor .....	-	180	ohms
Amplification Factor .....	19	-	
Plate Resistance (Approx.) .....	5750	300000	ohms
Transconductance .....	3300	6000	$\mu\text{mhos}$
Grid-No.1 Voltage (Approx.) for plate current of 10 $\mu\text{a}$ .....	-19	-	volts
Grid-No.1 Voltage (Approx.) for transconductance of 100 $\mu\text{mhos}$ .....	-	-12.5	volts
Plate Current .....	13	9.5	ma
Grid-No.2 Current .....	-	3	ma

#### Maximum Circuit Values:

Grid-No.1-Circuit Resistance: <sup>*</sup>			
For fixed-bias operation .....	0.5 max	0.25 max	megohm
For cathode-bias operation .....	1.0 max	1.0 max	megohm

■ The dc component must not exceed 100 volts.

▲ The heater-cathode voltage should not exceed the value of the operating cathode bias. If the heater-cathode voltage exceeds the operating cathode bias value, grid No.3 will be made negative with respect to cathode, and thus possibly cause a change in tube characteristics.

\* If either unit is operating at maximum rated conditions, grid-No.1-circuit resistance for both units should not exceed the stated values.

### POWER TRIODE

# 6B4-G

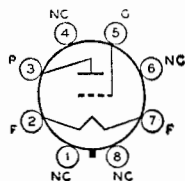

Glass octal type used in output stage of radio receivers and amplifiers. Outline 50, OUTLINES SECTION. Tube requires octal socket. For typical operation as a single-tube class A amplifier, refer to type 2A3. Filament volts (ac/dc), 6.3; amperes, 1.0. Maximum ratings as push-pull class AB<sub>1</sub> amplifier: plate volts, 325; plate dissipation, 15 watts. Type 6B4-G is a DISCONTINUED type listed for reference only.

6B5

**DIRECT-COUPLED POWER TRIODE**

Glass type used as class A<sub>1</sub> power amplifier. One triode, the driver, is directly connected within the tube to the second, or output, triode. Outline 43, OUTLINES SECTION. Tube requires six-contact socket. Heater volts (ac/dc), 6.3; amperes, 0.8. Characteristics of input and output triodes as class A<sub>1</sub> amplifier follow. Input triode: plate volts, 300 *max*; grid volts, 0; plate

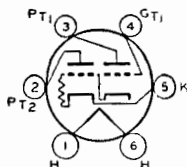

*ma.*, 8. Output triode: plate volts, 300 *max*; plate *ma.*, 45; plate resistance, 24000 ohms; load resistance, 7000 ohms; output watts, 4. This is a DISCONTINUED type listed for reference only.

6B6-G

**TWIN-DIODE—HIGH-MU TRIODE**

Glass octal type used as combined detector, amplifier, and avc tube. Outline 39, OUTLINES SECTION. Tube requires octal socket. Heater volts (ac/dc), 6.3; amperes, 0.3. Within its triode maximum plate-voltage rating of 250 volts, this type is similar electrically to type 6SQ7 and curves under that type apply to the 6B6-G. This is a DISCONTINUED type listed for reference only.

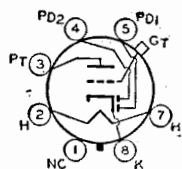

6B7  
6B7S

**TWIN-DIODE—  
REMOTE-CUTOFF PENTODE**

Glass types used as combined detector, amplifier, and avc tubes. Outline 40, OUTLINES SECTION. These types fit the small seven-contact (0.75-inch, pin-circle diameter) socket. Except for interelectrode capacitances, the electrical characteristics of the 6B7 are identical with those of type 6B8-G. Type 6B7S has the external shield connected to the cathode. In

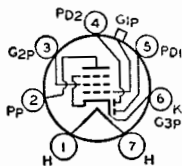

general, its electrical characteristics are similar to those of the 6B7, but the two types are usually not directly interchangeable. These are DISCONTINUED types listed for reference only.

6B8  
6B8-G

**TWIN-DIODE—  
SEMIREMOTE-CUTOFF PENTODE**

Metal type 6B8 and glass octal type 6B8-G are used as combined detector, amplifier, and avc tubes. Outlines 4 and 39, respectively, OUTLINES SECTION. Type 6B8 is used principally for renewal purposes; 6B8-G is a DISCONTINUED type listed for reference only. Tubes require octal socket. Heater volts (ac/dc), 6.3; amperes, 0.3. Maximum ratings of pentode unit as class A<sub>1</sub> amplifier: plate volts,

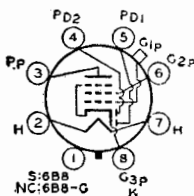

300 *max*; grid-No.2 volts, 125 *max*; grid-No.2 supply volts, 300 *max*; grid-No.1 volts, positive-bias valuc, 0 *max*; plate dissipation, 3.0 *max* watts (6B8), 2.25 *max* watts (6B8-G); grid-No.2 input, 0.3 *max* watt.

6BA6

**REMOTE-CUTOFF PENTODE**

Miniature type used as rf amplifier in standard broadcast and FM receivers, as well as in wide-band, high-frequency applications. This type is similar in performance to metal type

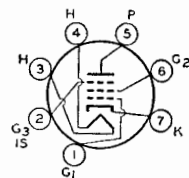

6SG7. The low value of grid-No.1-to-plate capacitance minimizes regenerative effects, while the high transconductance makes possible high signal-to-noise ratio.

## Technical Data

HEATER VOLTAGE (AC/DC).....	6.3	volts
HEATER CURRENT.....	0.3	ampere
<b>DIRECT INTERELECTRODE CAPACITANCES:</b>		
Grid No.1 to Plate.....	<i>Without External Shield</i> 0.0035 <i>max</i>	<i>With External Shield</i> <sup>■</sup> 0.0035 <i>max</i> $\mu\text{f}$
Grid No.1 to Cathode, Heater, Grid No.2, Grid No.3, and Internal Shield.....	5.5	5.5 $\mu\text{f}$
Plate to Cathode, Heater, Grid No.2, Grid No.3, and Internal Shield.....	5.0	5.5 $\mu\text{f}$

■ With external shield connected to cathode.

### CLASS A<sub>1</sub> AMPLIFIER

Maximum Ratings, (Design-Maximum Values):

PLATE VOLTAGE.....	330 <i>max</i>	volts
GRID NO.3 (SUPPRESSOR GRID) AND INTERNAL SHIELD.....	Connect to cathode at socket	
GRID-NO.2 (SCREEN-GRID) VOLTAGE.....	See curve page 66	
GRID-NO.2 SUPPLY VOLTAGE.....	330 <i>max</i>	volts
PLATE DISSIPATION.....	3.4 <i>max</i>	watts
GRID-NO.2 INPUT:		
For grid-No.2 voltages up to 165 volts.....	0.7 <i>max</i>	watt
For grid-No.2 voltages between 165 and 330 volts.....	See curve page 66	
GRID-NO.1 (CONTROL-GRID) VOLTAGE:		
Negative bias value.....	-55 <i>max</i>	volts
Positive bias value.....	0 <i>max</i>	volts
PEAK HEATER-CATHODE VOLTAGE:		
Heater negative with respect to cathode.....	200 <i>max</i>	volts
Heater positive with respect to cathode.....	200* <i>max</i>	volts

\* The dc component must not exceed 100 volts.

#### Characteristics:

Plate Supply Voltage.....	100	250	volts
Grid No.3 and Internal Shield.....	Connected to cathode at socket		
Grid-No.2 Supply Voltage.....	100	100	volts
Cathode-Bias Resistor.....	68	68	ohms
Plate Resistance (Approx.).....	0.25	1.0	megohm
Transconductance.....	4300	4400	$\mu\text{mhos}$
Grid-No.1 Voltage (Approx.) for transconductance of 40 $\mu\text{mhos}$ .....	-20	-20	volts
Plate Current.....	10.8	11	ma
Grid-No.2 Current.....	4.4	4.2	ma

### INSTALLATION AND APPLICATION

Type 6BA6 requires miniature seven-contact socket and may be mounted in any position. Outline 11, OUTLINES SECTION.

Control-grid bias variation will be found effective in changing the volume of the receiver. In order to obtain adequate volume control, an available grid-No.1-bias voltage of approximately 50 volts will be required. The exact value will depend upon the circuit design and operating conditions. This voltage may be obtained, depending on the receiver requirements, from a potentiometer across a fixed supply voltage, from a variable cathode-bias resistor, from the avc system, or from a combination of these methods.

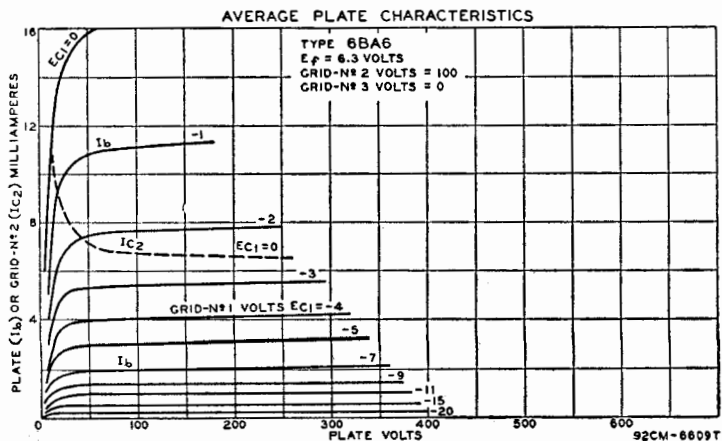

The grid-No. 2 (screen-grid) voltage may be obtained from a potentiometer or bleeder circuit across the B-supply source, or through a dropping resistor from the plate supply. The use of series resistors for obtaining satisfactory control of grid-No.2 voltage in the case of four-electrode tubes is usually impossible because of secondary-emission phenomena. In the 6BA6, however, because grid No.3 practically removes these effects, it is practical to obtain grid-No.2 voltage through a series-dropping resistor from the plate supply or from some high intermediate voltage, provided the source does not exceed the plate-supply voltage. With this method, the grid-No.2-to-cathode voltage will fall off very little from minimum to maximum value of the resistor controlling cathode bias. In some cases, it may actually rise. This rise of grid-No.2-to-cathode voltage above the normal maximum value is allowable because both the grid-No.2 current and the plate current are reduced simultaneously by a sufficient amount to prevent damage to the tube. It should be recognized that, in general, the series-resistor method of obtaining grid-No.2 voltage from a higher voltage supply necessitates the use of the variable cathode-resistor method of controlling volume in order to prevent too high a voltage on grid No.2. When grid-No.2 and control-grid voltage are obtained in this manner, the remote "cutoff" advantage of the 6BA6 can be fully realized. However, it should be noted that the use of a resistor in the grid-No.2 circuit will have an effect on the change in plate resistance with variation in grid-No.3 (suppressor-grid) voltage in case grid No.3 is utilized for control purposes.

Grid No. 3 (suppressor grid) may be connected directly to the cathode or it may be made negative with respect to the cathode. For the latter condition, the grid-No.3 voltage may be obtained from a potentiometer or bleeder circuit, or from the avc system.

### PENTAGRID CONVERTER

Miniature type used as converter in superheterodyne circuits especially those for the FM broadcast band. Outline 14, OUTLINES SECTION. Tube requires miniature nine-contact socket and may be mounted in any position.

## 6BA7

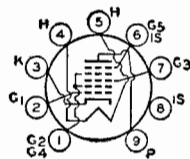

HEATER VOLTAGE (AC/DC) .....	6.3	volts
HEATER CURRENT .....	0.3	ampere

#### Maximum Ratings:

#### CONVERTER SERVICE

PLATE VOLTAGE .....	300 max	volts
GRIDS-NO.5-AND-INTERNAL-SHIELD VOLTAGE* .....	0 max	volts
GRIDS-NO.2-AND-NO.4 (SCREEN-GRID) VOLTAGE .....	100 max	volts
GRIDS-NO.2-AND-NO.4 SUPPLY VOLTAGE .....	300 max	volts
PLATE DISSIPATION .....	2.0 max	watts
GRIDS-NO.2-AND-NO.4 INPUT .....	1.5 max	watts
TOTAL CATHODE CURRENT .....	22 max	ma
GRID-NO.3 VOLTAGE:		
Negative bias value .....	-100 max	volts
Positive bias value .....	0 max	volts
PEAK HEATER-CATHODE VOLTAGE:		
Heater negative with respect to cathode .....	90 max	volts
Heater positive with respect to cathode .....	90 max	volts

#### Characteristics (Separate Excitation):\*

Plate Voltage .....	100	250	volts
Grid No.5 and Internal Shield* .....	Connected directly to ground		
Grids-No.2-and-No.4 (Screen-Grid) Voltage .....	100	100	volts
Grid-No.3 (Control-Grid) Voltage .....	-1.0	-1.0	volt
Grid-No.1 (Oscillator-Grid) Resistor .....	20000	20000	ohms
Plate Resistance (Approx.) .....	0.5	1.0	megohm
Conversion Transconductance .....	900	950	μmhos
Conversion Transconductance (Approx.)** .....	3.5	3.5	μmhos
Plate Current .....	3.6	3.8	ma
Grids-No.2-and-No.4 Current .....	10.2	10	ma
Grid-No.1 Current .....	0.35	0.35	ma
Total Cathode Current .....	14.2	14.2	ma



NOTE: The transconductance between grid No.1 and grids No.2 and No.4 connected to plate (not oscillating) is approximately 8000  $\mu$ mhos under the following conditions: signal applied to grid No.1 at zero bias; grids No.2 and No.4 and plate at 100 volts; grid No.3 grounded. Under the same conditions, the plate current is 32 milliamperes, and the amplification factor is 16.5.

\* The characteristics shown with separate excitation correspond very closely with those obtained in a self-excited oscillator circuit operating with zero bias.

\*\* With grid-No.3 bias of -20 volts.

• Internal Shield (pins No.6 and No.8) connected directly to ground.

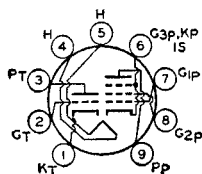

### MEDIUM-MU TRIODE — SHARP-CUTOFF PENTODE

# 6BA8-A

Miniature type used in a wide variety of applications in color and black-and-white television receivers. This type has a controlled heater warm-up time for use in receivers employing series-connected heater strings.

The pentode unit is used as a video amplifier, an age amplifier, or a reactance tube. The triode unit is used in low-frequency oscillator and phase-splitter circuits. Outline 14, OUTLINES SECTION. Tube requires miniature nine-contact socket and may be mounted in any position.

HEATER VOLTAGE (AC/DC) .....	6.3	volts
HEATER CURRENT .....	0.6	ampere
HEATER WARM-UP TIME (Average) .....	11	seconds

	Without External Shield	With External Shield*	
<b>DIRECT INTERELECTRODE CAPACITANCES (Approx.):</b>			
<b>Triode Unit:</b>			
Grid to Plate .....	2.2	2.2	$\mu$ f
Grid to Cathode and Heater .....	2.5	2.7	$\mu$ f
Plate to Cathode and Heater .....	0.4	1.9	$\mu$ f
<b>Pentode Unit:</b>			
Grid No.1 to Plate .....	0.04	0.03	$\mu$ f
Grid No.1 to Cathode, Heater, Grid No.2, Grid No.3, and Internal Shield .....	10	10	$\mu$ f
Plate to Cathode, Heater, Grid No.2, Grid No.3, and Internal Shield .....	3.6	4.5	$\mu$ f
Triode Grid to Pentode Plate .....	0.016	0.006	$\mu$ f
Pentode Grid No.1 to Triode Plate .....	0.006	0.003	$\mu$ f
Pentode Plate to Triode Plate .....	0.15	0.023	$\mu$ f

\* With external shield connected to cathode of unit under test.

#### CLASS A<sub>1</sub> AMPLIFIER

	Triode Unit	Pentode Unit	
<b>Maximum Ratings:</b>			
PLATE VOLTAGE .....	300 <i>max</i>	300 <i>max</i>	volts
GRID-NO.2 (SCREEN-GRID) SUPPLY VOLTAGE .....	-	300 <i>max</i>	volts
GRID-NO.2 VOLTAGE .....	-	See curve page 66	
<b>GRID-NO.1 (CONTROL-GRID) VOLTAGE:</b>			
Negative bias value .....	-	-50 <i>max</i>	volts
Positive bias value .....	-	0 <i>max</i>	volts
PLATE DISSIPATION .....	2 <i>max</i>	3.25 <i>max</i>	watts
<b>GRID-NO.2 INPUT:</b>			
For grid-No.2 voltages up to 150 volts .....	-	1 <i>max</i>	watt
For grid-No.2 voltages between 150 and 300 volts .....	-	See curve page 66	
<b>PEAK HEATER-CATHODE VOLTAGE:</b>			
Heater negative with respect to cathode .....	200 <i>max</i>	200 <i>max</i>	volts
Heater positive with respect to cathode .....	200 <i>max</i>	200 <i>max</i>	volts
<b>Characteristics:</b>			
Plate-Supply Voltage .....	200	200	volts
Grid-No.2 Supply Voltage .....	-	150	volts
Grid-No.1 Voltage .....	-8	-	volts
Cathode-Bias Resistor .....	-	180	ohms
Amplification Factor .....	18	-	
Plate Resistance (Approx.) .....	6700	40000	ohms
Transconductance .....	2700	9000	$\mu$ mhos
Grid-No.1 Voltage (Approx.) for plate current of 10 $\mu$ a .....	-16	-10	volts
Plate Current .....	8	13	ma
Grid-No.2 Current .....	-	3.5	ma

#### Maximum Circuit Values:

Grid-No.1-Circuit Resistance:			
For fixed-bias operation .....	0.5 <i>max</i>	0.25 <i>max</i>	megohm
For cathode-bias operation .....	1.0 <i>max</i>	1.0 <i>max</i>	megohm

\* The dc component must not exceed 100 volts.

# 6BC4

## MEDIUM-MU TRIODE

Miniature type used as an rf amplifier in the cathode-drive circuits of uhf television tuners covering the frequency range of 470 to 890 megacycles per second. Outline 10, OUTLINES

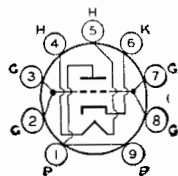

SECTION. Tube requires miniature nine-contact socket and may be mounted in any position.

HEATER VOLTAGE (AC/DC).....	6.3	volts
HEATER CURRENT.....	0.225	ampere
DIRECT INTERELECTRODE CAPACITANCES (Approx.):		
Grid to Plate.....	1.6	$\mu\text{f}$
Grid to Heater and Cathode.....	2.9	$\mu\text{f}$
Plate to Heater and Cathode.....	0.26	$\mu\text{f}$
Heater to Cathode.....	2.7	$\mu\text{f}$

### CLASS A<sub>1</sub> AMPLIFIER

**Maximum Ratings:**

PLATE VOLTAGE.....	250 max	volts
PLATE DISSIPATION.....	2.5 max	watts
CATHODE CURRENT.....	25 max	ma
PEAK HEATER-CATHODE VOLTAGE:		
Heater negative with respect to cathode.....	75 max	volts
Heater positive with respect to cathode.....	75 max	volts

**Characteristics:**

Plate Supply Voltage.....	150	volts
Cathode-Bias Resistor.....	100	ohms
Amplification Factor.....	48	
Plate Resistance (Approx.).....	4800	ohms
Transconductance.....	10000	$\mu\text{mhos}$
Grid Voltage (Approx.) for plate current of 10 $\mu\text{a}$ .....	-10	volts
Plate Current.....	14.5	ma

**Maximum Circuit Values:**

Grid-Circuit Resistance:		
For fixed-bias operation.....		Not recommended
For cathode-bias operation.....	0.5 max	megohm

# 6BC5

## SHARP-CUTOFF PENTODE

Miniature type used in compact radio equipment as an rf or if amplifier at frequencies up to 400 megacycles per second. Outline 11, OUTLINES

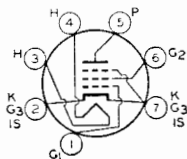

SECTION. Tube requires miniature seven-contact socket and may be mounted in any position. For typical operation as resistance-coupled amplifier, refer to RESISTANCE-COUPLED AMPLIFIER SECTION.

HEATER VOLTS (AC/DC).....	6.3	volts
HEATER CURRENT.....	0.3	ampere
DIRECT INTERELECTRODE CAPACITANCES:		
Pentode Connection:		
Grid No.1 to Plate.....	0.030 max	$\mu\text{f}$
Grid No.1 to Cathode, Heater, Grid No.2, Grid No.3, and Internal Shield.....	6.5	$\mu\text{f}$
Plate to Cathode, Heater, Grid No.2, Grid No.3, and Internal Shield.....	1.8	$\mu\text{f}$
Triode Connection:*		
Grid No.1 to Plate and Grid No.2.....	2.5	$\mu\text{f}$
Grid No.1 to Cathode, Heater, Grid No.3, and Internal Shield.....	3.9	$\mu\text{f}$
Plate and Grid No.2 to Cathode, Heater, Grid No.3, and Internal Shield.....	3.0	$\mu\text{f}$

\* Grid No.2 connected to plate.

## CLASS A<sub>1</sub> AMPLIFIER

<b>Maximum Ratings:</b>	<i>Triode Connection*</i>		<i>Pentode Connection</i>			
PLATE VOLTAGE.....	300 max		300 max		volts	
GRID-NO.2 (SCREEN-GRID) SUPPLY VOLTAGE.....	-		300 max		volts	
GRID-NO.2 VOLTAGE.....	-		See curve page 66			
GRID-NO.1 (CONTROL-GRID) VOLTAGE, Positive bias value..	0 max		0 max volts			
PLATE DISSIPATION.....	2.5 max		2 max watts			
GRID-NO.2 INPUT:						
For grid-No.2 voltages up to 150 volts.....	-		0.5 max		watt	
For grid-No.2 voltages between 150 and 300 volts.....	-		See curve page 66			
<b>PEAK HEATER-CATHODE VOLTAGE:</b>						
Heater negative with respect to cathode.....	90 max		90 max		volts	
Heater positive with respect to cathode.....	90 max		90 max		volts	
<b>Characteristics:</b>						
Plate Supply Voltage.....	180	250	100	125	250	volts
Grid-No.2 Supply Voltage.....	-	-	100	125	150	volts
Cathode-Bias Resistor.....	330	820	180	100	180	ohms
Amplification Factor.....	42	40	-	-	-	
Plate Resistance (Approx.).....	0.006	0.009	0.6	0.5	0.8	megohm
Transconductance.....	6000	4400	4900	6100	5700	μmhos
Grid-No.1 Voltage (Approx.) for plate current of 10 μA.....	-	-	-5	-6	-8	volts
Plate Current.....	8	6	4.7	8	7.5	ma
Grid-No.2 Current.....	-	-	1.4	2.4	2.1	ma

\* Grid No.2 connected to plate.

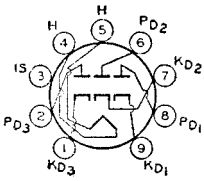

### TRIPLE DIODE

Miniature type containing three high-perveance diode units in one envelope; used in dc restorer circuits of color television receivers. Also used in AM/FM radio receivers as a combination

# 6BC7

F<sub>M</sub> discriminator and AM detector tube. Outline 12, OUTLINES SECTION. Tube requires nine-contact miniature socket and may be mounted in any position.

HEATER VOLTAGE (AC/DC).....	6.3	volts
HEATER CURRENT.....	0.450	ampere
<b>DIRECT INTERELECTRODE CAPACITANCES (Approx.):</b>		
Diode-No.1 Plate to Diode-No.1 Cathode, Heater, and Internal Shield.....	3.5	μfd
Diode-No.2 Plate to Diode-No.2 Cathode, Heater, and Internal Shield.....	5.5	μfd
Diode-No.3 Plate to Diode-No.3 Cathode, Heater, and Internal Shield.....	3.5	μfd

**Maximum Ratings (Each Diode Unit):**

PEAK INVERSE PLATE VOLTAGE.....	330 max	volts
PEAK PLATE CURRENT*.....	54 max	ma
DC OUTPUT CURRENT.....	12 max	ma
<b>PEAK HEATER-CATHODE VOLTAGE:</b>		
Heater negative with respect to cathode.....	200 max	volts
Heater positive with respect to cathode.....	200 max	volts

\* In rectifier service, the minimum total effective plate-supply impedance per plate is 560 ohms.

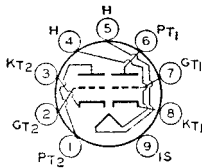

### MEDIUM-MU TWIN TRIODE

Miniature type used in direct-coupled cathode-drive rf amplifier circuits of vhf television tuners. In such circuits, one triode unit is used as the direct-coupled grounded-cathode driver

# 6BC8

for the other unit. This type is also used in push-pull cathode-drive rf amplifiers. Outline 12, OUTLINES SECTION. Tube requires miniature nine-contact socket and may be mounted in any position.

HEATER VOLTAGE (AC/DC).....	6.3	volts	
HEATER CURRENT.....	0.4	ampere	
<b>DIRECT INTERELECTRODE CAPACITANCES*:</b>	<i>Unit No.1</i>	<i>Unit No.2</i>	
Grid to Plate.....	1.2	1.2	μfd
Grid to Cathode, Heater, and Internal Shield.....	2.6	-	μfd
Cathode to Grid, Heater, and Internal Shield.....	-	5.5	μfd
Plate to Cathode, Heater, and Internal Shield.....	1.3	-	μfd
Plate to Grid, Heater, and Internal Shield.....	-	2.4	μfd
Plate to Cathode.....	-	0.12	μfd
Heater to Cathode.....	2.8	2.8	μfd
Plate of Unit No.1 to Plate of Unit No.2.....	0.02 max		μfd
Plate of Unit No.2 to Plate and Grid of Unit No.1.....	0.04 max		μfd

\* With external shield connected to internal shield.

**CLASS A<sub>1</sub> AMPLIFIER (Each Unit)**

Maximum Ratings, (Design-Maximum Values):

PLATE VOLTAGE.....	250* <i>max</i>	volts
PLATE DISSIPATION.....	2.2 <i>max</i>	watts
CATHODE CURRENT.....	22 <i>max</i>	ma
<b>PEAK HEATER-CATHODE VOLTAGE:</b>		
Heater negative with respect to cathode.....	200* <i>max</i>	volts
Heater positive with respect to cathode.....	200* <i>max</i>	volts

**Characteristics:**

Plate Supply Voltage.....	150	volts
Cathode-Bias Resistor.....	220	ohms
Plate Resistance (Approx.).....	5300	ohms
Amplification Factor.....	35	
Transconductance.....	6200	$\mu$ mhos
Grid Voltage (Approx.) for transconductance of 50 $\mu$ mhos.....	-13	volts
Plate Current.....	10	ma

**Maximum Circuit Value:**

Grid-Circuit Resistance.....	0.5 <i>max</i>	megohm
------------------------------	----------------	--------

\* This rating may be as high as 300 volts under cutoff conditions, when the tube is used as a cascode amplifier and the two units are connected in series.

■ The dc component must not exceed 100 volts.

**SHARP-CUTOFF BEAM TRIODE**

**6BD4**  
**6BD4-A**

Glass octal types used for the voltage regulation of high-voltage, low-current dc power supplies in color television receivers. Outline 47, OUTLINES SECTION. Tubes require octal socket. Heater volts (ac/dc), 6.3; amperes, 0.6. Maximum ratings for voltage-control service: dc plate volts, 6BD4 20000 *max*, 6BD4-A 27000 *max*; unregulated dc supply volts, 6BD4 40000 *max*, 6BD4-A 55000 *max*; dc grid volts, -125

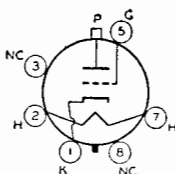

*max*; peak grid volts, -550 *max*; dc plate ma., 1.5 *max*; plate dissipation, 6BD4 20 *max* watts, 6BD4-A 25 *max* watts; peak heater-cathode volts, 180 *max*. These are DISCONTINUED types listed for reference only.

**REMOTE-CUTOFF PENTODE**

**6BD6**

Miniature type used as rf or if amplifier in radio receivers. This type is similar in performance to metal type 6SK7. Outline 11, OUTLINES SECTION. Tube requires miniature seven-contact socket and may be mounted in any position. Heater volts (ac/dc), 6.3; amperes, 0.3. Characteristics as class A<sub>1</sub> amplifier: plate volts, 250 (300 *max*); grid No.3 connected to cathode at socket; grid-No.2 volts, 100 (125

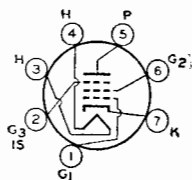

*max*); grid-No.1 volts, -3; plate resistance (approx.), 0.8 megohm; transconductance, 2000  $\mu$ mhos; plate dissipation, 3 *max* watts; grid-No.2 input, 0.65 *max* watt; plate ma., 9; grid-No.2 ma., 3; total cathode ma., 14 *max*; peak heater-cathode volts, 90 *max*. This type is used principally for renewal purposes.

**PENTAGRID CONVERTER**

**6BE6**

Miniature type used as converter in superheterodyne circuits in both the standard broadcast and FM bands. The 6BE6 is similar in performance to metal type 6SA7. For general discussion of pentagrid types, see *Frequency Conversion* in ELECTRON TUBE APPLICATION SECTION.

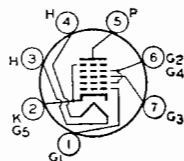

of pentagrid types, see *Frequency Conversion* in ELECTRON TUBE APPLICATION SECTION.

# Technical Data

HEATER VOLTAGE (AC/DC).....	6.3	volts
HEATER CURRENT.....	0.3	ampere

### DIRECT INTERELECTRODE CAPACITANCES:

	Without External Shield	With External Shield <sup>■</sup>	
Grid No.3 to Plate.....	0.30 max	0.25 max	μf
Grid No.3 to Grid No.1.....	0.15 max	0.15 max	μf
Grid No.1 to Plate.....	0.10 max	0.05 max	μf
Grid No.3 to All Other Electrodes.....	7.0	7.0	μf
Grid No.1 to All Other Electrodes.....	5.5	5.5	μf
Plate to All Other Electrodes.....	8.0	13.0	μf
Grid No.1 to Cathode and Grid No.5.....	3.0	3.0	μf
Cathode and Grid No.5 to All Other Electrodes except Grid No.1.....	15.0	20.0	μf

■ With external shield connected to cathode and grid No.5.

### CONVERTER

#### Maximum Ratings, (Design-Maximum Values):

PLATE VOLTAGE.....	330 max	volts
GRIDS-NO.2-AND-NO.4 (SCREEN-GRID) VOLTAGE.....	110 max	volts
GRIDS-NO.2-AND-NO.4 SUPPLY VOLTAGE.....	330 max	volts
PLATE DISSIPATION.....	1.1 max	watts
GRIDS-NO.2-AND-NO.4 INPUT.....	1.1 max	watts
CATHODE CURRENT.....	15.5 max	ma
GRID-NO.3 VOLTAGE:		
Negative bias value.....	-55 max	volts
Positive bias value.....	0 max	volts
PEAK HEATER-CATHODE VOLTAGE:		
Heater negative with respect to cathode.....	200 max	volts
Heater positive with respect to cathode.....	200*max	volts

#### Typical Operation (Separate Excitation):\*

Plate Voltage.....	100	250	volts
Grids-No.2-and-No.4 (Screen-Grid) Voltage.....	100	100	volts
Grid-No.1 (Oscillator-Grid) Voltage (rms).....	10	10	volts
Grid-No.3 (Control-Grid) Voltage.....	-1.5	-1.5	volts
Grid-No.1 (Oscillator-Grid) Resistor.....	20000	20000	ohms
Plate Resistance (Approx.).....	0.4	1.0	megohm
Conversion Transconductance.....	455	475	μmhos
Grid-No.3 Voltage for conversion transconductance of 10 μmhos.....	-30	-30	volts
Plate Current.....	2.6	2.9	ma
Grids-No.2-and-No.4 Current.....	7.0	6.8	ma
Grid-No.1 Current.....	0.5	0.5	ma
Cathode Current.....	10.1	10.2	ma

Note: The transconductance between grid No.1 and grids No.2 and No.4 connected to plate (not oscillating) is approximately 7250 μmhos under the following conditions: grids No.1 and No.3 at 0 volts; grids No.2 and No.4 and plate at 100 volts. Under the same conditions, the cathode current is 25 ma., and the amplification factor is 20. Grid-No.1 voltage (Approx.) for plate current of 10 μa is -11 volts.

\* The dc component must not exceed 100 volts.

\* The characteristics shown with separate excitation correspond very closely with those obtained in a self-excited oscillator circuit operating with zero bias.

OPERATION CHARACTERISTICS  
WITH SELF-EXCITATION

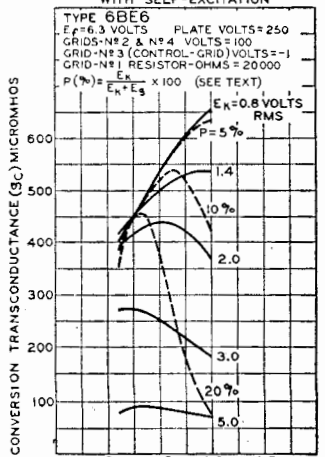

92CM-6625T

OPERATION CHARACTERISTICS  
WITH SEPARATE OSCILLATOR EXCITATION

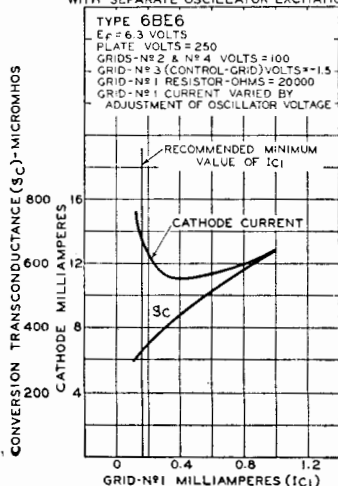

92CM-6624T

### INSTALLATION AND APPLICATION

Type 6BE6 requires miniature seven-contact socket and may be mounted in any position. Outline 11, OUTLINES SECTION.

Because of the special structural arrangement of the 6BE6, a change in signal-grid voltage produces little change in cathode current. Consequently, an rf voltage on the signal grid produces little modulation of the electron current flowing in the cathode circuit. This feature is important because it is desirable that the impedance in the cathode circuit should produce little degeneration or regeneration of the signal-frequency input and intermediate-frequency output. Another important feature is that, because signal-grid voltage has very little effect on the space charge near the cathode, changes in avc bias produce little change in oscillator transconductance and in the input capacitance of grid No.1. There is, therefore, little detuning of the oscillator by avc bias.

A typical self-excited oscillator circuit employing the 6BE6 is given in the CIRCUIT SECTION.

In the 6BE6 operation characteristics curves with self-excitation,  $E_k$  is the voltage across the oscillator-coil section between cathode and ground;  $E_c$  is the oscillator voltage between cathode and grid.

### BEAM POWER TUBE

## 6BF5

Miniature type used in audio output stage of television and radio receivers. Triode-connected, it is used as a vertical deflection amplifier in television receivers. Outline 13, OUTLINES SECTION. Tube requires miniature seven-contact socket and may be mounted in any position. Heater volts (ac/dc), 6.3; amperes, 1.2. Typical operation as class A<sub>1</sub> amplifier: plate volts, 110 (250 *max*); grid-No.2 volts,

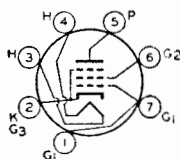

110 (117 *max*); grid-No.1 volts, -7.5; peak af grid-No.1 volts, 7.5; plate dissipation, 5.5 *max* watts; grid-No.2 input, 1.25 *max* watts; plate *ma.*, 36 (zero-signal), 39 (maximum-signal); grid-No.2 *ma.*, 4 (zero-signal), 10.5 (maximum-signal); plate resistance (approx.), 12000 ohms; transconductance, 7500  $\mu$ mhos; plate load resistance, 2500 ohms; total harmonic distortion, 10 per cent; maximum-signal power output, 1.9 watts; peak heater-cathode volts, 200 *max* (dc component 100 *max* when heater is positive with respect to cathode). This type is used principally for renewal purposes.

### TWIN DIODE— MEDIUM-MU TRIODE

## 6BF6

Miniature type used in compact radio equipment as combined detector, amplifier, and avc tube. The triode unit is particularly useful as a driver for impedance- or transformer-coupled

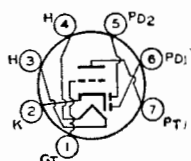

output stages in automobile receivers. It is equivalent in performance to metal type 6SR7. Outline 11, OUTLINES SECTION. Tube requires miniature seven-contact socket and may be mounted in any position.

HEATER VOLTAGE (AC/DC) .....	6.3	volts
HEATER CURRENT .....	0.3	ampere

**DIRECT INTERELECTRODE CAPACITANCES:**

	<i>Without External Shield</i>	<i>With External Shield</i> <sup>■</sup>	
Triode Grid to Triode Plate .....	1.9	1.9	$\mu$ f
Triode Grid to Cathode and Heater .....	1.8	1.9	$\mu$ f
Triode Plate to Cathode and Heater .....	0.7	1.2	$\mu$ f
Plate of Diode Unit No.1 to Triode Grid .....	0.07 <i>max</i>	0.06 <i>max</i>	$\mu$ f
Plate of Diode Unit No.2 to Triode Grid .....	0.06 <i>max</i>	0.05 <i>max</i>	$\mu$ f

■ With external shield connected to cathode.

**Maximum Ratings: TRIODE UNIT AS CLASS A<sub>1</sub> AMPLIFIER**

PLATE VOLTAGE.....	300 <i>max</i>	volts
PLATE DISSIPATION.....	2.5 <i>max</i>	watts
<b>PEAK HEATER-CATHODE VOLTAGE:</b>		
Heater negative with respect to cathode.....	90 <i>max</i>	volts
Heater positive with respect to cathode.....	90 <i>max</i>	volts

**Typical Operation:**

Plate Voltage.....	250	volts
Grid Voltage.....	-9	volts
Amplification Factor.....	16	
Plate Resistance (Approx.).....	8500	ohms
Transconductance.....	1900	μmhos
Plate Current.....	9.5	ma
Load Resistance.....	10000	ohms
Total Harmonic Distortion.....	6.5	per cent
Power Output.....	300	mw

**Maximum Rating: DIODE UNITS**

PLATE CURRENT (Each Unit).....	1.0 <i>max</i>	ma
--------------------------------	----------------	----

The two diode plates and the triode unit have a common cathode. Diode biasing of the triode unit of the 6BG6 is not suitable. For diode operation curves, refer to type 6AV6.

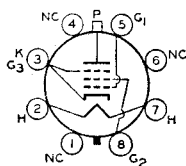

**BEAM POWER TUBE**

Glass octal types used as output amplifier in horizontal-deflection circuits of television equipment and other applications where high pulse voltages occur during short duty cycles. Out-

**6BG6-G**

**6BG6-GA**

lines 52 and 46, respectively, OUTLINES SECTION. Tubes require octal socket. Type 6BG6-G is supplied with pins 4 and 6 or with pins 1, 4, and 6 omitted. Type 6BG6-GA may be supplied with pins 4 and 6 or with pins 1, 4, and 6 omitted. Vertical tube mounting is preferred but horizontal operation is permissible if pins No.2 and 7 are in vertical plane. Type 6BG6-G is used principally for renewal purposes.

HEATER VOLTAGE (AC/DC).....	6.3	volts
HEATER CURRENT.....	0.9	ampere
<b>DIRECT INTERELECTRODE CAPACITANCES:</b>		
Grid No.1 to Plate.....	0.34	μf
Grid No.1 to Cathode, Heater, Grid No.2, and Grid No.3.....	12	μf
Plate to Cathode, Heater, Grid No.2, and Grid No.3.....	6.5	μf
TRANSCONDUCTANCE <sup>†</sup> .....	6000	μmhos
MU-FACTOR, Grid No.2 to Grid No.1 <sup>°</sup> .....	8.0	

<sup>°</sup>For plate and grid-No.2 volts, 250; grid-No.1 volts, -15.

**HORIZONTAL DEFLECTION AMPLIFIER**

*For operation in a 525-line, 30-frame system*

**Maximum Ratings:**

DC PLATE VOLTAGE.....	700 <i>max</i>	volts
PEAK POSITIVE-PULSE PLATE VOLTAGE* (Absolute Maximum).....	6600* <i>max</i>	volts
PEAK NEGATIVE-PULSE PLATE VOLTAGE.....	-1500 <i>max</i>	volts
DC GRID-NO.2 (SCREEN-GRID) VOLTAGE.....	350 <i>max</i>	volts
PEAK NEGATIVE-PULSE GRID-NO.1 (CONTROL-GRID) VOLTAGE.....	-300 <i>max</i>	volts
PEAK CATHODE CURRENT.....	400 <i>max</i>	ma
AVERAGE CATHODE CURRENT.....	110 <i>max</i>	ma
PLATE DISSIPATION††.....	20 <i>max</i>	watts
GRID-NO.2 INPUT.....	3.2 <i>max</i>	watts
<b>PEAK HEATER-CATHODE VOLTAGE:</b>		
Heater negative with respect to cathode.....	200 <i>max</i>	volts
Heater positive with respect to cathode.....	200 <i>max</i>	volts
BULB TEMPERATURE (At hottest point).....	210 <i>max</i>	°C

**Maximum Circuit Value:**

Grid-No.1-Circuit Resistance.....	0.47 <i>max</i>	megohm
-----------------------------------	-----------------	--------

\*The duration of the voltage pulse must not exceed 15 per cent of one horizontal scanning cycle. In a 525-line, 30-frame system, 15 per cent of one horizontal scanning cycle is 10 microseconds.

† Under no circumstances should this absolute value be exceeded.

†† An adequate bias resistor or other means is required to protect the tube in the absence of excitation.

‡ The dc component must not exceed 100 volts.

**HALF-WAVE VACUUM RECTIFIER**

**6BH3**

Novar type used as damper tube in horizontal deflection circuits of black-and-white television receivers. Outline 54, OUTLINES SECTION. Tube requires octal socket and may be operated in any position. Socket terminals 1, 3, 6, and 8 should not be used as tie points. It is especially important that this tube, like other power-handling tubes, be adequately ventilated. For curve of average plate characteristics, see page 67.

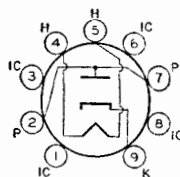

HEATER VOLTAGE (AC/DC) .....	6.3	volts
HEATER CURRENT .....	1.6	amperes
DIRECT INTERELECTRODE CAPACITANCES (Approx.): <sup>o</sup>		
Plate to Cathode and Heater .....	6.5	$\mu\mu\text{f}$
Cathode to Plate and Heater .....	9.0	$\mu\mu\text{f}$
Heater to Cathode .....	2.8	$\mu\mu\text{f}$

**DAMPER SERVICE**

For operation in a 525-line, 30-frame system

Maximum Ratings, (Design-Maximum Values):

PEAK INVERSE PLATE VOLTAGE <sup>■</sup> .....	5500 <i>max</i>	volts
PEAK PLATE CURRENT .....	1100 <i>max</i>	ma
DC PLATE CURRENT .....	180 <i>max</i>	ma
PLATE DISSIPATION .....	6.5 <i>max</i>	watts
PEAK HEATER-CATHODE VOLTAGE:		
Heater negative with respect to cathode .....	5500 <i>max</i>	volts
Heater positive with respect to cathode .....	300 <i>max</i>	volts

<sup>o</sup> Without external shield.

<sup>■</sup> The duration of the voltage pulse must not exceed 15 per cent of one horizontal scanning cycle. In a 525-line, 30-frame system, 15 per cent of one horizontal scanning cycle is 10 microseconds.

<sup>\*</sup> The dc component must not exceed 900 volts.

<sup>†</sup> The dc component must not exceed 100 volts.

**SHARP-CUTOFF PENTODE**

**6BH6**

Miniature type used as rf amplifier particularly in ac/dc receivers and in mobile equipment where low heater-current drain is important. It is particularly useful in high-frequency,

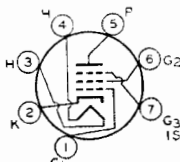

wide-band applications. Outline 11, OUTLINES SECTION. Tube requires miniature seven-contact socket and may be mounted in any position.

HEATER VOLTAGE (AC/DC) .....	6.3	volts
HEATER CURRENT .....	0.15	ampere
DIRECT INTERELECTRODE CAPACITANCES: <sup>■</sup>		
Grid No.1 to Plate .....	0.0035 <i>max</i>	$\mu\mu\text{f}$
Grid No.1 to Cathode, Heater, Grid No.2, Grid No.3, and Internal Shield .....	5.4	$\mu\mu\text{f}$
Plate to Cathode, Heater, Grid No.2, Grid No.3, and Internal Shield .....	4.4	$\mu\mu\text{f}$

<sup>■</sup> Without external shield, or with external shield connected to cathode.

Maximum Ratings:

**CLASS A<sub>1</sub> AMPLIFIER**

PLATE VOLTAGE .....	300 <i>max</i>	volts
GRID NO.3 (SUPPRESSOR GRID) AND INTERNAL SHIELD .....	Connect to cathode at socket	
GRID-NO.2 (SCREEN-GRID) VOLTAGE .....	See curve page 66	
GRID-NO.2 SUPPLY VOLTAGE .....	300 <i>max</i>	volts
PLATE DISSIPATION .....	3 <i>max</i>	watts
GRID-NO.2 INPUT:		
For grid-No.2 voltages up to 150 volts .....	0.5 <i>max</i>	watt
For grid-No.2 voltages between 150 and 300 volts .....	See curve page 66	
GRID-NO.1 (CONTROL-GRID) VOLTAGE:		
Negative bias value .....	-50 <i>max</i>	volts
Positive bias value .....	0 <i>max</i>	volts
PEAK HEATER-CATHODE VOLTAGE:		
Heater negative with respect to cathode .....	90 <i>max</i>	volts
Heater positive with respect to cathode .....	90 <i>max</i>	volts



**Characteristics:**

Plate Voltage.....	100	250	volts
Grid-No.3 and Internal Shield.....	Connected to cathode at socket		
Grid-No.2 Voltage.....	100	150	volts
Grid-No.1 Voltage.....	-1	-1	volt
Plate Resistance (Approx.).....	0.7	1.4	megohms
Transconductance.....	3400	4600	μmhos
Grid-No.1 Voltage (Approx.) for plate current of 10 μa.....	-5	-7.7	volts
Plate Current.....	3.6	7.4	ma
Grid-No.2 Current.....	1.4	2.9	ma

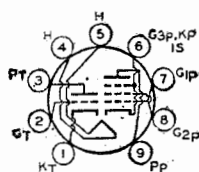

**MEDIUM-MU TRIODE—  
SHARP-CUTOFF PENTODE**

Miniature type used in a wide variety of applications in television receivers. This type has a controlled heater warm-up time for use in receivers employing series-connected

**6BH8**

heater strings. The pentode unit is used as an if amplifier, a video amplifier, or an agc amplifier. The triode unit is used in low-frequency oscillator circuits. Outline 14, OUTLINES SECTION. Tube requires miniature nine-contact socket and may be mounted in any position.

HEATER VOLTAGE (AC/DC).....	6.3	volts
HEATER CURRENT.....	0.6	ampere
HEATER WARM-UP TIME (Average).....	11	seconds
<b>DIRECT INTERELECTRODE CAPACITANCES (Approx.):</b>		
<b>Triode Unit:</b>		
Grid to Plate.....	2.4	μf
Grid to Cathode and Heater.....	2.6	μf
Plate to Cathode and Heater.....	0.38	μf
<b>Pentode Unit:</b>		
Grid No.1 to Plate.....	0.046	μf
Grid No.1 to Cathode, Heater, Grid No.2, Grid No.3, and Internal Shield.....	7	μf
Plate to Cathode, Heater, Grid No.2, Grid No.3, and Internal Shield.....	2.4	μf
Triode Grid to Pentode Plate.....	0.016	μf
Pentode Grid No.1 to Triode Plate.....	0.004	μf
Pentode Plate to Triode Plate.....	0.095	μf

**CLASS A<sub>1</sub> AMPLIFIER**

**Maximum Ratings:**

	<i>Triode Unit</i>	<i>Pentode Unit</i>	
PLATE VOLTAGE.....	300 max	300 max	volts
GRID-NO.2 (SCREEN-GRID) SUPPLY VOLTAGE.....	-	300 max	volts
GRID-NO.2 VOLTAGE.....	-	See curve page 66	
GRID-NO.1 (CONTROL-GRID) VOLTAGE, Positive bias value...	0 max	0 max	volts
PLATE DISSIPATION.....	2.5 max	3 max	watts
<b>GRID-NO.2 INPUT:</b>			
For grid-No.2 voltages up to 150 volts.....	-	1 max	watt
For grid-No.2 voltages between 150 and 300 volts.....	-	See curve page 66	
<b>PEAK HEATER-CATHODE VOLTAGE:</b>			
Heater negative with respect to cathode.....	200 max	200 max	volts
Heater positive with respect to cathode.....	200 max	200 max	volts

**Characteristics:**

Plate Supply Voltage.....	150	200	volts
Grid-No.2 Supply Voltage.....	-	125	volts
Grid-No.1 Voltage.....	-5	-	volts
Cathode-Bias Resistor.....	-	82	ohms
Amplification Factor.....	17	-	
Plate Resistance (Approx.).....	5150	15000	ohms
Transconductance.....	3300	7000	μmhos
Grid-No.1 Voltage (Approx.) for plate current of 100 μa...	-14	-8	volts
Plate Current.....	9.5	15	ma
Grid-No.2 Current.....	-	3.4	ma

**Maximum Circuit Values:**

<b>Grid-No.1-Circuit Resistance:</b>			
For fixed-bias operation.....	0.5 max	0.25 max	megohm
For cathode-bias operation.....	1.0 max	1.0 max	megohm

■ The dc component must not exceed 100 volts.

# 6BJ6

## REMOTE-CUTOFF PENTODE

Miniature type used as rf amplifier in high-frequency and wide-band applications. Features high transconductance and low grid-to-plate capacitance. Outline 11, OUTLINES SECTION.

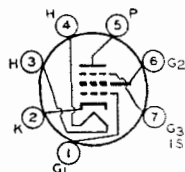

Tube requires miniature seven-contact socket and may be mounted in any position.

HEATER VOLTAGE (AC/DC).....	6.3	volts
HEATER CURRENT.....	0.15	ampere
DIRECT INTERELECTRODE CAPACITANCES:■		
Grid No.1 to Plate.....	0.0035 max	μf
Grid No.1 to Cathode, Heater, Grid No. 2, Grid No. 3, and Internal Shield.....	4.5	μf
Plate to Cathode, Heater, Grid No. 2, Grid No. 3, and Internal Shield....	5.5	μf

■ Without external shield, or with external shield connected to cathode.

### Maximum Ratings:

### CLASS A<sub>1</sub> AMPLIFIER

PLATE VOLTAGE.....	300 max	volts
Grid No. 3 (SUPPRESSOR GRID) AND INTERNAL SHIELD.....	Connect to cathode at socket	
Grid-No.2 (SCREEN-GRID) VOLTAGE.....	See curve page 66	
Grid-No.2 SUPPLY VOLTAGE.....	300 max	volts
PLATE DISSIPATION.....	3 max	watts
Grid-No.2 INPUT:		
For grid-No.2 voltages up to 150 volts.....	0.6 max	watt
For grid-No.2 voltages between 150 and 300 volts.....	See curve page 66	
Grid-No.1 (CONTROL-GRID) VOLTAGE:		
Negative bias value.....	-50 max	volts
Positive bias value.....	0 max	volts
PEAK HEATER-CATHODE VOLTAGE:		
Heater negative with respect to cathode.....	90 max	volts
Heater positive with respect to cathode.....	90 max	volts

### Characteristics:

Plate Voltage.....	100	250	volts
Grid No.3 and Internal Shield.....	Connected to cathode at socket		
Grid-No.2 Voltage.....	100	100	volts
Grid-No.1 Voltage.....	-1.0	-1.0	volt
Plate Resistance (Approx.).....	0.25	1.3	megohms
Transconductance.....	3650	3600	μmhos
Grid-No.1 Voltage (Approx.) for transconductance of 10 μmhos.....	-20	-20	volts
Plate Current.....	9.0	9.2	ma
Grid-No.2 Current.....	3.5	3.3	ma

# 6BJ7

## TRIPLE DIODE

Miniature type used as a dc-restorer tube in each of the three signal channels of color-television receivers. Each diode has a separate cathode. Outline 12, OUTLINES SECTION.

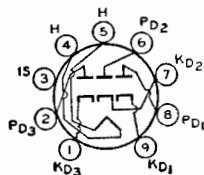

Tube requires miniature nine-contact socket and may be mounted in any position.

HEATER VOLTAGE (AC/DC).....	6.3	volts
HEATER CURRENT.....	0.45	ampere

### DC RESTORER SERVICE

#### Maximum Ratings (Each Diode Unit):

PEAK INVERSE PLATE VOLTAGE.....	330 max	volts
PEAK PLATE CURRENT.....	10 max	ma
DC OUTPUT CURRENT.....	1 max	ma
PEAK HEATER-CATHODE VOLTAGE:		
Heater negative with respect to cathode.....	330 max	volts
Heater positive with respect to cathode.....	100 max	volts

### TWIN DIODE— MEDIUM-MU TRIODE

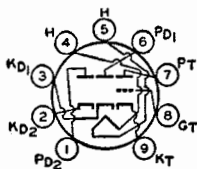

# 6BJ8

Miniature type used in a wide variety of applications in black-and-white and color television receivers. The diode units are used in phase-detector, phase-comparator, ratio-detector or discriminator, and horizontal afc discriminator circuits. The triode unit is used in phase-splitter, audio-frequency amplifier, and low-frequency oscillator applications; it may also be used as a vertical-deflection amplifier in compact portable television receivers. This type has a controlled heater warm-up time for use in receivers employing series-connected heater strings. Each of the three units has its own cathode with individual base-pin terminal to provide for flexibility of circuit connections. Outline 14, OUTLINES SECTION. Tube requires miniature nine-contact socket and may be mounted in any position.

HEATER VOLTS (AC/DC) .....	6.3	volts
HEATER CURRENT .....	0.6	amperes
HEATER WARM-UP TIME (Average) .....	11	seconds
<b>DIRECT INTERELECTRODE CAPACITANCES:</b>		
Triode Unit:		
Grid to Plate .....	2.6	$\mu\text{f}$
Grid to Cathode and Heater .....	2.8	$\mu\text{f}$
Plate to Cathode and Heater .....	0.31	$\mu\text{f}$
Diode Units:		
Plate to Cathode and Heater (Each Unit) .....	1.9	$\mu\text{f}$
Cathode to Plate and Heater (Each Unit) .....	4.6	$\mu\text{f}$
Plate of Unit No.1 to Plate of Unit No.2 .....	0.06 max	$\mu\text{f}$
Plate of Diode Unit No.1 to Triode Grid .....	0.07 max	$\mu\text{f}$
Plate of Diode Unit No.2 to Triode Grid .....	0.11 max	$\mu\text{f}$
Plate of Either Diode Unit to All Other Electrodes .....	3.0	$\mu\text{f}$
Cathode of Either Diode Unit to All Other Electrodes .....	4.8	$\mu\text{f}$

#### TRIODE UNIT AS CLASS A<sub>1</sub> AMPLIFIER

Maximum Ratings, (Design-Maximum Values):

PLATE VOLTAGE .....	330 max	volts
GRID VOLTAGE, Positive bias value .....	0 max	volts
AVERAGE CATHODE CURRENT .....	22 max	ma
PLATE DISSIPATION .....	4 max	watts
<b>PEAK HEATER-CATHODE VOLTAGE:</b>		
Heater negative with respect to cathode .....	200 max	volts
Heater positive with respect to cathode .....	200*max	volts

**Characteristics:**

Plate Voltage .....	90	250	volts
Grid Voltage .....	0	-9	volts
Amplification Factor .....	22	20	
Plate Resistance (Approx.) .....	4700	7150	ohms
Transconductance .....	4700	2800	$\mu\text{mhos}$
Grid Voltage (Approx.) for plate current of 10 $\mu\text{a}$ .....	-7	-18	volts
Plate Current .....	13.5	8	ma
Plate Current for grid voltage of -12.5 volts .....	-	1.7	ma

**Maximum Circuit Value:**

Grid-Circuit Resistance .....	1 max	megohm
-------------------------------	-------	--------

\* The dc component must not exceed 100 volts.

#### TRIODE UNIT AS VERTICAL DEFLECTION AMPLIFIER

*For operation in a 525-line, 30-frame system*

Maximum Ratings, (Design-Maximum Values):

DC PLATE VOLTAGE .....	330 max	volts
PEAK POSITIVE-PULSE PLATE VOLTAGE $\uparrow$ .....	1200 max	volts
PEAK NEGATIVE-PULSE GRID VOLTAGE .....	-275 max	volts
PEAK CATHODE CURRENT .....	77 max	ma
AVERAGE CATHODE CURRENT .....	22 max	ma
PLATE DISSIPATION .....	4 max	watts
<b>PEAK HEATER-CATHODE VOLTAGE:</b>		
Heater negative with respect to cathode .....	200 max	volts
Heater positive with respect to cathode .....	200*max	volts

**AVERAGE CHARACTERISTICS**  
TRIODE UNIT

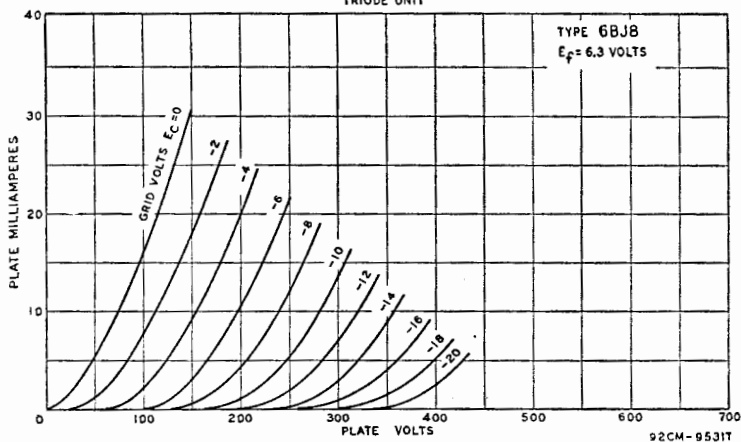

Maximum Circuit Value:

Grid-Circuit Resistance:

For cathode-bias operation..... 2.2 max megohms

**DIODE UNITS**

Maximum Ratings, (Design-Maximum Values):

PLATE CURRENT (Each Unit):

Peak..... 51 max ma

Average..... 9 max ma

PEAK HEATER-CATHODE VOLTAGE:

Heater negative with respect to cathode..... 200 max volts

Heater positive with respect to cathode..... 200 max volts

† The duration of the voltage pulse must not exceed 15 per cent of one vertical scanning cycle. In a 525-line, 30-frame system, 15 per cent of one vertical scanning cycle is 2.5 milliseconds.

‡ The dc component must not exceed 100 volts.

# 6BK4

## SHARP-CUTOFF BEAM TRIODE

Glass octal type used for the voltage regulation of high-voltage, low-current dc power supplies in color television receivers. Outline 46, OUT-LINES SECTION. Tube requires octal socket and may be mounted in any position.

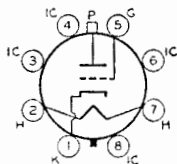

HEATER VOLTAGE (AC/DC).....	6.3	volts
HEATER CURRENT.....	0.2	ampere
DIRECT INTERELECTRODE CAPACITANCES (Approx.):		
Grid to Plate.....	0.03	$\mu$ f
Grid to Cathode and Heater.....	2.6	$\mu$ f
Plate to Cathode and Heater.....	1	$\mu$ f
AMPLIFICATION FACTOR (Approx.).....	2000	

**VOLTAGE-CONTROL SERVICE**

Maximum Ratings, (Design-Maximum Values):

DC PLATE VOLTAGE.....	27000 max	volts
UNREGULATED DC SUPPLY VOLTAGE.....	60000 max	volts
DC GRID VOLTAGE.....	-135 max	volts
PEAK GRID VOLTAGE <sup>†</sup> .....	-440 max	volts
DC PLATE CURRENT.....	1.6 max	ma
PLATE DISSIPATION.....	25 max	watts
PEAK HEATER-CATHODE VOLTAGE:		
Heater negative with respect to cathode.....	200 max	volts
Heater positive with respect to cathode.....	Not recommended	

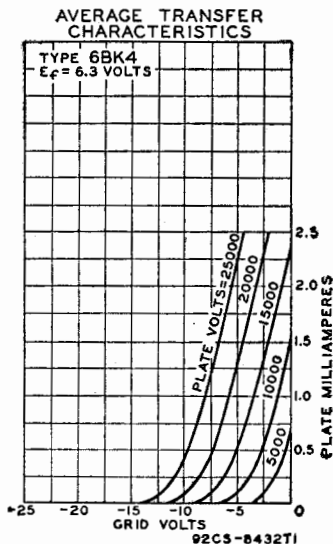

Maximum Circuit Value:

Grid-Circuit Resistance:

For use with "Flyback Transformer" high-voltage supply. . . . . 8 *max* megohms

■ For interval of 20 seconds maximum duration during equipment warm-up period.

**BEAM POWER TUBE**

Miniature type used in audio output stages of television and radio receivers. Outline 14, OUTLINES SECTION. Tube requires miniature nine-contact socket and may be mounted in any position. Heater volts (ac/dc), 6.3; amperes, 1.2. Typical operation as class A<sub>1</sub> amplifier: plate and grid-No.2 volts, 250 *max*; grid-No.1 volts, -5; peak af grid-No.1 volts, 5; plate dissipation, 9 *max* watts; grid-No.2 input, 2.5

**6BK5**

*max* watts; plate ma., 35 (zero-signal), 37 (maximum-signal); grid-No.2 ma., 3.5 (zero-signal), 10 (maximum-signal); plate resistance (approx.), 0.1 megohm; transconductance, 8500  $\mu$ hos; load resistance, 6500 ohms; total harmonic distortion, 7 per cent; power output, 3.5 watts; peak heater-cathode volts, 100 *max*. This type is used principally for renewal purposes.

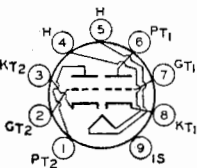

**MEDIUM-MU TWIN TRIODE**

Miniature types used in direct-coupled cathode-drive rf amplifier circuits of vhf television tuners. In such circuits, one triode unit is used as the direct-coupled grounded-cathode driver for the other unit. These types are also used in push-pull cathode-drive rf amplifiers.

**6BK7-A**  
**6BK7-B**

Type 6BK7-B has a controlled heater warm-up time for use in receivers employing series-connected heater strings. Outline 12, OUTLINES SECTION. Tubes require miniature nine-contact socket and may be mounted in any position. For typical operation as a resistance-coupled amplifier, refer to Chart 12, RESISTANCE-COUPLED AMPLIFIER SECTION. Type 6BK7-A is a DISCONTINUED type listed for reference only.

HEATER VOLTAGE (AC/DC) .....	6.3	volts	
HEATER CURRENT .....	0.45	ampere	
HEATER WARM-UP TIME (Average) for 6BK7-B .....	11	seconds	
<b>DIRECT INTERELECTRODE CAPACITANCES:</b>			
	<i>Unit No. 1</i>	<i>Unit No. 2</i>	
Grid to Plate .....	1.8	1.8	$\mu\text{f}$
Grid to Cathode, Heater, and Internal Shield .....	3	3	$\mu\text{f}$
Plate to Cathode, Heater, and Internal Shield .....	1	0.9	$\mu\text{f}$
Cathode to Grid, Heater, and Internal Shield .....	6	6	$\mu\text{f}$
Plate to Grid, Heater, and Internal Shield .....	2.4	2.4	$\mu\text{f}$
Plate to Cathode .....	0.22	0.22	$\mu\text{f}$
Heater to Cathode .....	2.8	3	$\mu\text{f}$
Grid of Unit No.1 to Grid of Unit No.2 .....		0.004 <i>max</i>	$\mu\text{f}$
Plate of Unit No.1 to Plate of Unit No.2 .....		0.075 <i>max</i>	$\mu\text{f}$

**CLASS A<sub>1</sub> AMPLIFIER (Each Unit)**

<b>Maximum Ratings:</b>		
PLATE VOLTAGE .....	300 <i>max</i>	volts
GRID VOLTAGE, Negative-bias value .....	-50 <i>max</i>	volts
PLATE DISSIPATION .....	2.7 <i>max</i>	watts
<b>PEAK HEATER-CATHODE VOLTAGE:</b>		
Heater negative with respect to cathode .....	200 <sup>2</sup> <i>max</i>	volts
Heater positive with respect to cathode .....	200 <sup>1</sup> <i>max</i>	volts

**Characteristics:**

Plate Supply Voltage .....	150	volts
Cathode-Bias Resistor .....	56	ohms
Amplification Factor .....	43	
Plate Resistance (Approx.) .....	4600	ohms
Transconductance .....	9300	$\mu\text{mhms}$
Plate Current .....	18	ma
Grid Voltage (Approx.) for plate current of 10 $\mu\text{a}$ .....	-11	volts

\* In cathode-drive circuits with direct-coupled drive, it is permissible for this voltage to be as high as 300 volts under cutoff conditions.

<sup>1</sup>The dc component must not exceed 100 volts.

**HALF-WAVE VACUUM RECTIFIER**

Glass octal type used as a damper tube in horizontal deflection circuits of color television receivers. Outline 41, OUTLINES SECTION. Tube requires octal socket and may be mounted in any position. Heater volts (ac/dc), 6.3; amperes, 3. Maximum ratings for damper service: peak inverse plate volts (absolute maximum) 4500 *max*; peak plate ma., 1200 *max*; dc plate ma., 200 *max*; plate dissipation, 8 *max* watts;

peak heater-cathode volts, 4500 absolute *max* when heater is negative with respect to cathode (dc component must not exceed 900 volts); 300 *max* when heater is positive with respect to cathode (dc component must not exceed 100 volts). This is a DISCONTINUED type listed for reference only.

**6BL4**

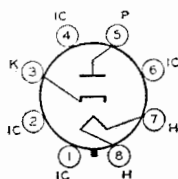

**MEDIUM-MU TWIN TRIODE**

Glass octal types used as combined vertical deflection amplifier and vertical deflection oscillator in television receivers. When so operated, it is recommended that unit No.1 (pins 4,

5, and 6) be used as the oscillator. Outline 22, OUTLINES SECTION. Tubes require octal socket and may be mounted in any position. Type 6BL7-GT is a DISCONTINUED type listed for reference only.

**6BL7-GT**

**6BL7-GTA**

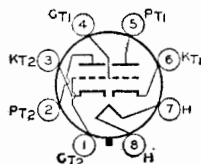

HEATER VOLTAGE (AC/DC) .....	6.3	volts	
HEATER CURRENT .....	1.5	amperes	
<b>DIRECT INTERELECTRODE CAPACITANCES (Approx.):</b>			
	<i>Unit No. 1</i>	<i>Unit No. 2</i>	
Grid to Plate .....	6	6	$\mu\text{f}$
Grid to Cathode and Heater .....	4.2	4.6	$\mu\text{f}$
Plate to Cathode and Heater .....	0.9	0.9	$\mu\text{f}$
AMPLIFICATION FACTOR* .....		15	
PLATE RESISTANCE (Approx.)* .....		2150	ohms
TRANSCONDUCTANCE* .....		7000	$\mu\text{mhms}$

\* Each unit; for plate volts, 250; grid volts, -9; plate ma., 40.

**VERTICAL DEFLECTION OSCILLATOR OR AMPLIFIER\***

*For operation in a 525-line, 30-frame system*

<b>Maximum Ratings:</b>	<i>Oscillator</i>	<i>Amplifier</i>	
DC PLATE VOLTAGE .....	500 max	500 max	volts
PEAK POSITIVE-PULSE PLATE VOLTAGE† ( <i>Absolute Maximum</i> ) ..	—	2000 max	volts
PEAK NEGATIVE-PULSE GRID VOLTAGE .....	-400 max	-250 max	volts
PEAK CATHODE CURRENT .....	210 max	210 max	ma
AVERAGE CATHODE CURRENT .....	60 max	60 max	ma
<b>PLATE DISSIPATION:</b>			
For either plate .....	10 max	10 max	watts
For both plates with both units operating .....	12 max	12 max	watts
<b>PEAK HEATER-CATHODE VOLTAGE:</b>			
Heater negative with respect to cathode .....	200 max	200 max	volts
Heater positive with respect to cathode .....	200 max	200 max	volts

**Maximum Circuit Values:**

Grid-Circuit Resistance .....	4.7 max	4.7 max	megohms
-------------------------------	---------	---------	---------

\* Unless otherwise specified, values are for each unit.

† The duration of the voltage pulse must not exceed 15 per cent of one vertical scanning cycle. In a 525-line, 30-frame system, 15 per cent of one vertical scanning cycle is 2.5 milliseconds.

‡ Under no circumstances should this absolute value be exceeded.

§ The dc component must not exceed 100 volts.

¶ For cathode-bias operation.

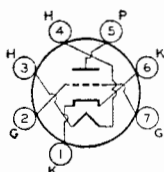

**MEDIUM-MU TRIODE**

Miniature types used as rf amplifier tubes in grid-drive circuits of vhf television tuners. The double base-pin connections for both cathode and grid reduce effective lead inductance and

**6BN4**  
**6BN4-A**

lead resistance with consequent reduction in input conductance. In addition, the basing arrangement facilitates isolation of input and output circuits and permits short, direct connections to base-pin terminals. Outline 11, OUTLINES SECTION. Tubes require miniature seven-contact socket and may be mounted in any position.

HEATER VOLTAGE (AC/DC) .....	6.3	volts
HEATER CURRENT .....	0.2	ampere
<b>DIRECT INTERELECTRODE CAPACITANCES (Approx.):*</b>		
Grid to Plate .....	1.2	μf
Grid to Cathode and Heater .....	3.2	μf
Plate to Cathode and Heater .....	1.4	μf
Heater to Cathode (Type 6BN4 only) .....	2.8*	μf

\* With external shield connected to cathode except as noted.

• With external shield connected to ground.

**CLASS A<sub>1</sub> AMPLIFIER**

<b>Maximum Ratings:</b>	<i>6BN4 Design-Maximum Values</i>	<i>6BN4-A Design-Center Values</i>	
PLATE VOLTAGE .....	275 max	275 max	volts
GRID VOLTAGE, Positive bias value .....	0 max	0 max	volts
PLATE DISSIPATION .....	2.2 max	2.2 max	watts
CATHODE CURRENT .....	22 max	22 max	ma
<b>PEAK HEATER-CATHODE VOLTAGE:</b>			
Heater negative with respect to cathode .....	100 max	100 max	volts
Heater positive with respect to cathode .....	100 max	100 max	volts
<b>Characteristics:</b>	<i>6BN4</i>	<i>6BN4-A</i>	
Plate-Supply Voltage .....	150	150	volts
Cathode-Bias Resistor .....	220	220	ohms
Amplification Factor .....	43	43	
Plate Resistance (Approx.) .....	6300	5400	ohms
Transconductance .....	6800	8000	μmhos
Grid Voltage (Approx.) for plate current of 100 μa .....	-6	-6	volts
Plate Current .....	9	9	ma

**Maximum Circuit Value:**

Grid-Circuit Resistance .....	0.5 max	megohm
-------------------------------	---------	--------

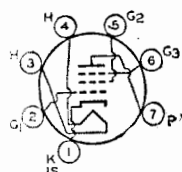

### BEAM TUBE

Miniature type used as combined limiter, discriminator, and audio-voltage amplifier in intercarrier television and FM receivers, Outline 13, OUTLINES SECTION. Tube requires

# 6BN6

miniature seven-contact socket and may be mounted in any position. Heater volts (ac/dc), 6.3; amperes, 0.3.

#### LIMITER AND DISCRIMINATOR SERVICE

Maximum Ratings, (Design-Maximum Values):

PLATE-SUPPLY VOLTAGE.....	330 <i>max</i>	volts
GRID-NO.2 VOLTAGE.....	110 <i>max</i>	volts
GRID-NO.1 VOLTAGE, Positive peak value.....	60 <i>max</i>	volts
CATHODE CURRENT.....	13 <i>max</i>	ma
PEAK HEATER-CATHODE VOLTAGE:		
Heater negative with respect to cathode.....	200 <i>max</i>	volts
Heater positive with respect to cathode.....	200 <i>max</i>	volts

The dc component must not exceed 100 volts.

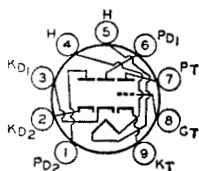

### TWIN DIODE—HIGH-MU TRIODE

Miniature type used in a wide variety of applications in color and black-and-white television receivers. This type has a controlled heater

# 6BN8

warm-up time for use in receivers employing series-connected heater strings. The triode unit is used in burst-amplifier, af amplifier, and low-frequency oscillator applications. The diode units are used in phase-detector, ratio-detector or discriminator, and horizontal AFC discriminator circuits. Outline 14, OUTLINES SECTION. Tube requires miniature nine-contact socket and may be mounted in any position.

HEATER VOLTAGE (AC/DC).....	6.3	volts
HEATER CURRENT.....	0.3	ampere
HEATER WARM-UP TIME (Average).....	11	seconds
DIRECT INTERELECTRODE CAPACITANCES:		
Triode Grid to Triode Plate.....	2.5	$\mu$ f
Triode Grid to Cathode and Heater.....	3.6	$\mu$ f
Triode Plate to Cathode and Heater.....	0.25	$\mu$ f
Plate of Diode Unit No.1 to Triode Grid.....	0.06 <i>max</i>	$\mu$ f
Plate of Diode Unit No.2 to Triode Grid.....	0.1 <i>max</i>	$\mu$ f
Plate of Diode Unit No.1 to Plate of Diode Unit No.2.....	0.07 <i>max</i>	$\mu$ f
Diode Cathode to All Other Electrodes (Each Diode Unit).....	5	$\mu$ f
Diode Plate to Diode Cathode and Heater (Each Diode Unit).....	1.9	$\mu$ f
Diode Cathode to Diode Plate and Heater (Each Diode Unit).....	1.8	$\mu$ f
Diode Plate to All Other Electrodes (Each Diode Unit).....	3	$\mu$ f

#### TRIODE UNIT AS CLASS A<sub>1</sub> AMPLIFIER

Maximum Ratings, (Design-Maximum Values):

PLATE VOLTAGE.....	330 <i>max</i>	volts
GRID VOLTAGE, Positive bias value.....	0 <i>max</i>	volts
PLATE DISSIPATION.....	1.7 <i>max</i>	watts
PEAK HEATER-CATHODE VOLTAGE:		
Heater negative with respect to cathode.....	200 <i>max</i>	volts
Heater positive with respect to cathode.....	200 <i>max</i>	volts

#### Characteristics:

Plate Voltage.....	100	250	volts
Grid Voltage.....	-1	-3	volts
Amplification Factor.....	75	70	
Plate Resistance (Approx.).....	21000	28000	ohms
Transconductance.....	3500	2500	amhos
Grid Voltage (Approx.) for plate current of 10 $\mu$ a.....	-2.5	5.5	volts
Plate Current.....	1.5	1.6	ma

#### Maximum Circuit Value:

Grid-Circuit Resistance.....	1.0 <i>max</i>	megohm
------------------------------	----------------	--------



## DIODE UNITS

Maximum Ratings, (Design-Maximum Values):

PLATE CURRENT (Each Unit):		
Peak .....	54 <i>max</i>	ma
DC .....	9 <i>max</i>	ma
PEAK HEATER-CATHODE VOLTAGE:		
Heater negative with respect to cathode .....	200 <i>max</i>	volts
Heater positive with respect to cathode .....	200 <i>max</i>	volts

\* The dc component must not exceed 100 volts.

### AVERAGE CHARACTERISTICS TRIODE UNIT

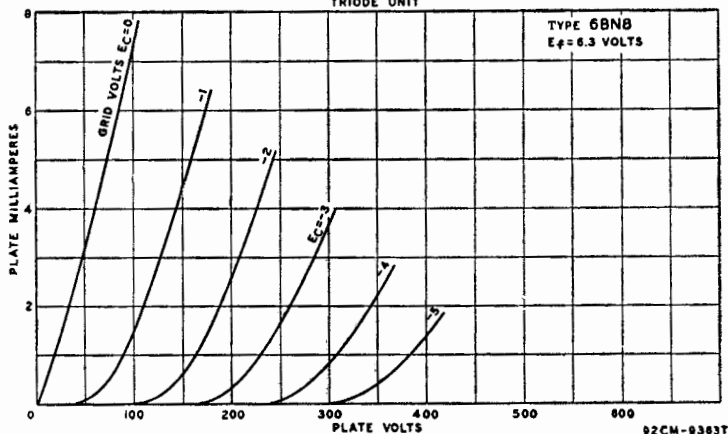

92CM-9383T

## POWER PENTODE

Miniature type used in the output stage of audio-frequency amplifiers. Outline 18, OUTLINES SECTION. Tube requires miniature nine-contact socket and may be mounted in any position.

# 6BQ5

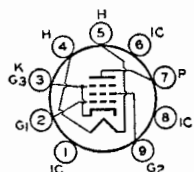

HEATER VOLTAGE (AC/DC) .....	6.3	volts
HEATER CURRENT .....	0.76	ampere
DIRECT INTERELECTRODE CAPACITANCES:		
Grid No.1 to Plate .....	0.5 <i>max</i>	$\mu\text{f}$
Grid No.1 to Cathode, Heater, Grid No.2, and Grid No.3 .....	10.8	$\mu\text{f}$
Plate to Cathode, Heater, Grid No.2, and Grid No.3 .....	6.5	$\mu\text{f}$
Grid No.1 to Heater .....	0.25 <i>max</i>	$\mu\text{f}$

### CLASS A<sub>1</sub> AMPLIFIER

Maximum Ratings:

PLATE VOLTAGE .....	300 <i>max</i>	volts
GRID-NO.2 (SCREEN-GRID) VOLTAGE .....	300 <i>max</i>	volts
GRID-NO.1 (CONTROL-GRID) VOLTAGE, Positive-bias value .....	0 <i>max</i>	volts
GRID-NO.2 INPUT .....	2 <i>max</i>	watts
PLATE DISSIPATION .....	12 <i>max</i>	watts
CATHODE CURRENT .....	65 <i>max</i>	ma
PEAK HEATER-CATHODE VOLTAGE:		
Heater negative with respect to cathode .....	100 <i>max</i>	volts
Heater positive with respect to cathode .....	100 <i>max</i>	volts

\* The dc component must not exceed 100 volts.

Typical Operation:

Plate Voltage .....	250	volts
Grid-No.2 Voltage .....	250	volts
Grid-No.1 (Control-Grid) Voltage .....	-7.3	volts
Peak AF Grid-No.1 Voltage .....	6.2	volts
Zero-Signal Plate Current .....	48	ma
Maximum-Signal Plate Current .....	50.6	ma
Zero-Signal Grid-No.2 Current .....	5.5	ma
Maximum-Signal Grid-No.2 Current .....	10	ma
Plate Resistance (Approx.) .....	38000	ohms

Transconductance	11300	μmhos
Load Resistance	4500	ohms
Total Harmonic Distortion	10	per cent
Maximum-Signal Power Output	5.7	watts

### Maximum Circuit Values:

Grid-No.1-Circuit Resistance:		
For fixed-bias operation	0.3 max	megohm
For cathode-bias operation	1.0 max	megohm

### PUSH-PULL CLASS AB<sub>1</sub> AMPLIFIER

Maximum Ratings: (Same as for single-tube class A<sub>1</sub> amplifier)

Typical Operation, (Values are for two tubes):

Plate Supply Voltage	250	300	volts
Grid-No.2 Supply Voltage	250	300	volts
Cathode-Bias Resistor	130	130	ohms
Peak AF Grid-No.1-to-Grid-No.1 Voltage	22.6	28.3	volts
Zero-Signal Plate Current	62	72	ma
Maximum-Signal Plate Current	75	92	ma
Zero-Signal Grid-No.2 Current	7	8	ma
Maximum-Signal Grid-No.2 Current	15	22	ma
Effective Load Resistance (Plate-to-plate)	8000	8000	ohms
Total Harmonic Distortion	3	4	per cent
Maximum-Signal Power Output	11	17	watts

### Maximum Circuit Values:

Grid-No.1-Circuit Resistance:		
For fixed-bias operation	0.3 max	megohm
For cathode-bias operation	1.0 max	megohm

### BEAM POWER TUBE

Glass octal types used as horizontal deflection amplifiers in television receivers. Outline 30, OUT-LINES SECTION. Tubes require octal socket and may be mounted in any position. These types may be supplied with pin No.1 omitted. Type 6BQ6-GT is a DISCONTINUED type listed for reference only.

6BQ6-GT  
6BQ6-GTB  
/6CU6

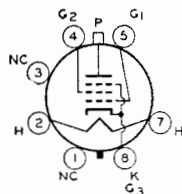

HEATER VOLTAGE (AC/DC)	6.3	volts
HEATER CURRENT	1.2	amperes
DIRECT INTERELECTRODE CAPACITANCES (Approx., 6BQ6-GTB/6CU6):		
Grid No.1 to Plate	0.6	μf
Grid No.1 to Cathode, Heater, Grid No.2, and Grid No.3	15	μf
Plate to Cathode, Heater, Grid No.2, and Grid No.3	7	μf
TRANSCONDUCTANCE* (6BQ6-GTB/6CU6)	5900	μmhos
MU-FACTOR, Grid No.2 to Grid No.1**	4.3	

\* For plate volts, 250; grid-No.2 volts, 150; grid-No.1 volts, -22.5; plate ma., 57; grid-No.2 ma., 2.1.

\*\* For plate and grid-No.2 volts, 150; grid-No.1 volts, -22.5.

### HORIZONTAL DEFLECTION AMPLIFIER

For operation in a 525-line, 30-frame system

Maximum Ratings:	6BQ6-GT	6BQ6-GTB/6CU6	
DC PLATE VOLTAGE	550 max	600 max	volts
PEAK POSITIVE-PULSE PLATE VOLTAGE* (Absolute Maximum)	5500†max	6000†max	volts
PEAK NEGATIVE-PULSE PLATE VOLTAGE	-1250 max	-1250 max	volts
DC GRID-NO.2 (SCREEN-GRID) VOLTAGE	175 max	200 max	volts
PEAK NEGATIVE-PULSE GRID-NO.1 (CONTROL-GRID) VOLTAGE	-300 max	-300 max	volts
PEAK CATHODE CURRENT	400 max	400 max	ma
AVERAGE CATHODE CURRENT	110 max	110 max	ma
GRID-NO.2 INPUT	2.5 max	2.5 max	watts
PLATE DISSIPATION‡	11 max	11 max	watts
PEAK HEATER-CATHODE VOLTAGE:			
Heater negative with respect to cathode	200 max	200 max	volts
Heater positive with respect to cathode	200‡max	200‡max	volts
BULB TEMPERATURE (At hottest point)	220 max	220 max	°C

### Maximum Circuit Value:

Grid-No.1-Circuit Resistance	0.47 max	megohm
------------------------------	----------	--------

• The duration of the voltage pulse must not exceed 15 per cent of one horizontal scanning cycle. In a 525-line, 30-frame system, 15 per cent of one horizontal scanning cycle is 10 microseconds.

† Under no circumstances should this absolute value be exceeded.

‡ An adequate bias resistor or other means is required to protect the tube in the absence of excitation.

■ The dc component must not exceed 100 volts.

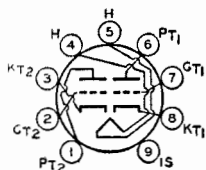

**MEDIUM-MU TWIN TRIODE**

**6BQ7**  
**6BQ7-A**

Miniature types used in direct-coupled cathode-drive rf amplifier circuits of vhf television tuners. In such circuits, one triode unit is used as the direct-coupled grounded-cathode driver for the other unit. These types are also used in push-pull cathode-drive rf amplifiers. Outline 12, OUTLINES SECTION. Tubes require miniature nine-contact socket and may be mounted in any position. For typical operation as a resistance-coupled amplifier, refer to RESISTANCE-COUPLED AMPLIFIER SECTION. Type 6BQ7 is a DISCONTINUED type listed for reference only.

HEATER VOLTAGE (AC/DC)	6.3	volts	
HEATER CURRENT	0.4	ampere	
DIRECT INTERELECTRODE CAPACITANCES (6BQ7-A): <sup>o</sup>	Unit No.1	Unit No.2	
Grid to Plate	1.2	1.2	µf
Grid to Cathode, Heater, and Internal Shield	2.6	-	µf
Cathode to Grid, Heater, and Internal Shield	-	5.0	µf
Plate to Cathode, Heater, and Internal Shield	1.2	-	µf
Plate to Grid, Heater, and Internal Shield	-	2.2	µf
Plate to Cathode	0.12	0.12	µf
Heater to Cathode (6BQ7-A)	2.6	2.6	µf
Plate of Unit No.1 to Plate of Unit No.2	-	0.010 max	µf
Plate of Unit No.2 to Plate and Grid of Unit No.1	-	0.024 max	µf

**CLASS A<sub>1</sub> AMPLIFIER (Each Unit)**

<b>Maximum Ratings:</b>		
PLATE SUPPLY VOLTAGE	250*max	volts
PLATE DISSIPATION	2 max	watts
CATHODE CURRENT	20 max	ma
<b>PEAK HEATER-CATHODE VOLTAGE:</b>		
Heater negative with respect to cathode	200*max	volts
Heater positive with respect to cathode	200*max	volts

<b>Characteristics:</b>	6BQ7	6BQ7-A	
Plate Supply Voltage	150	150	volts
Cathode-Bias Resistor	220	220	ohms
Amplification Factor	35	38	
Plate Resistance (Approx.)	5800	5900	ohms
Transconductance	6000	6400	µmhos
Plate Current	9	9	ma
<b>Grid Voltage (Approx.):</b>			
For plate current of 100 µa	-	-6.5	volts
For plate current of 10 µa	-10	-	volts

**Maximum Circuit Value:**

Grid-Circuit Resistance	0.5 max	megohm
-------------------------	---------	--------

<sup>o</sup> With external shield connected to internal shield.

\* In cathode-drive circuits with direct-coupled drive, it is permissible for this voltage to be as high as 300 volts.

• The dc component must not exceed 100 volts.

**AVERAGE PLATE CHARACTERISTICS FOR EACH UNIT**

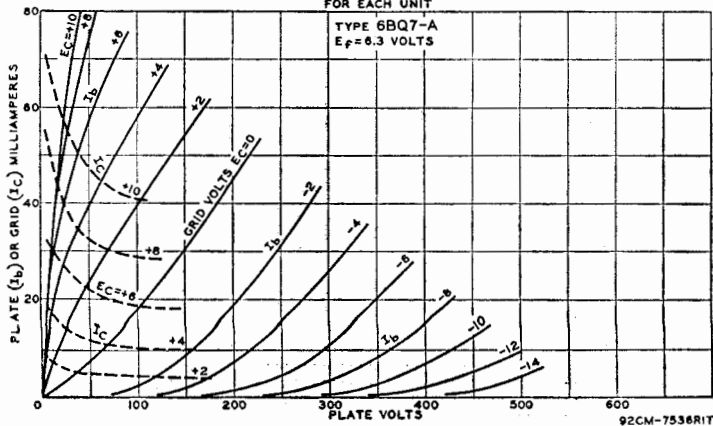

## 6BR8

## 6BR8-A

### MEDIUM-MU TRIODE— SHARP-CUTOFF PENTODE

Miniature types used in a wide variety of applications in color and black-and-white television receivers. Especially useful as combined triode oscillator and pentode mixer in vhf

television tuners. Type 6BR8-A has a controlled heater warm-up time for use in receivers employing series-connected heater strings. Outline 12, OUTLINES SECTION. Except for basing arrangement and grid-No.1-to-plate capacitance of pentode unit, these types are identical with miniature types 6U8 and 6U8-A, respectively.

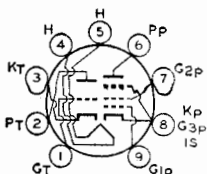

### MEDIUM-MU TWIN TRIODE

Miniature type used in direct-coupled cathode-drive rf amplifier circuits of vhf television tuners. In such circuits, one triode unit is used as the direct-coupled grounded-cathode driv-

er for the other unit. This type is also used in push-pull cathode-drive rf amplifiers. Outline 12, OUTLINES SECTION. Tube requires miniature nine-contact socket and may be mounted in any position.

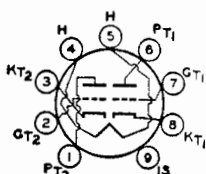

HEATER VOLTAGE (AC/DC).....	6.3	volts
HEATER CURRENT.....	0.4	ampere

<b>Maximum Ratings:</b>		
<b>CLASS A<sub>1</sub> AMPLIFIER (Each Unit)</b>		
PLATE VOLTAGE.....	150 max	volts
PLATE DISSIPATION.....	2 max	watts
CATHODE CURRENT.....	20 max	ma
<b>PEAK HEATER-CATHODE VOLTAGE:</b>		
Heater negative with respect to cathode.....	200 max	volts
Heater positive with respect to cathode.....	200 max	volts

<b>Characteristics:</b>		
Plate-Supply Voltage.....	150	volts
Cathode-Bias Resistor.....	220	ohms
Amplification Factor.....	36	
Plate Resistance (Approx.).....	5000	ohms
Transconductance.....	7200	μmhos
Plate Current.....	10	ma
Grid Voltage (Approx.) for plate current of 10 μA.....	-7	volts

<b>Maximum Circuit Values:</b>		
Grid-Circuit Resistance.....	0.5 max	megohm

\* This value applies to unit No.2 only.

## 6BU8

### SHARP-CUTOFF TWIN PENTODE

Miniature type used as combined sync separator, sync clipper, and agc amplifier tube in television receivers. Outline 14, OUTLINES SECTION. Tube requires miniature nine-contact socket and may be mounted in any position.

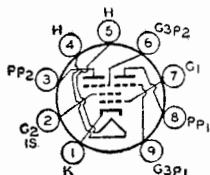

HEATER VOLTAGE (AC/DC).....	6.3	volts
HEATER CURRENT.....	0.3	ampere

<b>DIRECT INTERELECTRODE CAPACITANCES:</b>		
Grid No.3 to Plate (Each Unit).....	1.9	μμf
Grid No.1 to All Other Electrodes.....	6	μμf
Grid No.3 to All Other Electrodes (Each Unit).....	3.6	μμf
Plate to All Other Electrodes (Each Unit).....	3	μμf
Grid No.3 of Unit No.1 to Grid No.3 of Unit No.2.....	0.015 max	μμf

## CLASS A<sub>1</sub> AMPLIFIER

### Maximum Ratings, (Design-Maximum Values):

PLATE VOLTAGE (Each Unit) .....	300 max	volts
GRID-NO.3 (SUPPRESSOR-GRID) VOLTAGE (Each Unit):		
Peak positive value .....	50 max	volts
DC negative value .....	-50 max	volts
DC positive value .....	3 max	volts
GRID-NO.2 (SCREEN-GRID) VOLTAGE .....	150 max	volts
GRID-NO.1 (CONTROL-GRID) VOLTAGE, Negative bias value .....	-50 max	volts
CATHODE CURRENT .....	12 max	ma
GRID-NO.2 INPUT .....	0.75 max	watt
PLATE DISSIPATION (Each Unit) .....	1.1 max	watts
PEAK HEATER-CATHODE VOLTAGE:		
Heater negative with respect to cathode .....	200 max	volts
Heater positive with respect to cathode .....	200 <sup>max</sup>	volts

### Characteristics:

#### With Both Units Operating

Plate Voltage (Each Unit) .....	100	100	volts
Grid-No.3 Voltage (Each Unit) .....	-10	0	volts
Grid-No.2 Voltage .....	67.5	67.5	volts
Grid-No.1 Voltage .....	*	*	volts
Plate Current (Each Unit) .....	-	2.2	ma
Grid-No.2 Current .....	6.5	3.3	ma
Cathode Current .....	6.6	7.8	ma

#### With One Unit Operating†

Plate Voltage .....	100	100	volts
Grid-No.3 Voltage .....	0	0	volts
Grid-No.2 Voltage .....	67.5	67.5	volts
Grid-No.1 Voltage .....	0	*	volts
Grid-No.3 Transconductance .....	-	180	μmhos
Grid-No.1 Transconductance .....	1500	-	μmhos
Plate Current .....	-	2.2	ma
Grid-No.3 Voltage (Approx.) for plate current of 100 μa .....	-	-4.5	volts
Grid-No.1 Voltage (Approx.) for plate current of 100 μa .....	-	-2.3	volts

### Maximum Circuit Values:

Grid-No.3-Circuit Resistance (Each Unit) .....	0.5 max	megohm
Grid-No.1-Circuit Resistance .....	0.5 max	megohm

\* The dc component must not exceed 100 volts.

\* Adjusted to give a dc grid-No.1 current of 100 microamperes.

† With plate and grid No.3 of the other unit connected to ground.

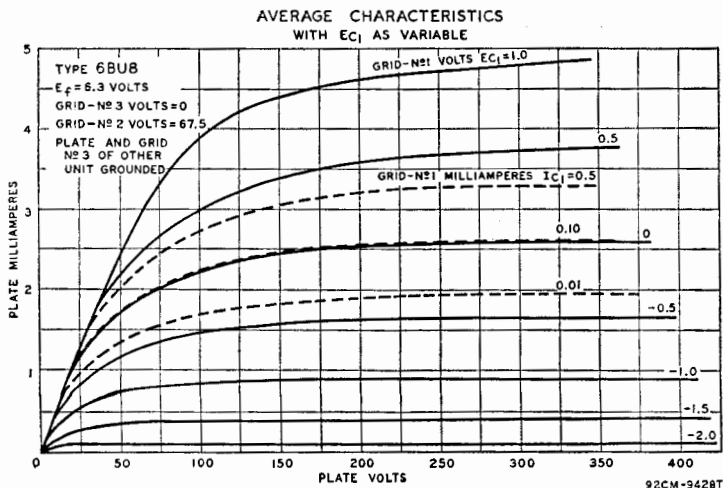

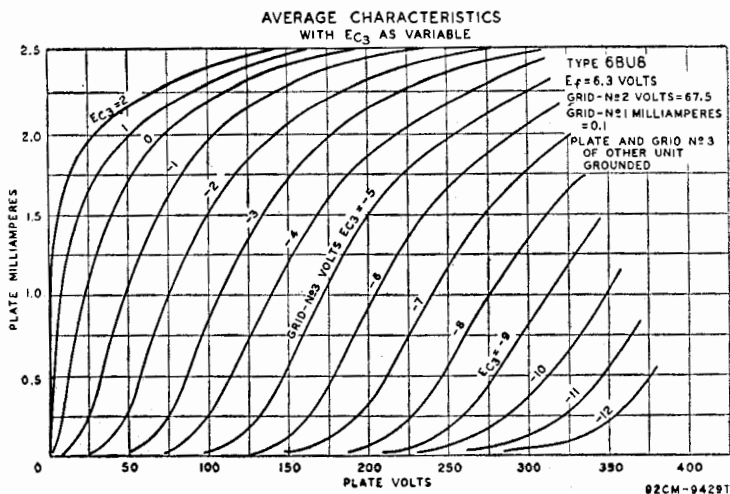

## 6BV8

### TWIN DIODE— MEDIUM-MU TRIODE

Miniature type used as combined synchronous detector and chrominance amplifier in color television receivers; also used as combined FM detector and af voltage amplifier. Tube has controlled warm-up time for use in series-connected heater strings. Outline 12, OUT-LINES SECTION. Tube requires miniature nine-contact socket and may be operated in any position.

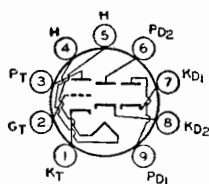

HEATER VOLTAGE (AC/DC) .....	6.3	volts
HEATER CURRENT .....	0.6	ampere
HEATER WARM-UP TIME (Average) .....	11	seconds

#### TRIODE UNIT AS CLASS A<sub>1</sub> AMPLIFIER

##### Maximum Ratings, (Design-Maximum Values):

PLATE VOLTAGE .....	330 max	volts
GRID VOLTAGE, Positive Bias Value .....	0 max	volts
PLATE DISSIPATION .....	2.7 max	watts
<b>PEAK HEATER-CATHODE VOLTAGE:</b>		
Heater negative with respect to cathode .....	200 max	volts
Heater positive with respect to cathode .....	200 <sup>o</sup> max	volts

##### Characteristics:

Plate Voltage .....	75	200	volts
Grid Voltage .....	0	-	volts
Cathode Resistor .....	-	330	ohms
Amplification Factor .....	-	33	
Plate Resistance (Approx.) .....	-	5900	ohms
Transconductance .....	-	5600	μmhos
Plate Current .....	14	11	ma
Grid Voltage (Approx.) for plate $\mu_a = 100$ .....	-	- 11	volts

##### Maximum Circuit Values:

<b>Grid-Circuit Resistance:</b>		
For fixed-bias operation .....	0.1 max	megohm
For cathode-bias operation .....	0.5 max	megohm

#### DIODE UNITS—TWO

*Values are for each unit*

<b>Maximum Ratings, (Design-Maximum Values):</b>		
PLATE CURRENT .....	10 max	ma
<b>PEAK HEATER-CATHODE VOLTAGE:</b>		
Heater negative with respect to cathode .....	200 max	volts
Heater positive with respect to cathode .....	200 <sup>o</sup> max	volts

**Characteristics, Instantaneous Test Condition:**

Plate Current, for plate volts = 5.....	23	ma
° The dc component must not exceed 100 volts.		

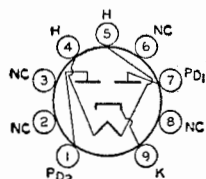

**FULL-WAVE VACUUM RECTIFIER**

Miniature type used in full-wave power supplies having high dc output current requirements. Outline 14, OUTLINES SECTION. Type 6BW4 requires miniature nine-contact socket

**6BW4**

and may be mounted in any position. It is especially important that this tube, like other power-handling tubes, be adequately ventilated.

HEATER VOLTAGE (AC/DC).....	6.3	volts
HEATER CURRENT.....	0.9	ampere

**FULL-WAVE RECTIFIER**

<b>Maximum Ratings:</b>			
PEAK INVERSE PLATE VOLTAGE.....	1275 max	volts	
AC PLATE SUPPLY VOLTAGE (Per Plate, rms).....	450 max	volts	
STEADY-STATE PEAK PLATE CURRENT (Per Plate).....	350 max	ma	
DC OUTPUT CURRENT.....	62.5 max	ma	
TRANSIENT PEAK PLATE CURRENT (Per Plate).....	2 max	amperes	
DC HEATER-CATHODE VOLTAGE: Heater negative with respect to cathode.....	450 max	volts	

<b>Typical Operation:</b>	<i>Filter Input</i>	<i>Capacitor</i>	<i>Choke</i>	
AC Plate-To-Plate Supply Voltage (rms)*.....	650	900	volts	
Filter Input Capacitor.....	40	-	µf	
Total Effective Plate Supply Resistance per Plate.....	82	-	ohms	
Filter Input Choke.....	-	10	henries	
DC Output Current.....	100	100	ma	
DC Output Voltage at Input to Filter (Approx.).....	330	360	volts	

\* AC plate supply voltage is measured without load.

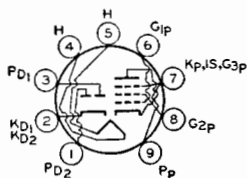

**TWIN DIODE—  
SHARP-CUTOFF PENTODE**

Miniature type used in television receivers; diodes are used as horizontal phase detectors; pentode is used as a sound if amplifier, sound limiter, and agc keyer. Outline 12, OUTLINES SECTION. Heater volts (ac/dc), 6.3; amperes, 0.45. Tube requires nine-contact socket and may be operated in any position.

**6BW8**

Heater volts (ac/dc), 6.3; amperes, 0.45. Tube requires nine-contact socket and may be operated in any position.

**PENTODE UNIT AS CLASS A<sub>1</sub> AMPLIFIER**

**Maximum Ratings, (Design-Maximum Values):**

PLATE VOLTAGE.....	330 max	volts
GRID-NO.2 (SCREEN-GRID) SUPPLY VOLTAGE.....	330 max	volts
GRID-NO.2 VOLTAGE.....	See curve page 66	
GRID-NO.1 (CONTROL-GRID) VOLTAGE:		
Positive-bias value.....	0 max	volts
Negative-bias value.....	55 max	volts
GRID-NO.2 INPUT:		
For grid-No.2 voltages up to 165 volts.....	0.55 max	watt
For grid-No.2 voltages between 165 and 330 volts.....	See curve page 66	
PLATE DISSIPATION.....	3 max	watts
PEAK HEATER-CATHODE VOLTAGE:		
Heater negative with respect to cathode.....	200 max	volts
Heater positive with respect to cathode.....	200 <sup>o</sup> max	volts

**Characteristics:**

Plate Voltage.....	250	volts
Grid-No.2 Voltage.....	110	volts
Cathode-Bias Resistor.....	68	ohms
Plate Resistance (Approx.).....	0.25	megohm
Transconductance.....	5200	µmhos
Grid-No.1 Voltage (Approx.) for plate µa = 10.....	-10	volts
Plate Current.....	10	ma
Grid-No.2 Current.....	3.5	ma

**Maximum Circuit Values:**

Grid-No.1 Circuit Resistance:		
For fixed-bias operation.....	0.1 <i>max</i>	megohm
For cathode-bias operation.....	0.5 <i>max</i>	megohm

**DIODE UNITS (Each Unit)**

**Maximum Ratings, (Design-Maximum Values):**

PLATE CURRENT.....	5 <i>max</i>	ma
PEAK HEATER-CATHODE VOLTAGE:		
Heater negative with respect to cathode.....	200 <i>max</i>	volts
Heater positive with respect to cathode.....	200 <sup>o</sup> <i>max</i>	volts

<sup>o</sup> The dc component must not exceed 100 volts.

## 6BX7-GT

### MEDIUM-MU TWIN TRIODE

Glass octal type used as combined vertical deflection amplifier and vertical deflection oscillator in television receivers. When so operated, it is recommended that unit No.1 (pins 4, 5, and 6) be used as the oscillator. Outline 22, OUTLINES SECTION. Tube requires octal socket and may be mounted in any position.

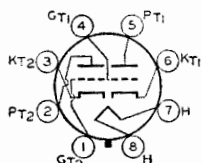

HEATER VOLTAGE (AC/DC).....	6.3	volts
HEATER CURRENT.....	1.5	amperes
AMPLIFICATION FACTOR*.....	10	
PLATE RESISTANCE (Approx.)*.....	1300	ohms
TRANSCONDUCTANCE*.....	7600	μmhos

\* For plate volts, 250; cathode-bias resistor, 390 ohms; plate ma., 42.

### VERTICAL DEFLECTION OSCILLATOR OR AMPLIFIER (Each Unit)

*For operation in a 525-line, 30-frame system*

Maximum Ratings:	Oscillator	Amplifier	
DC PLATE VOLTAGE.....	500 <i>max</i>	500 <i>max</i>	volts
PEAK POSITIVE-PULSE PLATE VOLTAGE (Absolute Maximum) <sup>‡</sup> .....	-	2000 <sup>‡</sup> <i>max</i>	volts
PEAK NEGATIVE-PULSE GRID VOLTAGE.....	-100 <i>max</i>	250 <i>max</i>	volts
PEAK CATHODE CURRENT.....	180 <i>max</i>	180 <i>max</i>	ma
AVERAGE CATHODE CURRENT.....	60 <i>max</i>	60 <i>max</i>	ma
PLATE DISSIPATION:			
For either plate.....	10 <i>max</i>	10 <i>max</i>	watts
For both plates with both units operating.....	12 <i>max</i>	12 <i>max</i>	watts
PEAK HEATER-CATHODE VOLTAGE:			
Heater negative with respect to cathode.....	200 <i>max</i>	200 <i>max</i>	volts
Heater positive with respect to cathode.....	200 <sup>o</sup> <i>max</i>	200 <sup>o</sup> <i>max</i>	volts

**Maximum Circuit Values:**

Grid-Circuit Resistance.....	2.2 <i>max</i>	2.2 <sup>‡</sup> <i>max</i>	megohms
------------------------------	----------------	-----------------------------	---------

The duration of the voltage pulse must not exceed 15 per cent of one vertical scanning cycle. In a 525-line, 30-frame system, 15 per cent of one vertical scanning cycle is 2.5 milliseconds.

<sup>‡</sup> Under no circumstances should this absolute value be exceeded.

<sup>o</sup> The dc component must not exceed 100 volts.

<sup>‡</sup> For cathode-bias operation.

### FULL-WAVE VACUUM RECTIFIER

Octal type having high permeance used as a damper tube in horizontal deflection circuits of television receivers or as a rectifier in conventional power-supply applications. Outline 31, OUTLINES SECTION. Tube requires octal socket and may be mounted in any position. It is especially important that this tube, like other power-handling tubes, be adequately ventilated. Heater volts (ac/dc), 6.3; amperes, 1.6. Maximum ratings for damper service (each unit): peak inverse plate volts (absolute maximum), 3000 *max*; peak plate ma., 525 *max*; dc plate ma., 175 *max*. Peak heater-cathode volts; heater negative with respect to cathode, 450 *max*; heater positive with respect to cathode, 100 *max*. This type is used principally for renewal purposes.

## 6BY5-GA

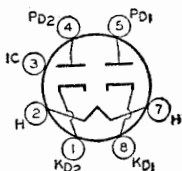



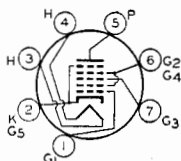

### PENTAGRID AMPLIFIER

## 6BY6

Miniature type used as a gated amplifier in color television receivers. In such service, it may be used as a combined sync separator and sync clipper. Outline 11, OUTLINES SEC-

TION. Tube requires miniature seven-contact socket and may be mounted in any position.

HEATER VOLTAGE (AC/DC) .....	6.3	volts
HEATER CURRENT .....	0.3	ampere
<b>DIRECT INTERELECTRODE CAPACITANCES:</b>		
Grid No.1 to Plate .....	0.08 max	$\mu\mu\text{f}$
Grid No.3 to Plate .....	0.35 max	$\mu\mu\text{f}$
Grid No.1 to Grid No.3 .....	0.22 max	$\mu\mu\text{f}$
Grid No.1 to All Other Electrodes .....	5.4	$\mu\mu\text{f}$
Grid No.3 to All Other Electrodes .....	6.9	$\mu\mu\text{f}$
Plate to All Other Electrodes .....	7.6	$\mu\mu\text{f}$

#### Characteristics:

#### CLASS A<sub>1</sub> AMPLIFIER

Plate Voltage .....	250	volts
Grids-No.2-and-No.4 Voltage .....	100	volts
Grid-No.3 Voltage .....	-2.5	volts
Grid-No.1 Voltage .....	-2.5	volts
Grid-No.3-to-Plate Transconductance .....	500	$\mu\text{mhos}$
Grid-No.1-to-Plate Transconductance .....	1900	$\mu\text{mhos}$
Plate Current .....	6.5	ma
Grids-No.2-and-No.4 Current .....	9	ma
Grid-No.3 Volts (Approx.) for plate current of 35 $\mu\text{a}$ and grid-No.1 volts = -4 .....	-15	volts
Grid-No.1 Volts (Approx.) for plate current of 35 $\mu\text{a}$ and grid-No.3 volts = 0 .....	-12	volts

#### GATED AMPLIFIER

#### Maximum Ratings, (Design-Maximum Values):

PLATE VOLTAGE .....	330 max	volts
GRIDS-NO.2-AND-NO.4 VOLTAGE .....	See curve page 66	
GRIDS-NO.2-AND-NO.4 SUPPLY VOLTAGE .....	330 max	volts
<b>GRID-NO.3 VOLTAGE:</b>		
Negative bias value .....	-55 max	volts
Positive bias value .....	0 max	volts
Positive peak value .....	27 max	volts
GRID-NO.1 VOLTAGE, Negative bias value .....	-110 max	volts
PLATE DISSIPATION .....	2.3 max	watts
GRID-NO.3 INPUT .....	0.1 max	watt
<b>GRIDS-NO.2-AND-NO.4 INPUT:</b>		
For grids-No.2-and-No.4 voltages up to 165 volts .....	1.1 max	watts
For grids-No.2-and-No.4 voltages between 165 and 330 volts .....	See curve page 66	
GRID-NO.1 INPUT .....	0.1 max	watt
<b>PEAK HEATER-CATHODE VOLTAGE:</b>		
Heater negative with respect to cathode .....	200 max	volts
Heater positive with respect to cathode .....	200 <sup>o</sup> max	volts

#### Characteristics as Sync Separator and Sync Clipper:

Plate Voltage .....	10	volts
Grid-No.3 Voltage .....	0	volts
Grids-No.2-and-No.4 Voltage .....	25	volts
Grid-No.1 Voltage .....	0	volts
Plate Current .....	1.4	ma
Grids-No.2-and-No.4 Current .....	3.5	ma
Grid-No.3 Volts (Approx.) for plate voltage of 25 volts, grids-No.2-and-No.4 voltage of 25 volts, grid-No.1 voltage of 0 volts, and plate current of 50 $\mu\text{a}$ .....	-2.5	volts
Grid-No.1 Volts (Approx.) for plate voltage of 25 volts, grids-No.2-and-No.4 voltage of 25 volts, grid-No.3 voltage of 0 volts, and plate current of 50 $\mu\text{a}$ .....	-2.3	volts

#### Maximum Circuit Values:

<b>Grid-No.1 or Grid-No.3-Circuit Resistance:</b>		
For fixed-bias operation .....	0.5 max	megohm
For cathode-bias operation .....	1.0 max	megohm

<sup>o</sup> The dc component must not exceed 100 volts.

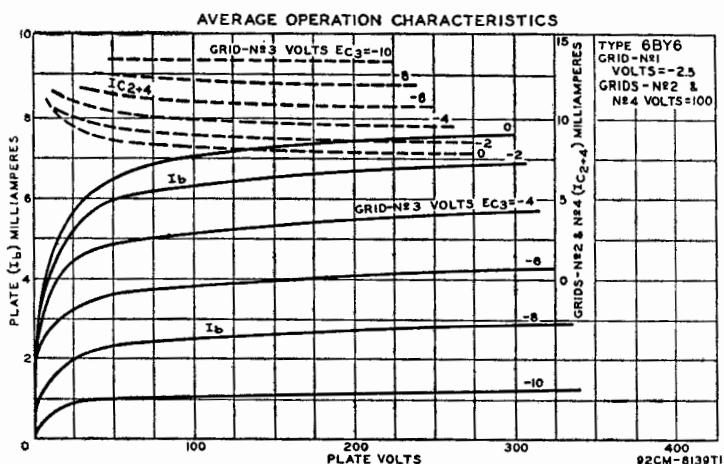

## 6BY8

### DIODE— SHARP-CUTOFF PENTODE

Miniature type used in diversified applications in television receivers. The pentode unit is used as an rf amplifier and the high-perveance diode as a limiter or detector. This type has a



controlled heater warm-up time for use in receivers employing series-connected heater strings. Outline 14, OUTLINES SECTION. Tube requires miniature nine-contact socket and may be mounted in any position.

HEATER VOLTAGE (AC/DC).....	6.3	volts
HEATER CURRENT.....	0.6	ampere
HEATER WARM-UP TIME (Average).....	11	seconds

#### Maximum Ratings: PENTODE UNIT AS CLASS A<sub>1</sub> AMPLIFIER

PLATE VOLTAGE.....	300 max	volts
GRID No.3 (SUPPRESSOR GRID).....	Connect to cathode at socket	
GRID-No.2 (SCREEN GRID) SUPPLY VOLTAGE.....	300 max	volts
GRID-No.2 VOLTAGE.....	See curve page 66	
GRID-No.1 (CONTROL-GRID) VOLTAGE:		
Negative bias value.....	-50 max	volts
Positive bias value.....	0 max	volts
PLATE DISSIPATION.....	3 max	watts
GRID-No.2 INPUT:		
For grid-No.2 voltages up to 150 volts.....	0.65 max	watt
For grid-No.2 voltages between 150 and 300 volts.....	See curve page 66	
PEAK HEATER-CATHODE VOLTAGE:		
Heater negative with respect to cathode.....	200 max	volts
Heater positive with respect to cathode.....	200 max	volts

#### Characteristics:

Plate Supply Voltage.....	100	250	volts
Grid No.3 and Internal Shield.....	Connected to cathode at socket		
Grid-No.2 Supply Voltage.....	100	150	volts
Cathode-Bias Resistor.....	150	68	ohms
Plate Resistance (Approx.).....	0.5	1	megohm
Transconductance.....	3900	5200	$\mu$ mhos
Grid-No.1 Voltage (Approx.) for plate current of 10 $\mu$ a.....	-4.2	-6.5	volts
Plate Current.....	5	10.6	ma
Grid-No.2 Current.....	2.1	4.3	ma

#### Maximum Circuit Values:

Grid-No.1-Circuit Resistance:		
For fixed-bias operation.....	0.25 max	megohm
For cathode-bias operation.....	1.0 max	megohm

■ The dc component must not exceed 100 volts.

#### Maximum Ratings: DIODE UNIT

PEAK INVERSE PLATE VOLTAGE.....	430 max	volts
PEAK PLATE CURRENT.....	180 max	ma
DC PLATE CURRENT.....	45 max	ma

**PEAK HEATER-CATHODE VOLTAGE:**

Heater negative with respect to cathode.....	200 <i>max</i>	volts
Heater positive with respect to cathode.....	200 <i>max</i>	volts

■ The dc component must not exceed 100 volts.

## SEMIREMOTE-CUTOFF PENTODE

# 6BZ6

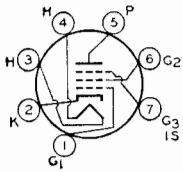

Miniature type used in gain-controlled video if stages of television receivers. Outline 11, **OUTLINES SECTION**. Tube requires miniature seven-contact socket and may be mounted in any position.

HEATER VOLTAGE (AC/DC).....	6.3	volts
HEATER CURRENT.....	0.3	ampere

**DIRECT INTERELECTRODE CAPACITANCES:**

Grid No.1 to Plate.....	<i>Without External Shield</i> 0.025 <i>max</i>	<i>With External Shield</i> <sup>▲</sup> 0.015 <i>max</i>	$\mu$ fd
Grid No.1 to Cathode, Heater, Grid No.2, Grid No.3, and Internal Shield.....	7	7	$\mu$ fd
Plate to Cathode, Heater, Grid No.2, Grid No.3, and Internal Shield.....	2	3	$\mu$ fd

▲ With external shield connected to cathode.

### CLASS A<sub>1</sub> AMPLIFIER

**Maximum Ratings, (Design-Maximum Values):**

PLATE VOLTAGE.....	330 <i>max</i>	volts
GRID No.3 (SUPPRESSOR GRID).....	Connect to cathode at socket	
GRID-No.2 (SCREEN-GRID) SUPPLY VOLTAGE.....	330 <i>max</i>	volts
GRID-No.2 VOLTAGE.....	See curve page 66	
GRID-No.1 (CONTROL-GRID) VOLTAGE, Positive bias value.....	0 <i>max</i>	volts
PLATE DISSIPATION.....	2.3 <i>max</i>	watts
GRID-No.2 INPUT:		
For grid-No.2 voltages up to 165 volts.....	0.55 <i>max</i>	watt
For grid-No.2 voltages between 165 and 330 volts.....	See curve page 66	
PEAK HEATER-CATHODE VOLTAGE:		
Heater negative with respect to cathode.....	200 <i>max</i>	volts
Heater positive with respect to cathode.....	200 <i>max</i>	volts

**Characteristics:**

Plate Supply Voltage.....	125	volts
Grid No.3 and Internal Shield.....	Connected to cathode at socket	
Grid-No.2 Supply Voltage.....	125	volts
Cathode-Bias Resistor.....	56	ohms
Plate Resistance (Approx.).....	0.26	megohm
Transconductance.....	8000	$\mu$ mhos
Grid-No.1 Voltage (Approx.) for transconductance of 50 $\mu$ mhos.....	-19	volts
Grid No.1 Voltage (Approx.) for transconductance of 700 $\mu$ mhos and cathode resistor of 0 ohms.....	-4.5	volts
Plate Current.....	14	ma
Grid-No.2 Current.....	3.6	ma

AVERAGE CHARACTERISTICS

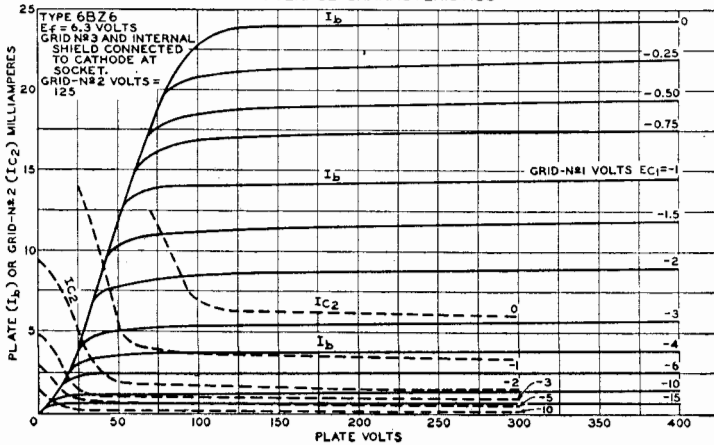

**Maximum Circuit Values:**

Grid-No.1-Circuit Resistance:		
For fixed-bias operation.....	0.25 max	megohm
For cathode-bias operation.....	1.0 max	megohm

■ The dc component must not exceed 100 volts.

**MEDIUM-MU TWIN TRIODE**

**6BZ7**

Miniature type used in direct-coupled cathode-drive rf amplifier circuits of vhf television tuners. In such circuits, one triode unit is used as the direct-coupled grounded-cathode driver for the other unit. This type is also used in push-pull cathode-drive rf amplifiers.

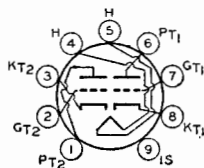

Outline 12, **OUTLINES SECTION**. Tube requires miniature nine-contact socket and may be mounted in any position. For typical operation as a resistance-coupled amplifier, refer to **RESISTANCE-COUPLED AMPLIFIER SECTION**.

HEATER VOLTAGE (AC/DC).....	6.3	volts
HEATER CURRENT.....	0.4	ampere

**CLASS A<sub>1</sub> AMPLIFIER (Each Unit)**

<b>Maximum Ratings:</b>		
PLATE VOLTAGE.....	250*max	volts
PLATE DISSIPATION.....	2.0 max	watts
CATHODE CURRENT.....	20 max	ma
<b>PEAK HEATER-CATHODE VOLTAGE:</b>		
Heater negative with respect to cathode.....	200*max	volts
Heater positive with respect to cathode.....	200*max	volts

\* In cathode-drive circuits with direct-coupled drive, it is permissible for this voltage to be as high as 300 volts under cutoff conditions.

■ The dc component must not exceed 100 volts.

**Characteristics:**

Plate Supply Voltage.....	150	volts
Cathode-Bias Resistor.....	220	ohms
Amplification Factor.....	36	
Plate Resistance (Approx.).....	5300	ohms
Transconductance.....	6800	μmhos
Plate Current.....	10	ma
Grid Voltage (Approx.) for plate current of 100 μa.....	-7	volts

**Maximum Circuit Value:**

Grid-Circuit Resistance.....	0.5 max	megohm
------------------------------	---------	--------

**AVERAGE CHARACTERISTICS  
EACH UNIT**

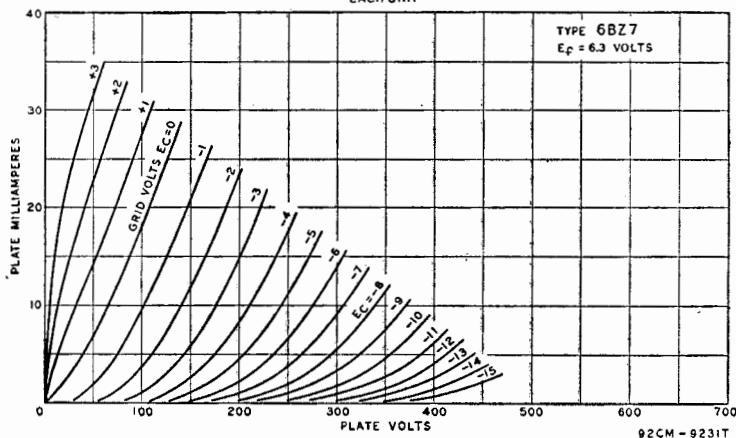

**MEDIUM-MU TWIN TRIODE**

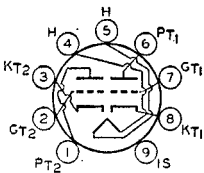

Miniature type used in direct-coupled, cathode-drive, rf amplifier circuits in vhf television tuners. In such circuits, one triode unit is used as the direct-coupled, grounded-cathode driver for the other unit. Outline 12, OUTLINES SECTION. Tube requires miniature nine-contact socket and may be mounted in any position. Heater volts (ac/dc), 6.3; amperes, 0.4. Type 6BZ8 is used principally for renewal purposes.

**6BZ8**

**Maximum Ratings:**

**CLASS A<sub>1</sub> AMPLIFIER (Each Unit)**

PLATE VOLTAGE.....	250 max	volts
CATHODE CURRENT.....	20 max	ma
PLATE DISSIPATION.....	2.2 max	watts
<b>PEAK HEATER-CATHODE VOLTAGE:</b>		
Heater negative with respect to cathode.....	200 max	volts
Heater positive with respect to cathode.....	200 max	volts

**Characteristics:**

Plate Supply Voltage.....	125	volts
Cathode-Bias Resistor.....	100	ohms
Amplification Factor.....	45	
Plate Resistance (Approx.).....	5600	ohms
Transconductance.....	8000	μmhos
Plate Current.....	10	ma
Grid Voltage (Approx.) for transconductance of 50 μmhos.....	-13	volts

**Typical Operation and Characteristics (In Cascode-Type Circuit):**

Plate Supply Voltage.....	250	volts
Grid Voltage.....	-0.5	volt
Transconductance.....	10000	μmhos
Plate Current.....	15	ma

**Maximum Circuit Value:**

Grid-Circuit Resistance.....	0.1 max	megohm
------------------------------	---------	--------

\* With external shield connected to cathode of unit under test.

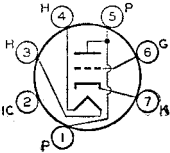

**POWER TRIODE**

Miniature type used in compact radio equipment as a local oscillator in FM and other high-frequency circuits. It may also be used as a class C rf amplifier. In such service, it delivers

**6C4**

a power output of 5.5 watts at moderate frequencies, and 2.5 watts at 150 megacycles per second. Outline 11, OUTLINES SECTION. Tube requires miniature seven-contact socket and may be mounted in any position. For typical operation as a resistance-coupled amplifier, refer to Chart 5, RESISTANCE-COUPLED AMPLIFIER SECTION. For additional curve of plate characteristics, refer to type 12AU7-A.

HEATER VOLTAGE (AC/DC).....	6.3	volts
HEATER CURRENT.....	0.15	ampere
<b>DIRECT INTERELECTRODE CAPACITANCES (Approx.):</b>		
	<i>Without External Shield</i>	<i>With External Shield*</i>
Grid to Plate.....	1.6	1.4
Grid to Cathode and Heater.....	1.8	1.8
Plate to Cathode and Heater.....	1.3	2.5

\* With external shield connected to cathode.

**Maximum Ratings:**

**CLASS A<sub>1</sub> AMPLIFIER**

PLATE VOLTAGE.....	300 max	volts
PLATE DISSIPATION.....	3.5 max	watts
<b>PEAK HEATER-CATHODE VOLTAGE:</b>		
Heater negative with respect to cathode.....	200 max	volts
Heater positive with respect to cathode.....	200 max	volts

**Characteristics:**

Plate Voltage.....	100	250	volts
Grid Voltage*.....	0	-8.5	volts
Amplification Factor.....	19.5	17	
Plate Resistance (Approx.).....	6250	7700	ohms
Transconductance.....	3100	2200	$\mu$ mhos
Plate Current.....	11.8	10.5	ma
Grid Voltage (Approx.) for plate current of 10 $\mu$ A.....	-10	-25	volts

\* Transformer- or impedance-type input coupling devices are recommended to minimize resistance in the grid circuit.

**Maximum Circuit Values:**

Grid-Circuit Resistance:			
For fixed-bias operation.....	0.25 max	megohm	
For cathode-bias operation.....	1.0 max	megohm	

■ The dc component must not exceed 100 volts.

**RF POWER AMPLIFIER AND OSCILLATOR—Class C Telegraphy**

**Maximum Ratings:**

PLATE VOLTAGE.....	300 max	volts
GRID VOLTAGE.....	-50 max	volts
PLATE CURRENT.....	25 max	ma
GRID CURRENT.....	8 max	ma
PLATE DISSIPATION.....	5 max	watts

**Typical Operation at frequencies up to 50 Mc:**

Plate Voltage.....	300	volts
Grid Voltage.....	-27	volts
Plate Current.....	25	ma
Grid Current (Approx.).....	7	ma
Driving Power (Approx.).....	0.35	watt
Power Output (Approx.).....	5.5	watts

• Approximately 2.5 watts power output can be obtained when the 6C4 is used at 150 megacycles as an oscillator with grid resistor of 10,000 ohms and with maximum rated input.

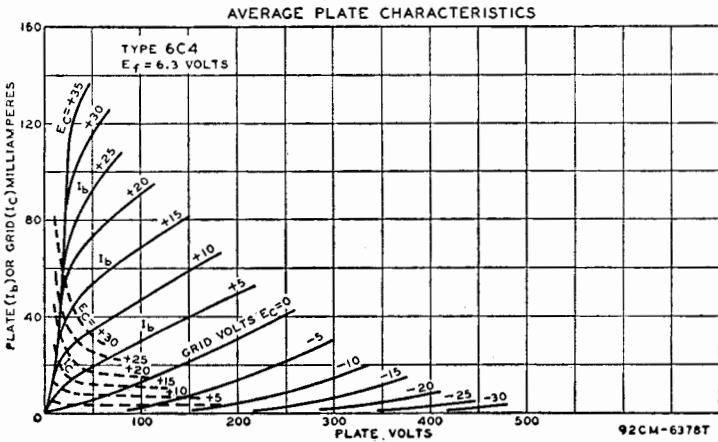

**6C5  
6C5-GT**

**MEDIUM-MU TRIODE**

Metal type 6C5 and glass octal type 6C5-GT used as audio amplifier and oscillator. They are also used as detectors of grid-resistor-and-capacitor type or grid-bias type. Outlines 3

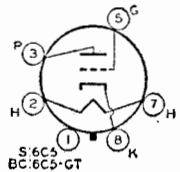

and 24, respectively, OUTLINES SECTION. Tubes require octal socket and may be mounted in any position. Heater volts (ac/dc), 6.3; amperes, 0.3. Maximum ratings as class A<sub>1</sub> amplifier: plate volts, 300 max; plate dissipation, 2.5 max watts; grid volts, positive-bias value, 0 max. Typical operation: plate volts, 250; grid volts, -8 (grid-circuit resistance should not exceed 1.0 megohm); amplification factor, 20; plate resistance, 10000 ohms; transconductance, 2000  $\mu$ mhos; plate ma., 8. The 6C5-GT is a DISCONTINUED type listed for reference only.

### SHARP-CUTOFF PENTODE

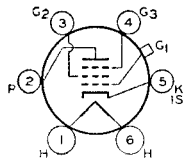

Glass type used as biased detector and as a high-gain amplifier in radio equipment. Outline 45, OUTLINES SECTION. Tube requires six-contact socket. Heater volts (ac/dc), 6.3; amperes, 0.3. For ratings and typical operation data, refer to type 6J7. Type 6C6 is used principally for renewal purposes.

6C6

### TWIN DIODE— MEDIUM-MU TRIODE

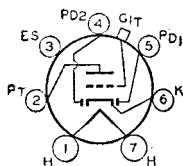

Glass type used as combined detector, amplifier, and avc tube. Outline 40, OUTLINES SECTION. Heater volts (ac/dc), 6.3; amperes, 0.3. This type is similar to, but not interchangeable with, type 85. The 6C7 is a DISCONTINUED type listed for reference only.

6C7

### MEDIUM-MU TWIN TRIODE

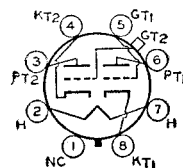

Glass octal type used as a voltage amplifier and phase inverter in radio equipment. Outline 39, OUTLINES SECTION. Tube requires octal socket. Heater volts (ac/dc), 6.3; amperes, 0.3. Maximum ratings for each triode unit as class A<sub>1</sub> amplifier: plate volts, 250 *max*; grid volts, positive-bias value, 0 *max*; plate dissipation, 1.0 *max* watt. Typical operation: plate volts, 250; grid volts, -4.5; plate ma., 3.2; plate

6C8-G

resistance, 22500 ohms; amplification factor, 36; transconductance, 1600  $\mu$ hos. This type is used principally for renewal purposes.

### FULL-WAVE VACUUM RECTIFIER

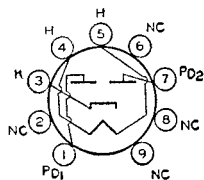

Miniature type used in power-supply of compact, audio equipment having moderate dc requirements. Outline 18, OUTLINES SECTION. Tube requires miniature nine-contact socket

6CA4

and may be mounted in any position. It is especially important that this tube, like other power-handling tubes, be adequately ventilated.

HEATER VOLTAGE (AC/DC).....	6.3	volts
HEATER CURRENT.....	1	ampere

Maximum Ratings:	FULL-WAVE RECTIFIER		
PEAK INVERSE PLATE VOLTAGE.....	1000 <i>max</i>		volts
PEAK PLATE CURRENT (Per Plate).....	450 <i>max</i>		ma
AC PLATE SUPPLY VOLTAGE (Per Plate, rms) with Capacitor Input to Filter.....	350 <i>max</i>		volts
DC OUTPUT CURRENT.....	150 <i>max</i>		ma
HOT SWITCHING TRANSIENT PLATE CURRENT (Per Plate)#.....			
PEAK HEATER-CATHODE VOLTAGE: Heater negative with respect to cathode.....	500 <i>max</i>		volts

Typical Operation with Capacitor Input to Filter:				
AC Plate-to-Plate Supply Voltage (rms).....	500	600	700	volts
Filter-Input Capacitor.....	50	50	50	$\mu$ i
Total Effective Plate Supply Impedance per Plate..	150	200	240	ohms
DC Output Voltage at Input to Filter (Approx.) For dc output current of 150 ma.....	245	293	347	volts

# When capacitor-input circuits are used, a maximum peak current value per plate of 1 ampere during the initial cycles of the hot-switching transient should not be exceeded.

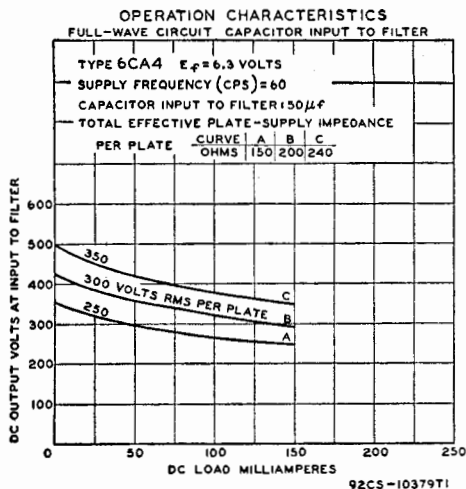

**BEAM POWER TUBE**

Miniature type used in af power output stage of radio and television receivers. Outline 13, OUTLINES SECTION. Tube requires miniature seven-contact socket and may be operated in any position. Heater volts (ac/dc), 6.3; amperes, 1.2.

**6CA5**

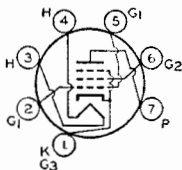

**Maximum Ratings:**

**CLASS A<sub>1</sub> AMPLIFIER**

PLATE VOLTAGE.....	130 <i>max</i>	volts
GRID-NO.2 (SCREEN-GRID) VOLTAGE.....	130 <i>max</i>	volts
GRID-NO.1 (CONTROL-GRID) VOLTAGE, Positive bias value.....	0 <i>max</i>	volts
PLATE DISSIPATION.....	5 <i>max</i>	watts
GRID-NO.2 INPUT.....	1.4 <i>max</i>	watts
<b>PEAK HEATER-CATHODE VOLTAGE:</b>		
Heater negative with respect to cathode.....	200 <i>max</i>	volts
Heater positive with respect to cathode.....	200 <sup>o</sup> <i>max</i>	volts
BULB TEMPERATURE (At hottest point).....	180 <i>max</i>	°C

**Typical Operation:**

Plate Voltage.....	110	125	volts
Grid-No.2 Voltage.....	110	125	volts
Grid-No.1 (Control-Grid) Voltage.....	-4	-4.5	volts
Peak AF Grid-No.1 Voltage.....	4	4.5	volts
Zero-Signal Plate Current.....	32	37	ma
Maximum-Signal Plate Current.....	31	36	ma
Zero-Signal Grid-No.2 Current (Approx.).....	3.5	4	ma
Maximum-Signal Grid-No.2 Current (Approx.).....	1.5	11	ma
Plate Resistance (Approx.).....	16000	15000	ohms
Transconductance.....	8100	9200	$\mu$ mhos
Load Resistance.....	3500	4500	ohms
Total Harmonic Distortion.....	5	6	per cent
Maximum-Signal Power Output.....	1.1	1.5	watts

**Maximum Circuit Values:**

<b>Grid-No.1-Circuit Resistance:</b>		
For fixed-bias operation.....	0.1 <i>max</i>	megohm
For cathode-bias operation.....	0.5 <i>max</i>	megohm

<sup>o</sup> The dc component must not exceed 100 volts.



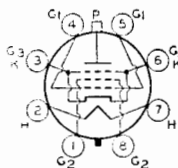

**BEAM POWER TUBE**

Glass octal types used as horizontal deflection amplifiers in color television receivers. Outlines 49 and 46, respectively, OUTLINES SECTION.

**6CB5**  
**6CB5-A**

Tubes require octal socket and may be mounted in any position. Type 6CB5 is a DISCONTINUED type listed for reference only.

HEATER VOLTAGE (AC/DC).....	6.3	volts
HEATER CURRENT.....	2.5	amperes
DIRECT INTERELECTRODE CAPACITANCES (Approx.):		
Grid No.1 to Plate.....	0.4	μf
Grid No.1 to Cathode, Heater, Grid No.2, and Grid No.3.....	22	μf
Plate to Cathode, Heater, Grid No.2, and Grid No.3.....	10	μf
TRANSCONDUCTANCE*.....	8800	μmhos
MU-FACTOR, Grid No.2 to Grid No.1*.....	3.8	

\*For plate and grid-No.2 volts, 175; grid-No.1 volts, -30; plate ma., 90; grid-No.2 ma., 6.

**HORIZONTAL DEFLECTION AMPLIFIER**

*For operation in a 525-line, 30-frame system*

	6CB5		6CB5-A
	Design-Center Values <sup>a</sup>	Design-Maximum Values	
<b>Maximum Ratings:</b>			
DC PLATE VOLTAGE.....	700 max	880 max	volts
PEAK POSITIVE-PULSE PLATE VOLTAGE <sup>b</sup> .....	6800 <sup>c</sup> max	6800 max	volts
PEAK NEGATIVE-PULSE PLATE VOLTAGE.....	-1500 max	-1650 max	volts
DC GRID-NO.2 (SCREEN-GRID) VOLTAGE.....	200 max	220 max	volts
DC GRID-NO.1 (CONTROL-GRID) VOLTAGE.....	-50 max	-55 max	volts
PEAK NEGATIVE-PULSE GRID-NO.1 VOLTAGE.....	-200 max	-220 max	volts
PEAK CATHODE CURRENT.....	- max	850 max	ma
AVERAGE CATHODE CURRENT.....	200 max	240 max	ma
GRID-NO.2 INPUT.....	3.6 max	4 max	watts
PLATE DISSIPATION <sup>d</sup> .....	23 max	26 max	watts
<b>PEAK HEATER-CATHODE VOLTAGE:</b>			
Heater negative with respect to cathode.....	200 max	200 max	volts
Heater positive with respect to cathode.....	200 <sup>e</sup> max	200 <sup>e</sup> max	volts
BULB TEMPERATURE (At hottest point).....	210 max	220 max	°C

**Maximum Circuit Value:**

Grid-No.1-Circuit Resistance.....	0.47 max	megohm
-----------------------------------	----------	--------

<sup>a</sup> Except as noted.

<sup>b</sup> The duration of the voltage pulse must not exceed 15 per cent of one horizontal scanning cycle. In a 525-line, 30-frame system, 15 per cent of one horizontal scanning cycle is 10 microseconds.

<sup>c</sup> Absolute-Maximum Value. Under no circumstances should this absolute value be exceeded.

<sup>d</sup> An adequate bias resistor or other means is required to protect the tube in the absence of excitation.

<sup>e</sup> The dc component must not exceed 100 volts.

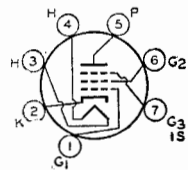

**SHARP-CUTOFF PENTODE**

Miniature types used in television receivers as intermediate-frequency amplifier at frequencies up to about 45 megacycles per second and as rf amplifier in vhf television tuners. Tubes

**6CB6**  
**6CB6-A**

feature very high transconductance combined with low interelectrode capacitance values, and are provided with separate base pins for grid No.3 and the cathode to permit the use of an unbypassed cathode resistor to minimize the effects of regeneration. Type 6CB6-A has a controlled heater warm-up time for use in television receivers employing series-connected heater strings. Outline 11, OUTLINES SECTION. Tubes require miniature seven-contact socket and may be mounted in any position. For typical operation as a resistance-coupled amplifier, refer to Chart 13, RESISTANCE-COUPLED AMPLIFIER SECTION.

HEATER VOLTS (AC/DC).....	6.3	volts
HEATER CURRENT.....	0.3	ampere
HEATER WARM-UP TIME (Average) for 6CB6-A.....	11	seconds

DIRECT INTERELECTRODE CAPACITANCES:	Without External Shield	With External Shield <sup>▲</sup>	
Grid No.1 to Plate.....	0.025 max	0.015 max	$\mu\mu\text{f}$
Grid No.1 to Cathode, Heater, Grid No.2, Grid No.3, and Internal Shield.....	6.5	6.5	$\mu\mu\text{f}$
Plate to Cathode, Heater, Grid No.2, Grid No.3, and Internal Shield.....	2		$\mu\mu\text{f}$

▲ With external shield connected to cathode.

### CLASS A<sub>1</sub> AMPLIFIER

Maximum Ratings, (Design-Maximum Values):

PLATE VOLTAGE.....	330 max	volts
GRID NO.3 (SUPPRESSOR GRID) AND INTERNAL SHIELD.....	Connect to cathode at socket	
GRID-NO.2 (SCREEN-GRID) VOLTAGE.....	See curve page 66	
GRID-NO.2 SUPPLY VOLTAGE.....	330 max	volts
GRID-NO. 1 (CONTROL-GRID) VOLTAGE, Positive bias value.....	0 max	volts
PLATE DISSIPATION.....	2.3 max	watts
GRID-NO.2 INPUT:		
For grid-No.2 voltages up to 165 volts.....	0.55 max	watt
For grid-No.2 voltages between 165 and 330 volts.....	See curve page 66	
PEAK HEATER-CATHODE VOLTAGE:		
Heater negative with respect to cathode.....	200 max	volts
Heater positive with respect to cathode.....	200 <sup>o</sup> max	volts

### Characteristics:

Plate Supply Voltage.....	125	volts
Grid No.3 and Internal Shield.....	Connected to cathode at socket	
Grid-No.2 Supply Voltage.....	125	volts
Cathode-Bias Resistor.....	56	ohms
Plate Resistance (Approx.).....	0.28	megohm
Transconductance.....	8000	$\mu\text{mhos}$
Grid-No.1 Voltage (Approx.) for plate current of 20 $\mu\text{a}$ .....	-6.5	volts
Grid-No.1 Voltage (Approx.) for plate current of 2.8 ma. and cathode resistor of 0 ohms.....	-3	volts
Plate Current.....	13	ma
Grid-No.2 Current.....	3.7	ma

The dc component must not exceed 100 volts.

### AVERAGE CHARACTERISTICS

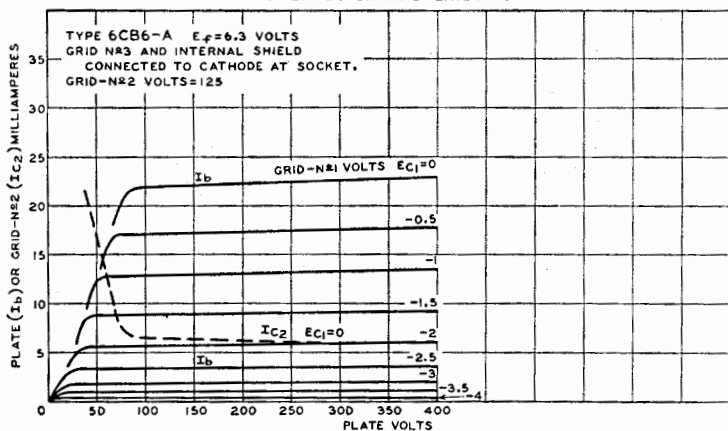

## 6CD6-G

## 6CD6-GA

### BEAM POWER TUBE

Glass octal types used as horizontal deflection amplifiers in high-efficiency deflection circuits of television receivers employing either transformer coupling or direct coupling to the deflection yoke. Outlines 52 and 46, respectively, OUTLINES SECTION. Tubes require octal socket. Type 6CD6-GA may be supplied with pins 1, 4, and 6 omitted. Vertical tube mounting is preferred but horizontal operation is permissible if pins No. 2 and 7 are in vertical plane. Type 6CD6-G has a maximum peak positive-pulse

deflection yoke. Outlines 52 and 46, respectively, OUTLINES SECTION. Tubes require octal socket. Type 6CD6-GA may be supplied with pins 1, 4, and 6 omitted. Vertical tube mounting is preferred but horizontal operation is permissible if pins No. 2 and 7 are in vertical plane. Type 6CD6-G has a maximum peak positive-pulse

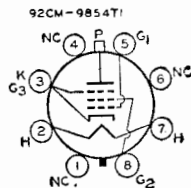

plate-voltage rating (*Absolute Maximum*) of 6600 volts, a maximum plate-dissipation rating of 15 watts, and a maximum bulb-temperature rating (at hottest point) of 210°C. Type 6CD6-G is a DISCONTINUED type listed for reference only.

HEATER VOLTAGE (AC/DC).....	6.3	volts
HEATER CURRENT.....	2.5	amperes
DIRECT INTERELECTRODE CAPACITANCES (Approx.):		
Grid No.1 to Plate.....	1.1	$\mu$ fd
Grid No.1 to Cathode, Heater, Grid No.2, and Grid No.3.....	22	$\mu$ fd
Plate to Cathode, Heater, Grid No.2, and Grid No.3.....	8.5	$\mu$ fd
TRANSCONDUCTANCE <sup>o</sup> .....	7700	$\mu$ mhos
PLATE RESISTANCE (Approx.) <sup>o</sup> .....	7200	ohms
MU-FACTOR, Grid No.2 to Grid No.1 <sup>o</sup> .....	3.9	

\*For plate and grid-No.2 volts, 175; grid-No.1 volts, -30; plate ma., 75; grid-No.2 ma., 5.5.

**HORIZONTAL DEFLECTION AMPLIFIER**

**Maximum Ratings:**

*For operation in a 525-line, 30-frame system*

DC PLATE VOLTAGE.....	700 <i>max</i>	volts
PEAK POSITIVE-PULSE PLATE VOLTAGE* ( <i>Absolute Maximum</i> ).....	7000 <i>max</i>	volts
PEAK NEGATIVE-PULSE PLATE VOLTAGE.....	-1500 <i>max</i>	volts
DC GRID-NO.2 (SCREEN-GRID) VOLTAGE.....	175 <i>max</i>	volts
PEAK NEGATIVE-PULSE GRID-NO.1 VOLTAGE.....	-200 <i>max</i>	volts
PEAK CATHODE CURRENT.....	700 <i>max</i>	ma
AVERAGE CATHODE CURRENT.....	200 <i>max</i>	ma
PLATE DISSIPATION†.....	20 <i>max</i>	watts
GRID-NO.2 INPUT.....	3 <i>max</i>	watts
<b>PEAK HEATER-CATHODE VOLTAGE:</b>		
Heater negative with respect to cathode.....	200 <i>max</i>	volts
Heater positive with respect to cathode.....	200 <i>max</i>	volts
BULB TEMPERATURE (At hottest point).....	225 <i>max</i>	°C

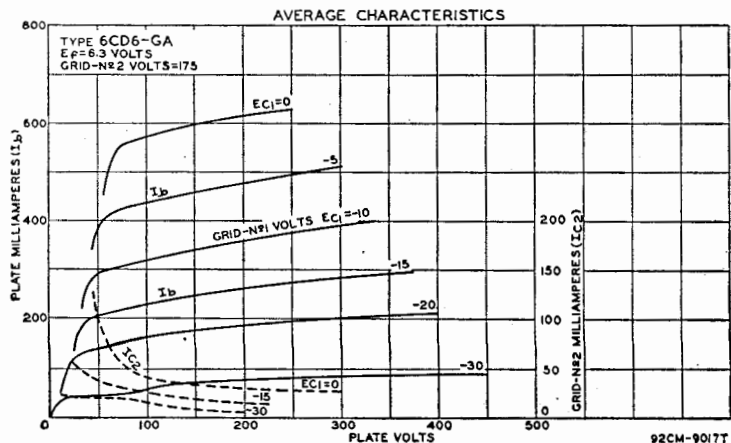
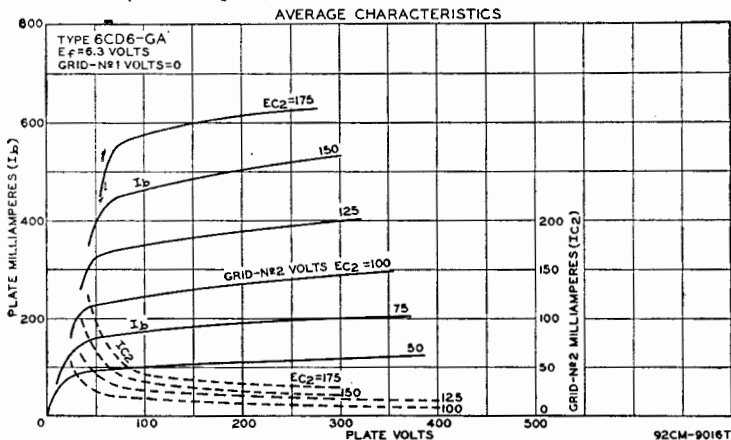

**Maximum Circuit Value:**

Grid-No.1-Circuit Resistance: ..... 0.47 *max* megohm  
 For grid-resistor-bias operation.....

\* The duration of the voltage pulse must not exceed 15 per cent of one horizontal scanning cycle. In a 525-line, 30-frame system, 15 per cent of one horizontal scanning cycle is 10 microseconds.

■ Under no circumstances should this absolute value be exceeded.

An adequate bias resistor or other means is required to protect the tube in the absence of excitation.

° The dc component must not exceed 100 volts.

**SHARP-CUTOFF PENTODE**

**6CE5**

Miniature type used as rf and if amplifier in vhf television receivers employing series-connected heater strings. Outline 11, OUTLINES SECTION. Tube requires miniature seven-contact socket and may be operated in any position.

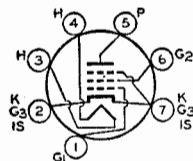

HEATER VOLTS (AC/DC).....	6.3	volts
HEATER CURRENT.....	0.3	ampere
HEATER WARM-UP TIME (Average).....	11	seconds
DIRECT INTERELECTRODE CAPACITANCES:°		
Grid No.1 to Plate.....	0.03 <i>max</i>	$\mu$ f
Grid No.1 to Cathode, Heater, Grid No.2, Grid No.3, and Internal Shield.....	6.5	$\mu$ f
Plate to Cathode, Heater, Grid No.2, Grid No.3, and Internal Shield.....	1.9	$\mu$ f
Without external shield.....		

**Maximum Ratings:**

**CLASS A<sub>1</sub> AMPLIFIER**

PLATE VOLTAGE.....	300 <i>max</i>	volts
GRID-NO.2 (SCREEN-GRID) VOLTAGE.....	150 <i>max</i>	volts
GRID-NO.1 (CONTROL-GRID) VOLTAGE, Positive bias value.....	0 <i>max</i>	volts
GRID-NO.2 INPUT.....	0.5 <i>max</i>	watt
PLATE DISSIPATION.....	2 <i>max</i>	watts
PEAK HEATER-CATHODE VOLTAGE:		
Heater negative with respect to cathode.....	200 <i>max</i>	volts
Heater positive with respect to cathode.....	200 <i>max</i>	volts

■ The dc component must not exceed 100 volts.

**Characteristics:**

Plate Voltage.....	125	volts
Grid-No.2 Voltage.....	125	volts
Grid-No.1 Supply Voltage.....	-1	volt
Grid-No.1 Resistor (Bypassed).....	1	megohm
Plate Resistance (Approx.).....	0.3	megohm
Transconductance.....	7600	$\mu$ mhos
Grid-No.1 Voltage (Approx.) for plate $\mu$ a=35.....	-5	volts
Plate Current.....	11	ma
Grid-No.2 Current.....	2.3	ma

**SHARP-CUTOFF PENTODE**

**6CF6**

Miniature type used in television receivers as an intermediate-frequency amplifier at frequencies up to about 45 megacycles per second and as an rf amplifier in vhf television tuners. Be-

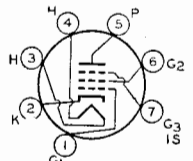

cause of its plate-current cutoff characteristic, this type is used in gain-controlled stages of video if amplifiers. This type is electrically similar to miniature type 6BC6. Outline 11, OUTLINES SECTION. Heater volts (ac/dc), 6.3; amperes, 0.3.

**Characteristics:**

Plate Supply Voltage.....	125	volts
Grid No.3 and Internal Shield.....	Connected to cathode at socket	
Grid-No.2 Supply Voltage.....	125	volts
Cathode-Bias Resistor.....	56	ohms
Plate Resistance (Approx.).....	0.3	megohm
Transconductance.....	7800	$\mu$ mhos
Grid-No 1 Voltage (Approx.) for plate current of 20 $\mu$ a.....	-6	volts
Grid-No.1 Voltage (Approx.) for plate current of 2.2 ma. and cathode resistor of 0 ohms.....	-3	volts
Plate Current.....	12.5	ma
Grid No.2 Current.....	3.7	ma

### MEDIUM-MU TWIN TRIODE

# 6CG7

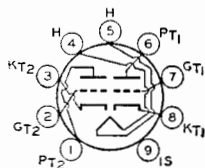

Miniature type used as combined vertical deflection and horizontal deflection oscillator in television receivers. Also used as phase inverter, sync separator and amplifier, and resistance-coupled amplifier in radio receivers. This type has a controlled heater warm-up time for use in receivers employing series-connected heater strings. Except for the common heater, each triode unit is independent of the other. Outline 14, OUTLINES SECTION. Tube requires miniature nine-contact socket and may be mounted in any position. For typical operation as a resistance-coupled amplifier, refer to RESISTANCE-COUPLED AMPLIFIER SECTION.

HEATER VOLTAGE (AC/DC) ..... 6.3 volts  
 HEATER CURRENT ..... 0.6 amperes  
 HEATER WARM-UP TIME (Average) ..... 11 seconds  
 DIRECT INTERELECTRODE CAPACITANCES (Each Unit, Approx.):  
   Grid to Plate ..... 4.0  $\mu$ f  
   Grid to Cathode, Heater, and Internal Shield ..... 2.3  $\mu$ f  
   Plate to Cathode, Heater, and Internal Shield ..... 2.2  $\mu$ f

#### CLASS A<sub>1</sub> AMPLIFIER (Each Unit)

Maximum Ratings, (Design-Maximum Values):

PLATE VOLTAGE .....	330 max	volts
GRID VOLTAGE, Positive bias value .....	0 max	volts
PLATE DISSIPATION:		
For either plate .....	4 max	watts
For both plates with both units operating .....	5.7 max	watts
CATHODE CURRENT .....	22 max	ma
PEAK HEATER-CATHODE VOLTAGE:		
Heater negative with respect to cathode .....	200 max	volts
Heater positive with respect to cathode .....	200 max	volts

**Characteristics:**

Plate Voltage .....	90	250	volts
Grid Voltage .....	0	-8	volts
Amplification Factor .....	20	20	
Plate Resistance (Approx.) .....	6700	7700	ohms
Transconductance .....	3000	2600	$\mu$ mhos
Grid Voltage (Approx.) for plate current of 10 $\mu$ a .....	-7	-18	volts
Plate Current for grid voltage of -12.5 volts .....	-	1.3	ma
Plate Current .....	10	9	ma

**Maximum Circuit Value:**

Grid-Circuit Resistance:		
For fixed-bias operation .....	1.0 max	megohm

■ The dc component must not exceed 100 volts.

**AVERAGE PLATE CHARACTERISTICS  
FOR EACH UNIT**

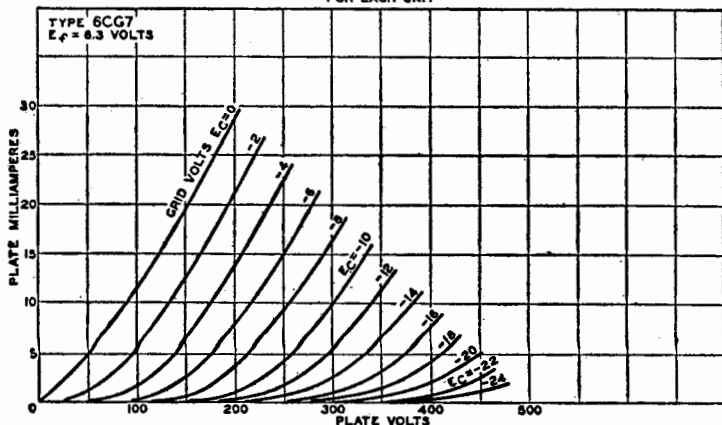

92CM-6442T

**OSCILLATOR**

*For operation in a 525-line, 30-frame system*

Maximum Ratings, ( <i>Design-Maximum Values, Each Unit</i> ):	<i>Vertical Deflection Oscillator</i>	<i>Horizontal Deflection Oscillator</i>	
DC PLATE VOLTAGE.....	330 <i>max</i>	330 <i>max</i>	volts
PEAK NEGATIVE-PULSE GRID VOLTAGE.....	-440 <i>max</i>	-660 <i>max</i>	volts
PEAK CATHODE CURRENT.....	77 <i>max</i>	330 <i>max</i>	ma
AVERAGE CATHODE CURRENT.....	22 <i>max</i>	22 <i>max</i>	ma
PLATE DISSIPATION:			
For either plate.....	4 <i>max</i>	4 <i>max</i>	watts
For both plates with both units operating.....	5.7 <i>max</i>	5.7 <i>max</i>	watts
PEAK HEATER-CATHODE VOLTAGE:			
Heater negative with respect to cathode.....	200 <i>max</i>	200 <i>max</i>	volts
Heater positive with respect to cathode.....	200 <i>max</i>	200 <i>max</i>	volts
<b>Maximum Circuit Value:</b>			
Grid-Circuit Resistance.....	2.2 <i>max</i>	2.2 <i>max</i>	megohms

• The dc component must not exceed 100 volts.

**MEDIUM-MU TRIODE—  
SHARP-CUTOFF PENTODE**

**6CG8  
6CG8-A**

Miniature types used as combined oscillator and mixer tubes in television receivers utilizing an intermediate frequency in the order of 40 megacycles per second. When used in an AM/FM

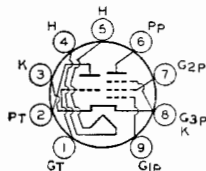

receiver, the triode unit is used as an oscillator for both sections. In the AM section, the pentode unit is used as a high-gain pentode mixer; in the FM section, the pentode unit is used either as a pentode mixer or as a triode-connected mixer depending on signal-to-noise considerations. Type 6CG8-A has a controlled heater warm-up time for use in television receivers employing series-connected heater strings. Outline 12, OUTLINES SECTION. Tubes require miniature nine-contact socket and may be mounted in any position. Heater volts (ac/dc), 6.3; amperes, 0.45; warm-up time (average) for 6CG8-A, 11 seconds. Maximum ratings, characteristics, and typical operating values are the same as those of miniature type 6X8. For curves of average characteristics, see type 6X8. The 6CG8 is a DISCONTINUED type listed for reference only.

**DIRECT INTERELECTRODE CAPACITANCES:**

	<i>Without External Shield</i>	<i>With External Shield<sup>2</sup></i>	
<b>Triode Unit:</b>			
Grid to Plate.....	1.5	1.5	μf
Grid to Cathode, Heater, and Pentode Grid No.3.....	2	2.4	μf
Plate to Cathode, Heater, and Pentode Grid No.3.....	0.5	1	μf
<b>Pentode Unit:</b>			
Grid No.1 to Plate.....	0.04 <i>max</i>	0.02 <i>max</i>	μf
Grid No.1 to Cathode, Heater, Grid No.2, and Grid No.3	4.6	4.8	μf
Plate to Cathode, Heater, Grid No.2, and Grid No.3...	0.9	1.6	μf
Pentode Grid No.1 to Triode Plate.....	0.05 <i>max</i>	0.04 <i>max</i>	μf
Pentode Plate to Triode Plate.....	0.05 <i>max</i>	0.008 <i>max</i>	μf
Heater to Cathode.....	6.5	6.5 <sup>•</sup>	μf

<sup>2</sup> With External shield connected to cathode, except as noted.

• With external shield connected to plate.

**MEDIUM-MU TRIODE—  
SHARP-CUTOFF PENTODE**

**6CH8**

Miniature type used in a wide variety of applications in television receivers. The pentode unit is used as an if amplifier, video amplifier, agc amplifier, or reactance tube. The triode

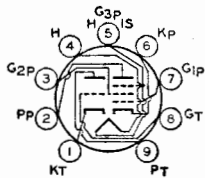

unit is used in low-frequency oscillator, sync-separator, sync-clipper, and phase-splitter circuits. Outline 12, OUTLINES SECTION. Tube requires miniature nine-contact socket and may be mounted in any position. For curves of average plate characteristics, refer to type 6AN8. The pentode-unit curve for the 6AN8 applies for this type except that grid No.3, heater, and internal shield (pin 5) are connected to ground.

## Technical Data

HEATER VOLTAGE (AC/DC).....	6.3	volts
HEATER CURRENT.....	0.45	ampere
DIRECT INTERELECTRODE CAPACITANCES:		
Triode Unit:		
Grid to Plate.....	1.6	$\mu\text{f}$
Grid to Cathode, Heater, Pentode Grid No.3, and Internal Shield.....	1.9	$\mu\text{f}$
Plate to Cathode, Heater, Pentode Grid No.3, and Internal Shield.....	1.6	$\mu\text{f}$
Pentode Unit:		
Grid No.1 to Plate.....	0.025	$\mu\text{f}$
Grid No.1 to Cathode, Heater, Grid No.2, Grid No.3, and Internal Shield.....	7	$\mu\text{f}$
Plate to Cathode, Heater, Grid No.2, Grid No.3, and Internal Shield.....	2.25	$\mu\text{f}$
Triode Grid to Pentode Plate.....	0.005	$\mu\text{f}$
Pentode Grid No.1 to Triode Plate.....	0.02	$\mu\text{f}$
Pentode Plate to Triode Plate.....	0.04	$\mu\text{f}$

### CLASS A<sub>1</sub> AMPLIFIER

<b>Maximum Ratings:</b>	<i>Triode Unit</i>	<i>Pentode Unit</i>	
PLATE VOLTAGE.....	300 max	300 max	volts
GRID NO.3 (SUPPRESSOR GRID), HEATER, AND INTERNAL SHIELD (Pin 5).....	-	Connect to ground at socket	
GRID-NO.2 SUPPLY VOLTAGE.....	-	300 max	volts
GRID-NO.2 (SCREEN-GRID) VOLTAGE.....	-	See curve page 66	
GRID-NO.1 (CONTROL-GRID) VOLTAGE, Positive-bias value.....	0 max	0 max	volts
PLATE DISSIPATION.....	2.6 max	2 max	watts
GRID-NO.2 INPUT:			
For grid-No.2 voltages up to 150 volts.....	-	0.5 max	watt
For grid-No 2 voltages between 150 and 300 volts.....	-	See curve page 66	
PEAK HEATER-CATHODE VOLTAGE:			
Heater negative with respect to cathode.....	200 max	4 max	volts
Heater positive with respect to cathode.....	200°max	0 max	volts

#### Characteristics:

Plate Supply Voltage.....	200	200	volts
Grid No.3, Heater, and Internal Shield.....	-	Connected to ground at socket	
Grid-No.2 Supply Voltage.....	-	150	volts
Grid Voltage.....	-6	-	volts
Cathode-Bias Resistor.....	-	180	ohms
Amplification Factor.....	19	-	
Plate Resistance (Approx.).....	5750	300000	ohms
Transconductance.....	3300	6200	$\mu\text{mhos}$
Grid-No.1 Voltage (Approx.) for plate current of 10 $\mu\text{a}$ .....	-19	-8	volts
Plate Current.....	13	9.5	ma
Grid-No.2 Current.....	-	2.8	ma

#### Maximum Circuit Values:

Grid-No.1-Circuit Resistance: <sup>o</sup>			
For fixed-bias operation.....	0.5 max	0.25 max	megohm
For cathode bias operation.....	1.0 max	1.0 max	megohm

<sup>o</sup> The dc component must not exceed 100 volts.

<sup>a</sup> The heater-cathode voltage should not exceed the value of the operating cathode bias because the voltage between the heater and cathode is also applied between the cathode and grid No.3. The net result is to make grid No.3 negative with respect to cathode with possible change in tube characteristics.

<sup>\*</sup> If either unit is operating at maximum rated conditions, grid No.1-circuit resistance for both units should not exceed the stated values.

### LOW-MU TRIODE

Glass octal type used as a vertical-deflection-amplifier tube in television receivers. Outline 26, OUTLINES SECTION. Tube requires octal socket and may be mounted in any position. Type 6CK4 is used principally for renewal purposes.

## 6CK4

HEATER VOLTAGE (AC/DC).....	6.3	volts
HEATER CURRENT.....	1.25	ampere
AMPLIFICATION FACTOR <sup>o</sup> .....	6.6	
PLATE RESISTANCE (Approx.) <sup>o</sup> .....	1200	ohms
TRANSCONDUCTANCE.....	5500	$\mu\text{mhos}$

<sup>o</sup> For plate volts, 250; grid volts, -28; plate ma., 40.

## VERTICAL-DEFLECTION AMPLIFIER

For operation in a 525-line, 30-frame system

### Maximum Ratings, (Design-Maximum Values):

DC PLATE VOLTAGE .....	550 max	volts
PEAK POSITIVE-PULSE PLATE VOLTAGE* .....	2000 max	volts
PEAK NEGATIVE-PULSE GRID VOLTAGE .....	250 max	volts
PEAK CATHODE CURRENT .....	350 max	ma
AVERAGE CATHODE CURRENT .....	100 max	ma
PLATE DISSIPATION .....	12 max	watts
PEAK HEATER-CATHODE VOLTAGE:		
Heater negative with respect to cathode .....	200 max	volts
Heater positive with respect to cathode .....	200*max	volts

### Maximum Circuit Value:

Grid-Circuit Resistance:	
For cathode-bias operation .....	2.2 max megohms

\* The duration of the voltage pulse must not exceed 15 per cent of one vertical scanning cycle. In a 525-line, 30-frame system, 15 per cent of one vertical scanning cycle is 2.5 milliseconds.

\* The dc component must not exceed 100 volts.

## POWER PENTODE

# 6CL6

Miniature type used in output stage of video amplifier of television receivers and as wide-band amplifier tube in industrial and laboratory equipment. Outline 14, OUTLINES SECTION.

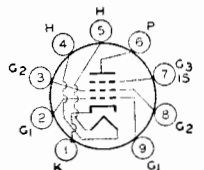

Tube requires miniature nine-contact socket and may be mounted in any position.

HEATER VOLTAGE (AC/DC) .....	6.3	volts
HEATER CURRENT .....	0.65	ampere
DIRECT INTERELECTRODE CAPACITANCES (Approx.):		
Grid No.1 to Plate .....	0.12	µf
Grid No.1 to Cathode, Heater, Grid No.2, Grid No.3, and Internal Shield .....	11	µf
Plate to Cathode, Heater, Grid No.2, Grid No.3, and Internal Shield .....	5.5	µf

### Maximum Ratings:

### CLASS A<sub>1</sub> AMPLIFIER

PLATE VOLTAGE .....	300 max	volts
GRID No.3 (SUPPRESSOR GRID) .....	Connect to cathode at socket	
GRID-No.2 (SCREEN-GRID) SUPPLY VOLTAGE .....	300 max	volts
GRID-No.2 VOLTAGE .....	150 max	volts
GRID-No.1 (CONTROL-GRID) VOLTAGE:		
Negative bias value .....	-50 max	volts
Positive bias value .....	0 max	volts
PLATE DISSIPATION .....	7.5 max	watts
GRID-No.2 INPUT .....	1.7 max	watts
PEAK HEATER-CATHODE VOLTAGE:		
Heater negative with respect to cathode .....	100 max	volts
Heater positive with respect to cathode .....	100 max	volts
BULB TEMPERATURE (At hottest point) .....	200 max	°C

### AVERAGE CHARACTERISTICS

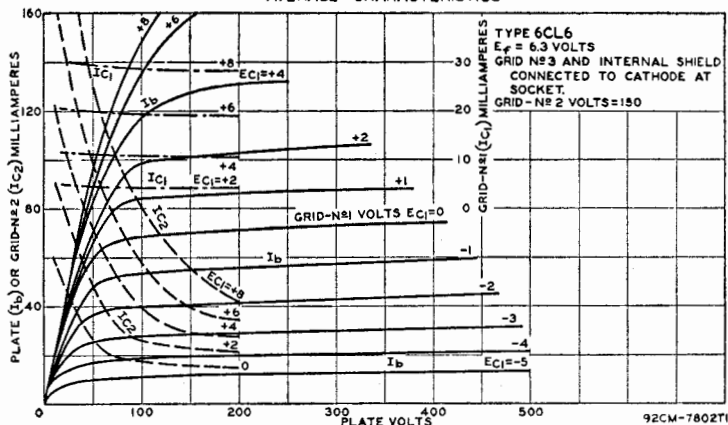



**Typical Operation:**

Plate Voltage	250	volts
Grid No.3 and Internal Shield	Connected to cathode at socket	
Grid-No.2 Voltage	150	volts
Grid-No.1 Voltage	-3	volts
Peak AF Grid-No.1 Voltage	3	volts
Zero-Signal Plate Current	30	ma
Maximum-Signal Plate Current	31	ma
Zero-Signal Grid-No.2 Current	7	ma
Maximum-Signal Grid-No.2 Current	7.2	ma
Plate Resistance (Approx.)	0.09	megohm
Transconductance	11000	μmhos
Grid-No.1 Voltage (Approx.) for plate current of 10 μa	-14	volts
Load Resistance	7500	ohms
Total Harmonic Distortion	8	per cent
Maximum-Signal Power Output	2.8	watts

**Typical Operation in 4-Mc-Bandwidth Video Amplifier:**

Plate Supply Voltage	300	volts
Grid No.3 and Internal Shield	Connected to cathode at socket	
Grid-No.2 Supply Voltage	300	volts
Grid-No.1 Bias Voltage	-2	volts
Grid-No.1 Signal Voltage (Peak to Peak)	3	volts
Grid-No.2 Resistor	24000	ohms
Grid-No.1 Resistor	0.1	megohm
Load Resistor	3900	ohms
Zero-Signal Plate Current	30	ma
Zero-Signal Grid-No.2 Current	7.0	ma
Voltage Output (Peak to Peak)	132	volts

**Maximum Circuit Values:**

Grid-No.1 Circuit Resistance:		
For fixed-bias operation	0.1 max	megohm
For cathode-bias operation	0.5 max	megohm

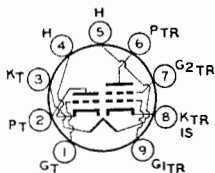

**MEDIUM-MU TRIODE—  
SHARP-CUTOFF TETRODE**

Miniature types used as combined vhf oscillator and mixer in television receivers employing series-connected heater strings. Outline 12, OUTLINES SECTION. Tubes require miniature

**6CL8**  
**6CL8-A**

nine-contact socket and may be mounted in any position. For maximum ratings as class A<sub>1</sub> amplifier, see type 6U8-A. Type 6CL8 is a DISCONTINUED type listed for reference only.

HEATER VOLTAGE (AC/DC)	6.3	volts
HEATER CURRENT	0.45	ampere
HEATER WARM-UP TIME (Average)	11	seconds

**CLASS A<sub>1</sub> AMPLIFIER**

Characteristics:	Triode Unit		Tetrode Unit		
	6CL8	6CL8-A	6CL8	6CL8-A	
Plate Supply Voltage	125	125	125	125	volts
Grid-No.2 (Screen-Grid) Voltage	-	-	125	125	volts
Grid-No.1 Voltage	-1	-1	-1	-1	volts
Amplification Factor	40	40	-	-	
Plate Resistance (Approx.)	0.005	0.005	0.12	0.2	megohm
Transconductance	8000	8000	6000	6500	μmhos
Grid-No.1 Voltage (Approx.) for plate current of 20 μa	-9	-9	-10	-9	volts
Plate Current	14	14	12	12	ma
Grid-No.2 Current	-	-	4	4	ma

**Maximum Circuit Values:**

Grid-No.1-Circuit Resistance:				
For fixed-bias operation	0.5 max	0.25 max	0.25 max	megohm
For cathode-bias operation	1 max	1 max	1 max	megohm

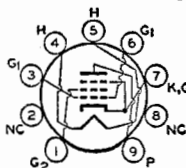

**BEAM POWER TUBE**

Miniature type used as vertical deflection amplifier in television receivers and as audio power amplifier in radio and television receivers. Outline 14, OUTLINES SECTION. Tube

**6CM6**

requires miniature nine-contact socket and may be mounted in any position. For typical operation and maximum circuit values as class A<sub>1</sub> amplifier, refer to type 6V6-GT. For curves of average plate characteristics, refer to type 6AQ5-A.

HEATER VOLTAGE (AC/DC).....	6.3	volts
HEATER CURRENT.....	0.45	ampere
AMPLIFICATION FACTOR*.....	9.8	
PLATE RESISTANCE (Approx.)*.....	1960	ohms
TRANSCONDUCTANCE*.....	5000	$\mu$ mhos

\* Grid No.2 connected to plate; plate and grid-No.2 volts, 250; grid-No.1 volts, -12.5; plate and grid-No.2 ma., 49.5.

### CLASS A<sub>1</sub> AMPLIFIER

#### Maximum Ratings:

PLATE VOLTAGE.....	315 <i>max</i>	volts
GRID-NO.2 (SCREEN-GRID) VOLTAGE.....	285 <i>max</i>	volts
GRID-NO.2 INPUT.....	2 <i>max</i>	watts
PLATE DISSIPATION.....	12 <i>max</i>	watts
PEAK HEATER-CATHODE VOLTAGE:		
Heater negative with respect to cathode.....	200 <i>max</i>	volts
Heater positive with respect to cathode.....	200 <sup>■</sup> <i>max</i>	volts

### VERTICAL DEFLECTION AMPLIFIER

*For operation in a 525-line, 30-frame system*

Maximum Ratings:	Triode Connection <sup>o</sup>	Pentode Connection	
DC PLATE VOLTAGE.....	315 <i>max</i>	315 <i>max</i>	volts
PEAK POSITIVE-PULSE PLATE VOLTAGE† ( <i>Absolute Maximum</i> ).....	2000 <sup>▲</sup> <i>max</i>	2000 <sup>▲</sup> <i>max</i>	volts
DC GRID-NO.2 (SCREEN-GRID) VOLTAGE.....	-	285 <i>max</i>	volts
PEAK NEGATIVE-PULSE GRID-NO.1 (CONTROL-GRID) VOLTAGE.....	-250 <i>max</i>	-250 <i>max</i>	volts
PEAK CATHODE CURRENT.....	120 <i>max</i>	120 <i>max</i>	ma
AVERAGE CATHODE CURRENT.....	40 <i>max</i>	40 <i>max</i>	ma
PLATE DISSIPATION.....	9 <i>max</i>	8 <i>max</i>	watts
GRID-NO.2 INPUT.....	-	1.75 <i>max</i>	watts
PEAK HEATER-CATHODE VOLTAGE:			
Heater negative with respect to cathode.....	200 <i>max</i>	200 <i>max</i>	volts
Heater positive with respect to cathode.....	200 <sup>■</sup> <i>max</i>	200 <sup>■</sup> <i>max</i>	volts

#### Maximum Circuit Values:

Grid-No.1-Circuit Resistance: For cathode-bias operation.....	2.2 <i>max</i>	2.2 <i>max</i>	megohms
--	----------------	----------------	---------

<sup>o</sup> Grid No.2 connected to plate.

† The duration of the voltage pulse must not exceed 15 per cent of one vertical scanning cycle. In a 525-line, 30-frame system, 15 per cent of one vertical scanning cycle is 2.5 milliseconds.

▲ Under no circumstances should this absolute value be exceeded.

■ The dc component must not exceed 100 volts.

### MEDIUM-MU DUAL TRIODE

## 6CM7

Miniature type used as combined vertical deflection oscillator and vertical deflection amplifier in television receivers employing series-connected heater strings. Unit No.1 is used as a conventional blocking oscillator in vertical deflection circuits, and unit No.2 as a vertical deflection amplifier. Outline 14, OUTLINES SECTION. Tube requires miniature nine-contact socket and may be mounted in any position.

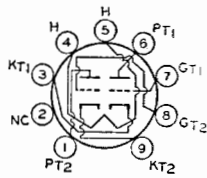

HEATER VOLTAGE (AC/DC).....	6.3	volts
HEATER CURRENT.....	0.6	ampere
HEATER WARM-UP TIME (Average).....	11	seconds

DIRECT INTERELECTRODE CAPACITANCES (Approx.):	Unit No.1	Unit No.2	
Grid to Plate.....	3.8	3	$\mu$ mf
Grid to Cathode and Heater.....	2	3.5	$\mu$ mf
Plate to Cathode and Heater.....	0.5	0.4	$\mu$ mf

### VERTICAL DEFLECTION OSCILLATOR AND AMPLIFIER

*For operation in a 525-line, 30-frame system*

Maximum Ratings, ( <i>Design-Maximum Values</i> ):	Unit No.1 Oscillator	Unit No.2 Amplifier	
DC PLATE VOLTAGE.....	550 <i>max</i>	550 <i>max</i>	volts
PEAK POSITIVE-PULSE PLATE VOLTAGE†.....	-	2200 <i>max</i>	volts
PEAK NEGATIVE-PULSE GRID VOLTAGE.....	-220 <i>max</i>	-220 <i>max</i>	volts
PEAK CATHODE CURRENT.....	77 <i>max</i>	77 <i>max</i>	ma
AVERAGE CATHODE CURRENT.....	17 <i>max</i>	22 <i>max</i>	ma
PLATE DISSIPATION.....	1.45 <i>max</i>	6 <i>max</i>	watts
PEAK HEATER-CATHODE VOLTAGE:			
Heater negative with respect to cathode.....	200 <i>max</i>	200 <i>max</i>	volts
Heater positive with respect to cathode.....	200 <sup>▲</sup> <i>max</i>	200 <sup>▲</sup> <i>max</i>	volts

## Maximum Circuit Values:

### Grid-Circuit Resistance:

For fixed-bias operation.....	2.2 max	1.0 max	megohms
For cathode-bias operation.....	2.2 max	2.5 max	megohms
For grid-resistor-bias operation.....	2.2 max	-	megohms

The duration of the voltage pulse must not exceed 15 per cent of one vertical scanning cycle. In a 525-line, 30-frame system, 15 per cent of one vertical scanning cycle is 2.5 milliseconds.

\* The dc component must not exceed 100 volts.

## CLASS A<sub>1</sub> AMPLIFIER

### Characteristics:

	Unit No.1 Oscillator	Unit No.2 Amplifier	
Plate Voltage.....	200	250	volts
Grid Voltage.....	-7	-8	volts
Amplification Factor.....	21	18	
Plate Resistance (Approx.).....	10500	1100	ohms
Transconductance.....	2000	1400	amperes
Grid Voltage (Approx.) for plate current of 10 $\mu$ A.....	14	-	volts
Plate Current.....	5	20	ma
Plate Current for grid voltage of -10 volts.....	1	-	ma

### AVERAGE CHARACTERISTICS UNIT #1

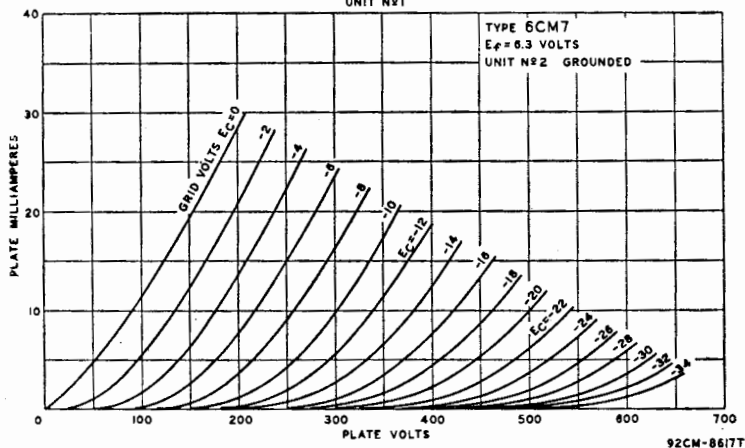

### AVERAGE CHARACTERISTICS UNIT #2

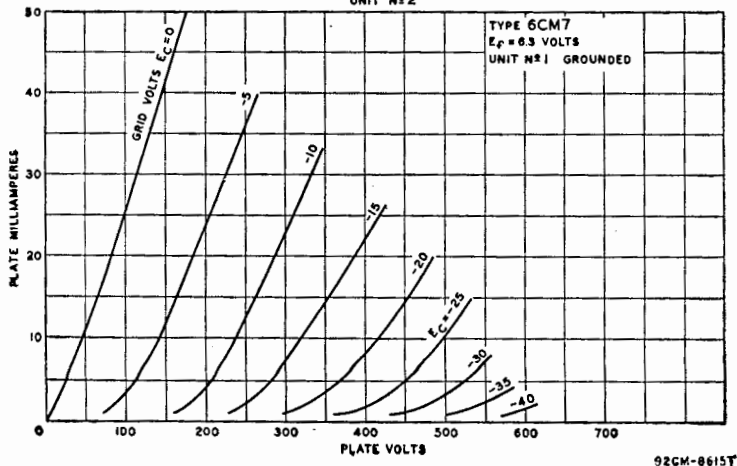

**HIGH-MU TRIODE—  
SHARP-CUTOFF PENTODE**

**6CM8**

Miniature type used in variety of applications in television receivers. The pentode unit is used as an intermediate-frequency-amplifier, a video-amplifier, an agc-amplifier, or as a reactance tube. The triode unit is used in sweep-oscillator, sync-separator, sync-clipper, and phase-splitter circuits. Outline 12, OUTLINES SECTION. Tube requires miniature nine-contact socket and may be mounted in any position.

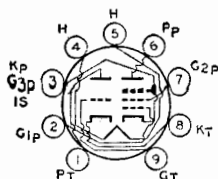

HEATER VOLTAGE (AC/DC).....	6.3	volts
HEATER CURRENT.....	0.45	ampere
HEATER WARM-UP TIME (Average).....	11	seconds

**CLASS A<sub>1</sub> AMPLIFIER**

**Maximum Ratings:**

	<i>Triode Unit</i>	<i>Pentode Unit</i>	
PLATE VOLTAGE.....	300 max	300 max	volts
GRID-NO.2 (SCREEN-GRID) SUPPLY VOLTAGE.....	-	300 max	volts
GRID-NO.2 VOLTAGE.....	See curve page 66		
GRID-NO.1 (CONTROL-GRID) VOLTAGE, Positive-bias value.....	0 max	0 max	volts
PLATE DISSIPATION.....	1 max	2 max	watts
GRID-NO.2 INPUT:			
For grid-No.2 voltages up to 150 volts.....	-	0.5 max	watt
For grid-No.2 voltages between 150 and 300 volts.....	-	See curve page 66	
PEAK HEATER-CATHODE VOLTAGE:			
Heater negative with respect to cathode.....	200 max	200 max	volts
Heater positive with respect to cathode.....	200 <sup>■</sup> max	200 <sup>■</sup> max	volts

**Characteristics:**

	<i>Triode Unit</i>	<i>Pentode Unit</i>	
Plate Supply Voltage.....	250	250	volts
Grid-No.2 Supply Voltage.....	-	150	volts
Grid Voltage.....	-2	-	volts
Cathode-Bias Resistor.....	-	180	ohms
Amplification Factor.....	100	-	
Plate Resistance (Approx.).....	0.05	0.6	megohm
Transconductance.....	2000	6200	amhos
Grid-No.1 Voltage (Approx. for plate current of 10 $\mu$ a).....	-	-8	volts
Plate Current.....	1.8	9.5	ma
Grid-No.2 Current.....	-	2.8	ma

**Maximum Circuit Values:**

	<i>Triode Unit</i>	<i>Pentode Unit</i>	
Grid-No.1-Circuit Resistance:			
For fixed-bias operation.....	0.25 max	0.25 max	megohm
For cathode-bias operation.....	1 max	1 max	megohm

■ The dc component must not exceed 100 volts.

**TWIN-DIODE—HIGH-MU TRIODE**

**6CN7**

Miniature type used as combined horizontal phase detector and reactance tube in television receivers employing series-connected heater strings. The triode unit is used in sync-separator, sync-amplifier, or audio amplifier circuits. Outline 12, OUTLINES SECTION. Tube requires miniature nine-contact socket and may be mounted in any position. For typical operation of triode unit as resistance-coupled amplifier, refer to RESISTANCE-COUPLED AMPLIFIER SECTION. For curve of average plate characteristics for triode unit, refer to type 6T8-A.

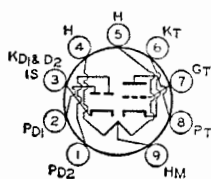

	<i>Series</i>	<i>Parallel</i>	
HEATER ARRANGEMENT:			
HEATER VOLTAGE (AC/DC).....	6.3	3.15	volts
HEATER CURRENT.....	0.3	0.6	ampere
WARM-UP TIME (Average).....	-	11	seconds

**TRIODE UNIT AS CLASS A<sub>1</sub> AMPLIFIER**

**Maximum Ratings, (Design-Maximum Values):**

PLATE VOLTAGE.....	330 <i>max</i>	volts
GRID VOLTAGE, Positive bias value.....	0 <i>max</i>	volts
PLATE DISSIPATION.....	1.1 <i>max</i>	watt
<b>PEAK HEATER-CATHODE VOLTAGE:</b>		
Heater negative with respect to cathode.....	200 <i>max</i>	volts
Heater positive with respect to cathode.....	200 <sup>■</sup> <i>max</i>	volts

**Characteristics:**

Plate Voltage.....	100	250	volts
Grid Voltage.....	-1	-3	volts
Amplification Factor.....	70	70	
Plate Resistance (Approx.).....	54000	58000	ohms
Transconductance.....	1300	1200	μmhos
Plate Current.....	0.8	1	ma

**DIODE UNITS**

**Maximum Ratings:**

PLATE CURRENT (Each Unit).....	5.5 <i>max</i>	ma
<b>PEAK HEATER-CATHODE VOLTAGE:</b>		
Heater negative with respect to cathode.....	200 <i>max</i>	volts
Heater positive with respect to cathode.....	200 <sup>■</sup> <i>max</i>	volts

■ The dc component must not exceed 100 volts.

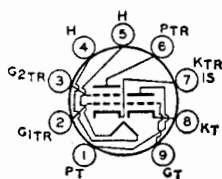

**MEDIUM-MU TRIODE—  
SHARP-CUTOFF TETRODE**

6CQ8

Miniature type used in a wide variety of applications in color and black-and-white television receivers employing series-connected heater strings. Especially useful as combined

vlf oscillator and mixer in tuners of television receivers utilizing an intermediate frequency in the order of 40 megacycles per second. The tetrode unit is used as a mixer, video if amplifier, or sound if amplifier tube. The triode unit is used in vlf oscillator, phase-splitter, sync-clipper, sync-separator, and rf amplifier circuits. Outline 12, OUTLINES SECTION. Tube requires miniature nine-contact socket and may be mounted in any position.

HEATER VOLTAGE (AC/DC).....	6.3	volts
HEATER CURRENT.....	0.45	ampere
HEATER WARM-UP TIME (Average).....	11	seconds

	<i>Without External Shield</i>	<i>With External Shield<sup>†</sup></i>	
<b>DIRECT INTERELECTRODE CAPACITANCES:</b>			
<b>Triode Unit:</b>			
Grid to Plate.....	1.8	1.8	μf
Grid to Cathode and Heater.....	2.7	2.7	μf
Plate to Cathode and Heater.....	0.4	1.2	μf
<b>Tetrode Unit:</b>			
Grid No.1 to Plate.....	0.019 <i>max</i>	0.015 <i>max</i>	μf
Grid No.1 to Cathode, Heater, Grid No.2 and Internal Shield.....	5.0	5.0	μf
Plate to Cathode, Heater, Grid No.2, and Internal Shield.....	2.5	3.3	μf
Tetrode Plate to Triode Plate.....	0.07 <i>max</i>	0.01 <i>max</i>	μf
Heater to Cathode (Each Unit).....	3.0	3.0†	μf

■ With external shield connected to cathode of unit under test.

† With external shield connected to ground.

**Characteristics:**

	<i>Triode Unit</i>	<i>Tetrode Unit</i>	
Plate-Supply Voltage.....	125	125	volts
Grid-No.2 Supply Voltage.....	-	125	volts
Grid-No.1 Voltage.....	-	-1	volts
Cathode-Bias Resistor.....	56	-	ohms
Amplification Factor.....	40	-	
Plate Resistance (Approx.).....	5000	140000	ohms
Transconductance.....	8000	5800	μmhos
Grid-No.1 Voltage (Approx.) for plate current of 100μa.....	-7	-7	volts
Plate Current.....	15	12	ma
Grid-No.2 Current.....	-	4.2	ma

**CLASS A<sub>1</sub> AMPLIFIER**

<i>Maximum Ratings, (Design-Maximum Values):</i>	<i>Triode Unit</i>	<i>Tetrode Unit</i>	
PLATE VOLTAGE.....	330 max	330 max	volts
GRID-NO.2 (SCREEN-GRID) SUPPLY VOLTAGE.....	-	330 max	volts
GRID-NO.2 VOLTAGE.....	-	See curve page 66	
GRID-NO.1 (CONTROL-GRID) VOLTAGE, Positive bias value.....	0 max	0 max	volts
PLATE DISSIPATION.....	3.1 max	3.2 max	watts
GRID-NO.2 INPUT:			
For grid-No.2 voltages up to 165 volts.....	-	0.7 max	watt
For grid-No.2 voltages between 165 and 330 volts.....	-	See curve page 66	
GRID INPUT.....	0.55 max	-	watt
PEAK HEATER-CATHODE VOLTAGE:			
Heater negative with respect to cathode.....	200 max	200 max	volts
Heater positive with respect to cathode.....	200* max	200* max	volts
<b>Maximum Circuit Values:</b>			
Grid-No.1-Circuit Resistance:			
For fixed-bias operation.....	0.5 max	0.25 max	megohm
For cathode-bias operation.....	1.0 max	1.0 max	megohm

\* The dc component must not exceed 100 volts.

**DIODE—REMOTE-CUTOFF  
PENTODE**

**6CR6**

Miniature type used as combined detector and audio amplifier in automobile and ac-operated radio receivers. The diode unit is used as an AM detector, and the pentode unit as an

automatic-volume-controlled audio amplifier. Outline 11, OUTLINES SECTION. Heater volts (ac/dc), 6.3; amperes, 0.3. Except for heater rating, this type is identical with miniature type 12CR6.

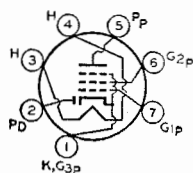

**PENTAGRID AMPLIFIER**

**6CS6**

Miniature type used as a gated amplifier in television receivers. In such service, it may be used as a combined sync separator and sync clipper. Outline 11, OUTLINES SECTION.

Tube requires miniature seven-contact socket and may be mounted in any position.

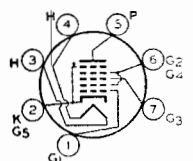

HEATER VOLTAGE (AC/DC).....	6.3	volts
HEATER CURRENT.....	0.3	ampere

**CLASS A<sub>1</sub> AMPLIFIER**

**Characteristics:**

Plate Voltage.....	100	100	volts
Grids-No.2-and-No.4 Voltage.....	30	30	volts
Grid-No.3 Voltage.....	-1	6	volt
Grid-No.1 Voltage.....	0	-1	volt
Plate Resistance (Approx.).....	0.7	1	megohm
Grid-No.3-to-Plate Transconductance.....	1500	-	μmhos
Grid-No.1-to-Plate Transconductance.....	-	1100	μmhos
Plate Current.....	0.8	1.0	ma
Grids-No.2-and-No.4 Current.....	5.5	1.3	ma
Grid-No.3 Voltage (Approx.) for plate current of 50 μa.....	-2.2	-	volts
Grid-No.1 Voltage (Approx.) for plate current of 50 μa.....	-	-2.5	volts

**GATED AMPLIFIER SERVICE**

**Maximum Ratings:**

PLATE VOLTAGE.....	300 max	volts
GRIDS-NO.2-AND-NO.4 SUPPLY VOLTAGE.....	300 max	volts
GRIDS-NO.2-AND-NO.4 VOLTAGE.....	See curve page 66	
PLATE DISSIPATION.....	1 max	watt
GRIDS-NO.2-AND-NO.4 INPUT:		
For grids-No.2-and-No.4 voltages up to 150 volts.....	1 max	watt
For grids-No.2-and-No.4 voltages between 150 and 300 volts.....	See curve page 66	
CATHODE CURRENT.....	14 max	ma
PEAK HEATER-CATHODE VOLTAGE:		
Heater negative with respect to cathode.....	200 max	volts
Heater positive with respect to cathode.....	200* max	volts

**Maximum Circuit Values:**

Grid-No.1-Circuit Resistance.....	0.47 max	megohm
Grid-No.3-Circuit Resistance.....	2.2 max	megohms

■The dc component must not exceed 100 volts

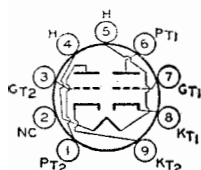

**MEDIUM-MU DUAL TRIODE**

Miniature type used as combined vertical deflection oscillator and vertical deflection amplifier in television receivers employing series-connected heater strings. Unit No.1 is used as a

**6CS7**

conventional blocking oscillator in vertical deflection circuits, and unit No.2 as a vertical deflection amplifier. Outline 14, OUTLINES SECTION. Tube requires miniature nine-contact socket and may be mounted in any position.

HEATER VOLTAGE.....	6.3	volts
HEATER CURRENT.....	0.6	ampere
HEATER WARM-UP TIME (Average).....	11	seconds

**CLASS A<sub>1</sub> AMPLIFIER**

Characteristics:	Unit No. 1	Unit No. 2	
Plate Voltage.....	250	250	volts
Grid Voltage.....	-8.5	-10.5	volts
Amplification Factor.....	17	15.5	
Plate Resistance (Approx.).....	7700	3450	ohms
Transconductance.....	2200	4500	μmhos
Grid Voltage (Approx.) for plate current of 10 μa.....	-24	-	volts
Grid Voltage (Approx.) for plate current of 50 μa.....	-	-22	volts
Plate Current.....	10.5	19	ma
Plate Current for grid voltage of -16 volts.....	-	3	ma

**VERTICAL DEFLECTION OSCILLATOR AND AMPLIFIER**

*For operation in a 525-line, 30-frame system*

Maximum Ratings:	Unit No. 1 Oscillator	Unit No. 2 Amplifier	
DC PLATE VOLTAGE.....	500 max	500 max	volts
PEAK POSITIVE-PULSE PLATE VOLTAGE† (Absolute Maximum).....	-	2200 <sup>■</sup> max	volts
PEAK NEGATIVE-PULSE GRID VOLTAGE.....	-400 max	-250 max	volts
PEAK CATHODE CURRENT.....	70 max	105 max	ma
AVERAGE CATHODE CURRENT.....	20 max	30 max	ma
PLATE DISSIPATION.....	1.25 max	6.5 max	watts
PEAK HEATER-CATHODE VOLTAGE:			
Heater negative with respect to cathode.....	200 max	200 max	volts
Heater positive with respect to cathode.....	200 <sup>■</sup> max	200 <sup>■</sup> max	volts

**Maximum Circuit Values:**

Grid-Circuit Resistance.....	2.2 max	2.2 max	megohms
------------------------------	---------	---------	---------

† The duration of the voltage pulse must not exceed 15 per cent of one vertical scanning cycle. In a 525-line, 30-frame system, 15 per cent of one vertical scanning cycle is 2.5 milliseconds.

\* Under no circumstances should this absolute value be exceeded.

■ The dc component must not exceed 100 volts.

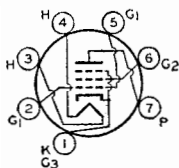

**BEAM POWER TUBE**

Miniature type used in the audio output stage of television receivers. Outline 13, OUTLINES SECTION. Tube requires miniature seven-contact socket and may be mounted in any position.

**6CU5**

HEATER VOLTAGE (AC/DC).....	6.3	volts
HEATER CURRENT.....	1.2	amperes
DIRECT INTERELECTRODE CAPACITANCES (Approx.):		
Grid No.1 to Plate.....	0.6	μμf
Grid No.1 to Cathode, Heater, Grid No.2, and Grid No.3.....	13	μμf
Plate to Cathode, Heater, Grid No.2, and Grid No.3.....	8.5	μμf

**CLASS A<sub>1</sub> AMPLIFIER**

**Maximum Ratings, (Design-Maximum Values):**

PLATE VOLTAGE.....	150 max	volts
GRID-NO.2 (SCREEN-GRID) VOLTAGE.....	117 max	volts
GRID-NO.1 (CONTROL-GRID) VOLTAGE, Positive bias value.....	0 max	volts
PLATE DISSIPATION.....	7 max	watts
GRID-NO.2 INPUT.....	1.4 max	watts
<b>PEAK HEATER-CATHODE VOLTAGE:</b>		
Heater negative with respect to cathode.....	200 max	volts
Heater positive with respect to cathode.....	200 max	volts
BULB TEMPERATURE (At hottest point).....	220 max	°C

■ The dc component must not exceed 100 volts.

**Typical Operation:**

Plate Voltage.....	120	volts
Grid-No.2 Voltage.....	110	volts
Grid-No.1 Voltage.....	8	volts
Peak AF Grid-No.1 Voltage.....	8	volts
Zero-Signal Plate Current.....	19	ma
Maximum-Signal Plate Current.....	50	ma
Zero-Signal Grid-No.2 Current.....	4	ma
Maximum-Signal Grid-No.2 Current.....	8.5	ma
Plate Resistance (Approx.).....	19000	ohms
Transconductance.....	7500	amhos
Load Resistance.....	2500	ohms
Total Harmonic Distortion.....	10	per cent
Maximum-Signal Power Output.....	2.3	watts

**Maximum Circuit Values:**

Grid-No.1-Circuit Resistance:		
For fixed-bias operation.....	0.1 max	megohm
For cathode-bias operation.....	0.5 max	megohm

**6CU6**

Refer to type 6BQ6-GTB/6CU6

**MEDIUM-MU TRIODE—  
SHARP-CUTOFF PENTODE**

**6CU8**

Miniature type used in a wide variety of applications in color and black-and-white television receivers employing series-connected heater strings. The pentode unit is used as an

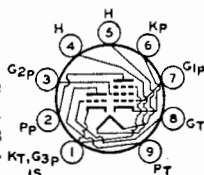

if amplifier, a video amplifier, an agc amplifier, and a reactance tube. The triode unit is used in low-frequency oscillator, sync-separator, sync-clipper, and phase-splitter circuits. Outline 12, OUTLINES SECTION. Tube requires miniature nine-contact socket and may be mounted in any position. For curves of plate characteristics for pentode unit, refer to type 6AN8.

HEATER VOLTAGE (AC/DC).....	6.3	volts
HEATER CURRENT.....	0.45	ampere
HEATER WARM-UP TIME (Average).....	11	seconds

**DIRECT INTERELECTRODE CAPACITANCES:**

<b>Triode Unit:</b>		
Grid to Plate.....	1.6	μf
Grid to Cathode, Heater, Pentode Grid No.3, and Internal Shield.....	1.9	μf
Plate to Cathode, Heater, Pentode Grid No.3, and Internal Shield.....	1.6	μf
<b>Pentode Unit:</b>		
Grid No.1 to Plate.....	0.025 max	μf
Grid No.1 to Cathode, Heater, Grid No.2, Grid No.3, Triode Cathode, and Internal Shield.....	7	μf
Plate to Cathode, Heater, Grid No.2, Grid No.3, Triode Cathode, and Internal Shield.....	2.4	μf
Pentode Grid No.1 to Triode Plate.....	0.03 max	μf
Pentode Plate to Triode Plate.....	0.07 max	μf

**CLASS A<sub>1</sub> AMPLIFIER**

**Maximum Ratings, (Design-Maximum Values):**

PLATE VOLTAGE.....	330 max	330 max	volts
GRID-NO.2 SUPPLY VOLTAGE.....	-	330 max	volts
GRID-NO.2 (SCREEN-GRID) VOLTAGE.....	-	See curve page 66	
GRID-NO.1 (CONTROL-GRID) VOLTAGE, Positive-bias value.....	0 max	0 max	volts
PLATE DISSIPATION.....	2.8 max	2.3 max	watts



**GRID-NO.2 INPUT:**

For grid-No.2 voltages up to 165 volts.....	-	0.55 max	watt
For grid-No.2 voltages between 165 and 330 volts.....	-	See curve page 66	

**PEAK HEATER-CATHODE VOLTAGE:**

Heater negative with respect to cathode.....	200 max	200 max	volts
Heater positive with respect to cathode.....	200 <sup>o</sup> max	200 <sup>o</sup> max	volts

**Characteristics:**

Plate Supply Voltage.....	125	125	volts
Grid-No.2 Supply Voltage.....	-	125	volts
Grid-No.1 Voltage.....	-1	-	volts
Cathode-Bias Resistor.....	-	56	ohms
Amplification Factor.....	24	-	
Plate Resistance (Approx.).....	4100	170000	ohms
Transconductance.....	5800	7800	$\mu$ mhos
Grid-No.1 Voltage (Approx.) for plate current of 20 $\mu$ a.....	-19	-8	volts
Plate Current.....	17	12	ma
Plate Current for grid-No.1 voltage of -3 volts and cathode resistor of 0 ohms.....	-	-1.6	ma
Grid-No.2 Current.....	-	3.8	ma

<sup>o</sup> The dc component must not exceed 100 volts.

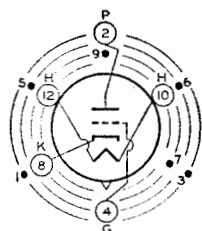

INDEX=LARGE LUG  
●=PIN CUT OFF

## HIGH-MU TRIODE

Nuvistor type used as a grounded-cathode, neutralized rf amplifier in vhf tuners of television and FM receivers. Outline 7A, OUTLINES SECTION. Tube requires nuvistor socket and may be operated in any position.

# 6CW4

HEATER VOLTAGE (AC/DC).....	6.3	volts
HEATER CURRENT.....	0.13	amp
<b>DIRECT INTERELECTRODE CAPACITANCES (Approx.):</b>		
Grid to Plate.....	0.92	$\mu$ f
Grid to Cathode, Heater, and Shell.....	4.1	$\mu$ f
Plate to Cathode, Heater, and Shell.....	1.7	$\mu$ f
Plate to Cathode.....	0.18	$\mu$ f
Heater to Cathode.....	1.3	$\mu$ f

### CLASS A<sub>1</sub> AMPLIFIER

**Maximum Ratings, (Design-Maximum Values):**

PLATE SUPPLY VOLTAGE.....	300 <sup>o</sup> max	volts
PLATE VOLTAGE.....	125 max	volts
<b>GRID VOLTAGE:</b>		
Negative-bias value.....	55 max	volts
Peak positive value.....	0 max	volts
PLATE DISSIPATION.....	1 max	watt
CATHODE CURRENT.....	15 max	ma
<b>PEAK HEATER-CATHODE VOLTAGE:</b>		
Heater negative with respect to cathode.....	100 max	volts
Heater positive with respect to cathode.....	100 max	volts

**Characteristics and Typical Operation:**

Plate Supply Voltage.....	110	70	volts
Grid Supply Voltage.....	0	0	volts
Cathode-Bias Resistor.....	130	-	ohms
Grid Resistor.....	-	47000	ohms
Amplification Factor.....	62	68	
Plate Resistance (Approx.).....	6300	5440	ohms
Transconductance.....	9800	12500	$\mu$ mhos
Grid Voltage (Approx.) for plate $\mu$ a=10.....	-4	-	volts
Plate Current.....	7.6	8	ma

**Maximum Circuit Values:**

<b>Grid-Circuit Resistance:■</b>		
For fixed-bias operation.....	0.5 max	megohms
For cathode-bias operation.....	2.2 max	megohms

<sup>o</sup> A plate supply voltage of 300 volts may be used provided that a sufficiently large resistor is used in the plate circuit to limit the plate dissipation to one watt under any condition of operation.

■ For operation at metal-shell temperatures up to 125° C.

AVERAGE PLATE CHARACTERISTICS

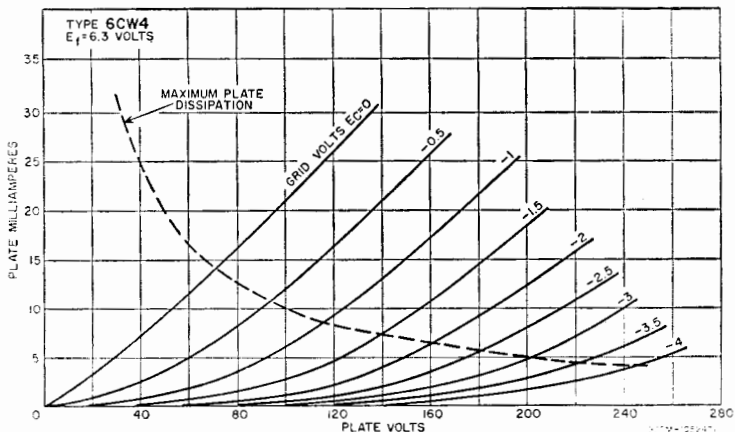

**MEDIUM-MU TRIODE—  
SHARP-CUTOFF PENTODE**

**6CX8**

Miniature type used in television receiver applications. Pentode unit is used as video amplifier; triode unit is used in sound intermediate-frequency amplifier, sweep-oscillator, sync-sep-

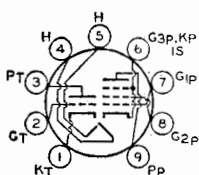

arator, sync-amplifier, and sync-clipper circuits. Outline 14, OUTLINES SECTION. Tube requires miniature nine-contact socket and may be mounted in any position.

HEATER VOLTAGE (AC/DC).....	6.3	volts
HEATER CURRENT.....	0.75	ampere

**CLASS A<sub>1</sub> AMPLIFIER**

**Maximum Ratings, (Design-Maximum Values):**

	Triode Unit	Pentode Unit	
PLATE VOLTAGE.....	330 max	330 max	volts
GRID-NO.2 (SCREEN-GRID) SUPPLY VOLTAGE.....	-	330 max	volts
GRID-NO.2 VOLTAGE.....	-	See curve page 66	
GRID-NO.1 (CONTROL-GRID) VOLTAGE, positive-bias value.....	0 max	0 max	volts
PLATE DISSIPATION.....	2 max	5 max	watts
GRID-NO.2 INPUT:			
For grid-No.2 voltages up to 165 volts.....	-	1.1 max	watts
For grid-No.2 voltages between 165 and 330 volts.....		See curve page 66	
PEAK HEATER-CATHODE VOLTAGE:			
Heater negative with respect to cathode.....	200 max	200 max	volts
Heater positive with respect to cathode.....	200 <sup>■</sup> max	200 <sup>■</sup> max	volts

**Characteristics:**

Plate Supply Voltage.....	150	200	volts
Grid-No.2 Supply Voltage.....	-	125	volts
Cathode-Bias Resistor.....	150	68	ohms
Amplification Factor.....	40	-	
Plate Resistance (Approx.).....	8700	70000	ohms
Transconductance.....	4600	10000	μmhos
Grid-No.1 Voltage (Approx.) for plate current of 100 μa.....	-5	-8.5	volts
Plate Current.....	9.2	24	ma
Grid-No.2 Current.....	-	5.2	ma

**Maximum Circuit Values:**

Grid-No.1-Circuit Resistance:			
For fixed-bias operation.....	0.5 max	0.25 max	megohm
For cathode-bias operation.....	1 max	1 max	megohm

■ The dc component must not exceed 100 volts.

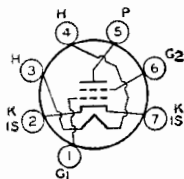

**SHARP-CUTOFF TETRODE**

Miniature type used as rf amplifier in vhf tuners of television receivers. Outline 11, OUTLINES SECTION. Tube requires miniature seven-contact socket and may be mounted in any position.

**6CY5**

HEATER VOLTAGE (AC/DC).....	6.3	volts
HEATER CURRENT.....	0.2	ampere
DIRECT INTERELECTRODE CAPACITANCES (Approx.):*		
Grid-No.1 to Plate.....	0.03	$\mu\text{f}$
Grid-No.1 to Cathode, Heater, Grid No.2, and Internal Shield.....	4.5	$\mu\text{f}$
Plate to Cathode, Heater, Grid No.2, and Internal Shield.....	3	$\mu\text{f}$

\* With external shield connected to cathode.

**CLASS A<sub>1</sub> AMPLIFIER**

Maximum Ratings, (Design-Maximum Values):

PLATE VOLTAGE.....	180 max	volts
GRID-NO.2 (SCREEN-GRID) SUPPLY VOLTAGE.....	180 max	volts
GRID-NO.2 VOLTAGE.....	See curve page 66	
GRID-NO.1 (CONTROL-GRID) VOLTAGE, Positive bias value.....	0 max	volts
CATHODE CURRENT.....	20 max	ma
GRID-NO.2 INPUT:		
For grid-No.2 voltages up to 90 volts.....	0.5 max	watt
For grid-No.2 voltages between 90 and 180 volts.....	See curve page 66	
PLATE DISSIPATION.....	2 max	watts
PEAK HEATER-CATHODE VOLTAGE:		
Heater negative with respect to cathode.....	100 max	volts
Heater positive with respect to cathode.....	100 max	volts

**Characteristics:**

Plate Voltage.....	125	volts
Grid-No.2 Voltage.....	80	volts
Grid-No.1 Voltage.....	-1	volt
Plate Resistance (Approx.).....	0.1	megohm
Transconductance.....	8000	$\mu\text{mhos}$
Plate Current.....	10	ma
Grid-No.2 Current.....	1.5	ma
Grid-No.1 Voltage (Approx.) for plate current of 20 $\mu\text{a}$ .....	-6	volts

**Maximum Circuit Value:**

Grid-No.1-Circuit Resistance.....	0.5 max	megohm
-----------------------------------	---------	--------

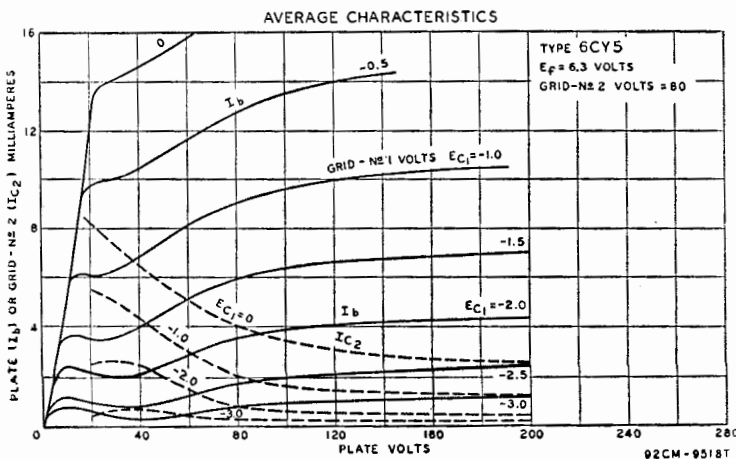

### DUAL TRIODE

# 6CY7

Miniature type used as combined vertical oscillator and vertical deflection amplifier in television receivers. Unit No.1 is a high- $\mu$  triode unit used as a blocking oscillator in

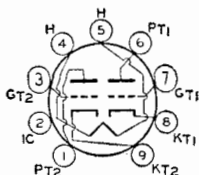

vertical deflection circuits, and unit No.2 is a low- $\mu$  triode unit used as a vertical deflection amplifier. Outline 14, OUTLINES SECTION. Tube requires miniature nine-contact socket and may be mounted in any position.

HEATER VOLTAGE (AC/DC).....	6.3	volts
HEATER CURRENT.....	0.75	ampere

#### VERTICAL DEFLECTION OSCILLATOR AND AMPLIFIER

For operation in a 525-line, 30-frame system

##### Maximum Ratings, (Design-Maximum Values):

	Unit No.1 Oscillator	Unit No.2 Amplifier	
DC PLATE VOLTAGE.....	350 max	350 max	volts
PEAK POSITIVE-PULSE PLATE VOLTAGE.....	-	1800 max	volts
PEAK NEGATIVE-PULSE GRID VOLTAGE.....	400 max	250 max	volts
PEAK CATHODE CURRENT.....	-	120 max	ma
AVERAGE CATHODE CURRENT.....	-	35 max	ma
PLATE DISSIPATION.....	1 max	5.5 max	watts
<b>PEAK HEATER-CATHODE VOLTAGE:</b>			
Heater negative with respect to cathode.....	200 max	200 max	volts
Heater positive with respect to cathode.....	200 max	200 max	volts

##### Maximum Circuit Values:

Grid-Circuit Resistance.....	2.2 max	2.2 max	megohms
------------------------------	---------	---------	---------

\* The duration of the voltage pulse must not exceed 15 per cent of one vertical scanning cycle. In a 525-line, 30-frame system, 15 per cent of one vertical scanning cycle is 2.5 milliseconds.

■ The dc component must not exceed 100 volts.

† For cathode-bias operation.

#### CLASS A<sub>1</sub> AMPLIFIER

##### Characteristics:

	Unit No.1	Unit No.2	
Plate Supply Voltage.....	250	150	volts
Grid Voltage.....	-3	-	volts
Cathode-Bias Resistor.....	-	620	ohms
Amplification Factor.....	68	5	
Plate Resistance (Approx.).....	52000	920	ohms
Transconductance.....	1300	5400	$\mu$ mhos
Grid Voltage (Approx.) for plate current of 10 $\mu$ a.....	-5.5	-	volts
Grid Voltage (Approx.) for plate current of 200 $\mu$ a.....	-	-40	volts
Plate Current.....	1.2	30	ma
Plate Current for grid voltage of -30 volts.....	-	3.5	ma

### BEAM POWER TUBE

# 6CZ5

Miniature type used as a vertical deflection amplifier in high-efficiency deflection circuits of television receivers utilizing picture tubes having diagonal deflection angles of 110 degrees

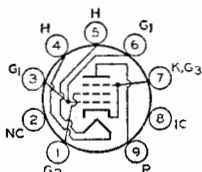

and operating at ultrahigh voltages up to 18 kilovolts. Also used in the audio output stage of television and radio receivers. This type has a controlled heater warm-up time for use in receivers employing series-connected heater strings. Outline 18, OUTLINES SECTION. Tube requires miniature nine-contact socket and may be mounted in any position.

HEATER VOLTAGE (AC/DC) .....	6.3	volts
HEATER CURRENT .....	0.45	amperes
HEATER WARM-UP TIME (Average) .....	11	seconds
<b>DIRECT INTERELECTRODE CAPACITANCES:</b>		
Grid No.1 to Plate .....	0.4 max	$\mu\text{f}$
Grid No.1 to Cathode, Heater, Grid No.2, and Grid No.3 .....	9	$\mu\text{f}$
Plate to Cathode, Heater, Grid No.2, and Grid No.3 .....	6	$\mu\text{f}$
PLATE RESISTANCE (Approx.)* .....	0.073	megohm
TRANSCONDUCTANCE* .....	4800	$\mu\text{mhos}$

\* Plate and grid-No.2 volts, 250; grid-No.1 volts, -14; plate ma., 46; grid-No.2 ma., 4.6.

**VERTICAL DEFLECTION AMPLIFIER**

*For operation in a 525-line, 30-frame system*

**Maximum Ratings, (Design-Maximum Values):**

DC PLATE VOLTAGE .....	350 max	volts
PEAK POSITIVE-PULSE PLATE VOLTAGE# .....	2200 max	volts
GRID-NO.2 (SCREEN-GRID) VOLTAGE .....	315 max	volts
PEAK NEGATIVE-PULSE GRID-NO.1 (CONTROL-GRID) VOLTAGE .....	-275 max	volts
PEAK CATHODE CURRENT .....	155 max	ma
AVERAGE CATHODE CURRENT .....	45 max	ma
PLATE DISSIPATION .....	10 max	watts
GRID-NO.2 INPUT .....	2.2 max	watts
<b>PEAK HEATER-CATHODE VOLTAGE:</b>		
Heater negative with respect to cathode .....	200 max	volts
Heater positive with respect to cathode .....	200* max	volts
BULB TEMPERATURE (At hottest point) .....	250 max	$^{\circ}\text{C}$

**Maximum Circuit Values:**

<b>Grid-No.1-Circuit Resistance:</b>		
For fixed-bias operation .....	0.5 max	megohm
For cathode-bias operation .....	1.0 max	megohm

# The duration of the voltage pulse must not exceed 15 per cent of one vertical scanning cycle. In a 525-line, 30-frame system, 15 per cent of one vertical scanning cycle is 2.5 milliseconds.

\* The dc component must not exceed 100 volts.

**REMOTE-CUTOFF PENTODE**

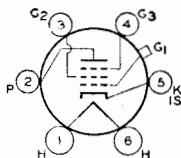

Glass type used in rf and if stages of radio receivers employing avc. Outline 45, OUTLINES SECTION. Tube requires six-contact socket. Except for interelectrode capacitances, this type is identical electrically with type 6U7-G. Refer to type 6SK7 for application information. Heater volts (ac/dc), 6.3; amperes, 0.3. This type is used principally for renewal purposes.

**6D6**

**SHARP-CUTOFF PENTODE**

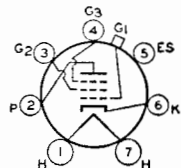

Glass type used as detector or amplifier in radio receivers. Outline 45, OUTLINES SECTION. Heater volts (ac/dc), 6.3; amperes, 0.3. For electrical characteristics, refer to type 6J7. Type 6D7 is a DISCONTINUED type listed for reference only.

**6D7**

**PENTAGRID CONVERTER**

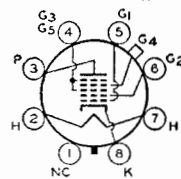

Glass octal type used in superheterodyne circuits. Outline 39, OUTLINES SECTION. Tube requires octal socket. Heater volts (ac/dc), 6.3; amperes, 0.15. Except for interelectrode capacitances and heater rating, the 6D8-G is similar electrically to type 6A8-G. Type 6D8-G is a DISCONTINUED type listed for reference only.

**6D8-G**

**HALF-WAVE VACUUM RECTIFIER**

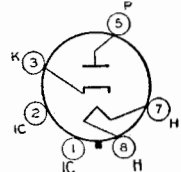

Glass octal type used as damper tube in horizontal-deflection circuits of television receivers. Outline 22, OUTLINES SECTION. Tube requires octal socket and may be mounted in any

**6DA4**

position. May be supplied with pin No.1 omitted. Socket terminals 1, 2, 4, and 6 should not be used as tie points. It is important that this tube, like other power-handling tubes, be adequately ventilated.

HEATER VOLTAGE (AC/DC).....	6.3	volts
HEATER CURRENT.....	1.2	amperes

### DAMPER SERVICE

*For operation in a 525-line, 30-frame system*

#### Maximum Ratings, (Design-Maximum Values):

PEAK INVERSE PLATE CURRENT.....	4400 <i>max</i>	volts
PEAK PLATE CURRENT.....	900 <i>max</i>	ma
DC PLATE CURRENT.....	155 <i>max</i>	ma
PLATE DISSIPATION.....	5.5 <i>max</i>	watts

#### PEAK HEATER-CATHODE VOLTAGE:

Heater negative with respect to cathode.....	4400 <sup>■</sup> <i>max</i>	volts
Heater positive with respect to cathode.....	300 <sup>▲</sup> <i>max</i>	volts

• The duration of the voltage pulse must not exceed 15 per cent of one horizontal scanning cycle. In a 525-line, 30-frame system, 15 per cent of one horizontal scanning cycle is 10 microseconds.

■ The dc component must not exceed 900 volts.

▲ The dc component must not exceed 100 volts.

### BEAM POWER TUBE

## 6DB5

Miniature type used as vertical-deflection-amplifier tube in television receivers. Outline 14, **OUTLINES SECTION**, except all vertical dimensions of this type are 1/8 inch greater.

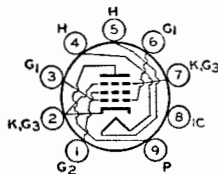

Tube requires miniature nine-contact socket and may be operated in any position. Heater volts (ac/dc), 6.3; amperes, 1.2. Except for heater rating this type is identical with miniature type 12DB5.

### SHARP-CUTOFF PENTODE

## 6DC6

Miniature type used in the gain-controlled picture stages of color television receivers. It is also used as a radio-frequency amplifier in the tuners of such receivers. Outline 11, **OUTLINES SECTION**. Tube requires seven-contact miniature socket and may be mounted in any position.

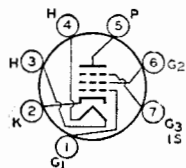

Tube requires seven-contact miniature socket and may be mounted in any position.

HEATER VOLTAGE (AC/DC).....	6.3	volts
HEATER CURRENT.....	0.3	ampere

#### DIRECT INTERELECTRODE CAPACITANCES:

Grid No.1 to Plate.....	0.02 <i>max</i>	μuf
Grid No.1 to Cathode, Heater, Grid No.2, Grid No.3, and Internal Shield.....	6.5	μuf
Plate to Cathode, Heater, Grid No.2, Grid No.3, and Internal Shield....	2	μuf

#### Maximum Ratings:

#### CLASS A<sub>1</sub> AMPLIFIER

PLATE VOLTAGE.....	300 <i>max</i>	volts
GRID NO.3 (SUPPRESSOR-GRID) AND INTERNAL SHIELD.....	Connect to cathode at socket	
GRID-NO.2 SUPPLY VOLTAGE.....	300 <i>max</i>	volts
GRID-NO.2 (SCREEN-GRID) VOLTAGE.....	See curve page 66	
GRID-NO.1 (CONTROL-GRID) VOLTAGE, Positive bias value.....	0 <i>max</i>	volts
PLATE DISSIPATION.....	2 <i>max</i>	watts

#### GRID-NO.2 INPUT:

For grid-No.2 voltages up to 150 volts.....	0.5 <i>max</i>	watt
For grid-No.2 voltages between 150 and 300 volts.....	See curve page 66	

#### PEAK HEATER-CATHODE VOLTAGE:

Heater negative with respect to cathode.....	200 <i>max</i>	volts
Heater positive with respect to cathode.....	200 <sup>◊</sup> <i>max</i>	volts

#### Characteristics:

Plate Supply Voltage.....	200	volts
Grid No.3 and Internal Shield.....	Connected to cathode at socket	
Grid-No.2 Supply Voltage.....	150	volts
Cathode-Bias Resistor.....	180	ohms
Plate Resistance (Approx.).....	0.5	megohm
Transconductance.....	5500	μmhos
Grid-No.1 Voltage (Approx.) for transconductance of 50 μmhos.....	-12.5	volts
Plate Current.....	9	ma
Grid-No.2 Current.....	3	ma

#### Maximum Circuit Values:

Grid-No.1-Circuit Resistance:		
For fixed-bias operation.....	0.25 <i>max</i>	megohm
For cathode-bias operation.....	1.0 <i>max</i>	megohm

◊ The dc component must not exceed 100 volts.

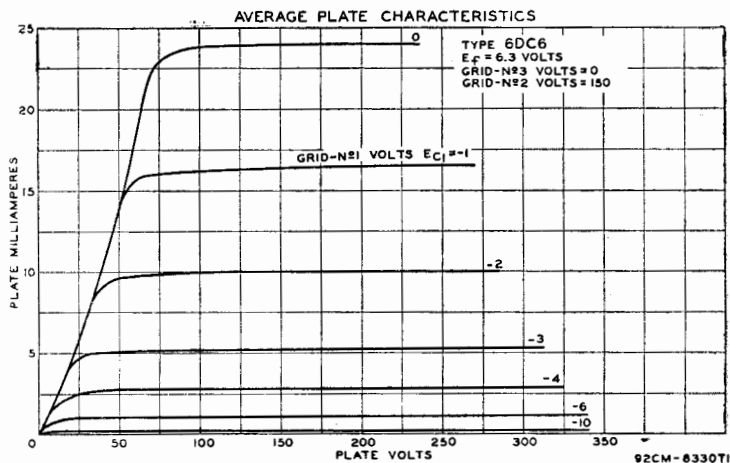

## HALF-WAVE VACUUM RECTIFIER

Glass octal type used as damper tube in horizontal-deflection circuits of television receivers. Outline 29, OUTLINES SECTION. Tube requires octal socket and may be operated in any

position. Socket terminals 1, 2, 4, and 6 should not be used as tie points. It is important that this tube, like other power-handling tubes, be adequately ventilated. For curve of average plate characteristics, see page 67.

HEATER VOLTAGE (AC/DC).....	6.3	volts
HEATER CURRENT.....	1.6	amperes
DIRECT INTERELECTRODE CAPACITANCES (Approx.):		
Plate to Cathode and Heater.....	8.5	μf
Cathode to Plate and Heater.....	11.5	μf
Heater to Cathode.....	4	μf

### DAMPER SERVICE

*For operation in a 525-line, 30-frame system*

Maximum Ratings, (Design-Maximum Values):

PEAK INVERSE PLATE VOLTAGE#.....	5500 max	volts
PEAK PLATE CURRENT.....	1100 max	ma
DC PLATE CURRENT.....	180 max	ma
PLATE DISSIPATION.....	6.5 max	watts
PEAK HEATER-CATHODE VOLTAGE:		
Heater negative with respect to cathode.....	5500 max	volts
Heater positive with respect to cathode.....	300 max	volts

# The duration of the voltage pulse must not exceed 15 per cent of one horizontal scanning cycle. In a 525-line, 30-frame system, 15 per cent of one horizontal scanning cycle is 10 microseconds.

- The dc component must not exceed 900 volts.
- The dc component must not exceed 100 volts.

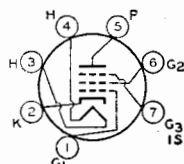

## SHARP-CUTOFF PENTODE

Miniature type used in the gain-controlled picture if stages of television receivers utilizing an intermediate frequency in the order of 40 megacycles per second. Also used as an rf amplifier

in vhf television tuners. This tube features very high transconductance combined with low interelectrode capacitance values, and is provided with separate base pins for grid No.3 and cathode to permit the use of an unbypassed cathode resistor to minimize the effects of regeneration. Outline 11, OUTLINES SECTION. Tube requires miniature seven-contact socket and may be mounted in any position.

HEATER VOLTAGE (AC/DC).....	6.3	volts
HEATER CURRENT.....	0.3	ampere
<b>DIRECT INTERELECTRODE CAPACITANCES:</b>		
Grid No.1 to Plate.....	0.025 max	$\mu\text{f}$
Grid No.1 to Cathode, Heater, Grid No.2, Grid No.3, and Internal Shield.....	6.5	$\mu\text{f}$
Plate to Cathode, Heater, Grid No.2, Grid No.3, and Internal Shield.....	2	$\mu\text{f}$

\* With external shield connected to cathode.

**CLASS A<sub>1</sub> AMPLIFIER**

Maximum Ratings, (Design-Maximum Values):

PLATE VOLTAGE.....	330 max	volts
GRID No.3 (SUPPRESSOR-GRID) AND INTERNAL SHIELD.....	Connect to cathode at socket	
GRID-No.2 (SCREEN-GRID) SUPPLY VOLTAGE.....	330 max	volts
GRID-No.2 VOLTAGE.....	See curve page 66	
GRID-No.1 (CONTROL-GRID) VOLTAGE, Positive bias value.....	0 max	volts
PLATE DISSIPATION.....	2.3 max	watts
<b>GRID-No.2 INPUT:</b>		
For grid-No.2 voltages up to 165 volts.....	0.55 max	watt
For grid-No.2 voltages between 165 and 330 volts.....	See curve page 66	
<b>PEAK HEATER-CATHODE VOLTAGE:</b>		
Heater negative with respect to cathode.....	200 max	volts
Heater positive with respect to cathode.....	200 max	volts

**Characteristics:**

Plate Supply Voltage.....	125	volts
Grid No.3 and Internal Shield.....	Connected to cathode at socket	
Grid-No.2 Supply Voltage.....	125	volts
Cathode-Bias Resistor.....	56	ohms
Plate Resistance (Approx.).....	0.25	megohm
Transconductance.....	8000	$\mu\text{mhos}$
Transconductance for grid-No.1 volts of -5.5 and cathode resistor of 0 ohms.....	700	$\mu\text{mhos}$
Grid-No.1 Voltage (Approx.) for plate current of 20 $\mu\text{a}$ .....	-9	volts
Plate Current.....	15.5	ma
Grid-No.2 Current.....	4.2	ma

■ The dc component must not exceed 100 volts.

**AVERAGE PLATE CHARACTERISTICS**

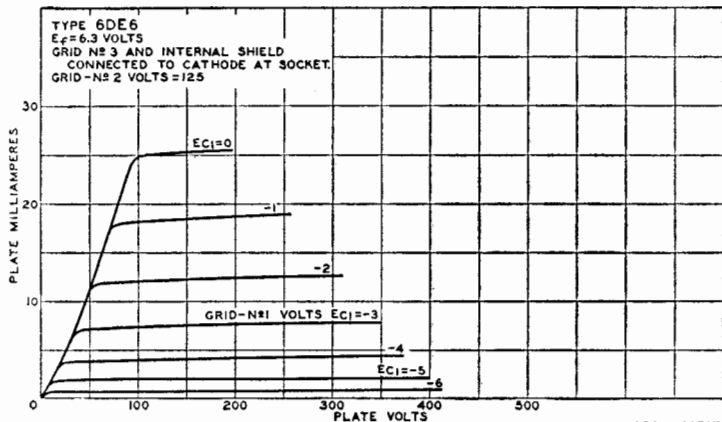

**DUAL TRIODE**

**6DE7**

Miniature type used as combined vertical oscillator and vertical-deflection amplifier in television receivers. Unit No.1 is a medium-mu triode unit used as a blocking oscillator in

vertical-deflection circuits, and unit No.2 is a low-mu triode unit used as a vertical-deflection amplifier. Outline 14, OUTLINES SECTION. Tube requires miniature nine-contact socket and may be mounted in any position. For curve of average plate characteristics, Unit No.2, refer to type 6DR7.

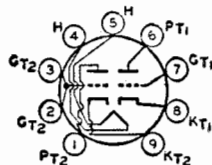



HEATER VOLTAGE (AC/DC).....	6.3	volts	
HEATER CURRENT.....	0.9	ampere	
DIRECT INTERELECTRODE CAPACITANCES (Approx.):	Unit No.1	Unit No.2	
Grid to Plate.....	4	8.5	$\mu\text{f}$
Grid to Cathode and Heater.....	2.2	5.5	$\mu\text{f}$
Plate to Cathode and Heater.....	0.52	1	$\mu\text{f}$

### VERTICAL-DEFLECTION OSCILLATOR AND AMPLIFIER

*For operation in a 525-line, 30-frame system*

<b>Maximum Ratings, (Design-Maximum Values):</b>	Unit No.1	Unit No.2	
	Oscillator	Amplifier	
DC PLATE VOLTAGE.....	330 max	275 max	volts
PEAK POSITIVE-PULSE PLATE VOLTAGE <sup>f</sup> .....	-	1500 max	volts
PEAK NEGATIVE-PULSE GRID VOLTAGE <sup>f</sup> .....	-400 max	-250 max	volts
PEAK CATHODE CURRENT.....	77 max	175 max	ma
AVERAGE CATHODE CURRENT.....	22 max	50 max	ma
PLATE DISSIPATION.....	7 max	7 max	watts
<b>PEAK HEATER-CATHODE VOLTAGE:</b>			
Heater negative with respect to cathode.....	200 max	200 max	volts
Heater positive with respect to cathode.....	200 max	200 max	volts

#### Maximum Circuit Values:

Grid-Circuit Resistance:  
 For grid-resistor bias or cathode-bias operation..... 2.2 max 2.2 max megohms  
<sup>f</sup> The duration of the voltage pulse must not exceed 15 per cent of one vertical scanning cycle. In a 525-line, 30-frame system, 15 per cent of one vertical scanning cycle is 2.5 milliseconds.  
 ■ The dc component must not exceed 100 volts.

### CLASS A<sub>1</sub> AMPLIFIER

<b>Characteristics:</b>	Unit No.1	Unit No.2	
Plate Voltage.....	250	150	volts
Grid Voltage.....	-11	-17.5	volts
Amplification Factor.....	17.5	6	
Plate Resistance (Approx.).....	8750	925	ohms
Transconductance.....	2000	6500	$\mu\text{mhos}$
Plate Current.....	5.5	35	ma
Plate Current for grid voltage of -24 volts.....	-	10	ma
Grid Voltage (Approx.) for plate current of 10 $\mu\text{a}$ .....	-20	-	volts
Grid Voltage (Approx.) for plate current of 50 $\mu\text{a}$ .....	-	-44	volts

AVERAGE PLATE CHARACTERISTICS  
UNIT NR1

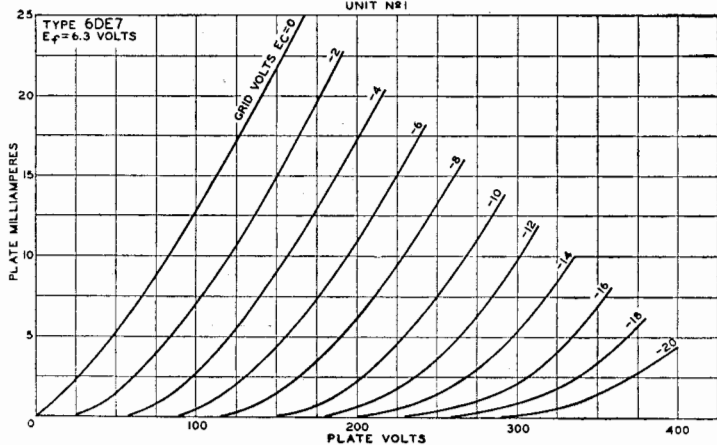

92CM-9988T

### BEAM POWER TUBE

Glass octal type used as output tube in audio-amplifier applications. Outline 22, OUTLINES SECTION. Tube requires octal socket and may be mounted in any position. This type may be supplied with pin 1 omitted.

## 6DG6-GT

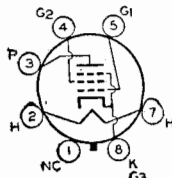

HEATER VOLTAGE (AC/DC).....	6.3	volts
HEATER CURRENT.....	1.2	amperes
<b>DIRECT INTERELECTRODE CAPACITANCES (Approx.):</b>		
Grid No.1 to Plate.....	0.6	$\mu\mu\text{f}$
Grid No.1 to Cathode, Heater, Grid No.2, and Grid No.3.....	15	$\mu\mu\text{f}$
Plate to Cathode, Heater, Grid No.2, and Grid No.3.....	10	$\mu\mu\text{f}$

**CLASS A<sub>1</sub> AUDIO-FREQUENCY POWER AMPLIFIER**

**Maximum Ratings:**

PLATE VOLTAGE.....	200 <i>max</i>	volts
GRID-NO.2 (SCREEN-GRID) VOLTAGE.....	125 <i>max</i>	volts
PLATE DISSIPATION.....	10 <i>max</i>	watts
GRID-NO.2 INPUT.....	1.25 <i>max</i>	watts
<b>PEAK HEATER-CATHODE VOLTAGE:</b>		
Heater negative with respect to cathode.....	200 <i>max</i>	volts
Heater positive with respect to cathode.....	200 <i>max</i>	volts

**Typical Operation:**

Plate Supply Voltage.....	110	200	volts
Grid-No.2 Supply Voltage.....	110	125	volts
Grid-No.1 (Control-Grid) Supply Voltage.....	-7.5	-	volts
Peak AF Grid-No.1 Voltage.....	7.5	8.5	volts
Cathode-Bias Resistor.....	-	180	ohms
Zero-Signal Plate Current.....	49	46	ma
Maximum-Signal Plate Current.....	50	47	ma
Zero-Signal Grid-No.2 Current.....	4	2.2	ma
Maximum-Signal Grid-No.2 Current.....	10	8.5	ma
Plate Resistance (Approx.).....	13000	28000	ohms
Transconductance.....	8000	8000	$\mu\text{mhos}$
Load Resistance.....	2000	4000	ohms
Total Harmonic Distortion.....	10	10	per cent
Maximum-Signal Power Output.....	2.1	3.8	watts

**Maximum Circuit Values:**

<b>Grid-No.1-Circuit Resistance:</b>		
For fixed-bias operation.....	0.1 <i>max</i>	megohm
For cathode-bias operation.....	0.5 <i>max</i>	megohm

\* The dc component must not exceed 100 volts.

## 6DK6

### SHARP-CUTOFF PENTODE

Miniature type used as intermediate-frequency amplifier in television receivers. This tube features high transconductance at low plate and grid-No.2 voltages, combined with low

interelectrode capacitances. Outline 11, OUTLINES SECTION. Tube requires miniature seven-contact socket and may be mounted in any position.

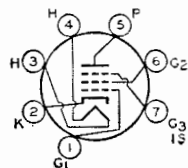

HEATER VOLTAGE (AC/DC).....	6.3	volts
HEATER CURRENT.....	0.3	ampere
<b>DIRECT INTERELECTRODE CAPACITANCES:</b>		
Grid No.1 to Plate.....	0.025 <i>max</i>	$\mu\mu\text{f}$
Grid No.1 to Cathode, Heater, Grid No.2, Grid No.3, and Internal Shield.....	6.3	$\mu\mu\text{f}$
Plate to Cathode, Heater, Grid No.2, Grid No.3, and Internal Shield.....	1.9	$\mu\mu\text{f}$

**CLASS A<sub>1</sub> AMPLIFIER**

**Maximum Ratings, (Design-Maximum Values):**

PLATE VOLTAGE.....	330 <i>max</i>	volts
GRID NO.3 (SUPPRESSOR GRID).....	Connect to cathode at socket	
GRID-NO.2 (SCREEN-GRID) SUPPLY VOLTAGE.....	330 <i>max</i>	volts
GRID-NO.2 VOLTAGE.....	See curve page 66	
GRID-NO.1 (CONTROL-GRID) VOLTAGE, Positive bias value.....	0 <i>max</i>	volts
PLATE DISSIPATION.....	2.3 <i>max</i>	watts
GRID-NO.2 INPUT:		
For grid-No.2 voltages up to 165 volts.....	0.55 <i>max</i>	watt
For grid-No.2 voltages between 165 and 330 volts.....	See curve page 66	
<b>PEAK HEATER-CATHODE VOLTAGE:</b>		
Heater negative with respect to cathode.....	200 <i>max</i>	volts
Heater positive with respect to cathode.....	200 <i>max</i>	volts

Characteristics:

Plate Supply Voltage	125	volts
Grid No.3 and Internal Shield	Connected to cathode at socket	
Grid-No.2 Supply Voltage	125	volts
Cathode-Bias Resistor	56	ohms
Plate Resistance (Approx.)	0.35	megohm
Transconductance	9800	$\mu$ mhos
Grid-No.1 Voltage (Approx.) for plate current of 20 $\mu$ a	-6.5	volts
Plate Current	12	ma
Grid-No 2 Current	3.8	ma

■ The dc component must not exceed 100 volts.

AVERAGE CHARACTERISTICS

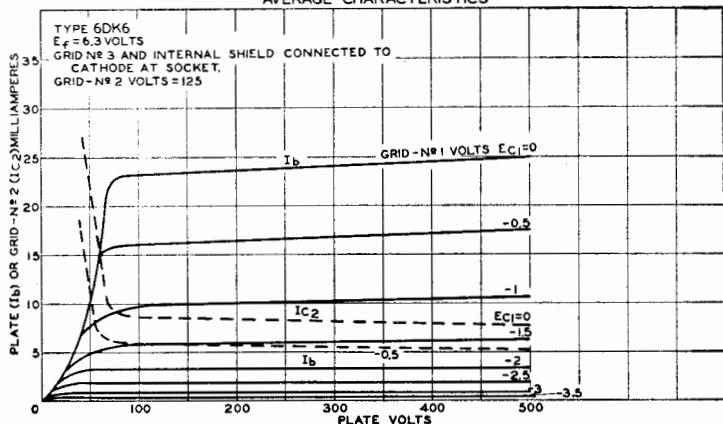

92CM-9851T1

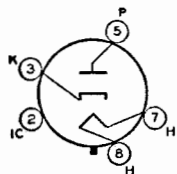

HALF-WAVE VACUUM RECTIFIER

Glass octal type used as damper tube in horizontal-deflection circuits of television receivers. Outline 29, OUT-LINES SECTION. Tube requires octal socket and may be operated in any position. Socket terminals 1, 2, 4, and 6 should not be used as tie points. It is important that this tube, like other power-handling tubes, be adequately ventilated.

6DM4

For curve of average plate characteristics, see page 67.

HEATER VOLTAGE (AC/DC)	6.3	volts
HEATER CURRENT	1.2	amperes
DIRECT INTERELECTRODE CAPACITANCES (Approx.):		
Plate to Cathode and Heater	8.5	$\mu$ f
Cathode to Plate and Heater	11.5	$\mu$ f
Heater to Cathode	4	$\mu$ f

DAMPER SERVICE

For operation in a 525-line, 30-frame system

Maximum Ratings: (Design-Maximum Values):

PEAK INVERSE PLATE VOLTAGE <sup>o</sup>	5000 max	volts
PEAK PLATE CURRENT	1100 max	ma
DC PLATE CURRENT	175 max	ma
PLATE DISSIPATION	6.5 max	watts
PEAK HEATER-CATHODE VOLTAGE:		
Heater negative with respect to cathode	5000 <sup>•</sup> max	volts
Heater positive with respect to cathode	300 <sup>•</sup> max	volts

<sup>o</sup> The duration of the voltage pulse must not exceed 15 per cent of one horizontal scanning cycle. In a 525-line, 30-frame system, 15 per cent of one horizontal scanning cycle is 10 microseconds.

- The dc component must not exceed 900 volts.
- The dc component must not exceed 100 volts.

**BEAM POWER TUBE**

**6DN6**

Glass octal type used as horizontal-deflection amplifier tube in television receivers having low B-supply voltages. Outline 46, OUTLINES SECTION. Tube requires octal socket. Vertical mounting is preferred, but horizontal mounting is permissible if pins 1 and 3 are in vertical plane. Heater volts (ac/dc), 6.3; amperes, 2.5. Type 6DN6 is used principally for renewal purposes.

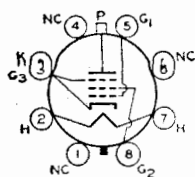

TRANSCONDUCTANCE*	9000	μmhos
PLATE RESISTANCE (Approx.)*	4000	ohms

\* For plate and grid-No.2 volts, 125; grid-No.1 volts, -18; plate ma., 70; grid-No.2 ma., 6.3.

**HORIZONTAL-DEFLECTION AMPLIFIER**

For operation in a 525-line, 30-frame system

**Maximum Ratings:**

DC PLATE VOLTAGE.....	700 max	volts
PEAK POSITIVE-PULSE PLATE VOLTAGE# (Absolute Maximum).....	6600 <sup>■</sup> max	volts
PEAK NEGATIVE-PULSE PLATE VOLTAGE.....	-1500 max	volts
DC GRID-NO.2 (SCREEN-GRID) VOLTAGE.....	175 max	volts
PEAK NEGATIVE-PULSE GRID-NO.1 VOLTAGE.....	-200 max	volts
PEAK CATHODE CURRENT.....	700 max	ma
AVERAGE CATHODE CURRENT.....	200 max	ma
GRID-NO.2 INPUT.....	3 max	watts
PLATE DISSIPATION†.....	15 max	watts
PEAK HEATER-CATHODE VOLTAGE:		
Heater negative with respect to cathode.....	200 max	volts
Heater positive with respect to cathode.....	200 <sup>▲</sup> max	volts
BULB TEMPERATURE (At hottest point).....	225 max	°C

**Maximum Circuit Value:**

Grid-No.1-Circuit Resistance.....	0.47 max	megohm
-----------------------------------	----------	--------

• The duration of the voltage pulse must not exceed 15 per cent of one horizontal scanning cycle. In a 525-line, 30-frame system, 15 per cent of one horizontal scanning cycle is 10 microseconds.  
<sup>■</sup> Under no circumstances should this absolute value be exceeded.  
<sup>†</sup> An adequate bias resistor or other means is required to protect the tube in the absence of excitation.  
<sup>▲</sup> The dc component must not exceed 100 volts.

**MEDIUM-MU DUAL TRIODE**

**6DN7**

Glass octal type used as combined vertical-deflection-oscillator and vertical-deflection-amplifier tube in television receivers. Outline 19, OUTLINES SECTION. Tube requires octal socket and may be mounted in any position. Heater volts (ac/dc), 6.3; amperes, 0.9.

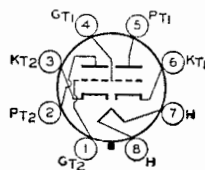

**VERTICAL-DEFLECTION OSCILLATOR AND AMPLIFIER**

For operation in a 525-line, 30-frame system

**Maximum Ratings, (Design-Maximum Values):**

	Unit No.1 Oscillator	Unit No.2 Amplifier	
DC PLATE VOLTAGE.....	350 max	550 max	volts
PEAK POSITIVE-PULSE PLATE VOLTAGE#.....	-	2500 max	volts
PEAK NEGATIVE-PULSE GRID VOLTAGE.....	400 max	250 max	ma
PEAK CATHODE CURRENT.....	-	150 max	ma
AVERAGE CATHODE CURRENT.....	-	50 max	ma
PLATE DISSIPATION.....	1 max	10 max	watts
PEAK HEATER-CATHODE VOLTAGE:			
Heater negative with respect to cathode.....	200 max	200 max	volts
Heater positive with respect to cathode.....	200 <sup>■</sup> max	200 <sup>■</sup> max	volts

**Maximum Circuit Values:**

Grid-Circuit Resistance:		
For fixed-bias operation.....	2.2 max	2.2 max
For cathode-bias operation.....	2.2 max	-

• The duration of the voltage pulse must not exceed 15 per cent of one vertical scanning cycle. In a 525-line, 30-frame system, 15 per cent of one vertical cycle is 2.5 milliseconds.  
<sup>■</sup> The dc component must not exceed 100 volts.

## CLASS A<sub>i</sub> AMPLIFIER

Characteristics:	Unit No.1	Unit No.2	
Plate Voltage.....	250	250	volts
Grid Voltage.....	-8	-9.5	volts
Amplification Factor.....	22.5	15.4	
Plate Resistance (Approx.).....	9000	2000	ohms
Transconductance.....	2500	7700	$\mu$ hos
Plate Current.....	8	41	ma
Grid Voltage (Approx.) for plate current of 10 $\mu$ a.....	-18	-	volts
Grid Voltage (Approx.) for plate current of 50 $\mu$ a.....	-	-23	volts

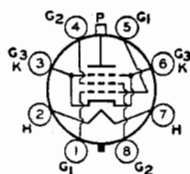

## BEAM POWER TUBE

Glass octal type used as horizontal deflection amplifier in color television receivers. Outline 46, OUT-LINES SECTION. Tube requires octal socket and may be mounted in any position.

# 6DQ5

HEATER VOLTAGE (AC/DC).....	6.3	volts
HEATER CURRENT.....	2.5	amperes
DIRECT INTERELECTRODE CAPACITANCES (Approx):		
Grid No.1 to Plate.....	0.5	$\mu$ f
Grid No.1 to Cathode, Heater, Grid No.2, and Grid No.3.....	23	$\mu$ f
Plate to Cathode, Heater, Grid No.2, and Grid No.3.....	11	$\mu$ f
PLATE RESISTANCE (Approx.)*.....	5500	ohms
TRANSCONDUCTANCE*.....	10500	$\mu$ hos
MU-FACTOR, Grid No.2 to Grid No.1**.....	3.3	

\* For plate volts, 175; grid-No.2 volts, 125; grid-No.1 volts, -25; plate ma., 110; grid-No.2 ma., 5.

\*\* For plate and grid-No.2 volts, 125; grid-No.1 volts, -25.

## HORIZONTAL DEFLECTION AMPLIFIER

*For operation in a 525-line, 40-frame system*

Maximum Ratings, (Design-Maximum Values):

DC PLATE VOLTAGE.....	990 max	volts
PEAK POSITIVE-PULSE PLATE VOLTAGE†.....	6500 max	volts
PEAK NEGATIVE-PULSE PLATE VOLTAGE.....	-1100 max	volts
DC GRID-NO.2 (SCREEN-GRID) VOLTAGE.....	190 max	volts
PEAK NEGATIVE-PULSE GRID-NO.1 (CONTROL-GRID) VOLTAGE.....	-250 max	volts
PEAK CATHODE CURRENT.....	1100 max	ma
AVERAGE CATHODE CURRENT.....	315 max	ma
GRID-NO.2 INPUT.....	3.2 max	watts
PLATE DISSIPATION‡.....	24 max	watts
PEAK HEATER-CATHODE VOLTAGE:		
Heater negative with respect to cathode.....	200 max	volts
Heater positive with respect to cathode.....	200 <sup>o</sup> max	volts
BULB TEMPERATURE (At hottest point).....	220 max	°C

Maximum Circuit Value:

Grid-No.1-Circuit Resistance:	
For grid-resistor-bias operation.....	0.47 max megohm

## AVERAGE CHARACTERISTICS

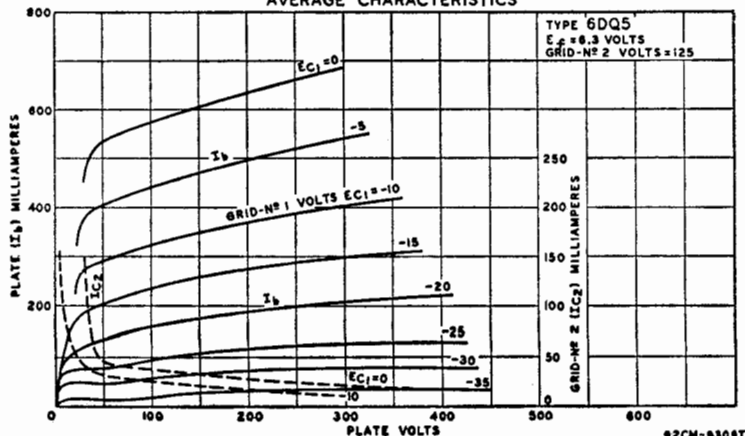

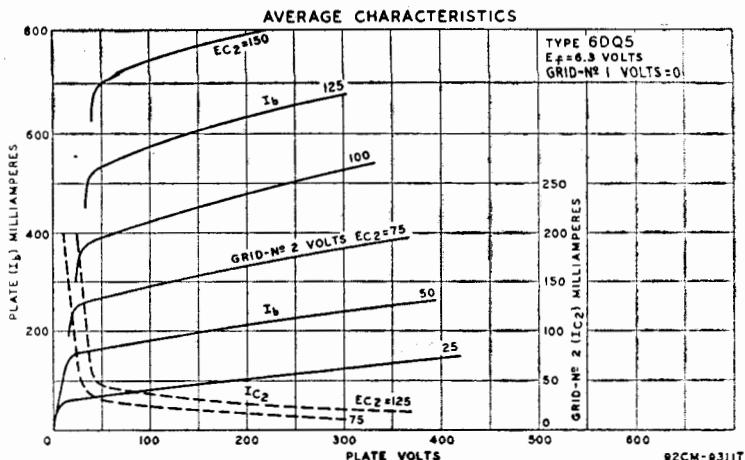

The duration of the voltage pulse must not exceed 15 per cent of one horizontal scanning cycle. In a 525-line, 30-frame system, 15 per cent of one horizontal scanning cycle is 10 microseconds.  
 An adequate bias resistor or other means is required to protect the tube in the absence of excitation.  
 The dc component must not exceed 100 volts.

**BEAM POWER TUBE**

**6DQ6-A  
6DQ6-B**

Glass octal types used as horizontal-deflection-amplifier tubes in high-efficiency deflection circuits of television receivers. Outline 37, OUT-LINESSECTION. Tubes require octal socket and may be mounted in any position. These types may be supplied with pin 1 omitted.

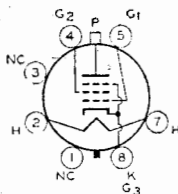

HEATER VOLTAGE (AC/DC).....	6.3	volts
HEATER CURRENT.....	1.2	amperes
DIRECT INTERELECTRODE CAPACITANCES (Approx.)		
Grid No.1 to Plate.....	0.5	μf
Grid No.1 to Cathode, Heater, Grid No.2, and Grid No.3.....	15	μf
Plate to Cathode, Heater, Grid No.2, and Grid No.3.....	7	μf

**CLASS A<sub>1</sub> AMPLIFIER**

Characteristics:	6DQ6-A		6DQ6-B		
Plate Voltage.....	60	250	60	250	volts
Grid-No.2 Voltage.....	150	150	150	150	volts
Grid-No.1 Voltage.....	0	-22.5	0	-22.5	volts
Plate Resistance (Approx.).....	-	20000	-	18000	ohms
Transconductance.....	-	6600	-	7300	ma/volts
Plate Current.....	315°	55	345°	65	ma
Grid-No.2 Current.....	25°	1.5	27°	1.8	ma
Grid-No.1 Voltage (Approx.) for grid-No.2 volts=150, plate ma=1, plate volts=250.....	-	-40	-	-12	volts
plate volts=5000.....	-	-100	-	-100	volts

**HORIZONTAL-DEFLECTION AMPLIFIER**

For operation in a 525-line, 30-frame system

Maximum Ratings, (Design-Maximum Values):	6DQ6-A	6DQ6-B	
DC PLATE-SUPPLY VOLTAGE.....	770 max	770 max	volts
PEAK POSITIVE-PULSE PLATE VOLTAGE.....	6000 max	6500 max	volts
PEAK NEGATIVE-PULSE PLATE VOLTAGE.....	-1500 max	-1500 max	volts
DC GRID-NO.2 (SCREEN-GRID) VOLTAGE.....	220 max	220 max	volts
PEAK NEGATIVE-PULSE GRID-NO.1 VOLTAGE.....	-330 max	-330 max	volts
PEAK CATHODE CURRENT.....	540 max	610 max	ma
AVERAGE CATHODE CURRENT.....	155 max	175 max	ma
GRID-NO.2 INPUT.....	3.6 max	3.6 max	watts
PLATE DISSIPATION.....	18 max	18 max	watts
PEAK HEATER-CATHODE VOLTAGE:			
Heater negative with respect to cathode.....	200 max	200 max	volts
Heater positive with respect to cathode.....	200 <sup>2</sup> max	200 <sup>2</sup> max	volts
BULB TEMPERATURE (At hottest point).....	220 max	220 max	°C

**Maximum Circuit Values:**

- Grid-No.1-Circuit Resistance for grid resistor-bias operation . . . 1 max 1 max megohm
- ° This value can be measured by a method involving a recurrent wave form such that the maximum ratings of the tube will not be exceeded.
- The duration of the voltage pulse must not exceed 15 per cent of one horizontal scanning cycle. In a 525-line, 30-frame system, 15 per cent of one horizontal scanning cycle is 10 microseconds.
- An adequate bias resistor or other means is required to protect the tube in the absence of excitation.
- The dc component must not exceed 100 volts.

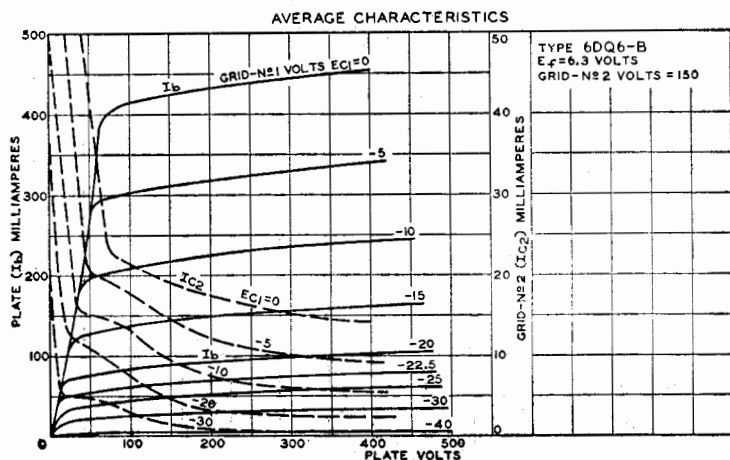

92CM-10555T

**DUAL TRIODE**

Miniature type containing high-mu and low-mu triodes; used as combined vertical-deflection-oscillator and vertical-deflection-amplifier tube in television receivers. Outline 14, OUT-LINES SECTION. Tube requires miniature nine-contact socket and may be operated in any position.

**6DR7**

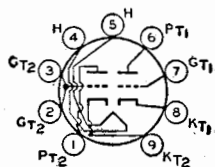

HEATER VOLTAGE (AC/DC).....	6.3	volts	
HEATER CURRENT.....	0.9	ampere	
DIRECT INTERELECTRODE CAPACITANCES (Approx.):	Unit No.1	Unit No.2	
Grid to Plate.....	4.5	8.5	μf
Grid to Cathode and Heater.....	2.2	5.5	μf
Plate to Cathode and Heater.....	0.34	1	μf

**VERTICAL-DEFLECTION OSCILLATOR AND AMPLIFIER**

For operation in a 525-line, 30-frame system

<b>Maximum Ratings, (Design-Maximum Values):</b>	Unit No.1	Unit No.2	
DC PLATE VOLTAGE.....	330 max	275 max	volts
PEAK POSITIVE-PULSE PLATE VOLTAGE <sup>2</sup> .....	-	1500 max	volts
PEAK NEGATIVE-PULSE GRID VOLTAGE.....	-400 max	-250 max	volts
PEAK CATHODE CURRENT.....	70 max	175 max	ma
AVERAGE CATHODE CURRENT.....	20 max	50 max	ma
PLATE DISSIPATION.....	1 max	7 max	watts
PEAK HEATER-CATHODE VOLTAGE:			
Heater negative with respect to cathode.....	200 max	200 max	volts
Heater positive with respect to cathode.....	200 <sup>▲</sup> max	200 <sup>▲</sup> max	volts

**Maximum Circuit Value:**

- Grid-Circuit Resistance:
  - For grid-resistor-bias or cathode-bias operation..... 2.2 max 2.2 max megohms
- <sup>2</sup> The duration of the voltage pulse must not exceed 15 per cent of one vertical scanning cycle. In a 525-line, 30-frame system, 15 per cent of one vertical scanning cycle is 2.5 milliseconds.
- <sup>▲</sup> The dc component must not exceed 100 volts.

## CLASS A<sub>1</sub> AMPLIFIER

### Characteristics:

	Unit No.1	Unit No.2	
Plate Voltage.....	250	150	volts
Grid Voltage.....	-3	-17.5	volts
Amplification Factor.....	68	6	
Plate Resistance (Approx.).....	40000	925	ohms
Transconductance.....	1600	6500	μmhos
Grid Voltage (Approx.) for plate current of 10 μa.....	-5.5	-	volts
Grid Voltage (Approx.) for plate current of 50 μa.....	-	-44	volts
Plate Current.....	1.4	35	ma
Plate Current for grid voltage of -24 volts.....	-	10	ma

AVERAGE PLATE CHARACTERISTICS  
UNIT #1

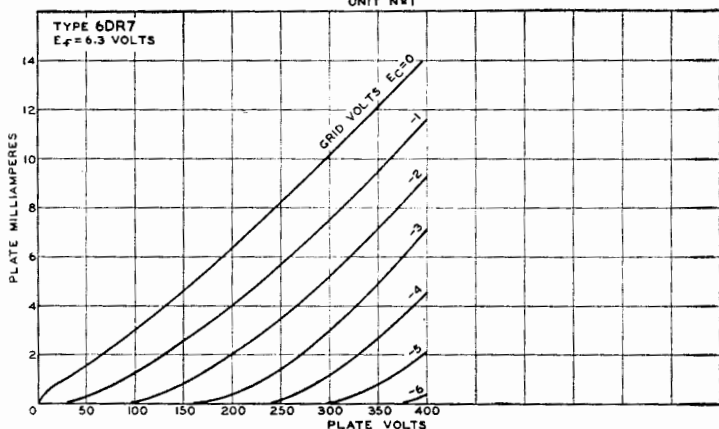

AVERAGE PLATE CHARACTERISTICS  
UNIT #2

92CM-9912T

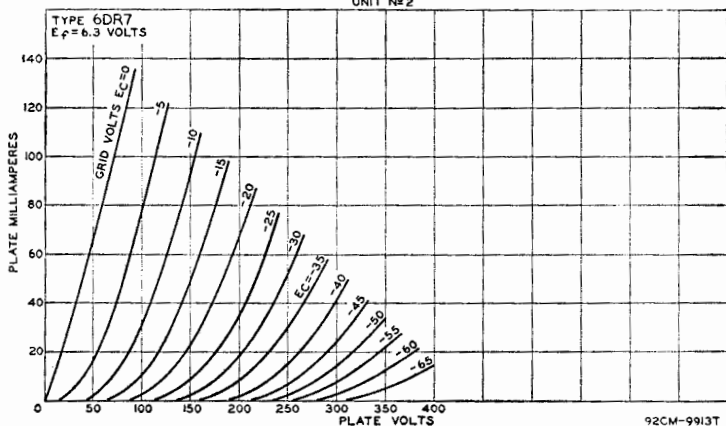

92CM-9913T

## 6DS4

### HIGH-MU TRIODE

Nuvistor type used as grounded-cathode, neutralized rf amplifier in vhf tuners of television and FM receivers. Because of its cutoff characteristics, the 6DS4 is used in circuits intended

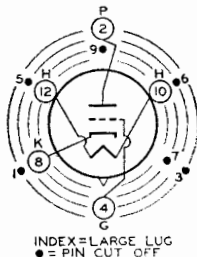



## Technical Data

for weak signal reception. Outline 7A, OUTLINES SECTION. Tube requires nuvistor socket and may be operated in any position.

HEATER VOLTAGE (AC/DC).....	6.3	volts
HEATER CURRENT.....	0.135	ampere
DIRECT INTERELECTRODE CAPACITANCES (Approx.):		
Grid to Plate.....	0.92	$\mu\text{af}$
Grid to Cathode, Heater, and Shell.....	4.1	$\mu\text{af}$
Plate to Cathode, Heater, and Shell.....	1.7	$\mu\text{af}$
Plate to Cathode.....	0.18	$\mu\text{af}$
Heater to Cathode.....	1.3	$\mu\text{af}$

### CLASS A<sub>1</sub> AMPLIFIER

#### Characteristics:

Plate Supply Voltage.....	110	volts
Grid Supply Voltage.....	0	volts
Cathode-Bias Resistor.....	130	ohms
Amplification Factor.....	62	
Plate Resistance (Approx.).....	6900	ohms
Transconductance.....	9000	$\mu\text{mbos}$
Plate Current.....	6.5	ma
Grid Voltage (Approx.) for plate current of 100 $\mu\text{a}$ .....	-5	volts
Grid Voltage (Approx.) for plate current of 10 $\mu\text{a}$ .....	-6.8	volts

#### Maximum Ratings, (Design-Maximum Values):

PLATE SUPPLY VOLTAGE.....	300 <sup>2</sup> max	volts
PLATE VOLTAGE.....	135 max	volts
GRID VOLTAGE, negative-bias value.....	55 max	volts
GRID VOLTAGE, peak positive value.....	0 max	volts
PLATE DISSIPATION.....	1 max	watt
CATHODE CURRENT.....	15 max	ma
PEAK HEATER-CATHODE VOLTAGE:		
Heater negative with respect to cathode.....	100 max	volts
Heater positive with respect to cathode.....	100 max	volts

#### Typical Operation:

Plate Voltage.....	70	volts
Grid Supply Voltage.....	0	volts
Grid Resistor.....	47000	ohms
Amplification Factor.....	68	
Plate Resistance (Approx.).....	5440	ohms
Transconductance.....	12500	$\mu\text{mbos}$
Plate Current.....	8	ma

#### Maximum Circuit Values:

Grid-Circuit Resistance: <sup>1</sup>		
For fixed-bias operation.....	0.5 max	megohm
For cathode-bias operation.....	2.2 max	megohms

<sup>2</sup> A plate supply voltage of 300 volts may be used provided a sufficiently large resistor is used in the plate circuit to limit the plate dissipation to one watt under any condition of operation.

<sup>1</sup> For operation at metal-shell temperatures up to 125°C.

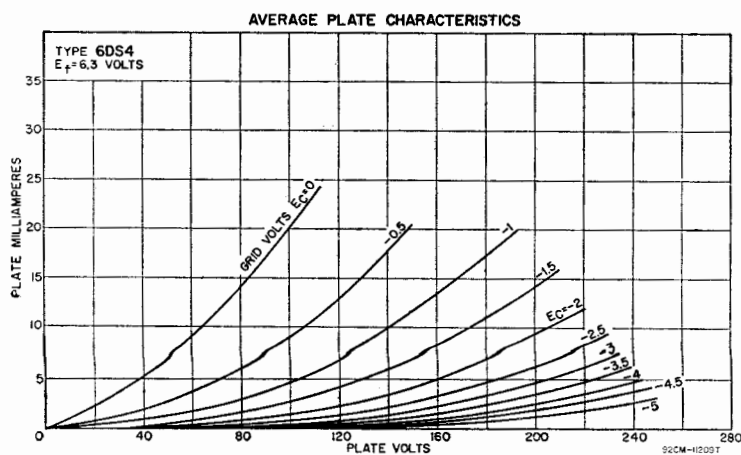

BEAM POWER TUBE

6DS5

Miniature type used in the audio output stages of television and radio receivers. Outline 13, OUTLINES SECTION. Tube requires miniature seven-contact socket and may be mounted in any position.

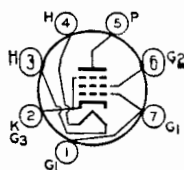

HEATER VOLTAGE (AC/DC) .....	6.3	volts
HEATER CURRENT .....	0.8	ampere
DIRECT INTERELECTRODE CAPACITANCES (Approx.):		
Grid No.1 to Plate .....	0.19	$\mu$ f
Grid No.1 to Cathode, Heater, Grid No.2, and Grid No.3 .....	9.5	$\mu$ f
Plate to Cathode, Heater, Grid No.2, and Grid No.3 .....	6.3	$\mu$ f

CLASS A<sub>1</sub> AMPLIFIER

Maximum Ratings, (Design-Maximum Values):

PLATE VOLTAGE .....	275 <i>max</i>	volts
GRID-NO.2 (SCREEN-GRID) VOLTAGE .....	275 <i>max</i>	volts
GRID-NO.1 (CONTROL-GRID) VOLTAGE, Positive bias value .....	0 <i>max</i>	volts
PLATE DISSIPATION .....	9 <i>max</i>	watts
GRID-NO.2 INPUT .....	2.2 <i>max</i>	watts
PEAK HEATER-CATHODE VOLTAGE:		
Heater negative with respect to cathode .....	200 <i>max</i>	volts
Heater positive with respect to cathode .....	200* <i>max</i>	volts
BULB TEMPERATURE (At hottest point) .....	250 <i>max</i>	°C

Typical Operation and Characteristics:

	Cathode-Bias Operation		Fixed-Bias Operation		
	200	250	200	250	
Plate Supply Voltage .....	200	250	200	250	volts
Grid-No.2 Supply Voltage .....	200	200	200	200	volts
Grid-No.1 Voltage .....	-	-	-7.5	-8.5	volts
Cathode-Bias Resistor .....	180	270	-	-	ohms
Peak AF Grid-No.1 Voltage .....	7.5	9.2	7.5	8.5	volts
Zero-Signal Plate Current .....	34.5	27	35	29	ma
Maximum-Signal Plate Current .....	32.5	25	36	32	ma
Zero-Signal Grid-No.2 Current .....	3.5	3	3	3	ma
Maximum-Signal Grid-No.2 Current .....	9	9	9	10	ma
Plate Resistance (Approx.) .....	28000	28000	28000	28000	ohms
Transconductance .....	6000	5800	6000	5800	$\mu$ mhos
Load Resistance .....	6000	8000	6000	8000	ohms
Total Harmonic Distortion .....	10	10	9	10	per cent
Maximum-Signal Power Output .....	2.8	3.6	3	3.8	watts

Maximum Circuit Values:

Grid-No.1-Circuit Resistance:	
For fixed-bias operation .....	0.1 <i>max</i> megohm
For cathode-bias operation .....	1.0 <i>max</i> megohm

\* The dc component must not exceed 100 volts.

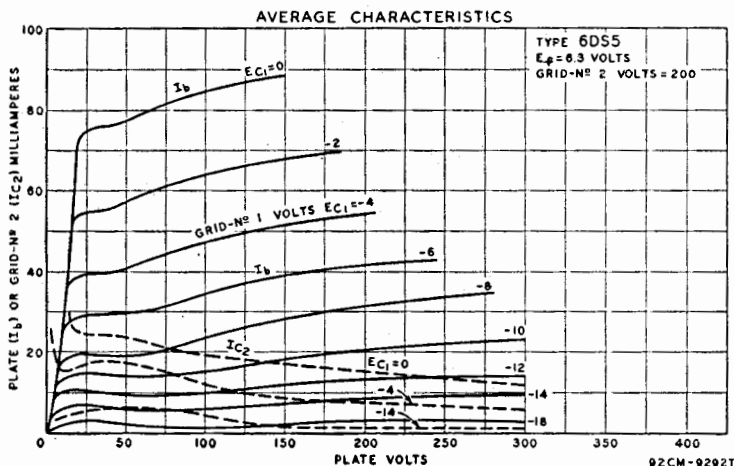

**BEAM POWER TUBE**

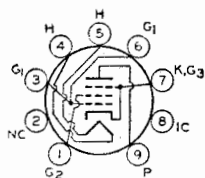

Miniature type used as a vertical-deflection-amplifier tube in television receivers employing 110-degree picture-tube systems. Outline 14, OUTLINES SECTION. Tube requires miniature nine-contact socket and may be operated in any position.

**6DT5**

HEATER VOLTAGE (AC/DC).....	6.3	volts
HEATER CURRENT.....	1.2	amperes
TRANSCONDUCTANCE*.....	6200	ambos

\* For plate and grid-No.2 volts, 250; grid-No.1 volts, -16.5; plate ma., 44; grid-No.2 ma., 1.5.

**VERTICAL-DEFLECTION AMPLIFIER**

For operation in a 525-line, 30-frame system

Maximum Ratings, (Design-Maximum Values):

DC PLATE VOLTAGE.....	315 max	volts
PEAK POSITIVE-PULSE PLATE VOLTAGE#.....	2200 max	volts
GRID-NO.2 (SCREEN-GRID) VOLTAGE.....	285 max	volts
PEAK NEGATIVE-PULSE GRID-NO.1 (CONTROL-GRID) VOLTAGE.....	-250 max	volts
PEAK CATHODE CURRENT.....	190 max	ma
AVERAGE CATHODE CURRENT.....	55 max	ma
PLATE DISSIPATION.....	9 max	watts
GRID-NO.2 INPUT.....	2 max	watts
PEAK HEATER-CATHODE VOLTAGE:		
Heater negative with respect to cathode.....	200 max	volts
Heater positive with respect to cathode.....	200*max	volts

Maximum Circuit Values:

Grid-No.1-Circuit Resistance:		
For fixed-bias operation.....	0.5 max	megohm
For cathode-bias operation.....	1 max	megohm

# The duration of the voltage pulse must not exceed 15 per cent of one vertical scanning cycle. In a 525-line, 30-frame system, 15 per cent of one vertical scanning cycle is 2.5 milliseconds.  
\* The dc component must not exceed 100 volts.

**SHARP-CUTOFF PENTODE**

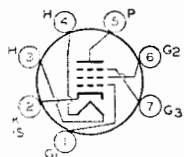

Miniature type used as FM detector in television receivers. Outline 11, OUTLINES SECTION. Tube requires miniature seven-contact socket and may be mounted in any position.

**6DT6**  
**6DT6-A**

HEATER VOLTAGE (AC/DC).....	6.3	volts
HEATER CURRENT.....	0.3	ampere
DIRECT INTERNAL ELECTRODE CAPACITANCES (Approx.)*		
Grid No.1 to Plate.....	0.02	μf
Grid No.1 to Cathode, Heater, Grid No.2, Grid No.3, and Internal Shield.....	5.8	μf
Grid No.3 to Plate.....	1.4†	μf
Grid No.1 to Grid No.3.....	0.1	μf
Grid No.3 to Cathode, Heater, Grid No.1, Grid No.2, and Internal Shield.....	6.1	μf

External shield connected to cathode. †For type 6DT6-A, value is 1.7 μf.

Characteristics:

**CLASS A<sub>1</sub> AMPLIFIER**

	6DT6-A	6DT6	
Plate Supply Voltage.....	150	150	volts
Grid No.3 (Suppressor Grid).....	Connected to cathode at socket		
Grid-No.2 (Screen-Grid) Supply Voltage.....	100	100	volts
Cathode-Bias Resistor.....	560	560	ohms
Plate Resistance (Approx.).....	0.15	0.15	megohm
Transconductance, Grid No.1 to Plate.....	1350	800	ambos
Transconductance, Grid No.3 to Plate.....	515	515	ambos
Plate Current.....	1.55	1.1	ma
Grid-No.2 Current.....	1.8	2.1	ma
Grid-No.1 Voltage (Approx.) for plate current of 10 μa.....	-5.2	-4.5	volts
Grid-No.3 Voltage (Approx.) for plate current of 10 μa.....	-4.2	-3.5	volts

## FM DETECTOR

### Maximum Ratings, (Design-Maximum Values):

PLATE VOLTAGE.....	330 <i>max</i>	volts
GRID-No.3 VOLTAGE.....	28 <i>max</i>	volts
GRID-No.2 SUPPLY VOLTAGE.....	330 <i>max</i>	volts
GRID-No.2 VOLTAGE.....	See curve page 66	volts
GRID-No.1 (CONTROL-GRID) VOLTAGE, Positive bias value.....	0 <i>max</i>	volts
PLATE DISSIPATION.....	1.7 <i>max</i>	watts
GRID-No.2 INPUT: For grid-No.2 voltages up to 165 volts.....	1.1 <i>max</i>	watts
For grid-No.2 voltages between 165 and 330 volts.....	See curve page 66	
PEAK HEATER-CATHODE VOLTAGE: Heater negative with respect to cathode.....	200 <i>max</i>	volts
Heater positive with respect to cathode.....	200 <i>max</i>	volts

### Maximum Circuit Values:

Grid-No.1-Circuit Resistance: For fixed-bias operation.....	0.25 <i>max</i>	megohm
For cathode-bias operation.....	0.5 <i>max</i>	megohm

▪ The dc component must not exceed 100 volts.

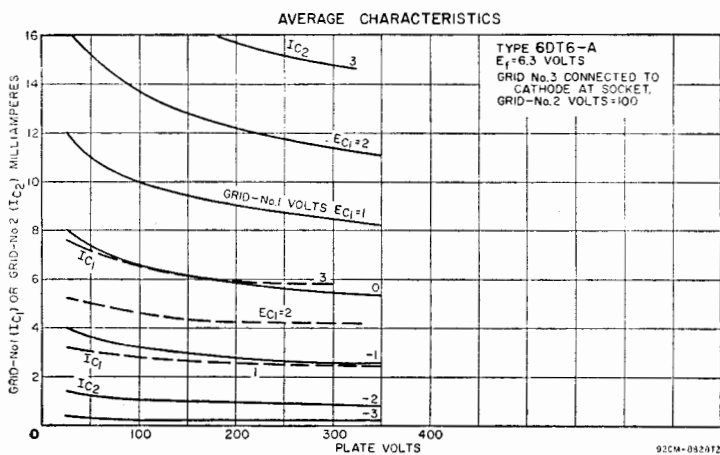
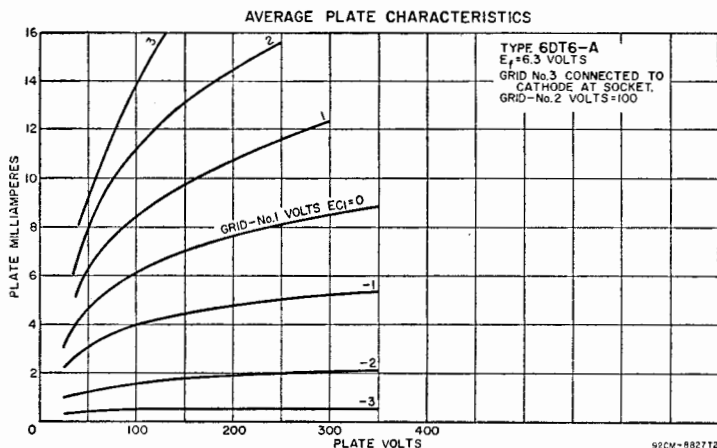

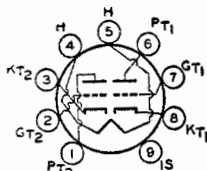

### HIGH-MU TWIN TRIODE

# 6DT8

Miniature type used in a wide variety of applications in radio and television receivers. Especially useful in push-pull rf amplifiers or as frequency converter in FM tuners. Outline 12, OUTLINES SECTION. Tube requires miniature nine-contact socket and may be mounted in any position. Heater volts (ac/dc), 6.3; amperes, 0.3. Peak heater-cathode volts: heater negative with respect to cathode, 200 *max*; heater positive with respect to cathode, 200 *max*; (the dc component must not exceed 100 volts). Except for heater and heater-cathode ratings, interelectrode capacitances, and basing arrangement, this type is identical with miniature type 12AT7.

**DIRECT INTERELECTRODE CAPACITANCES (Approx., Each Unit Except as Noted):**

Grid to Plate	1.6*	$\mu\text{f}$
Grid to Cathode, Heater, and Internal Shield	2.7*	$\mu\text{f}$
Plate to Cathode, Heater, and Internal Shield	1.6*	$\mu\text{f}$
Heater to Cathode	3*	$\mu\text{f}$
Cathode to Grid, Heater, and Internal Shield (Unit No.2)	5.3†	$\mu\text{f}$
Plate to Grid, Heater, and Internal Shield (Unit No.2)	2.8†	$\mu\text{f}$

- \* With external shield connected to cathode of unit under test.
- † With external shield connected to ground.
- ‡ With external shield connected to grid of unit under test.

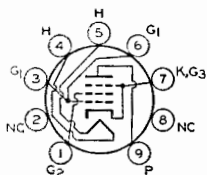

### BEAM POWER TUBE

# 6DW5

Miniature type used in vertical deflection amplifier service in television receivers employing 110-degree deflection systems. Outline 18, OUTLINES SECTION. Tube requires miniature nine-contact socket and may be operated in any position. Heater volts (ac/dc), 6.3; amperes, 1.2.

**CLASS A<sub>1</sub> AMPLIFIER**

Characteristics:	Pentode		Triode		
	Connection		Connection		
Plate Voltage	60	200	150	-	volts
Grid-No.2 Voltage	150	150	-	-	volts
Grid-No.1 Voltage	0	-22.5	-22.5	-	volts
Amplification Factor	-	-	4.3	-	
Plate Resistance (Approx.)	-	15000	-	-	ohms
Transconductance	-	5500	-	-	amhos
Plate Current	260 <sup>■</sup>	55	-	-	ma
Grid-No.2 Current	20 <sup>■</sup>	2	-	-	ma
Grid-No.1 Voltage (Approx.) for plate ma = 0.1	-	-55	-	-	volts

**VERTICAL DEFLECTION AMPLIFIER**

*For operation in a 525-line, 30-frame system\**

**Maximum Ratings, (Design-Maximum Values):**

DC PLATE VOLTAGE	330 <i>max</i>	volts
PEAK POSITIVE-PULSE PLATE VOLTAGE <sup>°</sup>	2200 <i>max</i>	volts
DC GRID-NO.2 (SCREEN-GRID) VOLTAGE	220 <i>max</i>	volts
PEAK NEGATIVE-PULSE GRID-NO.1 (CONTROL-GRID) VOLTAGE	250 <i>max</i>	volts
PEAK CATHODE CURRENT	225 <i>max</i>	ma
AVERAGE CATHODE CURRENT	65 <i>max</i>	ma
PLATE DISSIPATION	11 <i>max</i>	watts
GRID-NO.2 INPUT	2.5 <i>max</i>	watts
PEAK HEATER-CATHODE VOLTAGE:		
Heater negative with respect to cathode	200 <i>max</i>	volts
Heater positive with respect to cathode	200* <i>max</i>	volts

**Maximum Circuit Values:**

Grid-No.1 Circuit Resistance:	
For cathode-bias operation	2.2 <i>max</i> megohms

- This value can be measured by a method involving a recurrent wave form such that the maximum ratings of the tube will not be exceeded.
- ° The duration of the voltage pulse must not exceed 15 per cent of one vertical scanning cycle. In a 525-line, 30-frame system, 15 per cent of one vertical scanning cycle is 2.5 milliseconds.
- ° With grid No.2 connected to plate.
- \* The dc component must not exceed 100 volts.

# 6DZ7

## TWIN POWER PENTODE

Glass octal type used as power amplifier tube in high-fidelity audio equipment. Outline 31, OUTLINES SECTION. Tube requires octal socket and may be operated in any position.

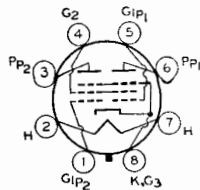

It is especially important that this tube, like other power-handling tubes, be adequately ventilated. Heater voltage (ac/dc), 6.3; amperes, 1.52.

### CLASS A<sub>1</sub> AMPLIFIER

Characteristics, (Each Unit):

Plate Voltage.....	250	volts
Grid-No.2 (Screen-Grid) Voltage.....	250	volts
Grid-No.1 (Control-Grid) Voltages.....	-7.3	volts
Plate Resistance (Approx.).....	38000	ohms
Transconductance.....	11300	μmhos
Plate Current.....	48	ma
Grid-No.2 Current.....	5.5	ma

### PUSH-PULL CLASS AB<sub>1</sub> AMPLIFIER

Maximum Ratings, (Design-Maximum Values) (Per Tube):

PLATE VOLTAGE.....	440 max	volts
GRID-NO.2 VOLTAGE.....	300 max	volts
GRID-NO.2 INPUT (Total).....	4 max	watts
PLATE DISSIPATION.....	13.2 max	watts
PEAK HEATER-CATHODE VOLTAGE:		
Heater negative with respect to cathode.....	200 max	volts
Heater positive with respect to cathode.....	200 <sup>o</sup> max	volts

Typical Operation, (Per Tube):

	Fixed Bias	Cathode Bias	
Plate Voltage.....	400	300	volts
Grid-No.2 Voltage.....	250	250	volts
Grid-No.1 Voltage.....	-11	-	volts
Cathode Resistor.....	-	120	ohms
Peak AF Grid-No.1-to-Grid-No.1 Voltage.....	22	22	volts
Zero-Signal Plate Current.....	40	66	ma
Maximum-Signal Plate Current.....	100	80	ma
Zero-Signal Grid-No.2 Current.....	4	7	ma
Maximum-Signal Grid-No.2 Current.....	13	15	ma
Effective Load Resistance (Plate-to-Plate).....	9000	9000	ohms
Total Harmonic Distortion.....	2.5	3.5	per cent
Maximum-Signal Power Output.....	18	12	watts

Maximum Circuit Values, (Each Unit):

Grid-No.1-Circuit Resistance.....	0.27 max	megohm
-----------------------------------	----------	--------

<sup>o</sup> The dc component must not exceed 100 volts.

## ELECTRON-RAY TUBE

# 6E5

Glass type used to indicate visually by means of a fluorescent target the effects of a change in a controlling voltage. It is used as a convenient means of indicating accurate radio-

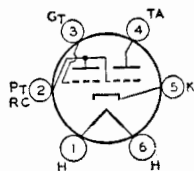

receiver tuning. Outline 34, OUTLINES SECTION. Tube requires six-contact socket. Heater volts (ac/dc), 6.3; amperes, 0.3. For additional considerations, refer to *Tuning Indication with Electron-Ray Tubes* in ELECTRON TUBE APPLICATIONS SECTION.

### TUNING INDICATOR

Maximum and Minimum Ratings:

PLATE-SUPPLY VOLTAGE.....	250 max	volts
TARGET VOLTAGE.....	{ 250 max	volts
	{ 125 min	volts

**Typical Operation:**

Plate and Target Supply Voltage.....	200	250	volts
Series Triode-Plate Resistor.....	1	1	megohm
Target Current*†.....	3	4	ma
Triode-Plate Current*.....	0.19	0.24	ma
Triode-Grid Voltage (Approx.):			
For shadow angle of 0°.....	-6.5	-8.0	volts
For shadow angle of 90°.....	0	0	volts

\* For zero triode-grid voltage. † Subject to wide variations.

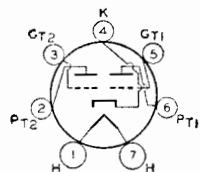

**TWIN POWER TRIODE**

Glass type used as class A<sub>1</sub> amplifier in either push-pull or parallel circuits. Outline 43, OUTLINES SECTION. Heater volts (ac/dc), 6.3; amperes, 0.6. With plate volts of 250 and grid volts of -27.5, characteristics for each unit are: plate ma., 18; plate resistance, 3500 ohms; transconductance, 1700  $\mu$ mhos; amplification factor, 6. With plate-to-plate load resistance

**6E6**

of 14000 ohms, output for two tubes is 1.6 watts. This is a DISCONTINUED type listed for reference only.

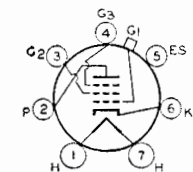

**REMOTE-CUTOFF PENTODE**

Glass type used in rf and if stages of radio receivers employing AVC. Outline 45, OUTLINES SECTION. Except for interelectrode capacitances, this type is identical electrically with type 6U7-G. Heater volts (ac/dc), 6.3; amperes, 0.3. This is a DISCONTINUED type listed for reference only.

**6E7**

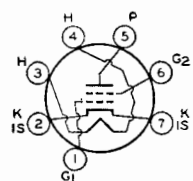

**SHARP-CUTOFF PENTODE**

Miniature type used as rf amplifier in vhf tuners of television receivers. Outline 11, OUTLINES SECTION. Tube requires miniature seven-contact socket and may be operated in any position.

**6EA5**

HEATER VOLTAGE (AC/DC).....	6.3	volts
HEATER CURRENT.....	0.2	ampere
	<i>Without External Shield</i>	<i>With External Shield<sup>o</sup></i>
DIRECT INTERELECTRODE CAPACITANCES:		
Grid No.1 to Plate.....	0.06 max	0.05 max $\mu$ fd
Grid No.1 to Cathode, Heater, Grid No.2, and Internal Shield.....	3.8	4.5 $\mu$ fd
Plate to Cathode, Heater, Grid No.2, and Internal Shield.....	2.3	3 $\mu$ fd

<sup>o</sup> With external shield connected to cathode.

**CLASS A<sub>1</sub> AMPLIFIER**

**Maximum Ratings, (Design-Maximum Values):**

PLATE VOLTAGE.....	250 max	volts
GRID-NO.2 (SCREEN-GRID) VOLTAGE.....	150 max	volts
GRID-NO.1 (CONTROL-GRID) VOLTAGE, Positive bias value.....	0 max	volts
CATHODE CURRENT.....	20 max	ma
GRID-NO.2 INPUT.....	0.5 max	watt
PLATE DISSIPATION.....	3.25 max	watts
PEAK HEATER-CATHODE VOLTAGE:		
Heater negative with respect to cathode.....	200 max	volts
Heater positive with respect to cathode.....	200 <sup>■</sup> max	volts

**Characteristics:**

Plate Voltage.....	250	volts
Grid-No.2 Voltage.....	140	volts
Grid-No.1 Voltage.....	-1	volt
Plate Resistance (Approx.).....	0.15	megohm
Transconductance.....	8000	$\mu$ mhos
Plate Current.....	10	ma
Grid-No.2 Current.....	0.95	ma
Grid-No.1 Voltage (Approx.) for transconductance of 100 $\mu$ mhos or less.....	-6	volts

<sup>■</sup> The dc component must not exceed 100 volts.

DUAL TRIODE

6EA7

Glass octal type containing high-mu triode and high-perveance, low-mu triode in same envelope. Used as a combined vertical deflection oscillator and vertical deflection amplifier in television receivers. Outline 19, OUTLINES SECTION. Tube requires octal socket and may be operated in any position. Heater volts (ac/dc), 6.3; amperes, 1.05.

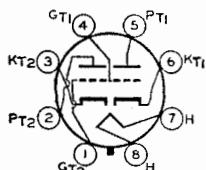

VERTICAL-DEFLECTION OSCILLATOR AND AMPLIFIER

For operation in a 525-line, 30-frame system

Maximum Ratings, (Design-Maximum Values):

	Unit No.1	Unit No.2	
DC PLATE VOLTAGE.....	350 max	550 max	volts
PEAK POSITIVE-PULSE PLATE VOLTAGE <sup>2</sup> .....	-	1500 max	volts
PEAK NEGATIVE-PULSE GRID VOLTAGE.....	400 max	250 max	volts
PEAK CATHODE CURRENT.....	- max	175 max	ma
AVERAGE CATHODE CURRENT.....	- max	50 max	ma
PLATE DISSIPATION.....	1 max	10 max	watts
PEAK HEATER-CATHODE VOLTAGE:			
Heater negative with respect to cathode.....	200 max	200 max	volts
Heater positive with respect to cathode.....	200 <sup>max</sup> max	200 <sup>max</sup> max	volts

Maximum Circuit Values:

	Unit No.1	Unit No.2	
Grid-Circuit Resistance:			
For grid-resistor-bias operation.....	1 max	1 max	megohm
For cathode-bias operation.....	2.2 max	2.2 max	megohms

Characteristics:

CLASS A<sub>1</sub> AMPLIFIER

	Unit No.1	Unit No.2	
Plate Voltage.....	250	60 175	volts
Grid Voltage.....	-3	0 -25	volts
Amplification Factor.....	66	- 5.5	
Plate Resistance (Approx.).....	30000	- 920	ohms
Transconductance.....	2200	- 6000	amhos
Grid Voltage (Approx.):			
For plate current of 20 $\mu$ a.....	-5.3	-	volts
For plate current of 200 $\mu$ a.....	-	-45	volts
Plate current.....	2 100 <sup>*</sup>	40	ma

<sup>2</sup> The duration of the voltage pulse must not exceed 15 per cent of one vertical-scanning cycle. In a 525-line, 30-frame system, 15 per cent of one vertical-scanning cycle is 2.5 milliseconds.

\* The dc component must not exceed 100 volts.

• This value can be measured by a method involving a recurrent wave form such that the maximum ratings of the tube will not be exceeded.

MEDIUM-MU TRIODE—  
SHARP-CUTOFF PENTODE

6EA8

Miniature type used as combined oscillator and mixer in television receivers utilizing an intermediate frequency in the order of 40 megacycles per second. Outline 12, OUTLINES

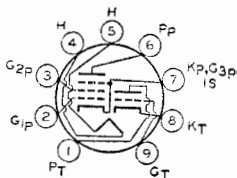

SECTION. Tube requires miniature nine-contact socket and may be mounted in any position.

HEATER VOLTAGE (AC/DC).....	6.3	volts
HEATER CURRENT.....	0.45	ampere
HEATER WARM-UP TIME (Average).....	11	seconds

DIRECT INTERELECTRODE CAPACITANCES:

	Without External Shield	With External Shield <sup>2</sup>	
Triode Unit:			
Grid to Plate.....	1.7	1.7	$\mu$ uf
Grid to Cathode, Heater, Pentode Cathode, Pentode Grid No.3, and Internal Shield.....	3	3.2	$\mu$ uf
Plate to Cathode, Heater, Pentode Cathode, Pentode Grid No.3, and Internal Shield.....	1.4	1.9	$\mu$ uf
Cathode to Heater.....	3	3 <sup>max</sup>	$\mu$ uf
Pentode Unit:			
Grid No.1 to Plate.....	0.02 max	0.01 max	$\mu$ uf
Grid No.1 to Cathode, Heater, Grid No.2, Grid No.3, and Internal Shield.....	5	5	$\mu$ uf
Plate to Cathode, Heater, Grid No.2, Grid No.3, and Internal Shield.....	2.6	3.4	$\mu$ uf
Heater to Cathode.....	3	3 <sup>max</sup>	$\mu$ uf



# Technical Data

° With external shield connected to cathode of unit under test except as noted.

▪ With external shield connected to ground.

## CLASS A<sub>1</sub> AMPLIFIER

Maximum Ratings, (Design-Maximum Values):

	Triode Unit	Pentode Unit	
PLATE VOLTAGE.....	330 max	330 max	volts
GRID-NO.2 (SCREEN-GRID) SUPPLY VOLTAGE.....	-	330 max	volts
GRID-NO.2 VOLTAGE.....	-	See curve page 66	
GRID-NO.1 (CONTROL-GRID) VOLTAGE:			
Positive bias value.....	0 max	0 max	volts
PLATE DISSIPATION.....	2.5 max	3.1 max	watts
GRID-NO.2 INPUT:			
For grid-No.2 voltages up to 165 volts.....	-	0.55 max	watt
For grid-No.2 voltages between 165 and 330 volts.....	-	See curve page 66	
PEAK HEATER-CATHODE VOLTAGE:			
Heater negative with respect to cathode.....	200 max	200 max	volts
Heater positive with respect to cathode.....	200*max	200*max	volts

\* The dc component must not exceed 100 volts.

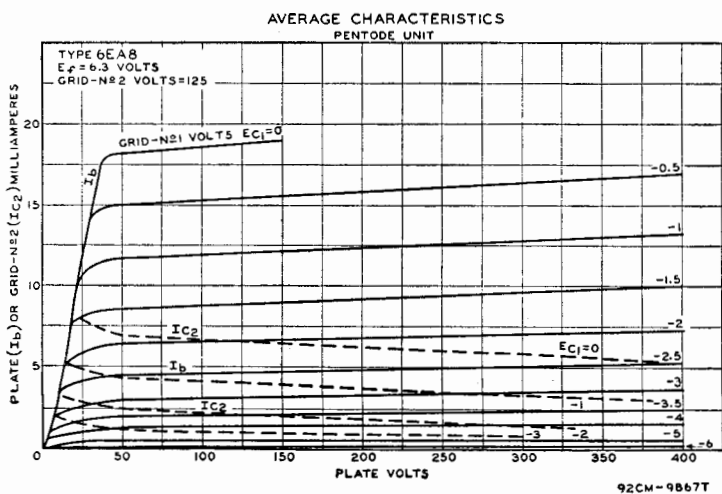
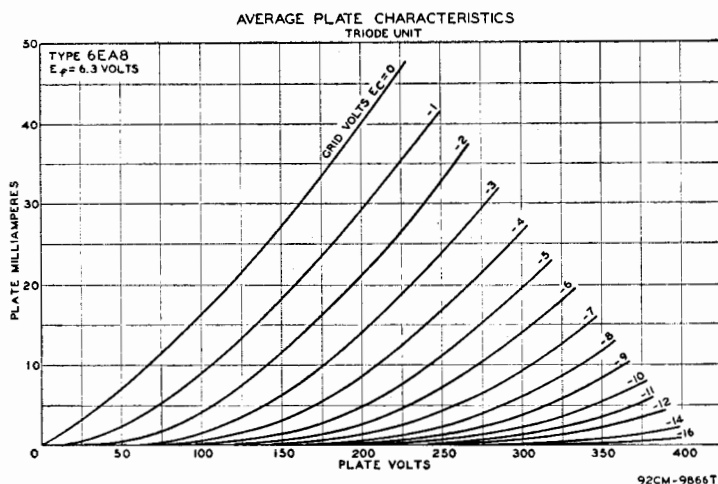

Characteristics:	<i>Triode Unit</i>	<i>Pentode Unit</i>	
Plate Supply Voltage.....	150	125	volts
Grid-No.2 Voltage.....	-	125	volts
Grid-No.1 Voltage.....	-	-1	volt
Cathode-Bias Resistor.....	56	-	ohms
Amplification Factor.....	40	-	
Plate Resistance (Approx.).....	5000	200000	ohms
Transconductance.....	8500	6400	amhos
Plate Current.....	18	12	ma
Grid-No.2 Current.....	-	4	ma
Grid-No.1 Voltage for plate current of 10 $\mu$ a.....	-12	-9	volts

**HIGH-MU TRIODE—  
SHARP-CUTOFF PENTODE**

**6EB8**

Miniature type used in color and black-and-white television receivers. Pentode unit is used as video output amplifier; triode unit is used in sync-separator, sync-clipper, and phase-in-

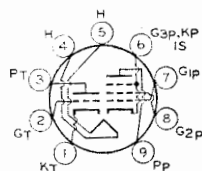

verter circuits. Outline 14, OUTLINES SECTION. Tube requires miniature nine-contact socket and may be mounted in any position.

HEATER VOLTAGE (AC/DC).....	6.3	volts
HEATER CURRENT.....	0.75	ampere
DIRECT INTERELECTRODE CAPACITANCES:		
Triode Unit:		
Grid to Plate.....	4.4	$\mu$ f
Grid to Cathode and Heater.....	2.4	$\mu$ f
Plate to Cathode and Heater.....	0.36	$\mu$ f
Pentode Unit:		
Grid No.1 to Plate.....	0.1 max	$\mu$ f
Grid No.1 to Cathode, Heater, Grid No.2, Grid No.3, and Internal Shield.....	11	$\mu$ f
Plate to Cathode, Heater, Grid No.2, Grid No.3, and Internal Shield.....	4.2	$\mu$ f
Triode Grid to Pentode Plate.....	0.018 max	$\mu$ f
Pentode Grid No.1 to Triode Plate.....	0.005 max	$\mu$ f
Pentode Plate to Triode Plate.....	0.17 max	$\mu$ f

**CLASS A<sub>1</sub> AMPLIFIER**

Maximum Ratings, (Design-Maximum Values):	<i>Triode Unit</i>	<i>Pentode Unit</i>	
PLATE VOLTAGE.....	330 max	330 max	volts
GRID-NO.2 (SCREEN-GRID) SUPPLY VOLTAGE.....	-	330 max	volts
GRID-NO.2 VOLTAGE.....	-	See curve page 66	
GRID-NO.1 (CONTROL-GRID) VOLTAGE:			
Positive bias value.....	0 max	0 max	volts
PLATE DISSIPATION.....	1 max	5 max	watts
GRID-NO.2 INPUT:			
For grid-No.2 voltages up to 165 volts.....	-	1.1 max	watts
For grid-No.2 voltages between 165 and 330 volts.....	-	See curve page 66	
PEAK HEATER-CATHODE VOLTAGE:			
Heater negative with respect to cathode.....	200 max	200 max	volts
Heater positive with respect to cathode.....	200 <sup>o</sup> max	200 <sup>o</sup> max	volts
The dc component must not exceed 100 volts.			

Characteristics:	<i>Triode Unit</i>	<i>Pentode Unit</i>	
Plate Supply Voltage.....	250	200	volts
Grid-No.2 Supply Voltage.....	-	125	volts
Grid Voltage.....	-2	-	volts
Cathode-Bias Resistor.....	-	68	ohms
Amplification Factor.....	100	-	
Plate Resistance (Approx.).....	37000	75000	ohms
Transconductance.....	2700	12500	amhos
Grid Voltage (Approx.) for plate current of 20 $\mu$ a.....	-5	-	volts
Grid-No.1 Voltage (Approx.) for plate current of 100 $\mu$ a.....	-	-9	volts
Plate Current.....	2	25	ma
Grid-No.2 Current.....	-	7	ma

**Maximum Circuit Values:**

Grid-No.1-Circuit Resistance:			
For fixed-bias operation.....	0.5 max	0.25 max	megohm
For cathode-bias operation.....	1.0 max	1.0 max	megohm

## AVERAGE CHARACTERISTICS PENTODE UNIT

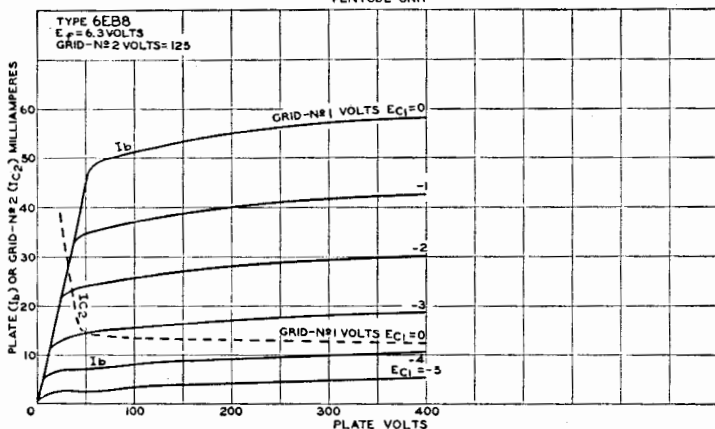

92CM-9906T

## AVERAGE PLATE CHARACTERISTICS TRIODE UNIT

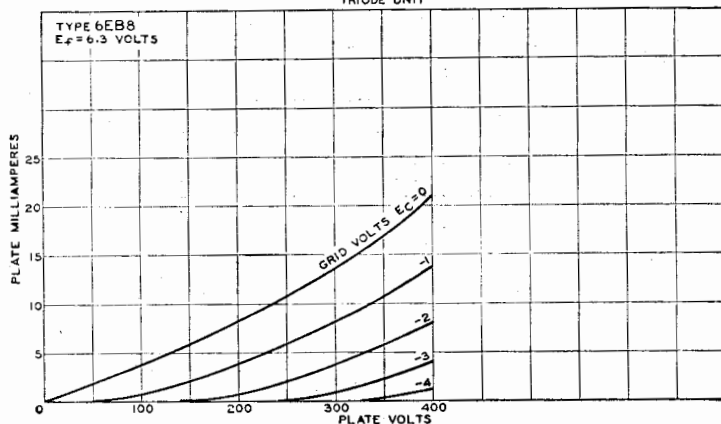

92CM-9907T

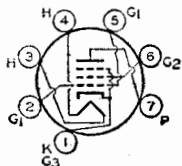

### POWER PENTODE

# 6EH5

Miniature type used in the audio output stage of radio and television receivers and in phonographs. This type has unusually high power sensitivity and is capable of providing

relatively high power output at low plate and screen-grid voltages with a low grid-No.1 driving voltage. Outline 13, OUTLINES SECTION. Tube requires miniature seven-contact socket and may be mounted in any position.

HEATER VOLTAGE (AC/DC).....	6.3	volts
HEATER CURRENT.....	1.2	amperes
DIRECT INTERELECTRODE CAPACITANCES (Approx.):		
Grid No.1 to Plate.....	0.65	$\mu\mu\text{f}$
Grid No.1 to Cathode, Heater, Grid No.2, and Grid No.3.....	17	$\mu\mu\text{f}$
Plate to Cathode, Heater, Grid No.2, and Grid No.3.....	9	$\mu\mu\text{f}$

## CLASS A<sub>1</sub> AMPLIFIER

Maximum Ratings, (Design-Maximum Values):

PLATE VOLTAGE.....	150 max	volts
GRID-NO.2 (SCREEN-GRID) VOLTAGE.....	130 max	volts
PLATE DISSIPATION.....	5.5 max	watts
GRID-NO.2 INPUT.....	2 max	watts
PEAK HEATER-CATHODE VOLTAGE:		
Heater negative with respect to cathode.....	200 max	volts
Heater positive with respect to cathode.....	200 max	volts
BULB TEMPERATURE (At hottest point).....	220 max	°C

Typical Operation:

Plate Supply Voltage.....	110	volts
Grid-No.2 Supply Voltage.....	115	volts
Cathode-Bias Resistor.....	62	ohms
Peak AF Grid-No.1 Voltage.....	3	volts
Zero-Signal Plate Current.....	12	ma
Maximum-Signal Plate Current.....	42	ma
Zero-Signal Grid-No.2 Current.....	11.5	ma
Maximum-Signal Grid-No.2 Current.....	14.5	ma
Plate Resistance (Approx.).....	11000	ohms
Transconductance.....	14600	μmhos
Load Resistance.....	3000	ohms
Total Harmonic Distortion.....	7	per cent
Maximum-Signal Power Output.....	1.4	watts

Maximum Circuit Values:

Grid-No.1-Circuit Resistance:		
For fixed-bias operation.....	0.1 max	megohm
For cathode-bias operation.....	0.5 max	megohm

■ The dc component must not exceed 100 volts.

## PUSH-PULL CLASS AB<sub>1</sub> AUDIO-FREQUENCY POWER AMPLIFIER

Maximum Ratings: (Same as for class A<sub>1</sub> audio-frequency power amplifier)

Typical Operation, (Values are for 2 tubes):

Plate Supply Voltage.....	140	volts
Grid-No.2 Supply Voltage.....	120	volts
Cathode-Bias Resistor.....	68	ohms
Peak AF Grid-No.1 Voltage.....	9.4	volts
Zero-Signal Plate Current.....	47	ma
Maximum-Signal Plate Current.....	51	ma
Zero-Signal Grid-No.2 Current.....	11	ma
Maximum-Signal Grid-No.2 Current.....	17.7	ma
Effective Load Resistance (Plate-to-plate).....	6000	ohms
Total Harmonic Distortion.....	5	per cent
Maximum-Signal Power Output.....	3.8	watts

Maximum Circuit Values:

Grid-No.1-Circuit Resistance:		
For fixed-bias operation.....	0.1 max	megohm
For cathode-bias operation.....	0.5 max	megohm

AVERAGE CHARACTERISTICS

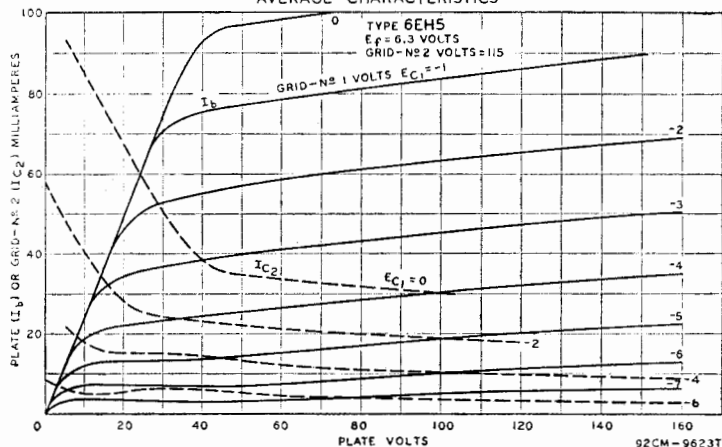

### MEDIUM-MU TRIODE— SHARP-CUTOFF PENTODE

# 6EH8

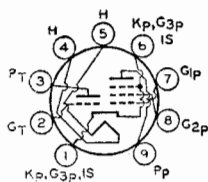

Miniature type used as combined oscillator and mixer tube in vhf tuners of television receivers having series-connected heater strings. Outline 12, OUTLINES SECTION. Tube requires nine-contact socket and may be mounted in any position. Heater volts (ac/dc), 6.3; amperes, 0.45; warm-up time (average), 11 seconds. This type is used principally for renewal purposes.

#### CLASS A<sub>1</sub> AMPLIFIER

Maximum Ratings, (Design-Maximum Values):

	Triode Unit	Pentode Unit	
PLATE VOLTAGE.....	300 max	300 max	volts
GRID-NO.2 (SCREEN-GRID) SUPPLY VOLTAGE.....	-	300 max	volts
GRID-NO.2 VOLTAGE.....	-	See curve page 66	volts
GRID-NO.1 (CONTROL-GRID) VOLTAGE, Positive-bias value.....	0 max	0 max	volts
PLATE DISSIPATION.....	2.5 max	2.8 max	watts
GRID-NO.2 INPUT:			
For grid-No.2 voltages up to 150 volts.....	-	0.5 max	watt
For grid-No.2 voltages between 150 and 300 volts.....	-	See curve page 66	
PEAK HEATER-CATHODE VOLTAGE:			
Heater negative with respect to cathode.....	200 max	200 max	volts
Heater positive with respect to cathode.....	200 <sup>o</sup> max	200 <sup>o</sup> max	volts

#### Characteristics:

Plate Voltage.....	125	125	volts
Grid-No.2 Voltage.....	-	125	volts
Grid-No.1 Voltage.....	-1	-1	volt
Amplification Factor.....	40	-	
Plate Resistance (Approx.).....	-	0.17	megohm
Transconductance.....	7500	6000	μmhos
Grid-No.1 Voltage (Approx.) for plate current of 20 μa.....	-9	-10	volts
Plate Current.....	13.5	12	ma
Grid-No.2 Current.....	-	4	ma

#### Maximum Circuit Values:

Grid-No.1-Circuit Resistance:			
For fixed-bias operation.....	0.5 max	0.25 max	megohm
For cathode-bias operation.....	1 max	1 max	megohm

° The dc component must not exceed 100 volts.

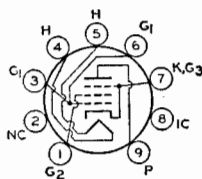

### BEAM POWER TUBE

# 6EM5

Miniature type used as vertical deflection amplifier in television receivers utilizing picture tubes having diagonal deflection angles of 110 degrees. Outline 18, OUTLINES SECTION.

Tube requires miniature nine-contact socket and may be mounted in any position.

HEATER VOLTAGE (AC/DC).....	6.3	volts
HEATER CURRENT.....	0.8	ampere
DIRECT INTERELECTRODE CAPACITANCES:		
Grid No.1 to Plate.....	0.7 max	μfd
Grid No.1 to Cathode, Heater, Grid No.2, and Grid No.3.....	10	μfd
Plate to Cathode, Heater, Grid No.2, and Grid No.3.....	5.1	μfd
PLATE RESISTANCE (Approx.)*.....	0.05	megohm
TRANSCONDUCTANCE*.....	5100	μmhos

\* For plate and grid-No.2 volts, 250; grid-No.1 volts, -18; plate ma., 40; grid-No.2 ma., 3.

#### VERTICAL DEFLECTION AMPLIFIER

For operation in a 525-line, 30-frame system

DC PLATE VOLTAGE.....	315 max	volts
PEAK POSITIVE-PULSE PLATE VOLTAGE† (Absolute Maximum).....	2200 <sup>o</sup> max	volts
GRID-NO.2 (SCREEN-GRID) VOLTAGE.....	285 max	volts
PEAK NEGATIVE-PULSE GRID-NO.1 (CONTROL-GRID) VOLTAGE.....	-250 max	volts
PEAK CATHODE CURRENT.....	210 max	ma
AVERAGE CATHODE CURRENT.....	60 max	ma
PLATE DISSIPATION.....	10 max	watts
GRID-NO.2 INPUT.....	1.5 max	watts
PEAK HEATER-CATHODE VOLTAGE:		
Heater negative with respect to cathode.....	200 max	volts
Heater positive with respect to cathode.....	200 <sup>o</sup> max	volts
BULB TEMPERATURE (At hottest point).....	250 max	°C

**Maximum Circuit Values:**

Grid-No.1-Circuit Resistance..... 2.2 max megohm  
 † The duration of the voltage pulse must not exceed 15 per cent of one vertical scanning cycle. In a 525-line, 30-frame system, 15 per cent of one vertical scanning cycle is 2.5 milliseconds.

• Under no circumstances should this absolute value be exceeded.

• The dc component must not exceed 100 volts.

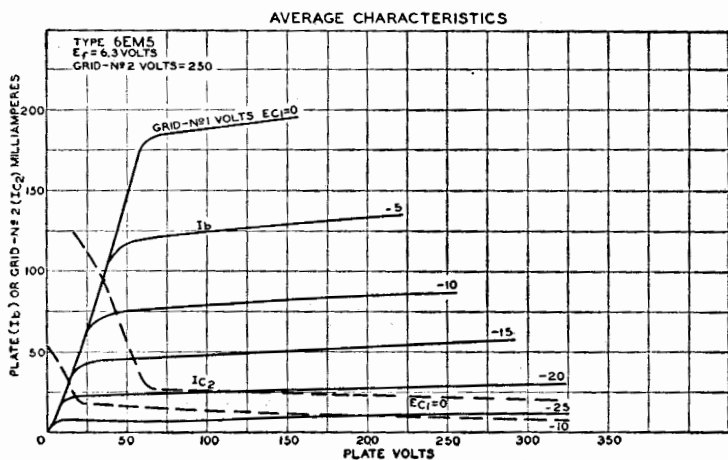
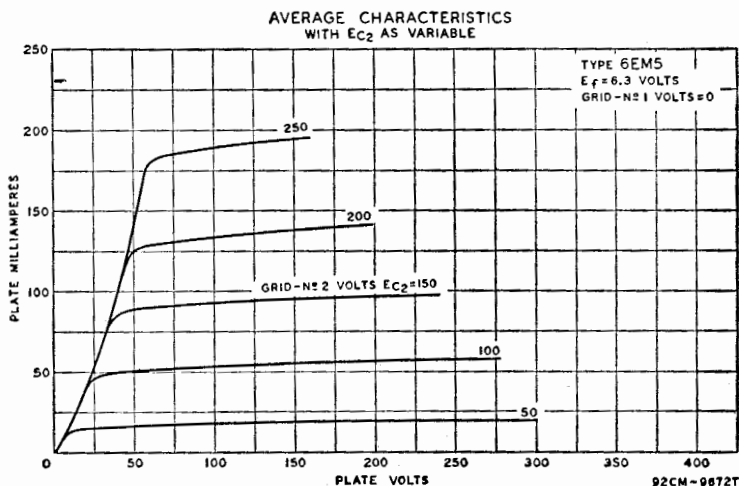

**DUAL TRIODE**

**6EM7**

Glass octal type containing high- $\mu$  triode and high-perveance, low- $\mu$  triode in same envelope. Used as combined vertical-deflection amplifier and vertical-deflection oscillator in television receivers employing picture tubes having 110-degree deflection angles and high ultor voltages. Outline 19, OUTLINES SECTION, except vertical dimensions are  $\frac{1}{8}$  inch less. Tube requires octal socket and may be mounted in any position.

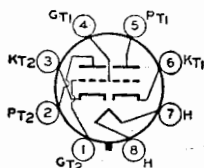

For curve of average plate characteristics, Unit No.1, refer to type 6DR7.

## Technical Data

HEATER VOLTAGE (AC/DC).....	6.3	volts
HEATER CURRENT.....	0.925	ampere
DIRECT INTERELECTRODE CAPACITANCES (Approx.):	<i>Unit No.1</i>	<i>Unit No.2</i>
Grid to Plate.....	4.8	10
Grid to Cathode and Heater.....	2.2	7
Plate to Cathode and Heater.....	0.6	1.8

### VERTICAL-DEFLECTION OSCILLATOR AND AMPLIFIER

*For operation in a 525-line, 30-frame system*

<b>Maximum Ratings, (Design-Maximum Values):</b>	<i>Unit No.1</i>	<i>Unit No.2</i>	
DC PLATE VOLTAGE.....	Oscillator 330 max	Amplifier 330 max	volts
PEAK POSITIVE-PULSE PLATE VOLTAGE.....	-	1500 max	volts
PEAK NEGATIVE-PULSE GRID VOLTAGE.....	400 max	250 max	volts
PEAK CATHODE CURRENT.....	77 max	175 max	ma
AVERAGE CATHODE CURRENT.....	22 max	50 max	ma
PLATE DISSIPATION.....	1.5 max	10 max	watts
PEAK HEATER-CATHODE VOLTAGE:			
Heater negative with respect to cathode.....	200 max	200 max	volts
Heater positive with respect to cathode.....	200 max	200 max	volts

#### Maximum Circuit Values:

Grid-Circuit Resistance:	<i>Unit No.1</i>	<i>Unit No.2</i>	
For grid-resistor-bias operation.....	2.2 max	2.2 max	megohms
For cathode-bias operation.....	2.2 max	2.2 max	megohms

### CLASS A<sub>1</sub> AMPLIFIER

<b>Characteristics:</b>	<i>Unit No.1</i>	<i>Unit No.2</i>	
Plate Voltage.....	250	150	volts
Grid Voltage.....	-3	-20	volts
Amplification Factor.....	68	5.4	
Plate Resistance (Approx.).....	40000	750	ohms
Transconductance.....	1600	7200	amhos
Grid Voltage (Approx.):			
For plate current of 10 $\mu$ a.....	-5.5	-	volts
For plate current of 100 $\mu$ a.....	-	-45	volts
Plate Current.....	1.4	50	ma
Plate Current, for plate volts=60 and grid volts=0.....	-	95	ma
Plate Current, for grid volts=-28.....	-	10	ma

The duration of the voltage pulse must not exceed 15 per cent of one vertical-scanning cycle. In a 525-line, 30-frame system, 15 per cent of one vertical-scanning cycle is 2.5 milliseconds.

■ The dc component must not exceed 100 volts.

AVERAGE PLATE CHARACTERISTICS  
UNIT No. 2

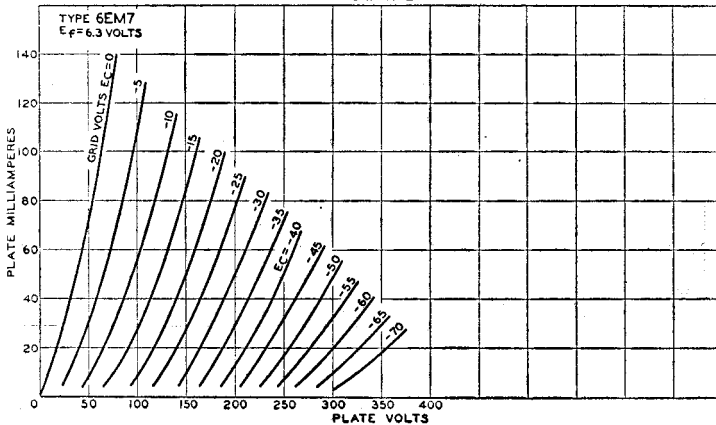

92CM-10466T

### DIODE—REMOTE-CUTOFF PENTODE

Miniature type used as combined if amplifier and AM detector in AM and AM/FM radio receivers. Outline 14, OUTLINES SECTION. Tube requires miniature nine-contact socket and may be operated in any position.

# 6EQ7

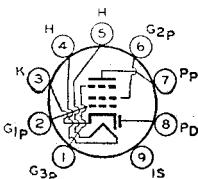

# RCA Receiving Tube Manual

HEATER VOLTAGE (AC/DC).....	6.3	volts
HEATER CURRENT.....	0.3	ampere
DIRECT INTERELECTRODE CAPACITANCES: <sup>o</sup>		
Pentode Unit:		
Grid No.1 to Plate.....	0.002 <i>max</i>	$\mu\mu\text{f}$
Grid No.1 to cathode, heater, grid No.2, grid No.3, and Internal Shield.....	5.5	$\mu\mu\text{f}$
Plate to cathode, heater, grid No.2, grid No.3, and Internal Shield.....	5	$\mu\mu\text{f}$
Pentode Grid No.1 to Diode Plate.....	0.0015 <i>max</i>	$\mu\mu\text{f}$
Pentode Plate to Diode Plate.....	0.095	$\mu\mu\text{f}$

## PENTODE UNIT AS CLASS A<sub>1</sub> AMPLIFIER

### Maximum Ratings, (Design-Maximum Values):

PLATE VOLTAGE.....	300 <i>max</i>	volts
GRID-NO.3 (SUPPRESSOR-GRID) VOLTAGE:		
Positive value.....	300 <i>max</i>	volts
Negative value.....	300 <i>max</i>	volts
GRID-NO.2 (SCREEN-GRID) SUPPLY VOLTAGE.....	300 <i>max</i>	volts
GRID-NO.2 VOLTAGE.....	See curve page 66	
GRID-NO.1 (CONTROL-GRID) VOLTAGE:		
Positive-bias value.....	0 <i>max</i>	volts
Negative-bias value.....	50 <i>max</i>	volts
PLATE DISSIPATION.....	3 <i>max</i>	watts
GRID-NO.3 INPUT.....	0.2 <i>max</i>	watt
GRID-NO.2 INPUT:		
For grid-No.2 voltages up to 150 volts.....	0.6 <i>max</i>	watt
For grid-No.2 voltages between 150 and 300 volts.....	See curve page 66	
PEAK HEATER-CATHODE VOLTAGE:		
Heater negative with respect to cathode.....	200 <i>max</i>	volts
Heater positive with respect to cathode.....	200 <i>max</i>	volts
BULB TEMPERATURE (At hottest point).....	150 <i>max</i>	°C

### Characteristics:

Plate Voltage.....	100	volts
Grid No.3.....	Connected to cathode at socket	
Internal Shield.....	Connected to cathode at socket	
Grid-No.2 Voltage.....	100	volts
Grid-No.1 Supply Voltage.....	0	volts
Grid-No.1 Resistor (Bypassed).....	2.2	megohms
Plate Resistance (Approx.).....	0.25	megohm
Transconductance.....	3800	$\mu\text{mhos}$
Plate Current.....	9	ma
Grid-No.2 Current.....	3.5	ma
Grid-No.1 Voltage (Approx.) for transconductance of 40 $\mu\text{mhos}$ .....	-20	volts

## DIODE UNIT

### Maximum Ratings, (Design-Maximum Values):

PLATE CURRENT.....	1 <i>max</i>	ma
--------------------	--------------	----

### Characteristics, Instantaneous Test Condition:

Plate Current, for plate volts=10.....	2	ma
--	---	----

<sup>o</sup> Without external shield.

■ The dc component must not exceed 100 volts.

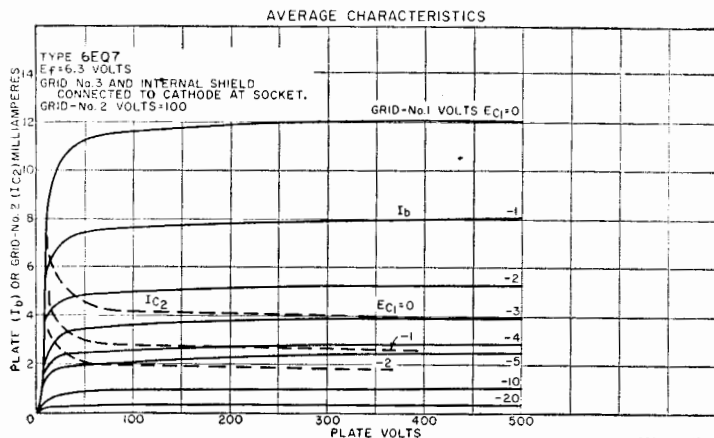

92C11-106-0011



### HIGH-MU TRIODE

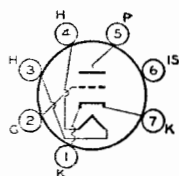

Miniature type used in vhf tuners of television receivers. Outline 11, OUTLINES SECTION. Tube requires miniature seven-contact socket and may be mounted in any position. Heater volts (ac/dc), 6.3, amperes, 0.18.

## 6ER5

CLASS A <sub>1</sub> AMPLIFIER			
Maximum Ratings:			
PLATE VOLTAGE.....	250 <i>max</i>	volts	
GRID VOLTAGE, Negative-bias value.....	50 <i>max</i>	volts	
CATHODE CURRENT.....	20 <i>max</i>	ma	
PLATE DISSIPATION.....	2.2 <i>max</i>	watts	
PEAK HEATER-CATHODE VOLTAGE:			
Heater negative with respect to cathode.....	100 <i>max</i>	volts	
Heater positive with respect to cathode.....	100 <i>max</i>	volts	
Characteristics:			
Plate Voltage.....	200	volts	
Grid Voltage.....	-1.2	volts	
Amplification Factor.....	80		
Plate Resistance (Approx.).....	8000	ohms	
Transconductance.....	10500	μmhos	
Plate Current.....	10	ma	
Grid Voltage (Approx.) for transconductance of 500 μmhos.....	-3.8	volts	
Grid Voltage (Approx.) for transconductance of 100 μmhos.....	-5.6	volts	
Maximum Circuit Value:			
Grid Circuit Resistance.....	1 <i>max</i>	megohm	

### HIGH-MU TRIODE

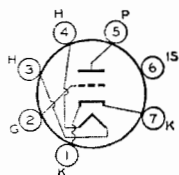

Miniature type used as grounded-cathode rf amplifier in vhf television receivers. Outline 11, OUTLINES SECTION. Tube requires miniature seven-contact socket and may be operated in any position. Heater volts (ac/dc), 6.3; amperes, 0.2.

## 6ES5

CLASS A <sub>1</sub> AMPLIFIER			
Maximum Ratings, (Design-Maximum Values):			
PLATE VOLTAGE.....	250 <i>max</i>	volts	
GRID VOLTAGE, Positive-bias value.....	0 <i>max</i>	volts	
CATHODE CURRENT.....	22 <i>max</i>	ma	
PLATE DISSIPATION.....	2.2 <i>max</i>	watts	
PEAK HEATER-CATHODE VOLTAGE:			
Heater negative with respect to cathode.....	100 <i>max</i>	volts	
Heater positive with respect to cathode.....	100 <i>max</i>	volts	
Characteristics:			
Plate Voltage.....	200	volts	
Grid Voltage.....	-1	volt	
Amplification Factor.....	75		
Plate Resistance (Approx.).....	8000	ohms	
Transconductance.....	9000	μmhos	
Plate Current.....	10	ma	
Grid Voltage (Approx.) for plate μa=100.....	-6	volts	
Maximum Circuit Values:			
Grid-Circuit Resistance.....	1 <i>max</i>	megohm	

### VARIABLE-MU TWIN DIODE

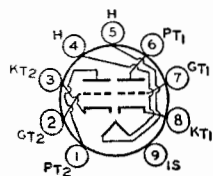

Miniature type with high trans-conductance, variable mu, and low noise; used as cascode-type amplifier in tuners of television receivers. Outline 12, OUTLINES SECTION. Tube requires miniature nine-contact socket and may be operated in any position.

## 6ES8

HEATER VOLTAGE (AC/DC).....	6.3	volts
HEATER CURRENT.....	0.365	ampere

**CASCODE-TYPE AMPLIFIER**

**Maximum Ratings:**

PLATE SUPPLY VOLTAGE with plate $m\alpha=0$ .....	550 <i>max</i>	volts
PLATE VOLTAGE (Each unit).....	130 <i>max</i>	volts
GRID VOLTAGE, Negative-bias value (Each unit).....	50 <i>max</i>	volts
CATHODE CURRENT (Each unit).....	22 <i>max</i>	ma
PLATE DISSIPATION (Each unit).....	1.8 <i>max</i>	watts
<b>HEATER-CATHODE VOLTAGE:</b>		
Unit No.1: <sup>2</sup>		
RMS voltage between cathode and heater.....	50 <i>max</i>	volts
Unit No.2: <sup>2</sup>		
RMS voltage between cathode and heater <sup>2</sup> .....	50 <i>max</i>	volts
DC voltage between cathode and heater <sup>2</sup> .....	130 <i>max</i>	volts

**Typical Operation:**

*In a cascode-type circuit with the grid of the output unit connected to a voltage divider<sup>2</sup>*

Supply Voltage.....	180	volts
Plate Current.....	15	ma
Transconductance.....	12500	$\mu$ mhos
Noise Figure <sup>2</sup> .....	6.5	db
Grid Voltage (Approx.) for transconductance of 125 $\mu$ mhos.....	-9	volts
Input Voltage for cross-modulation factor of 0.01 and transconductance of 125 $\mu$ mhos.....	500	mv

**Maximum Circuit Values:**

Grid-Circuit Resistance (Each unit).....	1 <i>max</i>	megohm
--	--------------	--------

**CLASS A<sub>1</sub> AMPLIFIER (each unit)**

**Characteristics:**

Plate Voltage.....	90	90	90	volts
Grid Voltage.....	-1.2	-5	-9	volts
Plate Resistance (Approx.).....	2500	—	—	ohms
Transconductance.....	12500	625	125	$\mu$ mhos
Plate Current.....	15	—	—	ma

<sup>o</sup> Grounded-cathode input unit—pins 6, 7, and 8.

<sup>■</sup> Grounded-grid output unit—pins 1, 2, and 3.

<sup>■</sup> Cathode positive with respect to heater.

<sup>□</sup> In order not to exceed the maximum-rated plate voltage when the cascode-type amplifier is controlled it is necessary to use a voltage divider for the grounded-grid output unit.

\* Measured with tube operating in a television tuner.

**HIGH-MU TWIN TRIODE**

6EU7

Miniature type used in high-gain, resistance-coupled, low-level audio-amplifier applications where low-hum and non-microphonic characteristics are important considerations, such as

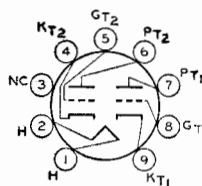

in microphone amplifiers and in preamplifiers for mono- and stereophonic phonographs. Outline 12, OUTLINES SECTION. Tube requires miniature nine-contact socket and may be mounted in any position. For typical operation as a resistance-coupled amplifier, refer to RESISTANCE-COUPLED AMPLIFIER SECTION.

HEATER VOLTAGE (AC/DC).....	6.3	volts
HEATER CURRENT.....	0.3	ampere
<b>DIRECT INTERELECTRODE CAPACITANCES (Each Unit, Approx.):</b>		
Grid to Plate.....	1.5	$\mu\mu$ f
Grid to Cathode and Heater.....	1.6	$\mu\mu$ f
Plate to Cathode and Heater.....	0.2	$\mu\mu$ f
<b>EQUIVALENT NOISE AND HUM VOLTAGE (Referenced to Grid, Each Unit):</b>		
Average Value*.....	1.8	microvolts rms

\* Measured in "true rms" units under the following conditions: Heater volts (ac), 6.3; center-tap of heater transformer grounded; plate supply volts, 250; plate load resistor, 10000 ohms; cathode resistor, 2700 ohms; cathode bypass capacitor, 100  $\mu$ f; grid resistor, 0 ohms; amplifier frequency range, 25 to 10000 cps.

## CLASS A<sub>1</sub> AMPLIFIER (Each Unit)

### Maximum Ratings, (Design-Maximum Values):

PLATE VOLTAGE.....	330 max	volts
GRID VOLTAGE:		
Negative-bias value.....	-55 max	volts
Positive-bias value.....	0 max	volts
PLATE DISSIPATION.....	1.2 max	watts
PEAK HEATER-CATHODE VOLTAGE:		
Heater negative with respect to cathode.....	200 max	volts
Heater positive with respect to cathode.....	200 <sup>max</sup>	volts

■ The dc component must not exceed 100 volts.

### Characteristics:

Plate Voltage.....	100	250	volts
Grid Voltage.....	-1	-2	volts
Amplification Factor.....	100	100	
Plate Resistance (Approx.).....	80000	62500	ohms
Transconductance.....	1250	1600	amhos
Plate Current.....	0.5	1.2	ma

AVERAGE PLATE CHARACTERISTICS  
EACH UNIT

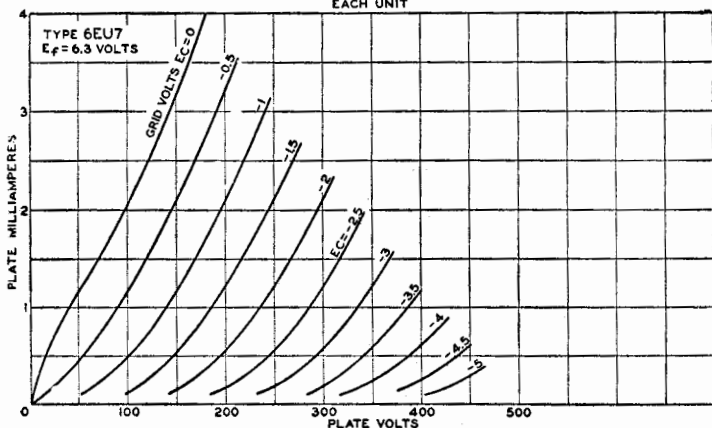

92CM-10470T

## MEDIUM-MU TRIODE— SHARP-CUTOFF PENTODE

Miniature type used as combined triode oscillator and pentode mixer in television receivers. Outline 12, OUT-LINES SECTION. Tube requires miniature nine-contact socket and may be operated in any position.

# 6EU8

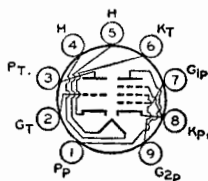

HEATER VOLTAGE (AC/DC).....	6.3	volts
HEATER CURRENT.....	0.45	ampere
HEATER WARM-UP TIME (Average).....	11	seconds

### Maximum Ratings:

### CLASS A<sub>1</sub> AMPLIFIER

	Triode Unit	Pentode Unit	
PLATE VOLTAGE.....	330 max	330 max	volts
GRID-NO.2 (SCREEN-GRID) SUPPLY VOLTAGE.....	—	330 max	volts
GRID-NO.2 VOLTAGE.....		See curve page 66	
GRID-NO.1 (CONTROL-GRID) VOLTAGE, Positive bias value.....	0 max	0 max	volts
PLATE DISSIPATION.....	3 max	3.1 max	watts
GRID-NO.2 INPUT:			
For grid-No.2 voltages up to 165 volts.....	—	0.55 max	watt
For grid-No.2 voltages between 165 and 330 volts.....		See curve page 66	
PEAK HEATER-CATHODE VOLTAGE:			
Heater negative with respect to cathode.....	200 max	200 max	volts
Heater positive with respect to cathode.....	200 <sup>max</sup>	200 <sup>max</sup>	volts

**Characteristics:**

Plate Supply Voltage.....	150	125	volts
Grid-No.2 Supply Voltage.....	—	125	volts
Grid-No.1 Voltage.....	—	-1	volt
Cathode-Bias Resistor.....	56	—	ohms
Amplification Factor.....	40	—	
Plate Resistance (Approx.).....	5000	8000	ohms
Transconductance.....	8500	6400	$\mu$ mhos
Grid-No.1 Voltage (Approx.) for plate $\mu$ =10.....	-12	-9	volts
Plate Current.....	18	12	ma
Grid-No.2 Current.....	—	4	ma
Cathode Warm-up Time <sup>■</sup> .....	35	—	seconds

**Maximum Circuit Values:**

Grid-No.1-Circuit Resistance.....	0.1 max	0.1 max	megohm
-----------------------------------	---------	---------	--------

<sup>°</sup> The dc component must not exceed 100 volts.

<sup>■</sup> The cathode warm-up time is defined as the time required for the transconductance to reach 6500  $\mu$ mhos when the tube is operated from a cold start with dc plate volts=100, grid volts=0, and heater volts=5.5.

**SHARP-CUTOFF TETRODE**

**6EV5**

Miniature type used as rf amplifier in vhf tuners of television receivers. Outline 11, OUTLINES SECTION. Tube requires miniature seven-contact socket and may be operated in any position. Heater volts (ac/dc), 6.3; amperes, 0.2.

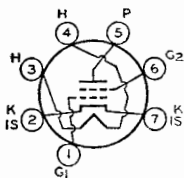

**CLASS A<sub>1</sub> AMPLIFIER**

**Maximum Ratings, (Design-Maximum Values):**

PLATE VOLTAGE.....	275 max	volts
GRID-NO 2 (SCREEN-GRID) SUPPLY VOLTAGE.....	180 max	volts
GRID-NO.2 VOLTAGE.....	See curve page 66	
GRID-NO.1 (CONTROL-GRID) VOLTAGE, Positive bias value.....	0 max	volts
CATHODE CURRENT.....	20 max	ma
GRID-NO.2 INPUT:		
For grid-No.2 voltages up to 90 volts.....	0.2 max	watt
For grid-No.2 voltages between 90 and 180 volts.....	See curve page 66	
PLATE DISSIPATION.....	3.25 max	watts
PEAK HEATER-CATHODE VOLTAGE:		
Heater negative with respect to cathode.....	100 max	volts
Heater positive with respect to cathode.....	100 <sup>°</sup> max	volts

**Characteristics:**

Plate Voltage.....	250	volts
Grid-No.2 Voltage.....	80	volts
Grid-No.1 Voltage.....	-1	volt
Plate Resistance (Approx.).....	0.15	megohm
Transconductance.....	880	$\mu$ mhos
Plate Current.....	11.5	ma
Grid-No.2 Current.....	0.9	ma
Grid-No.1 Voltage (Approx.) for transconductance of 100 $\mu$ mhos.....	-4.5	volts

**Maximum Circuit Value:**

Grid-No.1-Circuit Resistance.....	0.5 max	megohm
-----------------------------------	---------	--------

<sup>°</sup> The dc component must not exceed 50 volts.

**HIGH-MU TWIN TRIODE**

**6EV7**

Miniature type used as a relay-control tube in remote-control tuning units of television receivers. It is processed specifically for operation under standby conditions. Outline 14, OUT-

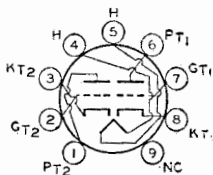

LINE SECTION. Tube requires miniature nine-contact socket and may be mounted in any position.

HEATER VOLTAGE (AC/DC).....	6.3	volts
HEATER CURRENT.....	0.6	ampere
DIRECT INTERELECTRODE CAPACITANCES (Approx.):	<i>Unit No.1</i>	<i>Unit No.2</i>
Grid to Plate.....	3.4	3.4
Grid to Cathode and Heater.....	3	3
Plate to Cathode and Heater.....	0.33	0.23

### RELAY-CONTROL SERVICE (Each Unit)

#### Maximum Ratings, (Design-Maximum Values):

PLATE VOLTAGE.....	300 <i>max</i>	volts
GRID VOLTAGE, Positive-bias value.....	0 <i>max</i>	volts
CATHODE CURRENT.....	20 <i>max</i>	ma
PLATE DISSIPATION:		
When "on" time exceeds 30 seconds in any 2-minute interval.....	2.5 <i>max</i>	watts
When "on" time does not exceed 30 seconds in any 2-minute interval..	4.5 <i>max</i>	watts
PEAK HEATER-CATHODE VOLTAGE:		
Heater negative with respect to cathode.....	200 <i>max</i>	volts
Heater positive with respect to cathode.....	200 <i>max</i>	volts

■ The dc component must not exceed 100 volts.

#### Typical Operation with 2500-Ohm-Relay Load:

<i>With "on" time in any 2-minute interval:</i>	<i>30 sec. or less</i>	<i>Over 30 sec</i>	
Plate Supply Voltage.....	250	150	volts
Zero-bias Plate Current.....	18.5	10	ma
Grid Voltage (Approx.) for plate current of 100 $\mu$ a.....	-9	-5	volts

#### Maximum Circuit Value:

Grid-Circuit Resistance.....	3.9 <i>max</i>	megohms
------------------------------	----------------	---------

#### Characteristics:

### CLASS A<sub>1</sub> AMPLIFIER (Each Unit)

Plate Voltage.....	250	volts
Grid Voltage.....	-2	volts
Amplification Factor.....	60	
Plate Resistance (Approx.).....	11500	ohms
Transconductance.....	5200	$\mu$ mhos
Plate Current.....	9.2	ma
Grid Voltage (Approx.) for plate current of 100 $\mu$ a.....	-9	volts

### AVERAGE PLATE CHARACTERISTICS EACH UNIT

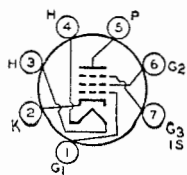
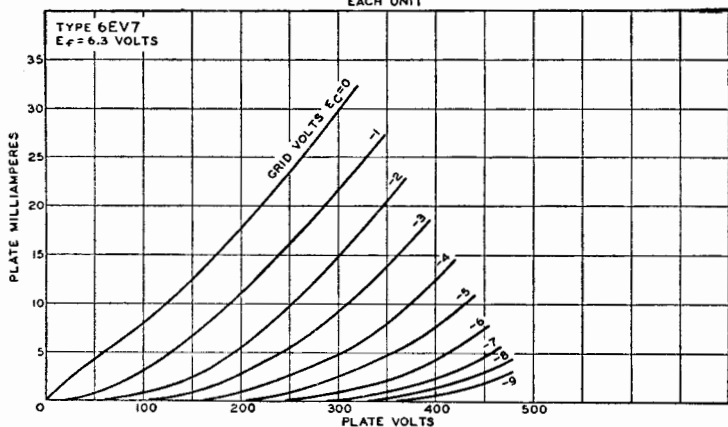

### SHARP-CUTOFF PENTODE

Miniature type used in the gain-controlled picture-if stages of vhf television receivers operating at an intermediate frequency in the order of 40 megacycles per second. This tube features controlled plate-current cutoff and high transconductance (14000  $\mu$ mhos)

## 6EW6

features controlled plate-current cutoff and high transconductance (14000  $\mu$ mhos)

combined with low interelectrode capacitance values. The 6EW6 is provided with separate base pins for grid No.3 and cathode to permit the use of an unbypassed cathode resistor to minimize changes in input conductance and input capacitance with bias, without causing oscillation. Outline 11, OUTLINES SECTION. Tube requires miniature seven-contact socket and may be mounted in any position.

HEATER VOLTAGE (AC/DC).....	6.3	volts
HEATER CURRENT.....	0.4	ampere
DIRECT INTERELECTRODE CAPACITANCES:		
Grid No.1 to Plate.....	0.04 max	$\mu\text{f}$
Grid No.1 to Cathode, Heater, Grid No.2, Grid No.3 and Internal Shield.....	10	$\mu\text{f}$
Plate to Cathode, Heater, Grid No.2, Grid No.3, and Internal Shield.....	2.4	$\mu\text{f}$

**CLASS A<sub>1</sub> AMPLIFIER**

**Maximum Ratings, (Design-Maximum Values):**

PLATE VOLTAGE.....	330 max	volts
GRID NO.3 (SUPPRESSOR GRID).....	Connect to cathode at socket	
GRID-NO.2 (SCREEN-GRID) SUPPLY VOLTAGE.....	330 max	volts
GRID-NO.2 VOLTAGE.....	See curve page 66	
GRID-NO.1 (CONTROL-GRID) VOLTAGE, Positive bias value.....	0 max	volts
PLATE DISSIPATION.....	3.1 max	watts
GRID-NO.2 INPUT:		
For grid-No.2 voltages up to 165 volts.....	0.65 max	watt
For grid-No.2 voltages between 165 and 330 volts.....	See curve page 66	
<b>PEAK HEATER-CATHODE VOLTAGE:</b>		
Heater negative with respect to cathode.....	200 max	volts
Heater positive with respect to cathode.....	200 max	volts

**Characteristics:**

Plate Supply Voltage.....	125	volts
Grid No.3 and Internal Shield.....	Connected to cathode at socket	
Grid-No.2 Supply Voltage.....	125	volts
Cathode-Bias Resistor.....	56	ohms
Plate Resistance (Approx.).....	0.2	megohm
Transconductance.....	14000	$\mu\text{mhos}$
Grid-No.1 Voltage (Approx.) for plate current of 20 $\mu\text{A}$ .....	-3.5	volts
Plate Current.....	11	ma
Grid-No.2 Current.....	3.2	ma

\* With external shield connected to cathode.

■ The dc component must not exceed 100 volts.

**AVERAGE CHARACTERISTICS**

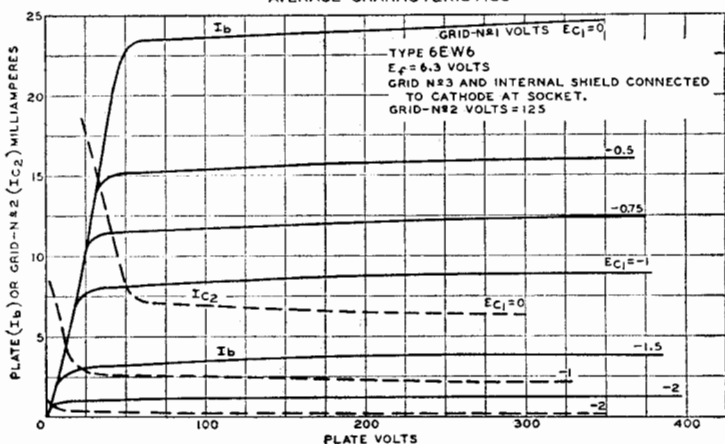

DUAL TRIODE

6EW7

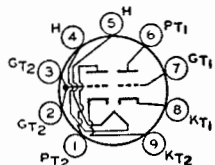

Glass "noval"-based type used as combined vertical-deflection oscillator and vertical-deflection amplifier in television receivers. Tube uses same type of envelope as Outline 53 but has large-

button noval base. Maximum dimensions: over-all length, 2-15/16 inches; seated length, 2-5/8 inches; diameter, 1-3/16 inches. Tube requires noval nine-contact socket and may be operated in any position. For curve of average plate characteristics, Unit No.1, refer to type 6DE7.

HEATER VOLTAGE (AC/DC).....	6.3	volts
HEATER CURRENT.....	0.9	ampere
DIRECT INTERELECTRODE CAPACITANCES (Approx.):°		
Grid to Plate.....	Unit No.1 4.2	Unit No.2 9 $\mu\text{f}$
Grid to Cathode and Heater.....	2.2	7 $\mu\text{f}$
Plate to Cathode and Heater.....	0.4	1.2 $\mu\text{f}$

VERTICAL-DEFLECTION OSCILLATOR AND AMPLIFIER

For operation in a 525-line, 30-frame system

<b>Maximum Ratings, (Design-Maximum Values):</b>	<i>Unit No.1</i>	<i>Unit No.2</i>	
DC PLATE VOLTAGE.....	<i>Oscillator</i> 330 max	<i>Amplifier</i> 330 max	volts
PEAK POSITIVE-PULSE PLATE VOLTAGE.....	—	1500 max	volts
PEAK NEGATIVE-PULSE GRID VOLTAGE.....	400 max	250 max	volts
PEAK CATHODE CURRENT.....	77 max	175 max	ma
AVERAGE CATHODE CURRENT.....	22 max	50 max	ma
PLATE DISSIPATION.....	1.5 max	10 max	watts
PEAK HEATER-CATHODE VOLTAGE:			
Heater negative with respect to cathode.....	200 max	200 max	volts
Heater positive with respect to cathode.....	200•max	200•max	volts

Maximum Circuit Values:

Grid-Circuit Resistance:			
For cathode-bias operation.....	2.2 max	2.2 max	megohms
For grid-resistor-bias operation.....	2.2 max	2.2 max	megohms

CLASS A<sub>1</sub> AMPLIFIER

<b>Characteristics:</b>	<i>Unit No.1</i>	<i>Unit No.2</i>	
Plate Voltage.....	250	150	volts
Grid Voltage.....	-11	-17.5	volts
Amplification Factor.....	17.5	6	
Plate Resistance (Approx.).....	8750	800	ohms
Transconductance.....	2000	7500	$\mu\text{mbos}$
Grid Voltage (Approx.) for plate $\mu\text{a}=10$ .....	-20	—	volts
Grid Voltage (Approx.) for plate $\mu\text{a}=100$ .....	—	-40	volts
Plate Current.....	5.5	45	ma
Plate Current for plate volts=60, grid volts=0.....	—	95	ma
Plate Current for grid volts=-25.....	—	8	ma

AVERAGE CHARACTERISTICS

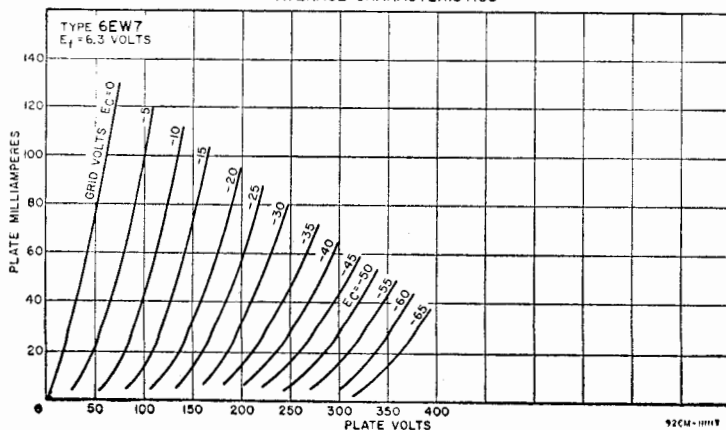

▪ Without external shield.

° The duration of the voltage pulse must not exceed 15 per cent of one vertical scanning cycle. In a 525-line, 30-frame system, 15 per cent of one vertical scanning cycle is 2.5 milliseconds.

• The dc component must not exceed 100 volts.

# 6EX6

## BEAM POWER TUBE

Glass octal type used as horizontal deflection amplifier in television receivers. Outline 46, OUTLINES SECTION. Tube requires octal socket and should be operated vertically (base down or up) or horizontally with pins 2 and 7 in a vertical plane. Heater volts (ac/dc) 6.3; amperes, 2.25. This type is used principally for renewal purposes.

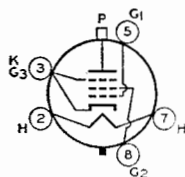

### HORIZONTAL-DEFLECTION AMPLIFIER

For operation in a 525-line, 30-frame system

#### Maximum Ratings, (Design-Maximum Values):

DC PLATE VOLTAGE.....	770 max	volts
PEAK POSITIVE-PULSE PLATE VOLTAGE <sup>°</sup> .....	7000 max	volts
PEAK NEGATIVE-PULSE PLATE VOLTAGE.....	1500 max	volts
DC GRID-NO.2 (SCREEN-GRID) VOLTAGE.....	195 max	volts
PEAK NEGATIVE-PULSE GRID-NO.1 VOLTAGE.....	220 max	volts
PEAK CATHODE CURRENT.....	770 max	ma
AVERAGE CATHODE CURRENT.....	220 max	ma
PLATE DISSIPATION <sup>•</sup> .....	22 max	watts
GRID-NO.2 INPUT.....	3.5 max	watts
PEAK HEATER-CATHODE VOLTAGE:		
Heater negative with respect to cathode.....	200 max	volts
Heater positive with respect to cathode.....	200 <sup>2</sup> max	volts
BULB TEMPERATURE (At hottest point).....	225 max	°C

#### Maximum Circuit Values:

Grid-No.1 Circuit Resistance.....	0.47 max	megohm
-----------------------------------	----------	--------

#### Characteristics:

### CLASS A<sub>1</sub> AMPLIFIER

Plate Voltage.....	60	60	175	volts
Grid-No.2 Voltage.....	125	150	175	volts
Grid-No.1 Voltage.....	0	0	-30	volts
Triode Amplification Factor.....	—	—	4.2	
Plate Resistance (Approx.).....	—	—	8500	ohms
Transconductance.....	—	—	7700	μmhos
Plate Current.....	360*	460 <sup>3</sup>	67	ma
Grid-No.2 Current.....	30*	45 <sup>3</sup>	3.3	ma
Grid-No.1 Voltage (Approx.) for plate ma=1.....	—	—	-50	volts
Grid-No.1 Voltage (Approx.) for peak positive-pulse plate voltage of 5000 volts and plate current of 1 ma	-88	-94	-101	volts

▪ The duration of the voltage pulse must not exceed 15 per cent of one horizontal scanning cycle. In a 525-line, 30-frame system, 15 per cent of one horizontal scanning cycle is 10 microseconds.

• An adequate bias resistor or other means is required to protect the tube in the absence of excitation.

° The dc component must not exceed 100 volts.

\* This value can be measured by a method involving a recurrent waveform such that the maximum ratings of the tube will not be exceeded.

## BEAM POWER TUBE

# 6EY6

Glass octal type used as vertical deflection amplifier in television receivers. Outline 26, OUTLINES SECTION. Tube requires octal socket and may be operated in any position.

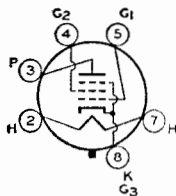

HEATER VOLTAGE (AC/DC).....	6.3	volts
HEATER CURRENT.....	0.68	ampere

### VERTICAL DEFLECTION AMPLIFIER

For operation in a 525-line, 30-frame system

#### Maximum Ratings, (Design-Maximum Values)

DC PLATE VOLTAGE.....	350 max	volts
PEAK POSITIVE-PULSE PLATE VOLTAGE <sup>°</sup> .....	2500 max	volts
GRID-NO.2 (SCREEN-GRID) VOLTAGE.....	300 max	volts
PEAK NEGATIVE-PULSE GRID-NO.1 (CONTROL-GRID) VOLTAGE.....	250 max	volts
PEAK CATHODE CURRENT.....	180 max	ma
AVERAGE CATHODE CURRENT.....	60 max	ma
PLATE DISSIPATION.....	11 max	watts
GRID-NO.2 INPUT.....	2.75 max	watts



<b>PEAK HEATER-CATHODE VOLTAGE:</b>		
Heater negative with respect to cathode.....	200 <i>max</i>	volts
Heater positive with respect to cathode.....	200 <i>max</i>	volts
<b>BULB TEMPERATURE (At hottest point).....</b>	200 <i>max</i>	°C

**Maximum Circuit Values:**

Grid-No.1-Circuit Resistance:		
For fixed-bias operation.....	1 <i>max</i>	megohm
For cathode-bias operation.....	2.2 <i>max</i>	megohms

### CLASS A<sub>1</sub> AMPLIFIER

**Characteristics:**

Plate Voltage.....	50	250	volts
Grid-No.2 Voltage.....	250	250	volts
Grid-No.1 Voltage.....	0	-17.5	volts
Plate Resistance (Approx.).....	—	60000	ohms
Transconductance.....	—	4400	μmhos
Grid-No.1 Voltage (Approx.) for plate $\mu a=100$ .....	—	-48	volts
Plate Current.....	153*	44	ma
Grid-No.2 Current.....	21*	3	ma

° The duration of the voltage pulse must not exceed 15 per cent of one vertical scanning cycle. In a 525-line, 30-frame system, 15 per cent of one vertical scanning cycle is 2.5 milliseconds.

- The dc component must not exceed 100 volts.
- This value can be measured by a method involving a recurrent waveform such that the maximum ratings of the tube will not be exceeded.

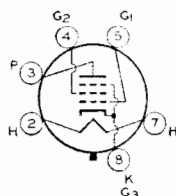

### BEAM POWER TUBE

Glass octal type used as vertical deflection amplifier in television receivers. Outline 26, OUTLINES SECTION. Tube requires octal socket and may be operated in any position.

## 6EZ5

HEATER VOLTAGE (AC/DC).....	6.3	volts
HEATER CURRENT.....	0.8	ampere

### VERTICAL DEFLECTION AMPLIFIER

*For operation in a 525-line, 30-frame system*

**Maximum Ratings, (Design-Maximum Values):**

DC PLATE VOLTAGE.....	350 <i>max</i>	volts
PEAK POSITIVE-PULSE PLATE VOLTAGE°.....	2500 <i>max</i>	volts
GRID-NO.2 (SCREEN-GRID) VOLTAGE.....	300 <i>max</i>	volts
PEAK NEGATIVE-PULSE GRID-NO.1 (CONTROL-GRID) VOLTAGE.....	250 <i>max</i>	volts
PEAK CATHODE CURRENT.....	260 <i>max</i>	ma
AVERAGE CATHODE CURRENT.....	75 <i>max</i>	ma
PLATE DISSIPATION.....	12 <i>max</i>	watts
GRID-NO.2 INPUT.....	2.75 <i>max</i>	watts
<b>PEAK HEATER-CATHODE VOLTAGE:</b>		
Heater negative with respect to cathode.....	200 <i>max</i>	volts
Heater positive with respect to cathode.....	200 <i>max</i>	volts
<b>BULB TEMPERATURE (At hottest point).....</b>	200 <i>max</i>	°C

**Maximum Circuit Values:**

Grid-No.1-Circuit Resistance:		
For fixed-bias operation.....	1 <i>max</i>	megohm
For cathode-bias operation.....	2.2 <i>max</i>	megohms

### CLASS A<sub>1</sub> AMPLIFIER

**Characteristics:**

Plate Voltage.....	60	250	volts
Grid-No.2 Voltage.....	250	250	volts
Grid-No.1 Voltage.....	0	-20	volts
Plate Resistance (Approx.).....	—	50000	ohms
Transconductance.....	—	4100	μmhos
Grid-No.1 Voltage (Approx.) for plate $\mu a=100$ .....	—	-50	volts
Plate Current.....	180*	43	ma
Grid-No.2 Current.....	26*	3.5	ma

° The duration of the voltage pulse must not exceed 15 per cent of one vertical scanning cycle. In a 525-line, 30-frame system, 15 per cent of one vertical scanning cycle is 2.5 milliseconds.

- The dc component must not exceed 100 volts.
- This value can be measured by a method involving a recurrent waveform such that the maximum ratings of the tube will not be exceeded.

### HIGH-MU TRIPLE TRIODE

## 6EZ8

Miniature type used in oscillator-mixer and afc service in FM receivers. Outline 12, OUTLINES SECTION. Tube requires miniature nine-contact socket and may be operated in any position.

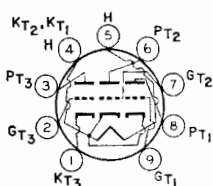

HEATER VOLTAGE (AC/DC).....	6.3	volts
HEATER CURRENT.....	0.45	ampere

#### CLASS A<sub>1</sub> AMPLIFIER

Values are for Each Unit Unless Specified Otherwise

#### Maximum Ratings, (Design-Maximum Values):

PLATE VOLTAGE.....	330 max	volts
GRID VOLTAGE:		
Negative-bias value.....	50 max	volts
Positive-bias value.....	0 max	volts
PLATE DISSIPATION.....	2 max	watts
TOTAL PLATE DISSIPATION (All plates).....	5 max	watts
HEATER-CATHODE VOLTAGE (Unit No.3):		
Heater negative with respect to cathode.....	100 max	volts
Heater positive with respect to cathode.....	100 max	volts

#### Characteristics:

Plate Voltage.....	125	volts
Grid Voltage.....	1	volt
Amplification Factor.....	57	
Plate Resistance (Approx.).....	13600	ohms
Transconductance.....	4200	μmhos
Grid Voltage (Approx.), for plate $\mu a = 20$ .....	-1	volts
Plate Current.....	4.2	ma

### HIGH-MU TRIODE

## 6F5 6F5-GT

Metal type 6F5 and glass octal type 6F5-GT used in resistance-coupled amplifier circuits. Outlines 4 and 21, respectively, OUTLINES SECTION. Tubes require octal socket

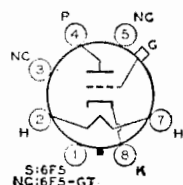

and may be mounted in any position. Type 6F5-GT may be supplied with pin No.1 omitted. Heater volts (ac/dc), 6.3; amperes, 0.3. Typical operation as class A<sub>1</sub> amplifier: plate volts, 250 (300 max); grid volts, -2; amplification factor, 100; plate resistance (approx.), 66000 ohms; transconductance, 1500 μmhos; plate ma., 0.9. Peak heater-cathode volts, 90 max. Type 6F5-GT is a DISCONTINUED type listed for reference only.

## 6F6 6F6-G 6F6-GT

### POWER PENTODE

Metal type 6F6 and glass octal types 6F6-G and 6F6-GT used in the audio output stage of ac receivers. Tubes are capable of large power output with relatively small input voltage.

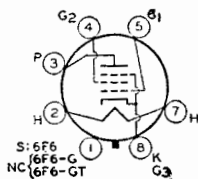

Outlines 6, 42 and 26, respectively, OUTLINES SECTION. Type 6F6-GT may be supplied with pin No.1 omitted. Tubes require octal socket and may be mounted in any position. It is especially important that these tubes, like other power-handling tubes, be adequately ventilated. Types 6F6-G and 6F6-GT are used principally for renewal purposes.

HEATER VOLTAGE (AC/DC).....	6.3	volts
HEATER CURRENT.....	0.7	ampere

**CLASS A<sub>1</sub> AMPLIFIER**

**Maximum Ratings:**

	<i>Pentode Connection</i>	<i>Triode Connection<sup>▲</sup></i>	
PLATE VOLTAGE.....	375 <i>max</i>	350 <i>max</i>	volts
GRID-NO.2 (SCREEN-GRID) VOLTAGE.....	285 <i>max</i>	-	volts
PLATE DISSIPATION.....	11 <i>max</i>	10 <i>max</i>	watts
GRID-NO.2 INPUT.....	3.75 <i>max</i>	-	watts
<b>PEAK HEATER-CATHODE VOLTAGE:</b>			
Heater negative with respect to cathode.....	90 <i>max</i>	90 <i>max</i>	volts
Heater positive with respect to cathode.....	90 <i>max</i>	90 <i>max</i>	volts

**Typical Operation:**

	<i>Pentode Connection</i>		<i>Triode Connection<sup>▲</sup></i>	
Plate Voltage.....	250	285	250	volts
Grid-No.2 Voltage.....	250	285	-	volts
Grid-No.1 (Control-Grid) Voltage.....	-16.5	-20	-20	volts
Peak AF Grid-No.1 Voltage.....	16.5	20	20	volts
Zero-Signal Plate Current.....	34	38	31	ma
Maximum-Signal Plate Current.....	36	40	34	ma
Zero-Signal Grid-No.2 Current.....	6.5	7	-	ma
Maximum-Signal Grid-No.2 Current.....	10.5	13	-	ma
Amplification Factor.....	-	-	6.8	
Plate Resistance (Approx.).....	80000	78000	2600	ohms
Transconductance.....	2500	2550	2600	μmhos
Load Resistance.....	7000	7000	4000	ohms
Total Harmonic Distortion.....	8	9	6.5	per cent
Maximum-Signal Power Output.....	3.2	4.8	0.85	watts

**PUSH-PULL CLASS A<sub>1</sub> AMPLIFIER**

Maximum Ratings. (Same as for class A<sub>1</sub> amplifier)

**Typical Operation** (Values are for two tubes):

Plate Voltage.....	315	volts
Grid-No.2 Voltage.....	285	volts
Grid-No.1 (Control-Grid) Voltage.....	-24	volts
Peak AF Grid-No.1-to-Grid-No.1 Voltage.....	48	volts
Zero-Signal Plate Current.....	62	ma
Maximum-Signal Plate Current.....	80	ma
Zero-Signal Grid-No.2 Current.....	12	ma
Maximum-Signal Grid-No.2 Current.....	19.5	ma
Effective Load Resistance (Plate-to-plate).....	10000	ohms
Total Harmonic Distortion.....	4	per cent
Maximum-Signal Power Output.....	11	watts

**Maximum Circuit Values:**

Grid-No.1 Circuit Resistance:		
For fixed-bias operation.....	0.1 <i>max</i>	megohm
For cathode-bias operation.....	0.5 <i>max</i>	megohm

▲ Grid No.2 connected to plate.

**LOW-MU TRIODE—  
REMOTE-CUTOFF PENTODE**

Glass type adaptable to circuit design in several ways. Outline 40, OUTLINES SECTION. Heater volts (ac/dc), 6.3; amperes, 0.3. Typical operation as class A<sub>1</sub> amplifier; pentode unit—plate volts, 250 *max*; grid-No.2 volts, 100; grid-No.1 volts, -3; plate resistance, 0.85 megohm; transconductance, 1100 μmhos; plate ma., 6.5; grid-No.2 ma., 1.5; triode unit—plate volts,

**6F7**

100 *max*; grid volts, -3; amplification factor, 8; plate resistance, 0.016 megohm; transconductance, 500 μmhos; plate ma., 3.5. This type is used principally for renewal purposes.

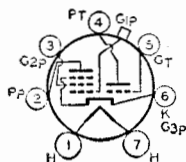

**MEDIUM-MU TWIN TRIODE**

Glass octal type used as voltage amplifier or phase inverter in radio equipment. Outline 39, OUTLINES SECTION. Tube requires octal socket. Except for the heater rating of 6.3 volts (ac/dc) and 0.6 ampere and interelectrode capacitances, each triode unit is identical electrically with type 6J5. Type 6F8-G is used principally for renewal purposes.

**6F8-G**

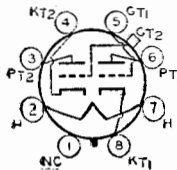

**DIODE—SHARP-CUTOFF,  
TWIN-PLATE TETRODE**

**6FA7**

Miniature type used in frequency-divider and complex-wave generator circuits of electronic musical instruments. Outline 14, OUTLINES SECTION. Tube requires miniature nine-contact socket and may be operated in any position.

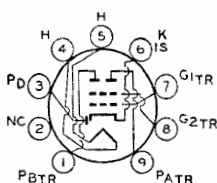

HEATER VOLTAGE (AC/DC).....	6.3	volts
HEATER CURRENT.....	0.3	ampere
DIRECT INTERELECTRODE CAPACITANCES: <sup>o</sup>		
Tetrode Unit:		
Grid No.1 to Plate A.....	0.040	$\mu$ f
Grid No.1 to Plate B.....	0.030 <i>max</i>	$\mu$ f
Grid No.1 to Cathode, Heater, Grid No.2, and Internal Shield.....	5.5	$\mu$ f
Plate A to Cathode, Heater, Grid No.2.....	1.8	$\mu$ f
Plate B to Cathode, Heater, Grid No.2, and Internal Shield.....	1.8	$\mu$ f
Tetrode Grid No.1 to Diode Plate.....	0.022	$\mu$ f
Tetrode Plate A to Diode Plate.....	0.020 <i>max</i>	$\mu$ f
Tetrode Plate B to Diode Plate.....	0.055	$\mu$ f

**FREQUENCY DIVIDER & COMPLEX-WAVE GENERATOR**  
*Tetrode Unit*

Maximum Ratings, (Design-Maximum Values):

PLATE-A VOLTAGE.....	330 <i>max</i>	volts
PLATE-B VOLTAGE.....	330 <i>max</i>	volts
GRID-NO.2 (SCREEN-GRID) SUPPLY VOLTAGE.....	330 <i>max</i>	volts
GRID-NO.2 VOLTAGE.....	See curve page 66	
GRID-NO.1 (CONTROL-GRID) VOLTAGE:		
Negative-bias value.....	50 <i>max</i>	volts
Positive-bias value.....	0 <i>max</i>	volts
PLATE-A DISSIPATION.....	1.5 <i>max</i>	watts
PLATE-B DISSIPATION.....	1.5 <i>max</i>	watts
GRID-NO.2 INPUT:		
For grid-No.2 voltages up to 165 volts.....	0.65 <i>max</i>	watt
For grid-No.2 voltages between 165 and 330 volts.....	See curve page 66	
PEAK HEATER-CATHODE VOLTAGE:		
Heater negative with respect to cathode.....	200 <i>max</i>	volts
Heater positive with respect to cathode.....	200 <i>max</i>	volts

Maximum Circuit Values:

Grid-No.1 Circuit Resistance:		
For grid-No.1 resistor-bias operation.....	2.2 <i>max</i>	megohms

*Diode Unit*

Maximum Ratings, (Design-Maximum Values):

PLATE CURRENT.....	1 <i>max</i>	ma
--------------------	--------------	----

Characteristics, Instantaneous Test Condition:

Plate Current for plate volts=10.....	2	ma
---------------------------------------	---	----

**CLASS A<sub>1</sub> AMPLIFIER**

Characteristics, (Tetrode Unit):

*Plate A and Plate B connected together*

Plate Voltage.....	100	volts
Grid-No.2 Voltage.....	100	volts
Grid-No.1 Supply Voltage.....	0	volts
Grid-No.1 Resistor (Bypassed).....	2.2	megohms
Plate Resistance (Approx.).....	90000	ohms
Transconductance.....	3200	$\mu$ mhos
Plate Current.....	3.8	ma
Grid-No.2 Current.....	1.7	ma
Grid-No.1 Voltage (Approx.) for plate $\mu$ a=20.....	-4	volts

*Using either Plate A or B, with unused plate grounded*

Plate Voltage.....	100	volts
Grid-No.2 Voltage.....	100	volts
Grid-No.1 Supply Voltage.....	0	volts
Grid-No.1 Resistor (Bypassed).....	2.2	megohms
Plate Resistance (Approx.).....	130000	ohms
Transconductance.....	1900	$\mu$ mhos
Plate Current.....	2.2	ma
Grid-No.2 Current.....	3	ma

<sup>o</sup> Without external shield.

■ The dc component must not exceed 100 volts.

## AVERAGE CHARACTERISTICS

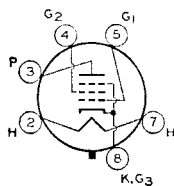
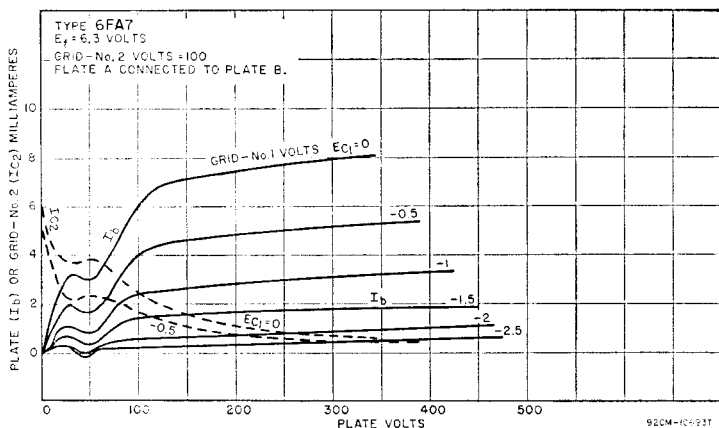

### BEAM POWER TUBE

Glass octal type used in the audio output stages of compact stereophonic phonographs and in radio and television receivers. Tube has high sensitivity at very low plate and screen-grid voltages; it can deliver relatively high power output at low values of plate load resistance. Outline 29, OUTLINES SECTION. Tube requires octal socket and may be mounted in any position.

## 6FE5

HEATER VOLTAGE (AC/DC).....	6.3	volts
HEATER CURRENT.....	1.2	amperes
DIRECT INTERELECTRODE CAPACITANCES (Approx.):		
Grid No.1 to Plate.....	0.44	μf
Grid No.1 to Cathode, Heater, Grid No.2, and Grid No.3.....	15	μf
Plate to Cathode, Heater, Grid No.2, and Grid No.3.....	9	μf

### CLASS A<sub>1</sub> AMPLIFIER

Maximum Ratings, (Design-Maximum Values):

PLATE VOLTAGE.....	175 max	volts
GRID-NO.2 (SCREEN-GRID) VOLTAGE.....	175 max	volts
GRID-NO.2 INPUT.....	2.4 max	watts
PLATE DISSIPATION.....	14.5 max	watts
PEAK HEATER-CATHODE VOLTAGE:		
Heater negative with respect to cathode.....	300 max	volts
Heater positive with respect to cathode.....	200 max	volts

Typical Operation:

	<i>Fixed Bias</i>		<i>Cathode Bias</i>		
Plate Supply Voltage.....	130	145	130	145	volts
Grid-No.2 Supply Voltage.....	130	145	130	145	volts
Grid-No.1 (Control-Grid) Voltage.....	-12.5	-16	-	-	volts
Cathode-Bias Resistor.....	-	-	120	150	ohms
Peak AF Grid-No.1 Voltage.....	12.5	15	11.9	15.4	volts
Zero-Signal Plate Current.....	82	80	88	86	ma
Maximum-Signal Plate Current.....	94	100	90	86	ma
Zero-Signal Grid-No.2 Current.....	4	4	5	4.2	ma
Maximum-Signal Grid-No.2 Current.....	15	18	9	17	ma
Plate Resistance (Approx.).....	-	-	8000	-	ohms
Transconductance.....	-	-	9500	-	μmhos
Load Resistance.....	1000	1000	1000	1000	ohms
Total Harmonic Distortion.....	12	15	10	13	per cent
Maximum-Signal Power Output.....	4.2	5.6	3.5	4.3	watts

**PUSH-PULL CLASS A<sub>1</sub> AMPLIFIER**

Maximum Ratings, (Design-Maximum Values): (Same as for class A<sub>1</sub> amplifier)

Typical Operation (Values are for two tubes):

Plate Supply Voltage.....	130	145	volts
Grid-No.2 Supply Voltage.....	130	145	volts
Cathode-Bias Resistor.....	75	75	ohms
Peak AF Grid-No.1-to-Grid-No.1 Voltage.....	25.8	28.8	volts
Zero-Signal Plate Current.....	150	160	ma
Maximum-Signal Plate Current.....	164	172	ma
Zero-Signal Grid-No.2 Current.....	7.2	8	ma
Maximum-Signal Grid-No.2 Current.....	17	20	ma
Effective Load Resistance (Plate-to-plate).....	1600	1600	ohms
Total Harmonic Distortion.....	6	6	per cent
Maximum-Signal Power Output.....	7	8.5	watts

**Maximum Circuit Values:**

Grid-No.1-Circuit Resistance:		
For fixed-bias operation.....	0.1 max	megohm
For cathode-bias operation.....	0.5 max	megohm

■ The dc component must not exceed 100 volts.

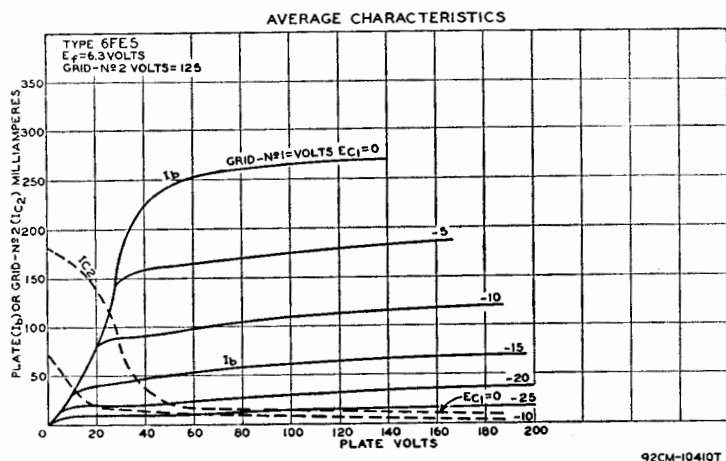
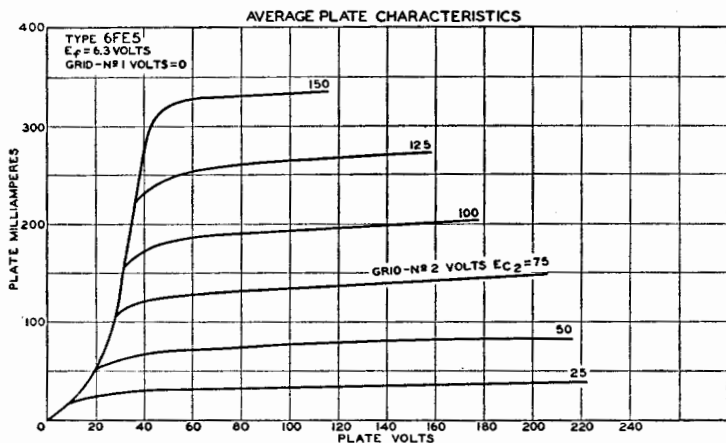

Refer to type EM84/6FG6

6FG6

6FH5

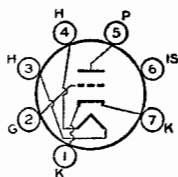

**HIGH-MU TRIODE**

Miniature type used as an rf amplifier in vhf tuners of television receivers. Outline 11, OUTLINES SECTION. Tube requires seven-contact socket and may be mounted in any position.

HEATER VOLTAGE (AC/DC).....	6.3	volts
HEATER CURRENT.....	0.2	ampere
DIRECT INTERELECTRODE CAPACITANCES (Approx.):		
Grid to Plate.....	0.52	$\mu\text{f}$
Grid to Cathode, Internal Shield, and Heater.....	3.2	$\mu\text{f}$
Plate to Cathode, Internal Shield, and Heater.....	3.2	4 $\mu\text{f}$

Without External Shield
With External Shield\*

\* With external shield connected to cathode.

**CLASS A<sub>1</sub> AMPLIFIER**

Maximum Ratings, (Design-Maximum Values):

PLATE VOLTAGE.....	150 max	volts
GRID VOLTAGE, Positive-bias value.....	0 max	volts
CATHODE CURRENT.....	22 max	ma
PLATE DISSIPATION.....	2.2 max	watts
PEAK HEATER-CATHODE VOLTAGE:		
Heater negative with respect to cathode.....	100 max	volts
Heater positive with respect to cathode.....	100 max	volts

**Characteristics:**

Plate Voltage.....	135	volts
Grid Voltage.....	-1	volt
Plate Resistance (Approx.).....	5600	ohms
Transconductance.....	9000	$\mu\text{mhos}$
Plate Current.....	11	ma
Grid Voltage (Approx.) for plate current of 100 $\mu\text{a}$ .....	-5.5	volts

**Maximum Circuit Values:**

Grid-Circuit Resistance:	
For cathode-bias operation.....	1 max megohm

AVERAGE PLATE CHARACTERISTICS

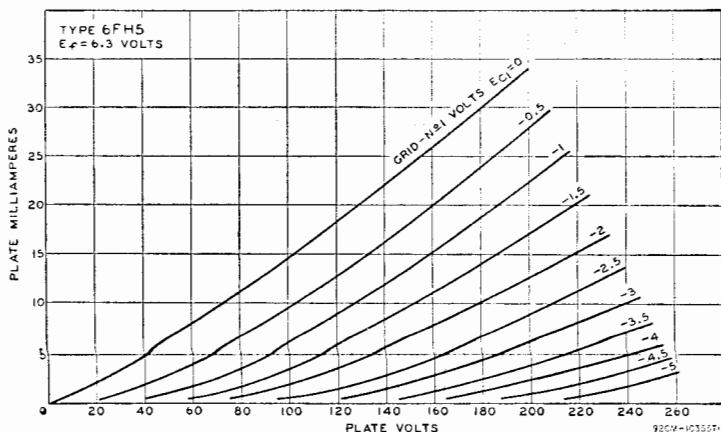

# 6FH8

## MEDIUM-MU TRIODE— THREE-PLATE TETRODE

Miniature type used in complex-wave generator applications. Sharp-cutoff tetrode unit has pair of additional plates. Outline 12, OUTLINES SECTION. Tube requires nine-contact socket and may be mounted in any position.

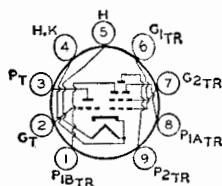

HEATER VOLTAGE (AC/DC).....	6.3	volts
HEATER CURRENT.....	0.45	ampere
DIRECT INTERELECTRODE CAPACITANCES: <sup>o</sup>		
Triode Unit:		
Grid to Plate.....	1.4	μf
Grid to Cathode and Heater.....	2.6	μf
Plate to Cathode and Heater.....	1	μf
Tetrode Unit:		
Grid No.1 to Plate No.2.....	0.06 max	μf
Grid No.1 to Cathode, Heater, Grid No.2, Plate No.1A, and Plate No.1B	4.5	μf
Plate No.2 to Cathode, Heater, Grid No.2, Plate No.1A, and Plate No.1B	1.4	μf
Tetrode Grid No.1 to Triode Plate.....	0.35 max	μf
Tetrode Plate No.2 to Triode Plate.....	0.008 max	μf

**Characteristics, Class A<sub>1</sub> Amplifier:**

	<i>Triode Unit</i>	
Plate Voltage.....	100	volts
Grid Voltage.....	-1	volt
Amplification Factor.....	40	
Plate Resistance (Approx.).....	7400	ohms
Transconductance.....	5400	μmhos
Plate Current.....	7.9	ma
Grid Voltage (Approx.) for plate current of 100 μa.....	-7	volts

*Tetrode Unit with Plates No. 1A and No. 1B Connected to Cathode at Socket*

Plate-No.2 Voltage.....	250	volts
Grid-No.2 Voltage.....	250	volts
Grid-No.1 Voltage.....	-2	volts
Plate-No.2 Resistance (Approx.).....	0.75	megohm
Transconductance, Grid No.1 to Plate No.2.....	4400	μmhos
Plate-No.2 Current.....	7.3	ma
Grid-No.2 Current.....	1.4	ma
Grid-No.1 Voltage (Approx.) for plate No.2 current of 100 μa.....	-7	volts

### COMPLEX-WAVE GENERATOR

**Maximum Ratings, (Design-Maximum Values):**

	<i>Triode Unit</i>	<i>Tetrode Unit</i>	
PLATE VOLTAGE.....	275 max	-	volts
PLATE-NO.1A VOLTAGE.....	-	200 max	volts
PLATE-NO.1B VOLTAGE.....	-	200 max	volts
PLATE-NO.2 VOLTAGE.....	-	275 max	volts
GRID-NO.2 (SCREEN-GRID) SUPPLY VOLTAGE.....	-	275 max	volts
GRID-NO.2 VOLTAGE.....	-	See curve page 66	
GRID-NO.1 (CONTROL-GRID) VOLTAGE:			
Negative-bias value.....	40 max	40 max	volts
Positive-bias value.....	0 max	0 max	volts
PLATE DISSIPATION.....	1.7 max	-	watts
PLATE-NO.1A DISSIPATION.....	-	0.3 max	watt
PLATE-NO.1B DISSIPATION.....	-	0.3 max	watt
PLATE-NO.2 DISSIPATION.....	-	2.3 max	watts
GRID-NO.2 INPUT:			
For grid-No.2 voltages up to 137.5 volts.....	-	0.45 max	watt
For grid-No.2 voltages between 137.5 and 275 volts.....	-	See curve page 66	

**Typical Operation With Separate Plate Operation (Tetrode Unit):**

Plates-No.1A, No.1B, and No.2 Voltage.....	100	volts
Grid-No.2 Voltage.....	50	volts
Grid-No.1 Voltage.....	-1	volt
Plate-No.1A Current.....	0.04	ma
Plate-No.1B Current.....	0.04	ma
Plate-No.2 Current.....	1.6	ma
Grid-No.2 Current.....	0.3	ma
Transconductance (Approx.):		
Grid No.1 to Plate No.1A.....	70	μmhos
Grid No.1 to Plate No.1B.....	70	μmhos
Grid No.1 to Plate No.2.....	2500	μmhos

**Maximum Circuit Values:**

Grid-No.1-Circuit Resistance:	<i>Triode Unit</i>	<i>Tetrode Unit</i>	
For fixed-bias operation.....	0.5 max	0.5 max	megohm



### TWIN DIODE—HIGH-MU TRIODE

Miniature type used as combined FM detector and af voltage amplifier in FM receivers. Outline 12, OUTLINES SECTION. Tube requires miniature nine-contact socket and may be operated in any position.

## 6FM8

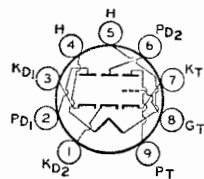

HEATER VOLTAGE (AC/DC).....	6.3	volts
HEATER CURRENT.....	0.45	ampere

#### TRIODE UNIT AS CLASS A<sub>1</sub> AMPLIFIER

Maximum Ratings, (Design-Maximum Values):

PLATE VOLTAGE.....	330 <i>max</i>	volts
GRID VOLTAGE, Positive bias value.....	0 <i>max</i>	volts
PLATE DISSIPATION.....	1.1 <i>max</i>	watts
PEAK HEATER-CATHODE VOLTAGE:		
Heater negative with respect to cathode.....	200 <i>max</i>	volts
Heater positive with respect to cathode.....	200° <i>max</i>	volts

Characteristics:

Plate Voltage.....	250	volts
Grid Voltage.....	-3	volts
Amplification Factor.....	70	
Plate Resistance (Approx.).....	58000	ohms
Transconductance.....	12000	μmhos
Plate Current.....	1	ma

#### DIODE UNITS AS CLASS A<sub>1</sub> AMPLIFIER

(Each Unit)

Maximum Ratings, (Design-Maximum Values):

PLATE CURRENT.....	5 <i>max</i>	ma
PEAK HEATER-CATHODE VOLTAGE:		
Heater negative with respect to cathode.....	200 <i>max</i>	volts
Heater positive with respect to cathode.....	200° <i>max</i>	volts

Characteristics, Instantaneous Test Condition:

Plate Current, for plate volts=5.....	20	ma
---------------------------------------	----	----

° The dc component must not exceed 100 volts.

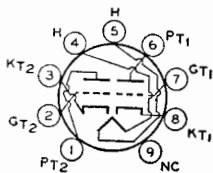

### MEDIUM-MU TWIN TRIODE

Miniature type used as combined vertical- and horizontal-deflection oscillator in television receivers. Outline 14, OUTLINES SECTION. Tube requires miniature nine-contact socket

## 6FQ7

and may be operated in any position. Except for direct interelectrode capacitances, this type is identical with miniature type 6CG7.

HEATER VOLTAGE (AC/DC).....	6.3	volts
HEATER CURRENT.....	0.6	ampere
HEATER WARM-UP TIME (AVERAGE).....	11	seconds

DIRECT INTERELECTRODE CAPACITANCES (Approx.) <sup>°</sup>		<i>Unit No. 1</i>	<i>Unit No. 2</i>	
Grid to Plate.....	3.6	3.8		μf
Grid to Cathode and Heater.....	2.4	2.4		μf
Plate to Cathode and Heater.....	0.34	0.26		μf
Plate of Unit No.1 to Plate of Unit No.2.....			1	μf

° Without external shield.

### SHARP-CUTOFF TETRODE

Miniature type used as rf amplifier in vhf tuners of television receivers. Outline 11, OUTLINES SECTION. Tube requires seven-contact socket and may be mounted in any position.

## 6FV6

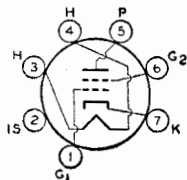

HEATER VOLTAGE (AC/DC).....	6.3	volts
HEATER CURRENT.....	0.2	ampere
DIRECT INTERELECTRODE CAPACITANCES: <sup>o</sup>		
Grid No.1 to Plate.....	0.03 <i>max</i>	$\mu\mu\text{f}$
Grid No.1 to Cathode, Heater, Grid No.2, and Internal Shield.....	4.5	$\mu\mu\text{f}$
Plate to Cathode, Heater, Grid No.2, and Internal Shield.....	3	$\mu\mu\text{f}$
Cathode to Heater.....	2.7 <sup>*</sup>	$\mu\mu\text{f}$

- <sup>o</sup> With external shield connected to cathode except as noted.  
<sup>\*</sup> With external shield connected to ground.

### CLASS A<sub>1</sub> AMPLIFIER

#### Maximum Ratings, (Design-Maximum Values):

PLATE VOLTAGE.....	275 <i>max</i>	volts
GRID-NO.2 (SCREEN-GRID) SUPPLY VOLTAGE.....	180 <i>max</i>	volts
GRID-NO.2 VOLTAGE.....	See curve page 66	
GRID-NO.1 (CONTROL-GRID) VOLTAGE, Positive bias value.....	0 <i>max</i>	volts
CATHODE CURRENT.....	20 <i>max</i>	ma
GRID-NO.2 INPUT:		
For grid-No.2 voltages up to 90 volts.....	0.5 <i>max</i>	watt
For grid-No.2 voltages between 90 and 180 volts.....	See curve page 66	
PLATE DISSIPATION.....	2 <i>max</i>	watts
PEAK HEATER-CATHODE VOLTAGE:		
Heater negative with respect to cathode.....	200 <i>max</i>	volts
Heater positive with respect to cathode.....	200 <sup>*</sup> <i>max</i>	volts

#### Characteristics:

Plate Voltage.....	125	volts
Grid-No.2 Voltage.....	80	volts
Grid-No.1 Voltage.....	-1	volt
Plate Resistance (Approx.).....	0.1	megohm
Transconductance.....	8000	$\mu\text{mhos}$
Plate Current.....	10	ma
Grid-No.2 Current.....	1.5	ma
Grid-No.1 Voltage (Approx.) for plate current of 20 $\mu\text{a}$ .....	-6	volts

#### Maximum Circuit Value:

Grid-No.1-Circuit Resistance.....	0.5 <i>max</i>	megohm
-----------------------------------	----------------	--------

<sup>o</sup> The dc component must not exceed 100 volts.

### MEDIUM-MU TRIODE— SHARP-CUTOFF PENTODE

## 6FV8

Miniature type used in television receivers as combined oscillator and amplifier. Triode is used as vertical deflection oscillator; pentode is used as if or general-purpose amplifier. Out-

line 12, OUTLINES SECTION. Tube requires nine-contact socket and may be operated in any position. Heater volts (ac/dc), 6.3; amperes, 0.45; heater warm-up time (average), 11 seconds.

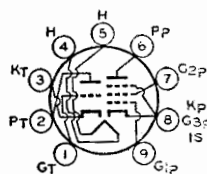

### VERTICAL-DEFLECTION OSCILLATOR—TRIODE UNIT

*For operation in a 525-line, 30-frame system*

#### Maximum Ratings, (Design-Maximum Values):

DC PLATE VOLTAGE.....	330 <i>max</i>	volts
PEAK NEGATIVE-PULSE GRID VOLTAGE.....	250 <i>max</i>	volts
PEAK CATHODE CURRENT.....	70 <i>max</i>	ma
AVERAGE CATHODE CURRENT.....	20 <i>max</i>	ma
PLATE DISSIPATION.....	2 <i>max</i>	watts
PEAK HEATER-CATHODE VOLTAGE:		
Heater negative with respect to cathode.....	200 <i>max</i>	volts
Heater positive with respect to cathode.....	200 <sup>o</sup> <i>max</i>	volts

#### Maximum Circuit Values:

Grid-Circuit Resistance:	
For cathode-bias operation.....	3 <i>max</i> megohms

## CLASS A<sub>1</sub> AMPLIFIER

*Pentode Unit*

**Maximum Ratings, (Design-Maximum Values):**

PLATE VOLTAGE.....	330 <i>max</i>	volts
GRID-NO.2 (SCREEN-GRID) SUPPLY VOLTAGE.....	330 <i>max</i>	volts
GRID-NO.2 VOLTAGE.....	See curve page 66	
GRID-NO.1 (CONTROL-GRID) VOLTAGE, Positive-bias value.....	0 <i>max</i>	volts
PLATE DISSIPATION.....	2.3 <i>max</i>	watts
GRID-NO.2 INPUT:		
For grid-No.2 voltages up to 165 volts.....	0.55 <i>max</i>	watt
For grid-No.2 voltages between 165 and 330 volts.....	See curve page 66	
PEAK HEATER-CATHODE VOLTAGE:		
Heater negative with respect to cathode.....	200 <i>max</i>	volts
Heater positive with respect to cathode.....	200 <sup>o</sup> <i>max</i>	volts

**Maximum Circuit Values:**

Grid-No.1-Circuit Resistance:		
For fixed-bias operation.....	0.25 <i>max</i>	megohm
For cathode-bias operation.....	1 <i>max</i>	megohm

**Characteristics:**

	<i>Triode Unit</i>	<i>Pentode Unit</i>	
Plate Voltage.....	125	125	volts
Grid-No.2 Voltage.....	—	125	volts
Grid-No.1 Voltage.....	—1	—1	volt
Amplification Factor.....	40	—	
Plate Resistance (Approx.).....	5000	200000	ohms
Transconductance.....	8000	6500	μmhos
Grid-No.1 Voltage (Approx.) for plate current of 20 μa.....	—9	—9	volts
Plate Current.....	14	12	ma
Grid-No.2 Current.....	—	4	ma

° The dc component must not exceed 100 volts.

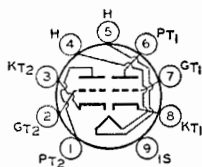

## MEDIUM-MU TWIN TRIODE

Miniature type used in direct-coupled cathode-drive rf-amplifier circuits of vhf television tuners. In such circuits, one triode unit is used as the direct-coupled grounded-cathode driver for the other unit. Outline 12, OUTLINES SECTION. Tube requires nine-contact socket and may be mounted in any position. Heater voltage (ac/dc), 6.3; amperes, 0.4. This type is used principally for renewal purposes.

# 6FW8

## CLASS A<sub>1</sub> AMPLIFIER (Each Unit)

**Maximum Ratings, (Design-Maximum Values):**

PLATE VOLTAGE.....	250 <sup>▲</sup> <i>max</i>	volts
PLATE DISSIPATION.....	2.2 <i>max</i>	watts
CATHODE CURRENT.....	22 <i>max</i>	ma
PEAK HEATER-CATHODE VOLTAGE:		
Heater negative with respect to cathode.....	200 <sup>▲</sup> <i>max</i>	volts
Heater positive with respect to cathode.....	200 <sup>▲</sup> <i>max</i>	volts

**Characteristics:**

Plate Voltage.....	100	volts
Grid Voltage.....	—1.2	volts
Amplification Factor.....	33	
Plate Resistance (Approx.).....	2500	ohms
Transconductance.....	13000	μmhos
Plate Current.....	15	ma
Grid Volts (Approx.) for transconductance of 70 μmhos.....	—6	volts

**Maximum Circuit Value:**

Grid-Circuit Resistance.....	0.5 <i>max</i>	megohm
------------------------------	----------------	--------

▲ Under cutoff conditions in cascode-type circuits with direct-coupled drive, this voltage may be as high as 300 volts.

■ The dc component must not exceed 100 volts.

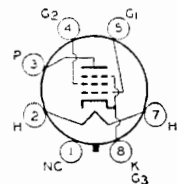

## POWER PENTODE

Glass octal type used in output stage of radio receivers where moderate power output is required. Outline 36, OUTLINES SECTION. Tube requires octal socket. Except for inter-electrode capacitances and a plate resistance of 175000 ohms, this type is electrically identical with type 6AK6. Heater volts (ac/dc), 6.3; amperes, 0.15. Type 6G6-G is used principally for renewal purposes.

# 6G6-G

**MEDIUM-MU TRIODE—  
SHARP-CUTOFF PENTODE**

**6GH8**

Miniature type used in multi-  
brator-type horizontal-deflection cir-  
cuits in television receivers. Also used  
for agc-amplifier or sync-separator ap-  
plications in such receivers. Outline 12,

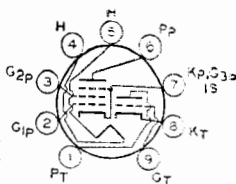

OUTLINES SECTION. Tube requires miniature nine-contact socket and may be mounted in any position.

HEATER VOLTAGE (AC/DC).....	6.3	vols
HEATER CURRENT.....	0.45	ampere-
HEATER WARM-UP TIME (Average).....	11	seconds

**DIRECT INTERELECTRODE CAPACITANCES:**

Triode Unit:	Without External Shield	With External Shield	
Grid to Plate.....	1.6	1.6	$\mu\text{f}$
Grid to Cathode, Heater, Pentode Grid No.3, Pentode Cathode, and Internal Shield.....	3.4	3.6	$\mu\text{f}$
Plate to Cathode, Heater, Pentode Grid No.3, Pentode Cathode, and Internal Shield.....	1.7	2.2	$\mu\text{f}$
Heater to Cathode.....	3	3*	$\mu\text{f}$
<b>Pentode Unit:</b>			
Grid No.1 to Plate.....	0.02 max	0.015 max	$\mu\text{f}$
Grid No.1 to Cathode, Heater, Grid No.2, Grid No.3, and Internal Shield.....	5.5	5.5	$\mu\text{f}$
Plate to Cathode, Heater, Grid No.2, Grid No.3, and Internal Shield.....	2.6	3.4	$\mu\text{f}$
Heater to Cathode, Grid No.3, and Internal Shield.....	3	3*	$\mu\text{f}$

\* With external shield connected to cathode of unit under test except as noted.

• With external shield connected to ground.

**HORIZONTAL-DEFLECTION OSCILLATOR**

For operation in a 525-line, 30-frame system

**Maximum Ratings, (Design-Maximum Values):**

	Triode Unit	Pentode Unit	
PLATE VOLTAGE.....	330 max	350 max	vols
GRID-NO.2 (SCREEN-GRID) SUPPLY VOLTAGE.....	—	330 max	vols
GRID-NO.2 VOLTAGE.....	—	See curve page 66	
<b>GRID-NO.1 (CONTROL-GRID) VOLTAGE:</b>			
Positive-bias value.....	0 max	0 max	vols
Peak negative value.....	—	-175 max	vols
PEAK CATHODE CURRENT.....	—	300 max	ma
AVERAGE CATHODE CURRENT.....	—	20 max	ma

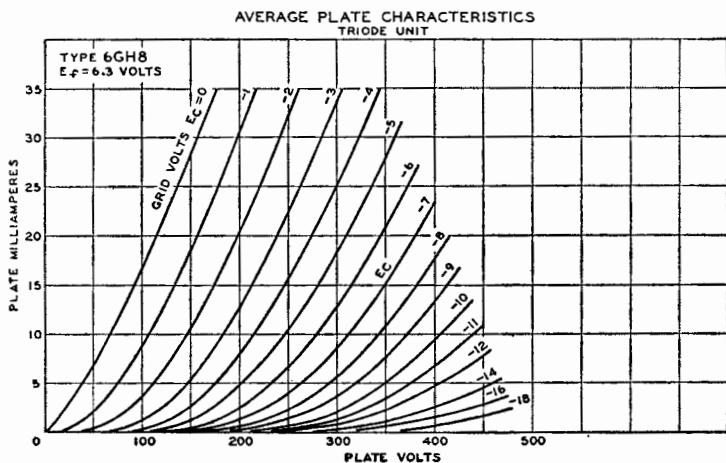

92CM-10421T3

**GRID-NO.2 INPUT:**

For grid-No.2 voltages up to 165 volts..... - 0.55 max watt  
 For grid-No.2 voltages between 165 and 330 volts..... - See curve page 66

**PLATE DISSIPATION..... 2.5 max 2.5 max watts**

**PEAK HEATER-CATHODE VOLTAGE:**

Heater negative with respect to cathode..... 200 max 200 max volts  
 Heater positive with respect to cathode..... 200 max 200 max volts

■ The dc component must not exceed 100 volts.

**Maximum Circuit Values:**

Grid-No.1-Circuit Resistance:  
 For fixed-bias operation..... 2.2 max 2.2 max megohms  
 For cathode-bias operation..... 2.2 max 2.2 max megohms

**CLASS A<sub>1</sub> AMPLIFIER**

**Characteristics:**

	<i>Triode Unit</i>	<i>Pentode Unit</i>	
Plate Voltage.....	125	125	volts
Grid-No.2 Voltage.....	-	125	volts
Grid-No.1 Voltage.....	-1	-1	volts
Amplification Factor.....	46	-	
Plate Resistance (Approx.).....	5400	200000	ohms
Transconductance.....	8500	7500	μmhos
Plate Current.....	13.5	12	ma
Grid-No.2 Current.....	-	4	ma
Grid-No.1 Voltage (Approx.) for plate current of 10 μa.....	-8	-8	volts

**AVERAGE CHARACTERISTICS  
PENTODE UNIT**

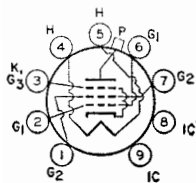
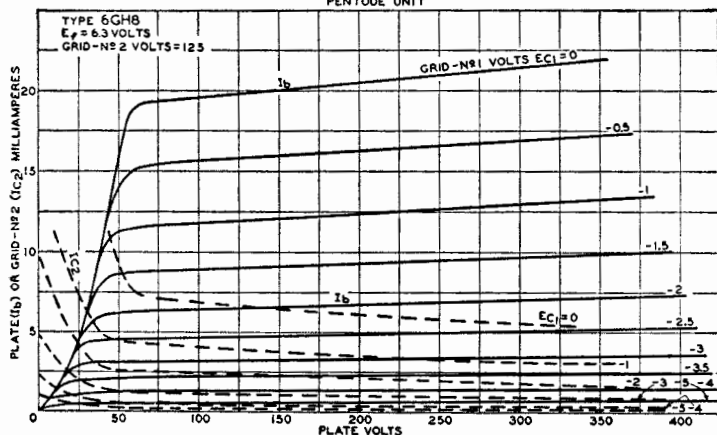

**BEAM POWER TUBE**

Novar type used in high-efficiency horizontal-deflection-amplifier circuits of television receivers. Outline 55, OUTLINES SECTION. Tube requires novar nine-contact socket and may be

**6GJ5**

operated in any position. For curve of average characteristics see type 6GW6.

HEATER VOLTAGE (AC/DC).....	6.3	volts
HEATER CURRENT.....	1.2	amperes
<b>DIRECT INTERELECTRODE CAPACITANCES (Approx.)<sup>o</sup></b>		
Grid No.1 to Plate.....	0.26	μμf
Grid No.1 to Cathode, Heater, Grid No.2, and Grid No.3.....	15	μμf
Plate to Cathode, Heater, Grid No.2, and Grid No.3.....	6.5	μμf

## HORIZONTAL-DEFLECTION AMPLIFIER

For operation in a 525-line, 30-frame system

### Maximum Ratings, (Design-Maximum Values):

DC PLATE SUPPLY VOLTAGE.....	770 <i>max</i>	volts
PEAK POSITIVE-PULSE PLATE VOLTAGE <sup>1</sup> .....	6500 <i>max</i>	volts
PEAK NEGATIVE-PULSE PLATE VOLTAGE.....	1500 <i>max</i>	volts
DC GRID-NO.2 VOLTAGE.....	220 <i>max</i>	volts
DC GRID-NO.1 VOLTAGE.....	-55 <i>max</i>	volts
PEAK NEGATIVE-PULSE GRID-NO.1 VOLTAGE.....	330 <i>max</i>	volts
PEAK CATHODE CURRENT.....	550 <i>max</i>	ma
AVERAGE CATHODE CURRENT.....	175 <i>max</i>	ma
PLATE DISSIPATION <sup>2</sup> .....	17.5 <i>max</i>	watts
GRID-NO.2 INPUT.....	3.5 <i>max</i>	watts
PEAK HEATER-CATHODE VOLTAGE:		
Heater negative with respect to cathode.....	200 <i>max</i>	volts
Heater positive with respect to cathode.....	200 <sup>3</sup> <i>max</i>	volts
BULB TEMPERATURE (At hottest point).....	240 <i>max</i>	°C

### Maximum Circuit Values:

Grid-No.1-Circuit Resistance:		
For grid-resistor-bias operation <sup>4</sup> .....	1 <i>max</i>	megohm

### CLASS A<sub>1</sub> AMPLIFIER

Characteristics:	<i>Triode Connection</i>	<i>Pentode Connection</i>	
Plate Voltage.....	150	60	250 volts
Grid-No.2 Voltage.....	150	150	150 volts
Grid-No.1 Voltage.....	-22.5	0	-22.5 volts
Mu-Factor, grid No.2 to grid No.1.....	4.4	-	
Plate Resistance (Approx.).....	-	-	15000 ohms
Transconductance.....	-	7100	μmhos
Plate Current.....	-	390 <sup>2</sup>	70 ma
Grid-No.2 Current.....	-	32 <sup>2</sup>	2.1 ma
Grid-No.1 Voltage, for plate ma=1.....	-	-	-42 volts

<sup>1</sup> Without external shield.

<sup>2</sup> The dc component must not exceed 100 volts.

<sup>3</sup> An adequate bias resistor or other means is required to protect the tube in the absence of excitation. This value can be measured by a method involving a recurrent wave form such that the maximum ratings of the tube will not be exceeded.

<sup>4</sup> The duration of the voltage pulse must not exceed 15 per cent of one horizontal scanning cycle. In a 325-line, 30-frame system, 15 per cent of one horizontal scanning cycle is 10 microseconds.

### MEDIUM-MU TRIODE— SHARP-CUTOFF PENTODE

Miniature type used as oscillator in horizontal deflection circuits of television receivers. Outline 12, OUTLINES SECTION. Tube requires miniature nine-contact socket and may be operated in any position. Heater volts (ac/dc) *in series*: 6.3; amperes, 0.3. Heater volts *in parallel*: 3.15; amperes, 0.6. Heater warm-up time (average), 11 seconds. Characteristics as class A<sub>1</sub> Amplifier, **triode unit**: plate volts, 125;

grid volts, -1; amplification factor, 40; plate resistance (approx.), 5000 ohms; transconductance, 8500 μmhos; plate ma., 13.5; **pentode unit**: plate, grid-No.2 volts, 125; grid-No.1 volts, -1; plate resistance (approx.), 150,000 ohms; transconductance, 7500 μmhos; plate ma., 12; grid-No.2 ma., 4.5. Maximum ratings as horizontal-deflection oscillator (*design-maximum values*), **triode unit**: plate volts, 330 *max*; grid volts, positive-bias value, 0 *max*; plate dissipation, 2.5 *max* watts; **pentode unit**: plate, grid-No.2 volts, 330 *max*; grid No.1, positive-bias value, 0 *max*; grid No.1, positive-bias value, 0 *max* volts; plate dissipation, 2.5 *max* watts. This is a DISCONTINUED TYPE listed for reference purposes only.

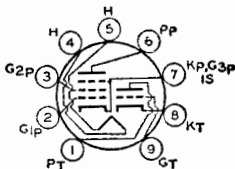

## 6GJ8

### HIGH-MU TRIODE

Miniature type used as a grounded-cathode rf-amplifier tube in vhf tuners of television receivers. Outline 11, OUTLINES SECTION. Tube requires miniature seven-contact socket and may be operated in any position.

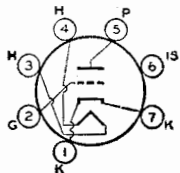

## 6GK5

HEATER VOLTAGE (AC/DC).....	6.3	volts
HEATER CURRENT.....	0.18	ampere
DIRECT INTERELECTRODE CAPACITANCES (Approx.): <sup>o</sup>		
Grid to Plate.....	0.52	μf
Grid to Cathode, Heater, and Internal Shield.....	5	μf
Plate to Cathode, Heater, and Internal Shield.....	3.5	μf
Heater to Cathode.....	2.5 <sup>1</sup>	μf

## CLASS A<sub>1</sub> AMPLIFIER

### Maximum Ratings, (Design-Maximum Values):

PLATE VOLTAGE.....	200 <i>max</i>	volts
GRID VOLTAGE:		
Negative-bias value.....	50 <i>max</i>	volts
Positive-bias value.....	0 <i>max</i>	volts
AVERAGE CATHODE CURRENT.....	22 <i>max</i>	ma
PLATE DISSIPATION.....	2.5 <i>max</i>	watts
PEAK HEATER-CATHODE VOLTAGE:		
Heater negative with respect to cathode.....	100 <i>max</i>	volts
Heater positive with respect to cathode.....	100 <i>max</i>	volts

### Characteristics:

Plate Voltage.....	135	volts
Grid Voltage.....	-1	volt
Amplification Factor.....	78	
Plate Resistance (Approx.).....	5400	ohms
Transconductance.....	15000	$\mu$ mhos
Plate Current.....	11.5	ma
Grid Voltage (Approx.) for transconductance of 150 $\mu$ mhos.....	-4.2	volts
Grid Voltage (Approx.) for transconductance of 15000 $\mu$ mhos.....	-2.5	volts
Input Resistance.....	275	ohms
Input Capacitance.....	11.2	$\mu$ f
Noise Figure.....	4.7	db

### Maximum Circuit Values:

- Grid-Circuit Resistance:
- For cathode-bias operation..... 1 *max* megohm
- With external shield connected to cathode, except as noted.
  - With external shield and internal shield connected to ground.
  - Measured at 200 Mc with heater volts = 6.3 and plate effectively grounded for rf voltages.
  - For a neutralized triode amplifier at a frequency of 200 Mc with signal source impedance adjusted for minimum noise output.

AVERAGE PLATE CHARACTERISTICS

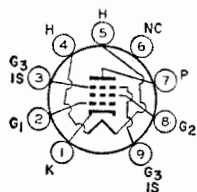
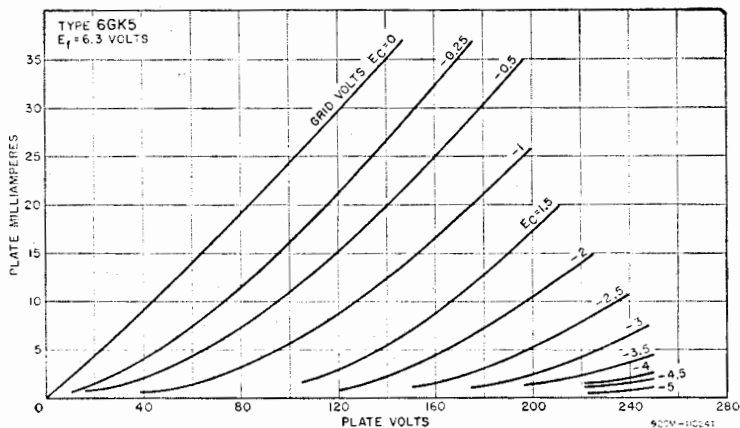

## POWER PENTODE

Miniature type used in the output stage of audio amplifying equipment and also in the video output stage of television receivers. Outline 18, OUT-LINES SECTION. Tube requires

# 6GK6

miniature nine-contact socket and may be operated in any position.

HEATER VOLTAGE (AC/DC).....	6.3	volts
HEATER CURRENT.....	0.76	ampere
DIRECT INTERELECTRODE CAPACITANCES:◦		
Grid No.1 to Plate.....	0.14 <i>max</i>	$\mu$ f
Grid No.1 to Cathode, Heater, Grid No.2, Grid No.3, and Internal Shield.....	10	$\mu$ f
Plate to Cathode, Heater, Grid No.2, Grid No.3, and Internal Shield.....	7	$\mu$ f

◦ Without external shield.

## CLASS A<sub>1</sub> AMPLIFIER

### Maximum Ratings: (Design-Maximum Values):

PLATE SUPPLY VOLTAGE.....	600 <i>max</i>	volts
PLATE VOLTAGE.....	330 <i>max</i>	volts
GRID-NO.2 SUPPLY VOLTAGE.....	405 <i>max</i>	volts
GRID-NO.2 (SCREEN-GRID) VOLTAGE.....	330 <i>max</i>	volts
GRID-NO.1 (CONTROL-GRID) VOLTAGE, Negative-bias value.....	100 <i>max</i>	volts
CATHODE CURRENT.....	65 <i>max</i>	ma
PLATE DISSIPATION.....	13.2 <i>max</i>	watts
GRID-NO.2 INPUT, Peak.....	4 <i>max</i>	watts
GRID-NO.2 INPUT, Average.....	2 <i>max</i>	watts
PEAK HEATER-CATHODE VOLTAGE:		
Heater negative with respect to cathode.....	100 <i>max</i>	volts
Heater positive with respect to cathode.....	100 <i>max</i>	volts

### Characteristics and Typical Operation:

Plate Supply Voltage.....	250	volts
Grid-No.2 Supply Voltage.....	250	volts
Cathode-Bias Resistor.....	135	ohms
Mu-Factor, Grid No.2 to Grid No.1.....	19	
Plate Resistance (Approx.).....	38000	ohms
Transconductance.....	11300	$\mu$ ohms
Peak AF Grid-No.1 Voltage.....	7.3	volts
Zero-Signal Plate Current.....	48	ma
Maximum-Signal Plate Current.....	50.6	ma
Zero-Signal Grid-No.2 Current.....	5.5	ma
Maximum-Signal Grid-No.2 Current.....	10	ma
Effective Load Resistance.....	5200	ohms
Total Harmonic Distortion.....	10	per cent
Maximum-Signal Power Output.....	5.7	watts

## PUSH-PULL CLASS AB<sub>1</sub> and B AMPLIFIER

### Maximum Ratings: (Same as for class A<sub>1</sub> amplifier)

#### Typical Operation, (Values are for two tubes):

	Class AB <sub>1</sub>		Class B		
Plate Voltage.....	250	300	250	300	volts
Grid-No.2 Voltage.....	250	300	250	300	volts
Grid-No.1 Voltage.....	—	—	-11.6	-14.7	volts
Cathode-Bias Resistor.....	130	130	—	—	ohms
Peak AF Grid-No.1-to-Grid-No.1 Voltage.....	22.4	28	22.4	28	volts
Zero-Signal Plate Current.....	62	72	20	15	ma
Maximum-Signal Plate Current.....	75	92	75	92	ma
Zero-Signal Grid-No.2 Current.....	7	8	2.2	1.6	ma
Maximum-Signal Grid-No.2 Current.....	15	22	15	22	ma
Effective Load Resistance (plate to plate).....	8000	8000	8000	8000	ohms
Total Harmonic Distortion.....	3	4	3	4	per cent
Maximum-Signal Power Output.....	11	17	11	17	watts

### Maximum Circuit Values:

Grid-No.1-Circuit Resistance:		
For fixed-bias operation.....	0.3 <i>max</i>	megohm
For cathode-bias operation.....	1 <i>max</i>	megohm

### AVERAGE CHARACTERISTICS

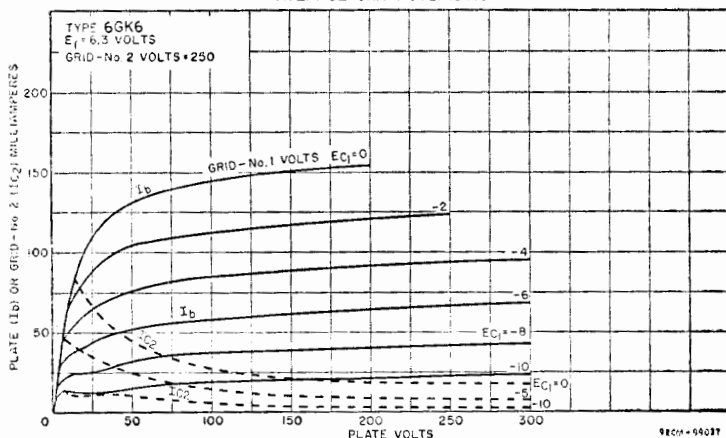



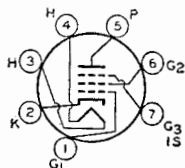

**SEMIREMOTE-CUTOFF PENTODE**

Miniature type used in gain-controlled picture-if stages of television receivers operating at intermediate frequencies in the order of 40 megacycles.

**6GM6**

Tube features high transconductance

and relatively low-capacitances. Outline 11, OUTLINES SECTION. Tube requires seven-contact socket and may be mounted in any position.

HEATER VOLTAGE (AC/DC).....	6.3	volts
HEATER CURRENT.....	0.4	amperes

DIRECT INTERELECTRODE CAPACITANCES:			
Grid No.1 to Plate.....	Without External Shield	With External Shield*	$\mu\mu\text{f}$
Grid No.1 to Cathode, Heater, Grid No.2, Grid No.3, and Internal Shield.....	0.036 max	0.026 max	
Plate to Cathode, Heater, Grid No.2, Grid No.3, and Internal Shield.....	10	10	$\mu\mu\text{f}$
	2.4	3.4	$\mu\mu\text{f}$

**CLASS A<sub>1</sub> AMPLIFIER**

Maximum Ratings, (Design-Maximum Values):

PLATE VOLTAGE.....	330 max	volts
GRID No.3 (SUPPRESSOR GRID).....	Connect to cathode at socket	
GRID-No.2 (SCREEN-GRID) SUPPLY VOLTAGE.....	330 max	volts
GRID-No.2 VOLTAGE.....	See curve page 66	
GRID-No.1 (CONTROL-GRID) VOLTAGE, Positive-bias value.....	0 max	volts
PLATE DISSIPATION.....	3.1 max	watts
GRID-No.2 INPUT:		
For grid-No.2 voltages up to 165 volts.....	0.65 max	watt
For grid-No.2 voltages between 165 and 330 volts.....	See curve page 66	
PEAK HEATER-CATHODE VOLTAGE:		
Heater negative with respect to cathode.....	200 max	volts
Heater positive with respect to cathode.....	200*max	volts

**Characteristics:**

Plate Supply Voltage.....	125	volts
Grid No.3 and Internal Shield.....	Connected to cathode at socket	
Grid-No.2 Supply Voltage.....	125	volts
Cathode-Bias Resistor.....	56	ohms
Plate Resistance (Approx.).....	0.2	megohm
Transconductance.....	13000	$\mu\text{mhos}$
Grid-No.1 Voltage (Approx.) for transconductance of 60 $\mu\text{mhos}$ .....	-15	volts
Plate Current.....	14	ma
Grid-No.2 Current.....	3.4	ma

\* With external shield connected to cathode.  
 • The dc component must not exceed 100 volts.

**AVERAGE CHARACTERISTICS**

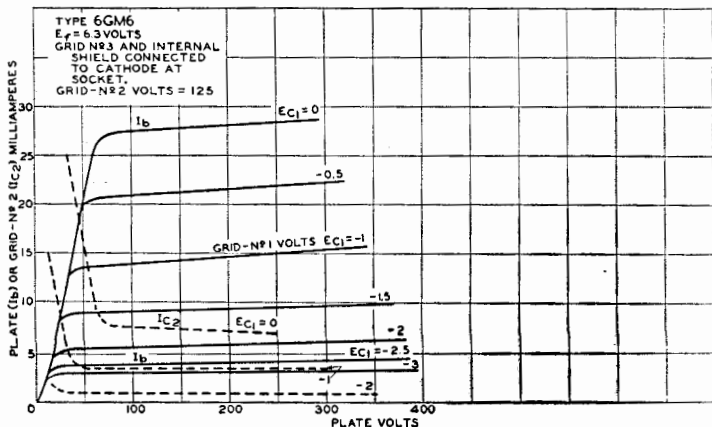

92CM-10390T1

**HIGH-MU TRIODE—  
SHARP-CUTOFF TRIODE**

**6GN8**

Miniature type used in color and black-and-white television receivers. Triode unit is used as sync-separator, sync-clipper, phase inverter, or sound-if amplifier. Pentode unit is used in

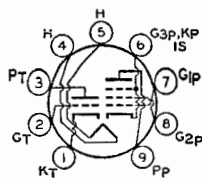

output stage of video amplifier. Outline 14, OUTLINES SECTION. Tube requires miniature nine-contact socket and may be operated in any position. For direct interelectrode capacitances, refer to type 6EB8; curve for average plate characteristics of triode unit is same as for type 6EB8.

HEATER VOLTAGE (AC/DC).....	6.3	volts
HEATER CURRENT.....	0.75	ampere

**CLASS A<sub>1</sub> AMPLIFIER**

Maximum Ratings, (Design-Maximum Values):

	Triode Unit	Pentode Unit	
PLATE VOLTAGE.....	330 max	330 max	volts
GRID-NO.2 (SCREEN-GRID) SUPPLY VOLTAGE.....	—	330 max	volts
GRID-NO.2 VOLTAGE.....	—	See curve page 66	
GRID-NO.1 (CONTROL-GRID) VOLTAGE, Positive-bias value.....	0 max	0 max	volts
PLATE DISSIPATION.....	1 max	5 max	watts
GRID-NO.2 INPUT:			
For grid-No.2 voltages up to 165 volts.....	—	1.1 max	watts
For grid-No.2 voltages between 165 and 330 volts.....	—	See curve page 66	
PEAK HEATER-CATHODE VOLTAGE:			
Heater negative with respect to cathode.....	200 max	200 max	volts
Heater positive with respect to cathode.....	200 <sup>o</sup> max	200 <sup>o</sup> max	volts

Characteristics:

	Triode Unit	Pentode Unit		
Plate Supply Voltage.....	250	60	200	volts
Grid-No.2 Supply Voltage.....	—	150	150	volts
Grid-No.1 Voltage.....	-2	0	—	volts
Cathode-Bias Resistor.....	—	—	100	ohms
Amplification Factor.....	100	—	—	
Plate Resistance (Approx.).....	37000	—	60000	ohms
Transconductance.....	2700	—	11500	μmhos
Grid Voltage (Approx.) for plate current of 20 μa.....	-5	—	—	volts
Grid-No.1 Voltage (Approx.) for plate current of 100 μa.....	—	—	-10	volts
Plate Current.....	2	55 <sup>■</sup>	25	ma
Grid-No.2 Current.....	—	18 <sup>■</sup>	5.5	ma

AVERAGE CHARACTERISTICS

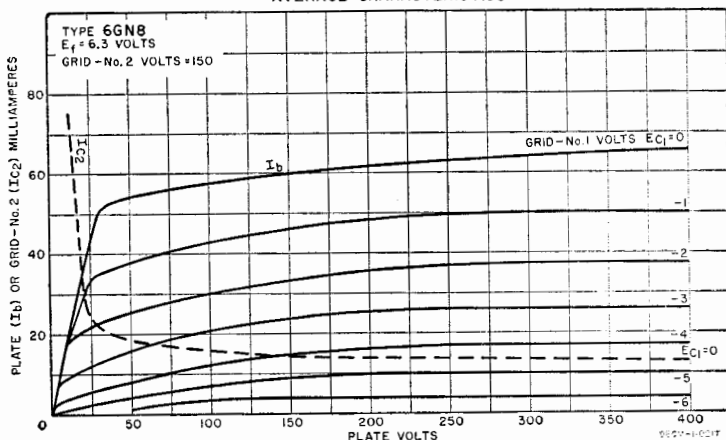

### Maximum Circuit Values:

Grid-No.1-Circuit Resistance:			
For fixed-bias operation.....	Triode Unit	Pentode Unit	
For cathode-bias operation.....	0.5 max	0.25 max	megohm
	1 max	1 max	megohm

° The dc component must not exceed 100 volts.

■ This value can be measured by a method involving a recurrent waveform such that the maximum ratings of the tube will not be exceeded.

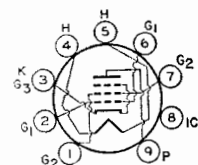

## BEAM POWER TUBE

# 6GT5

Novar type used as a horizontal-deflection amplifier in television receivers. Outline 54, OUTLINES SECTION, except vertical dimensions are 0.6 inch shorter. Tube requires octal

socket and may be operated in any position. For curve of average characteristics, refer to type 6GW6.

HEATER VOLTAGE (AC/DC).....	6.3	volts
HEATER CURRENT.....	1.2	amperes
DIRECT INTERELECTRODE CAPACITANCES (Approx.):°		
Grid No.1 to Plate.....	0.26	μuf
Grid No.1 to Cathode, Heater, Grid No.2, and Grid No.3.....	15	μuf
Plate to Cathode, Heater, Grid No.2, and Grid No.3.....	6.5	μuf

Without external shield.

### CLASS A<sub>1</sub> AMPLIFIER

Characteristics:	Triode Connection	Pentode Connection	
Plate Voltage.....	150	60	250 volts
Grid-No.2 (Screen-Grid) Voltage.....	150	150	150 volts
Grid-No.1 (Control-Grid) Voltage.....	-22.5	0	-22.5 volts
Mu Factor, grid No.2 to grid No.1.....	4.4	—	—
Plate Resistance (Approx.).....	—	—	15000 ohms
Transconductance.....	—	—	7100 μmhos
Plate Current.....	—	390*	70 ma
Grid-No.2 Current.....	—	32*	2.1 ma
Grid-No.1 Voltage (Approx.) for plate ma=1.....	—	—	-42 volts

### HORIZONTAL-DEFLECTION AMPLIFIER

*For operation in a 525-line, 30-frame system*

#### Maximum Ratings, (Design-Maximum Values):

DC PLATE SUPPLY VOLTAGE.....	770 max	volts
PEAK POSITIVE-PULSE PLATE VOLTAGE <sup>■</sup> .....	6500 max	volts
PEAK NEGATIVE-PULSE PLATE VOLTAGE.....	1500 max	volts
DC GRID-NO.2 VOLTAGE.....	220 max	volts
DC GRID-NO.1 VOLTAGE.....	-55 max	volts
PEAK NEGATIVE-PULSE GRID-NO.1 VOLTAGE.....	330 max	volts
PEAK CATHODE CURRENT.....	550 max	ma
AVERAGE CATHODE CURRENT.....	175 max	ma
GRID-NO.2 INPUT.....	3.5 max	watts
PLATE DISSIPATION <sup>°</sup> .....	17.5 max	watts
PEAK HEATER-CATHODE VOLTAGE:		
Heater negative with respect to cathode.....	200 max	volts
Heater positive with respect to cathode.....	200 <sup>□</sup> max	volts
BULB TEMPERATURE (At hottest point).....	240 max	°C

#### Maximum Circuit Values:

Grid-No.1-Circuit Resistance:	
For grid-resistor-bias operation <sup>•</sup> .....	1 max megohm

\* These values can be measured by a method involving a recurrent waveform such that the plate dissipation and grid-No.2 input will not exceed their maximum ratings.

■ The duration of the voltage pulse must not exceed 15 per cent of one horizontal scanning cycle. In a 525-line, 30-frame system, 15 per cent of one horizontal scanning cycle is 10 microseconds.

□ The plate dissipation should be limited in the event of loss of grid signal; for this purpose, some protection—such as a cathode resistor of suitable value—should be employed.

° The dc component must not exceed 100 volts.

**BEAM POWER TUBE**

**6GW6**

Glass octal type used as horizontal-deflection amplifier in high-efficiency deflection circuits of television receivers. Outline 37, OUTLINES SECTION. Tube requires octal socket and may be operated in any position.

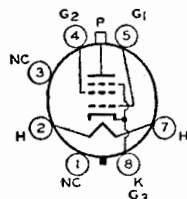

HEATER VOLTAGE (AC/DC).....	6.3	volts
HEATER CURRENT.....	1.2	amperes
DIRECT INTERELECTRODE CAPACITANCES (Approx.): <sup>o</sup>		
Grid No.1 to Plate.....	0.5	$\mu\text{f}$
Grid No.1 to Cathode, Heater, Grid No.2, and Grid No.3.....	17	$\mu\text{f}$
Plate to Cathode, Heater, Grid No.2, and Grid No.3.....	7	$\mu\text{f}$

**HORIZONTAL-DEFLECTION AMPLIFIER**

For operation in a 525-line, 30-frame system

**Maximum Ratings, (Design-Maximum Values):**

DC PLATE SUPPLY VOLTAGE.....	770 max	volts
PEAK POSITIVE-PULSE PLATE VOLTAGE <sup>■</sup> .....	6500 max	volts
PEAK NEGATIVE-PULSE PLATE VOLTAGE.....	1500 max	volts
DC GRID-NO.2 (SCREEN-GRID) VOLTAGE.....	220 max	volts
DC GRID-NO.1 (CONTROL-GRID) VOLTAGE.....	-55 max	volts
PEAK NEGATIVE-PULSE GRID-NO.1 VOLTAGE.....	330 max	volts
PEAK CATHODE CURRENT.....	550 max	ma
AVERAGE CATHODE CURRENT.....	175 max	ma
GRID-NO.2 INPUT.....	3.5 max	watts
PLATE DISSIPATION <sup>•</sup> .....	17.5 max	watts
PEAK HEATER-CATHODE VOLTAGE:		
Heater negative with respect to cathode.....	200 max	volts
Heater positive with respect to cathode.....	200 <sup>•</sup> max	volts
BULB TEMPERATURE (At hottest point).....	240 max	$^{\circ}\text{C}$

**Maximum Circuit Values:**

Grid-No.1-Circuit Resistance:		
For grid resistor-bias operation.....	1 max	megohm

**CLASS A<sub>1</sub> AMPLIFIER**

Plate Voltage.....	60	250	volts
Grid-No.2 Voltage.....	150	150	volts
Grid-No.1 Voltage.....	0	-22.5	volts
Plate Resistance (Approx.).....	—	15000	ohms
Transconductance.....	—	7100	$\mu\text{mhos}$
Plate Current.....	390 <sup>•</sup>	70	ma
Grid-No.2 Current.....	32 <sup>•</sup>	2.1	ma
Grid-No.1 Voltage (Approx.) for plate current of 1 ma.....	—	-42	volts

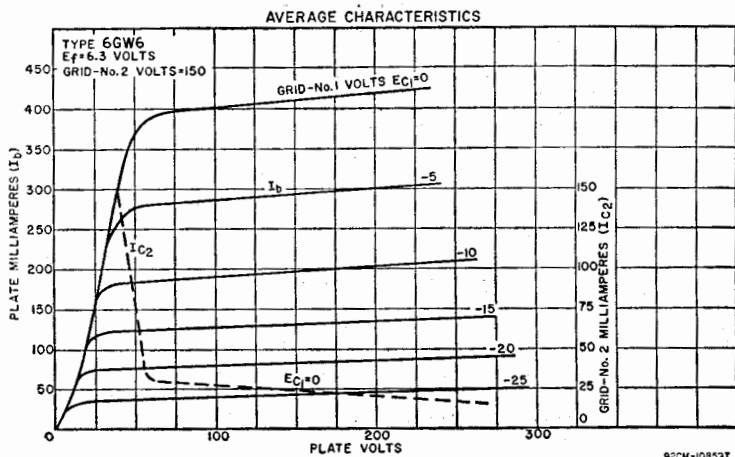

<sup>2</sup> Without external shield.

■ The duration of the voltage pulse must not exceed 15 per cent of one horizontal scanning cycle. In a 525-line, 30-frame system, 15 per cent of one horizontal scanning cycle is 10 microseconds.

■ An adequate bias resistor or other means is required to protect the tube in the absence of excitation.

† The dc component must not exceed 100 volts.

‡ This value can be measured by a method involving a recurrent waveform such that the maximum ratings of the tube will not be exceeded.

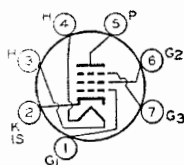

### SHARP-CUTOFF PENTODE

Miniature type used for FM sound-detector service in locked-oscillator, quadrature-grid FM detector circuits, as combined detector, limiter, and audio-voltage driver. Tube has two

## 6GX6

independent control grids. Outline 11, OUTLINES SECTION. Tube requires miniature seven-contact socket and may be operated in any position.

HEATER VOLTAGE (AC/DC).....	6.3	volts
HEATER CURRENT.....	0.45	ampere-
HEATER WARM-UP TIME (Average).....	11	seconds
DIRECT INTERELECTRODE CAPACITANCES (Approx.): <sup>2</sup>		
Grid No.1 to Plate.....	0.022	μf
Grid No.1 to Cathode, Heater, Grid No.2, Grid No.3, and Internal Shield.....	8	μf
Grid No.1 to Grid No.3.....	0.11	μf
Grid No.3 to Plate.....	1.6	μf
Grid No.3 to Cathode, Heater, Grid No.1, Grid No.2, Plate, and Internal Shield.....	7.5	μf

### FM SOUND-DETECTOR

Maximum Ratings, (Design-Maximum Values):

PLATE VOLTAGE.....	300 max	volts
GRID-NO.3 (CONTROL-GRID) VOLTAGE:		
Negative value (dc and peak ac).....	100 max	volts
Positive value (dc and peak ac).....	25 max	volts
GRID-NO.2 (SCREEN-GRID) SUPPLY VOLTAGE.....	300 max	volts
GRID-NO.2 VOLTAGE.....		See curve page 66
GRID-NO.1 (CONTROL-GRID) VOLTAGE:		
Negative-bias value.....	50 max	volts
Positive-bias value.....	0 max	volts
PLATE DISSIPATION.....	1.7 max	watts
GRID-NO.3 INPUT.....	0.1 max	watt
GRID-NO.2 INPUT:		
For grid-No.2 voltages up to 150 volts.....	1.0 max	watt
For grid-No.2 voltages between 150 and 300 volts.....		See curve page 66
PEAK HEATER-CATHODE VOLTAGE:		
Heater negative with respect to cathode.....	200 max	volts
Heater positive with respect to cathode.....	200 max	volts

Maximum Circuit Values:

Grid-No.3-Circuit Resistance.....	0.68 max	megohm
Grid-No.1-Circuit Resistance:		
For fixed-bias operation.....	0.22 max	megohm
For cathode-bias operation.....	0.47 max	megohm

Characteristics:

### CLASS A<sub>1</sub> AMPLIFIER

Plate Supply Voltage.....	150	volts
Grid-No.3 Supply Voltage.....	0	volts
Grid-No.2 Supply Voltage.....	100	volts
Grid-No.1 Supply Voltage.....	0	volts
Cathode-Bias Resistor.....	180	ohms
Plate Resistance (Approx.).....	0.14	megohm
Transconductance, grid No.1 to plate.....	3700	μmhos
Transconductance, grid No.3 to plate.....	750	μmhos
Plate Current.....	3.7	ma
Grid-No.2 Current.....	3	ma
Grid-No.3 Supply Voltage (Approx.) for plate μ <sub>a</sub> =20.....	-7	volts
Grid-No.1 Supply Voltage (Approx.) for plate μ <sub>a</sub> =20.....	-4.5	volts

<sup>2</sup> Without external shield.

■ The dc component must not exceed 100 volts.

AVERAGE CHARACTERISTICS

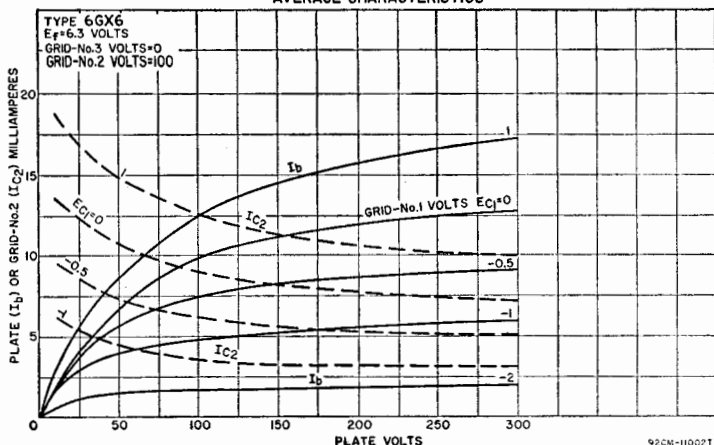

AVERAGE CHARACTERISTICS

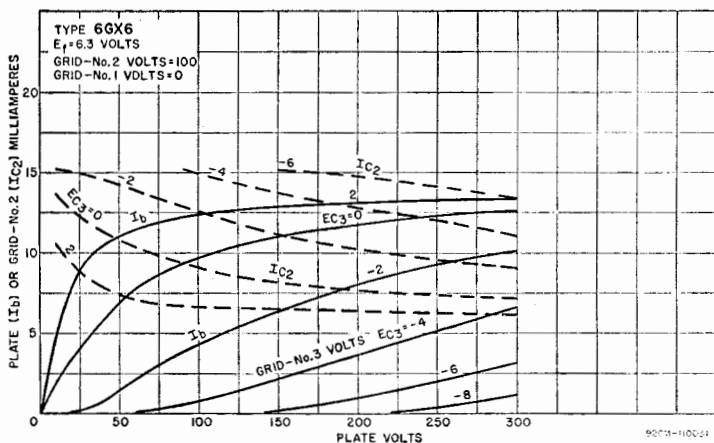

SHARP-CUTOFF PENTODE

6GY6

Miniature type used in gated-agc-amplifier circuits and as a noise-inverter tube in television receivers. Tube has two independent control grids. Outline 11, OUTLINES SECTION.

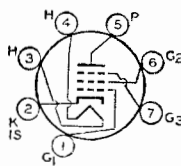

Tube requires miniature seven-contact socket and may be operated in any position. For curves of average characteristics, refer to type 6EX6.

HEATER VOLTAGE (AC/DC).....	6.3	volts
HEATER CURRENT.....	0.45	ampere
HEATER WARM-UP TIME (AVERAGE).....	11	seconds
DIRECT INTERELECTRODE CAPACITANCES: <sup>o</sup>		
Grid No.1 to Plate.....	0.026	$\mu\text{mf}$
Grid No.1 to Cathode, Heater, Grid No.2, Grid No.3, and Internal Shield.....	8	$\mu\text{mf}$
Grid No.1 to Grid No.3.....	0.12	$\mu\text{mf}$
Grid No.3 to Plate.....	1.6	$\mu\text{mf}$
Grid No.3 to Cathode, Heater, Plate, Grid No.1, Grid No.2, and Internal Shield.....	6.5	$\mu\text{mf}$

## GATED-AGC-AMPLIFIER AND NOISE INVERTER

*For operation in a 525-line, 30-frame system*

### Maximum Ratings, (Design-Maximum Values):

PLATE VOLTAGE.....	300 max	volts
PEAK POSITIVE-PULSE PLATE VOLTAGE <sup>■</sup> .....	600 max	volts
GRID-NO.3 (CONTROL-GRID) VOLTAGE:		
Negative-bias value.....	100 max	volts
Positive-bias value.....	0 max	volts
GRID-NO.2 (SCREEN-GRID) SUPPLY VOLTAGE.....	300 max	volts
GRID-NO.2 VOLTAGE.....	See curve page 66	
GRID-NO.1 (CONTROL-GRID) VOLTAGE:		
Negative-bias value.....	50 max	volts
Positive-bias value.....	0 max	volts
PLATE DISSIPATION.....	1.7 max	watts
GRID-NO.2 INPUT:		
For grid-No.2 voltages up to 150 volts.....	1 max	watt
For grid-No.2 voltages between 150 and 300 volts.....	See curve page 66	
PEAK HEATER-CATHODE VOLTAGE:		
Heater negative with respect to cathode.....	200 max	volts
Heater positive with respect to cathode.....	200 <sup>●</sup> max	volts

### Maximum Circuit Values:

Grid-No.3-Circuit Resistance.....	0.68 max	megohm
Grid-No.1-Circuit Resistance:		
For fixed-bias operation.....	0.22 max	megohm
For cathode-bias operation.....	0.47 max	megohm

### CLASS A<sub>1</sub> AMPLIFIER

#### Characteristics:

Plate Supply Voltage.....	150	volts
Grid-No.3 Supply Voltage.....	0	volts
Grid-No.2 Supply Voltage.....	100	volts
Grid-No.1 Supply Voltage.....	0	volts
Cathode-Bias Resistor.....	180	ohms
Plate Resistance (Approx.).....	0.14	megohm
Transconductance, Grid No.1 to Plate.....	3700	$\mu$ mhos
Transconductance, Grid No.3 to Plate.....	750	$\mu$ mhos
Plate Current.....	3.7	ma
Grid-No.2 Current.....	3	ma
Grid-No.3 Supply Voltage (Approx.) for plate $\mu$ a=20.....	-7	volts
Grid-No.1 Supply Voltage (Approx.) for plate $\mu$ a=20.....	-4.5	volts

◊ Without external shield.

■ The duration of the voltage pulse must not exceed 15 per cent of one horizontal scanning cycle. In a 525-line, 30-frame system, 15 per cent of one horizontal scanning cycle is 10 microseconds.

● The dc component must not exceed 100 volts.

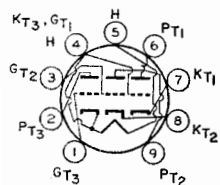

### HIGH-MU TRIPLE TRIODE

Miniature type used in rf-amplifier, mixer, and automatic-frequency-control service in FM radio receivers. Outline 12, OUTLINES SECTION. Tube requires miniature nine-contact socket and may be operated in any position.

## 6GY8

HEATER VOLTAGE (AC/DC).....	6.3	volts
HEATER CURRENT.....	0.45	ampere

### CLASS A<sub>1</sub> AMPLIFIER

*Values are for each unit, except as noted*

#### Maximum Ratings, (Design-Maximum Values):

PLATE VOLTAGE.....	330 max	volts
GRID VOLTAGE, Positive-bias value.....	0 max	volts
PLATE DISSIPATION.....	2 max	watts
TOTAL PLATE DISSIPATION (All plates).....	5 max	watts
PEAK HEATER-CATHODE VOLTAGE (Units No.1 and No.2):		
Heater negative with respect to cathode.....	100 max	volts
Heater positive with respect to cathode.....	100 max	volts

#### Characteristics:

	Unit No.1	Units No.2 or No.3	
Plate Supply Voltage.....	125	125	volts
Grid Voltage.....	—	-1	volts
Cathode-Bias Resistor.....	220	—	ohms
Amplification Factor.....	63	63	
Plate Resistance (Approx.).....	14000	14000	ohms
Transconductance.....	4500	4500	$\mu$ mhos
Plate Current.....	4.5	4.5	ma
Grid Voltage (Approx.), for plate $\mu$ a=20.....	—	-4	volts

**TWIN DIODE**

**6H6  
6H6-GT**

Metal type 6H6 and glass octal type 6H6-GT used as detectors, low-voltage rectifiers, and avc tubes. Except for the common heater, the two diode units are independent of each other.

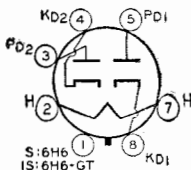

For diode detector considerations, refer to ELECTRON TUBE APPLICATIONS SECTION. Type 6H6-GT is a DISCONTINUED type listed for reference only.

HEATER VOLTAGE (AC/DC).....	6.3	volts
HEATER CURRENT.....	0.3	ampere

**Maximum Ratings: RECTIFIER OR DOUBLER**

PEAK INVERSE PLATE VOLTAGE.....	420 max	volts
PEAK PLATE CURRENT (Per Plate).....	48 max	ma
DC OUTPUT CURRENT (Per Plate).....	8 max	ma
PEAK HEATER-CATHODE VOLTAGE:		
Heater negative with respect to cathode.....	330 max	volts
Heater positive with respect to cathode.....	330 max	volts

**Typical Operation As Half-Wave Rectifier\***

AC Plate Voltage (Per Plate, rms).....	117	150	volts
Min. Total Effective Plate-Supply Impedance (Per Plate)*.....	15	40	ohms
DC Output Current (Per Plate).....	8	8	ma

**Typical Operation As Voltage Doubler**

	<i>Half-Wave</i>	<i>Full-Wave</i>	
AC Plate Voltage (Per Plate, rms).....	117	117	volts
Min. Total Effective Plate-Supply Impedance (Per Plate) <sup>o</sup> .....	30	15	ohms
DC Output Current.....	8	8	ma

\* In half-wave service, the two units may be used separately or in parallel.

<sup>o</sup> When a filter-input capacitor larger than 40  $\mu$ f is used, it may be necessary to use more plate-supply impedance than the value shown to limit the peak plate current to the rated value.

**INSTALLATION AND APPLICATION**

Types 6H6 and 6H6-GT require an octal socket and may be mounted in any position. Type 6H6-GT may be supplied with pin No.1 omitted. Outlines 1 and 22 respectively, OUTLINES SECTION.

For detection, the diodes may be utilized in a full-wave circuit or in a half-wave circuit. In the latter case, one plate only, or the two plates in parallel, may be employed. For the same signal voltage, the use of the half-wave arrangement will provide approximately twice the rectified voltage as compared with the full-wave arrangement.

For automatic volume control, the 6H6 and 6H6-GT may be used in circuits similar to those employed for any of the twin-diode types of tubes. The only difference is that the 6H6 and 6H6-GT are more adaptable because each diode has its own separate cathode.

**HIGH-MU TRIODE—  
SHARP-CUTOFF PENTODE**

**6HF8**

Miniature type used in color and black-and-white television receivers. The triode unit is used in high-gain, sound-if stages and in sync-separator, sync-clipper, and phase-inverter circuits; pentode unit is used as video-output amplifier. Outline 14, OUTLINES SECTION. Tube requires miniature nine-contact socket and may be operated in any position. For curves of average characteristics, refer to type 6AW8-A for the triode unit and to type 6EB8 for the pentode unit.

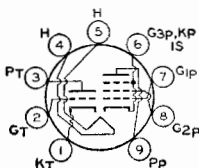



HEATER VOLTAGE (AC/DC).....	6.3	volts
HEATER CURRENT.....	0.75	ampere
DIRECT INTERELECTRODE CAPACITANCES: <sup>o</sup>		
Triode Unit:		
Grid to Plate.....	3.5	$\mu\mu\text{f}$
Grid to Cathode, Heater, Pentode Cathode, Grid No.3, and Internal Shield.....	2.8	$\mu\mu\text{f}$
Plate to Cathode, Heater, Pentode Cathode, Grid No.3, and Internal Shield.....	2.6	$\mu\mu\text{f}$
Pentode Unit:		
Grid No.1 to Plate.....	0.1 <i>max</i>	$\mu\mu\text{f}$
Grid No.1 to Cathode, Heater, Grid No.2, Grid No.3, and Internal Shield.....	10	$\mu\mu\text{f}$
Plate to Cathode, Heater, Grid No.2, Grid No.3, and Internal Shield.....	4.2	$\mu\mu\text{f}$
Triode Grid to Pentode Plate.....	0.015 <i>max</i>	$\mu\mu\text{f}$

### CLASS A: AMPLIFIER

#### Maximum Ratings, (Design-Maximum Values):

	Triode Unit	Pentode Unit	
PLATE VOLTAGE.....	330 <i>max</i>	330 <i>max</i>	volts
GRID-NO.2 (SCREEN-GRID) SUPPLY VOLTAGE.....	—	330 <i>max</i>	volts
GRID-NO.2 VOLTAGE.....	—	See curve page 66	
GRID-NO.1 (CONTROL-GRID) VOLTAGE, Positive-bias value.....	0 <i>max</i>	0 <i>max</i>	volts
PLATE DISSIPATION.....	1 <i>max</i>	5 <i>max</i>	watts
GRID-NO.2 INPUT:			
For grid-No.2 voltages up to 165 volts.....	—	1.1 <i>max</i>	watts
For grid-No.2 voltages between 165 and 330 volts.....	—	See curve page 66	
PEAK HEATER-CATHODE VOLTAGE:			
Heater negative with respect to cathode.....	200 <i>max</i>	200 <i>max</i>	volts
Heater positive with respect to cathode.....	200 <i>max</i>	200 <i>max</i>	volts

#### Characteristics:

	Triode Unit	Pentode Unit	
Plate Supply Voltage.....	200	45	200
Grid-No.2 Supply Voltage.....	—	125	125
Grid-No.1 Voltage.....	—2	0	—
Cathode-Bias Resistor.....	—	—	68
Amplification Factor.....	70	—	—
Plate Resistance (Approx.).....	17500	—	75000
Transconductance.....	4000	—	12500
Plate Current.....	4	40*	25
Grid-No.2 Current.....	—	15*	7
Grid-No.1 Voltage (Approx.) for plate $\mu\text{a}=100$ .....	—	—	—9
Grid-No.1 Voltage (Approx.) for plate $\mu\text{a}=20$ .....	—6	—	—

#### Maximum Circuit Values:

	Triode Unit	Pentode Unit	
Grid-No.1-Circuit Resistance:			
For fixed-bias operation.....	0.5 <i>max</i>	0.25 <i>max</i>	megohm
For cathode-bias operation.....	1 <i>max</i>	1 <i>max</i>	megohm

<sup>o</sup> Without external shield.

\* This value can be measured by a method involving a recurrent waveform such that the maximum ratings of the tube will not be exceeded.

• The dc component must not exceed 100 volts.

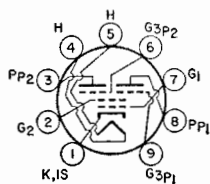

## SHARP-CUTOFF TWIN PENTODE

Miniature type used in agc amplifier, sync, and noise-limiting circuits of television receivers. One pentode unit is used as combined sync separator and sync clipper; second pentode

# 6HS8

unit is used as agc amplifier. Outline 14, OUTLINES SECTION. Tube requires miniature nine-contact socket and may be operated in any position.

HEATER VOLTS (AC/DC).....	6.3	volts
HEATER CURRENT.....	0.3	ampere
DIRECT INTERELECTRODE CAPACITANCES: <sup>o</sup>		
Grid No.3 to Plate (Each Unit).....	2	$\mu\mu\text{f}$
Grid No.1 to All Other Electrodes.....	6	$\mu\mu\text{f}$
Grid No.3 (Each Unit) to All Other Electrodes.....	3.6	$\mu\mu\text{f}$
Plate (Each Unit) to All Other Electrodes.....	3	$\mu\mu\text{f}$
Grid No.3 (Unit No.1) to Grid No.3 (Unit No.2).....	0.015 <i>max</i>	$\mu\mu\text{f}$

## CLASS A<sub>1</sub> AMPLIFIER

### Maximum Ratings, (Design-Maximum Values):

PLATE VOLTAGE (Each Unit).....	300 <i>max</i>	volts
GRID-NO.3 (SUPPRESSOR-GRID) VOLTAGE (Each Unit):		
Peak positive value.....	50 <i>max</i>	volts
DC negative value.....	50 <i>max</i>	volts
DC positive value.....	3 <i>max</i>	volts
GRID-NO.2 (SCREEN-GRID) VOLTAGE.....	150 <i>max</i>	volts
GRID-NO.1 (CONTROL-GRID) VOLTAGE, Negative bias value.....	50 <i>max</i>	volts
CATHODE CURRENT.....	12 <i>max</i>	ma
PLATE DISSIPATION (Each Unit).....	1.1 <i>max</i>	watts
GRID-NO.2 INPUT.....	0.75 <i>max</i>	watt
PEAK HEATER-CATHODE VOLTAGE:		
Heater negative with respect to cathode.....	200 <i>max</i>	volts
Heater positive with respect to cathode.....	200 <i>max</i>	volts

### Characteristics:

#### With One Unit Operating\*

Plate Voltage.....	100	100	volts
Grid-No.3 Voltage.....	0	0	volts
Grid-No.2 Voltage.....	67.5	67.5	volts
Grid-No.1 Voltage.....	0	□	volts
Transconductance, Grid-No.3-to-Plate.....	—	450	μmhos
Transconductance, Grid-No.1-to-Plate.....	1100	—	μmhos
Plate Current.....	—	2	ma
Grid-No.3 Voltage (Approx.) for plate $\mu a=25$ .....	—	-3	volts
Grid-No.1 Voltage (Approx.) for plate $\mu a=100$ .....	—	-2.3	volts

#### With Both Units Operating

Plate Voltage (Each Unit).....	100	100	volts
Grid-No.3 Voltage (Each Unit).....	-10	0	volts
Grid-No.2 Voltage.....	67.5	67.5	volts
Grid-No.1 Voltage.....	□	□	volts
Plate Current (Each Unit).....	—	2	ma
Grid-No.2 Current.....	7	4.4	ma
Cathode Current.....	7.1	8.5	ma

### Maximum Circuit Values:

Grid-No.3-Circuit Resistance (Each Unit).....	0.5 <i>max</i>	megohm
Grid-No.1-Circuit Resistance.....	0.5 <i>max</i>	megohm

\* Without external shield.

▪ The dc component must not exceed 100 volts.

• With plate and grid No.3 of other unit connected to ground.

† Adjusted to give grid-No.1 current of 0.1 milliampere.

### AVERAGE CHARACTERISTICS

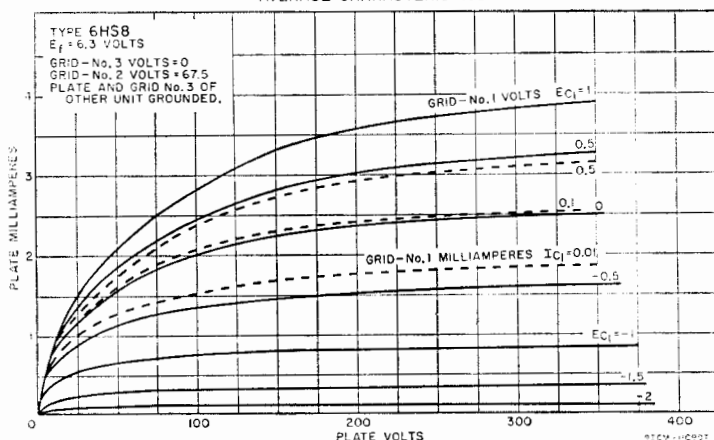

AVERAGE CHARACTERISTICS

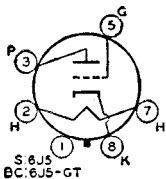
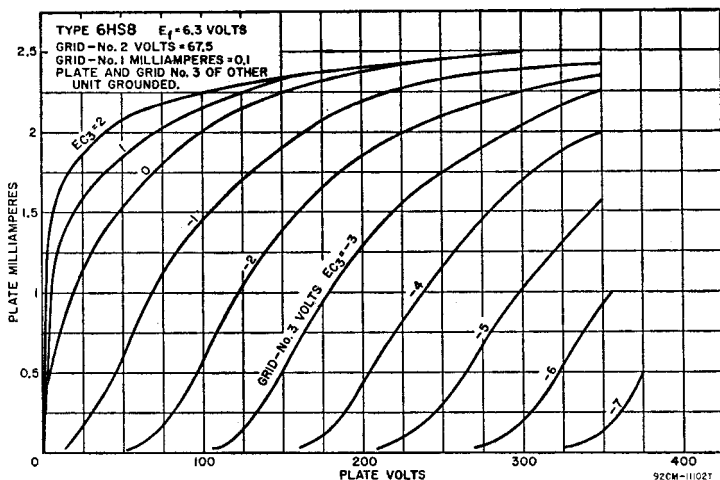

**MEDIUM-MU TRIODE**

Metal type 6J5 and glass octal type 6J5-GT used as detectors, amplifiers, or oscillators in radio equipment. These types feature high transconductance together with comparatively

**6J5**  
**6J5-GT**

high amplification factor. Outlines 3 and 24, respectively, OUTLINES SECTION. Tubes require octal socket and may be mounted in any position. For typical operation as resistance-coupled amplifiers, refer to RESISTANCE-COUPLED AMPLIFIER SECTION.

HEATER VOLTAGE (AC/DC).....	6.3	volts
HEATER CURRENT.....	0.3	ampere
DIRECT INTERELECTRODE CAPACITANCES (Approx.):	<i>6J5*</i>	<i>6J5-GT**</i>
Grid to Plate.....	3.4	38 $\mu\text{f}$
Grid to Cathode and Heater.....	3.4	4.2 $\mu\text{f}$
Plate to Cathode and Heater.....	3.6	5.0 $\mu\text{f}$

\* Shell connected to cathode.      \*\* Base sleeve and external shield connected to cathode.

**Maximum Ratings:** **CLASS A<sub>1</sub> AMPLIFIER**

PLATE VOLTAGE.....	300 <i>max</i>	volts
GRID VOLTAGE, Positive Bias Value.....	0 <i>max</i>	volts
PLATE DISSIPATION.....	2.5 <i>max</i>	watts
CATHODE CURRENT.....	20 <i>max</i>	ma
PEAK HEATER-CATHODE VOLTAGE:		
Heater negative with respect to cathode.....	90 <i>max</i>	voltg
Heater positive with respect to cathode.....	90 <i>max</i>	voltg

**Characteristics:**

Plate Voltage.....	90	250	volts
Grid Voltage.....	0	-8	volts
Amplification Factor.....	20	20	
Plate Resistance (Approx.).....	6700	7700	ohms
Transconductance.....	300 $\mu$	2600	amhos
Grid Voltage (Approx.) for plate current of 10 $\mu\text{a}$ .....	-7	-18	volts
Plate Current.....	10	9	ma

**Maximum Circuit Value:**

Grid-Circuit Resistance.....	1.0 <i>max</i>	megohm
------------------------------	----------------	--------

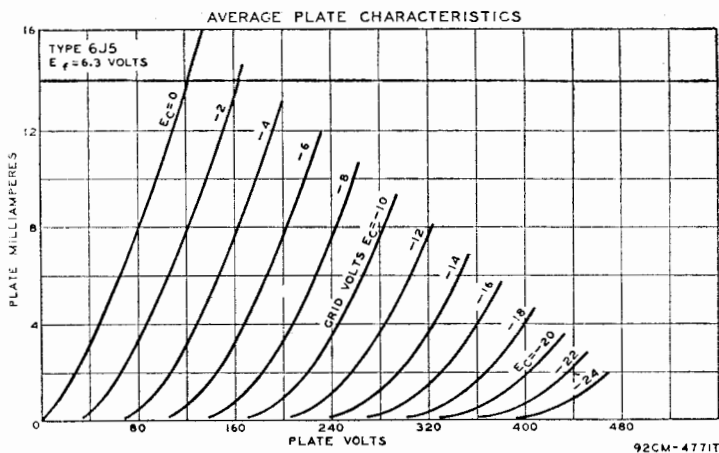

## 6J6 6J6-A

### MEDIUM-MU TWIN TRIODE

Miniature types used as combined rf power amplifier and oscillator or as twin af amplifier. With push-pull arrangement of the grids and the plates in parallel, can also be used as a mixer

at frequencies as high as 600 megacycles per second. Outline 11, OUTLINES SECTION. Tubes require miniature seven-contact socket and may be mounted in any position. Except for heater rating, the 6J6-A is identical with type 6J6.

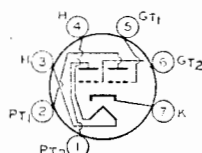

HEATER VOLTAGE (AC/DC).....	6.3	volts
HEATER CURRENT.....	0.45	ampere
HEATER WARM-UP TIME (Average) for 6J6-A.....	11	seconds

DIRECT INTERELECTRODE CAPACITANCES (Each Unit, Approx.):	Without External Shield	With External Shield	
Grid to Plate.....	1.6	1.6	μf
Grid to Cathode and Heater.....	2.2	2.6	μf
Plate to Cathode and Heater (Unit No.1).....	0.4	1.6	μf
Plate to Cathode and Heater (Unit No.2).....	0.4	1	μf

#### Maximum Ratings:

#### CLASS A<sub>1</sub> AMPLIFIER (Each Unit):

PLATE VOLTAGE.....	300 max	volts
GRID VOLTAGE, Positive-Bias value.....	0 max	volts
PLATE DISSIPATION.....	1.5 max	watts
PEAK HEATER-CATHODE VOLTAGE:		
Heater negative with respect to cathode.....	100 max	volts
Heater positive with respect to cathode.....	100 max	volts

#### Characteristics:

Plate Voltage.....	100	volts
Cathode-Bias Resistor.....	50†	ohms
Amplification Factor.....	38	
Plate Resistance (Approx.).....	7100	ohms
Transconductance.....	5300	μmhos
Plate Current.....	8.5	ma

#### Maximum Circuit Values:

Grid-Circuit Resistance:		
For fixed-bias operation.....		Not recommended
For cathode-bias operation.....		0.5 max megohm

† Value is for both units operating at the specified conditions.

**RF POWER AMPLIFIER AND OSCILLATOR—Class C Telegraphy**

*Key-down conditions per tube without modulation*

**Maximum Ratings (Each Unit):**

PLATE VOLTAGE.....	300 <i>max</i>	volts
GRID VOLTAGE:		
Negative-bias value.....	-40 <i>max</i>	volts
Positive-bias value.....	0 <i>max</i>	volts
PLATE CURRENT.....	15 <i>max</i>	ma
GRID CURRENT.....	8 <i>max</i>	ma
PLATE INPUT.....	4.5 <i>max</i>	watts
PLATE DISSIPATION.....	1.5 <i>max</i>	watts
PEAK HEATER-CATHODE VOLTAGE:		
Heater negative with respect to cathode.....	100 <i>max</i>	volts
Heater positive with respect to cathode.....	100 <i>max</i>	volts

**Typical Push-Pull Operation (Both Units):**

Plate Voltage.....	150	volts
Grid Voltage <sup>o</sup> .....	-10	volts
Plate Current.....	30	ma
Grid Current (Approx.).....	16	ma
Driving Power (Approx.).....	0.35	watt
Power Output (Approx.).....	3.5	watts

<sup>o</sup> Obtained by grid resistor (625 ohms), cathode-bias resistor (220 ohms), or fixed supply.

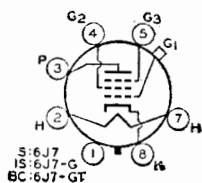

**SHARP-CUTOFF PENTODE**

Metal type 6J7 and glass octal types 6J7-G and 6J7-GT are used as biased detectors or high-gain audio amplifiers in radio receivers. Outlines 4, 39, and 23, respectively, OUTLINES

**6J7**  
**6J7-G**  
**6J7-GT**

SECTION. Type 6J7-GT is used principally for renewal purposes. Type 6J7-G is a DISCONTINUED type listed for reference only. All types require octal socket and may be mounted in any position.

HEATER VOLTAGE (AC/DC).....	6.3	volts
HEATER CURRENT.....	0.3	ampere

**Maximum Ratings: CLASS A<sub>1</sub> AMPLIFIER**

PLATE VOLTAGE.....	300 <i>max</i>	volts
GRID No.3 (SUPPRESSOR GRID).....	Connect to cathode at socket	
GRID-No.2 (SCREEN-GRID) VOLTAGE.....	See curve page 66	
GRID-No.2 SUPPLY VOLTAGE.....	300 <i>max</i>	volts
GRID-No.1 (CONTROL-GRID) VOLTAGE, Positive-bias value.....	0 <i>max</i>	volts
PLATE DISSIPATION.....	0.75 <i>max</i>	watt
GRID-No.2 INPUT:		
For grid-No.2 voltages up to 150 volts.....	0.10 <i>max</i>	watt
For grid-No.2 voltages between 150 and 300 volts.....	See curve page 66	
PEAK HEATER-CATHODE VOLTAGE:		
Heater negative with respect to cathode.....	90 <i>max</i>	volts
Heater positive with respect to cathode.....	90 <i>max</i>	volts

**Characteristics:**

Plate Voltage.....	100	250	volts
Grid No.3.....	Connected to cathode at socket		
Grid-No.2 Voltage.....	100	100	volts
Grid-No.1 Voltage.....	-3	-3	volts
Plate Resistance (Approx.).....	1	*	megohm
Transconductance.....	1185	1225	μmhos
Grid-No.1 Voltage (Approx.) for plate current of 10 μa.....	-7	-7	volts
Plate Current.....	2	2	ma
Grid-No.2 Current.....	0.5	0.5	ma

**Maximum Circuit Value:**

Grid-No.1-Circuit Resistance.....	1.0 <i>max</i>	megohm
-----------------------------------	----------------	--------

**Maximum Ratings: CLASS A<sub>1</sub> AMPLIFIER (Triode Connection)<sup>o</sup>**

PLATE VOLTAGE.....	250 <i>max</i>	volts
GRID-No.1 VOLTAGE, Positive-bias value.....	0 <i>max</i>	volts
PLATE DISSIPATION (TOTAL).....	1.75 <i>max</i>	watts
PEAK HEATER-CATHODE VOLTAGE:		
Heater negative with respect to cathode.....	90 <i>max</i>	volts
Heater positive with respect to cathode.....	90 <i>max</i>	volts

**Characteristics:**

Plate Voltage.....	180	250	volts
Grid-No.1 Voltage.....	-5.3	-8	volts
Amplification Factor.....	20	20	
Plate Resistance (Approx.).....	11000	10500	ohms
Transconductance.....	1800	1900	$\mu$ mhos
Plate Current.....	5.3	6.5	ma

**Maximum Circuit Value:**

Grid-No.1-Circuit Resistance.....	1.0 max	megohm
-----------------------------------	---------	--------

\* Greater than 1.0 megohm.

† Grids No.2 and No.3 connected to plate.

**TRIODE—HEPTODE CONVERTER**

**6J8-G**

Glass octal type used as a combined triode oscillator and heptode mixer in radio receivers. Outline 39, OUTLINES SECTION. Tube requires octal socket. Heater volts (ac/dc), 6.3; amperes, 0.3. Typical operation—Heptode unit: plate volts, 250 (300 max); grids-No.2-and-No.4 volts, 100 max; grid-No.1 volts, -3; plate resistance, 1.5 megohms; conversion transconductance, 290  $\mu$ mhos; plate ma., 1.4; grids-No.2-and-No.4 ma., 2.8. Triode unit: plate volts, 250 max

(applied through 20000-ohm dropping resistor); grid resistor, 50000 ohms; plate ma., 5.0. This is a DISCONTINUED type listed for reference only.

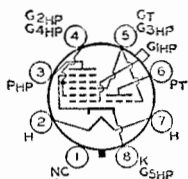

**HIGH-MU TRIODE**

**6K5-GT**

Glass octal type used as voltage amplifier in radio equipment. Outline 23, OUTLINES SECTION. Tube requires octal socket. Heater volts (ac/dc), 6.3; amperes, 0.3. Characteristics as class A<sub>1</sub> amplifier: plate volts, 250 max; grid volts, -3; amplification factor, 70; plate resistance, 50000 ohms; transconductance, 1400  $\mu$ mhos; plate ma., 1.1. This is a DISCONTINUED type listed for reference only.

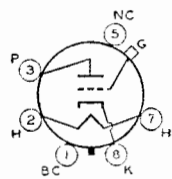

**POWER PENTODE**

**6K6-GT**

Glass octal type used in output stage of radio receivers and, triode-connected, as a vertical deflection amplifier in television receivers. It is capable of delivering moderate power output with relatively small input voltage. Tube may be used singly or in push-pull.

This type may be supplied with pin No.1 omitted. Tube requires octal socket and may be mounted in any position. Outline 22, OUTLINES SECTION. It is especially important that this tube, like other power-handling tubes, be adequately ventilated.

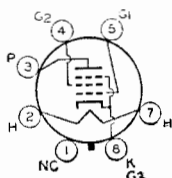

HEATER VOLTAGE (AC/DC).....	6.3	volts
HEATER CURRENT.....	0.4	ampere
<b>DIRECT INTERELECTRODE CAPACITANCES (Approx.):</b>		
Grid No.1 to Plate.....	0.5	$\mu$ f
Grid No.1 to Cathode, Heater, Grid No.2, and Grid No.3.....	5.5	$\mu$ f
Plate to Cathode, Heater, Grid No.2, and Grid No.3.....	6.0	$\mu$ f

**CLASS A<sub>1</sub> AMPLIFIER**

<b>Maximum Ratings:</b>		
PLATE VOLTAGE.....	315 max	volts
GRID-NO.2 (SCREEN-GRID) VOLTAGE.....	285 max	volts
PLATE DISSIPATION.....	8.5 max	watts
GRID-NO.2 INPUT.....	2.8 max	watts
<b>PEAK HEATER-CATHODE VOLTAGE:</b>		
Heater negative with respect to cathode.....	200 max	volts
Heater positive with respect to cathode.....	200* max	volts

\* The dc component must not exceed 100 volts.

### Typical Operation:

Plate Voltage.....	100	250	315	volts
Grid-No.2 Voltage.....	100	250	250	volts
Grid-No.1 (Control-Grid) Voltage.....	-7	-18	-21	volts
Peak AF Grid-No.1 Voltage.....	7	18	21	volts
Zero-Signal Plate Current.....	9	32	25.5	ma
Maximum-Signal Plate Current.....	9.5	33	28	ma
Zero-Signal Grid-No.2 Current.....	1.6	5.5	4.0	ma
Maximum-Signal Grid-No.2 Current.....	3	10	9	ma
Plate Resistance (Approx.).....	104000	90000	110000	ohms
Transconductance.....	1500	2300	2100	μmhos
Load Resistance.....	12000	7600	9000	ohms
Total Harmonic Distortion.....	11	11	15	per cent
Maximum-Signal Power Output.....	0.35	3.4	4.5	watts

### Typical Push-Pull Operation (Values are for two tubes):

	Fixed Bias	Cathode Bias	
Plate Supply Voltage.....	285	285	volts
Grid-No.2 Supply Voltage.....	285	285	volts
Grid-No.1 Voltage.....	-25.5	-	volts
Cathode-Bias Resistor.....	-	400	ohms
Peak AF Grid-No.1-to-Grid-No.1 Voltage.....	51	51	volts
Zero-Signal Plate Current.....	55	35	ma
Maximum-Signal Plate Current.....	72	61	ma
Zero-Signal Grid-No.2 Current.....	9	9	ma
Maximum-Signal Grid-No.2 Current.....	17	13	ma
Effective Load Resistance (Plate-to-plate).....	12000	12000	ohms
Total Harmonic Distortion.....	6	4	per cent
Maximum-Signal Power Output.....	10.5	9.8	watts

### Maximum Circuit Values:

Grid-No.1-Circuit Resistance:	
For fixed-bias operation.....	0.1 max megohm
For cathode-bias operation.....	0.5 max megohm

### Characteristics (Triode Connection)\*:

Plate Voltage.....	250	volts
Grid-No.1 Voltage.....	-18	volts
Plate Current.....	37.5	ma
Transconductance.....	2700	μmhos
Amplification Factor.....	6.8	
Plate Resistance (Approx.).....	2500	ohms
Grid-No.1 Voltage (Approx.) for plate current of 0.5 ma.....	-48	volts

\* Grid-No.2 connected to plate.

### VERTICAL DEFLECTION AMPLIFIER (Triode Connection)\*

Maximum Ratings:	For operation in a 525-line, 30-frame system	
DC PLATE VOLTAGE.....	315 max	volts
PEAK POSITIVE-PULSE PLATE VOLTAGE† (Absolute maximum).....	1200 max	volts
PEAK NEGATIVE-PULSE GRID-NO.1 VOLTAGE.....	-250 max	volts
PEAK CATHODE CURRENT.....	75 max	ma
AVERAGE CATHODE CURRENT.....	25 max	ma
PLATE DISSIPATION.....	7 max	watts
PEAK HEATER-CATHODE VOLTAGE:		
Heater negative with respect to cathode.....	200 max	volts
Heater positive with respect to cathode.....	200 max	volts

### Maximum Circuit Value:

Grid-No.1-Circuit Resistance:	
For cathode-bias operation.....	2.2 max megohms

\* Grid No.2 connected to plate.

† The duration of the voltage pulse must not exceed 15 per cent of one vertical scanning cycle. In a 525-line, 30-frame system, 15 per cent of one vertical scanning cycle is 2.5 milliseconds.

‡ Under no circumstances should this absolute value be exceeded.

■ The dc component must not exceed 100 volts.

## REMOTE-CUTOFF PENTODE

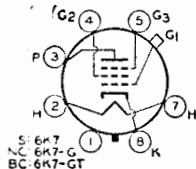

Metal type 6K7 and glass octal types 6K7-G and 6K7-GT used in rf and if stages of radio receivers, particularly in those employing avc. Outlines 4, 39, and 23, respectively, OUTLINES SECTION. These tubes require octal socket and may be mounted in any position. For electrode voltage supplies and application, refer to type 6SK7. Heater volts (ac/dc), 6.3;

# 6K7 6K7-G 6K7-GT

amperes, 0.3. Typical operation as class A<sub>1</sub> amplifier: plate volts 250 (300 max); grid No.3 connected to cathode at socket; grid-No.2 supply volts, 300 max; grid-No.2 volts, 125; grid-No.1 volts, -3; plate resistance, 0.6 megohm; transconductance, 1650 μmhos; plate ma., 10.5; grid-No.2 ma., 2.6; plate dissipation, 2.75 max watts; grid-No.2 input, 0.35 max watts. Types 6K7 and 6K7-GT are used principally for renewal purposes. Type 6K7-G is a DISCONTINUED type listed for reference only.

**6K8**  
**6K8-G**  
**6K8-GT**

**TRIODE-HEXODE CONVERTER**

Metal type 6K8 and glass octal types 6K8-G and 6K8-GT used as combined triode oscillator and hexode mixer in radio receivers. Type 6K8, Outline 5, type 6K8-G, Outline 39,

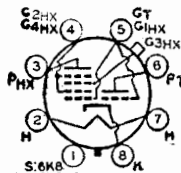

OUTLINES SECTION. Types 6K8-G and 6K8-GT are DISCONTINUED types listed for reference only. Tubes require octal socket and may be mounted in any position.

HEATER VOLTAGE (AC/DC).....	6.3	volts
HEATER CURRENT.....	0.3	ampere

**Maximum Ratings:**

**CONVERTER SERVICE**

HEXODE PLATE VOLTAGE.....	300 max	volts
HEXODE GRIDS-NO.2-AND-NO.4 (SCREEN-GRID) VOLTAGE.....	150 max	volts
HEXODE GRIDS-NO.2-AND-NO.4 SUPPLY VOLTAGE.....	300 max	volts
HEXODE GRID-NO.3 (CONTROL-GRID) VOLTAGE, Positive-bias value.....	0 max	volts
TRIODE PLATE VOLTAGE.....	125 max	volts
HEXODE PLATE DISSIPATION.....	0.75 max	watt
HEXODE GRIDS-NO.2-AND-NO.4 INPUT.....	0.7 max	watt
TRIODE PLATE DISSIPATION.....	0.75 max	watt
TOTAL CATHODE CURRENT.....	16 max	ma
PEAK HEATER-CATHODE VOLTAGE:		
Heater negative with respect to cathode.....	90 max	volts
Heater positive with respect to cathode.....	90 max	volts

**Typical Operation:**

Hexode Plate Voltage.....	100	250	volts
Hexode Grids-No.2-and-No.4 Voltage.....	100	100	volts
Hexode Grid-No.3 Voltage.....	-3	-3	volts
Triode Plate Voltage.....	100	100	volts
Triode Grid Resistor.....	50000	50000	ohms
Hexode Plate Resistance (Approx.).....	0.4	0.6	megohm
Conversion Transconductance.....	325	350	μmhos
Hexode Grid-No.3 Voltage (Approx.) for conversion transconductance of 2 μmhos.....	-30	-30	volts
Hexode Plate Current.....	2.3	2.5	ma
Hexode Grids-No.2-and-No.4 Current.....	6.2	6.0	ma
Triode Plate Current.....	3.8	3.8	ma
Triode Grid and Hexode Grid-No.1 Current.....	0.15	0.15	ma
Total Cathode Current.....	12.5	12.5	ma

The transconductance of the triode section, not oscillating, of the 6K8 is approximately 3000 μmhos when the triode plate voltage is 100 volts, and the triode grid voltage is 0 volts.

**MEDIUM-MU TRIODE**

Glass octal type used as detector, amplifier, or oscillator in radio receivers. Outline 36, OUTLINES SECTION. Heater volts (ac/dc), 6.3; amperes, 0.15. Typical operation and characteristics: plate volts, 250 max; grid volts, -9; plate ma., 8; plate resistance, 9000 ohms; amplification factor, 17; transconductance, 1900 μmhos; grid voltage for cathode-current cutoff, -20. This is a DISCONTINUED type listed for reference only.

**6L5-G**

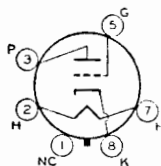

**6L6**  
**6L6-G**  
**6L6-GB**  
**6L6-GC**

**BEAM POWER TUBE**

Metal type 6L6 and glass octal types 6L6-G, 6L6-GB, 6L6-GC are used in the output stage of audio amplifying equipment, especially units designed to have ample reserve of power-

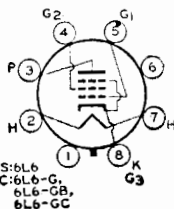

delivering ability. These types provide high power output, sensitivity, and high efficiency. Power output at all levels has low third- and higher-order harmonics.



Outlines 7, 50, 38, and 38, respectively, OUTLINES SECTION. Tubes require an octal socket and may be mounted in any position. It is especially important that these tubes, like other power-handling tubes, be adequately ventilated. Type 6L6-G is a DISCONTINUED type listed for reference only. Type 6L6-GC can be used in place of types 6L6, 6L6-G, 6L6-GA, and 6L6-GB. Type 6L6-GC may be supplied with pin 1 omitted.

HEATER VOLTAGE (AC/DC).....	6.3	volts
HEATER CURRENT.....	0.9	ampere
DIRECT INTERELECTRODE CAPACITANCES (Approx.):		
Grid No.1 to Plate.....	6L6* 0.4	6L6-GC 0.6
Grid No.1 to Cathode, Heater, Grid No.2, and Grid No.3..	10	10
Plate to Cathode, Heater, Grid No.2, and Grid No.3.....	12	6.5

\* With pin 1 connected to pin 8.

**CLASS A<sub>1</sub> AMPLIFIER**

Maximum Ratings:	<i>6L6, 6L6-G, 6L6-GB</i>		<i>6L6-GC</i>	
	<i>Design-Center Values</i>	<i>Design-Maximum Values</i>		
PLATE VOLTAGE.....	360 max	500 max		volts
GRID-NO.2 (SCREEN-GRID) VOLTAGE.....	270 max	450* max		volts
PLATE DISSIPATION.....	19 max	30 max		watts
GRID-NO.2 INPUT.....	2.5 max	5 max		watts
<b>PEAK HEATER-CATHODE VOLTAGE:</b>				
Heater negative with respect to cathode.....	180 max	200 max		volts
Heater positive with respect to cathode.....	180 max	200 max		volts
<b>Typical Operation:</b>				
Plate Voltage.....	250	300	350	volts
Grid-No.2 Voltage.....	250	200	250	volts
Grid-No.1 (Control-Grid) Voltage.....	-14	-12.5	-18	volts
Peak AF Grid-No.1 Voltage.....	14	12.5	18	volts
Zero-Signal Plate Current.....	72	48	54	ma
Maximum-Signal Plate Current.....	79	55	66	ma
Zero-Signal Grid-No.2 Current.....	5	2.5	2.5	ma
Maximum-Signal Grid-No.2 Current.....	7.3	4.7	7	ma
Plate Resistance (Approx.).....	22500	35000	33000	ohms
Transconductance.....	6000	5300	5200	μmhos
Load Resistance.....	2500	4500	4200	ohms
Total Harmonic Distortion.....	10	11	15	per cent
Maximum-Signal Power Output.....	6.5	6.5	10.8	watts

**CLASS A<sub>1</sub> AMPLIFIER (Triode Connection)†**

Maximum Ratings:	<i>6L6, 6L6-G, 6L6-GB</i>		<i>6L6-GC</i>	
	<i>Design-Center Values</i>	<i>Design-Maximum Values</i>		
PLATE VOLTAGE.....	275 max	450 max		volts
PLATE DISSIPATION (TOTAL).....	19 max	30 max		watts
<b>PEAK HEATER-CATHODE VOLTAGE:</b>				
Heater negative with respect to cathode.....	180 max	200 max		volts
Heater positive with respect to cathode.....	180 max	200 max		volts
<b>Typical Operation:</b>				
Plate Voltage.....		250		volts
Grid-No.1 Voltage.....		-20		volts
Peak AF Grid-No.1 Voltage.....		20		volts
Zero-Signal Plate Current.....		40		ma
Maximum-Signal Plate Current.....		44		ma
Plate Resistance (Approx.).....		1700		ohms
Amplification Factor.....		8		
Transconductance.....		4700		μmhos
Load Resistance.....		5000		ohms
Total Harmonic Distortion.....		5		per cent
Maximum-Signal Power Output.....		1.4		watts

† Grid No.2 connected to plate.

**PUSH-PULL CLASS A<sub>1</sub> AMPLIFIER**

Maximum Ratings: (Same as for class A<sub>1</sub> amplifier)

Typical Operation (Values are for two tubes):

Plate Voltage.....	250	270	volts
Grid-No.2 Voltage.....	250	270	volts
Grid-No.1 Voltage.....	-16	-17.5	volts
Peak AF Grid-No.1-to-Grid-No.1 Voltage.....	32	35	volts

Zero-Signal Plate Current.....	120	134	ma
Maximum-Signal Plate Current.....	140	155	ma
Zero-Signal Grid-No.2 Current.....	10	11	ma
Maximum-Signal Grid-No.2 Current.....	16	17	ma
Effective Load Resistance (Plate-to-plate).....	5000	5000	ohms
Total Harmonic Distortion.....	2	2	per cent
Maximum-Signal Power Output.....	14.5	17.5	watts

### PUSH-PULL CLASS AB<sub>1</sub> AMPLIFIER

Maximum Ratings: (Same as for class A<sub>1</sub> amplifier)

Typical Operation (Values are for two tubes):			
	6L6, 6L6-GB, 6L6-GC	6L6-GC	
Plate Voltage.....	360	360	volts
Grid-No.2 Voltage.....	270	270	volts
Grid-No.1 Voltage.....	-22.5	-22.5	volts
Peak AF Grid-No.1-to-Grid-No.1 Voltage.....	45	45	volts
Zero-Signal Plate Current.....	88	88	ma
Maximum-Signal Plate Current.....	132	140	ma
Zero-Signal Grid-No.2 Current.....	5	5	ma
Maximum-Signal Grid-No.2 Current.....	15	11	ma
Effective Load Resistance (Plate-to-plate).....	6600	3800	ohms
Total Harmonic Distortion.....	2	2	per cent
Maximum-Signal Power Output.....	26.5	18	watts

### PUSH-PULL CLASS AB<sub>2</sub> AMPLIFIER

Maximum Ratings: (Same as for class A<sub>1</sub> amplifier)

Typical Operation (Values are for two tubes):

Plate Voltage.....	360	360	volts
Grid-No.2 Voltage.....	225	270	volts
Grid-No.1 Voltage.....	-18	-22.5	volts
Peak AF Grid-No.1-to-Grid-No.1 Voltage.....	52	72	volts
Zero-Signal Plate Current.....	78	88	ma
Maximum-Signal Plate Current.....	142	205	ma
Zero-Signal Grid-No.2 Current.....	3.5	5	ma
Maximum-Signal Grid-No.2 Current.....	11	16	ma
Effective Load Resistance (Plate-to-plate).....	6000	3800	ohms
Total Harmonic Distortion.....	2	2	per cent
Maximum-Signal Power Output.....	31	47	watts

Maximum Circuit Values:

Grid-No.1-Circuit Resistance:

For fixed-bias operation..... 0.1 max megohm

For cathode-bias operation..... 0.5 max megohm

\* In push-pull circuits where grid No 2 of each tube is connected to a tap on the plate winding of the output transformer, this maximum rating is 500 volts.

AVERAGE PLATE CHARACTERISTICS

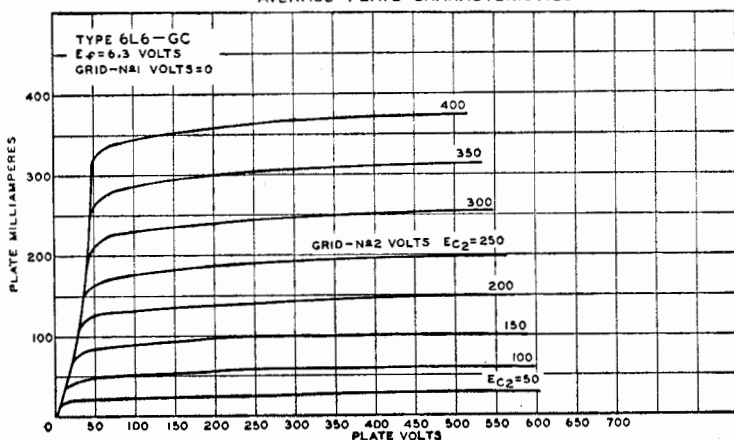

92CM-10327T

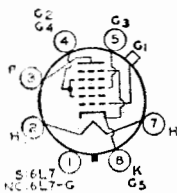

**PENTAGRID MIXER**

Metal type 6L7 and glass octal type 6L7-G are used as mixers in superheterodyne circuits having a separate oscillator stage as well as in other applications where dual control

**6L7**  
**6L7-G**

is desirable in a single stage. The two separate control grids are shielded from each other and the coupling effects between oscillator and signal circuits are very small. For additional information, refer to *Frequency Conversion*, ELECTRON TUBE APPLICATIONS SECTION. Outlines 4 and 39, respectively, OUTLINES SECTION. Heater volts (ac/dc), 6.3; amperes, 0.3. Typical operation as mixer (values recommended for all-wave receivers): plate volts, 250 (300 *max*); grids-No.2-and-No.4 volts, 150 *max*; grid-No.1 volts, -6 *min*; grid-No.3 volts, -15; peak oscillator volts applied to grid No.3, 18 *min*; plate dissipation, 1 *max* watt; grids-No.2-and-No.4 input, 1.5 *max* watts; plate ma, 3.3; grids-No.2-and-No.4 ma, 9.2; plate resistance, greater than 1 megohm; conversion transconductance, 350  $\mu$ mhos. Type 6L7-G is a DISCONTINUED type listed for reference only.

Refer to type 6AB5/6N5

**6N5**

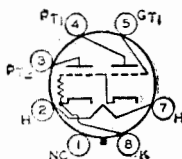

**DIRECT-COUPLED POWER TRIODE**

Glass octal type used as class A<sub>1</sub> power amplifier. Outline 42, OUTLINES SECTION. Heater volts (ac/dc), 6.3; amperes, 0.8. For electrical characteristics, refer to type 6B5. Type 6N6-G is a DISCONTINUED type listed for reference only.

**6N6-G**

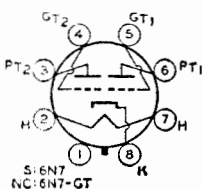

**MEDIUM-MU TWIN  
POWER TRIODE**

Metal type 6N7 and glass octal type 6N7-GT used in output stage of radio receivers as class B power amplifier or with units in parallel as a class A<sub>1</sub> amplifier to drive a 6N7 or 6N7-GT

**6N7**  
**6N7-GT**

as a class B amplifier. Outlines 6 and 22, respectively, OUTLINES SECTION. Tubes require octal socket and may be mounted in any position. For class B amplifier considerations, refer to ELECTRON TUBE APPLICATIONS SECTION. Type 6N7 is used principally for renewal purposes.

HEATER VOLTAGE (AC/DC).....	6.3	volts
HEATER CURRENT.....	0.8	ampere

**CLASS B POWER AMPLIFIER**

Maximum Ratings (Each Unit):

PLATE VOLTAGE.....	300 <i>max</i>	volts
PEAK PLATE CURRENT.....	125 <i>max</i>	ma
AVERAGE PLATE DISSIPATION.....	5.5 <i>max</i>	watts
<b>PEAK HEATER-CATHODE VOLTAGE:</b>		
Heater negative with respect to cathode.....	90 <i>max</i>	volts
Heater positive with respect to cathode.....	90 <i>max</i>	volts

Typical Push-Pull Operation (Unless Otherwise Specified, Values are for Both Units):

Plate-Supply Impedance.....	0	1000	ohms
Effective Grid-Circuit Impedance.....	300	516**	ohms
Plate Voltage.....		300	volts

Grid Voltage.....	0	0	volts
Peak AF Grid-to-Grid Voltage.....	58	82	volts
Zero-Signal Plate Current.....	35	35	ma
Maximum-Signal Plate Current.....	70	70	ma
Peak Grid Current (Each Unit).....	20	22	ma
Effective Load Resistance (Plate to plate).....	8000	8000	ohms
Total Harmonic Distortion.....	4	8	per cent
Maximum-Signal Power Output.....	10	10	watts

\*\* At 400 cycles per second for class B stage in which the effective resistance per grid circuit is 500 ohms, and the leakage inductance of the coupling transformer is 50 millihenries. The driver stage should be capable of supplying the grids of the class B stage with the specified values at low distortion.

**CLASS A<sub>1</sub> AMPLIFIER**

*Both grids connected together at socket; likewise, both plates*

**Maximum Ratings:**

PLATE VOLTAGE.....	300 max	volts
PLATE DISSIPATION (Per plate).....	1.0 max	watt
PEAK HEATER-CATHODE VOLTAGE:		
Heater negative with respect to cathode.....	90 max	volts
Heater positive with respect to cathode.....	90 max	volts

**Typical Operation:**

Plate Voltage.....	250	300	volts
Grid Voltage.....	-5	-6	volts
Amplification Factor.....	35	35	
Plate Resistance (Approx.).....	11300	11000	ohms
Transconductance.....	3100	3200	μmhos
Plate Current.....	6	7	ma

Plate Load—Depends largely on the design factors of the class B amplifier. In general, the load will be between 20000 and 40000 ohms.  
 Power Output—Under maximum voltage conditions, upwards of 400 milliwatts can be obtained.

**MEDIUM-MU TRIODE**

Glass octal type used as detector, amplifier, or oscillator in radio receivers. Outline 22. OUTLINES SECTION. Tube requires octal socket. Heater volts (ac/dc), 6.3; amperes, 0.3. Except for interelectrode capacitances, this type is identical electrically with type 76. Type 6P5-GT is a DISCONTINUED type listed for reference only.

**6P5-GT**

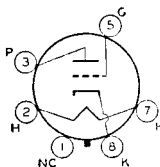

**LOW-MU TRIODE—  
REMOTE-CUTOFF PENTODE**

Glass octal type used as an amplifier. Outline 39, OUTLINES SECTION. Heater volts (ac/dc), 6.3; amperes, 0.3. Except for interelectrode capacitances, this type is identical electrically with type 6F7. Type 6P7-G is a DISCONTINUED type listed for reference only.

**6P7-G**

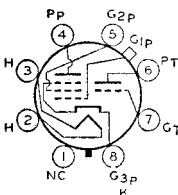

**TWIN DIODE—HIGH-MU TRIODE**

Metal type 6Q7 and glass octal types 6Q7-G and 6Q7-GT used as combined detector, amplifier, and avc tubes in radio receivers. Outlines 4, 39, and 23, respectively, OUTLINES SECTION. Types 6Q7 and 6Q7-GT are used principally for renewal purposes. Type 6Q7-G is a DISCONTINUED type listed for reference only. Tubes require octal socket. Heater volts (ac/dc), 6.3; amperes, 0.3. These types are similar electrically in most respects to types 6SQ7 and 6AT6. Maximum ratings and typical operation of the triode unit as a class A<sub>1</sub> amplifier are the same as those for type 6AT6 except that with a plate voltage of 100 volts, the transconductance is 1200 μmhos and the plate resistance 58000 ohms. For triode-unit, grid-bias considerations and diode curves, refer to type 6AV6.

**6Q7  
6Q7-G  
6Q7-GT**

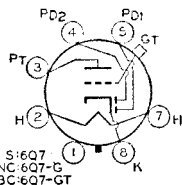

lar electrically in most respects to types 6SQ7 and 6AT6. Maximum ratings and typical operation of the triode unit as a class A<sub>1</sub> amplifier are the same as those for type 6AT6 except that with a plate voltage of 100 volts, the transconductance is 1200 μmhos and the plate resistance 58000 ohms. For triode-unit, grid-bias considerations and diode curves, refer to type 6AV6.

**TWIN DIODE—  
MEDIUM-MU TRIODE**

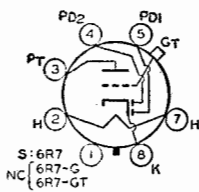

**6R7  
6R7-G  
6R7-GT**

Watts. For typical operation as a resistance-coupled amplifier, refer to Chart 7, RESISTANCE-COUPLED AMPLIFIER SECTION. Types 6R7-G and 6R7-GT are DISCONTINUED types listed for reference only. Type 6R7 is used principally for renewal purposes.

**MEDIUM-MU TRIODE**

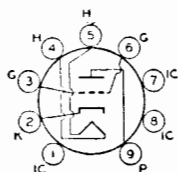

**6S4  
6S4-A**

Miniature types having high permeance used as vertical deflection amplifiers in television receivers. Type 6S4-A has a controlled heater warm-up time for use in television receivers employing series-connected heater strings. Outline 14, OUTLINES SECTION. Tubes require miniature nine-contact socket and may be mounted in any position. Type 6S4 is a DISCONTINUED type listed for reference only.

HEATER VOLTAGE (AC/DC).....	6.3	volts
HEATER CURRENT.....	0.6	ampere
HEATER WARM-UP TIME (Average) for 6S4-A.....	11	seconds
DIRECT INTERELECTRODE CAPACITANCES (Approx.):		
Grid to Plate.....	2.4	$\mu\text{f}$
Grid to Cathode and Heater.....	4.2	$\mu\text{f}$
Plate to Cathode and Heater.....	0.6	$\mu\text{f}$

<b>Characteristics:</b>		<b>CLASS A<sub>1</sub> AMPLIFIER</b>	
Plate Voltage.....	250	volts	
Grid Voltage.....	-8	volts	
Amplification Factor.....	16.5		
Plate Resistance (Approx.).....	3700	ohms	
Transconductance.....	4500	$\mu\text{mhos}$	
Plate Current.....	24	ma	
Plate Current for grid voltage of -15 volts.....	4	ma	
Grid Voltage (Approx.) for plate current of 50 $\mu\text{a}$ .....	-22	volts	

**VERTICAL DEFLECTION AMPLIFIER**

For operation in a 525-line, 30-frame system

<b>Maximum Ratings, (Design-Maximum Values):</b>		
DC PLATE VOLTAGE.....	550 max	volts
PEAK POSITIVE-PULSE PLATE VOLTAGE†.....	2200 max	volts
PEAK NEGATIVE-PULSE GRID VOLTAGE.....	-250 max	volts
PEAK CATHODE CURRENT.....	105 max	ma
AVERAGE CATHODE CURRENT.....	30 max	ma
PLATE DISSIPATION.....	8.5 max	watts
PEAK HEATER-CATHODE VOLTAGE:		
Heater negative with respect to cathode.....	200 max	volts
Heater positive with respect to cathode.....	200 max	volts

<b>Maximum Circuit Value:</b>		
Grid-Circuit Resistance:		
For cathode-bias operation.....	2.2 max	megohms

† The duration of the voltage pulse must not exceed 15 per cent of one vertical scanning cycle. In a 525-line, 30-frame system, 15 per cent of one vertical scanning cycle is 2.5 milliseconds.

■ The dc component must not exceed 100 volts.

REMOTE-CUTOFF PENTODE

6S7  
6S7-G

Metal type 6S7 and glass octal type 6S7-G used in rf and if stages of automobile receivers employing avc. Outlines 5 and 39, respectively, OUTLINES SECTION. Type 6S7 is used principally for renewal purposes. Type 6S7-G is a DISCONTINUED type listed for reference only. Tubes require octal socket. Heater volts, 6.3; amperes, 0.15. Typical operation as Class A<sub>1</sub> amplifier: plate volts, 250 (300 max); grid-

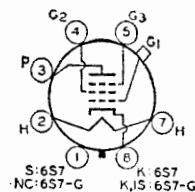

No.2 volts, see curve page 66; grid-No.2 supply volts, 300 max; grid-No.1 volts, -3 (0 max); grid No.3 connected to cathode at socket; plate ma., 8.5; grid-No.2 ma., 2; plate resistance (Approx.), 1.0 meg-ohm; transconductance, 1750  $\mu$ mhos; plate dissipation, 2.25 max watts; grid-No.2 input: for grid-No.2 voltages up to 150 volts, 0.25 max watt; for grid-No.2 voltages between 150 and 300 volts, see curve page 66. Peak heater-cathode volts, 90 max.

TRIPLE DIODE—HIGH-MU TRIODE

6S8-GT

Glass octal type used as audio amplifier, AM detector, and FM detector in AM/FM receivers. Diode unit No.2 is used for AM detection, and diode units No.1 and No.3 are used for FM detection. Outline 21, OUTLINES SECTION, except over-all length is 3-5/8 max inches and seated height is 3-1/16 max inches. Tube requires octal socket. Heater volts (ac/dc), 6.3; amperes, 0.3. Typical operation of triode

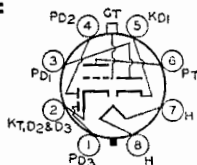

unit as class A<sub>1</sub> amplifier: plate volts, 250 (300 max); grid volts, -2; amplification factor, 100; plate resistance (Approx.), 91000 ohms; transconductance, 1100  $\mu$ mhos; plate dissipation, 0.5 max watt; plate ma., 0.9; peak heater-cathode volts, 90 max. Maximum plate ma. for diode units, 1.0 max (each unit). Peak heater-cathode volts (diode unit No.1), 90 max. For diode operation curves, refer to type 6AV6. Type 6S8-GT is used principally for renewal purposes.

PENTAGRID CONVERTER

6SA7

Metal type 6SA7 and glass octal type 6SA7-GT used as converters in superheterodyne circuits. They are similar in performance to type 6BE6. For general discussion of pentagrid types, see *Frequency Conversion* in ELECTRON TUBE APPLICATIONS SECTION. Both tubes have excellent frequency stability. Tubes require octal socket and may be mounted in any position. Outlines 3 and 22, respectively, OUTLINES SECTION. Type 6SA7-GT is used principally for renewal purposes.

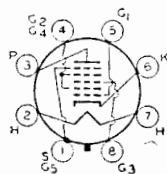

6SA7-GT

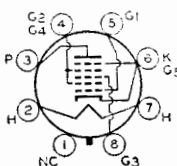

HEATER VOLTAGE (AC/DC).....	6.3	volts
HEATER CURRENT.....	0.3	ampere
DIRECT INTERELECTRODE CAPACITANCES for 6SA7:		
Grid No.3 to All Other Electrodes (RF Input).....	9.5*	$\mu$ uf
Plate to All Other Electrodes (Mixer Output).....	9.5*	$\mu$ uf
Grid No.1 to All Other Electrodes (Osc. Input).....	7*	$\mu$ uf
Grid No.3 to Plate.....	0.25 max*	$\mu$ uf
Grid No.3 to Grid No.1.....	0.15 max*	$\mu$ uf
Grid No.1 to Plate.....	0.06 max*	$\mu$ uf
Grid No.1 to Shell, Grid No.5, and All Other Electrodes except Cathode	4.4	$\mu$ uf
Grid No.1 to Cathode.....	2.6	$\mu$ uf
Cathode to Shell, Grid No.5, and All Other Electrodes except Grid No.1	5	$\mu$ uf

\* With shell connected to cathode.

**CONVERTER**

**Maximum Ratings:**

PLATE VOLTAGE.....	300 max	volts
GRID No.5 (SUPPRESSOR GRID) AND SHELL (6SA7 only).....	Connect to cathode at socket	
GRIDS-No.2-AND-No.4 (SCREEN-GRID) VOLTAGE.....	100 max	volts
GRIDS-No.2-AND-No.4 SUPPLY VOLTAGE.....	300 max	volts
GRID-No.3 (CONTROL-GRID) VOLTAGE:		
Negative bias value.....	-50 max	volts
Positive bias value.....	0 max	volts
PLATE DISSIPATION.....	1.0 max	watt
GRIDS-No.2-AND-No.4 INPUT.....	1.0 max	watt
CATHODE CURRENT.....	14 max	ma
PEAK HEATER-CATHODE VOLTAGE:		
Heater negative with respect to cathode.....	90 max	volts
Heater positive with respect to cathode.....	90 max	volts

**Typical Operation:**

*Separate Excitation†*

Plate Voltage.....	100	250	volts
Grid No.5 and shell (6SA7 only).....	Connected to cathode at socket		
Grids-No.2-and-No.4 Voltage.....	100	100	volts
Grid-No.3 Voltage.....	-2	-2	volts
Grid-No.1 (Oscillator-Grid) Resistor.....	20000	20000	ohms
Plate Resistance (Approx.).....	0.5	1.0	megohm
Conversion Transconductance.....	425	450	μmhos
Grid-No.3 Voltage (Approx.) for transconductance of 10 μmhos.....	-25	-25	volts
Grid-No.3 Voltage (Approx.) for conversion transconductance of 100 μmhos.....	-9	-9	volts
Plate Current.....	3.3	3.5	ma
Grids-No.2-and-No.4 Current.....	8.5	8.5	ma
Grid-No.1 Current.....	0.5	0.5	ma
Cathode Current.....	12.3	12.5	ma

NOTE: The transconductance between grid No.1 and grids No.2 and No.4 connected to plate (not oscillating) is 4500 μmhos under the following conditions: grids No.1, No.3 at 0 volts; grids No.2 and No.4 and plate at 100 volts; for 6SA7 only, grid No.5 and shell are connected to cathode at socket.

† The characteristics shown with separate excitation correspond very closely to those obtained in a self-excited oscillator circuit operating with zero bias.

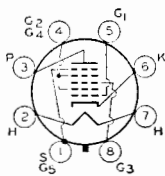

**PENTAGRID CONVERTER**

Metal type used as converter in super-heterodyne circuits. Because of its high conversion and oscillator transconductance, it is especially useful in FM converter service in the 100-megacycle region. The 6SB7-Y has a micaol base which minimizes drift in oscillator frequency during warm-up period. For general discussion of pentagrid types, see *Frequency Conversion* in ELECTRON TUBE APPLICATIONS SECTION. Outline 3, OUTLINES SECTION. Tube requires octal socket and may be mounted in any position. Heater volts (ac/dc), 6.3; amperes, 0.3. For maximum ratings and characteristics in converter service, refer to type 6BA7. Type 6SB7-Y is used principally for renewal purposes.

6SB7-Y

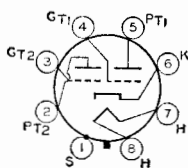

**HIGH-MU TWIN TRIODE**

Metal type used as phase inverter in radio equipment. Each unit may also be used in voltage amplifier circuits. Except for common cathode, each triode is independent of the other. Outline 3, OUTLINES SECTION. Tube requires octal socket and may be mounted in any position.

6SC7

HEATER VOLTAGE (AC/DC).....	6.3	volts
HEATER CURRENT.....	0.3	ampere
DIRECT INTERELECTRODE CAPACITANCES (Each Unit, Approx.): <sup>▲</sup>		
Grid to Plate.....	2	μμf
Grid to Cathode and Heater.....	2	μμf
Plate to Cathode and Heater.....	2	μμf

<sup>▲</sup> With shell connected to cathode.

**Maximum Ratings:**

**CLASS A<sub>1</sub> AMPLIFIER (Each Unit):**

PLATE VOLTAGE.....	250 <i>max</i>	volts
PEAK HEATER-CATHODE VOLTAGE:		
Heater negative with respect to cathode.....	90 <i>max</i>	volts
Heater positive with respect to cathode.....	90 <i>max</i>	volts

**Characteristics:**

Plate Voltage.....	250	volts
Grid Voltage.....	-2	volts
Amplification Factor.....	70	
Plate Resistance (Approx.).....	53000	ohms
Transconductance.....	1325	μmhos
Plate Current.....	2	ma

## 6SF5 6SF5-GT

### HIGH-MU TRIODE

Metal type 6SF5 and glass octal type 6SF5-GT are used in resistance-coupled amplifier circuits. Outlines 3 and 22, respectively, OUTLINES SECTION. Type 6SF5-GT may be

supplied with pin No.1 omitted. Tubes require octal socket and may be mounted in any position. Characteristics, application, and references under type 6F5 apply to types 6SF5 and 6SF5-GT. Heater volts (ac/dc), 6.3; amperes, 0.3. Type 6SF5-GT is used principally for renewal purposes.

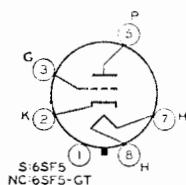

### DIODE— REMOTE-CUTOFF PENTODE

## 6SF7

Metal type used as combined rf or if amplifier and detector or avc tube in radio receivers. Also used as resistance-coupled af amplifier. Outline 3, OUTLINES SECTION. Tube requires octal socket and may be mounted in any position. Heater volts (ac/dc), 6.3; amperes, 0.3. Maximum ratings of pentode unit as class A<sub>1</sub> amplifier: plate and grid-No.2 supply volts,

300 *max*; grid-No.2 volts, 100 *max*; grid-No.1 volts, 0 *max*; plate dissipation, 3.5 *max* watts; grid-No.2 input, 0.5 *max* watt; peak heater-cathode volts, 90 *max*. For diode operation curves, refer to type 6AA 6. Type 6SF7 is used principally for renewal purposes.

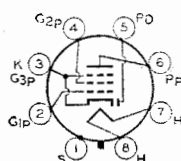

#### PENTODE UNIT AS CLASS A<sub>1</sub> AMPLIFIER

Characteristics:			
Plate Voltage.....	100	250	volts
Grid-No.2 Voltage.....	100	100	volts
Grid-No.1 Voltage.....	-1	-1	volt
Plate Resistance (Approx.).....	0.2	9.7	megohm
Transconductance.....	1975	2050	μmhos
Grid-No.1 Voltage (Approx.) for transconductance of 10 μmhos.....	-35	-35	volts
Plate Current.....	12	12.4	ma
Grid-No. 2 Current.....	3.4	3.3	ma

### SEMIREMOTE-CUTOFF PENTODE

## 6SG7

Metal type used as rf amplifier in high-frequency and wide-band applications. Features high transconductance with low grid-No.1-to-plate capacitance. Suitable for frequencies

up to 18 megacycles per second (approx.). Two separate cathode terminals enable the input and output circuits to be effectively isolated from each other. Outline 3, OUTLINES SECTION. Tube requires octal socket and may be mounted in any position.

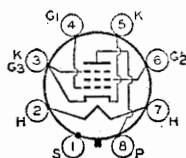



HEATER VOLTAGE (AC/DC).....	6.3	volts
HEATER CURRENT.....	0.3	ampere
DIRECT INTERELECTRODE CAPACITANCES: <sup>▲</sup>		
Grid No.1 to Plate.....	0.003 max	μf
Grid No.1 to Cathode, Heater, Grid No.2, and Grid No.3.....	8.5	μf
Plate to Cathode, Heater, Grid No.2, and Grid No.3.....	7	μf

▲ With shell connected to cathode.

<b>Maximum Ratings:</b>	<b>CLASS A<sub>1</sub> AMPLIFIER</b>	
PLATE VOLTAGE.....	300 max	volts
GRID-NO.2 (SCREEN-GRID) VOLTAGE.....	See curve page 66	
GRID-NO.2 SUPPLY VOLTAGE.....	300 max	volts
GRID-NO.1 (CONTROL-GRID) VOLTAGE, Positive bias value.....	0 max	volts
PLATE DISSIPATION.....	3 max	watts
GRID-NO.2 INPUT:		
For grid-No.2 voltages up to 150 volts.....	0.6 max	watt
For grid-No.2 voltages between 150 and 300 volts.....	See curve page 66	
PEAK HEATER-CATHODE VOLTAGE:		
Heater negative with respect to cathode.....	90 max	volts
Heater positive with respect to cathode.....	90 max	volts

**Characteristics:**

Plate Voltage.....	100	250	250	volts
Grid-No.2 Voltage.....	100	125	150	volts
Grid-No.1 Voltage.....	-1	-1	-2.5	volts
Plate Resistance (Approx.).....	0.25	0.9	*	megohm
Transconductance.....	4100	4700	4000	μmbos
Grid-No.1 Voltage (Approx.) for transconductance of 40 μmbos.....	-11.5	-14	-17.5	volts
Plate Current.....	8.2	11.8	9.2	ma
Grid-No.2 Current.....	3.2	4.4	3.4	ma

\* Greater than 1 megohm.

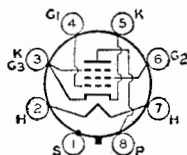

**SHARP-CUTOFF PENTODE**

Metal type used as rf amplifier in high-frequency, wide-band applications and as a limiter tube in FM equipment. Outline 3, OUTLINES SECTION. Tube requires octal socket

**6SH7**

and may be mounted in any position. Two separate cathode terminals enable the input and output circuits to be isolated effectively from each other. This type is not recommended for high-gain audio-amplifier applications because undesirable hum may be encountered. For typical operation as a resistance-coupled amplifier, refer to RESISTANCE-COUPLED AMPLIFIER SECTION.

HEATER VOLTAGE (AC/DC).....	6.3	volts
HEATER CURRENT.....	0.3	ampere
DIRECT INTERELECTRODE CAPACITANCES: <sup>▲</sup>		
Grid No.1 to Plate.....	0.003 max	μf
Grid No.1 to Cathode, Heater, Grid No.2, and Grid No.3.....	8.5	μf
Plate to Cathode, Heater, Grid No.2, and Grid No.3.....	7.0	μf

▲ With shell connected to cathode

<b>Maximum Ratings:</b>	<b>CLASS A<sub>1</sub> AMPLIFIER</b>	
PLATE VOLTAGE.....	300 max	volts
GRID-NO.2 (SCREEN-GRID) VOLTAGE.....	See curve page 66	
GRID-NO.2 SUPPLY VOLTAGE.....	300 max	volts
GRID-NO.1 (CONTROL-GRID) VOLTAGE, Positive bias value.....	0 max	volts
PLATE DISSIPATION.....	3 max	watts
GRID-NO.2 INPUT:		
For grid-No.2 voltages up to 150 volts.....	0.7 max	watt
For grid-No.2 voltages between 150 and 300 volts.....	See curve page 66	
PEAK HEATER-CATHODE VOLTAGE:		
Heater negative with respect to cathode.....	90 max	volts
Heater positive with respect to cathode.....	90 max	volts

**Characteristics:**

Plate Voltage.....	100	250	volts
Grid-No.2 Voltage.....	100	150	volts
Grid-No.1 Voltage.....	-1	-1	volt
Plate Resistance (Approx.).....	0.35	0.9	megohm
Transconductance.....	4000	4900	μmbos
Grid-No.1 Voltage (Approx.) for plate current of 10 μa.....	-4.0	-5.5	volts
Plate Current.....	5.3	10.8	ma
Grid-No.2 Current.....	2.1	4.1	ma

# 6SJ7 6SJ7-GT

## SHARP-CUTOFF PENTODE

Metal type 6SJ7 and glass octal type 6SJ7-GT used as rf amplifiers and biased detectors. As a detector, either type is capable of delivering large audio-frequency output voltage

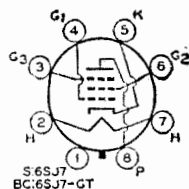

with relatively small input voltage. Outlines 3 and 24, respectively, **OUTLINES SECTION**. Tubes require octal socket and may be mounted in any position. Type 6SJ7-GT is used principally for renewal purposes.

HEATER VOLTAGE (AC/DC).....	6.3	volts
HEATER CURRENT.....	0.3	ampere
DIRECT INTERELECTRODE CAPACITANCES for 6SJ7: <sup>2</sup>		
Pentode Connection:		
Grid No.1 to Plate.....	0.005 max	μuf
Grid No.1 to Cathode, Heater, Grid No.2, and Grid No.3.....	6.0	μuf
Plate to Cathode, Heater, Grid No.2, and Grid No.3.....	7.0	μuf
Triode Connection:		
Grid No.1 to Plate.....	2.8	μuf
Grid No.1 to Cathode and Heater.....	3.4	μuf
Plate to Cathode and Heater.....	11	μuf

- <sup>2</sup> With shell connected to cathode.
- With grids No.2 and No.3 connected to plate.

### CLASS A<sub>1</sub> AMPLIFIER

#### Maximum Ratings:

	Triode Connection*	Pentode Connection	
PLATE VOLTAGE.....	250 max	300 max	volts
GRID No.3 (SUPPRESSOR GRID).....	Connect to cathode at socket		
GRID-No.2 (SCREEN-GRID) VOLTAGE.....	-	See curve page 66	
GRID-No.2 SUPPLY VOLTAGE.....	-	300 max	volts
GRID-No.1 (CONTROL-GRID) VOLTAGE, Positive bias value.....	0 max	0 max	volts
PLATE DISSIPATION.....	2.5 max	2.5 max	watts
GRID-No.2 INPUT:			
For grid-No.2 voltages up to 150 volts.....	-	0.7 max	watt
For grid-No.2 voltages between 150 and 300 volts.....	-	See curve page 66	
PEAK HEATER-CATHODE VOLTAGE:			
Heater negative with respect to cathode.....	90 max	90 max	volts
Heater positive with respect to cathode.....	90 max	90 max	volts

#### Typical Operation:

	Triode Connection*		Pentode Connection		
Plate Voltage.....	180	250	100	250	volts
Grid No.3.....	-	-	Connected to cathode at socket		
Grid-No.2 Voltage.....	-	-	100	100	volts
Grid-No.1 Voltage.....	-6	-8.5	-3	-3	volts
Amplification Factor.....	19	19	-	-	
Plate Resistance (Approx.).....	8250	7600	700000	†	ohms
Transconductance.....	2300	2500	1575	1650	μmhos
Grid-No.1 Voltage (Approx.) for plate current of 10 μa.....	-	-	-8	-8	volts
Plate Current.....	6.0	9.2	2.9	3.0	ma
Grid-No.2 Current.....	-	-	0.9	0.8	ma

\* Grids No.2 and No.3 connected to plate. † Greater than 1 megohm.

# 6SK7 6SK7-GT

## REMOTE-CUTOFF PENTODE

Metal type 6SK7 and glass octal type 6SK7-GT are used as rf or if amplifiers in radio receivers. They feature single-ended construction and interlead shields. Because of remote-cutoff

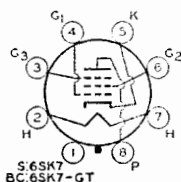

characteristic, these types are able to handle large signal voltages without cross-

modulation or modulation-distortion and are often used in receivers with avc. Outlines 3 and 24, respectively, **OUTLINES SECTION**. Tubes require octal socket and may be mounted in any position. Type 6SK7-GT is used principally for renewal purposes.

HEATER VOLTAGE (AC/DC).....	6.3	volts
HEATER CURRENT.....	0.3	ampere
DIRECT INTERELECTRODE CAPACITANCES for 6SK7:*		
Grid No.1 to Plate.....	0.003 max	$\mu\text{f}$
Grid No.1 to Cathode, Heater, Grid No.2, and Grid No.3.....	6.0	$\mu\text{f}$
Plate to Cathode, Heater, Grid No.2, and Grid No.3.....	7.0	$\mu\text{f}$

\* With shell connected to cathode.

**Maximum Ratings:**

**CLASS A<sub>1</sub> AMPLIFIER**

PLATE VOLTAGE.....	300 max	volts
GRID No.3 (SUPPRESSOR GRID).....	Connect to cathode	at socket
GRID-No.2 (SCREEN-GRID) VOLTAGE.....	See curve	page 66
GRID-No.2 SUPPLY VOLTAGE.....	300 max	volts
GRID-No.1 (CONTROL-GRID) VOLTAGE, Positive bias value.....	0 max	volts
PLATE DISSIPATION.....	4.0 max	watts
GRID-No.2 INPUT:		
For grid-No.2 voltages up to 150 volts.....	0.4 max	watt
For grid-No.2 voltages between 150 and 300 volts.....	See curve	page 66
<b>PEAK HEATER-CATHODE VOLTAGE:</b>		
Heater negative with respect to cathode.....	90 max	volts
Heater positive with respect to cathode.....	90 max	volts

**Characteristics:**

Plate Voltage.....	100	250	volts
Grid No.3.....	Connected to cathode	at socket	
Grid-No.2 Voltage.....	100	100	volts
Grid-No.1 Voltage.....	-1	-3	volts
Plate Resistance (Approx.).....	0.12	0.8	megohm
Transconductance.....	2350	2000	$\mu\text{mhos}$
Grid-No.1 Voltage (Approx.) for transconductance of 10 $\mu\text{mhos}$ .....	-35	-35	volts
Plate Current.....	13	9.2	ma
Grid-No.2 Current.....	4.0	2.6	ma

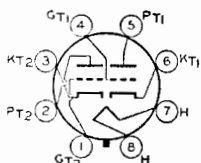

**HIGH-MU TWIN TRIODE**

Glass octal type used as phase inverter in radio equipment. Each unit may also be used in resistance-coupled amplifier circuits. Outline 22, **OUTLINES SECTION**. Tube requires

**6SL7-GT**

octal socket and may be mounted in any position. Except for the common heater, each triode unit is independent of the other. For typical operation as phase inverter or resistance-coupled amplifier, refer to **RESISTANCE-COUPLED AMPLIFIER SECTION**.

HEATER VOLTAGE (AC/DC).....	6.3	volts
HEATER CURRENT.....	0.3	ampere
DIRECT INTERELECTRODE CAPACITANCES (Approx.): <sup>a</sup>		
	<i>Unit No. 1</i>	<i>Unit No. 2</i>
Grid to Plate.....	2.8	2.8
Grid to Cathode and Heater.....	3.0	3.4
Plate to Cathode and Heater.....	3.8	3.2

<sup>a</sup> With external shield connected to cathode.

**Maximum Ratings:**

**CLASS A<sub>1</sub> AMPLIFIER (Each Unit)**

PLATE VOLTAGE.....	300 max	volts
GRID VOLTAGE, Positive bias value.....	0 max	volts
PLATE DISSIPATION.....	1 max	watt
<b>PEAK HEATER-CATHODE VOLTAGE:</b>		
Heater negative with respect to cathode.....	90 max	volts
Heater positive with respect to cathode.....	90 max	volts

**Characteristics:**

Plate Voltage.....	250	volts
Grid Voltage.....	-2	volts
Amplification Factor.....	70	
Plate Resistance (Approx.).....	44000	ohms
Transconductance.....	1600	$\mu\text{mhos}$
Plate Current.....	2.3	ma

**6SN7-GT**  
**6SN7-GTA**  
**6SN7-GTB**

**MEDIUM-MU TWIN TRIODE**

Glass octal types used as combined vertical oscillators and vertical deflection amplifiers, and as horizontal deflection oscillators, in television receivers. Each unit may also be used in

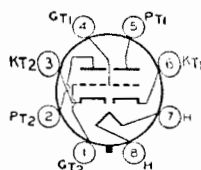

multivibrator or resistance-coupled amplifier circuits in radio equipment. Type 6SN7-GTB has a controlled heater warm-up time to permit use in series-connected heater strings. Outline 22, OUTLINES SECTION. Tubes require octal socket and may be mounted in any position. Except for the common heater, each triode unit is independent of the other. For typical operation as resistance-coupled amplifier, refer to Chart 6, RESISTANCE-COUPLED AMPLIFIER SECTION. Types 6SN7-GT and 6SN7-GTA are DISCONTINUED types listed for reference only.

HEATER VOLTAGE (AC/DC) .....	6.3	volts
HEATER CURRENT .....	0.6	ampere
HEATER WARM-UP TIME (Average) for 6SN7-GTB .....	11	seconds
DIRECT INTERELECTRODE CAPACITANCES (Approx.) for 6SN7-GTB:		
	<i>Unit No.1</i>	<i>Unit No.2</i>
Grid to Plate .....	4.0	3.8
Grid to Cathode and Heater .....	2.2	2.6
Plate to Cathode and Heater .....	0.7	0.7

<b>Maximum Ratings:</b>	<b>CLASS A<sub>1</sub> AMPLIFIER (Each Unit)</b>	<b>6SN7-GTB</b>
PLATE VOLTAGE .....	450 <i>max</i>	volts
CATHODE CURRENT .....	20 <i>max</i>	ma
PLATE DISSIPATION:		
For either plate .....	5 <i>max</i>	watts
For both plates with both units operating .....	7.5 <i>max</i>	watts
PEAK HEATER-CATHODE VOLTAGE:		
Heater negative with respect to cathode .....	200 <i>max</i>	volts
Heater positive with respect to cathode .....	200° <i>max</i>	volts

<b>Characteristics:</b>		
Plate Voltage .....	90	250
Grid Voltage .....	0	-8
Amplification Factor .....	20	20
Plate Resistance (Approx.) .....	6700	7700
Transconductance .....	3000	2600
Plate Current .....	10	9
Plate Current for grid voltage of -12.5 volts .....	-	1.3
Grid Voltage (Approx.) for plate current of 10 $\mu$ a .....	-7	-18

<b>Maximum Circuit Value:</b>	
Grid-Circuit Resistance:	
For fixed-bias operation .....	1.0 <i>max</i> megohm

\*The dc component must not exceed 100 volts.

**OSCILLATOR (Each Unit)**  
 For operation in a 525-line, 30-frame system

	<b>6SN7-GTB</b>	
	<i>Vertical</i>	<i>Horizontal</i>
	<i>Deflection</i>	<i>Deflection</i>
	<i>Oscillator</i>	<i>Oscillator</i>
<b>Maximum Ratings:</b>		
DC PLATE VOLTAGE .....	450 <i>max</i>	450 <i>max</i> volts
PEAK NEGATIVE-PULSE GRID VOLTAGE .....	-400 <i>max</i>	-600 <i>max</i> volts
PEAK CATHODE CURRENT .....	70 <i>max</i>	300 <i>max</i> ma
AVERAGE CATHODE CURRENT .....	20 <i>max</i>	20 <i>max</i> ma
PLATE DISSIPATION:		
For either plate .....	5 <i>max</i>	5 <i>max</i> watts
For both plates with both units operating .....	7.5 <i>max</i>	7.5 <i>max</i> watts
PEAK HEATER-CATHODE VOLTAGE:		
Heater negative with respect to cathode .....	200 <i>max</i>	200 <i>max</i> volts
Heater positive with respect to cathode .....	200° <i>max</i>	200° <i>max</i> volts
<b>Maximum Circuit Value:</b>		
Grid-Circuit Resistance .....	2.2 <i>max</i>	2.2 <i>max</i> megohms

## VERTICAL DEFLECTION AMPLIFIER (Each Unit)

For operation in a 525-line, 30-frame system

### Maximum Ratings:

	6SN7-GTB	
DC PLATE VOLTAGE	450 max	volts
PEAK POSITIVE-PULSE PLATE VOLTAGE † (Absolute maximum)	1500 max	volts
PEAK NEGATIVE-PULSE GRID VOLTAGE	-250 max	volts
PEAK CATHODE CURRENT	70 max	ma
AVERAGE CATHODE CURRENT	20 max	ma
PLATE DISSIPATION:		
For either plate	5 max	watts
For both plates with both units operating	7.5 max	watts
PEAK HEATER-CATHODE VOLTAGE:		
Heater negative with respect to cathode	200 max	volts
Heater positive with respect to cathode	200 max	volts

### Maximum Circuit Value:

#### Grid-Circuit Resistance:

For cathode-bias operation 2.2 max megohms

† The duration of the voltage pulse must not exceed 15 per cent of one vertical scanning cycle. In a 525-line, 30-frame system, 15 per cent of one vertical scanning cycle is 2.5 milliseconds.

‡ Under no circumstances should this absolute value be exceeded.

° The dc component must not exceed 100 volts.

### AVERAGE PLATE CHARACTERISTICS EACH TRIODE UNIT

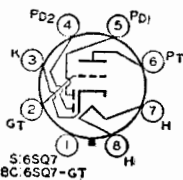
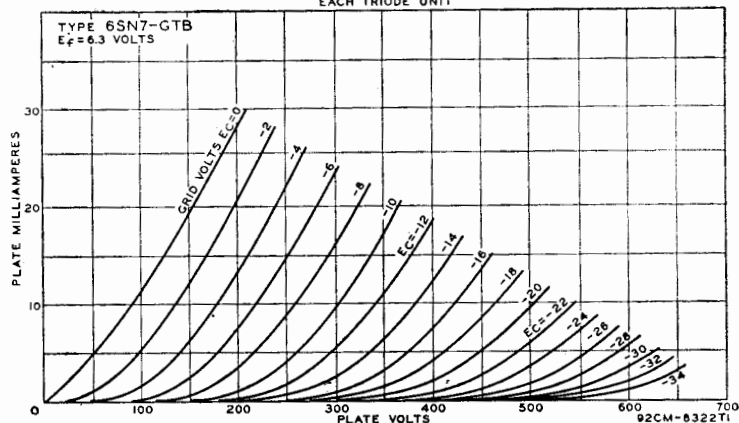

### TWIN DIODE—HIGH-MU TRIODE

Metal type 6SQ7 and glass octal type 6SQ7-GT used as combined detector, amplifier, and avc tube in radio receivers. Outlines 3 and 24, respectively, OUTLINES SECTION. Tubes

require octal socket and may be mounted in any position. These types are similar electrically to type 6Q7 in many respects, but they have a higher- $\mu$  triode. Diode-biasing of the triode unit is not suitable because of the probability of triode plate-current cutoff even with relatively small signal voltages applied to the diode circuit. Type 6SQ7-GT is used principally for renewal purposes.

# 6SQ7 6SQ7-GT

HEATER VOLTAGE (AC/DC)	6.3	volts
HEATER CURRENT	0.3	ampere
DIRECT INTERELECTRODE CAPACITANCES for 6SQ7:°		

#### Triode Unit:

Grid to Plate	1.6	$\mu\text{f}$
Grid to Cathode and Heater	3.2	$\mu\text{f}$
Plate to Cathode and Heater	3	$\mu\text{f}$
Either Diode Plate to Cathode and Heater	3.3 max	$\mu\text{f}$
Triode Grid to Plate of Diode No.1	0.03 max	$\mu\text{f}$
Triode Grid to Plate of Diode No.2	0.04 max	$\mu\text{f}$

° With shell connected to cathode.

**Maximum Ratings:**

**TRIODE UNIT AS CLASS A<sub>1</sub> AMPLIFIER**

PLATE VOLTAGE.....	300 <i>max</i>	volts
GRID VOLTAGE, Positive bias value.....	0 <i>max</i>	volts
PLATE DISSIPATION.....	0.5 <i>max</i>	watt
<b>PEAK HEATER-CATHODE VOLTAGE:</b>		
Heater negative with respect to cathode.....	90 <i>max</i>	volts
Heater positive with respect to cathode.....	90 <i>max</i>	volts

**Characteristics:**

Plate Voltage.....	100	250	volts
Grid Voltage.....	-1	-2	volts
Amplification Factor.....	100	100	
Plate Resistance (Approx.).....	11000Ω	8500Ω	ohms
Transconductance.....	925	1175	μmhos
Plate Current.....	0.5	1.1	ma

**Maximum Rating:**

**DIODE UNITS**

PLATE CURRENT (Each Unit).....	1.0 <i>max</i>	ma
--------------------------------	----------------	----

Two diode plates are placed around a cathode, the sleeve of which is common to the triode unit. Each diode plate has its own base pin. For diode operation curves, refer to type 6AV6.

**TWIN DIODE—  
MEDIUM-MU TRIODE**

**6SR7**

Metal type used as combined detector, amplifier, and avc tube. It is equivalent in performance to miniature type 6BF6. Outline 3, OUTLINES SECTION. Tube requires octal socket and may be mounted in any position. Heater volts (ac/dc), 6.3; amperes, 0.3. Maximum ratings and typical operation of triode unit as class A<sub>1</sub> amplifier: plate volts, 250 *max*; grid volts, -9; amplification factor, 16; plate resistance (approx.), 8500 ohms; transconductance, 1900 μmhos; plate ma., 9.5; plate dissipation, 2.5 *max* watts; peak heater-cathode volts, 90 *max*. For diode-operation curves, refer to type 6AV6. Type 6SR7 is used principally for renewal purposes.

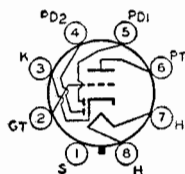

resistance (approx.), 8500 ohms; transconductance, 1900 μmhos; plate ma., 9.5; plate dissipation, 2.5 *max* watts; peak heater-cathode volts, 90 *max*. For diode-operation curves, refer to type 6AV6. Type 6SR7 is used principally for renewal purposes.

**REMOTE-CUTOFF PENTODE**

**6SS7**

Metal type used in rf or if stages of radio receivers particularly those employing avc. Outline 3, OUTLINES SECTION. Tube requires octal socket and may be mounted in any position. Heater volts (ac/dc), 6.3; amperes, 0.15. Typical operation as class A<sub>1</sub> amplifier: plate volts, 250 (300 *max*); grid-No.2 supply volts, 300 *max*; grid-No.2 volts, 100; grid-No.1 volts, -3; grid No.3 connected to cathode at socket;

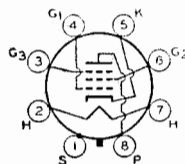
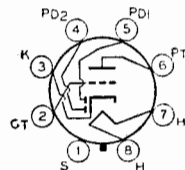

plate resistance (approx.), 1 megohm; transconductance, 1850 μmhos; plate ma., 9; grid-No.2 ma., 2; plate dissipation, 2.25 *max* watts; grid-No.2 input, 0.35 *max* watts. Type 6SS7 is used principally for renewal purposes.

**TWIN DIODE—MEDIUM-MU TRIODE**

**6ST7**

Metal type used as combined detector, amplifier, and avc tube. Within maximum ratings this type is electrically identical to type 6BF6 except for interelectrode capacitances and heater current. Outline 3, OUTLINES SECTION. Tube requires octal socket and may be mounted in any position. Heater volts (ac/dc), 6.3; amperes, 0.15. Maximum ratings of triode



unit as class A<sub>1</sub> amplifier: plate volts, 250 *max*; plate dissipation, 2.5 *max* watts. For diode operation curves, refer to type 6AV6. Type 6ST7 is a DISCONTINUED type listed for reference only.

**TWIN DIODE—HIGH-MU TRIODE**

**6SZ7**

Metal type used as combined detector, amplifier, and avc tube in radio receivers. Except for heater-current rating and interelectrode capacitances, this type is essentially the same electrically as type 6AT6. Outline 3, OUTLINES SECTION. Tube requires octal socket. Heater volts (ac/dc), 6.3; amperes, 0.15. For diode operation curves, refer to type 6AV6. Type 6SZ7 is a DISCONTINUED type listed for reference only.

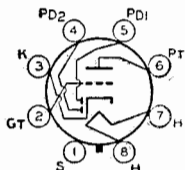

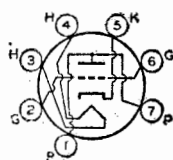

### MEDIUM-MU TRIODE

Miniature type used as oscillator in tuners of uhf television receivers. Outline 9, OUTLINES SECTION. Tube requires miniature seven-contact socket and may be mounted in any position. Heater volts (ac/dc), 6.3; amperes, 0.225. This type is used principally for renewal purposes.

# 6T4

AMPLIFICATION FACTOR <sup>2</sup> .....	13	
TRANSCONDUCTANCE*.....	7000	μmhos

<sup>2</sup> For plate-supply volts, 80; cathode-bias resistor, 150 ohms; plate ma., 18.

#### OSCILLATOR IN UHF TELEVISION RECEIVERS

##### Maximum Ratings:

PLATE VOLTAGE.....	200 max	volts
GRID CURRENT.....	8 max	ma
CATHODE CURRENT.....	30 max	ma
PLATE DISSIPATION.....	3.5 max	watts
PEAK HEATER-CATHODE VOLTAGE:		
Heater negative with respect to cathode.....	50 max	volts
Heater positive with respect to cathode.....	50*max	volts

\* The dc component must not exceed 25 volts.

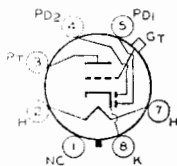

### TWIN DIODE—HIGH-MU TRIODE

Glass octal type used as combined detector, amplifier, and avc tube in radio receivers. Outline 39, OUTLINES SECTION. Heater volts (ac/dc), 6.3; amperes, 0.15. Typical operation as class A<sub>1</sub> amplifier: plate volts, 250 max; grid volts, -3; plate ma., 1.2; plate resistance (approx.), 62000 ohms; amplification factor, 65; transconductance, 1050 μmhos. For diode operation curves, refer to type 6AV6. Type 6T7-G is a DISCONTINUED type listed for reference only.

# 6T7-G

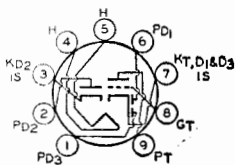

### TRIPLE DIODE—HIGH-MU TRIODE

Miniature types used as combined audio amplifier, AM detector, and FM detector in AM/FM radio receivers. Diode unit No.1 is used for AM detection, and diode units No.2 and No.3

# 6T8 6T8-A

are used for FM detection. Type 6T8-A has a controlled heater warm-up time for use in receivers employing series-connected heater strings. Outline 12, OUTLINES SECTION. Tubes require miniature nine-contact socket and may be mounted in any position. For typical operation as resistance-coupled amplifier, refer to Chart 3, RESISTANCE-COUPLED AMPLIFIER SECTION. Type 6T8 is a DISCONTINUED type listed for reference only.

HEATER VOLTAGE (AC/DC).....	6.3	volts
HEATER CURRENT.....	0.45	ampere
HEATER WARM-UP TIME (Average) for 6T8-A.....	11	seconds

DIRECT INTERELECTRODE CAPACITANCES for 6T8-A:		Without External Shield	With External Shield*
<b>Triode Unit:</b>			
Grid to Plate.....	1.7	1.7	μμf
Grid to Cathode, Internal Shield (pin 7), and Heater....	1.6	1.7	μμf
Plate to Cathode, Internal Shield (pin 7), and Heater....	1.2	2.4	μμf
<b>Diode Units:</b>			
Diode-No.1 Plate to Cathode, Internal Shield (pin 7), and Heater.....	3.8	3.8	μμf
Diode-No.2 Plate to Cathode, Internal Shield (pin 3), and Heater.....	3.8	3.8•	μμf
Diode-No.3 Plate to Cathode, Internal Shield (pin 7), and Heater.....	3.4	3.6	μμf

Diode-No.2 Cathode, Internal Shield (pin 3) to All Other Electrodes, and Heater.....	7.5	8.5 <sup>■</sup>	μf
Triode Grid to any Diode Plate.....	0.034 max	0.034 max	μf

\* With external shield connected to pin 7 except as noted.  
 ■ With external shield connected to pin 3.  
 ■ With external shield connected to pins 4 and 5.

**TRIODE UNIT AS CLASS A<sub>1</sub> AMPLIFIER**

Maximum Ratings, (Design-Maximum Values):

PLATE VOLTAGE.....	330 max	volts
GRID VOLTAGE, Positive bias value.....	0 max	volts
PLATE DISSIPATION.....	1.1 max	watts
PEAK HEATER-CATHODE VOLTAGE:		
Heater negative with respect to cathode.....	100 max	volts
Heater positive with respect to cathode.....	100 max	volts

Characteristics:

Plate Voltage.....	100	250	volts
Grid Voltage.....	-1	-3	volts
Amplification Factor.....	70	70	
Plate Resistance (Approx.).....	54000	58000	ohms
Transconductance.....	1300	1200	μmhos
Plate Current.....	0.8	1.0	ma

**DIODE UNITS**

Maximum Ratings, (Design-Maximum Values):

PLATE CURRENT (Each Unit).....	5.5 max	ma
PEAK HEATER-CATHODE VOLTAGE (Unit No.2):		
Heater negative with respect to cathode.....	100 max	volts
Heater positive with respect to cathode.....	100 max	volts

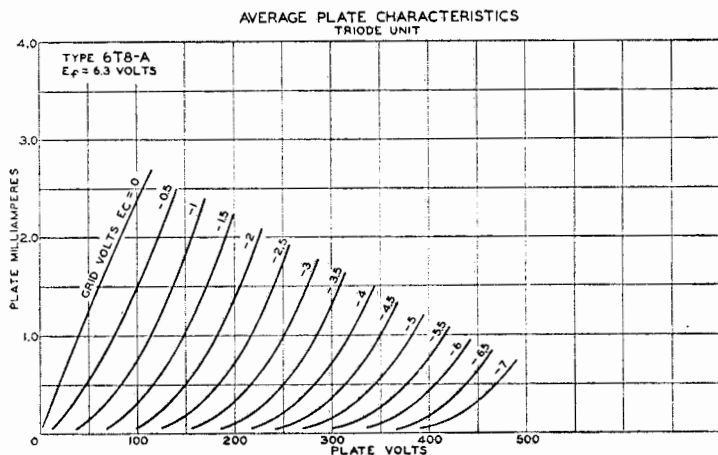

**6U5**

**ELECTRON-RAY TUBE**

Glass type used to indicate visually, by means of a fluorescent target, the effects of a change in a controlling voltage. It is used as a convenient, non-mechanical means of indicating accurate radio-receiver tuning. Outline 34, OUTLINES SECTION. Tube requires six-contact socket and may be mounted in any position. For a discussion of electron-ray tube

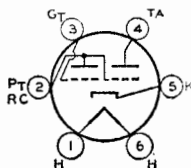

considerations, refer to **ELECTRON TUBE APPLICATIONS SECTION**. Heater volts (ac/dc), 6.3; amperes, 0.3. Typical operation in indicator service: plate- and target-supply volts, 250 (285 max.); target-supply volts, 125 min; series triode-plate resistor, 1 megohm; target ma., 4; triode-plate ma.; 0.21; triode-plate dissipation, 1 max watt; triode-grid volts (approx.), -22 for 0° shadow angle, 0 for 90° shadow angle; peak heater-cathode volts, 90 max. This type is used principally for renewal purposes.



REMOTE-CUTOFF PENTODE

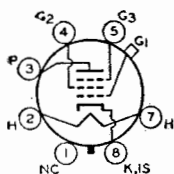

Glass octal type used in rf and if stages of radio receivers employing avc. It is also used as a mixer in superheterodyne circuits. Maximum over-all length, 4-7/8 inches; maximum diameter, 1-9/16 inches. Tube requires octal socket. Heater volts (ac/dc), 6.3; amperes, 0.3. Typical operation as class A<sub>1</sub> amplifier: plate volts, 250 (300 max); grid-No.2 supply volts, 300 max; grid-No.2 volts, 100; grid No.3 connected to cathode at socket; grid-No.1 volts, -3; plate resistance (approx.), 0.8 megohm; transconductance, 1600 μmhos; plate ma., 8.2; grid-No.2 ma., 2; plate dissipation, 2.25 max watts; grid-No.2 input, 0.25 max watt. This is a DISCONTINUED type listed for reference only.

6U7-G

connected to cathode at socket; grid-No.1 volts, -3; plate resistance (approx.), 0.8 megohm; transconductance, 1600 μmhos; plate ma., 8.2; grid-No.2 ma., 2; plate dissipation, 2.25 max watts; grid-No.2 input, 0.25 max watt. This is a DISCONTINUED type listed for reference only.

MEDIUM-MU TRIODE—  
SHARP-CUTOFF PENTODE

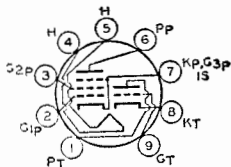

Miniature types used as combined oscillator and mixer tubes in television receivers utilizing an intermediate frequency in the order of 40 megacycles per second. Type 6U8-A has a controlled heater warm-up time for use in television receivers employing series-connected heater strings. Outline 12, OUTLINES SECTION. Tubes require miniature nine-contact socket and may be mounted in any position. Type 6U8 is a DISCONTINUED type listed for reference only.

6U8

6U8-A

controlled heater warm-up time for use in television receivers employing series-connected heater strings. Outline 12, OUTLINES SECTION. Tubes require miniature nine-contact socket and may be mounted in any position. Type 6U8 is a DISCONTINUED type listed for reference only.

HEATER VOLTAGE (AC/DC).....	6.3	volts
HEATER CURRENT.....	0.45	ampere
HEATER WARM-UP TIME (Average) for 6U8-A.....	11	seconds

DIRECT INTERELECTRODE CAPACITANCES:

Triode Unit:	Without External Shield	With External Shield*	
Grid to Plate.....	1.8	1.8	μf
Grid to Cathode, Heater, Pentode Cathode, Pentode Grid No.3, and Internal Shield.....	2.8	2.8	μf
Plate to Cathode, Heater, Pentode Cathode, Pentode Grid No.3, and Internal Shield.....	1.5	2	μf
Pentode Unit:			
Grid No.1 to Plate.....	0.010 max	0.006 max	μf
Grid No.1 to Cathode, Heater, Grid No.2, Grid No.3, and Internal Shield.....	5.0	5.0	μf
Plate to Cathode, Heater, Grid No.2, Grid No.3, and Internal Shield.....	2.6	3.5	
Triode Cathode to Heater.....	3	3•	μf
Pentode Cathode, Pentode Grid No.3, and Internal Shield to Heater.....	3	3•	μf
Pentode Grid No.1 to Triode Plate.....	0.2 max	0.2 max	μf
Pentode Plate to Triode Plate.....	0.1 max	0.02 max	μf

\* With external shield connected to pin 4 except as noted.

• With external shield connected to pin 6.

CLASS A<sub>1</sub> AMPLIFIER

Maximum Ratings, (Design-Maximum Values):

	Triode Unit	Pentode Unit	
PLATE VOLTAGE.....	330 max	330 max	volts
GRID-NO.2 (SCREEN-GRID) SUPPLY VOLTAGE.....	-	330 max	volts
GRID-NO.2 VOLTAGE.....	-	See curve page 66	
GRID-NO.1 (CONTROL-GRID) VOLTAGE, Positive bias value.....	0 max	0 max	volts
PLATE DISSIPATION.....	2.5 max	3 max	watts
GRID-NO.2 INPUT:			
For grid-No.2 voltages up to 165 volts.....	-	0.55 max	watt
For grid-No.2 voltages between 165 and 330 volts.....	-	See curve page 66	
PEAK HEATER-CATHODE VOLTAGE:			
Heater negative with respect to cathode.....	200 max	200 max	volts
Heater positive with respect to cathode.....	200 max	200 max	volts

**Characteristics:**

	<i>Triode Unit</i>	<i>Pentode Unit</i>	
Plate Voltage.....	125	125	volts
Grid-No.2 Voltage.....	-	110	volts
Grid-No.1 Voltage.....	-1	-1	volt
Amplification Factor.....	40	-	
Plate Resistance (Approx.).....	-	0.2	megohm
Transconductance.....	7500	5000	$\mu$ mhos
Grid-No.1 Voltage (Approx.) for plate current of 20 $\mu$ a.....	-9	-8	volts
Plate Current.....	13.5	9.5	ma
Grid-No.2 Current.....	-	3.5	ma

■ The dc component must not exceed 100 volts.

**HALF-WAVE VACUUM RECTIFIER**

**6V3-A**

Miniature type used as a damper tube in horizontal deflection circuits of television receivers. Outline 17, OUTLINES SECTION, except maximum over-all length 3-1/16 inches;

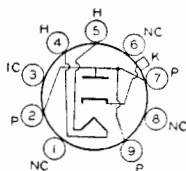

maximum seated length 2-25/32 inches. Tube requires miniature nine-contact socket and may be mounted in any position. It is especially important that this tube, like other power-handling tubes, be adequately ventilated.

HEATER VOLTAGE (AC/DC).....	6.3	volts
HEATER CURRENT.....	1.75	amperes

**DAMPER SERVICE**

*For operation in a 525-line, 30-frame system*

**Maximum Ratings:**

PEAK INVERSE PLATE VOLTAGE <sup>‡</sup> ( <i>Absolute Maximum</i> ).....	6000 <sup>†</sup> max	volts
PEAK PLATE CURRENT.....	800 max	ma
DC PLATE CURRENT.....	135 max	ma
PEAK HEATER-CATHODE VOLTAGE:		
Heater negative with respect to cathode <sup>‡</sup> ( <i>Absolute Maximum</i> ).....	6750 <sup>†</sup> max	volts
Heater positive with respect to cathode.....	300 <sup>°</sup> max	volts

<sup>‡</sup>The duration of the voltage pulse must not exceed 15 per cent of one horizontal scanning cycle. In a 525-line, 30-frame system, 15 per cent of one horizontal scanning cycle is 10 microseconds.

† Under no circumstances should this absolute value be exceeded.

■ The dc component must not exceed 750 volts.

° The dc component must not exceed 100 volts.

**6V6**

**BEAM POWER TUBE**

**6V6-GT**  
**6V6-GTA**

Metal type 6V6 and glass octal types 6V6-GT and 6V6-GTA are used as output amplifiers in automobile, battery-operated, and other receivers in which reduced plate-current drain

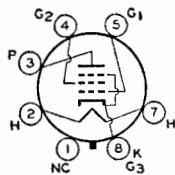

is desirable. Outlines 6, 22, and 22, respectively, OUTLINES SECTION. Type 6V6-GT may be supplied with pin No.1 omitted. Tubes require octal socket and may be mounted in any position. These tubes are equivalent in performance to type 6AQ5-A. Refer to type 6AQ5-A for average plate characteristic curves. Except for heater warm-up time, the 6V6-GTA is identical with type 6V6-GT.

HEATER VOLTAGE (AC/DC).....	6.3	volts
HEATER CURRENT.....	0.45	ampere
HEATER WARM-UP TIME (Average) 6V6-GTA.....	11	seconds

**DIRECT INTERELECTRODE CAPACITANCES (Approx.):**

	<b>6V6<sup>°</sup></b>	<b>6V6-GT</b>	
Grid No.1 to Plate.....	0.3	0.7	$\mu$ f
Grid No.1 to Cathode, Heater, Grid No.2, and Grid No.3....	10	9.0	$\mu$ f
Plate to Cathode, Heater, Grid No.2, and Grid No.3.....	11	7.5	$\mu$ f

° With shell connected to cathode.

**CLASS A<sub>1</sub> AMPLIFIER**

**Maximum Ratings, (Design-Maximum Values):**

PLATE VOLTAGE.....		350 <i>max</i>	volts
GRID-NO.2 (SCREEN-GRID) VOLTAGE.....		315 <i>max</i>	volts
PLATE DISSIPATION.....		14 <i>max</i>	watts
GRID-NO.2 INPUT.....		2.2 <i>max</i>	watts
PEAK HEATER-CATHODE VOLTAGE:.....	6V6	6V6-GT	
Heater negative with respect to cathode.....	100 <i>max</i>	200 <i>max</i>	volts
Heater positive with respect to cathode.....	100 <i>max</i>	200 <sup>■</sup> <i>max</i>	volts

**Typical Operation:**

Plate Voltage.....	180	250	315	volts
Grid-No.2 Voltage.....	180	250	225	volts
Grid-No.1 (Control-Grid) Voltage.....	-8.5	-12.5	-13	volts
Peak AF Grid-No.1 Voltage.....	8.5	12.5	13	volts
Zero-Signal Plate Current.....	29	45	34	ma
Maximum-Signal Plate Current.....	30	47	35	ma
Zero-Signal Grid-No.2 Current.....	3	4.5	2.2	ma
Maximum-Signal Grid-No.2 Current.....	4	7	6	ma
Plate Resistance (Approx.).....	50000	50000	80000	ohms
Transconductance.....	3700	4100	3750	amhos
Load Resistance.....	5500	5000	8500	ohms
Total Harmonic Distortion.....	8	8	12	per cent
Maximum-Signal Power Output.....	2	4.5	5.5	watts

**Characteristics (Triode Connection):<sup>▲</sup>**

Plate Voltage.....		250	volts
Grid-No.1 (Control-Grid) Voltage.....		-12.5	volts
Amplification Factor.....		9.8	
Plate Resistance (Approx.).....		1960	ohms
Transconductance.....		5000	amhos
Plate Current.....		49.5	ma
Grid-No.1 Voltage (Approx.) for plate current of 0.5 ma.....		-36	volts

<sup>▲</sup> Grid No.2 connected to plate.

**PUSH-PULL CLASS A<sub>1</sub> AMPLIFIER**

**Maximum Ratings: (Same as for class A<sub>1</sub> amplifier)**

**Typical Operation (Values are for two tubes):**

Plate Voltage.....	250	285	volts
Grid-No.2 Voltage.....	250	285	volts
Grid-No.1 (Control-Grid) Voltage.....	-15	-19	volts
Peak AF Grid-No.1-to-Grid-No.1 Voltage.....	30	38	volts
Zero-Signal Plate Current.....	70	70	ma
Maximum-Signal Plate Current.....	79	92	ma
Zero-Signal Grid-No.2 Current.....	5	4	ma
Maximum-Signal Grid-No.2 Current.....	13	13.5	ma
Effective Load Resistance (Plate-to-Plate).....	10000	8000	ohms
Total Harmonic Distortion.....	5	3.5	per cent
Maximum-Signal Power Output.....	10	14	watts

**Maximum Circuit Values:**

Grid-No.1-Circuit Resistance:			
For fixed-bias operation.....		0.1 <i>max</i>	megohm
For cathode-bias operation.....		0.5 <i>max</i>	megohm

**VERTICAL DEFLECTION AMPLIFIER (Triode Connection)<sup>▲</sup>**

*For operation in a 525-line, 30-frame system*

**Maximum Ratings, (Design-Maximum Values):**

DC PLATE VOLTAGE.....		350 <i>max</i>	volts
PEAK POSITIVE-PULSE PLATE VOLTAGE <sup>‡</sup> .....		1200 <i>max</i>	volts
PEAK NEGATIVE-PULSE GRID-NO.1 (CONTROL-GRID) VOLTAGE.....		275 <i>max</i>	volts
PEAK CATHODE CURRENT.....		115 <i>max</i>	ma
AVERAGE CATHODE CURRENT.....		40 <i>max</i>	ma
PLATE DISSIPATION.....		10 <i>max</i>	watts
PEAK HEATER-CATHODE VOLTAGE:.....	6V6	6V6-GT	
Heater negative with respect to cathode.....	100 <i>max</i>	200 <i>max</i>	volts
Heater positive with respect to cathode.....	100 <i>max</i>	200 <sup>■</sup> <i>max</i>	volts

**Maximum Circuit Value:**

Grid-No.1-Circuit Resistance:			
For cathode-bias operation.....		2.2 <i>max</i>	megohms

<sup>▲</sup> Grid No.2 connected to plate.

<sup>‡</sup> The duration of the voltage pulse must not exceed 15 per cent of one vertical scanning cycle. In a 525-line, 30-frame system, 15 per cent of one vertical scanning cycle is 2.5 milliseconds.

<sup>■</sup> The dc component must not exceed 100 volts.

**TWIN DIODE—LOW-MU TRIODE**

Glass octal type used as combined detector, amplifier, and avc tube. Outline 39, OUTLINES SECTION. Except for interelectrode capacitances, this type is identical electrically with type 85. Heater volts (ac/dc), 6.3; amperes, 0.3. For diode operation curves, refer to type 6AV6. Type 6V7-G is a DISCONTINUED type listed for reference only.

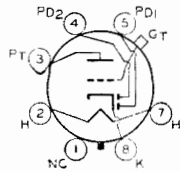

**6V7-G**

**HALF-WAVE VACUUM RECTIFIER**

Glass octal type used as damper tube in television receivers. Outline 22, OUTLINES SECTION. This type may be supplied with pin No.1 omitted. Tube requires octal socket and may

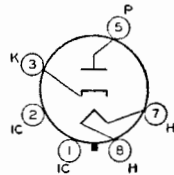

**6W4-GT**

be mounted in any position. Socket terminals 1, 2, 4, and 6 should not be used as tie points. It is especially important that this tube, like other power-handling tubes, be adequately ventilated. Power-rectifier operation of this type is not recommended. For curve of average plate characteristics, see page 67.

HEATER VOLTAGE (AC).....	6.3	volts
HEATER CURRENT.....	1.2	amperes
DIRECT INTERELECTRODE CAPACITANCES (Approx.):		
Plate to Cathode and Heater.....	6	$\mu$ f
Cathode to Plate and Heater.....	13	$\mu$ f
Heater to Cathode.....	7	$\mu$ f

**DAMPER**

*For operation in a 525-line, 30-frame system*

<b>Maximum Ratings:</b>		
PEAK INVERSE PLATE VOLTAGE (Absolute Maximum)*.....	3850 max	volts
PEAK PLATE CURRENT.....	750 max	ma
DC PLATE CURRENT.....	125 max	ma
PLATE DISSIPATION.....	3.5 max	watts

<b>PEAK HEATER-CATHODE VOLTAGE:</b>		
Heater negative with respect to cathode (Absolute Maximum)*.....	2300 max	volts
Heater positive with respect to cathode.....	300 max	volts

\* The duration of the voltage pulse must not exceed 15 per cent of one horizontal scanning cycle. In a 525-line, 30-frame system, 15 per cent of one horizontal scanning cycle is 10 microseconds.

- The dc component must not exceed 500 volts.
- ▲ The dc component must not exceed 100 volts.

**BEAM POWER TUBE**

Glass octal type used in the audio output stage of radio and television receivers. Triode-connected, it is used as a vertical deflection amplifier in television receivers. Outline 22, OUT-

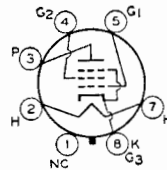

**6W6-GT**

LINE SECTION. This type may be supplied with pin No.1 omitted. Tube requires octal socket and may be mounted in any position.

HEATER VOLTAGE (AC/DC).....	6.3	volts
HEATER CURRENT.....	1.2	amperes
DIRECT INTERELECTRODE CAPACITANCES (Approx.):		
Grid No.1 to Plate.....	0.8	$\mu$ f
Grid No.1 to Cathode, Heater, Grid No.2, and Grid No.3.....	15	$\mu$ f
Plate to Cathode, Heater, Grid No.2, and Grid No.3.....	9	$\mu$ f

**CLASS A<sub>1</sub> AMPLIFIER**

<b>Maximum Ratings:</b>		
PLATE VOLTAGE.....	300 max	volts
GRID-NO.2 (SCREEN-GRID) VOLTAGE.....	150 max	volts
PLATE DISSIPATION.....	10 max	watts
GRID-NO.2 INPUT.....	1.25 max	watts

<b>PEAK HEATER-CATHODE VOLTAGE:</b>		
Heater negative with respect to cathode.....	200 max	volts
Heater positive with respect to cathode.....	200 max	volts

- The dc component must not exceed 100 volts.

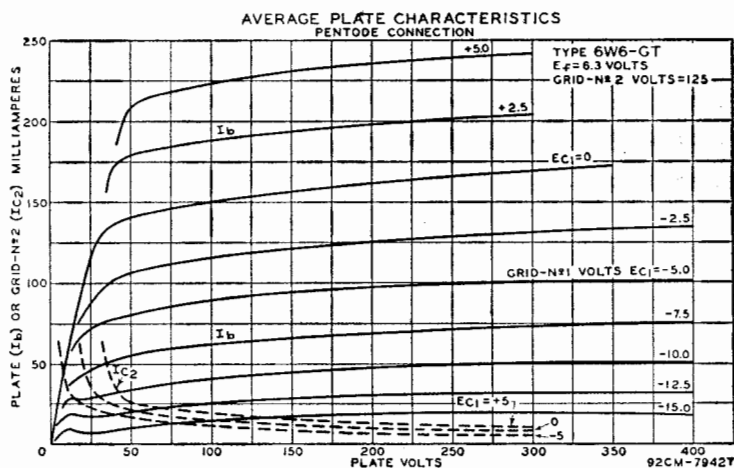

**Typical Operation:**

Plate Supply Voltage	110	200	volts
Grid-No.2 Supply Voltage	110	125	volts
Grid-No.1 (Control-Grid) Voltage	-7.5	—	volts
Cathode-Bias Resistor	—	180	ohms
Peak AF Grid-No.1 Voltage	7.5	8.5	volts
Zero-Signal Plate Current	49	46	ma
Maximum-Signal Plate Current	50	47	ma
Zero-Signal Grid-No.2 Current	4	2.2	ma
Maximum-Signal Grid-No.2 Current	10	8.5	ma
Plate Resistance (Approx.)	13000	28000	ohms
Transconductance	8000	8000	$\mu$ mhos
Load Resistance	2000	4000	ohms
Total Harmonic Distortion (Approx.)	10	10	per cent
Maximum-Signal Power Output	2.1	3.8	watts

**Characteristics (Triode Connection)\*:**

Plate Voltage	225	volts
Grid-No.1 Voltage	-30	volts
Amplification Factor	6.2	
Plate Resistance (Approx.)	1600	ohms
Transconductance	3800	$\mu$ mhos
Plate Current	22	ma
Grid No.1 Voltage (Approx.) for plate current of 0.5 ma	-42	volts

\*Grid No. 2 connected to plate.

**Maximum Circuit Values:**

Grid-No.1 Circuit Resistance:		
For fixed-bias operation	0.1 max	megohm
For cathode-bias operation	0.5 max	megohm

**VERTICAL DEFLECTION AMPLIFIER**

For operation in a 525-line, 30-frame system

**Maximum Ratings:**

	Triode Connection*		
DC PLATE VOLTAGE	300 max	300 max	volts
PEAK POSITIVE-PULSE PLATE VOLTAGE† (Absolute Maximum)	1200 <sup>o</sup> max	1500 <sup>o</sup> max	volts
DC GRID NO.2 (SCREEN-GRID) VOLTAGE	—	150 max	volts
PEAK NEGATIVE-PULSE GRID-NO.1 VOLTAGE	-250 max	250 max	volts
PEAK CATHODE CURRENT	180 max	180 max	ma
AVERAGE CATHODE CURRENT	60 max	60 max	ma
PLATE DISSIPATION	7.5 max	7 max	watts
PEAK HEATER-CATHODE VOLTAGE:			
Heater negative with respect to cathode	200 max	200 max	volts
Heater positive with respect to cathode	200 <sup>o</sup> max	200 <sup>o</sup> max	volts

**Maximum Circuit Value:**

Grid-No.1-Circuit Resistance:		
For cathode-bias operation	2.2 max	2.2 max megohms

\* Grid No.2 connected to plate.

† The duration of the voltage pulse must not exceed 15 per cent of one vertical scanning cycle. In a 525-line, 30-frame system, 15 per cent of one vertical scanning cycle is 2.5 milliseconds.

<sup>o</sup> Under no circumstances should this absolute value be exceeded.

■ The dc component must not exceed 100 volts.

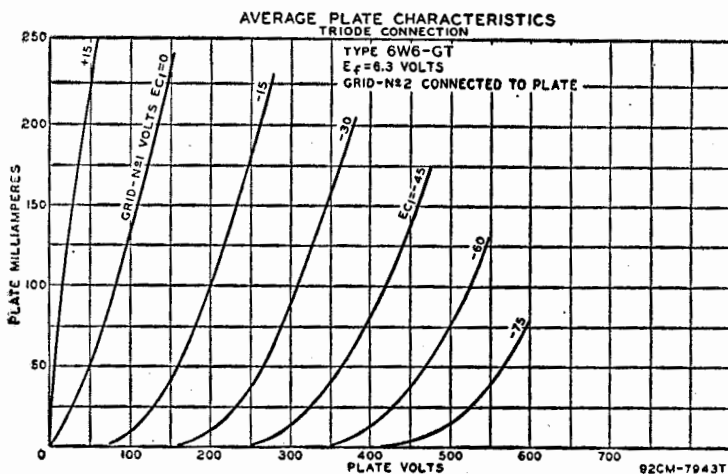

### 6W7-G

#### SHARP-CUTOFF PENTODE

Glass octal type used as biased detector or high-gain amplifier in radio receivers. Outline 39, OUTLINES SECTION. Tube requires octal socket. Heater volts (ac/dc), 6.3; amperes, 0.15. Maximum ratings: plate volts, 300 *max*; grid-No.2 (screen-grid) volts, 100 *max*; grid-No.2 supply volts, 300 *max*; grid-No.1 (control-grid) volts, 0 *max*; plate dissipation, 0.5 *watt*; grid-No.2 input, 0.1 *max watt*. Within its maximum ratings, this type is identical electrically with type 6J7. Type 6W7-G is a DISCONTINUED type listed for reference only.

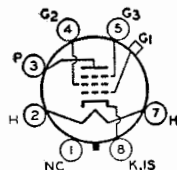

### 6X4

#### FULL-WAVE VACUUM RECTIFIER

Miniature type used in power supply of automobile and ac-operated radio receivers. Equivalent in performance to larger types 6X5 and 6X5-GT. Type 6X4 requires miniature seven-contact socket and may be mounted in any position. Outline 13, OUTLINES SECTION. It is especially important that this tube, like other power-handling tubes, be adequately ventilated. For discussion of Rating Chart and Operation Characteristics, refer to INTERPRETATION OF TUBE DATA.

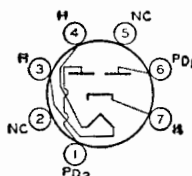

HEATER VOLTAGE (AC/DC).....	6.3 <sup>a</sup>	volts
HEATER CURRENT.....	0.6	ampere

#### FULL-WAVE RECTIFIER

Maximum Ratings, (Design-Maximum Values):

PEAK INVERSE PLATE VOLTAGE.....	1250 <i>max</i>	volts
STEADY-STATE PEAK PLATE CURRENT (Per Plate).....	245 <i>max</i>	ma
AC PLATE SUPPLY VOLTAGE (Per Plate, rms).....	See Rating Chart	
DC OUTPUT VOLTAGE (At filter input)†.....	350 <i>max</i>	volts
DC OUTPUT CURRENT (Each plate)†.....	45 <i>max</i>	ma
HOP-SWITCHING TRANSIENT PLATE CURRENT.....	#	
PEAK HEATER-CATHODE VOLTAGE:		
Heater negative with respect to cathode.....	450 <i>max</i>	volts
Heater positive with respect to cathode.....	200 <i>max</i>	volts

## RATING CHART

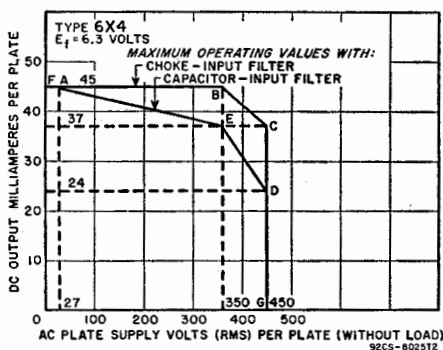

### Typical Operation:

	Sine-Wave Operation Capacitor	Choke	Vibrator Operation Capacitor	
AC Plate Supply Voltage (Each plate, rms).....	325	400	-	volts
Filter Input Capacitor.....	10	-	10	μf
Effective Plate Supply Impedance (Each plate).....	525	-	-	ohms
Filter Input Choke.....	-	10	-	henries
DC Output Current.....	70	70	70	ma
DC Output Voltage at Input to Filter (Approx.).....	310	340	240	volts

▲ When the heater is operated from a 3-cell (nominal-6-volt) storage-battery source, the permissible heater-voltage range is from 5 to 8 volts.

† This rating applies when the 6X4 is used in vibrator operation with a minimum duty cycle of 75 per cent.

≡ If hot-switching is regularly required in operation, the use of choke-input circuits is recommended. Such circuits limit the hot-switching current to a value no higher than that of the peak plate current. When capacitor-input circuits are used, a maximum peak current value per plate of 1.1 amperes during the initial cycles of the hot-switching transient should not be exceeded.

■ The dc component must not exceed 100 volts.

• AC plate supply voltage is measured without load.

### OPERATION CHARACTERISTICS

FULL-WAVE CIRCUIT, CHOKE INPUT TO FILTER

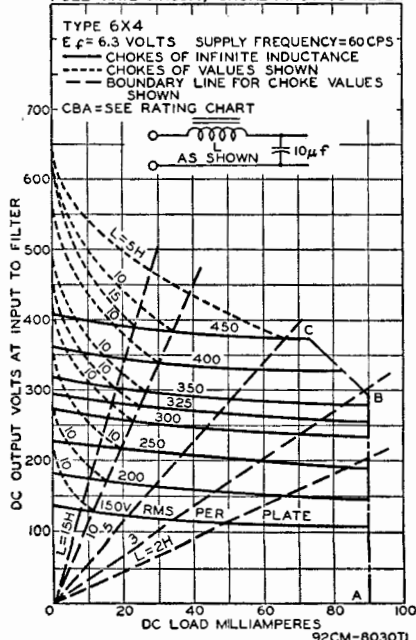

### OPERATION CHARACTERISTICS

FULL-WAVE CIRCUIT, CAPACITOR INPUT TO FILTER

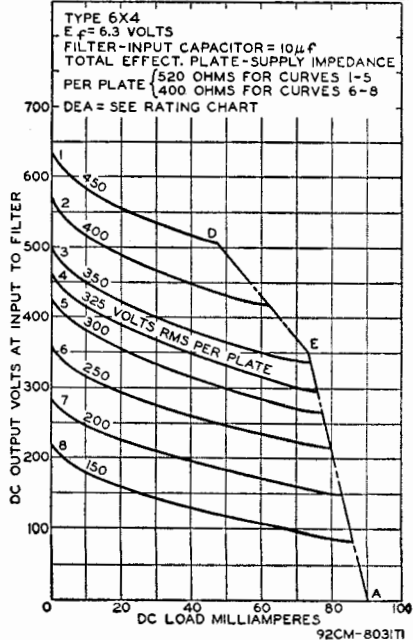

**6X5**  
**6X5-GT**

**FULL-WAVE VACUUM RECTIFIER**

Metal type 6X5 and glass octal type 6X5-GT are used in power supply of automobile and ac-operated receivers. Outlines 6 and 22, respectively, OUTLINES SECTION. Type 6X5-

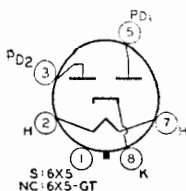

GT may be supplied with pin No.1 omitted. Both types require octal socket. Type 6X5 should be mounted in vertical position, but horizontal operation is permissible if pins 3 and 5 are in horizontal plane. Type 6X5-GT may be operated in any position. For maximum ratings, and typical operation, refer to type 6X4. Type 6X5 is a DISCONTINUED type listed for reference only.

**MEDIUM-MU TRIODE—  
SHARP-CUTOFF PENTODE**

**6X8**

Miniature type used as combined oscillator and mixer tube in television receivers utilizing an intermediate frequency in the order of 40 megacycles per second. In such service, the 6X8



gives performance comparable to that obtainable with a 6AG5 mixer and an oscillator consisting of one unit of a type 6J6. When used in an AM/FM receiver, the triode unit is used as an oscillator for both sections. In the AM section, the pentode unit is used as a high-gain pentode mixer; in the FM section, the pentode unit is used either as a pentode mixer or as a triode-connected mixer depending on signal-to-noise considerations. Outline 12, OUTLINES SECTION. Tube requires miniature nine-contact socket and may be mounted in any position.

HEATER VOLTAGE.....	6.3	volts
HEATER CURRENT.....	0.45	ampere
DIRECT INTERELECTRODE CAPACITANCES:		
TRIODE UNIT:	<i>Without External Shield</i>	<i>With External Shield*</i>
Grid to Plate.....	1.5	μf
Grid to Cathode and Heater.....	2	μf
Plate to Cathode and Heater.....	0.5	μf
PENTODE UNIT:		
Grid No.1 to Plate.....	0.09 max	0.06 max μf
Grid No.1 to Cathode, Heater, Grid No.2, and Grid No.3..	4.6	4.8 μf
Plate to Cathode, Heater, Grid No.2, and Grid No.3....	0.9	1.6 μf
Pentode Grid No.1 to Triode Plate.....	0.05 max	0.04 max μf
Pentode Plate to Triode Plate.....	0.05 max	0.008 max μf
Heater to Cathode.....	6.5	6.5* μf

- \* With external shield connected to cathode except as noted.
- With external shield connected to pentode plate.

**CLASS A<sub>1</sub> AMPLIFIER**

Maximum Ratings, (Design-Maximum Values):	Triode Unit	Pentode Unit	
PLATE VOLTAGE.....	275 max	275 max	volts
GRID NO.3 (SUPPRESSOR GRID).....	—	Connect to cathode at socket	
GRID NO.2 (SCREEN-GRID) SUPPLY VOLTAGE.....	—	275 max	volts
GRID-NO.2 VOLTAGE.....	—	See curve page 66	
GRID-NO.1 (CONTROL-GRID) VOLTAGE, Positive-bias value.....	0 max	0 max	volts
PLATE DISSIPATION.....	1.7 max	2.3 max	watts
GRID-NO.2 INPUT:			
For grid-No.2 voltages up to 137.5 volts.....	—	0.45 max	watt
For grid-No.2 voltages between 137.5 and 275 volts.....	—	See curve page 66	
PEAK HEATER-CATHODE VOLTAGE:			
Heater negative with respect to cathode.....	200 max	200 max	volts
Heater positive with respect to cathode.....	200*max	200*max	volts



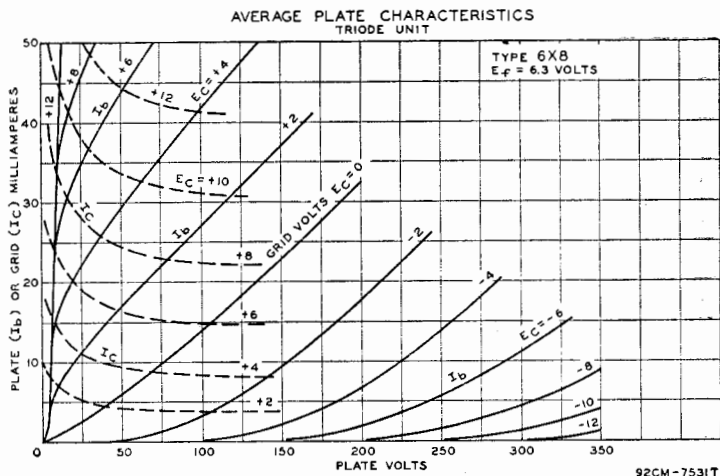

**Characteristics:**

Plate Voltage	125	Triode Unit	Pentode Unit	125	volts
Grid No. 3	-		Connected to cathode at sockets	-	
Grid-No. 2 Voltage	-		125	125	volt
Grid-No. 1 Voltage	-1		-1	-1	volt
Amplification Factor	40		-	-	
Plate Resistance (Approx.)	6000		300000	300000	ohms
Transconductance	6500		5500	5500	$\mu$ mbos
Plate Current	12		9	9	ma
Grid-No. 2 Current	-		2.2	2.2	ma
Grid-No. 1 Voltage (Approx.) for plate current of 20 $\mu$ a	-7		-6.5	-6.5	volts

■The dc component must not exceed 100 volts.

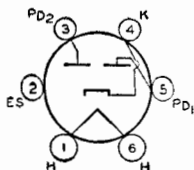
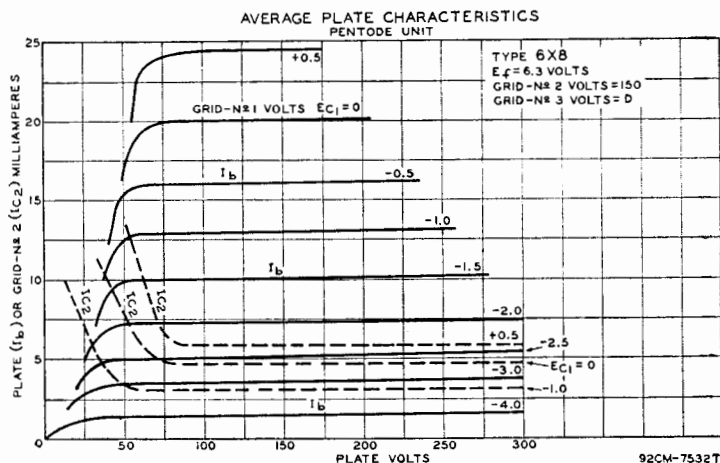

**FULL-WAVE VACUUM RECTIFIER**

Glass type used in power supply of radio receivers. Outline 34 or 35, OUTLINES SECTION. Heater volts (ac/dc), 6.3; amperes, 0.8. The maximum ac plate voltage per plate is 350 volts (rms), and the dc output current is 50 ma. This is a DISCONTINUED type listed for reference only.

6Y5

# 6Y6-G 6Y6-GA

## BEAM POWER TUBE

Glass octal types used as output amplifier in radio receivers. Also used in rf-operated, high-voltage power supplies in television equipment. Except for envelope size and direct interelectrode capacitances, type 6Y6-G and type 6Y6-GA are identical. Outlines 42 and 33, respectively, OUTLINES SECTION. Tubes require octal socket and may be mounted in any position.

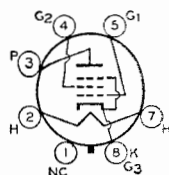

HEATER VOLTAGE (AC/DC).....	6.3	volts
HEATER CURRENT.....	1.25	amperes
DIRECT INTERELECTRODE CAPACITANCES (Approx.):	<i>6Y6-G</i>	<i>6Y6-GA</i>
Grid No.1 to Plate.....	0.7	μf
Grid No.1 to Cathode, Heater, Grid No.2, and Grid No.3.....	15	μf
Plate to Cathode, Heater, Grid No.2, and Grid No.3.....	11	μf

### Maximum Ratings:

### CLASS A AMPLIFIER

PLATE VOLTAGE.....	200 <i>max</i>	volts
GRID-NO.2 (SCREEN-GRID) SUPPLY VOLTAGE.....	200 <i>max</i>	volts
GRID-NO.2 VOLTAGE.....	See curve page 66	
GRID-NO.2 INPUT:		
For grid-No.2 voltages up to 100 volts.....	1.75 <i>max</i>	watts
For grid-No.2 voltages between 100 and 200 volts.....	See curve page 66	
PLATE DISSIPATION.....	12.5 <i>max</i>	watts
PEAK HEATER-CATHODE VOLTAGE:		
Heater negative with respect to cathode.....	180 <i>max</i>	volts
Heater positive with respect to cathode.....	180 <i>max</i>	volts

### Typical Operation:

Plate Voltage.....	135	200	volts
Grid-No.2 Voltage.....	135	135	volts
Grid-No.1 (Control-Grid) Voltage.....	-13.5	-14	volts
Peak AF Grid-No.1 Voltage.....	13.5	14	volts
Zero-Signal Plate Current.....	58	61	ma
Maximum-Signal Plate Current.....	60	66	ma
Zero-Signal Grid-No.2 Current.....	3.5	2.2	ma
Maximum-Signal Grid-No.2 Current.....	11.5	9	ma
Plate Resistance (Approx.).....	9300	18300	ohms
Transconductance.....	7000	7100	μmhos
Load Resistance.....	2000	2600	ohms
Total Harmonic Distortion.....	10	10	per cent
Maximum-Signal Power Output.....	3.6	6	watts

### Maximum Circuit Values:

Grid-No.1-Circuit Resistance:		
For fixed-bias operation.....	0.1 <i>max</i>	megohm
For cathode-bias operation.....	0.5 <i>max</i>	megohm

## HIGH-MU TWIN POWER TRIODE

Glass octal type used as class B amplifier in output stage of radio receivers. Outline 36, OUTLINES SECTION. For electrical characteristics, refer to type 79. Heater volts (ac/dc), 6.3; amperes, 0.6. This is a DISCONTINUED type listed for reference only.

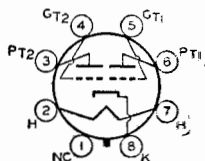

# 6Y7-G

# 6Z4

Refer to type 84/6Z4

**FULL-WAVE VACUUM RECTIFIER**

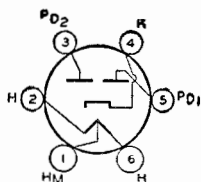

Glass type used in power supply of radio receivers. Outline 35, OUTLINES SECTION. Heater volts (ac/dc), 12.6 in series heater arrangement and 6.3 in parallel arrangement; amperes, 0.4 (series), 0.8 (parallel). Maximum ac plate voltage per plate is 230 volts, and maximum dc output current is 60 ma. This is a DISCONTINUED type listed for reference only.

**6Z5**

**HIGH-MU TWIN POWER TRIODE**

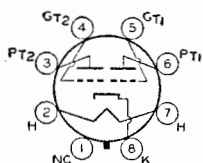

Glass octal type used as class B amplifier in output stage of radio receivers. Outline 36, OUTLINES SECTION. Tube requires octal socket. Heater volts (ac/dc), 6.3; amperes, 0.3. Typical operation and maximum ratings as class B power amplifier: plate volts, 180 max; grid volts, 0; peak plate ma. per plate, 60 max; average plate dissipation, 8 max watts; zero-

**6Z7-G**

signal plate ma. per plate, 4.2; plate-to-plate load resistance, 12000 ohms; output watts, 4.2 with average input of 320 milliwatts applied between grids. This is a DISCONTINUED type listed for reference only.

**FULL-WAVE VACUUM RECTIFIER**

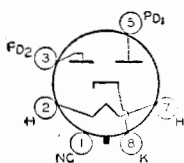

Glass octal type used in power supply of radio equipment where economy of power is important. Outline 36, OUTLINES SECTION. Tube requires octal socket and may be mounted in any position. Heater volts (ac/dc), 6.3; amperes, 0.3. Maximum ratings: peak inverse plate volts, 1250; peak plate ma. per plate, 120; dc output ma., 40; peak heater-cathode volts, 450. This is a DISCONTINUED type listed for reference only.

**6ZY5-G**

**MEDIUM-MU TRIODE**

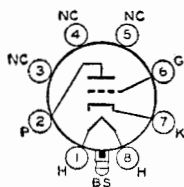

Glass lock-in type used as detector, amplifier, or oscillator in radio equipment. Outline 15, OUTLINES SECTION. Tube requires lock-in socket. Heater volts (ac/dc), 6.3; amperes, 0.3. Maximum ratings, typical operating conditions, and curves for type 7A4 are the same as for metal type 6J5. Type 7A4 is used principally for renewal purposes.

**7A4**

**BEAM POWER TUBE**

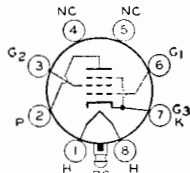

Glass lock-in type used as output amplifier in radio receivers in which the plate voltage available for the output stage is relatively low. Outline 20, OUTLINES SECTION. Tube requires lock-in socket. Heater volts (ac/dc), 6.3; amperes, 0.75. Typical operation and maximum ratings as class A<sub>1</sub> amplifier: plate volts, 110 (125 max); grid-No.2 volts, 110 (125 max);

**7A5**

grid-No.1 volts, -7.5; peak af grid-No.1 volts, 7.5; plate resistance (approx.), 16,000 ohms; transconductance 5800  $\mu$ mhos; plate ma., zero-signal, 40 (maximum-signal, 41); grid-No.2 ma., zero-signal, 3 (maximum-signal, 7); load resistance, 2500 ohms; total harmonic distortion, 10 per cent; maximum-signal power output, 1.5 watts; peak heater-cathode volts, 90 max. This type is used principally for renewal purposes.

**TWIN DIODE**

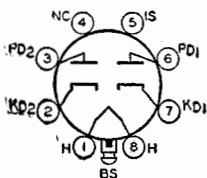

Glass lock-in type used as detector, low-voltage rectifier, or avc tube. Outline 15, OUTLINES SECTION. Tube requires lock-in socket. Heater volts (ac/dc), 6.3; amperes, 0.15. Maximum ratings as rectifier: ac plate volts per plate (rms), 150; dc output ma. per plate, 8; peak ma. per plate, 45; peak heater-cathode volts, 330. The application of this type is similar to that of metal type 6H6. Type 7A6 is used principally for renewal purposes.

**7A6**

## 7A7

### REMOTE-CUTOFF PENTODE

Glass lock-in type used as rf or if amplifier in radio receivers. Outline 15, OUTLINES SECTION. Tube requires lock-in socket. Heater volts (ac/dc), 6.3; amperes, 0.3. For maximum ratings, typical operation, and curves, refer to metal type 6SK7. Type 7A7 is used principally for renewal purposes.

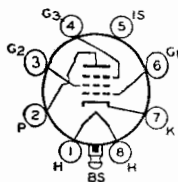

## 7A8

### OCTODE CONVERTER

Glass lock-in type used as converter in superheterodyne circuits. Outline 15, OUTLINES SECTION. Tube requires lock-in socket. Heater volts (ac/dc), 6.3; amperes, 0.15. Typical operation and maximum ratings as frequency converter: plate volts, 250 (300 *max*); grids-No.3-and-No.5 volts, 100 *max*; grid-No.2 supply volts, 250 applied through a 20000-ohm

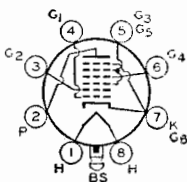

dropping resistor (300 *max*); grid-No.2 volts, 200 *max*; plate dissipation, 1 *max* watt; grids-No.3-and-No.5 input, 0.3 *max* watt; grid-No.2 input, 0.75 *max* watt; grid-No.4 volts, -3 (0 *max*); grid-No.1 resistor, 50000 ohms; plate *ma.*, 3; grids-No.3-and-No.5 *ma.*, 3.2; grid-No.2 *ma.*, 4.2; grid-No.1 *ma.*, 0.4; plate resistance (approx.), 0.7 megohm; conversion transconductance, 550  $\mu$ hos; peak heater-cathode volts, 90 *max.* This type is used principally for renewal purposes.

### POWER PENTODE

Lock-in type used in output stage of video amplifier of television receivers. Outline 20, OUTLINES SECTION. Tube requires lock-in socket. Heater volts (ac/dc), 6.3; amperes, 0.6. Characteristics and maximum ratings as Class A<sub>1</sub> amplifier: plate supply volts, 300 *max*; grid-No.2 supply volts, 150 (300 *max*); grid-No.2 volts, see curve page 69; grid-No.1 volts, posi-

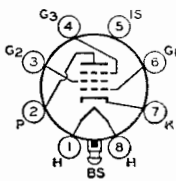

tive-bias value, 0 *max*; grid-No.2 input, for grid-No.2 voltages up to 150 volts, 1.2 *max* watts (for grid-No.2 voltages between 150 and 300 volts, see curve page 66); plate dissipation, 10 *max* watts; cathode-bias resistor, 68 ohms; plate *ma.*, 28; grid-No.2 *ma.*, 7; plate resistance (approx.), 0.3 megohm; transconductance, 9500  $\mu$ hos; peak heater-cathode volts, 90 *max.* Type 7AD7 is a DISCONTINUED type listed for reference only.

## 7AD7

### MEDIUM-MU TWIN TRIODE

Glass lock-in type used as voltage amplifier or phase inverter in radio equipment. Outline 15, OUTLINES SECTION. Tube requires lock-in socket. Heater volts (ac/dc), 6.3; amperes, 0.3. Characteristics and maximum ratings as Class A<sub>1</sub> amplifier (each unit): plate supply volts, 250 (300 *max*); grid volts, positive-bias value, 0 *max*; cathode-bias resistor, 1100 ohms; plate *ma.*, 9; transconductance, 2100  $\mu$ hos; amplification factor, 16; plate resistance (ap-

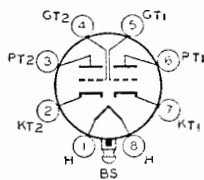

prox.), 7600 ohms, peak heater-cathode volts, 90 *max.* This type is used principally for renewal purposes.

## 7AF7

### SHARP-CUTOFF PENTODE

Glass lock-in type used as rf amplifier in ac/dc receivers or in mobile equipment where low heater current drain is important. Outline 15, OUTLINES SECTION. Tube requires lock-in socket. Heater volts (ac/dc), 6.3; amperes, 0.15. Characteristics and maximum ratings as class A<sub>1</sub> amplifier: plate and grid-No.2 supply volts, 250 (300 *max*); grid-No.1 volts, positive-bias value, 0 *max*; plate dissipation, 2

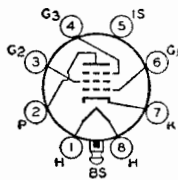

*max* watts; grid-No.2 input, 0.75 *max* watt; grid No.3 and internal shield connected to cathode at socket; plate resistance (approx.), greater than 1 megohm; transconductance, 4200  $\mu$ hos; cathode-bias resistor, 250 ohms; plate *ma.*, 6; grid-No.2 *ma.*, 2; peak heater-cathode volts, 90 *max.* This type is used principally for renewal purposes.

## 7AG7

### SHARP-CUTOFF PENTODE

7AH7

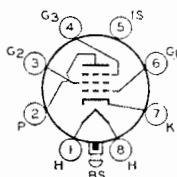

Glass lock-in type used as rf amplifier in high-frequency and wide-band applications. Outline 15, OUTLINES SECTION. Tube requires lock-in socket. Heater volts (ac/dc), 6.3; amperes, 0.15. Characteristics and maximum ratings as class A<sub>1</sub> amplifier: plate and grid-No. 2 supply volts, 250 (300 *max*); grid-No. 2 volts, 250 (see curve page 66); grid-No. 1 volts, positive-bias value, 0 *max*; plate dissipation, 2 *max*

watts; grid-No. 2 input, for grid-No. 2 voltages up to 150 volts, 0.7 *max* watt (for grid-No. 2 voltages from 150 to 300 volts, see curve page 66); cathode-bias resistor, 250 ohms; grid No. 3 and internal shield connected to cathode at socket; plate resistance (approx.), 1 megohm; transconductance, 3300  $\mu$ mhos; plate ma., 6.8; grid-No. 2 ma., 1.9; peak heater-cathode volts, 90 *max*. Type 7AH7 is used principally for renewal purposes.

### MEDIUM-MU TWIN TRIODE

7AU7

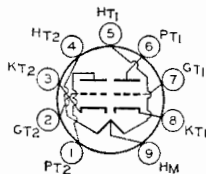

Miniature type used as combined vertical deflection amplifier and vertical deflection oscillator in television receivers. This type has a controlled heater warm-up time for use in receivers employing series-connected heater strings. Each unit may also be used as a

horizontal deflection oscillator, or in audio mixer, phase inverter, multivibrator, sync separator and amplifier, and resistance-coupled amplifier circuits in radio equipment. Outline 12, OUTLINES SECTION. Heater volts (ac/dc), 7 in series arrangement, 3.5 in parallel arrangement; amperes, 0.3 (series), 0.6 (parallel); warm-up time (average) in parallel arrangement, 11 seconds. Except for heater rating, this type is identical with miniature type 12AU7-A.

### HIGH-MU TRIODE

7B4

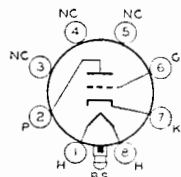

Glass lock-in type used in resistance-coupled amplifier circuits. Outline 15, OUTLINES SECTION. Tube requires lock-in socket. Heater volts (ac/dc), 6.3; amperes, 0.3. Except for interelectrode capacitances, this type has the same maximum ratings and characteristics as metal types 6F5 and 6SF5. Type 7B4 is used principally for renewal purposes.

### POWER PENTODE

7B5

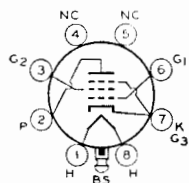

Glass lock-in type used in output stage of radio receivers. Outline 20, OUTLINES SECTION. Tube requires lock-in socket. Heater volts (ac/dc), 6.3; amperes, 0.4. Except for interelectrode capacitances, this type is the same electrically as glass-octal type 6K6-GT. Type 7B5 is used principally for renewal purposes.

### TWIN DIODE—HIGH-MU TRIODE

7B6

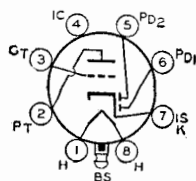

Glass lock-in type used as combined detector, amplifier, and avc tube. Outline 15, OUTLINES SECTION. Tube requires lock-in socket. Heater volts (ac/dc), 6.3; amperes, 0.3. Except for interelectrode capacitances, this type is the same electrically as metal type 6SQ7. Type 7B6 is used principally for renewal purposes.

**REMOTE-CUTOFF PENTODE**

**7B7**

Glass lock-in type used as rf or if amplifier in radio receivers employing avc. Outline 15, OUTLINES SECTION. Tube requires lock-in socket. Heater volts (ac/dc), 6.3; amperes, 0.15. Characteristics and maximum ratings as class A<sub>1</sub> amplifier: plate volts, 250 (300 *max*); grid-No.2 volts, 100 *max*; grid-No.1 volts, -3 (positive-bias value, 0 *max*); grid No.3 and internal

shield connected to cathode at socket; plate ma., 8.5; grid-No.2 ma., 1.7; grid-No.2 input, 0.25 *max* watt; plate dissipation, 2.25 *max* watts; plate resistance (approx.) 0.75 megohm; transconductance, 1750  $\mu$ hos; peak heater-cathode volts, 90 *max*. Type 7B7 is used principally for renewal purposes.

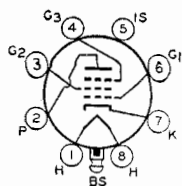

**PENTAGRID CONVERTER**

**7B8**

Glass lock-in type used as frequency converter in superheterodyne circuits. Outline 15, OUTLINES SECTION. Tube requires lock-in socket. Heater volts (ac/dc), 6.3; amperes, 0.3. Except for interelectrode capacitances, this type is the same electrically as metal type 6A8. Type 7B8 is used principally for renewal purposes.

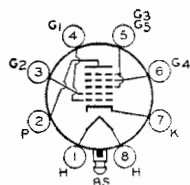

**BEAM POWER TUBE**

**7C5**

Glass lock-in type used as output amplifier in radio receivers. Outline 20, OUTLINES SECTION. Tube requires lock-in socket. Heater volts (ac/dc), 6.3; amperes, 0.45. Refer to metal type 6V6 for maximum ratings and typical operation as class A<sub>1</sub> amplifier and as push-pull class A<sub>1</sub> amplifier. Type 7C5 is used principally for renewal purposes.

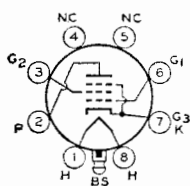

**TWIN DIODE—HIGH-MU TRIODE**

**7C6**

Glass lock-in type used as combined detector, amplifier, and avc tube. Outline 15, OUTLINES SECTION. Tube requires lock-in socket. Heater volts (ac/dc), 6.3; amperes, 0.15. Characteristics and maximum ratings of triode unit as class A<sub>1</sub> amplifier: plate volts, 250 (300 *max*); grid volts, -1 (positive-bias value, 0 *max*); plate ma., 1.3; amplification factor, 100; plate

resistance (approx.), 0.1 megohm; transconductance, 1000  $\mu$ hos; peak heater-cathode volts, 90 *max*. For diode operation curves and triode application, refer to miniature type 6AV6. Type 7C6 is used principally for renewal purposes.

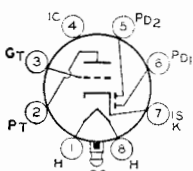

**SHARP-CUTOFF PENTODE**

**7C7**

Glass lock-in type used as biased detector or rf amplifier. Outline 15, OUTLINES SECTION. Tube requires lock-in socket. Heater volts (ac/dc), 6.3; amperes, 0.15. Characteristics and maximum ratings as class A<sub>1</sub> amplifier: plate volts, 250 (300 *max*); grid-No.2 supply volts, 300 *max*; grid-No.2 volts, 100 *max*; grid-No.1 volts, -3 (positive-bias value, 0 *max*); grid

No.3 and internal shield connected to cathode at socket; grid-No.2 input, 0.1 *max* watt; plate dissipation, 1 *max* watt; plate resistance (approx.), 2 megohms; plate ma., 2; grid-No.2 ma., 0.5; transconductance, 1300  $\mu$ hos; peak heater-cathode volts, 90 *max*. This type is used principally for renewal purposes.

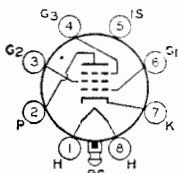

**TWIN DIODE—MEDIUM-MU TRIODE**

**7E6**

Glass lock-in type used as combined detector, amplifier, and avc tube. Outline 15, OUTLINES SECTION. Tube requires lock-in socket. Heater volts (ac/dc), 6.3; amperes, 0.3. For maximum ratings, typical operation, and curves, refer to miniature type 6BF6. Type 7E6 is a DISCONTINUED type listed for reference only.

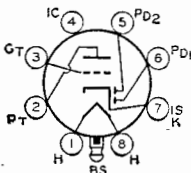

**TWIN DIODE—REMOTE-CUTOFF  
PENTODE**

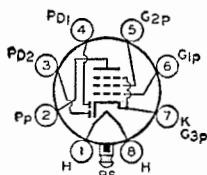

**7E7**

Glass lock-in type used as combined detector, amplifier, and AVC tube. Outline 15, OUTLINES SECTION. Tube requires lock-in socket. Heater volts (ac/dc), 6.3; amperes, 0.3. Characteristics and maximum ratings of pentode unit as class A<sub>1</sub> amplifier: plate volts, 250 (300 max); grid-No.2 supply volts, 300 max; grid-No.2 volts, 100 max; grid-No.1 volts, -3 (positive-bias value, 0 max); plate dissipation, 2 max watts; grid-No.2 input, 0.3 max watt; cathode-bias resistor, 330 ohms; plate resistance (approx.), 0.7 megohm; transconductance, 1300 μmhos; plate ma., 7.5; grid-No.2 ma., 1.6; peak heater-cathode volts, 90 max. For diode curves, refer to type 6AV6. Type 7E7 is used principally for renewal purposes.

**BEAM POWER TUBE**

**7EY6**

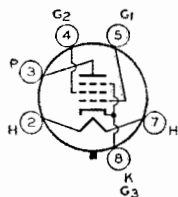

Glass octal type used as vertical deflection amplifier in television receivers employing series-connected heater strings. Outline 26, OUTLINES SECTION. Tube requires octal socket and may be operated in any position. Heater volts (ac/dc), 7.2; amperes, 0.6; warm-up time (average), 11 seconds. Except for heater ratings, this type is identical with glass octal type 6EY6.

**HIGH-MU TWIN TRIODE**

**7F7**

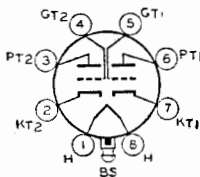

Glass lock-in type used as phase inverter or resistance-coupled amplifier. Outline 15, OUTLINES SECTION. Tube requires lock-in socket. Heater volts (ac/dc), 6.3; amperes, 0.3. For maximum ratings, typical operation as class A<sub>1</sub> amplifier, and curves, refer to glass-octal type 6SL7-GT. Type 7F7 is used principally for renewal purposes.

**MEDIUM-MU TWIN TRIODE**

**7F8**

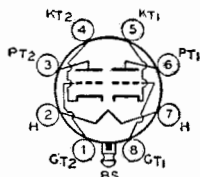

Glass lock-in type used as amplifier or oscillator in radio equipment. Outline 15, OUTLINES SECTION, except over-all length is 2-9/32 max inches and seated length is 1-3/4 inches. Tube requires lock-in socket. Heater volts (ac/dc), 6.3; amperes, 0.3. Characteristics and maximum ratings as class A<sub>1</sub> amplifier (each unit): plate supply volts, 250 (300 max); grid volts, positive-bias value, 0 max; plate dissipation, 3.5 max watts (both units, 3.5 max watts); cathode-bias resistor, 500 ohms; plate ma., 6.0; transconductance, 3300 μmhos; amplification factor, 48; peak heater-cathode volts, 90 max. This type is used principally for renewal purposes.

**SHARP-CUTOFF PENTODE**

**7G7**

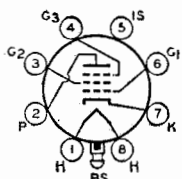

Glass lock-in type used in video amplifiers of television receivers and in other applications requiring high transconductance. Outline 15, OUTLINES SECTION. Tube requires lock-in socket. Heater volts (ac/dc), 6.3; amperes, 0.45. Characteristics and maximum ratings as class A<sub>1</sub> amplifier: plate volts, 250 (300 max); grid-No.2 supply volts, 300 max; grid-No.2 volts, 100 max; plate dissipation, 1.5 max watts; grid-No.2 input, 0.3 max watt; grid-No.1 volts, -2; grid No.3 and internal shield connected to cathode at socket; plate resistance (approx.), 0.8 megohm; transconductance, 4500 μmhos; plate ma., 6; grid-No.2 ma., 2.0; peak heater-cathode volts, 90 max. This type is used principally for renewal purposes.

**SEMIREMOTE-CUTOFF PENTODE**

**7H7**

Glass lock-in type used as rf or if amplifier in radio receivers. Outline 15, OUTLINES SECTION. Tube requires lock-in socket. Heater volts (ac/dc), 6.3; amperes, 0.3. Characteristics and maximum ratings as class A<sub>1</sub> amplifier: plate volts, 250 (300 *max*); grid-No.2 supply volts, 300 *max*; grid-No.2 volts, 150 (see curve page 66); grid-No.1 volts, positive-bias value, 0 *max*; plate dissipation, 2.5 *max* watts; grid-No.2 input for grid-No.2 voltages up to 150 volts, 0.5 *max* watt (for grid-No.2 voltages between 150 and 300 volts, see curve page 66); grid No.3 and internal shield connected to cathode at socket; cathode-bias resistor, 180 ohms; plate resistance (approx.), 0.8 megohm; transconductance, 4000  $\mu$ hos; plate ma., 10; grid-No.2 ma., 3.2; peak heater-cathode volts, 90 *max*. This type is used principally for renewal purposes.

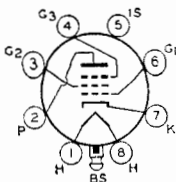

**TRIODE—HEPTODE CONVERTER**

**7J7**

Glass lock-in type used as combined oscillator and heptode mixer in radio receivers. Outline 15, OUTLINES SECTION. Tube requires lock-in socket. Heater volts (ac/dc), 6.3; amperes, 0.3. For maximum ratings and typical operation, refer to glass-octal type 6J8-G. Type 7J7 is used principally for renewal purposes.

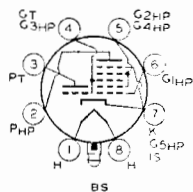

**TWIN DIODE—HIGH-MU TRIODE**

**7K7**

Glass lock-in type used as FM detector and audio amplifier in circuits which require diode and triode units with separate cathodes. Outline 15, OUTLINES SECTION. Tube requires lock-in socket. Heater volts (ac/dc), 6.3; amperes, 0.3. For ratings and typical operation, refer to glass-octal type 6AQ7-GT. Type 7K7 is used principally for renewal purposes.

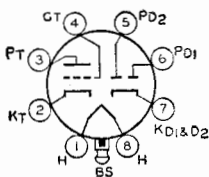

**SHARP-CUTOFF PENTODE**

**7L7**

Glass lock-in type used as rf and if amplifier in radio equipment. Outline 15, OUTLINES SECTION. Tube requires lock-in socket. Heater volts (ac/dc), 6.3; amperes, 0.3. Typical operation as class A<sub>1</sub> amplifier: plate volts, 250 (300 *max*); grid-No.2 volts, 100; grid-No.1 volts, -1.5; grid No.3 tied to cathode at socket; cathode-bias resistor, 250 ohms; plate ma., 4.5; grid-No.2 ma., 1.5; plate resistance (approx.), 1 megohm; transconductance, 3100  $\mu$ hos. This is a DISCONTINUED type listed for reference only.

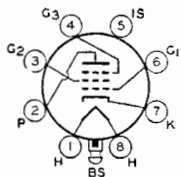

**MEDIUM-MU TWIN TRIODE**

**7N7**

Glass lock-in type used as voltage amplifier or phase inverter in radio equipment. Outline 20, OUTLINES SECTION. Tube requires lock-in socket. Heater volts (ac/dc), 6.3; amperes, 0.6. For maximum ratings and typical operation of each triode unit, refer to metal type 6J5. The application of this type is similar to that of glass-octal type 6SN7-GT. Type 7N7 is used principally for renewal purposes.

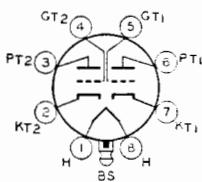

**PENTAGRID CONVERTER**

**7Q7**

Glass lock-in type used as converter in superheterodyne circuits. Outline 15, OUTLINES SECTION. Tube requires lock-in socket. Heater volts (ac/dc), 6.3; amperes, 0.3. For maximum ratings, typical operation in converter service, and curves, refer to metal type 6SA7. Type 7Q7 is used principally for renewal purposes.

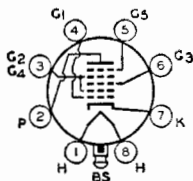



**TWIN DIODE—  
REMOTE-CUTOFF PENTODE**

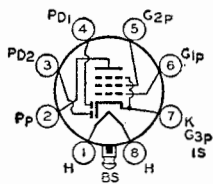

**7R7**

Glass lock-in type used as combined detector, amplifier, and avc tube. Outline 15, OUTLINES SECTION. Tube requires lock-in socket. Heater volts (ac/dc), 6.3; amperes, 0.3. Characteristics and maximum ratings of pentode unit as class A<sub>1</sub> amplifier: plate volts, 250 *max*; grid-No.2 supply volts, 250 *max*; grid-No.2 volts, 100 (see curve page 69); grid-No.1 volts, -1 (positive-bias value, 0 *max*); plate dissipation, 2 *max* watts; grid-No.2 input for grid-No.2 voltages up to 125, 0.25 *max* watt (for grid-No.2 voltages between 125 and 250 volts, see curve page 66); plate resistance (approx.), 1.0 megohm; transconductance, 3200  $\mu$ hos; plate ma., 5.7; grid-No.2 ma., 2.1; peak heater-cathode volts, 90 *max*. Refer to type 6AV6 for diode curves. Type 7R7 is used principally for renewal purposes.

**TRIODE—HEPTODE CONVERTER**

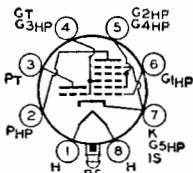

**7S7**

Glass lock-in type used as combined triode oscillator and heptode mixer in radio receivers. Outline 15, OUTLINES SECTION. Tube requires lock-in socket. Heater volts (ac/dc), 6.3; amperes, 0.3. Typical operation of heptode unit: plate volts, 250 (300 *max*); grids-No.2-and-No.4 volts, 100; grid-No.1 volts, -2; plate resistance, 1.25 megohms; conversion transconductance, 525  $\mu$ hos; plate ma., 1.8; grids-No.2-and-No.4 ma., 3.0. Typical operation of triode unit: plate supply volts, 250 (300 *max*) applied through a 20000-ohm dropping resistor bypassed by a 0.1- $\mu$ f capacitor; grid resistor, 50000 ohms; plate ma., 5.0; total cathode ma. (both units), 10.2. This is a DISCONTINUED type listed for reference only.

**SHARP-CUTOFF PENTODE**

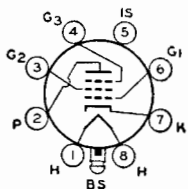

**7V7**

Glass lock-in type used as rf or if amplifier in radio receivers. Outline 15, OUTLINES SECTION. Tube requires lock-in socket. Heater volts (ac/dc), 6.3; amperes, 0.45. Characteristics and maximum ratings as class A<sub>1</sub> amplifier: plate and grid-No.2 supply volts, 300 *max*; grid-No.2 series resistor, 40000 ohms; plate dissipation, 4 *max* watts; grid-No.2 input, 0.8 *max* watt; grid No.3 connected to cathode at socket; cathode-bias resistor, 160 ohms; plate resistance (approx.), 0.3 megohm; transconductance, 5800  $\mu$ hos; plate ma., 10; grid-No.2 ma., 3.9; peak heater-cathode volts, 90 *max*. This type is used principally for renewal purposes.

**SHARP-CUTOFF PENTODE**

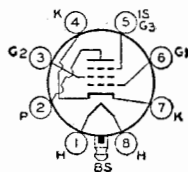

**7W7**

Glass lock-in type used as rf or if amplifier in radio receivers. Outline 15, OUTLINES SECTION. Tube requires lock-in socket. Heater volts (ac/dc), 6.3; amperes, 0.45. This type is the same as type 7V7 except for socket connections. Type 7W7 is used principally for renewal purposes.

**TWIN DIODE—HIGH-MU TRIODE**

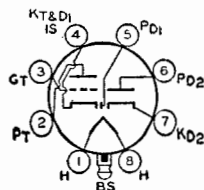

**7X7**

Glass lock-in type used as combined detector, amplifier, and avc tube in circuits which require diodes with separate cathodes. Outline 20, OUTLINES SECTION. Tube requires lock-in socket. Heater volts (ac/dc), 6.3; amperes, 0.3. Characteristics and maximum ratings of triode unit as class A<sub>1</sub> amplifier: plate volts, 250 (300 *max*); grid volts, -1; amplification factor, 100; plate resistance (approx.), 67000 ohms; transconductance, 1500  $\mu$ hos; plate ma., 1.9; peak heater-cathode volts, 90 *max*. This type is used principally for renewal purposes.

## 7Y4

### FULL-WAVE VACUUM RECTIFIER

Glass lock-in type used in power supply of automobile radio receivers and compact ac-operated receivers. Outline 15, OUTLINES SECTION. Tube requires lock-in socket. Heater volts (ac/dc), 6.3; amperes, 0.5. Maximum ratings: peak inverse plate volts, 1250; peak plate ma. per plate, 180; dc output ma., 70; peak heater-cathode volts, 450. For typical operation, refer to miniature type 6X4. Type 7Y4 is used principally for renewal purposes.

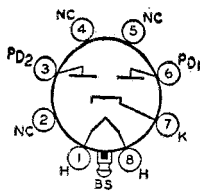

## 7Z4

### FULL-WAVE VACUUM RECTIFIER

Glass lock-in type used in power supply of automobile and ac-operated radio receivers. Outline 20, OUTLINES SECTION. Tube requires lock-in socket. Heater volts (ac/dc), 6.3; amperes, 0.9. Maximum ratings: peak inverse plate volts, 1250; peak plate ma. per plate, 300; dc output ma., 100; peak heater-cathode volts, 450. Typical operation with capacitor-input filter: ac plate-to-plate supply volts (rms), 650;

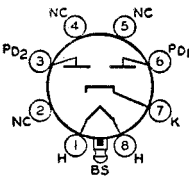

total effective plate-supply impedance per plate, 75 min ohms; dc output ma., 100. Typical operation with choke-input filter: ac plate-to-plate supply volts (rms), 900; filter-input choke, 6 min henries; dc output ma., 100. This type is used principally for renewal purposes.

## 8AU8

### MEDIUM-MU TRIODE— SHARP-CUTOFF PENTODE

Miniature type used in a wide variety of applications in television receivers employing series-connected heater strings. The pentode unit is used as a video amplifier, an if amplifier, or

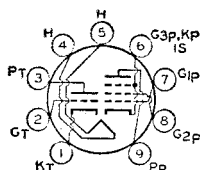

an age amplifier. The triode unit is used in sync-amplifier, sync-separator, sync-clipper, and phase-inverter circuits. Outline 14, OUTLINES SECTION. Heater volts (ac/dc), 8.4; amperes, 0.45. Except for heater rating, this type is identical with type 6AU8.

## 8AW8-A

### HIGH-MU TRIODE— SHARP-CUTOFF PENTODE

Miniature type used in a wide variety of applications in television receivers employing series-connected heater strings. The pentode unit is used as an amplifier and the triode

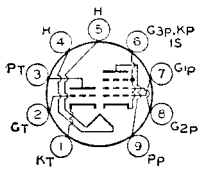

unit is used in low-frequency oscillator or sync circuits. Outline 14, OUTLINES SECTION. Heater volts (ac/dc), 8.4; amperes, 0.45; warm-up time (average) 11 seconds. Except for heater rating, this type is identical with miniature type 6AWS-A.

## 8BA8-A

### MEDIUM-MU TRIODE— SHARP-CUTOFF PENTODE

Miniature type used in a wide variety of applications in color and black-and-white television receivers employing series-connected heater strings. The pentode unit is used as a video amplifier,

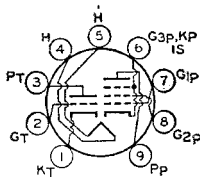

an age amplifier, or a reactance tube. The triode unit is used in low-frequency oscillator and phase-splitter circuits. Outline 14, OUTLINES SECTION. Tube requires miniature nine-contact socket and may be operated in any position. Heater volts (ac/dc), 8.4; amperes, 0.45. Except for heater ratings, the 8BA8-A is identical with miniature type 6BA8-A.

**MEDIUM-MU TRIODE—  
SHARP-CUTOFF PENTODE**

**8BH8**

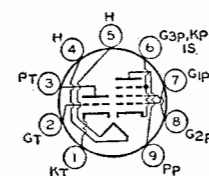

Miniature type used in a wide variety of applications in television receivers employing series-connected heater strings. The pentode unit is used as an if amplifier, a video amplifier, or an agc amplifier. The triode unit is used in low-frequency oscillator circuits. Outline 14, OUTLINES SECTION. Heater volts (ac/dc), 8.4; amperes, 0.45. Except for heater rating, this type is identical with type 6BH8.

**TWIN DIODE—  
HIGH-MU TRIODE**

**8BN8**

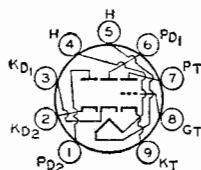

Miniature type used in a wide variety of applications in color and black-and-white television receivers employing series-connected heater strings. The triode unit is used in burst amplifier, af amplifier, and low-frequency oscillator applications. The diode units are used in phase-detector, ratio-detector or discriminator, and horizontal AFC discriminator circuits. Outline 14, OUTLINES SECTION. Heater volts (ac/dc), 8.4; amperes, 0.45. Except for heater rating, this type is identical with type 6BN8.

**POWER PENTODE**

**8BQ5**

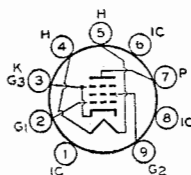

Miniature type used in the output stage of audio-frequency amplifiers employing series-connected heater strings. Outline 18, OUTLINES SECTION. Heater volts (ac/dc), 8; amperes, 0.6; warm-up time (average), 11 seconds. Except for heater rating, this type is identical with type 6BQ5.

**MEDIUM-MU TWIN TRIODE**

**8CG7**

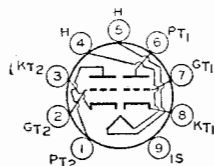

Miniature type used as combined vertical deflection and horizontal deflection oscillator in television receivers employing series-connected heater strings. Outline 14, OUTLINES SECTION. Heater volts (ac/dc), 8.4; amperes, 0.45; warm-up time (average), 11 seconds. Except for heater rating, this type is identical with miniature type 6CG7.

**MEDIUM-MU DUAL TRIODE**

**8CM7**

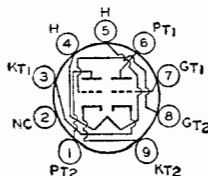

Miniature type used as combined vertical oscillator and vertical deflection amplifier in television receivers employing series-connected heater strings. Outline 14, OUTLINES SECTION. Heater volts (ac/dc), 8.4; amperes, 0.45; warm-up time (average), 11 seconds. Except for heater rating, this type is identical with miniature type 6CM7.

**TWIN DIODE—  
HIGH-MU TRIODE**

**8CN7**

Miniature type used as combined horizontal phase detector and reactance tube in television receivers employing series-connected heater strings. The triode unit is used in sync-separator, sync-amplifier, or audio-amplifier circuits. Outline 12, OUTLINES SECTION. Heater volts (ac/dc), 8.4 (series), 4.2 (parallel); amperes, 0.225 (series), 0.45 (parallel); warm-up time (average), 11 seconds (parallel). Except for heater rating, this type is identical with type 6CN7.

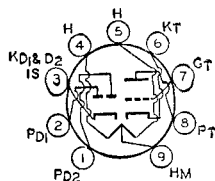

**MEDIUM-MU TRIODE—  
SHARP-CUTOFF PENTODE**

**8CX8**

Miniature type used in television receivers employing series-connected heater strings. Pentode unit is used as video amplifier; triode unit is used in sound if amplifier, sweep-oscillator, sync-separator, sync-amplifier, and sync-clipper circuits. Outline 14, OUTLINES SECTION. Heater volts (ac/dc), 8; amperes, 0.6; warm-up time (average), 11 seconds. Except for heater rating, this type is identical with type 6CX8.

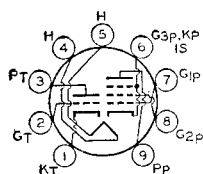

**HIGH-MU TRIODE—  
SHARP-CUTOFF PENTODE**

**8EB8**

Miniature type used in color and black-and-white television receivers employing series-connected heater strings. The pentode unit is used as a video output amplifier; the triode unit is used in sync-separator, sync-clipper, and phase-inverter circuits. Outline 14, OUTLINES SECTION. Heater volts (ac/dc), 8; amperes, 0.6; warm-up time (average), 11 seconds. Except for heater rating, this type is identical with miniature type 6EB8.

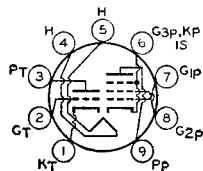

**BEAM POWER TUBE**

**8EM5**

Miniature type used as vertical deflection amplifier in television receivers utilizing picture tubes having diagonal deflection angles of 110 degrees and employing series-connected heater strings. Outline 18, OUTLINES SECTION. Heater volts (ac/dc), 8.4; amperes, 0.6; warm-up time (average), 11 seconds. Except for heater rating, this type is identical with miniature type 6EM5.

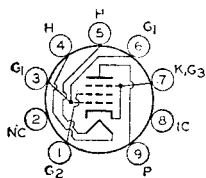

**TWIN DIODE—  
SHARP-CUTOFF PENTODE**

**8ET7**

Miniature type used in television receivers employing series-connected heater strings. The pentode unit is used as a video amplifier and the diodes are used as a horizontal phase inverter. Outline 14, OUTLINES SECTION. Tube requires miniature nine-contact socket and may be operated in any position.

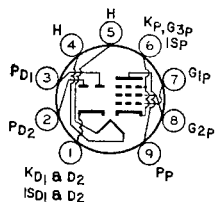

HEATER VOLTAGE (AC/DC).....	8	volts
HEATER CURRENT.....	0.6	ampere
HEATER WARM-UP TIME (Average).....	11	seconds

**PENTODE UNIT AS CLASS A<sub>1</sub> AMPLIFIER**

**Maximum Ratings, (Design-Maximum Values):**

PLATE VOLTAGE.....	330 <i>max</i>	volts
GRID-NO.2 (SCREEN-GRID) SUPPLY VOLTAGE.....	330 <i>max</i>	volts
GRID-NO.2 VOLTAGE.....	See curve page 66	
GRID-NO.1 (CONTROL-GRID) VOLTAGE, Positive-bias value.....	0 <i>max</i>	volts
GRID-NO.2 INPUT:		
For grid-No.2 voltages up to 165 volts.....	1.1 <i>max</i>	watts
For grid-No.2 voltages between 165 and 330 volts.....	See curve page 66	
PLATE DISSIPATION.....	5 <i>max</i>	watts
PEAK HEATER-CATHODE VOLTAGE:		
Heater negative with respect to cathode.....	200 <i>max</i>	volts
Heater positive with respect to cathode.....	200 <sup>o</sup> <i>max</i>	volts

**Characteristics:**

Plate Supply Voltage.....	60	200	volts
Grid-No.2 Supply Voltage.....	150	150	volts
Grid-No.1 Voltage.....	0	—	volts
Cathode-Bias Resistor.....	—	100	ohms
Plate Resistance (Approx.).....	—	60000	ohms
Transconductance.....	—	11500	$\mu$ ohms
Plate Current.....	55 <sup>■</sup>	25	ma
Grid-No.2 Current.....	18 <sup>■</sup>	5.5	ma
Grid-No.1 Voltage (Approx.), for plate $\mu$ a=100.....	—	-10	volts

**Maximum Circuit Values:**

Grid-No.1-Circuit Resistance		
For fixed-bias operation.....	0.1 <i>max</i>	megohm
For cathode-bias operation.....	0.25 <i>max</i>	megohm

**DIODE UNITS**

**Maximum Ratings, (Design-Maximum Values):**

DC PLATE CURRENT.....	3 <i>max</i>	ma
PEAK HEATER-CATHODE VOLTAGE:		
Heater negative with respect to cathode.....	200 <i>max</i>	volts
Heater positive with respect to cathode.....	200 <sup>■</sup> <i>max</i>	volts

**Characteristics, Instantaneous Test Condition:**

Plate Current, for plate volts=10.....	1.5	ma
--	-----	----

<sup>o</sup> The dc component must not exceed 100 volts.

<sup>■</sup> This value can be measured by a method involving a recurrent waveform such that the maximum ratings of the tube will not be exceeded.

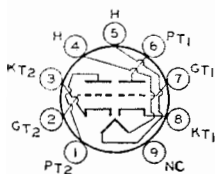

**MEDIUM-MU TWIN TRIODE**

Miniature type used as combined vertical- and horizontal-deflection oscillator in television receivers employing series-connected heater strings. Outline 14, OUTLINES SECTION.

**8FQ7**

Tube requires miniature nine-contact socket and may be operated in any position. Heater volts (ac/dc), 8.4; amperes, 0.45. Except for heater ratings, the 8FQ7 is identical with type 6FQ7.

**HIGH-MU TRIODE—  
SHARP-CUTOFF PENTODE**

Miniature type used in color and black-and-white television receivers employing series-connected heater strings. Triode unit is used in voltage-amplifier applications; pentode unit is

**8GN8**

used in output stage of video amplifier. Outline 14, OUTLINES SECTION. Tube requires miniature nine-contact socket and may be operated in any position. Heater volts (ac/dc), 8; amperes, 0.6; heater warm-up time (average), 11 seconds. Except for heater ratings, this type is identical with type 6GN8.

# 9AU7

## MEDIUM-MU TWIN TRIODE

Miniature type used as combined vertical-deflection-amplifier and vertical-deflection-oscillator in television receivers employing series-connected heater strings. Outline 12, OUTLINES

SECTION. Heater volts (ac/dc), 9.4 (series), 4.7 (parallel); amperes, 0.225 (series), 0.45 (parallel); warm-up time (average), 11 seconds (parallel). Except for heater rating, this type is identical with type 12AU7-A.

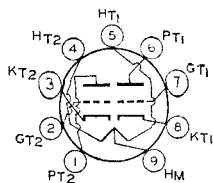

# 9BR7

## TWIN DIODE— HIGH-MU TRIODE

Miniature type used as combined sync separator and horizontal phase detector in television receivers employing series-connected heater strings. Outline 12, OUTLINES SECTION. Tube requires miniature socket and may be mounted in any position. Type 9BR7 is used principally for renewal purposes.

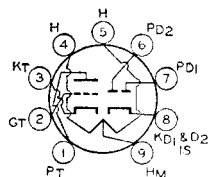

HEATER ARRANGEMENT:	Series	Parallel	
HEATER VOLTAGE (AC/DC).....	9.4	4.7	volts
HEATER CURRENT.....	0.3	0.6	ampere
HEATER WARM-UP TIME (Average).....	-	11	seconds

### Maximum Ratings: TRIODE UNIT AS CLASS A<sub>1</sub> AMPLIFIER

PLATE VOLTAGE.....	300 max	volts
GRID VOLTAGE, Negative-bias value.....	-50 max	volts
PLATE DISSIPATION.....	2.5 max	watts
PEAK HEATER-CATHODE VOLTAGE:		
Heater negative with respect to cathode.....	300 max	volts
Heater positive with respect to cathode.....	200 max	volts

### Characteristics.

Plate Supply Voltage.....	250	volts
Cathode-Bias Resistor.....	200	ohms
Amplification Factor.....	60	
Plate Resistance (Approx.).....	10900	ohms
Transconductance.....	4000	μmhos
Plate Current.....	10	ma
Grid Voltage (Approx.) for plate current of 10 μa.....	-12	volts

### DIODE UNITS (Each Unit)

PEAK INVERSE PLATE VOLTAGE.....	300 max	volts
PEAK PLATE CURRENT.....	60 max	ma
PEAK HEATER-CATHODE VOLTAGE:		
Heater negative with respect to cathode.....	300 max	volts
Heater positive with respect to cathode.....	200 max	volts

■ The dc component must not exceed 100 volts.

## MEDIUM-MU TRIODE— SHARP-CUTOFF TETRODE

Miniature type used as combined oscillator and mixer in vhf tuners of television receivers employing series-connected heater strings. Outline 12, OUTLINES SECTION. Tube requires miniature nine-contact socket and may be mounted in any position.

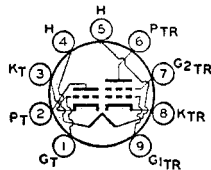

# 9CL8

HEATER VOLTAGE (AC/DC).....	9.5	volts
HEATER CURRENT.....	0.3	ampere
HEATER WARM-UP TIME (Average).....	11	seconds

CLASS A<sub>1</sub> AMPLIFIER

Maximum Ratings:

PLATE VOLTAGE.....	300 max	300 max	volts
GRID-NO.2 (SCREEN-GRID) SUPPLY VOLTAGE.....	-	300 max	volts
GRID-NO.2 VOLTAGE.....	-	see curve page 66	
GRID-NO.1 (CONTROL-GRID) VOLTAGE, Positive-bias value.....	0 max	0 max	volts
GRID-NO.2 INPUT:			
For grid-No.2 voltages up to 150 volts.....	-	0.5 max	watt
For grid-No.2 voltages between 150 and 300 volts.....	-	See curve page 66	
PLATE DISSIPATION.....	2.7 max	2.8 max	watts
PEAK HEATER-CATHODE VOLTAGE:			
Heater negative with respect to cathode.....	200 max	200 max	volts
Heater positive with respect to cathode.....	200 max	200 max	volts

■ The dc component must not exceed 100 volts.

Maximum Circuit Values:

Grid-No.1-Circuit Resistance:	Triode Unit	Tetrode Unit	
For fixed-bias operation.....	0.5 max	0.25 max	megohm
For cathode-bias operation.....	1 max	1 max	megohm

Characteristics:

Plate Supply Voltage.....	125	125	volts
Grid-No.2 Supply Voltage.....	-	125	volts
Grid-No.1 Voltage.....	-	-1	volt
Cathode-Bias Resistor.....	56	-	ohms
Amplification Factor.....	40	-	
Plate Resistance (Approx.).....	5000	100000	ohms
Transconductance.....	8000	5800	μmhos
Plate Current.....	15	12	ma
Grid-No.2 Current.....	-	4	ma
Grid-No.1 Voltage (Approx.) for plate current of 10 μa.....	-9	-10	volts

MEDIUM-MU TRIODE—  
SHARP-CUTOFF PENTODE

Miniature type used in television receivers employing series-connected heater strings. Tube is used as combined oscillator and mixer tube in vhf tuners of television receivers utilizing

9U8-A

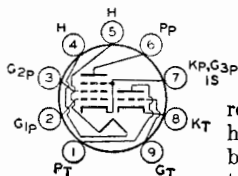

an intermediate frequency in the order of 40 megacycles per second. Outline 12, OUTLINES SECTION. Heater voltage (ac/dc), 9.45; amperes, 0.3, warm-up time (average), 11 seconds. Except for heater rating, this type is identical with type 6U8-A.

POWER TRIODE

Glass type used as an audio-frequency amplifier. Outline 51, OUTLINES SECTION. Tube requires four-contact socket. Filament volts (ac/dc), 7.5; amperes, 1.25. Typical operation as class A<sub>1</sub> af power amplifier: plate volts, 425 max; grid volts, -40; peak af grid volts, 35; plate ma., 18; plate resistance, 5000 ohms; transconductance, 1600 μmhos; load resistance,

10

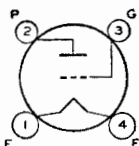

10200 ohms; undistorted output watts, 1.6. This is a DISCONTINUED type listed for reference only.

HIGH-MU TRIODE—  
SHARP-CUTOFF PENTODE

Miniature type used in diversified applications in television receivers employing series-connected heater strings. The pentode unit is used as a general-purpose amplifier tube; the triode unit is used in vertical-deflection-oscillator, sync-separator, sync-clipper, and sync-amplifier circuits. Outline 12, OUTLINES SECTION. Tube requires miniature nine-contact socket and may be mounted in any position.

10C8

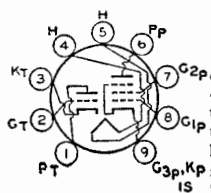

Heater volts (ac/dc), 10.5; amperes, 0.3; warm-up time (average), 11 seconds. This type is used principally for renewal purposes.

**CLASS A<sub>1</sub> AMPLIFIER**

**Maximum Ratings, (Design-Maximum Values):**

	<i>Triode Unit</i>	<i>Pentode Unit</i>	
PLATE VOLTAGE.....	300 max	300 max	volts
GRID-NO.2 (SCREEN-GRID) VOLTAGE.....	-	300 max	volts
GRID-NO.2 VOLTAGE.....	-	See curve page 66	
GRID-NO. (CONTROL-GRID) VOLTAGE, Positive-bias value.....	0 max	0 max	volts
GRID-NO.2 INPUT:			
For grid-No.2 voltages up to 150 volts.....	-	0.55 max	watt
For grid-No.2 voltages between 150 and 300 volts.....	-	See curve page 66	
PLATE DISSIPATION.....	2 max	2.2 max	watts
PEAK HEATER-CATHODE VOLTAGE:			
Heater negative with respect to cathode.....	200 max	200 max	volts
Heater positive with respect to cathode.....	200 <sup>■</sup> max	200 <sup>■</sup> max	volts

**Characteristics:**

Plate Supply Voltage.....	250	135	volts
Grid-No.2 Supply Voltage.....	-	135	volts
Cathode-Bias Resistor.....	390	100	ohms
Amplification Factor.....	53	40 <sup>□</sup>	
Plate Resistance (Approx.).....	0.012	0.19	megohm
Transconductance.....	4400	8000	μmhos
Plate Current.....	7.3	11.5	ma
Grid-No.2 Current.....	-	3.2	ma
Grid Voltage (Approx.) for plate current of 10 μa.....	-10	-	volts
Grid-No. Voltage (Approx.) for plate current of 50 μa.....	-	-6	volts

**Maximum Circuit Values:**

Grid-No.1-Circuit Resistance:			
For fixed-bias operation.....	0.5 max	0.25 max	megohm
For cathode-bias operation.....	1 max	1 max	megohm

**VERTICAL-DEFLECTION OSCILLATOR AND AMPLIFIER**

*For operation in a 525-line, 30-frame system*

**Maximum Ratings, (Design-Maximum Values):**

	<i>Triode Unit as Oscillator</i>	<i>Pentode Unit as Amplifier<sup>□</sup></i>	
PLATE VOLTAGE.....	300 max	300 max	volts
PEAK POSITIVE-PULSE PLATE VOLTAGE <sup>•</sup> .....	-	1000 max	volts
PEAK NEGATIVE-PULSE GRID VOLTAGE.....	400 max	-	volts
PEAK NEGATIVE-PULSE GRID-NO.1 VOLTAGE.....	-	250 max	volts
PEAK CATHODE CURRENT.....	35 max	55 max	ma
AVERAGE CATHODE CURRENT.....	12 max	18 max	ma
PLATE DISSIPATION.....	1 max	2.5 max	watts
PEAK HEATER-CATHODE VOLTAGE:			
Heater negative with respect to cathode.....	200 max	200 max	volt
Heater positive with respect to cathode.....	200 <sup>■</sup> max	200 <sup>■</sup> max	volts

**Maximum Circuit Values:**

Grid No.1-Circuit Resistance:			
For fixed bias, grid-resistor-bias, or cathode-bias operation	2.2 max	-	megohms
For grid-resistor-bias or cathode-bias operation.....	-	2.2 max	megohms

▪ The dc component must not exceed 100 volts.

\* Triode connection, grid No.2 connected to plate.

• The duration of the voltage pulse must not exceed 15 per cent of one vertical scanning cycle. In a 525-line, 30-frame system, 15 per cent of one vertical scanning cycle is 2.5 milliseconds.

**DUAL TRIODE**

**10DE7**

Miniature type used as combined vertical oscillator and vertical deflection amplifier in television receivers employing series-connected heater strings. Unit No.1 is a medium-μu

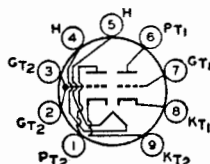

triode unit used as a blocking oscillator in vertical-deflection circuits, and unit No.2 is a low-μu triode unit used as a vertical-deflection amplifier. Outline 14, OUT-LINES SECTION. Heater volts (ac/dc), 9.7; amperes, 0.6; warm-up time (average), 11 seconds. Except for heater rating, this type is identical with miniature type 6DE7.



**DUAL TRIODE**

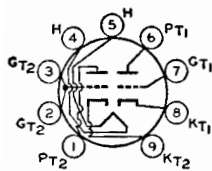

Miniature type used as combined vertical-deflection-oscillator and vertical-deflection-amplifier tube in television receivers employing series-connected heater strings. Outline 14, OUT-

**10DR7**

LINES SECTION. Tube requires miniature nine-contact socket and may be operated in any position. Heater volts (ac/dc), 9.7; amperes, 0.6; warm-up time (average), 11 seconds. Except for heater ratings, the 10DR7 is identical with type 6DR7.

**DUAL TRIODE**

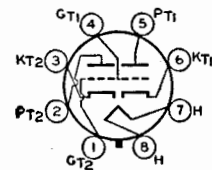

Glass octal type used as combined vertical-deflection oscillator and vertical-deflection amplifier in television receivers employing series-connected heater strings. Outline 19, OUTLINES

**10EG7**

SECTION. Tube requires octal socket and may be operated in any position. For maximum ratings and characteristics, refer to type 6EW7.

HEATER VOLTAGE (AC/DC).....	9.7	volts
HEATER CURRENT.....	0.6	ampere
HEATER WARM-UP TIME (Average).....	11	seconds

DIRECT INTERELECTRODE CAPACITANCES (Approx.): <sup>o</sup>	Unit No.1	Unit No.2	
Grid to Plate.....	4.4	9.5	$\mu\mu\text{f}$
Grid to Cathode and Heater.....	2.2	7	$\mu\mu\text{f}$
Plate to Cathode and Heater.....	0.6	1.6	$\mu\mu\text{f}$

<sup>o</sup>Without external shield.

**DUAL TRIODE**

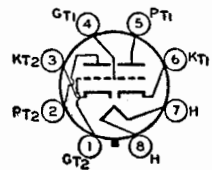

Glass octal type containing high-mu triode and high-perveance, low-mu triode in same envelope. Used as combined vertical-deflection oscillator and vertical-deflection amplifier in television

**10EM7**

receivers employing series-connected heater strings. Heater volts (ac/dc), 9.7; amperes, 0.6; warm-up time (average), 11 seconds. Except for heater ratings, this type is identical with type 6EM7.

**HIGH-MU TRIODE—  
SHARP-CUTOFF PENTODE**

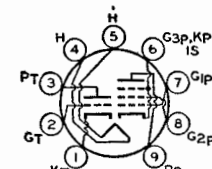

Miniature type used in color and black-and-white television receivers employing series-connected heater strings. Triode unit is used in high-gain, sound-if stages and in sync-separator,

**10HF8**

sync-clipper, and phase-inverter circuits; pentode unit is used as video-output amplifier. Outline 14, OUTLINES SECTION. Tube requires miniature nine-contact socket and may be operated in any position. Heater volts (ac/dc), 10.5; amperes, 0.45; warm-up time (average), 11 seconds. Except for heater ratings, this type is identical with miniature type 6HF8.

**DETECTOR AMPLIFIER**

Glass type used as detector and amplifier in battery-operated receivers. Filament volts (dc), 1.1; amperes, 0.25. Typical operation as class A<sub>1</sub> amplifier: plate volts, 135 max; grid volts, -10.5; plate resistance (approx.), 15500 ohms; transconductance, 440 μmhos; plate ma., 3. This is a DISCONTINUED type listed for reference only.

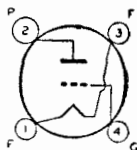

11

**DUAL TRIODE**

Miniature type used in television receivers employing series-connected heater-strings. Low-μ triode unit is used as vertical-deflection amplifier; high-μ triode unit is used as vertical-deflection oscillator. Outline 14, OUTLINES SECTION. Heater volts (ac/dc), 11; amperes, 0.45; warm-up time (average), 11 seconds. Except for heater rating, this type is identical with miniature type 6CY7.

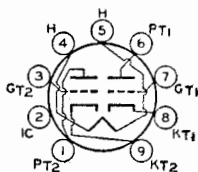

11CY7

**DETECTOR AMPLIFIER**

Glass type used as detector and amplifier in battery-operated receivers. Filament volts (dc), 1.1; amperes, 0.25. Typical operation as class A<sub>1</sub> amplifier: plate volts, 135 max; grid volts, -10.5; plate resistance (approx.), 15500 ohms; transconductance, 440 μmhos; plate ma., 3. This is a DISCONTINUED type listed for reference only.

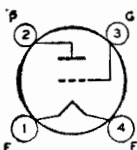

12

**POWER PENTODE**

Glass type used as output amplifier in ac/dc radio receivers. Outline 34 or 35, OUTLINES SECTION. Heater volts (ac/dc), 12.6 in series heater arrangement and 6.3 in parallel arrangement; amperes, 0.3 (series), 0.6 (parallel). Typical operation as class A<sub>1</sub> amplifier: plate volts and grid-No.2 volts, 180 max; grid-No.1 volts, -25; plate ma., 45; grid-No.2 ma., 8; plate resistance, 35000 ohms; transconductance, 2400 μmhos; load resistance, 3300 ohms; output watts, 3.4. This is a DISCONTINUED type listed for reference only.

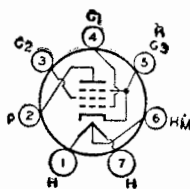

12A5

**RECTIFIER—POWER PENTODE**

Glass type used as combined half-wave rectifier and power amplifier. Outline 40, OUTLINES SECTION. Tube requires small seven-contact (0.75-inch, pin-circle diameter) socket. Heater volts (ac/dc), 12.6; amperes, 0.3. Typical operation of pentode unit as class A<sub>1</sub> amplifier: plate volts and grid-No.2 volts, 135 max; grid-No.1 volts, -13.5; load resistance, 13500

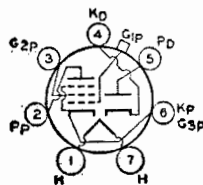

ohms; plate resistance, 100000 ohms; transconductance, 975 μmhos; cathode-bias resistor, 1175 ohms; plate ma., 9; grid-No.2 ma., 2.5; output watts, 0.55. Maximum ratings of rectifier unit with capacitor-input filter: ac plate volts (rms), 125; dc output ma., 30. This is a DISCONTINUED type listed for reference only.

12A7

**PENTAGRID CONVERTER**

Glass octal type used as converter in ac/dc receivers. Outline 23, OUTLINES SECTION. Heater volts (ac/dc), 12.6; amperes, 0.15. Except for heater rating, this type is identical with glass octal type 6A8-GT. Type 12A8-GT is used principally for renewal purposes.

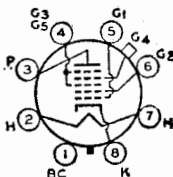

12A8-GT

**BEAM POWER TUBE**

Miniature type used in the output stage of automobile radio receivers operating from a 12-volt storage battery. Outline 14, OUTLINES SECTION. Tube requires miniature nine-contact socket and may be mounted in any position.

12AB5

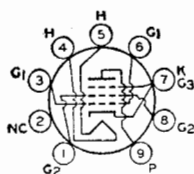

HEATER-VOLTAGE RANGE (AC/DC) .....	10.0 to 15.9	volts
HEATER CURRENT (Approx.) at 12.6 volts .....	0.2	ampere
DIRECT INTERELECTRODE CAPACITANCES:		
Grid No.1 to Plate .....	0.7 max	μf
Grid No.1 to Cathode, Heater, Grid No.2, and Grid No.3 .....	8	μf
Plate to Cathode, Heater, Grid No.2, and Grid No.3 .....	8.5	μf

• For longest life, it is recommended that the heater be operated within the voltage range of 11 to 14 volts.

**CLASS A<sub>1</sub> AMPLIFIER**

**Maximum Ratings:**

PLATE VOLTAGE .....	315 max	volts
GRID-NO.2 (SCREEN-GRID) VOLTAGE .....	285 max	volts
PLATE DISSIPATION .....	12 max	watts
GRID-NO.2 INPUT .....	2 max	watts
PEAK HEATER-CATHODE VOLTAGE:		
Heater negative with respect to cathode .....	90 max	volts
Heater positive with respect to cathode .....	90 max	volts
BULB TEMPERATURE (At hottest point) .....	250 max	°C

**Typical Operation with 12.6 Volts on Heater:**

Plate Supply Voltage .....	250	250	volts
Grid-No.2 Supply Voltage .....	200	250	volts
Grid-No.1 (Control-Grid) Voltage .....	-	-12.5	volts
Cathode-Bias Resistor .....	270	-	ohms
Peak AF Grid-No.1 Voltage .....	10.5	12.5	volts
Zero-Signal Plate Current .....	33.5	45	ma
Maximum-Signal Plate Current .....	36	47	ma
Zero-Signal Grid-No.2 Current .....	1.6	4.5	ma
Maximum-Signal Grid-No.2 Current .....	3.2	7	ma
Plate Resistance (Approx.) .....	75000	50000	ohms
Transconductance .....	4000	4100	μmhos
Load Resistance .....	6000	5000	ohms
Total Harmonic Distortion .....	8	8	per cent
Maximum-Signal Power Output .....	3.3	4.6	watts

**Maximum Circuit Values:**

Grid-No.1-Circuit Resistance:		
For fixed-bias operation .....	0.1 max	megohm
For cathode-bias operation .....	0.5 max	megohm

**PUSH-PULL CLASS AB<sub>1</sub> AMPLIFIER**

**Maximum Ratings: (Same as for single-tube class A<sub>1</sub> amplifier)**

**Typical Operation with 12.6 Volts on Heater (Values are for two tubes):**

Plate Voltage .....	250	volts
Grid-No.2 Voltage .....	250	volts
Grid-No.1 Voltage .....	-15	volts
Peak AF Grid-No.1-to-Grid-No.1 Voltage .....	30	volts
Zero-Signal Plate Current .....	70	ma
Maximum-Signal Plate Current .....	79	ma
Zero-Signal Grid-No.2 Current .....	5	ma
Maximum-Signal Grid-No.2 Current .....	13	ma
Effective Load Resistance (Plate-to-plate) .....	10000	ohms
Total Harmonic Distortion .....	5	per cent
Maximum-Signal Power Output .....	10	watts

**Maximum Circuit Values:**

Grid-No.1-Circuit Resistance:		
For fixed-bias operation .....	0.1 max	megohm
For cathode-bias operation .....	0.5 max	megohm

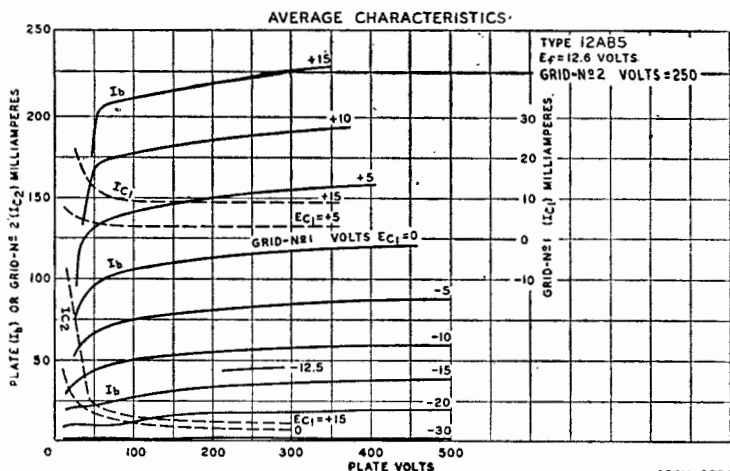

## 12AC6

### REMOTE-CUTOFF PENTODE

Miniature type used as rf and if amplifier in automobile receivers operating from a 12-volt storage battery. Outline 11, OUTLINES SECTION. Tube requires miniature seven-contact socket and may be mounted in any position. Heater-voltage range (ac/dc), 10 to 15.9; amperes at 12.6 volts, 0.15. This type is used principally for renewal purposes.

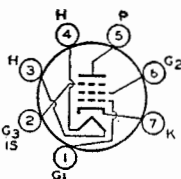

#### Maximum Ratings:

#### CLASS A<sub>1</sub> AMPLIFIER

PLATE VOLTAGE.....	30 max	volts
GRID-NO.3 (SUPPRESSOR GRID).....	Connect to cathode	at socket
GRID-NO.2 (SCREEN-GRID) VOLTAGE.....	30 max	volts
CATHODE CURRENT.....	20 max	ma
PEAK HEATER-CATHODE VOLTAGE:		
Heater negative with respect to cathode.....	30 max	volts
Heater positive with respect to cathode.....	30 max	volts

#### Characteristics with 12.6 Volts on Heater:

Plate Voltage.....	12.6	volts
Grid No.3 and Internal Shield.....	Connected to cathode	at socket
Grid-No.2 Voltage.....	12.6	volts
Grid-No.1 (Control-Grid) Supply Voltage.....	0	volts
Grid-No.1 Resistor (Bypassed).....	2.2	megohms
Plate Resistance (Approx.).....	0.5	megohm
Transconductance, Grid No.1 to Plate.....	730	$\mu$ mhos
Plate Current.....	550	$\mu$ A
Grid-No.2 Current.....	200	$\mu$ A
Grid-No.1 Voltage (Approx.) for transconductance of 10 $\mu$ mhos.....	-5.2	volts
Grid-No.3 Voltage (Approx.) for transconductance of 10 $\mu$ mhos.....	-3.7	volts

#### Maximum Circuit Value:

Grid-No.1-Circuit Resistance.....	10 max	megohms
-----------------------------------	--------	---------

•For longest life, it is recommended that the heater be operated within the voltage range of 11 to 14 volts.

### PENTAGRID CONVERTER

Miniature type used as combined oscillator and mixer in low B+ voltage automobile radio receivers operating directly from a 12-volt storage-battery system. Outline 11, OUTLINES SECTION. Tube requires miniature seven-contact socket and may be mounted in any position.

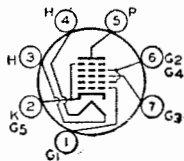

## 12AD6

## Technical Data

HEATER-VOLTAGE RANGE (AC/DC) *	10.0 to 15.9	volts
HEATER CURRENT (Approx.) at 12.6 volts.	0.15	ampere
<b>DIRECT INTERELECTRODE CAPACITANCES:</b>		
Grid No.3 to All Other Electrodes (RF Input) .....	7	$\mu\mu\text{f}$
Plate to All Other Electrodes (Mixer Output) .....	7	$\mu\mu\text{f}$
Grid No.1 to Cathode, Heater, Plate, Grid No.5, and Grid No.3 (Oscillator Input) .....	3.2 max	3.2 max $\mu\mu\text{f}$
Grid No.2 and Grid No.4 to Cathode, Heater, Plate, Grid No.5, and Grid No.3 (Oscillator Output) .....	11	11 $\mu\mu\text{f}$
Grid No.1 to Grid No.2 and Grid No.4 .....	2.2	2.2 $\mu\mu\text{f}$
Grid No.3 to Plate .....	0.8 max	0.26 max $\mu\mu\text{f}$
Grid No.3 to Grid No.1 .....	0.15 max	0.15 max $\mu\mu\text{f}$

\*For longest life, it is recommended that the heater be operated within the voltage range of 11 to 14 volts.

† External shield connected to cathode.

### CONVERTER SERVICE

#### Maximum Ratings, (Design-Maximum Values):

PLATE VOLTAGE .....	16 max	volts
GRIDS-NO.2-AND-NO.4 (SCREEN-GRID) SUPPLY VOLTAGE .....	16 max	volts
GRIDS-NO.2-AND-NO.4 VOLTAGE .....	16 max	volts
<b>GRID-NO.3 (CONTROL-GRID) VOLTAGE:</b>		
Negative bias value .....	-16 max	volts
Positive bias value .....	0 max	volts
TOTAL CATHODE CURRENT .....	20 max	ma
<b>PEAK HEATER-CATHODE VOLTAGE:</b>		
Heater negative with respect to cathode .....	16 max	volts
Heater positive with respect to cathode .....	16 max	volts

#### Typical Operation with 12.6 Volts on Heater (Separate Excitation):

Plate Voltage .....	10.6	12.6	14.6	volts
Grids-No.2-and-No.4 Voltage .....	10.6	12.6	14.6	volts
Grid-No.3 Supply Voltage .....	0	0	0	volts
Grid-No.1 (Oscillator-Grid) Voltage (peak to peak) ...	4.5	4.5	4.5	volts
Grid-No.3 Resistor .....	2.2	2.2	2.2	megohms
Grid-No.1 Resistor .....	33000	33000	33000	ohms
Plate Resistance (Approx.) .....	0.5	0.4	0.2	megohm
Conversion Transconductance .....	-	320	-	$\mu\text{mbos}$
Grid-No.3 Voltage (Approx.) for conversion transconductance of 5 $\mu\text{mbos}$ .....	-	-3	-	volts
Grid-No.3 Voltage (Approx.) for conversion transconductance of 0.5 $\mu\text{mbos}$ .....	-	-4	-	volts
Plate Current .....	-	0.35	-	ma
Grids-No.2-and-No.4 Current .....	-	1.5	-	ma
Grid-No.1 Current .....	-	0.06	-	ma
Total Cathode Current .....	-	1.6	-	ma

#### Maximum Circuit Value:

Grid-No.3-Circuit Resistance .....

10 max megohms

NOTE: The transconductance between grid No.1 and grids No.2 and No.4 connected to plate (not oscillating) is approximately 3600  $\mu\text{mbos}$  under the following conditions: heater at 12.6 volts, grids No.2 and No.4 and plate at 12.6 volts, grids No.1 and No.3 at 0 volts. Under the same conditions, the cathode current is 4.5 ma. and the amplification factor is 9.4.

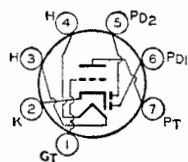

### TWIN DIODE— MEDIUM-MU TRIODE

Miniature types used as combined detector and af voltage amplifier in automobile radio receivers operating from a 12-volt storage battery. Outline 11, OUTLINES SECTION. Tube requires miniature seven-contact socket and may be mounted in any position. Type 12AE6 is a DISCONTINUED type listed for reference only.

## 12AE6 12AE6-A

HEATER-VOLTAGE RANGE (AC/DC) *	10.0 to 15.9	volts
HEATER CURRENT (Approx.) at 12.6 volts .....	0.15	ampere

\*For longest life, it is recommended that the heater be operated within the voltage range of 11 to 14 volts.

### TRIODE UNIT AS CLASS A<sub>1</sub> AMPLIFIER

Maximum Ratings:		
PLATE VOLTAGE .....	30 max	volts
TOTAL CATHODE CURRENT .....	20 max	ma
<b>PEAK HEATER-CATHODE VOLTAGE:</b>		
Heater negative with respect to cathode .....	30 max	volts
Heater positive with respect to cathode .....	30 max	volts

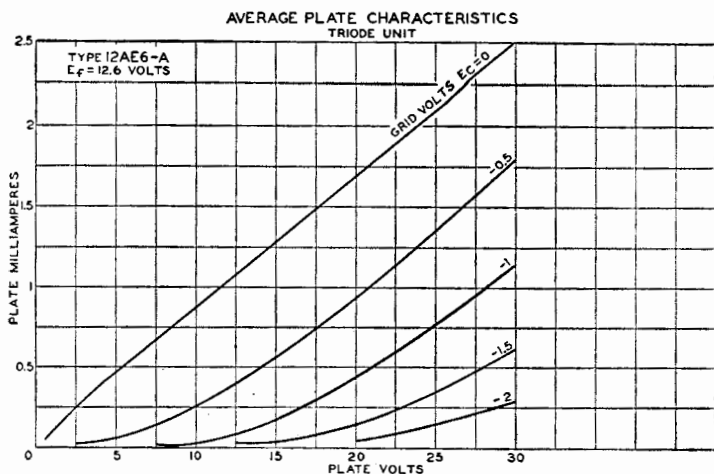

**Characteristics of 12AE6-A with 12.6 Volts on Heater:**

Plate Voltage.....	12.6	12.6	volts
Grid Voltage.....	0	0	volts
Grid Resistor.....	10	-	megohms
Plate Resistance (Approx.).....	20000	13000	ohms
Transconductance.....	715	1300	$\mu$ mhos
Amplification Factor.....	14.3	16.7	
Plate Current.....	0.32	1	ma

**Maximum Circuit Value:**

Grid-Circuit Resistance.....	10 max	megohms
------------------------------	--------	---------

**Maximum Rating:**

PLATE CURRENT (Each Unit).....	1 max	ma
--------------------------------	-------	----

**DUAL TRIODE**

Miniature type with medium- $\mu$  unit and low- $\mu$  unit; used as transistor-driver in audio-output stage of hybrid car radios. Outline 12, OUT-LINES SECTION. Tube requires miniature nine-contact socket and may be operated in any position.

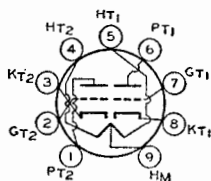

# 12AE7

HEATER VOLTAGE (AC/DC) <sup>o</sup> .....	10 to 15.9	volts
HEATER CURRENT (Approx.), at 12.6 volts.....	0.45	ampere

<sup>o</sup> For longest life, it is recommended that the heater be operated within the voltage range of 11 to 14 volts.

**CLASS A<sub>1</sub> AMPLIFIER**

**Characteristics with 12.6 Volts on Heater:**

	Unit No. 1	Unit No. 2	
Plate Voltage.....	12.6	12.6	volts
Grid Resistor.....	1.5	1	megohms
Amplification Factor.....	13	6.4	
Plate Resistance (Approx.).....	3150	985	ohms
Transconductance.....	4000	6500	$\mu$ mhos
Plate Current.....	1.9	7.5	ma

**AUDIO DRIVER**

**Maximum Ratings, (Each Unit):**

PLATE VOLTAGE.....	16 max	volts	
GRID VOLTAGE, Positive-bias value.....	0 max	volts	
PLATE DISSIPATION.....	1 max	watt	
<b>PEAK HEATER-CATHODE VOLTAGE:</b>			
Heater negative with respect to cathode.....	16 max	volts	
Heater positive with respect to cathode.....	16 max	volts	

**Maximum Circuit Value:**

Grid-Circuit Resistance.....	1.5 max	megohms
------------------------------	---------	---------

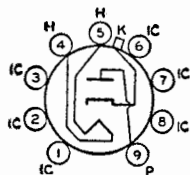

### HALF-WAVE VACUUM RECTIFIER

# 12AF3

Miniature type used as a damper tube in horizontal-deflection circuits of television receivers employing series-connected heater strings. Outline 17, OUTLINES SECTION, except all vertical dimensions of this type are 1/8 inch greater. Heater volts (ac/dc), 12.6; amperes, 0.6; warm-up time (average), 11 seconds. Except for heater rating, this type is identical with miniature type 6AF3.

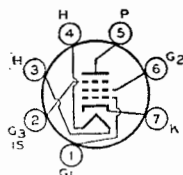

### REMOTE-CUTOFF PENTODE

# 12AF6

Miniature type used as if and rf amplifier in automobile radio receivers operating from a 12-volt storage battery. Outline 11, OUTLINES SECTION. Tube requires miniature seven-contact socket and may be mounted in any position.

HEATER-VOLTAGE RANGE (AC/DC) •	10.0 to 15.9	volts
HEATER CURRENT (Approx.) at 12.6 volts	0.15	amperes
DIRECT INTERELECTRODE CAPACITANCES:		
Grid No.1 to Plate	0.006 max	μfd
Grid No.1 to Cathode, Heater, Grid No.2, Grid No.3, and Internal Shield	5.5	μfd
Plate to Cathode, Heater, Grid No.2, Grid No.3, and Internal Shield..	4.8	μfd

•For longest life, it is recommended that the heater be operated within the voltage range of 11 to 14 volts.

### CLASS A<sub>1</sub> AMPLIFIER

#### Maximum Ratings:

PLATE VOLTAGE	16 max	volts
GRID-NO.3 (SUPPRESSOR GRID)	Connect to cathode at socket	
GRID-NO.2 (SCREEN-GRID) VOLTAGE	16 max	volts
GRID-NO.1 (CONTROL-GRID) VOLTAGE, Positive-bias value	9 max	volts
PEAK HEATER-CATHODE VOLTAGE:		
Heater negative with respect to cathode	16 max	volts
Heater positive with respect to cathode	16 max	volts

#### Characteristics with 12.6 Volts on Heater:

Plate Voltage	12.6	volts
Grid-No.3 and Internal Shield	Connected to cathode at socket	
Grid-No.2 Voltage	12.6	volts
Grid-No.1 Supply Voltage	0	volts
Grid-No.1 Resistor (Bypassed)	2.2	megohms
Plate Resistance (Approx.)	0.35	megohm
Transconductance	1500	μmhos
Grid-No.1 Voltage (Approx.) for transconductance of 10 μmhos*	-3.5	volts
Plate Current	1.1	ma
Grid-No.2 Current	0.45	ma

#### Maximum Circuit Value:

Grid-No.1-Circuit Resistance	2.2 max	megohms
------------------------------	---------	---------

\* With grid No.1 connected to grid No.3 and grid No.1 resistor=0.

### MEDIUM-MU TWIN TRIODE

# 12AH7-GT

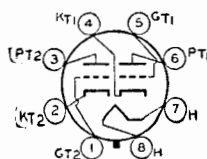

Glass octal tube used as audio amplifier in radio equipment. Outline 22, OUTLINES SECTION, except over-all length is 3-1/16 max inches and seated length is 2-1/2 inches. Tube requires octal socket. Heater volts (ac/dc), 12.6; amperes, 0.15. Characteristics and maximum ratings (each unit) as class A<sub>1</sub> amplifier: plate volts, 180 max; grid volts, -6.5; amplification factor, 16; transconductance, 1900 μmhos; plate resistance (approx.), 8400 ohms; plate ma., 7.6. This type is used principally for renewal purposes.

**TWIN DIODE—  
HIGH-MU TRIODE**

**12AJ6**

Miniature type used as combined detector and af voltage amplifier in automobile radio receivers operating from a 12-volt storage battery. Outline 11, OUTLINES SECTION. Tube requires miniature seven-contact socket. Heater-voltage range (ac/dc), 10 to 15.9 volts; amperes at 12.6 volts, 0.15. Characteristics with heater volts of 12.6 and maximum ratings of triode unit as class A<sub>1</sub> amplifier: plate volts, 12.6 (30

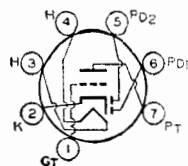

max); grid volts, 0; amplification factor, 55; plate resistance (approx.), 45000 ohms; transconductance, 1200  $\mu$ hos; plate ma., 0.75; total cathode ma., 20 max; peak heater-cathode volts, 30 max. Maximum rating of each diode unit: plate ma., 1 max. This type is used principally for renewal purposes.

**TWIN DIODE**

**12AL5**

Miniature, high-perveance type used as detector in FM and television circuits. It is especially useful as a ratio detector in ac/dc FM receivers. Outline 9, OUTLINES SECTION. Heater volts (ac/dc), 12.6; amperes, 0.15. Except for heater rating, this type is identical with miniature type 6AL5.

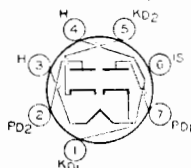

**MEDIUM-MU TRIODE—  
POWER TETRODE**

**12AL8**

Miniature type used in automobile-radio receivers operating from a 12-volt storage battery. The triode unit performs the trigger function and the tetrode unit performs the relay-actuating function in automatic station-selection circuits. The triode unit is also used for AM-signal detection and af amplification; the tetrode unit is used as a driver for a transistorized af power-output stage. Outline 14, OUTLINES SECTION. Tube requires miniature nine-contact socket and may be mounted in any position.

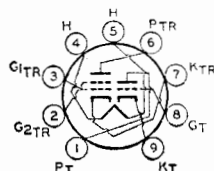

HEATER-VOLTAGE RANGE (AC/DC) •	10.0 to 15.9	volts
HEATER CURRENT (Approx.) at 12.6 volts	0.55	ampere
DIRECT INTERELECTRODE CAPACITANCES:		
Triode Unit:		
Grid to Plate	5.7	$\mu\mu\text{f}$
Grid to Cathode and Heater	1.8	$\mu\mu\text{f}$
Plate to Cathode and Heater	0.4	$\mu\mu\text{f}$
Tetrode Unit:		
Grid No.2 to Plate	14	$\mu\mu\text{f}$
Grid No.2 to Cathode, Heater, and Grid No.1	13	$\mu\mu\text{f}$
Plate to Cathode, Heater, and Grid No.1	1.6	$\mu\mu\text{f}$
Tetrode Grid No.2 to Triode Grid	0.01 max	$\mu\mu\text{f}$

•For longest life, it is recommended that the heater be operated within the voltage range of 11 to 14 volts.

**CLASS A<sub>1</sub> AMPLIFIER**

**Maximum Ratings:**

	Triode Unit	Tetrode Unit	
PLATE VOLTAGE	30 max	30 max	volts
GRID-NO.2 (CONTROL-GRID) VOLTAGE	-	-20 max	volts
GRID-NO.1 (SPACE-CHARGE-GRID) VOLTAGE (Absolute Maximum) ■	-	16 max	volts
CATHODE CURRENT	20 max	-	ma
PEAK HEATER-CATHODE VOLTAGE:			
Heater negative with respect to cathode	30 max	30 max	volts
Heater positive with respect to cathode	30 max	30 max	volts



**Characteristics with 12.6 Volts on Heater:**

	<i>Triode Unit</i>	<i>Tetrode Unit</i>	
Plate Voltage.....	12.6	12.6	volts
Control-Grid Voltage (Developed across 2.2-megohm resistor):			
Grid.....	-0.9	-	volt
Grid-No.2.....	-	-0.5	volt
Grid-No.1 (Space-Charge-Grid) Voltage.....	-	12.6	volts
Amplification Factor:			
Grid to Plate.....	13	-	
Grid No.2 to Plate.....	-	7.2	
Plate Resistance (Approx.).....	13000	480	ohms
Transconductance:			
Grid to Plate.....	1000	-	$\mu$ hos
Grid No.2 to Plate.....	-	15000	$\mu$ hos
Plate Current.....	0.5	40	ma
Grid-No.1 Current.....	-	75	ma

**Maximum Circuit Values:**

	<i>Triode Unit</i>	<i>Tetrode Unit</i>	
Grid No.2-Circuit Resistance.....	-	10 max	megohms
Grid-Circuit Resistance.....	10 max	-	megohms

■ Under no circumstances should this absolute maximum value be exceeded.

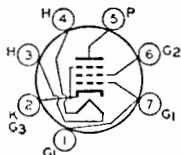

**BEAM POWER TUBE**

Miniature type used as output amplifier primarily in automobile radio receivers operating from a 12-volt storage battery. Outline 13, OUTLINES SECTION. Heater volts

**12AQ5**

(ac/dc), 12.6; amperes, 0.225. Except for heater rating, this type is identical with miniature type 6AQ5. Within its maximum ratings, the performance of the 12AQ5 is equivalent to that of the larger type 12V6-GT.

**TWIN DIODE—  
HIGH-MU TRIODE**

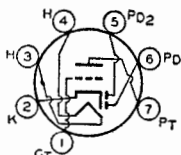

Miniature type used as combined detector, amplifier, and avc tube in compact ac/dc radio receivers. Outline 11, OUTLINES SECTION. Heater volts (ac/dc), 12.6; amperes, 0.15. Except for heater rating, this type is identical with miniature type 6AT6.

**12AT6**

**HIGH-MU TWIN TRIODE**

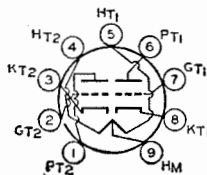

Miniature type used as push-pull cathode-drive amplifier or frequency converter in the FM and television broadcast bands. Outline 12, OUTLINES SECTION. Tube requires

**12AT7**

miniature nine-contact socket and may be mounted in any position. Each triode unit is independent of the other except for the common heater. For typical operation as a resistance-coupled amplifier, refer to RESISTANCE-COUPLED AMPLIFIER SECTION.

HEATER ARRANGEMENT:	<i>Series</i>	<i>Parallel</i>	
HEATER VOLTAGE (AC/DC).....	12.6	6.3	volts
HEATER CURRENT.....	0.15	0.3	ampere

**DIRECT INTERELECTRODE CAPACITANCES:**

Grid-Drive Operation:	<i>Without External Shield</i>	<i>With External Shield*</i>	
Grid to Plate (Each unit).....	1.5	1.5	$\mu$ f
Grid to Cathode and Heater (Each unit).....	2.2	2.2	$\mu$ f
Plate to Cathode and Heater:			
Unit No.1.....	0.5	1.2	$\mu$ f
Unit No.2.....	0.4	1.5	$\mu$ f

**Cathode-Drive Operation:**

Cathode to Plate (Each unit).....	0.2	0.2	$\mu\text{f}$
Cathode to Grid and Heater (Each unit).....	4.6	4.6	$\mu\text{f}$
Plate to Grid and Heater (Each unit).....	1.8	2.6	$\mu\text{f}$
Heater to Cathode (Each unit).....	2.4	2.4	$\mu\text{f}$

▲ With external shield connected to cathode of unit under test except as noted.

■ With external shield connected to grid of unit under test.

● With external shield connected to ground.

**Maximum Ratings:**

**CLASS A<sub>1</sub> AMPLIFIER (Each Unit)**

PLATE VOLTAGE.....	300 max	volts
GRID VOLTAGE, Negative bias value.....	-50 max	volts
PLATE DISSIPATION.....	2.5 max	watts
<b>PEAK HEATER-CATHODE VOLTAGE:</b>		
Heater negative with respect to cathode.....	90 max	volts
Heater positive with respect to cathode.....	90 max	volts

**Characteristics:**

Plate Supply Voltage.....	100	250	volts
Cathode-Bias Resistor.....	270	200	ohms
Amplification Factor.....	60	60	
Plate Resistance (Approx.).....	15000	10900	ohms
Transconductance.....	4000	5500	$\mu\text{mhos}$
Grid Voltage (Approx.) for plate current of 10 $\mu\text{a}$ .....	-5	-12	volts
Plate Current.....	3.7	10	ma

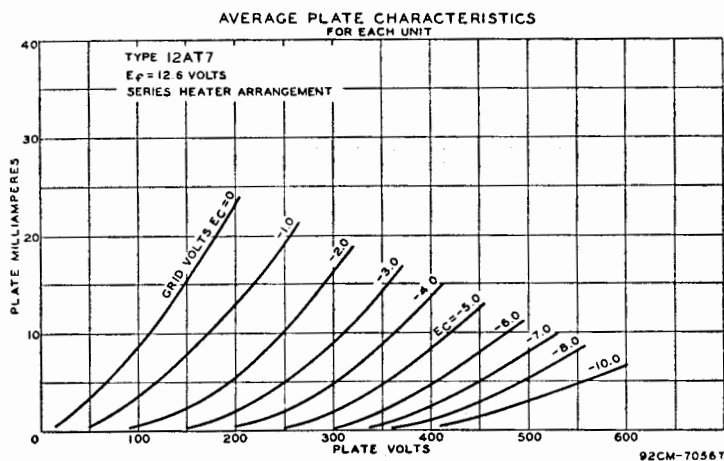

**SHARP-CUTOFF PENTODE**

Miniature type used in compact ac/dc radio equipment as an rf amplifier especially in high-frequency, wide-band applications. Outline 11, OUTLINES SECTION. Heater volts (ac/dc), 12.6; amperes, 0.15. Except for heater rating, this type is identical with miniature type 6AU6.

**12AU6**

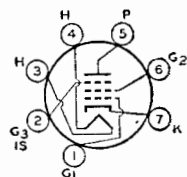

**MEDIUM-MU TWIN TRIODE**

**12AU7  
12AU7-A**

Miniature types used as phase inverter or push-pull amplifier in ac/dc radio equipment and in diversified applications such as multivibrators or oscillators in industrial control devices. Also used as combined vertical oscillator and vertical deflection amplifier,

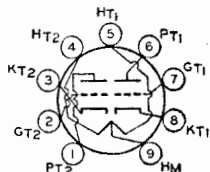

and as horizontal deflection oscillator, in television receivers. The 12AU7-A is also useful in applications critical as to microphonics. Outline 12, OUTLINES SECTION. Tubes require miniature nine-contact socket and may be mounted in any position. Each triode unit is independent of the other except for the common heater. For typical operation as a resistance-coupled amplifier, refer to RESISTANCE-COUPLED AMPLIFIER SECTION. Type 12AU7 is a DISCONTINUED type listed for reference only.

HEATER ARRANGEMENT:	<i>Series</i>	<i>Parallel</i>	
HEATER VOLTAGE (AC/DC).....	12.6	6.3	volts
HEATER CURRENT.....	0.15	0.3	ampere
DIRECT INTERELECTRODE CAPACITANCES for 12AU7-A (Approx.):			
	<i>Unit No.1</i>	<i>Unit No.2</i>	
Grid to Plate.....	1.5	1.5	$\mu$ fd
Grid to Cathode and Heater.....	1.6	1.6	$\mu$ fd
Plate to Cathode and Heater.....	0.5	0.35	$\mu$ fd

**CLASS A<sub>1</sub> AMPLIFIER (Each Unit Unless Otherwise Specified)**

**Maximum Ratings for 12AU7-A, (Design-Maximum Values):**

PLATE VOLTAGE.....		330 <i>max</i>	volts
PLATE DISSIPATION:			
Each Plate.....		2.75 <i>max</i>	watts
Both Plates (Both units operating).....		5.5 <i>max</i>	watts
CATHODE CURRENT.....		22 <i>max</i>	ma
PEAK HEATER-CATHODE VOLTAGE:			
Heater negative with respect to cathode.....		200 <i>max</i>	volts
Heater positive with respect to cathode.....		200 <sup>■</sup> <i>max</i>	volts

\* The dc component must not exceed 100 volts.

**Characteristics for 12AU7-A:**

Plate Voltage.....	100	250	volts
Grid Voltage.....	0	8.5	volts
Amplification Factor.....	19.5	17	
Plate Resistance (Approx.).....	6250	7700	ohms
Transconductance.....	3100	2200	$\mu$ mhos
Plate Current.....	11.8	10.5	ma
Grid Voltage (Approx.) for plate $\mu$ a=10.....	-	-24	volts

**Maximum Circuit Values:**

Grid-Circuit Resistance:			
For fixed-bias operation.....		0.25 <i>max</i>	megohm
For cathode-bias operation.....		1.0 <i>max</i>	megohm

**OSCILLATOR (Each Unit, Unless Otherwise Specified)**

*For operation in a 525-line, 30-frame system*

	<i>Vertical-Deflection Oscillator</i>	<i>Horizontal-Deflection Oscillator</i>	
<b>Maximum Ratings for 12AU7-A, (Design-Maximum Values):</b>			
DC PLATE VOLTAGE.....	330 <i>max</i>	330 <i>max</i>	volts
PEAK NEGATIVE-PULSE GRID VOLTAGE.....	-440 <i>max</i>	-660 <i>max</i>	volts
PEAK CATHODE CURRENT.....	66 <i>max</i>	330 <i>max</i>	ma
AVERAGE CATHODE CURRENT.....	22 <i>max</i>	22 <i>max</i>	ma
PLATE DISSIPATION:			
Each Plate.....	2.75 <i>max</i>	2.75 <i>max</i>	watts
Both Plates (Both units operating).....	5.5 <i>max</i>	5.5 <i>max</i>	watts
PEAK HEATER-CATHODE VOLTAGE:			
Heater negative with respect to cathode.....	200 <i>max</i>	200 <i>max</i>	volts
Heater positive with respect to cathode.....	200 <sup>■</sup> <i>max</i>	200 <sup>■</sup> <i>max</i>	volts

**Maximum Circuit Value:**

Grid-Circuit Resistance.....	2.2 <i>max</i>	2.2 <i>max</i>	megohms
------------------------------	----------------	----------------	---------

**VERTICAL-DEFLECTION AMPLIFIER (Each Unit Unless Otherwise Specified)**

*For operation in a 525-line, 30-frame system*

**Maximum Ratings for 12AU7-A, (Design-Maximum Values):**

DC PLATE VOLTAGE.....		330 <i>max</i>	volts
PEAK POSITIVE-PULSE PLATE VOLTAGE <sup>‡</sup> .....		1200 <i>max</i>	volts
PEAK NEGATIVE-PULSE GRID VOLTAGE.....		-275 <i>max</i>	volts
PEAK CATHODE CURRENT.....		66 <i>max</i>	ma
AVERAGE CATHODE CURRENT.....		22 <i>max</i>	ma
PLATE DISSIPATION:			
Each Plate.....		2.75 <i>max</i>	watts
Both Plates (Both units operating).....		5.5 <i>max</i>	watts
PEAK HEATER-CATHODE VOLTAGE:			
Heater negative with respect to cathode.....		200 <i>max</i>	volts
Heater positive with respect to cathode.....		200 <sup>■</sup> <i>max</i>	volts

**Maximum Circuit Values:**

**Grid-Circuit Resistance:**

For cathode-bias operation . . . . . 2.2 *max* megohms

‡ The duration of the voltage pulse must not exceed 15 per cent of one vertical scanning cycle. In a 525-line, 30-frame system, 15 per cent of one vertical scanning cycle is 2.5 milliseconds.

■ The dc component must not exceed 100 volts.

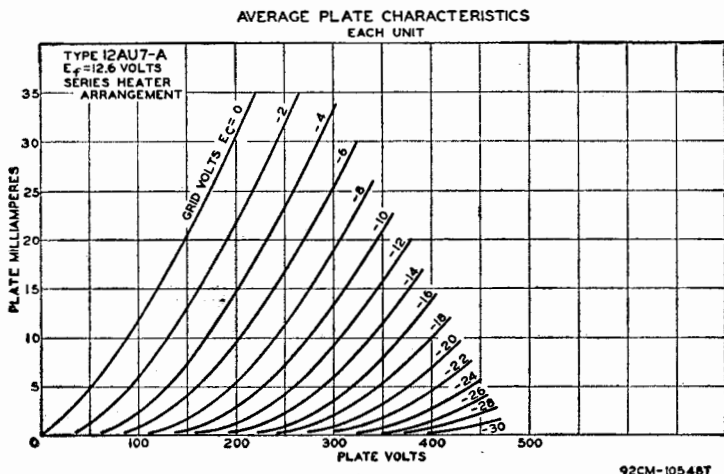

**BEAM POWER TUBE**

**12AV5-GA**

Glass octal type used as horizontal deflection amplifier in television receivers employing series-connected heater strings. Outline 33, OUTLINES SECTION. Heater volts (ac/dc), 12.6; amperes, 0.6; warm-up time (average), 11 seconds. Except for heater rating, this type is identical with glass octal type 6AV5-GA.

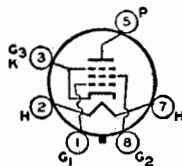

**TWIN DIODE—  
HIGH-MU TRIODE**

**12AV6**

Miniature type used as combined detector, amplifier, and avc tube in automobile and ac-operated receivers. Outline 11, OUTLINES SECTION. Heater volts (ac/dc), 12.6; amperes,

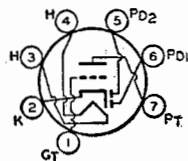

0.15. Except for heater rating, this type is identical with miniature type 6AV6.

**MEDIUM-MU TWIN TRIODE**

**12AV7**

Miniature type used as frequency converter in vhf tuners of television receivers. Also used as rf amplifier, oscillator, or mixer. Outline 12, OUTLINES SECTION. Tube requires miniature nine-contact socket. Heater volts (ac/dc), 12.6 in series arrangement, 6.3 in parallel arrangement; amperes, 0.225 (series), 0.45 (parallel). Maximum ratings as class A<sub>1</sub> amplifier (each unit): plate volts, 300 *max*; negative dc grid

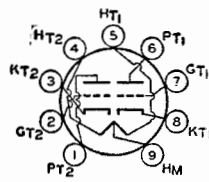

volts, -50 *max*; plate dissipation, 2.7 *max* watts; peak heater-cathode volts, 90 *max*. This type is used principally for renewal purposes.

**Characteristics:**

**CLASS A<sub>1</sub> AMPLIFIER (Each Unit)**

Plate Supply Voltage.....	100	150	volts
Cathode-Bias Resistor.....	120	56	ohms
Amplification Factor.....	37	41	
Plate Resistance (Approx.).....	6100	4800	ohms
Transconductance.....	6100	8500	$\mu$ mhos
Plate Current.....	9	18	ma
Grid Voltage (Approx.) for plate current of 10 $\mu$ a.....	-9	-12	volts

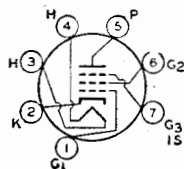

**SHARP-CUTOFF PENTODE**

Miniature type used as an rf or if amplifier up to 400 megacycles in compact ac/dc FM receivers. Outline 11, OUTLINES SECTION. Tube requires miniature seven-contact socket.

**12AW6**

Heater volts (ac/dc), 12.6; amperes, 0.15. Except for heater ratings and terminal connections, this type is identical with miniature type 6AG5.

**HALF-WAVE VACUUM RECTIFIER**

Glass octal types used as damper tubes in horizontal deflection circuits of television receivers. Types 12AX4-GTA and 12AX4-GTB have a controlled heater warm-up time for use in series-connected heater strings. Outline 22, OUTLINES SECTION. These types may be supplied with pin No. 1 omitted. Heater volts (ac/dc), 12.6;

**12AX4-GT**

**12AX4-**

**GTA**

**12AX4-**

**GTB**

amperes, 0.6; warm-up time (average) for 12AX4-GTA and 12AX4-GTB, 11 seconds. Except for heater rating, these types are identical with glass octal type 6AX4-GT. Type 12AX4-GT is a DISCONTINUED type listed for reference only.

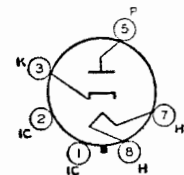

**HIGH-MU TWIN TRIODE**

Miniature types used as phase inverter or twin resistance-coupled amplifier in radio equipment. The 12AX7 is also used in diversified applications such as multivibrators or oscillators in

**12AX7**

**12AX7-A**

industrial control devices. Type 12AX7-A has controlled hum and noise characteristics and is used in high-fidelity audio-amplifier applications. Outline 12, OUTLINES SECTION. Tube requires miniature nine-contact socket and may be mounted in any position. Each triode unit is independent of the other except for common heater. For characteristics and curves, refer to type 6AV6. For typical operation as a resistance-coupled amplifier, refer to RESISTANCE-COUPLED AMPLIFIER SECTION.

**HEATER ARRANGEMENT:**

HEATER VOLTAGE (AC/DC).....	<i>Series</i>	<i>Parallel</i>	
HEATER CURRENT.....	12.6	6.3	volts
	0.15	0.3	ampere

**DIRECT INTERELECTRODE CAPACITANCES (Approx.):<sup>o</sup>**

	<i>Unit No. 1</i>	<i>Unit No. 2</i>	
Grid to Plate (Each unit).....	1.7	1.7	$\mu$ μf
Grid to Cathode and Heater (Each unit).....	1.6	1.6	$\mu$ μf
Plate to Cathode and Heater.....	0.46	0.34	$\mu$ μf

<sup>o</sup>Without external shield.

**CLASS A<sub>1</sub> AMPLIFIER (Each Unit)**

**Maximum Ratings, (Design-Maximum Values):**

PLATE VOLTAGE.....	330 <i>max</i>	volts
PLATE DISSIPATION.....	1.2 <i>max</i>	watts
GRID VOLTAGE:		
Negative-bias value.....	-55 <i>max</i>	volts
Positive-bias value.....	0 <i>max</i>	volts
PEAK HEATER-CATHODE VOLTAGE:		
Heater negative with respect to cathode.....	200 <i>max</i>	volts
Heater positive with respect to cathode.....	200 <i>max</i>	volts

\*The dc component must not exceed 100 volts.

**Equivalent Noise and Hum Voltage, (Reference to Grid, Each Unit):\***

Average Value.....	18	μvolts rms
--------------------	----	------------

\* Measured in "true rms" units under the following conditions: Heater voltage (parallel connection), 6.3 volts ac; center tap of heater transformer grounded; plate supply voltage, 250 volts dc; plate load resistor, 100000 ohms; cathode resistor, 2700 ohms bypassed by 100-μf capacitor; grid resistor, 0 ohms; and amplifier covering frequency range between 25 and 10000 cps.

**HALF-WAVE VACUUM RECTIFIER**

# 12AY3

Novar type used as damper tube in horizontal-deflection circuits of black-and-white television receivers. Tube has controlled warm-up time for use in series-connected heater strings.

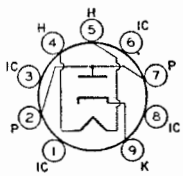

Outline 54, OUTLINES SECTION. Heater volts (ac/dc), 12.6; amperes, 0.6; warm-up time (average), 11 seconds. Except for heater rating, this type is identical with novar type 6AY3.

**MEDIUM-MU TWIN TRIODE**

# 12AY7

Miniature type used in the first stages of high-gain audio-frequency amplifiers where reduction of microphonics, leakage noise, and hum are primary considerations. Outline 12,

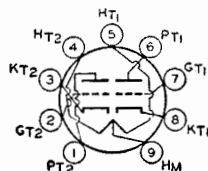

OUTLINES SECTION. Tube requires miniature nine-contact socket and may be mounted in any position. Each triode unit is independent of the other except for the common heater. Use of the 12.6-volt connection with an ac heater supply is not recommended for applications involving low hum. For typical operation as a resistance-coupled amplifier, refer to RESISTANCE-COUPLED AMPLIFIER SECTION.

HEATER ARRANGEMENT:	Series	Parallel	
HEATER VOLTAGE (AC/DC).....	12.6	6.3	volts
HEATER CURRENT.....	0.15	0.3	ampere
AMPLIFICATION FACTOR (Each unit)*.....		44	
PLATE RESISTANCE (Each unit, approx.)*.....		25000	ohms
TRANSCONDUCTANCE*.....		1750	μmhos

\* For plate volts, 250; grid volts, -4; plate ma., 3.

**CLASS A<sub>1</sub> AMPLIFIER (Each Unit)**

**Maximum Ratings:**

PLATE VOLTAGE.....	300 <i>max</i>	volts
GRID VOLTAGE:		
Negative bias value.....	-50 <i>max</i>	volts
Positive bias value.....	0 <i>max</i>	volts
PLATE DISSIPATION.....	1.5 <i>max</i>	watts
CATHODE CURRENT.....	10 <i>max</i>	ma
PEAK HEATER-CATHODE VOLTS:		
Heater negative with respect to cathode.....	90 <i>max</i>	volts
Heater positive with respect to cathode.....	90 <i>max</i>	volts

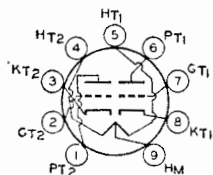

### HIGH-MU TWIN TRIODE

Miniature types used in direct-coupled cathode-drive rf amplifier circuits of vhf television tuners. Outline 12, OUTLINES SECTION. Tubes require miniature nine-contact socket

# 12AZ7 12AZ7-A

and may be mounted in any position. Heater volts (ac/dc): 12.6 in series arrangement, 6.3 in parallel arrangement; amperes, 0.225 (series), 0.45 (parallel); warm-up time (average), 12AZ7-A, 11 seconds. For characteristics, class A<sub>1</sub> amplifier, refer to miniature type 12AT7.

**DIRECT INTERELECTRODE CAPACITANCES (Approx.):**

	Without External Shield	With External Shield <sup>a</sup>	
Grid to Plate (Each unit).....	2	1.9	μf
Grid to Cathode and Heater (Each unit).....	2.6	2.8	μf
Plate to Cathode and Heater:			
Unit No.1.....	0.44	1.4	μf
Unit No.2.....	0.36	1.6	μf

<sup>a</sup> With external shield connected to cathode of unit under test.

**CLASS A<sub>1</sub> AMPLIFIER (Each Unit)**

	12AZ7 Design-Center Values	12AZ7-A Design-Maximum Values	
Maximum Ratings:			
PLATE VOLTAGE.....	300 max	330 max	volts
GRID VOLTAGE, Negative-bias value.....	-50 max	-55 max	volts
PLATE DISSIPATION.....	2.5 max	2.5 max	watts
PEAK HEATER-CATHODE VOLTAGE:			
Heater negative with respect to cathode.....	200 max	200 max	volts
Heater positive with respect to cathode.....	200 <sup>o</sup> max	200 <sup>o</sup> max	volts

<sup>o</sup> The dc component must not exceed 100 volts.

**Maximum Circuit Values (Each Unit):**

Grid-Circuit Resistance:			
For fixed-bias operation.....		0.25 max	megohm
For cathode-bias operation.....		1 max	megohm

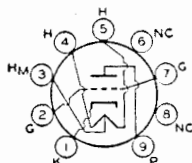

### LOW-MU TRIODE

Miniature type having high permeance used as vertical deflection amplifier in television receivers. This type has a controlled heater warm-up time for use in series-connected heater

# 12B4-A

strings. Outline 14, OUTLINES SECTION. Tube requires miniature nine-contact socket and may be mounted in any position.

	Series	Parallel	
HEATER ARRANGEMENT:			
HEATER VOLTAGE (AC/DC).....	12.6	6.3	volts
HEATER CURRENT.....	0.3	0.6	ampere
HEATER WARM-UP TIME (Average).....	-	11	seconds

**CLASS A<sub>1</sub> AMPLIFIER**

Maximum Ratings:			
PLATE VOLTAGE.....		550 max	volts
GRID VOLTAGE, Negative-bias value.....		-50 max	volts
PLATE DISSIPATION.....		5.5 max	watts
PEAK HEATER-CATHODE VOLTAGE:			
Heater negative with respect to cathode.....		200 max	volts
Heater positive with respect to cathode.....		200 <sup>o</sup> max	volts
Characteristics:			
Plate Voltage.....		150	volts
Grid Voltage.....		-17.5	volts
Amplification Factor.....		6.5	
Plate Resistance (Approx.).....		1030	ohms
Transconductance.....		6300	μmhos
Plate Current.....		34	ma
Grid Voltage (Approx.) for plate current of 200 μa.....		-32	volts
Plate Current for grid voltage of -23 volts.....		9.6	ma

**Maximum Circuit Values:**

Grid-Circuit Resistance:		
For fixed-bias operation.....	0.47 max	megohm
For cathode-bias operation.....	2.2 max	megohms

**VERTICAL DEFLECTION AMPLIFIER**  
For operation in a 525-line, 30-frame system

**Maximum Ratings:**

DC PLATE VOLTAGE.....	550 max	volts
PEAK POSITIVE-PULSE PLATE VOLTAGE# (Absolute Maximum).....	1000†max	volts
PEAK NEGATIVE-PULSE GRID VOLTAGE.....	-250 max	volts
PEAK CATHODE CURRENT.....	105 max	ma
AVERAGE CATHODE CURRENT.....	30 max	ma
PLATE DISSIPATION.....	5.5 max	watts
<b>PEAK HEATER-CATHODE VOLTAGE:</b>		
Heater negative with respect to cathode.....	200 max	volts
Heater positive with respect to cathode.....	200°max	volts

**Maximum Circuit Value:**

Grid-Circuit Resistance:		
For cathode-bias operation.....	2.2 max	megohms

#The duration of the voltage pulse must not exceed 15 per cent of one vertical scanning cycle. In a 525-line, 30-frame system, 15 per cent of one vertical scanning cycle is 2.5 milliseconds.

† Under no circumstances should this absolute value be exceeded.

° The dc component must not exceed 100 volts.

**TRIODE—PENTODE**

Glass octal type used as combined detector and rf or if amplifier in ac/dc receivers. Heater volts (ac/dc), 12.6; amperes, 0.3. Characteristics of triode unit: plate volts, 90; grid volts, 0; amplification factor, 90; plate resistance, 37000 ohms; transconductance, 2400  $\mu$ hos; plate ma., 2.8. Characteristics of pentode unit: plate volts, 90; grid-No.2 volts, 90; grid-No.1 volts,

-3; plate resistance, 200000 ohms; transconductance, 1800  $\mu$ hos; plate ma., 7; grid-No.2 ma., 2. This is a DISCONTINUED type listed for reference only.

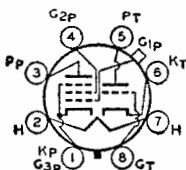

**12B8-GT**

**REMOTE-CUTOFF PENTODE**

Miniature type used as rf amplifier in ac/dc standard broadcast receivers, in FM receivers, and in other wide-band, high-frequency applications. Outline 11, OUTLINES SEC-

TION. Heater volts (ac/dc), 12.6; amperes, 0.15. Except for heater ratings, this type is identical with miniature type 6BA6.

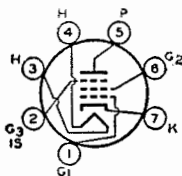

**12BA6**

**PENTAGRID CONVERTER**

Miniature type used as converter in ac/dc superheterodyne circuits especially those for the FM broadcast band. Outline 14, OUTLINES SECTION. Heater volts (ac/dc), 12.6; amperes, 0.15. Except for heater rating, this type is identical with miniature type 6BA7. Type 12BA7 is used principally for renewal purposes.



**12BA7**

**REMOTE-CUTOFF PENTODE**

Miniature type used as rf or if amplifier in radio receivers. Outline 11, OUTLINES SECTION. Heater volts (ac/dc), 12.6; amperes, 0.15. Except for heater rating, this type is identical with miniature type 6BD6. Type 12BD6 is used principally for renewal purposes.

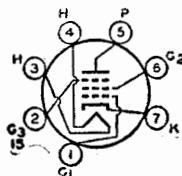

**12BD6**



**PENTAGRID CONVERTER**

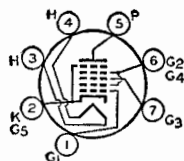

Miniature type used as converter in ac/dc receivers for both standard broadcast and FM bands. Outline 11, OUTLINES SECTION. Heater volts (ac/dc), 12.6; amperes, 0.15. Except for heater rating, this type is identical with miniature type 6BE6.

**12BE6**

**TWIN DIODE—  
MEDIUM-MU TRIODE**

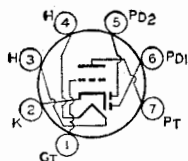

Miniature type used as combined detector, amplifier, and avc tube primarily in automobile radio receivers operating from a 12-volt storage battery. Outline 11, OUTLINES SECTION.

**12BF6**

Heater volts (ac/dc), 12.6; amperes, 0.15. Except for heater rating, this type is identical with miniature type 6BF6.

**MEDIUM-MU TWIN TRIODE**

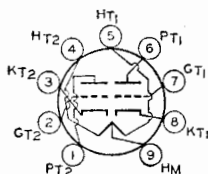

Miniature types used as combined vertical deflection amplifiers and vertical oscillators, and as horizontal deflection oscillators, in television receivers. Type 12BH7-A has a controlled

**12BH7  
12BH7-A**

heater warm-up time for use in series-connected heater strings. These types are also used in other applications including phase-inverter circuits and multivibrator circuits. Outline 14, OUTLINES SECTION. Tubes require miniature nine-contact socket and may be mounted in any position. Each triode unit is independent of the other except for the common heater. Type 12BH7 is a DISCONTINUED type listed for reference only.

HEATER ARRANGEMENT:	<i>Series</i>	<i>Parallel</i>	
HEATER VOLTAGE (AC/DC) .....	12.6	6.3	volts
HEATER CURRENT .....	0.3	0.6	ampere
HEATER WARM-UP TIME (Average) for 12BH7-A .....	—	11	seconds
DIRECT INTERELECTRODE CAPACITANCES (Approx.):	<i>Unit No.1</i>	<i>Unit No.2</i>	
Grid to Plate .....	2.6	2.6	μf
Grid to Cathode and Heater .....	3.2	3.2	μf
Plate to Cathode and Heater .....	0.5	0.4	μf
Plate of Unit No.1 to Plate of Unit No.2 .....		0.8	μf

**CLASS A<sub>1</sub> AMPLIFIER (Each Unit)**

<b>Maximum Ratings:</b>		
PLATE VOLTAGE .....	300 max	volts
GRID VOLTAGE:		
Negative-bias value .....	-50 max	volts
Positive-bias value .....	0 max	volts
CATHODE CURRENT .....	20 max	ma
PLATE DISSIPATION:		
Each Plate .....	3.5 max	watts
Both Plates (Both units operating) .....	7 max	watts
PEAK HEATER-CATHODE VOLTAGE:		
Heater negative with respect to cathode .....	200 max	volts
Heater positive with respect to cathode .....	200 max	volts

■ The dc component must not exceed 100 volts.

### Characteristics:

Plate Voltage.....	250	volts
Grid Voltage.....	-10.5	volts
Amplification Factor.....	16.5	
Plate Resistance (Approx.).....	5300	ohms
Transconductance.....	3100	μmhos
Grid Voltage (Approx.) for plate current of 50 μa.....	-23	volts
Plate Current.....	11.5	ma
Plate Current for grid voltage of -14 volts.....	4	ma

### Maximum Circuit Values:

Grid-Circuit Resistance:		
For fixed-bias operation.....	0.25 max	megohm
For cathode-bias operation.....	1.0 max	megohm

### OSCILLATOR (Each Unit)

*For operation in a 525-line, 30-frame system*

Maximum Ratings:	Vertical Deflection Oscillator	Horizontal Deflection Oscillator	
DC PLATE VOLTAGE.....	450 max	450 max	volts
PEAK NEGATIVE-PULSE GRID VOLTAGE.....	-400 max	-600 max	volts
PEAK CATHODE CURRENT.....	70 max	300 max	ma
AVERAGE CATHODE CURRENT.....	20 max	20 max	ma
PLATE DISSIPATION:			
Each Plate.....	3.5 max	3.5 max	watts
Both Plates (Both units operating).....	7 max	7 max	watts
PEAK HEATER-CATHODE VOLTAGE:			
Heater negative with respect to cathode.....	200 max	200 max	volts
Heater positive with respect to cathode.....	200° max	200° max	volts

### Maximum Circuit Values:

Grid-Circuit Resistance.....	2.2 max	2.2 max	megohms
------------------------------	---------	---------	---------

### VERTICAL DEFLECTION AMPLIFIER (Each Unit)

*For operation in a 525-line, 30-frame system*

Maximum Ratings:		
DC PLATE VOLTAGE.....	450 max	volts
PEAK POSITIVE-PULSE PLATE VOLTAGE# (Absolute maximum).....	1500 max	volts
PEAK NEGATIVE-PULSE GRID VOLTAGE.....	-250 max	volts
PEAK CATHODE CURRENT.....	70 max	ma
AVERAGE CATHODE CURRENT.....	20 max	ma
PLATE DISSIPATION:		
Each Plate.....	3.5 max	watts
Both Plates (Both units operating).....	7 max	watts
PEAK HEATER-CATHODE VOLTAGE:		
Heater negative with respect to cathode.....	200 max	volts
Heater positive with respect to cathode.....	200° max	volts

### Maximum Circuit Value:

Grid-Circuit Resistance:	
For cathode-bias operation.....	2.2 max megohms

# The duration of the voltage pulse must not exceed 15 per cent of one vertical scanning cycle. In a 525-line, 30-frame system, 15 per cent of one vertical scanning cycle is 2.5 milliseconds.

• Under no circumstances should this absolute value be exceeded.

° The dc component must not exceed 100 volts.

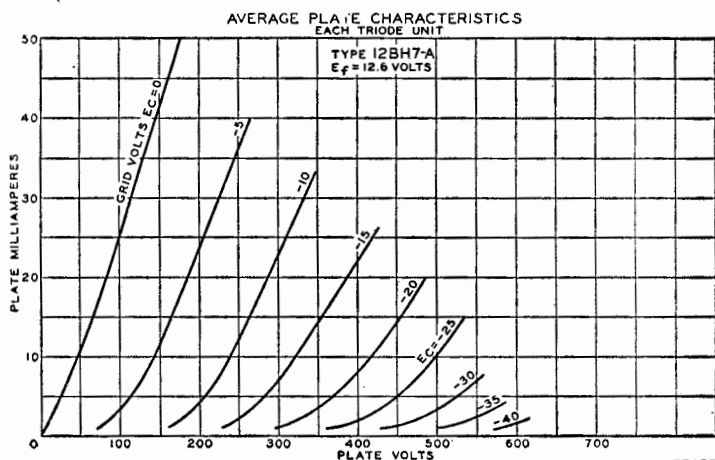

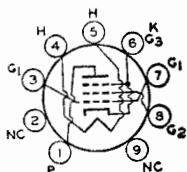

**BEAM POWER TUBE**

**12BK5**

Miniature type used in audio output stages of television and radio receivers employing series-connected heater strings. Outline 14, OUTLINES SECTION. Heater volts (ac/dc), 12.6; amperes, 0.6; warm-up time (average), 11 seconds. Peak heater-cathode volts, 200 max. When the heater is positive with respect to the cathode, the dc component of the heater-cathode voltage must not exceed 100 volts. Except

for heater and heater-cathode ratings, this type is identical with miniature type 6BK5. Type 12BK5 is used principally for renewal purposes.

**REMOTE-CUTOFF PENTODE**

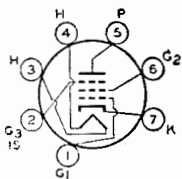

**12BL6**

Miniature type used as if and rf amplifier in automobile radio receivers operating from a 12-volt storage battery. Outline 11, OUTLINES SECTION. Tube requires miniature seven-contact socket and may be mounted in any position.

HEATER-VOLTAGE RANGE (AC/DC)*	10.0 to 15.9	volts
HEATER CURRENT (Approx.)	0.15	ampere

\* For longest life, it is recommended that the heater be operated within the voltage range of 11 to 14 volts.

**DIRECT INTERELECTRODE CAPACITANCES\***

Grid No.1 to Plate	0.006 max	$\mu\text{f}$
Grid No.1 to Cathode, Heater, Grid No.2, Grid No.3, and Internal Shield	5.5	$\mu\text{f}$
Plate to Cathode, Heater, Grid No.2, Grid No.3, and Internal Shield	4.8	$\mu\text{f}$

\* With external shield connected to cathode.

**Maximum Ratings:**

**CLASS A<sub>1</sub> AMPLIFIER**

PLATE VOLTAGE	30 max	volts
Grid No.3 (SUPPRESSOR GRID)	Connect to cathode at socket	
Grid-No.2 (SCREEN-GRID) VOLTAGE	30 max	volts
Grid-No.1 (CONTROL-GRID) VOLTAGE, Positive bias value	0 max	volts
CATHODE CURRENT	20 max	ma
<b>PEAK HEATER-CATHODE VOLTAGE:</b>		
Heater negative with respect to cathode	30 max	volts
Heater positive with respect to cathode	30 max	volts

**Typical Operation with 12.6 Volts on Heater:**

Plate Voltage	12.6	volts
Grid No.3 and Internal Shield	Connected to cathode at socket	
Grid-No.2 Voltage	12.6	volts
Grid-No.1 Supply Voltage	0	volts
Grid-No.1 Resistor	2.2	megohms
Plate Resistance (Approx.)	0.5	megohm
Transconductance	1350	$\mu\text{mhos}$
Grid-No.1 Voltage (Approx.) for transconductance of 10 $\mu\text{mhos}$	-6	volts
Grid-No.1 and Grid-No.3 Voltage (Approx.) for transconductance of 10 $\mu\text{mhos}$	-5	volts
Plate Current	1.35	ma
Grid-No.2 Current	0.5	ma

**Maximum Circuit Value:**

Grid-No.1-Circuit Resistance	10 max	megohms
------------------------------	--------	---------

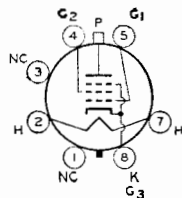

**BEAM POWER TUBE**

**12BQ6-GTB  
/12CU6**

Glass octal type used as horizontal deflection amplifier in television receivers employing series-connected heater strings. Outline 30, OUTLINES SECTION. This type may be supplied

with pin No.1 omitted. Heater volts (ac/dc), 12.6; amperes, 0.6; warm-up time (average), 11 seconds. Except for heater rating, this type is identical with glass octal type 6BQ6-GTB 6CU6.

**TWIN DIODE—HIGH-MU TRIODE**

**12BR7**

Miniature type used as combined sync separator and horizontal phase detector in television receivers. Outline 12, OUTLINES SECTION. Tube requires miniature nine-contact socket and may be mounted in any position. Heater volts (ac/dc): 12.6 in series arrangement, 6.3 in parallel arrangement; amperes, 0.225 (series), 0.45 (parallel). For maximum ratings, characteristics, and curves for triode unit, refer to type 12AT7. Type 12BR7 is used principally for renewal purposes.

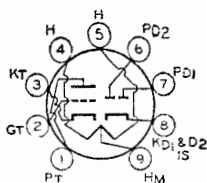

**Maximum Ratings, (Each Unit):**

**DIODE UNITS**

PEAK INVERSE PLATE VOLTAGE.....	300 <i>max</i>	volts
PEAK PLATE CURRENT.....	60 <i>max</i>	ma
PEAK HEATER-CATHODE VOLTAGE:		
Heater negative with respect to cathode.....	200 <i>max</i>	volts
Heater positive with respect to cathode.....	200 <i>max</i>	volts

■ The dc component must not exceed 100 volts.

**SHARP-CUTOFF PENTODE**

**12BV7**

Miniature type used as video amplifier in television receivers. Outline 14, OUTLINES SECTION. Tube requires miniature nine-contact socket and may be mounted in any position. Heater volts (ac/dc), 12.6 in series arrangement, 6.3 in parallel arrangement; amperes, 0.3 (series), 0.6 (parallel). This type is used principally for renewal purposes.

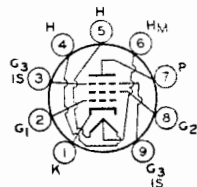

**Maximum Ratings:**

**CLASS A<sub>1</sub> AMPLIFIER**

PLATE VOLTAGE.....	300 <i>max</i>	volts
GRID No.3 (SUPPRESSOR GRID).....	Connect to cathode at socket	
GRID-No.2 (SCREEN-GRID) VOLTAGE.....	175 <i>max</i>	volts
GRID-No.1 (CONTROL-GRID) VOLTAGE. Negative bias value.....	-50 <i>max</i>	volts
GRID-No.2 INPUT.....	1 <i>max</i>	watt
PLATE DISSIPATION.....	6.25 <i>max</i>	watts
PEAK HEATER-CATHODE VOLTAGE:		
Heater negative with respect to cathode.....	200 <i>max</i>	volts
Heater positive with respect to cathode.....	200 <i>max</i>	volts

**Maximum Circuit Values:**

Grid-No.1-Circuit Resistance:		
For fixed-bias operation.....	0.25 <i>max</i>	megohm
For cathode-bias operation.....	1.0 <i>max</i>	megohm

■ The dc component must not exceed 100 volts.

**FULL-WAVE VACUUM RECTIFIER**

**12BW4**

Miniature type used in full-wave power supplies having high dc output current requirements. Outline 14, OUTLINES SECTION. Type 12BW4 requires miniature nine-contact socket

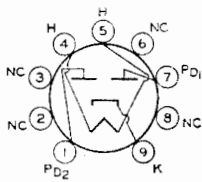

and may be mounted in any position. Heater volts (ac/dc), 12.6; amperes 0.45. It is especially important that this tube, like other power-handling tubes, be adequately ventilated. Except for heater rating, this type is identical with miniature type 6BW4.

**SHARP-CUTOFF PENTODE**

**12BY7**  
**12BY7-A**

Miniature types used as video amplifier in television receivers. Type 12BY7-A has a controlled heater warm-up time for use in series-connected heater strings. Outline 14,

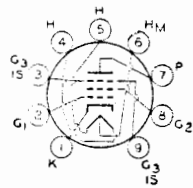

OUTLINES SECTION. Tubes require miniature nine-contact socket and may be mounted in any position. Type 12BY7 is a DISCONTINUED type listed for reference only.

HEATER ARRANGEMENT:	<i>Series</i>	<i>Parallel</i>	
HEATER VOLTAGE (AC/DC) .....	12.6	6.3	volts
HEATER CURRENT .....	0.3	0.6	ampere
HEATER WARM-UP TIME (Average) for 12BY7-A .....	—	11	seconds
DIRECT INTERELECTRODE CAPACITANCES:			
Grid No.1 to Plate .....		0.063	$\mu$ f
Grid No.1 to Cathode, Heater, Grid No.2, Grid No.3, and Internal Shield .....		10.2	$\mu$ f
Plate to Cathode, Heater, Grid No.2, Grid No.3, and Internal Shield .....		3.5	$\mu$ f

### Maximum Ratings:

### CLASS A<sub>1</sub> AMPLIFIER

PLATE SUPPLY VOLTAGE .....	300 <i>max</i>	volts
GRID No.3 (SUPPRESSOR GRID) .....	Connect to cathode at socket	
GRID-No.2 (SCREEN-GRID) VOLTAGE .....	180 <i>max</i>	volts
GRID-No.1 (CONTROL-GRID) VOLTAGE:		
Negative bias value .....	-50 <i>max</i>	volts
Positive bias value .....	0 <i>max</i>	volts
GRID-No.2 INPUT .....	1.1 <i>max</i>	watts
PLATE DISSIPATION .....	6.5 <i>max</i>	watts
PEAK HEATER-CATHODE VOLTAGE:		
Heater negative with respect to cathode .....	200 <i>max</i>	volts
Heater positive with respect to cathode .....	200 <sup>2</sup> <i>max</i>	volts

### Characteristics:

Plate Supply Voltage .....	250	volts
Grid No.3 and Internal Shield .....	Connected to cathode at socket	
Grid-No.2 Supply Voltage .....	180	volts
Cathode-Bias Resistor .....	100	ohms
Plate Resistance (Approx.) .....	93000	ohms
Transconductance .....	11000	$\mu$ mbos
Plate Current .....	26	ma
Grid-No.2 Current .....	5.75	ma
Grid-No.1 Voltage (Approx.) for plate current of 20 $\mu$ a .....	-11.6	volts

### Maximum Circuit Values:

Grid-No.1-Circuit Resistance:		
For fixed-bias operation .....	0.25 <i>max</i>	megohm
For cathode-bias operation .....	1 <i>max</i>	megohm

The dc component must not exceed 100 volts.

### AVERAGE PLATE CHARACTERISTICS

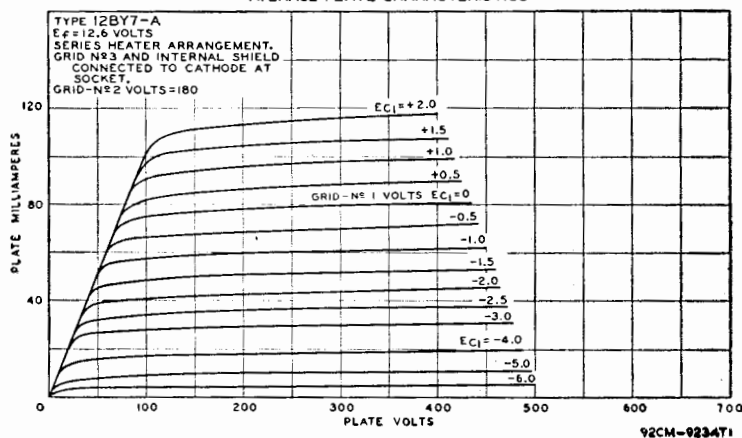

92CM-9234T1

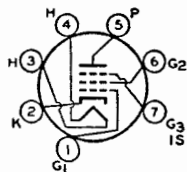

### SEMIREMOTE-CUTOFF PENTODE

# 12BZ6

Miniature type used in gain-controlled video if stages of television receivers. Outline 11, OUTLINES SECTION. Tube requires miniature seven-contact socket and may be mounted in any position. Heater volts (ac/dc), 12.6; amperes, 0.15. Except for heater rating, this type is identical with miniature type 6BZ6.

### HIGH-MU TWIN TRIODE

# 12BZ7

Miniature type used in sync-separator and sync-amplifier circuits of television receivers. This tube is also used in clipping circuits and in general-purpose audio amplifier applications.

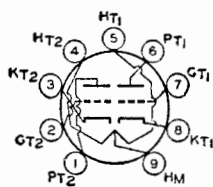

Outline 14, OUTLINES SECTION. Tube requires miniature nine-contact socket and may be mounted in any position.

HEATER ARRANGEMENT:	Series	Parallel	
HEATER VOLTAGE (AC/DC)	12.6	6.3	volts
HEATER CURRENT	0.3	0.6	ampere
<b>Maximum Ratings:</b>			
<b>CLASS A<sub>1</sub> AMPLIFIER (Each Unit)</b>			
PLATE VOLTAGE		300 max	volts
GRID VOLTAGE:			
Negative-bias value		-50 max	volts
Positive-bias value		0 max	volts
PLATE DISSIPATION		1.5 max	watts
PEAK HEATER-CATHODE VOLTAGE:			
Heater negative with respect to cathode		180 max	volts
Heater positive with respect to cathode		180 max	volts
<b>Characteristics:</b>			
Plate Voltage		250	volts
Grid Voltage		-2	volts
Amplification Factor		100	
Plate Resistance (Approx.)		31800	ohms
Transconductance		3200	μmhos
Plate Current		2.5	ma
<b>Maximum Circuit Value:</b>			
Grid-Circuit Resistance:			
For contact-potential-bias operation			5 max megohms

# 12C5

Refer to type 12CU5/12C5

### TWIN DIODE— SEMIREMOTE-CUTOFF PENTODE

# 12C8

Metal type used as combined detector, amplifier, and avc tube in ac/dc receivers. Outline 4, OUTLINES SECTION. Heater volts (ac/dc), 12.6; amperes, 0.15. Except for heater rating, this type is identical with metal type 6B8. Type 12C8 is used principally for renewal purposes.

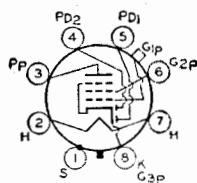

### BEAM POWER TUBE

# 12CA5

Miniature type used in the audio output stages of television receivers. This type has a controlled heater warm-up time for use in series-connected heater strings. Outline 13,

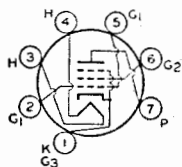

OUTLINES SECTION. Tube requires miniature seven-contact socket and may be mounted in any position.

HEATER VOLTAGE (AC/DC)	12.6	volts
HEATER CURRENT	0.6	ampere
HEATER WARM-UP TIME (Average)	11	seconds
<b>DIRECT INTERELECTRODE CAPACITANCES (Approx.):</b>		
Grid No.1 to Plate	0.5	μf
Grid No.1 to Cathode, Heater, Grid No.2, and Grid No.3	15	μf
Plate to Cathode, Heater, Grid No.2, and Grid No.3	9	μf
<b>Maximum Ratings:</b>		
<b>CLASS A<sub>1</sub> AMPLIFIER</b>		
PLATE VOLTAGE	130 max	volts
GRID-NO.2 (SCREEN-GRID) VOLTAGE	130 max	volts
GRID-NO.1 (CONTROL-GRID) VOLTAGE, Positive bias value	0 max	volts
PLATE DISSIPATION	5 max	watts
GRID-NO.2 INPUT	1.4 max	watts
PEAK HEATER-CATHODE VOLTAGE:		
Heater negative with respect to cathode	300 max	volts
Heater positive with respect to cathode	200 max	volts
BULB TEMPERATURE (At hottest point)	180 max	°C

### Typical Operation:

Plate Voltage	110	125	volts
Grid-No.2 Voltage	110	125	volts
Grid-No.1 Voltage	-4.0	-4.5	volts
Peak AF Grid-No.1 Voltage	4.0	4.5	volts
Zero-Signal Plate Current	32	37	ma
Maximum-Signal Plate Current	31	36	ma
Zero-Signal Grid-No.2 Current	3.5	4	ma
Maximum-Signal Grid-No.2 Current	7.5	11	ma
Plate Resistance (Approx.)	16000	15000	ohms
Transconductance	8100	9200	$\mu$ mb/s
Load Resistance	3500	4500	ohms
Total Harmonic Distortion	5	6	per cent
Maximum-Signal Power Output	1.1	1.5	watts

### Maximum Circuit Values:

Grid-No.1-Circuit Resistance			
For fixed-bias operation		0.1 max	megohm
For cathode-bias operation		0.5 max	megohm

- ▲ The dc component must not exceed 200 volts.
- The dc component must not exceed 100 volts.

### AVERAGE PLATE CHARACTERISTICS

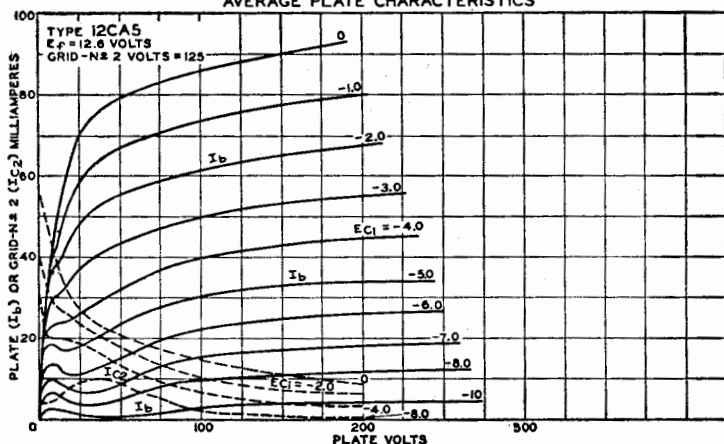

92CM-6507T

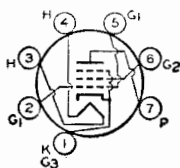

### REMOTE-CUTOFF PENTODE

Miniature type used as if amplifier in automobile radio receivers operating from a 12-volt storage battery. Outline 13, OUTLINES SECTION. Tube requires miniature seven-contact socket and may be mounted in any position. Heater voltage range (ac/dc), 10 to 15.9; amperes, at 12.6 volts, 0.45. This type is used principally for renewal purposes.

## 12CN5

### Maximum Ratings:

PLATE VOLTAGE	16 max	volts
GRID-NO.2 (SCREEN-GRID) VOLTAGE	16 max	volts
GRID-NO.1 (CONTROL-GRID) VOLTAGE, Positive bias value	0 max	volts
PEAK HEATER-CATHODE VOLTAGE:		
Heater negative with respect to cathode	16 max	volts
Heater positive with respect to cathode	16 max	volts

### CLASS A<sub>1</sub> AMPLIFIER

### Characteristics with 12.6 Volts on Heater:

Plate Voltage	12.6	volts
Grid-No.2 Voltage	12.6	volts
Grid-No.1 Supply Voltage	0	volts
Grid-No.1 Resistor (Bypassed)	2.2	megohms
Plate Resistance (Approx.)	40000	ohms
Transconductance	3800	$\mu$ mhos
Plate Current	4.5	ma
Grid-No.2 Current	3.5	ma

### Maximum Circuit Value:

Grid-No.1-Circuit Resistance	2.2 max	megohms
------------------------------	---------	---------

**DIODE—  
REMOTE-CUTOFF PENTODE**

**12CR6**

Miniature type used as combined detector and audio amplifier in automobile and ac-operated radio receivers. The diode unit is used as an AM detector, and the pentode unit as an

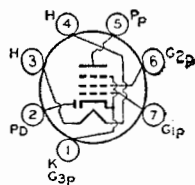

automatic-volume-controlled audio amplifier. Outline 11, OUTLINES SECTION. Tube requires miniature seven-contact socket and may be mounted in any position.

HEATER VOLTAGE (AC/DC).....	12.6	volts
HEATER CURRENT.....	0.15	ampere

**PENTODE UNIT AS CLASS A<sub>1</sub> AMPLIFIER**

**Maximum Ratings:**

PLATE VOLTAGE.....	300 <i>max</i>	volts
GRID-NO.2 (SCREEN-GRID) VOLTAGE.....	See curve page 66	
GRID-NO.2 SUPPLY VOLTAGE.....	300 <i>max</i>	volts
GRID-NO.1 (CONTROL-GRID) VOLTAGE, Positive-bias value.....	0 <i>max</i>	volts
PLATE DISSIPATION.....	2.5 <i>max</i>	watts
GRID-NO.2 INPUT:		
For grid-No.2 voltages up to 150 volts.....	0.3 <i>max</i>	watt
For grid-No.2 voltages between 150 and 300 volts.....	See curve page 66	
PEAK HEATER-CATHODE VOLTAGE:		
Heater negative with respect to cathode.....	100 <i>max</i>	volts
Heater positive with respect to cathode.....	100 <i>max</i>	volts

**Characteristics:**

Plate Voltage.....	250	volts
Grid-No.2 Voltage.....	100	volts
Grid-No.1 Voltage.....	-2	volts
Plate Resistance (Approx.).....	0.8	megohm
Transconductance.....	2200	$\mu$ mhos
Plate Current.....	9.6	ma
Grid-No.2 Current.....	2.6	ma
Grid-No.1 Voltage (Approx.) for transconductance of 10 $\mu$ mhos.....	-32	volts

**Maximum Circuit Values:**

Grid-No.1-Circuit Resistance:		
For fixed-bias operation.....	0.25 <i>max</i>	megohms
For cathode-bias operation.....	1.0 <i>max</i>	megohm

**Maximum Rating:**

**DIODE UNIT**

PLATE CURRENT.....	1 <i>max</i>	ma
--------------------	--------------	----

**MEDIUM-MU TRIODE—  
SHARP-CUTOFF PENTODE**

Miniature type used in television receivers employing series-connected heater strings. Pentode unit is used as video amplifier; triode unit is used in sweep-oscillator sync-amplifier, sync-separator, and sync-clipper circuits. Outline 14, OUTLINES SECTION. Tube requires miniature nine-contact socket and may be operated in any position. Heater volts (ac/dc), 12.6; amperes, 0.3; warm-up time (average), 11 seconds. This type is used principally for renewal purposes.

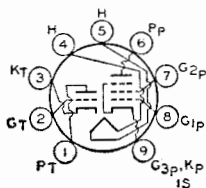

**12CT8**

**CLASS A<sub>1</sub> AMPLIFIER**

**Maximum Ratings, (Design-Maximum Values):**

	Triode Unit	Pentode Unit	
PLATE VOLTAGE.....	300 <i>max</i>	300 <i>max</i>	volts
GRID-NO.2 (SCREEN-GRID) SUPPLY VOLTAGE.....	-	300 <i>max</i>	volts
GRID-NO.2 VOLTAGE.....	-	See curve page 66	
GRID-NO.1 (CONTROL-GRID) VOLTAGE, Positive-bias value.....	0 <i>max</i>	0 <i>max</i>	volts
PLATE DISSIPATION.....	2.5 <i>max</i>	2.75 <i>max</i>	watts
GRID-NO.2 INPUT:			
For grid-No.2 voltages up to 150 volts.....	-	0.9 <i>max</i>	watt
For grid-No.2 voltages between 150 and 300 volts.....	-	See curve page 66	
PEAK HEATER-CATHODE VOLTAGE:			
Heater negative with respect to cathode.....	200 <i>max</i>	200 <i>max</i>	volts
Heater positive with respect to cathode.....	200 <i>max</i>	200 <i>max</i>	volts

**Characteristics:**

Plate Supply Voltage.....	150	200	volts
Grid-No.2 Supply Voltage.....	-	125	volts



Cathode-Bias Resistor .....	150	82	ohms
Amplification Factor .....	40	-	
Plate Resistance (Approx.) .....	8200	150000	ohms
Transconductance .....	4900	7000	$\mu$ hos
Grid-No.1 Voltage (Approx.) for plate current of 100 $\mu$ a .....	-6.5	-8	volts
Plate Current .....	9	15	ma
Grid No.2 Current .....	-	3.4	ma

**Maximum Circuit Values:**

Grid-No.1-Circuit Resistance:	<i>Triode Unit</i>	<i>Pentode Unit</i>	
For fixed-bias operation .....	0.5 max	0.25 max	megohm
For cathode-bias operation .....	1 max	1 max	megohm

■ The dc component must not exceed 100 volts.

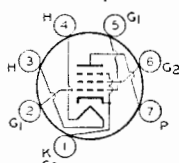

**BEAM POWER TUBE**

Miniature type used in the audio output stage of television receivers employing series-connected heater strings. Outline 13, OUTLINES SECTION. Heater volts (ac/dc), 12.6; amperes,

**12CU5  
/12C5**

0.6; warm-up time (average), 11 seconds. Except for heater rating, this type is identical with miniature type 6CU5.

Refer to type **12BQ6-GBT / 12CU6**

**12CU6**

**REMOTE-CUTOFF PENTODE**

Miniature type used as rf amplifier in low B+ voltage automobile radio receivers operating directly from 12-volt storage-battery systems. Outline 11, OUTLINES SECTION. Tube requires miniature seven-contact socket and may be mounted in any position. Heater voltage range (ac/dc) 10.0 to 15.9; amperes (approx.) at 12.6 volts, 0.15. This type is used principally for renewal purposes.

**12CX6**

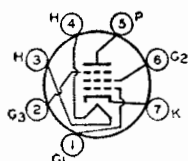

**CLASS A<sub>1</sub> AMPLIFIER**

**Maximum Ratings, (Design-Maximum Values):**

PLATE VOLTAGE .....	33 max	volts
GRID No.3 (SUPPRESSOR GRID) .....	Connect to cathode at socket	
GRID-No.2 (SCREEN-GRID) VOLTAGE .....	33 max	volts
GRID-No.1 (CONTROL-GRID) VOLTAGE, Positive-bias value .....	0 max	volts
PEAK HEATER-CATHODE VOLTAGE:		
Heater negative with respect to cathode .....	30 max	volts
Heater positive with respect to cathode .....	30 max	volts

**Characteristics with 12.6 Volts on Heater:**

Plate Voltage .....	12.6	volts
Grid No.3 .....	Connected to cathode at socket	
Grid-No.2 Voltage .....	12.6	volts
Grid-No.1 Supply Voltage .....	0	volts
Grid-No.1 Resistor (Bypassed) .....	2.2	megohms
Plate Resistance (Approx.) .....	40000	ohms
Transconductance .....	3100	$\mu$ hos
Grid-No.1 Voltage (Approx.) for plate current of 10 $\mu$ a .....	-4.5	volts
Plate Current .....	3	ma
Grid-No.2 Current .....	1.4	ma

**Maximum Circuit Value:**

Grid-No.1-Circuit Resistance .....	10 max	megohms
------------------------------------	--------	---------

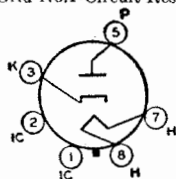

**HALF-WAVE VACUUM RECTIFIER**

Glass octal type used as damper diode in horizontal-deflection circuits of television receivers employing series-connected heater strings. Outline 22, OUTLINES SECTION. Tube re-

**12D4**

quires octal socket and may be mounted in any position. Socket terminals 1, 2, 4, and 6 should not be used as tie points. This type may be supplied with pin 1 omitted. It is especially important that this tube, like other power-handling tubes, be adequately ventilated.

HEATER VOLTAGE (AC/DC).....	12.6	volts
HEATER CURRENT.....	0.6	ampere
HEATER WARM-UP TIME (Average).....	11	seconds

### DAMPER SERVICE

*For operation in a 525-line, 30-frame system*

#### Maximum Ratings, (Design-Maximum Values):

PEAK INVERSE PLATE VOLTAGE#.....	4400 max	volts
PEAK PLATE CURRENT.....	900 max	ma
DC PLATE CURRENT.....	155 max	ma
PLATE DISSIPATION.....	5.5 max	watts
PEAK HEATER-CATHODE VOLTAGE:		
Heater negative with respect to cathode#.....	4400 <sup>▲</sup> max	volts
Heater positive with respect to cathode.....	300 <sup>■</sup> max	volts

# The duration of the voltage pulse must not exceed 15 per cent of one horizontal scanning cycle. In a 525-line, 30-frame system, 15 per cent of one horizontal scanning cycle is 10 microseconds.

▲ The dc component must not exceed 900 volts.

■ The dc component must not exceed 100 volts.

### BEAM POWER TUBE

Miniature type used as vertical-deflection-amplifier tube in television receivers employing series-connected heater strings. Outline 14, OUTLINES SECTION, except all vertical dimensions of this type are 1/8 inch greater. Tube requires miniature nine-contact socket and may be operated in any position.

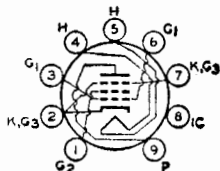

## 12DB5

HEATER VOLTAGE (AC/DC).....	12.6	volts
HEATER CURRENT.....	0.6	ampere
HEATER WARM-UP TIME (Average).....	11	seconds

#### Maximum Ratings: CLASS A<sub>1</sub> AMPLIFIER

PLATE VOLTAGE.....	300 max	volts
GRID-NO.2 (SCREEN-GRID) VOLTAGE.....	150 max	volts
GRID-NO.2 INPUT.....	1.25 max	watts
PLATE DISSIPATION.....	10 max	watts
PEAK HEATER-CATHODE VOLTAGE:		
Heater negative with respect to cathode.....	200 max	volts
Heater positive with respect to cathode.....	200 <sup>■</sup> max	volts

#### Typical Operation:

Plate Supply Voltage.....	200	volts
Grid-No.2 Supply Voltage.....	125	volts
Cathode-Bias Resistor.....	180	ohms
Peak AF Grid-No.1 Voltage.....	8.5	volts
Zero-Signal Plate Current.....	46	ma
Maximum-Signal Plate Current.....	47	ma
Zero-Signal Grid-No.2 Current.....	2.2	ma
Maximum-Signal Grid-No.2 Current.....	8.5	ma
Plate Resistance (Approx.).....	28000	ohms
Transconductance.....	8000	μmhos
Load Resistance.....	4000	ohms
Total Harmonic Distortion.....	10	per cent
Maximum-Signal Power Output.....	3.8	watts

#### Maximum Circuit Values:

Grid-No.1 Circuit Resistance:		
For fixed-bias operation.....	0.1 max	megohm
For cathode-bias operation.....	2.2 max	megohms

### VERTICAL-DEFLECTION AMPLIFIER

*For operation in a 525-line, 30-frame system*

#### Maximum Ratings:

DC PLATE VOLTAGE.....	300 max	volts
PEAK POSITIVE-PULSE PLATE VOLTAGE (Absolute Maximum) <sup>▲</sup> .....	2000 <sup>■</sup> max	volts
DC GRID-NO.2 (SCREEN-GRID) VOLTAGE.....	150 max	volts
PEAK NEGATIVE-PULSE GRID-NO.1 (CONTROL-GRID) VOLTAGE.....	250 max	volts
PEAK CATHODE CURRENT.....	200 max	ma
AVERAGE CATHODE CURRENT.....	55 max	ma
GRID-NO.2 INPUT.....	1.25 max	watts
PLATE DISSIPATION.....	10 max	watts
PEAK HEATER-CATHODE VOLTAGE:		
Heater negative with respect to cathode.....	200 max	volts
Heater positive with respect to cathode.....	200 <sup>■</sup> max	volts

#### Maximum Circuit Values:

Grid-No.1-Circuit Resistance:		
For fixed-bias operation.....	0.1 max	megohm
For cathode-bias operation.....	2.2 max	megohms

- The dc component must not exceed 100 volts.
- The duration of the voltage pulse must not exceed 15 per cent of one vertical scanning cycle. In a 525-line, 30-frame system, 15 per cent of one vertical scanning cycle is 2.5 milliseconds.
- Under no circumstances should this absolute maximum value be exceeded.

**DIODE—  
REMOTE-CUTOFF PENTODE**

12DE8

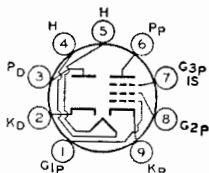

Miniature type used in automobile radio receivers; pentode unit is used as rf or if amplifier. Outline 12, OUTLINES SECTION. Tube requires miniature nine-contact socket and may be operated in any position.

HEATER VOLTAGE RANGE (DC)°	10 to 15.9	volts
HEATER CURRENT (Approx.), at 12.6 volts	0.2	ampere

° For longest life, it is recommended that the heater be operated within the voltage range of 11 to 14 volts.

<b>PENTODE UNIT AS CLASS A<sub>1</sub> AMPLIFIER</b>		
Maximum Ratings:		
PLATE VOLTAGE	30 max	volts
GRID No.3 (SUPPRESSOR GRID)	Connect to cathode at socket	
GRID-No.2 (SCREEN-GRID) VOLTAGE	30 max	volts
CATHODE CURRENT	20 max	ma
PEAK HEATER-CATHODE VOLTAGE:		
Heater negative with respect to cathode	30 max	volts
Heater positive with respect to cathode	30 max	volts
<b>Characteristics with 12.6 Volts on Heater:</b>		
Plate Voltage	12.6	volts
Grid No.3	Connected to cathode at socket	
Grid-No.2 Voltage	12.6	volts
Grid-No.1 Voltage, Developed across a 2.2-megohm grid resistor	-0.8	volt
Plate Resistance (Approx.)	0.3	megohm
Transconductance	1500	μmhos
Plate Current	1.3	ma
Grid-No.2 Current	0.5	ma
Grid-No.1 Voltage (Approx.), for transconductance of 10 μmhos	-6	volts

Maximum Circuit Values:		
Grid-No.1-Circuit Resistance	10 max	megohms

<b>DIODE UNIT</b>		
Maximum Ratings:		
PLATE CURRENT	5 max	ma
<b>Characteristics, Instantaneous Test Condition:</b>		
Plate Current, for plate volts=5	20	ma

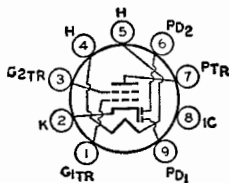

**TWIN DIODE—POWER TETRODE**

12DK7

Miniature type used as combined detector, avc diode, and power amplifier in low B<sup>+</sup> voltage automobile radio receivers operating directly from 12-volt storage-battery systems. Outline 14, OUTLINES SECTION. Tube requires miniature nine-contact socket and may be operated in any position.

line 14, OUTLINES SECTION. Tube requires miniature nine-contact socket and may be operated in any position.

HEATER VOLTAGE RANGE (DC)°	10 to 15.9	volts
HEATER CURRENT (Approx.), at 12.6 volts	0.5	ampere

° For longest life, it is recommended that the heater be operated within the voltage range of 11 to 14 volts.

<b>TETRODE UNIT AS CLASS A<sub>1</sub> AMPLIFIER</b>		
Maximum Ratings:		
PLATE VOLTAGE	30 max	volts
GRID-No.2 (SCREEN-GRID) VOLTAGE	30 max	volts
PLATE CURRENT	10 max	ma
PLATE DISSIPATION	0.5 max	watt
PEAK HEATER-CATHODE VOLTAGE:		
Heater negative with respect to cathode	30 max	volts
Heater positive with respect to cathode	30 max	volts
<b>Typical Operation with 12.6 Volts on Heater:</b>		
Plate Voltage	12.6	volts
Grid-No.2 Voltage	12.6	volts

Grid-No.1 Voltage.....	Obtained by rectification through 15-megohm grid-No.1 resistor	
Peak AF Grid-No.1 Voltage, from 0.2-megohm signal source.....	1.4	volts
Zero-Signal Plate Current.....	6	ma
Maximum-Signal Plate Current.....	2.5	ma
Load Resistance.....	3500	ohms
Total Harmonic Distortion.....	10	per cent
Maximum-Signal Power Output.....	10	mw

**Maximum Circuit Values:**

Grid-No.1-Circuit Resistance.....	15 max	megohms
-----------------------------------	--------	---------

**DIODE UNITS (Each Unit)**

**Characteristics, Instantaneous Test Condition:**

Heater Voltage.....	12.6	volts
Plate Current, for plate volts=10.....	1	ma

**TWIN DIODE—POWER TETRODE**

Miniature type used as combined detector and power amplifier driver in low B+ voltage automobile radio receivers operating directly from 12-volt storage-battery systems. Outline 14, OUTLINES SECTION. Heater voltage range (ac/dc), 10.0 to 15.9; amperes (approx.) at 12.6 volts, 0.55. Tube requires miniature nine-contact socket and may be mounted in any position. This type is used principally for renewal purposes.

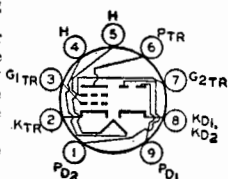

# 12DL8

**TETRODE UNIT AS AUDIO DRIVER**

**Maximum Ratings:**

PLATE VOLTAGE.....	30 max	volts
GRID-NO.2 (CONTROL-GRID) VOLTAGE, Negative-bias value.....	-20 max	volts
GRID-NO.1 (SPACE-CHARGE-GRID) VOLTAGE (Absolute Maximum).....	16 <sup>max</sup>	volts
PEAK HEATER-CATHODE VOLTAGE:		
Heater negative with respect to cathode.....	30 max	volts
Heater positive with respect to cathode.....	30 max	volts

**Characteristics with 12.6 Volts on Heater:**

Plate Voltage.....	12.6	volts
Grid-No.2 Voltage.....	-0.5	volt
Grid-No.1 Voltage.....	12.6	volts
Plate Resistance (Approx.).....	480	ohms
Transconductance (Grid No.2 to Plate).....	15000	μmhos
Amplification Factor (Grid No.2 to Plate).....	7.2	
Plate Current.....	40	ma
Grid-No.1 Current.....	75	ma

**Typical Operation with 12.6 Volts on Heater:**

Plate Voltage.....	12.6	volts
Grid-No.2 Voltage <sup>▲</sup> .....	-2	volts
Peak AF Grid-No.2 Voltage <sup>‡</sup> .....	2.5	volts
Grid-No.1 Voltage.....	12.6	volts
Zero-Signal Plate Current.....	40	ma
Maximum-Signal Plate Current.....	8	ma
Grid-No.1 Current.....	75	ma
Load Resistance.....	800	ohms
Total Harmonic Distortion.....	10	per cent
Maximum-Signal Power Output.....	40	mw

**Maximum Circuit Value:**

Grid-No.2-Circuit Resistance.....	10 max	megohms
-----------------------------------	--------	---------

**DIODE UNITS (Each Unit):**

**Maximum Ratings:**

PLATE CURRENT.....	5 max	ma
PEAK HEATER-CATHODE VOLTAGE:		
Heater positive with respect to cathode.....	30 max	volts
Heater negative with respect to cathode.....	30 max	volts

- Under no circumstances should this absolute maximum value be exceeded.
- ▲ Developed across a 2.2-megohm resistor.
- Obtained by rectification through a 2.2-megohm resistor.
- ‡ Obtained from 0.1-megohm source.

**HALF-WAVE VACUUM RECTIFIER**

Glass octal type used as damper tube in horizontal-deflection circuits of television receivers employing series-connected heater strings. Outline 29, OUTLINES SECTION. Heater volts

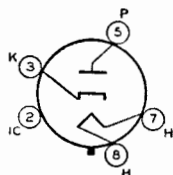

# 12DM4

(ac/dc), 12.6; amperes, 0.6; warm-up time (average), 11 seconds. Except for heater rating, this type is identical with glass octal type 6DM4.

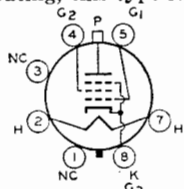

**BEAM POWER TUBE**

Glass octal types used as horizontal-deflection-amplifier tubes in television receivers employing series-connected heaterstrings. Outline 37, OUTLINES SECTION. Heater volts

**12DQ6-A**  
**12DQ6-B**

(ac/dc), 12.6; amperes, 0.6; warm-up time (average), 11 seconds. Except for heater ratings, these types are identical with glass octal types 6DQ6-A and 6DQ6-B, respectively.

**POWER PENTODE**

Miniature type used as video-output-amplifier tube in television receivers employing series-connected heater strings. Outline 14, OUTLINES SECTION. Tube requires miniature nine-contact socket and may be operated in any position. Heater volts (ac/dc): 12.6 in series arrangement, 6.3 in parallel arrangement; amperes, 0.3 (series), 0.6 (parallel); warm-up time (average), 11 seconds. This type is used principally for renewal purposes.

**12DQ7**

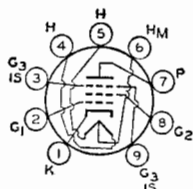

**CLASS A<sub>1</sub> AMPLIFIER**

Maximum Ratings, (Design-Maximum Values):

PLATE VOLTAGE.....	330 max	volts
GRID No.3 (SUPPRESSOR GRID).....	Connect to cathode at socket	
GRID-No.2 (SCREEN-GRID) SUPPLY VOLTAGE.....	330 max	volts
GRID-No.2 VOLTAGE.....	See curve page 66	
GRID-No.1 (CONTROL-GRID) VOLTAGE, Positive-bias value.....	0 max	volts
GRID-No.2 INPUT:		
For grid-No.2 voltages up to 165 volts.....	1.1 max	watts
For grid-No.2 voltages between 165 and 330 volts.....	See curve page 66	
PLATE DISSIPATION.....	6.5 max	watts
PEAK HEATER-CATHODE VOLTAGE:		
Heater negative with respect to cathode.....	200 max	volts
Heater positive with respect to cathode.....	200 <sup>max</sup>	volts

**Characteristics:**

Plate Supply Voltage.....	200	volts
Grid No.3 and Internal Shield.....	Connected to cathode at socket	
Grid-No.2 Supply Voltage.....	125	volts
Cathode-Bias Resistor.....	68	ohms
Plate Resistance (Approx.).....	53000	ohms
Transconductance.....	10500	μmhos
Plate Current.....	26	ma
Grid-No.2 Current.....	5.6	ma
Grid-No.1 Voltage (Approx.) for plate current of 100 μa.....	-9	volts

**Maximum Circuit Values:**

Grid-No.1-Circuit Resistance:		
For fixed-bias operation.....	0.25 max	megohm
For cathode-bias operation.....	1 max	megohm

■ The dc component must not exceed 100 volts.

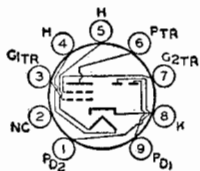

**TWIN DIODE—POWER TETRODE**

Miniature types used as combined detectors and power amplifier drivers in low B<sup>+</sup> voltage automobile radio receivers operating directly from 12-volt storage-battery systems. The diode

**12DS7**  
**12DS7-A**

units are used for AM signal detection and automatic volume control, and the tetrode unit is used as the driver for the output stage. Outline 14, OUTLINES SECTION. Tubes require miniature nine-contact socket and may be mounted in any position. For characteristics and typical operation with grid-No.2-resistor bias of tetrode unit of the 12DS7 as class A<sub>1</sub> amplifier, refer to type 12DL8. Type 12DS7-A is a DISCONTINUED type listed for reference only.

HEATER-VOLTAGE RANGE (AC/DC)*	10.0 to 15.9	volts
HEATER CURRENT (Approx.) at 12.6 volts	0.4	ampere
DIRECT INTERELECTRODE CAPACITANCES for 12DS7:		
Tetrode Unit:		
Grid No.2 to Plate	13	$\mu\text{f}$
Grid No.2 to Cathode, Heater, and Grid No.1	13	$\mu\text{f}$
Plate to Cathode, Heater, and Grid No.1	2.4	$\mu\text{f}$
Diode Units:		
Plate to Cathode and Heater (Each unit)	0.5	$\mu\text{f}$
Plate of Unit No.1 to Plate of Unit No.2	0.1	$\mu\text{f}$
Tetrode Grid No.2 to Plate of Diode Unit No.1	0.3 max	$\mu\text{f}$
Tetrode Grid No.2 to Plate of Diode Unit No.2	0.3 max	$\mu\text{f}$

\*For longest life, it is recommended that the heater be operated within the voltage range of 11 to 14 volts.

### TETRODE UNIT OF 12DS7 AS AUDIO DRIVER

Maximum Ratings, (Design-Maximum Values):

PLATE VOLTAGE	16 max	volts
GRID-NO.2 (CONTROL-GRID) VOLTAGE, Negative-bias value	-16 max	volts
GRID-NO.1 (SPACE-CHARGE-GRID) VOLTAGE	16* max	volts
PEAK HEATER-CATHODE VOLTAGE:		
Heater negative with respect to cathode	16 max	volts
Heater positive with respect to cathode	16 max	volts

Typical Operation with 12.0 Volts on Heater:

Plate and Grid-No.1 Supply Voltage	11.2	volts
Grid-No.2 Supply Voltage	0	volts
Peak AF Grid-No.2 Supply Voltage (Approx.)†	4.25	volts
Grid-No.1 Supply Voltage	11.2	volts
Zero-Signal Plate Current	20	ma
Maximum-Signal Plate Current	7	ma
Grid-No.1 Current	58	ma
Total Harmonic Distortion	5	per cent
Signal Power Output	8	mW

Maximum Circuit Value:

Grid-No.2-Circuit Resistance	10 max	megohms
------------------------------	--------	---------

† Under no circumstances should this absolute value be exceeded.

‡ Obtained from 3.3-megohm signal source.

Grid-No.2 voltage obtained by a cathode resistor.

### DIODE UNITS OF 12DS7 (Each Unit)

Maximum Ratings, (Design-Maximum Values):

PLATE CURRENT	5 max	ma
---------------	-------	----

#### AVERAGE CHARACTERISTICS TETRODE UNIT

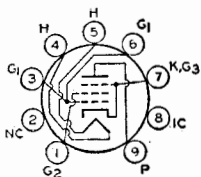
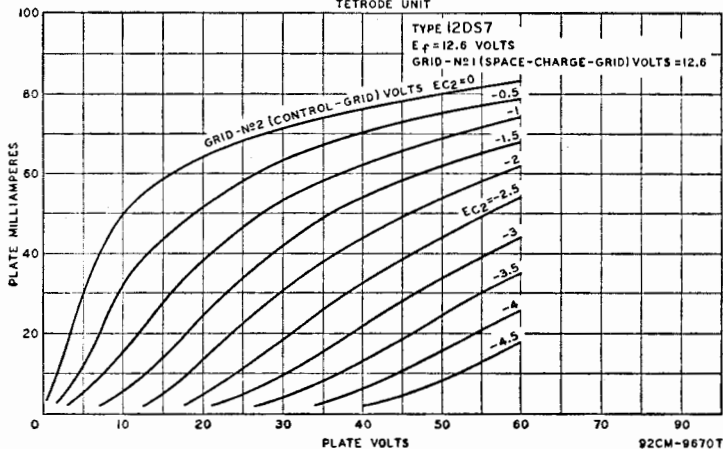

### BEAM POWER TUBE

Miniature type used as vertical-deflection-amplifier tube in television receivers employing series-connected heater strings. Outline 14, OUTLINES SECTION. Heater volts (ac/dc), 12.6;

# 12DT5

amperes, 0.6; warm-up time (average), 11 seconds. Except for heater rating, this type is identical with type 6DT5.

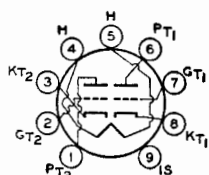

### HIGH-MU TWIN TRIODE

Miniature type used as push-pull rf amplifier and as combined oscillator and mixer in FM tuners. Also useful in a wide variety of applications in radio and television receivers. Outline

# 12DT8

12, OUTLINES SECTION. Heater volts (ac/dc), 12.6; amperes, 0.15. Except for heater rating, interelectrode capacitances, and basing arrangement, this type is identical with miniature type 12AT7. Except for heating rating, type 12DT8 is identical with miniature type 6DT8.

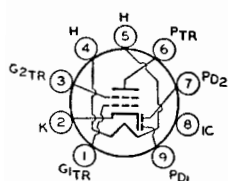

### TWIN-DIODE—POWER TETRODE

Miniature type used as combined detector, avc, and power amplifier driver in low B<sup>+</sup> voltage automobile radio receivers operating directly from 12-volt storage-battery systems. Out-

# 12DU7

line 12, OUTLINES SECTION. Tube requires miniature nine-contact socket and may be operated in any position.

HEATER VOLTAGE RANGE (DC)°	10 to 15.9	volts
HEATER CURRENT (Approx.), at 12.6 volts	0.25	ampere

° For longest life, it is recommended that the heater be operated within the voltage range of 11 to 14 volts.

#### TETRODE UNIT AS AUDIO DRIVER

##### Maximum Ratings, (Design-Maximum Values):

PLATE VOLTAGE	16 max	volts
GRID-NO.2 (SCREEN-GRID) VOLTAGE	16 max	volts
PEAK HEATER-CATHODE VOLTAGE:		
Heater negative with respect to cathode	16 max	volts
Heater positive with respect to cathode	16 max	volts

##### Typical Operation with 12.6 Volts on Heater:

Plate Voltage	12.6	volts
Grid-No.2 Voltage	12.6	volts
Grid-No.1 Voltage	Obtained by rectification through 2.2-megohm grid-No.1 resistor	
Peak AF Grid-No.1 Voltage	2.2	volts
Load Resistance	2700	ohms
Total Harmonic Distortion	10	per cent
Maximum-Signal Power Output	25	mw

##### Maximum Circuit Values:

Grid-No.1-Circuit Resistance	10 max	megohms
------------------------------	--------	---------

#### DIODE UNITS

*Each Unit*

##### Maximum Ratings, (Design-Maximum Values):

PLATE CURRENT	1 max	ma
---------------	-------	----

##### Characteristics, Instantaneous Test Condition:

Heater Voltage	12.6	volts
Plate Current, for plate volts=10	1.3	ma

**TWIN DIODE—POWER TETRODE**

**12DV8**

Miniature type used as combined detector and power-amplifier driver in low B<sup>+</sup> voltage automobile-radio receivers operating directly from 12-volt storage-battery systems. The diode

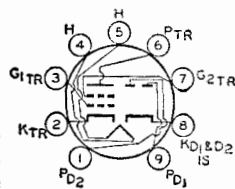

units are used for AM signal detection and automatic-volume control; the tetrode unit is used as the driver for a transistorized power-output stage. Outline 14, OUTLINES SECTION. Tube requires miniature nine-contact socket and may be mounted in any position.

HEATER-VOLTAGE RANGE (AC/DC)*	10.0 to 15.9	volts
HEATER CURRENT (Approx.) at 12.6 volts	0.375	ampere

\*For longest life, it is recommended that the heater be operated within the voltage range of 11 to 14 volts.

**CLASS A<sub>1</sub> AMPLIFIER (Tetrode Unit)**

Characteristics with 12.6 Volts on Heater:

Plate Supply Voltage	12.6	volts
Grid-No.1 (Space-Charge-Grid) Voltage	12.6	volts
Grid-No.2 (Control-Grid) Resistor	4.7	megohms
Cathode-Bias Resistor	18	ohms
Plate Resistance (Approx.)	900	ohms
Transconductance (Grid No.2 to Plate)	8500	μmhos
Amplification Factor (Grid No.2 to Plate)	7.6	
Plate Current	9	ma
Grid-No.1 Current	53	ma

**TETRODE UNIT AS AUDIO DRIVER**

Maximum Ratings, (Design-Maximum Values):

PLATE VOLTAGE	16 max	volts
GRID-NO.2 (CONTROL-GRID) VOLTAGE, Negative-bias value	-16 max	volts
GRID-NO.1 (SPACE-CHARGE-GRID) VOLTAGE	16 max	volts
PEAK HEATER-CATHODE VOLTAGE:		
Heater negative with respect to cathode	16 max	volts
Heater positive with respect to cathode	16 max	volts

Typical Operation with 12.6 Volts on Heater:

Plate Supply Voltage	12.6	volts
Grid-No.1 Supply Voltage	12.6	volts
Grid-No.2 Resistor	4.7	megohms
Cathode-Bias Resistor	18	ohms
Peak AF Grid-No.2 Supply Voltage (Approx.) <sup>■</sup>	1.2	volts
Indicated-Signal Plate Current	6.8	ma
Grid-No.1 Current	54	ma
Load Resistance	1250	ohms
Total Harmonic Distortion	3	per cent
Indicated-Signal Power Output	5	mw

Maximum Circuit Value:

Grid-No.2-Circuit Resistance	10 max	megohms
------------------------------	--------	---------

<sup>■</sup> Obtained from 0.3-megohm signal source.

**DIODE UNITS (Each Unit)**

Maximum Ratings, (Design-Maximum Values):

PLATE CURRENT	5 max	ma
PEAK HEATER-CATHODE VOLTAGE:		
Heater negative with respect to cathode	16 max	volts
Heater positive with respect to cathode	16 max	volts

**DUAL TRIODE**

**12DW7**

Miniature type containing high- $\mu$  and medium- $\mu$  triodes; used as amplifier and phase inverter in audio equipment. Outline 12, OUTLINES SECTION. Tube requires miniature nine-contact socket and may be operated in any position.

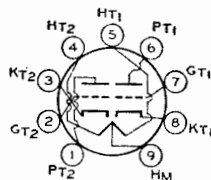

HEATER ARRANGEMENT:	Series	Parallel	
HEATER VOLTAGE (AC/DC)	12.6	6.3	volts
HEATER CURRENT	0.15	0.3	ampere



## CLASS A<sub>1</sub> AMPLIFIER

### Maximum Ratings, (Design-Maximum Values):

	Unit No.1	Unit No.2	
PLATE VOLTAGE.....	330 max	330 max	volts
GRID VOLTAGE:			
Negative-bias value.....	55 max	-	volts
Positive-bias value.....	0 max	-	volts
CATHODE CURRENT.....	-	22 max	ma
PLATE DISSIPATION.....	1.2 max	3.3 max	watts
PEAK HEATER-CATHODE VOLTAGE:			
Heater negative with respect to cathode.....	200 max	200 max	volts
Heater positive with respect to cathode.....	200° max	200° max	volts

### Characteristics:

	Unit No.1		Unit No.2		
Plate Voltage.....	100	250	100	250	volts
Grid Voltage.....	-1	-2	0	-8.5	volts
Amplification Factor.....	100	100	20	17	
Plate Resistance (Approx.).....	80000	62500	6500	7700	ohms
Transconductance.....	1250	1600	3100	2200	amhos
Plate Current.....	0.5	1.2	11.8	10.5	ma
Grid Voltage (Approx.) for plate $\mu$ =10.....	-	-	-	-24	volts

### Maximum Circuit Values:

	Unit No.1	Unit No.2	
Grid-Circuit Resistance:			
For fixed-bias operation.....	0.25 max	0.25 max	megohm
For cathode-bias operation.....	1 max	1 max	megohm

° The dc component must not exceed 100 volts.

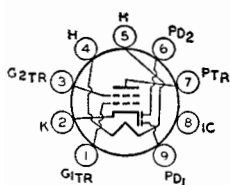

## MEDIUM-MU TRIODE— REMOTE-CUTOFF TETRODE

Miniature type used in low B<sup>+</sup> voltage automobile radio receivers operating directly from 12-volt storage-battery systems; tetrode unit is used for relay service in a signal-seeker.

# 12DY8

Outline 12, OUTLINES SECTION. Tube requires miniature nine-contact socket and may be operated in any position.

HEATER VOLTAGE RANGE (DC)°.....	10 to 15.9	volts
HEATER CURRENT (Approx.) at 12.6 volts.....	0.35	ampere

° For longest life, it is recommended that the heater be operated within the voltage range of 10 to 14 volts.

### TETRODE UNIT AS RELAY CONTROL

#### Maximum Ratings, (Design-Maximum Values):

PLATE VOLTAGE.....	16 max	volts
GRID-NO.2 (SCREEN-GRID) VOLTAGE.....	16 max	volts
PEAK HEATER-CATHODE VOLTAGE:		
Heater negative with respect to cathode.....	16 max	volts
Heater positive with respect to cathode.....	16 max	volts

#### Typical Operation:

Heater Voltage.....	10	15	volts
Plate Supply Voltage.....	10	15	volts
Grid-No.2 Voltage.....	10	15	volts
Grid-No.1 Voltage.....	-	-6	volts
Grid-No.1 Resistor.....	10	-	megohms
Plate Load Resistor.....	700	700	ohms
Plate Current.....	5 min	3 max	ma

#### Maximum Circuit Values:

Grid-No.1-Circuit Resistance.....	10 max	megohms
-----------------------------------	--------	---------

## CLASS A<sub>1</sub> AMPLIFIER

### Maximum Ratings, (Design-Maximum Values):

	(Triode Unit)	
PLATE VOLTAGE.....	16 max	volts
PEAK HEATER-CATHODE VOLTAGE:		
Heater negative with respect to cathode.....	16 max	volts
Heater positive with respect to cathode.....	16 max	volts

### Characteristics with 12.6 Volts on Heater:

	Triode Unit	Tetrode Unit	
Plate Voltage.....	12.6	12.6	volts
Grid-No.2 Voltage.....	-	12.6	volts
Grid-No.1 Voltage.....	0	-	volts
Grid-No.1 Resistor.....	-	2.2	megohms
Amplification Factor.....	20	-	
Plate Resistance (Approx.).....	10000	5000	ohms
Transconductance.....	2000	6000	$\mu$ mhos
Plate Current.....	1.2	14	ma
Grid-No.2 Current.....	-	2	ma
Grid Voltage (Approx.) for plate $\mu$ a=10.....	-2	-	volts
Grid-No.1 Voltage (Approx.) for plate $\mu$ a=20.....	-	-9	volts

### Maximum Circuit Values: (Triode Unit)

Grid-Circuit Resistance.....	10 max	megohms
------------------------------	--------	---------

## 12DZ6

### REMOTE-CUTOFF PENTODE

Miniature type used as rf and if amplifier in low B+ voltage automobile radio receivers operating directly from 12-volt storage-battery systems. Outline 11, OUTLINES SECTION.

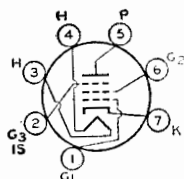

Tube requires miniature seven-contact socket and may be mounted in any position.

HEATER-VOLTAGE RANGE (AC/DC)*.....	10.0 to 15.9	volts
HEATER CURRENT (Approx.) at 12.6 volts.....	0.19	ampere
DIRECT INTERELECTRODE CAPACITANCES:		
Grid No.1 to Plate.....	0.05 max	$\mu$ mf
Grid No.1 to Cathode, Heater, Grid No.2, Grid No.3, and Internal Shield.....	9.5	$\mu$ mf
Plate to Cathode, Heater, Grid No.2, Grid No.3, and Internal Shield.....	4	$\mu$ mf

### CLASS A<sub>1</sub> AMPLIFIER

#### Maximum Ratings, (Design-Maximum Values):

PLATE VOLTAGE.....	16 max	volts
GRID NO.3 (SUPPRESSOR GRID).....	Connect to cathode at socket	
GRID NO.2 (SCREEN-GRID) VOLTAGE.....	16 max	volts
GRID NO.1 (CONTROL-GRID) VOLTAGE, Positive-bias value.....	0 max	volts
PEAK HEATER-CATHODE VOLTAGE:		
Heater negative with respect to cathode.....	16 max	volts
Heater positive with respect to cathode.....	16 max	volts

### AVERAGE CHARACTERISTICS

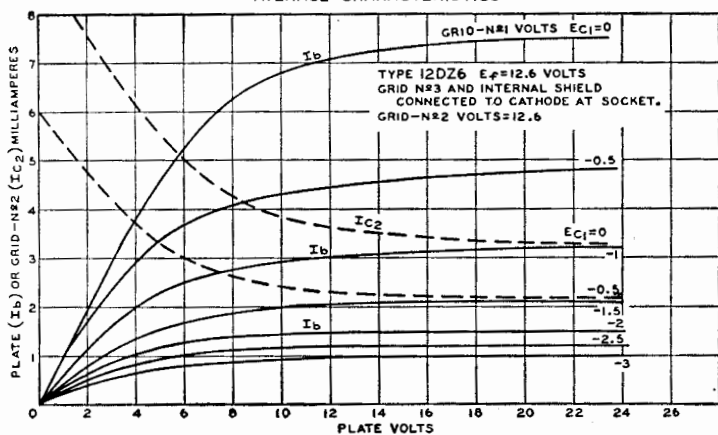

**Characteristics with 12.6 Volts on Heater:**

Plate Voltage .....	12.6	volts
Grid No.3 and Internal Shield .....	Connected to cathode at socket	
Grid-No.2 Voltage .....	12.6	volts
Grid-No.1 Supply Voltage .....	0	volts
Grid-No.1 Resistor (Bypassed) .....	10	megohms
Grid-No.3 Resistor (Bypassed) .....	10	megohms
Plate Resistance (Approx.) .....	2500	ohms
Transconductance .....	3800	$\mu$ hos
Grids No.1 and No.3 Supply Voltage (Approx.) for transconductance, grid No.1 to plate, of 10 $\mu$ hos .....	-10	volts
Plate Current .....	4.5	ma
Grid-No.2 Current .....	2.2	ma

**Maximum Circuit Values:**

Grid-No.1-Circuit Resistance .....	10 max	megohms
Grid-No.3-Circuit Resistance .....	10 max	megohms

\*For longest life, it is recommended that the heater be operated within the voltage range of 11 to 14 volts.

**REMOTE-CUTOFF PENTODE**

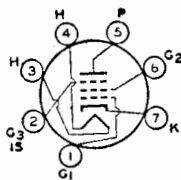

Miniature type used as rf amplifier in low B+ voltage automobile radio receivers operating directly from 12-volt storage-battery systems. Outline 11, OUTLINES SECTION. Tube requires miniature seven-contact socket and may be mounted in any position. Heater voltage range (ac/dc), 10.0 to 15.9; amperes (approx.) at 12.6 volts, 0.19. This type is used principally for renewal purposes.

**12EA6**

**CLASS A<sub>1</sub> AMPLIFIER**

**Maximum Ratings, (Design-Maximum Values):**

PLATE VOLTAGE .....	16 max	volts
GRID NO.3 (SUPPRESSOR GRID) .....	Connect to cathode at socket	
GRID-NO.2 (SCREEN-GRID) VOLTAGE .....	16 max	volts
GRID-NO.1 (CONTROL-GRID) VOLTAGE, Positive-bias value .....	0 max	volts
PEAK HEATER-CATHODE VOLTAGE:		
Heater negative with respect to cathode .....	16 max	volts
Heater positive with respect to cathode .....	16 max	volts

**Characteristics with 12.6 Volts on Heater:**

Plate Voltage .....	12.6	volts
Grid No.3 and Internal Shield .....	Connected to cathode at socket	
Grid-No.2 Voltage .....	12.6	volts
Grid-No.1 Resistor (Bypassed) .....	10	megohms
Plate Resistance (Approx.) .....	3200	ohms
Transconductance .....	3800	$\mu$ hos
Grid-No.1 Voltage (Approx.) for plate current of 10 $\mu$ a .....	-3.4	volts
Plate Current .....	3.2	ma
Grid-No.2 Current .....	1.4	ma

**Maximum Circuit Value:**

Grid-No.1-Circuit Resistance .....	12 max	megohms
------------------------------------	--------	---------

**MEDIUM-MU TRIODE—  
SEMIREMOTE-CUTOFF PENTODE**

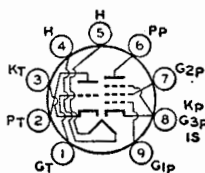

Miniature type used as a combined vhf oscillator and mixer in low B+ voltage automobile radio receivers operating directly from 12-volt storage-battery systems. Outline 12, OUTLINES SECTION. Tube requires miniature nine-contact socket and may be operated in any position.

**12EC8**

HEATER VOLTAGE RANGE (DC)° .....	10 to 15.9	volts
HEATER CURRENT (Approx.) at 12.6 volts .....	0.225	ampere

° For longest life, it is recommended that the heater be operated within the voltage range of 11 to 14 volts.

**CLASS A<sub>1</sub> AMPLIFIER**

Maximum Ratings, (Design-Maximum Values):	<i>Triode Unit</i>	<i>Pentode Unit</i>	
PLATE VOLTAGE.....	16 <i>max</i>	16 <i>max</i>	volts
GRID-NO.2 (SCREEN-GRID) VOLTAGE.....	—	16 <i>max</i>	volts
PEAK HEATER-CATHODE VOLTAGE:			
Heater negative with respect to cathode.....	16 <i>max</i>	16 <i>max</i>	volts
Heater positive with respect to cathode.....	16 <i>max</i>	16 <i>max</i>	volts

**Characteristics with 12.6 Volts on Heater:**

	<i>Triode Unit</i>	<i>Pentode Unit</i>	
Plate Supply Voltage.....	12.6	12.6	volts
Grid-No.2 Voltage.....	—	12.6	volts
Grid-No.1 Supply Voltage.....	0	0	volts
Grid-No.1 Resistor.....	4700	33000	ohms
Amplification Factor.....	25	—	
Plate Resistance (Approx.).....	6000	750000	ohms
Transconductance.....	4700	2000	μmhos
Plate Current.....	2.4	0.66	ma
Grid-No.2 Current.....	—	0.28	ma
Grid-No.1 Voltage (Approx.), for plate μa=10.....	-2.2	-1.6	volts

**Maximum Circuit Value:**

	<i>Triode Unit</i>	<i>Pentode Unit</i>	
Grid-No.1-Circuit Resistance.....	1 <i>max</i>	1 <i>max</i>	megohm

**BEAM POWER TUBE**

Miniature type used as audio-out-put amplifier in radio and television receivers employing series-connected heater strings. Outline 13, OUTLINES SECTION. Tube requires miniature seven-contact socket and may be mounted in any position.

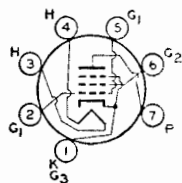

**12ED5**

HEATER VOLTAGE (AC/DC).....	12.6	volts
HEATER CURRENT.....	0.45	ampere
HEATER WARM-UP TIME (Average).....	11	seconds

**CLASS A<sub>1</sub> AMPLIFIER**

**Maximum Ratings, (Design-Maximum Values):**

PLATE VOLTAGE.....	150 <i>max</i>	volts
GRID-NO.2 (SCREEN-GRID) VOLTAGE.....	150 <i>max</i>	volts
GRID-NO.2 INPUT.....	1.5 <i>max</i>	watts
PLATE DISSIPATION.....	6.25 <i>max</i>	watts
PEAK HEATER-CATHODE VOLTAGE:		
Heater negative with respect to cathode.....	300* <i>max</i>	volts
Heater positive with respect to cathode.....	200■ <i>max</i>	volts

**Typical Operation:**

Plate Voltage.....	110	125	volts
Grid-No.2 Voltage.....	110	125	volts
Grid-No.1 (CONTROL-GRID) Voltage.....	-4	-4.5	volts
Peak AF Grid-No.1 Voltage.....	4	4.5	volts
Zero-Signal Plate Current.....	32	37	ma
Maximum-Signal Plate Current.....	31	36	ma
Zero-Signal Grid-No.2 Current.....	4	7	ma
Maximum-Signal Grid-No.2 Current.....	8	11	ma
Plate Resistance (Approx.).....	14000	14000	ohms
Transconductance.....	8100	8500	μmhos
Load Resistance.....	4500	4500	ohms
Total Harmonic Distortion.....	5	5	per cent
Maximum-Signal Power Output.....	1.1	1.5	watts

**Maximum Circuit Values:**

Grid-No.1-Circuit Resistance:			
For fixed-bias operation.....	0.1 <i>max</i>	megohm	
For cathode-bias operation.....	0.5 <i>max</i>	megohm	

- \* The dc component must not exceed 200 volts.
- The dc component must not exceed 100 volts.

### PENTAGRID AMPLIFIER

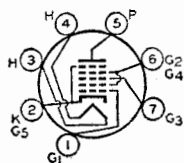

Miniature type used as rf amplifier in low B+ voltage automobile radio receivers operating directly from 12-volt storage-battery systems. Outline 11, OUTLINES SECTION. Grid No.1 and grid No.3 are independent control electrodes. Tube requires miniature seven-contact socket and may be mounted in any position. This type is used principally for renewal purposes.

## 12EG6

HEATER VOLTAGE RANGE (AC/DC).....	10.0 to 15.9	volts
HEATER CURRENT (Approx.) at 12.6 volts.....	0.15	ampere

\*For longest life, it is recommended that the heater be operated within the voltage range of 11 to 14 volts.

#### CLASS A<sub>1</sub> AMPLIFIER

**Maximum Ratings:**

PLATE VOLTAGE.....	16 <i>max</i>	volts
GRIDS-NO.3 (CONTROL-GRID) VOLTAGE:		
Positive-bias value.....	0 <i>max</i>	volts
Negative-bias value.....	-16 <i>max</i>	volts
GRIDS-NO.2-AND-NO.4 (SCREEN-GRID) VOLTAGE.....	16 <i>max</i>	volts
GRIDS-NO.2-AND-NO.4 SUPPLY VOLTAGE.....	16 <i>max</i>	volts
CATHODE CURRENT.....	20 <i>max</i>	ma
PEAK HEATER-CATHODE VOLTAGE:		
Heater negative with respect to cathode.....	16 <i>max</i>	volts
Heater positive with respect to cathode.....	16 <i>max</i>	volts

**Characteristics with 12.6 Volts on Heater and Grid No. 3 Connected to Grid No. 1 through 100,000-ohm resistor:**

Plate Voltage.....	12.6	volts
Grids-No.2-and-No.4 Voltage.....	12.6	volts
Grid-No.1 (Control-Grid) Voltage (Developed across 2.2-megohm resistor)...	-0.6	volt
Plate Resistance (Approx.).....	0.15	megohm
Transconductance (Grid No.3 to Plate).....	800	μmhos
Grid-No.1 Voltage (Approx.) for grid-No.3-to-plate transconductance of 20 μmhos.....	-3	volts
Plate Current.....	0.55	ma
Grids-No.2-and-No.4 Current.....	2.8	ma

**Maximum Circuit Value:**

Grid-No.3-Circuit Resistance.....	10 <i>max</i>	megohm
-----------------------------------	---------------	--------

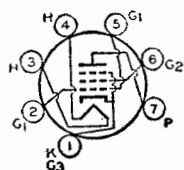

### POWER PENTODE

Miniature type used in the audio output stage of radio and television receivers employing series-connected heater strings. Outline 13, OUTLINES SECTION. Heater volts (ac/dc),

## 12EH5

12.6; amperes, 0.6; warm-up time (average), 11 seconds. Peak heater-cathode voltage when the heater is negative with respect to the cathode, 300 *max* volts. Except for heater and heater-cathode ratings, this type is identical with miniature type 6EH5.

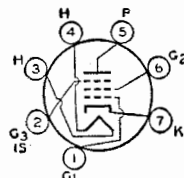

### REMOTE-CUTOFF PENTODE

Miniature type used as if and rf amplifier in low B+ voltage automobile radio receivers operating directly from 12-volt storage-battery systems. Outline 11, OUTLINES SECTION. Tube

## 12EK6

requires miniature seven-contact socket and may be mounted in any position.

HEATER-VOLTAGE RANGE (AC/DC)*	10.0 to 15.9	volts
HEATER CURRENT (Approx.) at 12.6 Volts	0.19	ampere
DIRECT INTERELECTRODE CAPACITANCES:		
Grid No.1 to Plate	0.036 max	$\mu\text{f}$
Grid No.1 to Cathode, Heater, Grid No.2, Grid No.3, and Internal Shield	10	$\mu\text{f}$
Plate to Cathode, Heater, Grid No.2, Grid No.3, and Internal Shield	5	$\mu\text{f}$

\*For longest life, it is recommended that the heater be operated within the voltage range of 11 to 14 volts.

## CLASS A<sub>1</sub> AMPLIFIER

### Maximum Ratings, (Design-Maximum Values):

PLATE VOLTAGE	16 max	volts
GRID No.3 (SUPPRESSOR GRID)	Connect to cathode at socket	
GRID-No.2 (SCREEN-GRID) VOLTAGE	16 max	volts
GRID-No.1 (CONTROL-GRID) VOLTAGE, Positive-bias value	0 max	volts
PEAK HEATER-CATHODE VOLTAGE:		
Heater negative with respect to cathode	16 max	volts
Heater positive with respect to cathode	16 max	volts

### Characteristics with 12.6 Volts on Heater:

Plate Voltage	12.6	volts
Grid No.3 and Internal Shield	Connected to cathode at socket	
Grid-No.2 Voltage	12.6	volts
Grid-No.1 Supply Voltage	0	volts
Grid-No.1 Resistor (Bypassed)	2.2	megohms
Plate Resistance (Approx.)	50000	ohms
Transconductance	4200	$\mu\text{mhos}$
Grid-No.1 Voltage (Approx.) for plate current of 10 $\mu\text{a}$	-3.8	volts
Plate Current	4	ma
Grid-No.2 Current	1.7	ma

### Maximum Circuit Value:

Grid-No.1-Circuit Resistance	10 max	megohms
------------------------------	--------	---------

### AVERAGE CHARACTERISTICS

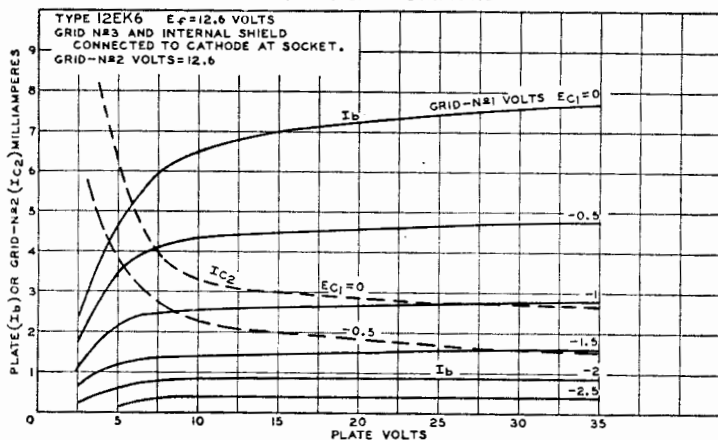

## TWIN-DIODE— HIGH-MU TRIODE

Miniature type used as combined detector and audio-amplifier tube in low B+ voltage automobile-radio receivers operating directly from 12-volt storage-battery systems. Outline 11, OUTLINES SECTION. Tube requires miniature seven-contact socket and may be mounted in any position. Heater voltage range (ac/dc), 10.0 to 15.9; amperes (approx.) at 12.6 volts, 0.15. Characteristics: amplification factor, 55; plate resistance (approx.), 45000 ohms; transconductance, 1200  $\mu\text{mhos}$ ; for plate volts, 12.6; grid volts, 0; plate  $\mu\text{a}$ , 750.

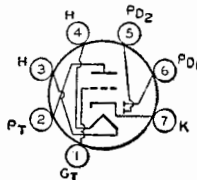

# 12EL6

**TRIODE UNIT AS CLASS A<sub>1</sub> AMPLIFIER**

**Maximum Ratings:**

PLATE VOLTAGE.....	30 <i>max</i>	volts
CATHODE CURRENT.....	20 <i>max</i>	ma
<b>PEAK HEATER-CATHODE VOLTAGE:</b>		
Heater negative with respect to cathode.....	30 <i>max</i>	volts
Heater positive with respect to cathode.....	30 <i>max</i>	volts

**Typical Operation As Resistance-Coupled Amplifier with 12.6 Volts on Heater:**

Plate Supply Voltage.....	12.6	volts
Grid Voltage.....	0	volts
Plate Load Resistor.....	1	megohm
Grid Resistor.....	1	megohm
Grid Resistor of Following Stage.....	2	megohms
Input Capacitor.....	0.02	μf
Output Capacitor.....	0.01	μf
Voltage Gain at 400 cps with rms output voltage of 1 volt.....	16	

**Maximum Circuit Value:**

Grid-Circuit Resistance.....	10 <i>max</i>	megohms
------------------------------	---------------	---------

**DIODE UNITS (Each Unit)**

**Maximum Ratings:**

PLATE CURRENT.....	1 <i>max</i>	ma
--------------------	--------------	----

**DIODE—POWER TETRODE**

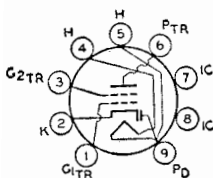

Miniature type used as combined detector and driver for transistorized power output stage in low B+ voltage automobile-radio receivers operating directly from 12-volt storage-battery systems. Outline 14, OUTLINES SECTION. Heater voltage range (ac/dc), 10.0 to 15.9; amperes (approx.) at 12.6 volts, 0.5. Characteristics for tetrode unit: plate resistance (approx.), 4000 ohms; transconductance, 5000

**12EM6**

μmhos; plate and grid-No.2 volts, 12.6; grid-No.1 resistor (bypassed), 2.2 megohms; plate ma., 6; grid-No.2 ma., 1. Maximum ratings, tetrode unit: plate and grid-No.2 volts, 30 *max*; plate dissipation, 0.5 *max* watts; peak heater-cathode volts, 30 *max*. Maximum ratings, tetrode unit: plate ma., 10 *max*. Tube requires miniature nine-contact socket and may be operated in any position. Type 12EM6 is a DISCONTINUED type listed for reference only.

**BEAM POWER TUBE**

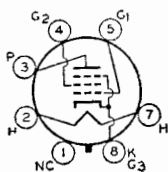

Glass octal type used as vertical-deflection-amplifier tube in television receivers employing series-connected heater strings. Outline 22, OUTLINES SECTION. Tube requires octal socket and may be operated in any position. This tube may be supplied with pin 1 omitted. Heater volts (ac/dc), 12.6; amperes, 0.6; warm-up time (average), 11 seconds. Characteristics: plate resistance (approx.), 28000 ohms; transconductance, 8000 μmhos; for plate volts, 200; grid-No.2 volts, 110; grid-No.1 volts, -9.5; plate ma., 50; grid-No.2 ma., 2.2. This type is used principally for renewal purposes.

**12EN6**

**VERTICAL-DEFLECTION AMPLIFIER**

*For operation in a 525-line, 30-frame system*

**Maximum Ratings, (Design-Maximum Values):**

DC PLATE VOLTAGE.....	300 <i>max</i>	300 <i>max</i>	volts
PEAK POSITIVE-PULSE PLATE VOLTAGE*.....	1200 <i>max</i>	1200 <i>max</i>	volts
DC GRID-No.2 (SCREEN-GRID) VOLTAGE.....	150 <i>max</i>	-	volts
PEAK NEGATIVE-PULSE GRID-No.1 (CONTROL-GRID) VOLTAGE.....	250 <i>max</i>	250 <i>max</i>	volts
PEAK CATHODE CURRENT.....	175 <i>max</i>	175 <i>max</i>	ma
AVERAGE CATHODE CURRENT.....	50 <i>max</i>	50 <i>max</i>	ma
PLATE DISSIPATION.....	7 <i>max</i>	7.5 <i>max</i>	watts
GRID-No.2 INPUT.....	1.25 <i>max</i>	-	watts
<b>PEAK HEATER-CATHODE VOLTAGE:</b>			
Heater negative with respect to cathode.....	300 <i>max</i>	300 <i>max</i>	volts
Heater positive with respect to cathode.....	200 <i>max</i>	200 <i>max</i>	volts

**Maximum Circuit Values:**

Grid-No.1-Circuit Resistance . . . . .	2.2 max	Triode Connection†	2.2 max megohms
† Grid No.2 connected to plate.			

- ▲ The duration of the voltage pulse must not exceed 15 per cent of one vertical scanning cycle. In a 525-line, 30-frame system, 15 per cent of one vertical scanning cycle is 2.5 milliseconds.
- The dc component must not exceed 200 volts.
- The dc component must not exceed 100 volts.

**DIODE—  
REMOTE-CUTOFF PENTODE**

**12EQ7**

Miniature type used as combined amplifier and AM detector in AM and AM/FM radio receivers. Outline 14, OUTLINES SECTION. Tube requires miniature nine-contact socket and may be operated in any position. Heater volts (ac/dc,) 12.6; amperes, 0.15. Except for heater rating, this type is identical with miniature type 6EQ7.

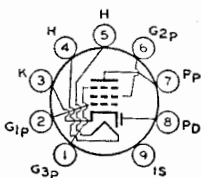

**HIGH-MU TRIODE**

**12F5-GT**

Glass octal type used in resistance-coupled amplifier circuits of ac/dc receivers. Outline 21, OUTLINES SECTION. This type may be supplied with pin No.1 omitted. Heater volts (ac/dc), 12.6; amperes, 0.15. Except for heater rating, this type is identical with glass-octal type 6F5-GT. Type 12F5-GT is a DISCONTINUED type listed for reference only.

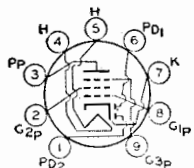

**TWIN DIODE—**

**REMOTE-CUTOFF PENTODE**

**12F8**

Miniature type used as combined detector and af voltage amplifier in low B+ voltage automobile radio receivers operating directly from 12-volt storage-battery systems. Outline 12, OUTLINES SECTION. Tube requires miniature nine-contact socket and may be mounted in any position.

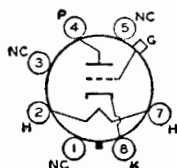

HEATER-VOLTAGE RANGE (AC/DC)* . . . . .	10.0 to 15.9	volts
HEATER CURRENT (Approx.) at 12.6 volts . . . . .	0.15	ampere
DIRECT INTERELECTRODE CAPACITANCES (Approx.):		

Pentode Unit:		
Grid No.1 to Plate . . . . .	0.06	μf
Grid No.1 to Cathode, Heater, Grid No.2, and Grid No.3 . . . . .	4.5	μf
Plate to Cathode, Heater, Grid No.2, and Grid No.3 . . . . .	3.0	μf
Plate of Diode Unit No.1 to Plate of Diode Unit No.2 . . . . .	0.3	μf

\*For longest life, it is recommended that the heater be operated within the voltage range of 11 to 14 volts.

**PENTODE UNIT AS CLASS A<sub>1</sub> AMPLIFIER**

<b>Maximum Ratings:</b>		
PLATE VOLTAGE . . . . .	30 max	volts
GRID NO.3 (SUPPRESSOR GRID) . . . . .	Connect to cathode at socket	
GRID-NO.2 (SCREEN-GRID) VOLTAGE . . . . .	30 max	volts
GRID-NO.1 (CONTROL-GRID) VOLTAGE, Positive-bias value . . . . .	0 max	volts
<b>PEAK HEATER-CATHODE VOLTAGE:</b>		
Heater negative with respect to cathode . . . . .	30 max	volts
Heater positive with respect to cathode . . . . .	30 max	volts

**Typical Operation with 12.6 Volts on Heater:**

Plate Voltage . . . . .	12.6	volts
Grid No.3 . . . . .	Connected to cathode at socket	
Grid-No.2 Voltage . . . . .	12.6	volts
Grid-No.1 Voltage . . . . .	0	volts
Plate Resistance (Approx.) . . . . .	0.33	megohm
Transconductance . . . . .	1000	μmhos
Grid-No.1 Voltage (Approx.) for transconductance of 10 μmhos . . . . .	-5	volts
Plate Current . . . . .	1	ma
Grid-No.2 Current . . . . .	0.38	ma



**Maximum Circuit Value:**

Grid-No.1-Circuit Resistance..... **10 max** megohms

**Maximum Rating:**

**DIODE UNITS**

PLATE CURRENT (Each unit)..... **1 max** ma

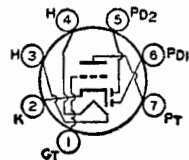

**TWIN DIODE—LOW-MU TRIODE**

Miniature type used as combined detector and af amplifier in low B+ voltage automobile radio receivers operating directly from 12-volt storage-battery systems. Outline 11, OUT-

**12FK6**

LINES SECTION. Tube requires miniature seven-contact socket and may be mounted in any position.

HEATER-VOLTAGE RANGE (AC/DC)..... **10.0 to 15.9** volts  
 HEATER CURRENT (Approx.) at 12.6 volts..... **0.15** ampere

**DIRECT INTERELECTRODE CAPACITANCES (Approx.):**

Triode Grid to Triode Plate..... **1.6**  $\mu\mu\text{f}$   
 Triode Grid to Cathode and Heater..... **1.8**  $\mu\mu\text{f}$   
 Triode Plate to Cathode and Heater..... **0.7**  $\mu\mu\text{f}$   
 Plate of Diode Unit No.1 to Plate of Diode Unit No.2..... **0.9**  $\mu\mu\text{f}$

• For longest life, it is recommended that the heater be operated within the voltage range of 11 to 14 volts.

**Maximum Ratings: TRIODE UNIT AS CLASS A<sub>1</sub> AMPLIFIER**

PLATE VOLTAGE..... **16 max** volts  
 GRID VOLTAGE.....  
     Positive-bias value..... **0 max** volts  
     Negative-bias value..... **-16 max** volts  
 PEAK HEATER-CATHODE VOLTAGE:  
     Heater negative with respect to cathode..... **16 max** volts  
     Heater positive with respect to cathode..... **16 max** volts

**Characteristics with 12.6 Volts on Heater:**

Plate Voltage..... **12.6** volts  
 Grid-Supply Voltage..... **0** volts  
 Grid Resistor (Bypassed)..... **2.2** megohms  
 Plate Resistance (Approx.)..... **6200** ohms  
 Transconductance..... **1200**  $\mu\text{mhos}$   
 Amplification Factor..... **7.4**  
 Plate Current..... **1.3** ma  
 Grid Voltage (Approx.) for plate current of 10  $\mu\text{a}$ ..... **-4** volts

**Maximum Circuit Value:**

Grid-Circuit Resistance..... **10 max** megohms

**Maximum Ratings:**

**DIODE UNITS**

LATE CURRENT (Each unit)..... **1 max** ma

**AVERAGE CHARACTERISTICS  
 TRIODE UNIT**

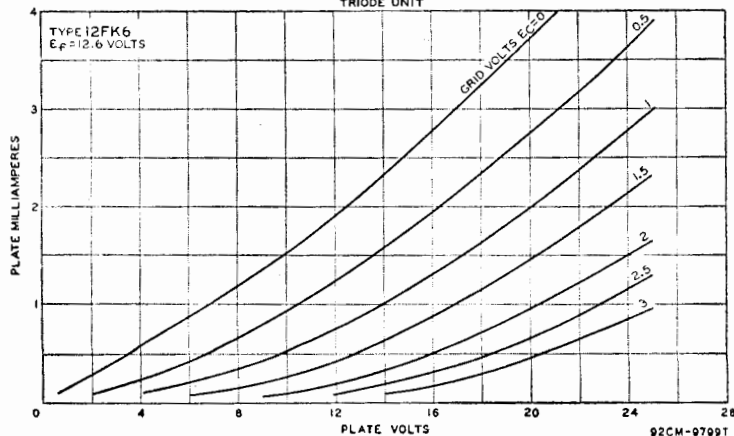

**TWIN DIODE—  
MEDIUM-MU TRIODE**

**12FM6**

Miniature type used as combined detector and af-voltage amplifier in low B+ voltage automobile-radio receivers operating directly from 12-volt storage-battery systems. Outline

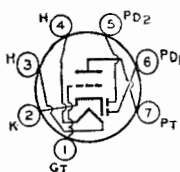

11, OUTLINES SECTION. Tube requires miniature seven-contact socket and may be mounted in any position.

HEATER-VOLTAGE RANGE (AC/DC)*	10.0 to 15.9	volts
HEATER CURRENT (Approx.) at 12.6 volts	0.15	ampere
AMPLIFICATION FACTOR*	10	
PLATE RESISTANCE (Approx.)*	7700	ohms
TRANSCONDUCTANCE*	1300	μmhos

\* For longest life, it is recommended that the heater be operated within the voltage range of 11 to 14 volts.  
 † For triode unit. Plate volts, 12.6; grid resistor (bypassed), 2.2 megohms; plate ma., 1.

**TRIODE UNIT AS CLASS A<sub>1</sub> AMPLIFIER**

<b>Maximum Ratings:</b>		
PLATE VOLTAGE	30 max	volts
CATHODE CURRENT	20 max	ma
<b>PEAK HEATER-CATHODE VOLTAGE:</b>		
Heater negative with respect to cathode	30 max	volts
Heater positive with respect to cathode	30 max	volts

<b>Maximum Circuit Value:</b>		
Grid-Circuit Resistance	10 max	megohms

**DIODE UNITS (Each Unit)**

<b>Maximum Ratings:</b>		
PLATE CURRENT	1 max	ma

**HIGH-MU  
TWIN DOUBLE-PLATE TRIODE**

**12FQ8**

Miniature type used in frequency-divider and complex-wave-generator circuits of electronic musical instruments. Outline 12, OUTLINES SECTION. Tube requires miniature nine-contact socket and may be operated in any position.

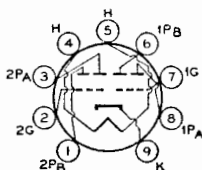

HEATER VOLTAGE (AC/DC)	12.6	volts
HEATER CURRENT	0.15	ampere

**FREQUENCY-DIVIDER AND COMPLEX-WAVE GENERATOR  
Each Unit**

<b>Maximum Ratings, (Design-Maximum Values):</b>		
PLATE A VOLTAGE	330 max	volts
PLATE B VOLTAGE	330 max	volts
GRID VOLTAGE, Positive-bias value	0 max	volts
PLATE A DISSIPATION	0.5 max	watt
PLATE B DISSIPATION	0.5 max	watt
<b>PEAK HEATER-CATHODE VOLTAGE:</b>		
Heater negative with respect to cathode	200 max	volts
Heater positive with respect to cathode	200 max	volts

° The dc component must not exceed 100 volts.

**CLASS A<sub>1</sub> AMPLIFIER**

<b>Characteristics, (Each Unit):<sup>■</sup></b>		
Plate Voltage	250	volts
Grid Voltage	-1.5	volts
Amplification Factor	95	
Plate Resistance (Approx.)	76000	ohms
Transconductance	1250	μmhos
Plate Current	1.5	ma

■ Using either plate A or plate B, with plate not in use connected to ground.

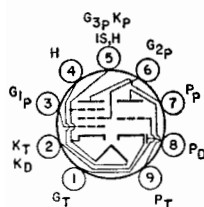

**DIODE—  
MEDIUM-MU TRIODE—  
REMOTE-CUTOFF PENTODE**

**12FR8**

Miniature type used as combined if amplifier, af amplifier, and second detector in low B+ voltage automobile radio receivers operating directly from 12-volt storage-battery systems. Out-

line 14, OUTLINES SECTION, except vertical dimensions are 3/16 inch shorter. Tube requires miniature nine-contact socket and may be operated in any position.

HEATER VOLTAGE RANGE (DC)°	10 to 15.9	volts
HEATER CURRENT (Approx.) at 12.6 volts	0.32	ampere

For longest life, it is recommended that the heater be operated within the voltage range of 11 to 14 volts.

**CLASS A<sub>1</sub> AMPLIFIER**

**Maximum Ratings:**

	<i>Triode Unit</i>	<i>Pentode Unit</i>	
PLATE VOLTAGE	16 max	16 max	volts
GRID-NO.2 (SCREEN-GRID) SUPPLY VOLTAGE	-	16 max	volts
GRID-NO.2 VOLTAGE	-	16 max	volts
PEAK HEATER-CATHODE VOLTAGE:			
Heater negative with respect to cathode	16 max	-	volts
Heater positive with respect to cathode	16 max	-	volts

**Characteristics with 12.6 Volts on Heater:**

	<i>Triode Unit</i>	<i>Pentode Unit</i>	
Plate Voltage	12.6	12.6	volts
Grid-No.2 Voltage	-	12.6	volts
Grid-No.1 Voltage	-0.6	-0.8	volt
Amplification Factor	10	-	
Plate Resistance (Approx.)	-	0.4	megohm
Transconductance	1200	2700	μmhos
Plate Current	1	1.9	ma
Grid-No.2 Current	-	0.7	ma
Grid-No.1 Voltage (Approx.), for transconductance of 30 μmhos	-	2.8	volts
Grid Voltage (Approx.), for plate current of 10 μa	3.5	-	volts

■ Developed across a 2.2-megohm grid-No.1 resistor.

**Maximum Circuit Values:**

	<i>Triode Unit</i>	<i>Pentode Unit</i>	
Grid-No.1-Circuit Resistance	10 max	10 max	megohms

**DIODE UNIT**

**Maximum Ratings:**

PLATE CURRENT	5 max	ma
---------------	-------	----

**Characteristics, Instantaneous Test Condition:**

Plate Current, for plate volts=10	2	ma
-----------------------------------	---	----

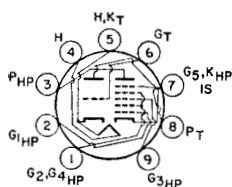

**MEDIUM-MU TRIODE—  
PENTAGRID CONVERTER**

**12FX8**

Miniature type used as combined rf amplifier and frequency converter in low B+ voltage automobile radio receivers operating directly from 12-volt storage-battery systems. Outline

14, OUTLINES SECTION, except vertical dimensions are 3/16 inch shorter. Tube requires miniature nine-contact socket and may be operated in any position.

HEATER VOLTAGE RANGE (DC)°	10 to 15.9	volts
HEATER CURRENT (Approx.) at 12.6 volts	0.27	ampere

For longest life, it is recommended that the heater be operated within the voltage range of 11 to 14 volts.

**HEPTODE UNIT AS CONVERTER**

**Maximum Ratings:**

PLATE VOLTAGE.....	16 <i>max</i>	volts
GRID-NO.3 (CONTROL-GRID) VOLTAGE:		
Negative-bias value.....	16 <i>max</i>	volts
Positive-bias value.....	0 <i>max</i>	volts
GRIDS-NO. 2 and No. 4 (SCREEN GRID) VOLTAGE.....	16 <i>max</i>	volts
PEAK HEATER-CATHODE VOLTAGE:		
Heater negative with respect to cathode.....	16 <i>max</i>	volts
Heater positive with respect to cathode.....	16 <i>max</i>	volts

**Typical Operation and Characteristics with 12.6 Volts on Heater:\***

Plate Voltage.....	12.6	volts
Grid-No.3 Voltage <sup>†</sup> .....	-0.5	volt
Grids-No.2 and No.4 Voltage.....	12.6	volts
RMS Grid-No.1 (Oscillator-Grid) Voltage.....	1.6	volts
Grid-No.1 Resistor.....	33000	ohms
Plate Resistance (Approx.).....	0.5	megohm
Conversion Transconductance.....	300	$\mu$ mhos
Grid-No.3 Voltage (Approx.).....		
For conversion transconductance of 10 $\mu$ mhos.....	-3	volts
Plate Current.....	290	$\mu$ a
Grids-No.2 and No.4 Current.....	1.25	ma

**Oscillator Characteristics (Not Oscillating):\***

Plate and Grids-No.2 and No.4 Voltage.....	12.6	volts
Grid-No.3 Voltage.....	0	volts
Grid-No.1 Voltage.....	0	volts
Amplification Factor (between grid No.1 and grids No.2 and No.4 connected to plate).....	9	
Transconductance (between grid No.1 and grids No.2 and No.4 connected to plate).....	3600	$\mu$ mhos
Cathode Current.....	4.4	ma
Grid-No.1 Voltage (Approx.) for plate $\mu$ a=10.....	-4.5	volts

\* With grids No.2 and No.4 connected to plate and with 12.6 volts on heater.

**Maximum Circuit Values:**

Grid-No.3-Circuit Resistance.....	10 <i>max</i>	megohms
-----------------------------------	---------------	---------

- † With self-excitation.
- Developed across a 2.2-megohm grid-No.3 resistor.

**TRIODE UNIT AS CLASS A, AMPLIFIER**

**Maximum Ratings:**

PLATE VOLTAGE.....	16 <i>max</i>	volts
--------------------	---------------	-------

**Characteristics with 12.6 Volts on Heater:**

Plate Voltage.....	12.6	volts
Grid Voltage.....	-0.8	volt
Amplification Factor.....	10	
Plate Resistance (Approx.).....	7150	ohms
Transconductance.....	1400	$\mu$ mhos
Plate Current.....	1.3	ma
Grid Voltage (Approx.) For plate $\mu$ a=10.....	-3.2	volts

† Developed across a 2.2 megohm grid resistor

# 12GA6

**PENTAGRIDS CONVERTER**

Miniature type used as converter in low B+ voltage automobile radio receivers operating directly from 12-volt storage-battery systems. Outline 11, OUTLINES SECTION. Tube requires miniature seven-contact socket and may be operated in any position.

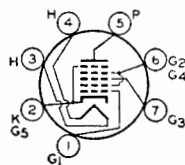

HEATER VOLTAGE RANGE (DC) <sup>°</sup> .....	10 to 15.9	volts
HEATER CURRENT (Approx.), at 12.6 volts.....	0.15	ampere

<sup>°</sup> For longest life, it is recommended that the heater be operated within the voltage range of 11 to 14 volts.

## CONVERTER

### Maximum Ratings, (Design-Maximum Values):

PLATE VOLTAGE.....	16 max	volts
GRID-NO.3 (CONTROL-GRID) VOLTAGE:		
Negative-bias value.....	16 max	volts
Positive-bias value.....	0 max	volts
GRIDS-NO.2 and NO.4 (SCREEN-GRID) VOLTAGE.....	16 max	volts
PEAK HEATER-CATHODE VOLTAGE:		
Heater negative with respect to cathode.....	16 max	volts
Heater positive with respect to cathode.....	16 max	volts

### Typical Operation and Characteristics with 12.6 Volts on Heater (Separate excitation):<sup>o</sup>

Plate Voltage.....	12.6	volts
Grids-No.2 and No.4 Voltage.....	12.6	volts
Grid-No.3 Supply Voltage.....	0	volts
Grid-No.3 Resistor (Bypassed).....	2.2	megohms
RMS Grid-No.1 (Oscillator-Grid) Voltage.....	1.6	volts
Grid-No.1 Resistor.....	33000	ohms
Plate Resistance (Approx.).....	1	megohm
Conversion Transconductance.....	140	$\mu$ mhos
Grid-No.3 Voltage (Approx.):		
For conversion transconductance of 5 $\mu$ mhos.....	-3	volts
For conversion transconductance of 20 $\mu$ mhos.....	-2.5	volts
Plate Current.....	0.3	ma
Grids-No.2 and No.4 Current.....	0.8	ma
Grid-No.1 Current.....	0.06	ma

### Oscillator Characteristics (Not Oscillating) with 12.6 Volts on Heater:<sup>n</sup>

Plate and Grids-No.2 and No.4 Voltage.....	12.6	volts
Grid-No.3 Voltage.....	0	volts
Grid-No.1 Voltage.....	0	volts
Amplification Factor, between grid No.1 and grids No.2 and No.4 connected to plate.....	9	
Transconductance, between grid No.1 and grids No.2 and No.4 connected to plate.....	2400	$\mu$ mhos
Cathode Current.....	3.6	ma
Grid-No.1 Voltage (Approx.) for plate current of 10 $\mu$ a.....	-3.3	volts

### Maximum Circuit Values:

Grid-No.3-Circuit Resistance.....	10 max	megohms
-----------------------------------	--------	---------

<sup>o</sup> The characteristics shown with separate excitation correspond closely with those obtained in a self-excited oscillator circuit operating with zero-bias.

<sup>n</sup> With grids No.2 and No.4 connected to plate.

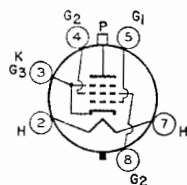

## BEAM POWER TUBE

Glass octal type used as horizontal-deflection amplifier in television receivers employing series-connected heater strings. Outline 37, OUTLINES SECTION. Tube requires octal socket and may be operated in any position.

# 12GC6

HEATER VOLTAGE (AC/DC).....	12.6	volts
HEATER CURRENT.....	0.6	ampere
HEATER WARM-UP TIME (AVERAGE).....	11	seconds

### CLASS A<sub>1</sub> AMPLIFIER

#### Characteristics:

Plate Voltage.....	60	250	volts
Grid-No.2 (Screen-Grid) Voltage.....	150	150	volts
Grid-No.1 (Control-Grid) Voltage.....	0	-22.5	volts
Triode Amplification Factor, for plate and grid-No.2 voltages=150.....	-	4.1	
Plate Resistance (Approx.).....	-	20000	ohms
Transconductance.....	-	6600	$\mu$ mhos
Plate Current.....	345 <sup>o</sup>	75	ma
Grid-No.2 Current.....	30 <sup>o</sup>	2.4	ma
Grid-No.1 Voltage (Approx.), for plate current of 1 ma.....	-	-46	volts

## HORIZONTAL-DEFLECTION AMPLIFIER

*For operation in a 525-line, 30-frame system*

### Maximum Ratings, (Design-Maximum Values):

DC PLATE VOLTAGE.....	770 max	volts
PEAK POSITIVE-PULSE PLATE VOLTAGE <sup>1</sup> .....	6500 max	volts
PEAK NEGATIVE-PULSE PLATE VOLTAGE.....	1500 max	volts
DC GRID-NO.2 VOLTAGE.....	220 max	volts
PEAK NEGATIVE-PULSE GRID-NO.1 VOLTAGE.....	330 max	volts
PEAK CATHODE CURRENT.....	550 max	ma
AVERAGE CATHODE CURRENT.....	175 max	ma
PLATE DISSIPATION <sup>2</sup> .....	17.5 max	watts
GRID-NO.2 INPUT.....	4.5 max	watts
PEAK HEATER-CATHODE VOLTAGE:		
Heater negative with respect to cathode.....	200 max	volts
Heater positive with respect to cathode.....	200 max	volts
BULB TEMPERATURE (At hottest point).....	220 max	°C

### Maximum Circuit Values:

Grid-No.1-Circuit Resistance..... 1 max megohm

<sup>1</sup> This value can be measured by a method involving a recurrent waveform such that the maximum ratings will not be exceeded.

<sup>2</sup> This rating is applicable where the duration of the voltage pulse does not exceed 15 per cent of one horizontal scanning cycle. In a 525-line, 30-frame system, 15 per cent of one horizontal scanning cycle is 10 microseconds.

<sup>3</sup> An adequate bias resistor or other means is required to protect the tube in the absence of excitation.

<sup>4</sup> The dc component must not exceed 100 volts.

## 12GJ5

### BEAM POWER TUBE

Novar type used in horizontal-deflection-amplifier circuits of television receivers employing series-connected heater strings. Outline 55, OUTLINES SECTION. Tube requires novar nine-

contact socket and may be operated in any position. Heater volts (ac/dc), 12.6; amperes, 0.6; warm-up time (average), 11 seconds. Except for heater ratings, this type is identical with novar type 6GJ5.

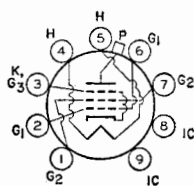

## 12GT5

### BEAM POWER TUBE

Novar type used as horizontal-deflection amplifier in television receivers employing series-connected heater strings. Outline 54, OUTLINES SECTION, except vertical dimensions

are 0.6 inch shorter. Tube requires octal socket and may be operated in any position. Heater volts (ac/dc), 12.6; amperes, 0.6; warm-up time (average), 11 seconds. Except for heater ratings, this tube is identical with novar type 6GT5.

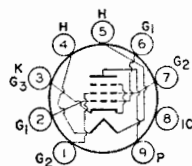

## 12GW6

### BEAM POWER TUBE

Glass octal type used as horizontal-deflection amplifier in high-efficiency deflection circuits of television receivers employing series-connected heater strings. Outline 37, OUTLINES

SECTION. Tube requires octal socket and may be operated in any position. Heater volts (ac/dc), 12.6; amperes, 0.6; heater warm-up time (average), 11 seconds. Except for heater ratings, this type is identical with glass octal type 6GW6.

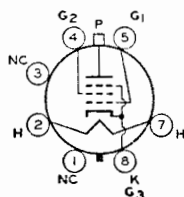

**TWIN DIODE**

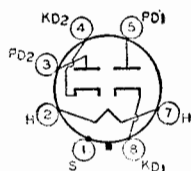

Metal type used as detector, low-voltage rectifier, or avc tube in ac/dc radio receivers. Outline 1, OUTLINES SECTION. Heater volts (ac/dc), 12.6; amperes, 0.15. Except for heater rating, this type is identical with metal type 6H6.

**12H6**

**MEDIUM-MU TRIODE**

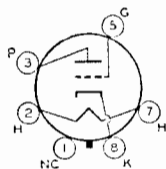

Glass octal type used as detector, amplifier, or oscillator in ac/dc radio equipment. Outline 24, OUTLINES SECTION. This type may be supplied with pin No.1 omitted. Heater volts (ac/dc), 12.6; amperes, 0.15. Except for heater rating and base, this type is identical with glass-octal type 6J5-GT. Type 12J5-GT is used principally for renewal purposes.

**12J5-GT**

**SHARP-CUTOFF PENTODE**

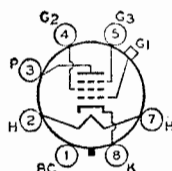

Glass octal type used as biased detector or high-gain audio amplifier in ac/dc radio receivers. Outline 23, OUTLINES SECTION. Heater volts (ac/dc), 12.6; amperes, 0.15. Except for heater rating, this type is identical with glass-octal type 6J7-GT. Type 12J7-GT is used principally for renewal purposes.

**12J7-GT**

**TWIN DIODE—POWER TETRODE**

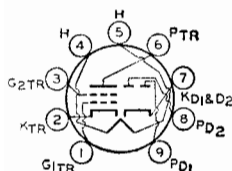

Miniature type used as combined detector and audio driver in low B+ voltage automobile radio receivers operating directly from 12-volt storage-battery systems. Outline 12, OUTLINES SECTION. Tube requires miniature nine-contact socket and may be mounted in any position. Heater voltage range (ac/dc), 10.0 to 15.9; amperes (approx.) at 12.6 volts, 0.325. Maximum ratings of tetrode unit as audio driver: plate volts, grid-No.2 volts, peak heater-cathode volts, 30 max (each). This type is used principally for renewal purposes.

**12J8**

**Typical Operation with 12.6 Volts on Heater:**

Plate Voltage	12.6	volts
Grid-No.2 Voltage	12.6	volts
Grid-No.1 (Control-Grid) Voltage	0	volts
Peak AF Grid-No.1 Voltage	2.26	volts
Grid-No.1 Resistor	2.2	megohms
Grid-No.1-Resistor Bypass Capacitor	1	μf
Zero-Signal Plate Current	12	ma
Zero-Signal Grid-No.2 Current	1.5	ma
Plate Resistance (Approx.)	6000	ohms
Transconductance	5500	ambos
Load Resistance	2700	ohms
Total Harmonic Distortion	5	per cent
Maximum-Signal Power Output	20	mW

**Maximum Circuit Value:**

Grid-No.1-Circuit Resistance	10 max	megohms
------------------------------	--------	---------

**DIODE UNITS (Each Unit)**

<b>Maximum Ratings:</b>		
PLATE CURRENT	5 max	ma
PEAK HEATER-CATHODE VOLTAGE:		
Heater negative with respect to cathode	30 max	volts
Heater positive with respect to cathode	30 max	volts

**POWER TETRODE**

**12K5**

Miniature type used as power amplifier driver in low B+ voltage automobile radio receivers operating directly from 12-volt storage-battery systems. Outline 13, OUTLINES

SECTION. Tube requires miniature seven-contact socket and may be mounted in any position. Heater-voltage range (ac/dc), 10.0 to 15.9; amperes (approx.) at 12.6 volts, 0.4. Maximum ratings and characteristics are the same as those of the tetrode unit of miniature type 12DL8.

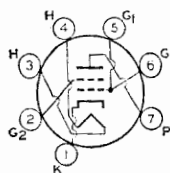

**REMOTE-CUTOFF PENTODE**

**12K7-GT**

Glass octal type used as rf or if amplifier in ac/dc radio receivers particularly those employing ave. Outline 23, OUTLINES SECTION. Heater volts (ac/dc), 12.6; amperes, 0.15. Except for heater rating, this type is identical with glass octal type 6K7-GT. Type 12K7-GT is used principally for renewal purposes

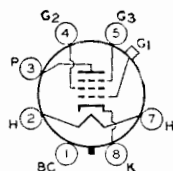

**TRIODE—HEXODE CONVERTER**

**12K8**

Metal type used as combined triode oscillator and hexode mixer in ac/dc radio receivers. Outline 5, OUTLINES SECTION. Heater volts (ac/dc), 12.6; amperes, 0.15. Except for heater rating, this type is identical with metal type 6K8. Type 12K8 is used principally for renewal purposes.

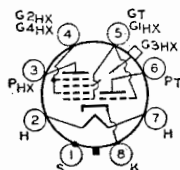

**BEAM POWER TUBE**

**12L6-GT**

Glass octal type used in audio output stages of television receivers employing series-connected heater strings. Outline 22, OUTLINES SECTION. This type may be supplied with pin No. 1 omitted. Heater volts (ac/dc), 12.6; amperes, 0.6; warm-up time (average), 11 seconds. Peak heater-cathode volts: heater negative with respect to cathode, 300 max; heater positive with respect to cathode, 200 max; (the dc component must not exceed 100 volts). Except for heater and heater-cathode ratings, this type is identical with glass octal type 50L6-GT. Type 12L6-GT is used principally for renewal purposes.

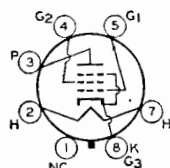

**TWIN DIODE—HIGH-MU TRIODE**

**12Q7-GT**

Glass octal type used as combined detector, amplifier, and ave tube in ac/dc radio receivers. Outline 23, OUTLINES SECTION. Heater volts (ac/dc), 12.6; amperes, 0.15. Except for heater rating, this type is identical with glass octal type 6Q7-GT. Type 12Q7-GT is used principally for renewal purposes.

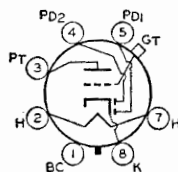

**BEAM POWER TUBE**

**12R5**

Miniature type used as a vertical deflection amplifier in television receivers employing series-connected heater strings. Outline 13, OUTLINES SECTION. Tube requires miniature seven-contact socket and may be mounted in any position.

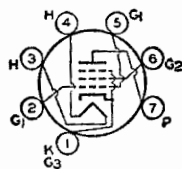



HEATER VOLTAGE (AC/DC).....	12.6	volts
HEATER CURRENT.....	0.6	ampere
HEATER WARM-UP TIME (Average).....	11	seconds
PLATE RESISTANCE (Approx.)*.....	13000	ohms
TRANSCONDUCTANCE*.....	7000	μmhos

\* For plate and grid-No.2 volts, 110; grid-No.1 volts, -8.5, plate ma., 40; grid-No.2 ma., 3.3.

### VERTICAL DEFLECTION AMPLIFIER

*For operation in a 525-line, 30-frame system*

#### Maximum Ratings:

DC PLATE VOLTAGE.....	150 max	volts
PEAK POSITIVE-PULSE PLATE VOLTAGE† (Absolute Maximum).....	1500*max	volts
GRID-NO.2 (SCREEN-GRID) VOLTAGE.....	150 max	volts
PEAK NEGATIVE-PULSE GRID-NO.1 (CONTROL-GRID) VOLTAGE.....	-150 max	volts
PEAK CATHODE CURRENT.....	155 max	ma
AVERAGE CATHODE CURRENT.....	45 max	ma
PLATE DISSIPATION.....	4.5 max	watts
GRID-NO.2 INPUT.....	1 max	watt
<b>PEAK HEATER-CATHODE VOLTAGE:</b>		
Heater negative with respect to cathode.....	300 max	volts
Heater positive with respect to cathode.....	200*max	volts

#### Maximum Circuit Value:

Grid-No.1-Circuit Resistance:	
For cathode-bias operation.....	2.2 max megohms

† The duration of the voltage pulse must not exceed 15 per cent of one vertical scanning cycle. In a 525-line, 30-frame system, 15 per cent of one vertical scanning cycle is 2.5 milliseconds.

▲ Under no circumstances should this absolute value be exceeded.

■ The dc component must not exceed 100 volts.

### TRIPLE DIODE—HIGH-MU TRIODE

Glass octal type used as audio amplifier, AM detector, and FM detector in AM/FM receivers. Outline 21, OUTLINES SECTION, except over-all length is 3-9/16 max inches and seated height is 3 max inches. Heater volts (ac/dc), 12.6; amperes, 0.15. Except for heater rating, this type is identical with glass octal type 6S8-GT. Type 12S8-GT is a DISCONTINUED type listed for reference only.

**12S8-GT**

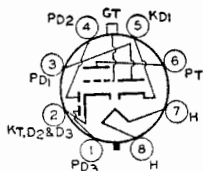

### PENTAGRID CONVERTER

Metal type 12SA7 and glass octal type 12SA7-GT used as converter in ac/dc receivers. Outlines 3 and 22, respectively, OUTLINES SECTION. Heater volts (ac/dc), 12.6; amperes, 0.15. Except for heater ratings, these types are identical with metal type 6SA7 and glass octal type 6SA7-GT. Type 12SA7-GT is used principally for renewal purposes.

**12SA7**

**12SA7-GT**

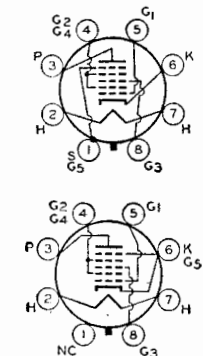

### HIGH-MU TWIN TRIODE

Metal type used as phase inverter or voltage amplifier in ac/dc radio equipment. Outline 3, OUTLINES SECTION. Heater volts (ac/dc), 12.6; amperes, 0.15. Except for heater rating, this type is identical with metal type 6SC7.

**12SC7**

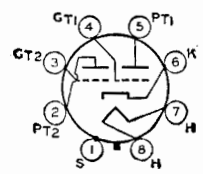

**HIGH-MU TRIODE**

**12SF5**  
**12SF5-GT**

Metal type 12SF5 and glass octal type 12SF5-GT used in resistance-coupled amplifier circuits of ac/dc radio equipment. Outline 3 and 22, respectively, **OUTLINES SECTION**.

Heater volts (ac/dc), 12.6; amperes, 0.15. Except for heater rating, these types are identical with metal type 6SF5 and glass octal type 6SF5-GT, respectively. Type 12SF5-GT is a **DISCONTINUED** type listed for reference only.

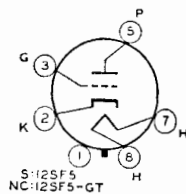

**DIODE—REMOTE-CUTOFF PENTODE**

**12SF7**

Metal type used as combined rf or if amplifier and detector or avc tube in ac/dc radio receivers. Outline 3, **OUTLINES SECTION**. Heater volts (ac/dc), 12.6; amperes, 0.15. Except for heater rating, this type is identical with metal type 6SF7. Type 12SF7 is used principally for renewal purposes.

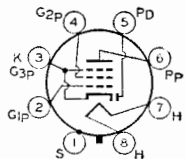

**SEMIREMOTE-CUTOFF PENTODE**

**12SG7**

Metal type used as rf amplifier in ac/dc receivers involving high-frequency, wide-band applications. Outline 3, **OUTLINES SECTION**. Heater volts (ac/dc), 12.6; amperes, 0.15. Except for heater rating, this type is identical with metal type 6SG7.

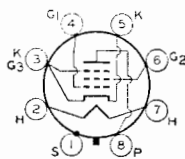

**SHARP-CUTOFF PENTODE**

**12SH7**

Metal type used as rf amplifier in ac/dc receivers involving high-frequency, wide-band applications and as limiter tube in FM equipment. Outline 3, **OUTLINES SECTION**. Heater volts (ac/dc), 12.6; amperes, 0.15. Except for heater rating, this type is identical with metal type 6SH7. Type 12SH7 is used principally for renewal purposes.

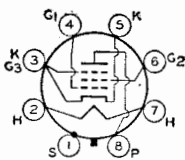

**SHARP-CUTOFF PENTODE**

**12SJ7**  
**12SJ7-GT**

Metal type 12SJ7 and glass-octal type 12SJ7-GT used as rf amplifiers and biased detectors in ac/dc radio receivers. Outlines 3 and 24, respectively, **OUTLINES SECTION**.

Heater volts (ac/dc), 12.6; amperes, 0.15. Except for heater rating, these types are identical with metal type 6SJ7 and glass-octal type 6SJ7-GT. Type 12SJ7-GT is a **DISCONTINUED** type listed for reference only.

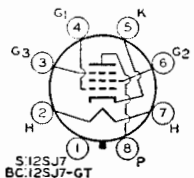

**REMOTE-CUTOFF PENTODE**

**12SK7**  
**12SK7-GT**

Metal type 12SK7 and glass octal type 12SK7-GT used as rf and if amplifiers in ac/dc radio receivers. Outlines 3 and 24, respectively, **OUTLINES SECTION**. Heater volts

(ac/dc), 12.6; amperes, 0.15. Except for heater rating, these types are identical with metal type 6SK7 and glass octal type 6SK7-GT. Type 12SK7-GT is used principally for renewal purposes.

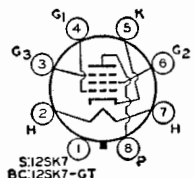

**HIGH-MU TWIN TRIODE**

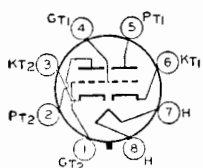

Glass octal type used as phase inverter or resistance-coupled amplifier in ac/dc radio equipment. Outline 22, OUTLINES SECTION. Heater volts (ac/dc), 12.6; amperes, 0.15. Except for heater rating, this type is identical with glass octal type 6SL7-GT.

**12SL7-GT**

**MEDIUM-MU TWIN TRIODE**

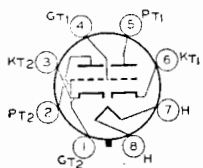

Glass octal types used as combined vertical oscillators and vertical deflection amplifiers, and as horizontal deflection oscillators in television receivers. May also be used in multivibrator or resistance-coupled amplifier circuits in radio receivers. Outline 22, OUTLINES SECTION. Heater volts (ac/dc), 12.6; amperes, 0.3. Except for heater rating, these types are identical with glass octal types 6SN7-GT and 6SN7-GTB, respectively.

**12SN7-GT**  
**12SN7-GTA**

**TWIN DIODE—HIGH-MU TRIODE**

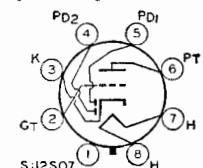

S:12SQ7  
BC:12SQ7-GT

Metal type 12SQ7 and glass octal type 12SQ7-GT used as combined detector, amplifier, and avc tube in ac/dc radio receivers. Outlines 3 and 24, respectively, OUTLINES SECTION.

**12SQ7**  
**12SQ7-GT**

Heater volts (ac/dc), 12.6; amperes, 0.15. Except for heater rating, these types are identical with metal type 6SQ7 and glass octal type 6SQ7-GT.

**TWIN DIODE—MEDIUM-MU TRIODE**

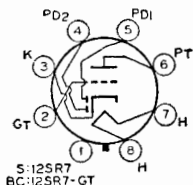

S:12SR7  
BC:12SR7-GT

Metal type 12SR7 and glass octal type 12SR7-GT used as combined detector, amplifier, and avc tube in ac/dc radio receivers. Outlines 3 and 22, respectively, OUTLINES SECTION. Heater volts (ac/dc), 12.6; amperes, 0.15. Except for heater rating, type 12SR7 is identical with type 6SR7, and type 12SR7-GT is electrically identical with type 6SR7 except for interelectrode capacitances. Type 12SR7 is used principally for renewal purposes. The 12SR7-GT is a DISCONTINUED type listed for reference only.

**12SR7**  
**12SR7-GT**

**MEDIUM-MU TWIN TRIODE**

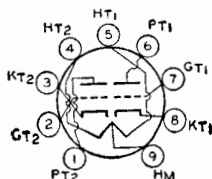

Miniature type used as general-purpose amplifier tube in automobile-radio receivers operating directly from 12-volt storage-battery systems. Outline 12, OUTLINES SECTION. Tube requires miniature nine-contact socket and may be mounted in any position. Heater voltage range (ac/dc), 10.0 to 15.9; amperes (approx.) at 12.6 volts, 0.15. Maximum ratings (each unit) as class A<sub>1</sub> amplifier: plate volts, 30 max; cathode ma., 15 max; peak heater-cathode volts, 30 max. This type is used principally for renewal purposes.

**12U7**

**CLASS A<sub>1</sub> AMPLIFIER (Each Unit)**

**Maximum Ratings:**

PLATE VOLTAGE.....	30 <i>max</i>	volts
CATHODE CURRENT.....	15 <i>max</i>	ma
<b>PEAK HEATER-CATHODE VOLTAGE:</b>		
Heater negative with respect to cathode.....	30 <i>max</i>	volts
Heater positive with respect to cathode.....	30 <i>max</i>	volts

**Characteristics:**

Plate Voltage.....	12.6	volts
Grid Voltage.....	0	volts
Amplification Factor.....	20	
Plate Resistance (Approx.).....	12500	ohms
Transconductance.....	1600	μmhos
Plate Current.....	1	ma
Grid Voltage (Approx.) for plate current of 10 μa.....	-1.5	volts

**Maximum Circuit Values:**

<b>Grid-Circuit Resistance:</b>		
For fixed-bias operation.....	0.25 <i>max</i>	megohm
For cathode-bias operation.....	1 <i>max</i>	megohm

**BEAM POWER TUBE**

**12V6-GT**

Glass octal type used as output amplifier primarily in automobile radio receivers operating from a 12-volt storage battery. Outline 22, OUTLINES SECTION. Tube requires octal socket

and may be mounted in any position. Heater volts (ac/dc), 12.6; amperes, 0.225. Except for heater rating, this type is identical with glass octal type 6V6-GT.

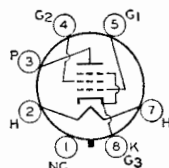

**BEAM POWER TUBE**

**12W6-GT**

Glass octal type used in the audio output stages of television receivers employing series-connected heater strings. Triode-connected, this type is used as a vertical deflection amplifier. Outline

22, OUTLINES SECTION. This type may be supplied with pin No.1 omitted. Heater volts (ac/dc), 12.6; amperes, 0.6; warm-up time (average), 11 seconds. Peak heater-cathode volts: heater negative with respect to cathode, 300 *max* (the dc component must not exceed 200 volts); heater positive with respect to cathode, 200 *max* (the dc component must not exceed 100 volts). Except for heater and heater-cathode ratings, this type is identical with glass octal type 6W6-GT.

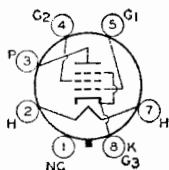

**FULL-WAVE VACUUM RECTIFIER**

**12X4**

Miniature type used in power supply of automobile radio receivers operating from a 12-volt storage battery. Outline 13, OUTLINES SECTION. Heater volts (ac/dc), 12.6; amperes, 0.3. Except for heater rating, this type is identical with miniature type 6X4.

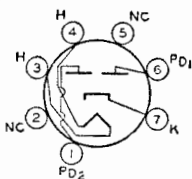

**HALF-WAVE VACUUM RECTIFIER**

**12Z3**

Glass types used in power supply of ac/dc receivers. Outline 34 or 35, OUTLINES SECTION. Tube requires four-contact socket. Heater volts (ac/dc), 12.6; amperes, 0.3. Maximum ratings as half-wave rectifier: peak inverse plate volts, 700 *max*; peak plate ma., 330 *max*; dc output ma., 55 *max*; peak heater-cathode volts, 350 *max*. This is a DISCONTINUED type listed for reference only.

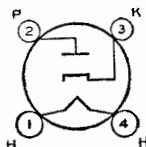

**DUAL TRIODE**

**13DE7**

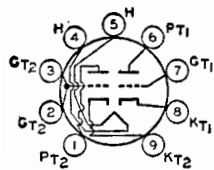

Miniature type used as combined vertical-deflection-oscillator and vertical-deflection-amplifier tube in television receivers employing series-connected heater strings. Unit No.1 is a

medium-mu triode unit used as a blocking oscillator in vertical-deflection circuits, and unit No.2 is a low-mu triode unit used as a vertical-deflection amplifier. Outline 14, OUTLINES SECTION. Heater volts (ac/dc), 13; amperes, 0.45; warm-up time (average), 11 seconds. Except for heater rating, this type is identical with miniature type 6DE7.

**DUAL TRIODE**

**13DR7**

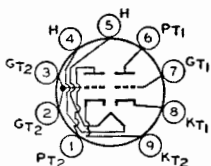

Miniature type containing high-mu and low-mu triodes; used as combined vertical-deflection-oscillator and vertical-deflection-amplifier tube in television receivers. Outline 14, OUT-

LINES SECTION. Tube requires miniature nine-contact socket and may be operated in any position. Heater volts (ac/dc), 13; amperes, 0.45; warm-up time (average), 11 seconds. Except for heater ratings, the 13DR7 is identical with type 6DR7.

**DUAL TRIODE**

**13EM7**

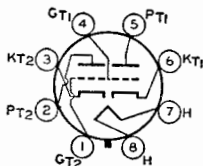

Glass octal type containing high-mu triode and high-perveance, low-mu triode; used as combined vertical-deflection oscillator and vertical-deflection amplifier in television receivers

employing series-connected heater strings. Heater volts (ac/dc), 13; amperes, 0.45; warm-up time (average), 11 seconds. Except for heater ratings, this type is identical with type 6EM7.

**MEDIUM-MU TRIODE**

**14A4**

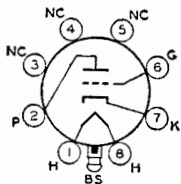

Glass lock-in type used as detector, amplifier, or oscillator in ac/dc radio receivers. Outline 15, OUTLINES SECTION. Tube requires lock-in socket. Heater volts (ac/dc), 12.6; amperes, 0.15. Except for heater rating and capacitances, this type is electrically identical with lock-in type 7A4 and metal type 6J5. Type 14A4 is a DISCONTINUED type listed for reference only.

**BEAM POWER TUBE**

**14A5**

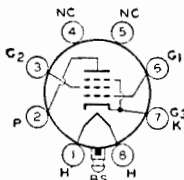

Glass lock-in type used as output amplifier in ac/dc radio receivers. Outline 15, OUTLINES SECTION. Tube requires lock-in socket. Heater volts (ac/dc), 12.6; amperes, 0.15. Typical operation and ratings as class A<sub>1</sub> amplifier: plate volts and grid-No.2 volts, 250 (300 max); plate dissipation, 7.5 watts; grid-No.2 input, 1.5 watts; grid-No.1 volts, -12.5; plate ma., 32;

grid-No.2 ma., 5.5; plate resistance, 70000 ohms; transconductance, 3000  $\mu$ mhos; load resistance 7500 ohms; output watts, 2.8. This is a DISCONTINUED type listed for reference only.

### REMOTE-CUTOFF PENTODE

Glass lock-in type used as rf or if amplifier in ac/dc radio receivers. Outline 15, OUTLINES SECTION. Tube requires lock-in socket. Heater volts (ac/dc), 12.6; amperes, 0.15. Except for heater rating and capacitances, this type is electrically identical with metal type 6SK7 and lock-in type 7A7. Type 14A7 is used principally for renewal purposes.

14A7

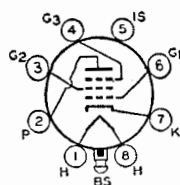

### MEDIUM-MU TWIN TRIODE

Glass lock-in type used as voltage amplifier or phase inverter in radio equipment. Outline 15, OUTLINES SECTION. Tube requires lock-in socket. Heater volts (ac/dc), 12.6; amperes, 0.15. Except for heater ratings, this type is electrically identical with lock-in type 7AF7. Type 14AF7 is used principally for renewal purposes.

14AF7

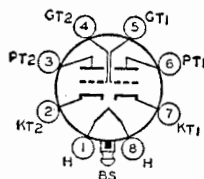

### TWIN DIODE—HIGH-MU TRIODE

Glass lock-in type used as combined detector, amplifier, and avc tube in ac/dc radio receivers. Outline 15, OUTLINES SECTION. Tube requires lock-in socket. Heater volts (ac/dc), 12.6; amperes, 0.15. Except for heater rating and capacitances, this type is electrically identical with lock-in type 7B6 and metal type 6SQ7. Type 14B6 is used principally for renewal purposes.

14B6

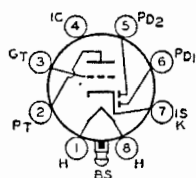

### PENTAGRID CONVERTER

Glass lock-in type used as converter in ac/dc radio receivers. Outline 15, OUTLINES SECTION. Tube requires lock-in socket. Heater volts (ac/dc), 12.6; amperes, 0.15. Except for heater rating and capacitances, this type is electrically identical with lock-in type 7B8 and metal type 6A8. Type 14B8 is a DISCONTINUED type listed for reference only.

14B8

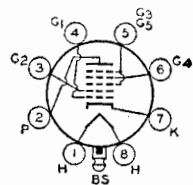

### BEAM POWER TUBE

Glass lock-in type used as output amplifier in ac/dc radio receivers. Outline 20, OUTLINES SECTION. Tube requires lock-in socket. Heater volts (ac/dc), 12.6; amperes, 0.225. Except for heater rating, this type is electrically identical with lock-in type 7C5 and metal type 6V6. Type 14C5 is a DISCONTINUED type listed for reference only.

14C5

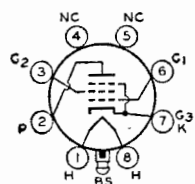

### SHARP-CUTOFF PENTODE

Glass lock-in type used as rf amplifier and biased detector in ac/dc radio receivers. Outline 15, OUTLINES SECTION. Tube requires lock-in socket. Heater volts (ac/dc), 12.6; amperes, 0.15. Typical operation and maximum ratings as class A<sub>1</sub> amplifier: plate volts, 250 (300 max); grid-No.2 volts, 100; plate dissipation, 1 max watt; grid-No.2 input, 0.1

14C7

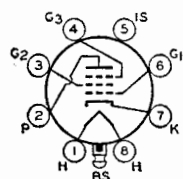

max watt; grid No.1 volts, -8; grid No.3 connected to cathode at socket; plate resistance, greater than 1 megohm; transconductance, 1575  $\mu$ mhos; plate ma., 2.2; grid-No.2 ma., 0.7. Within the limits of its maximum ratings, this type is similar in performance to metal types 6SJ7 and 12SJ7. Type 14C7 is used principally for renewal purposes.

### TWIN DIODE—MEDIUM-MU TRIODE

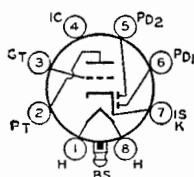

Glass lock-in type used as combined detector, amplifier, and avc tube in ac/dc radio receivers. Outline 15, OUTLINES SECTION. Tube requires lock-in socket. Heater volts, (ac/dc), 12.6; amperes, 0.15. Except for heater rating, this type is electrically identical with lock-in type 7E6 and miniature type 6BF6. Type 14E6 is a DISCONTINUED type listed for reference only.

**14E6**

### TWIN DIODE—REMOTE-CUTOFF PENTODE

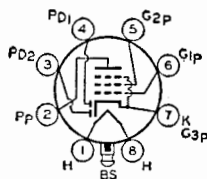

Glass lock-in type used as combined detector, amplifier, and avc tube in ac/dc receivers. Outline 15, OUTLINES SECTION. Tube requires lock-in socket. Heater volts (ac/dc), 12.6; amperes, 0.15. Except for heater rating, this type is electrically identical with lock-in type 7E7. Type 14E7 is a DISCONTINUED type listed for reference only.

**14E7**

### HIGH-MU TWIN TRIODE

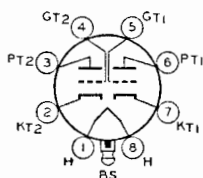

Glass lock-in type used as phase inverter or resistance-coupled amplifier in ac/dc radio receivers. Outline 15, OUTLINES SECTION. Tube requires lock-in socket. Heater volts (ac/dc), 12.6; amperes, 0.15. Except for heater rating, this type is electrically identical with lock-in type 7F7 and glass-octal type 6SL7-GT. Type 14F7 is used principally for renewal purposes.

**14F7**

### MEDIUM-MU TWIN TRIODE

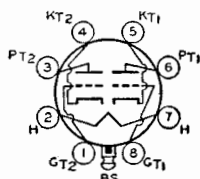

Glass lock-in type used as amplifier or oscillator in ac/dc radio equipment. Outline 15, OUTLINES SECTION, except over-all length is 2-9/32 max inches and seated length is 1-3/4 inches. Tube requires lock-in socket. Heater volts (ac/dc), 12.6; amperes, 0.15. Except for heater rating, this type is electrically identical with lock-in type 7F8. Type 14F8 is used principally for renewal purposes.

**14F8**

### TWIN DIODE—HIGH-MU TRIODE

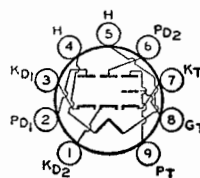

Miniature type used as combined detector and af voltage amplifier in radio receivers. Outline 12, OUTLINES SECTION. Tube requires miniature nine-contact socket and may be operated in any position.

**14GT8**

HEATER VOLTAGE (AC/DC).....	14	volts
HEATER CURRENT.....	0.15	ampere
AMPLIFICATION FACTOR <sup>o</sup> .....	72	
PLATE RESISTANCE (Approx.) <sup>o</sup> .....	72000	ohms
TRANSCONDUCTANCE <sup>o</sup> .....	1000	μmhos

<sup>o</sup> For triode unit; plate volts, 250; grid volts, -3; plate ma., 0.7.

#### TRIODE UNIT AS CLASS A<sub>1</sub> AMPLIFIER

Maximum Ratings, (Design-Maximum Values):

PLATE VOLTAGE.....	330 max	volts
GRID VOLTAGE, Positive-bias value.....	0 max	volts
PLATE DISSIPATION.....	1.1 max.	watts
PEAK HEATER-CATHODE VOLTAGE:		
Heater negative with respect to cathode.....	200 max	volts
Heater positive with respect to cathode.....	200 <sup>max</sup>	volts

## DIODE UNITS (Each Unit)

### Maximum Ratings, (Design-Maximum Values):

PLATE CURRENT.....	5 max	ma
PEAK HEATER-CATHODE VOLTAGE:		
Heater negative with respect to cathode.....	200 max	volts
Heater positive with respect to cathode.....	200 max	volts

### Characteristics, Instantaneous Test Condition:

Plate Current, for plate volts = 5.....	18	ma
---	----	----

■ The dc component must not exceed 100 volts.

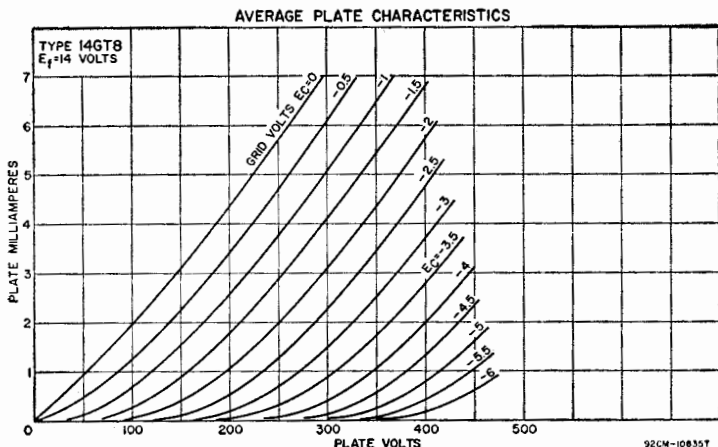

### SEMIREMOTE-CUTOFF PENTODE

Glass lock-in type used as rf or if amplifier in ac/dc radio receivers. Outline 15, OUTLINES SECTION. Tube requires lock-in socket. Heater volts (ac/dc), 12.6; amperes, 0.15. Except for heater rating, this type is electrically identical with type 7H7. Type 14H7 is a DISCONTINUED type listed for reference only.

**14H7**

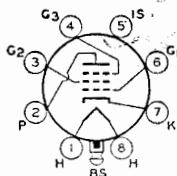

### TRIODE—HEPTODE CONVERTER

Glass lock-in type used as combined triode oscillator and heptode mixer in ac/dc radio receivers. Outline 15, OUTLINES SECTION. Tube requires lock-in socket. Heater volts (ac/dc), 12.6; amperes, 0.15. Except for heater rating, this type is electrically identical with lock-in type 7J7. Type 14J7 is a DISCONTINUED type listed for reference only.

**14J7**

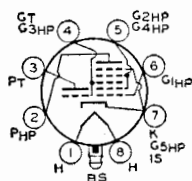

### MEDIUM-MU TWIN TRIODE

Glass lock-in type used as voltage amplifier or phase inverter in ac/dc radio equipment. Outline 20, OUTLINES SECTION. Tube requires lock-in socket. Heater volts (ac/dc), 12.6; amperes, 0.3. Except for heater rating and capacitances, this type is electrically identical with lock-in type 7N7 and glass-octal type 6SN7-GT. Type 14N7 is a DISCONTINUED type listed for reference only.

**14N7**

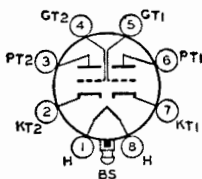



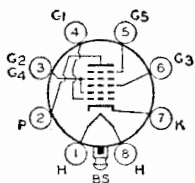

**PENTAGRID CONVERTER**

Glass lock-in type used as converter in ac/dc radio receivers. Outline 15, OUTLINES SECTION. Tube requires lock-in socket. Heater volts (ac/dc), 12.6; amperes, 0.15. Except for heater ratings and capacitances, this type is electrically identical with metal type 6SA7 and lock-in type 7Q7. Type 14Q7 is used principally for renewal purposes.

**14Q7**

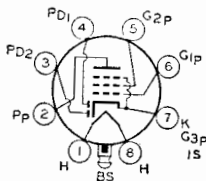

**TWIN DIODE—  
REMOTE-CUTOFF PENTODE**

Glass lock-in type used as combined detector, amplifier, and ave tube in ac/dc radio receivers. Outline 15, OUTLINES SECTION. Tube requires lock-in socket. Heater volts (ac/dc), 12.6; amperes, 0.15. Except for heater rating, this type is electrically identical with lock-in type 7R7. Type 14R7 is used principally for renewal purposes.

**14R7**

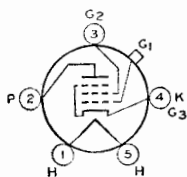

**SHARP-CUTOFF PENTODE**

Glass type used as rf amplifier in battery-operated receivers. Outline 40, OUTLINES SECTION. Tube requires five-contact socket. Heater volts (dc), 2.0; amperes, 0.22. Typical operation as class A<sub>1</sub> amplifier: plate volts, 135 max; grid-No.2 (screen-grid) volts, 67.5 max; grid-No.1 volts, -1.5; plate ma., 1.85; grid-No.2 ma., 0.3; plate resistance, 0.80 megohm; trans-conductance, 750 μmhos. This is a DISCONTINUED type listed for reference only.

**15**

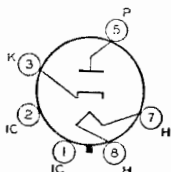

**HALF-WAVE VACUUM RECTIFIER 17AX4-GT  
17AX4-GTA**

Glass octal types used as damper tubes in horizontal deflection circuits of television receivers employing series-connected heater strings. Outline 22, OUTLINES SECTION. Heater volts (ac/dc), 16.8; amperes, 0.45; warm-up time (average), 11 seconds. Except for heater rating, these types are identical with glass octal types 6AX4-GT and 6AX4-GTR, respectively.

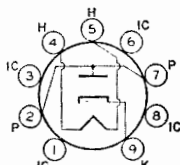

**HALF-WAVE VACUUM RECTIFIER**

Novar type used as damper tube in horizontal-deflection circuits of black-and-white television receivers employing series-connected heater strings. Outline 54, OUTLINES SECTION.

**17AY3**

Heater volts (ac/dc), 16.8; amperes, 0.45; warm-up time (average), 11 seconds. Except for heater rating, this type is identical with novar type 6AY3.

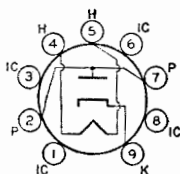

**HALF-WAVE VACUUM RECTIFIER**

Novar type used as damper tube in horizontal-deflection circuits of black-and-white television receivers employing series-connected heater strings. Outline 54, OUTLINES SECTION.

**17BH3**

Heater volts (ac/dc), 17.0; amperes, 0.6; warm-up time (average), 11 seconds. Except for heater rating, this type is identical with novar type 6BH3.

## 17BQ6- GTB

### BEAM POWER TUBE

Glass octal type used as horizontal deflection amplifier in television receivers employing series-connected heater strings. Outline 30, OUTLINES SECTION. Heater volts (ac/dc), 16.8;

amperes, 0.45; warm-up time (average), 11 seconds. Except for heater rating, this type is identical with glass octal type 6BQ6-GTB/6CU6.

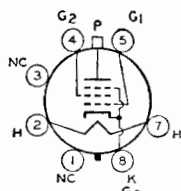

### HALF-WAVE VACUUM RECTIFIER

## 17D4

Glass octal type used as damper tube in horizontal-deflection circuits of television receivers employing series-connected heater strings. Outline 22, OUTLINES SECTION. Heater volts

(ac/dc), 16.8; amperes, 0.45; warm-up time (average), 11 seconds. Except for heater rating, this type is identical with glass octal type 6DA4.

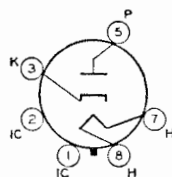

### HALF-WAVE VACUUM RECTIFIER

## 17DE4

Glass octal type used as damper tube in horizontal-deflection circuits of television receivers employing series-connected heater strings. Outline 29, OUTLINES SECTION. Heater volts

(ac/dc), 17; amperes, 0.6; warm-up time (average), 11 seconds. Except for heater rating, this type is identical with glass octal type 6DE4.

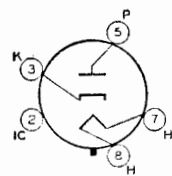

### HALF-WAVE VACUUM RECTIFIER

## 17DM4

Glass octal type used as damper tube in horizontal-deflection circuits of television receivers employing series-connected heater strings. Outline 29, OUTLINES SECTION. Heater volts

(ac/dc), 16.8; amperes, 0.45; warm-up time (average), 11 seconds. Except for heater rating, this type is identical with glass octal type 6DM4.

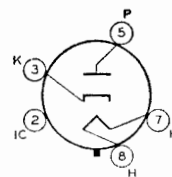

### BEAM POWER TUBE

## 17DQ6-A

Glass octal type used as horizontal deflection amplifier in television receivers employing series-connected heater strings. Outline 37, OUTLINES SECTION. Heater volts (ac/dc), 16.8;

amperes, 0.45; warmup time (average), 11 seconds. Except for heater rating, this type is identical with glass octal type 6DQ6-A.

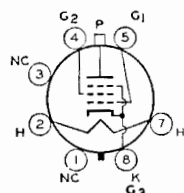

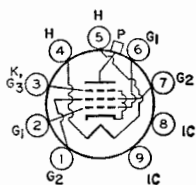

**BEAM POWER TUBE**

Novar type used in horizontal-deflection-amplifier circuits of television receivers employing series-connected heater strings. Outline 55, OUTLINES SECTION. Tube requires novar nine-

**17GJ5**

contact socket and may be operated in any position. Heater volts (ac/dc), 16.8; amperes, 0.45; warm-up time (average), 11 seconds. Except for heater ratings, this type is identical with type 6GJ5.

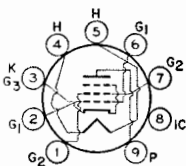

**BEAM POWER TUBE**

Novar type used in horizontal-deflection-amplifier circuits of television receivers employing series-connected heater strings. Outline 54, OUTLINES SECTION, except vertical dimensions

**17GT5**

are 0.6 inch shorter. Tube requires octal socket and may be operated in any position. Heater volts (ac/dc), 16.8; amperes, 0.45; warm-up time (average), 11 seconds. Except for heater ratings, this tube is identical with novar type 6GT5.

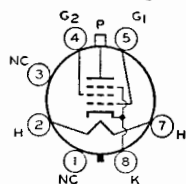

**BEAM POWER TUBE**

Glass octal type used in horizontal-deflection-amplifier circuits of high-efficiency deflection circuits of television receivers employing series-connected heater strings. Outline 37, OUT-

**17GW6**

LINES SECTION. Tube requires octal socket and may be operated in any position. Heater volts (ac/dc), 16.8; amperes, 0.45; warm-up time (average), 11 seconds. Except for heater ratings, this type is identical with glass octal type 6GW6.

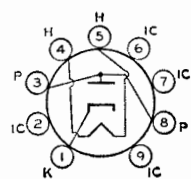

**HALF-WAVE VACUUM RECTIFIER**

Miniature type used as damper tube in horizontal-deflection circuits of television receivers employing series-connected heater strings. Outline 14, OUTLINES SECTION. Tube requires miniature nine-contact socket and may be mounted in any position. Socket terminals 2, 6, 7, and 9 should not be used as tie points. It is especially important that this tube, like other power-handling tubes, be adequately ventilated.

**17H3**

Heater volts (ac/dc), 17.5; amperes, 0.3; warm-up time (average), 11 seconds. This type is used principally for renewal purposes.

**DAMPER SERVICE**

*For operation in a 525-line, 30-frame system*

Maximum Ratings, (Design-Maximum Values):

PEAK INVERSE PLATE VOLTAGE#	2000 max	volts
PEAK PLATE CURRENT	450 max	ma
DC PLATE CURRENT	75 max	ma
PLATE DISSIPATION	3 max	watts
PEAK HEATER-CATHODE VOLTAGE:		
Heater negative with respect to cathode	2000*max	volts
Heater positive with respect to cathode	200**max	volts

# The duration of the voltage pulse must not exceed 15 per cent of one horizontal scanning cycle. In a 525-line, 30-frame system, 15 per cent of one horizontal scanning cycle is 10 microseconds.

- \* The dc component must not exceed 500 volts.
- \*\* The dc component must not exceed 100 volts.

**BEAM POWER TUBE**

**18A5**

Glass octal type used as horizontal-deflection amplifier tube in television receivers employing series-connected heater strings. Outline 26, OUTLINES SECTION. Tube requires octal socket and may be operated in any position. Heater volts (ac/dc), 18.5; amperes, 0.3; warm-up time (average), 11 seconds. Characteristics as horizontal-deflection amplifier: transconductance, 4800  $\mu$ mhos; plate resistance (ap-

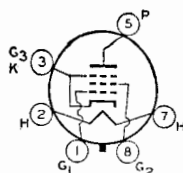

prox.) 27000 ohms; for plate volts, 200; grid-No.2 volts, 125; grid-No.1 volts, -17; plate ma., 40; grid-No.2 ma., 1.1.

**HORIZONTAL-DEFLECTION AMPLIFIER**

*For operation in a 525-line, 30-frame system*

**Maximum Ratings, (Design-Maximum Values):**

DC PLATE VOLTAGE.....	350 <i>max</i>	volts
PEAK POSITIVE-PULSE PLATE VOLTAGE#.....	3000 <i>max</i>	volts
PEAK NEGATIVE-PULSE PLATE VOLTAGE.....	600 <i>max</i>	volts
DC GRID-NO.2 (SCREEN-GRID) VOLTAGE.....	150 <i>max</i>	volts
PEAK NEGATIVE-PULSE GRID-NO.1 (CONTROL-GRID) VOLTAGE.....	250 <i>max</i>	volts
PEAK CATHODE CURRENT.....	310 <i>max</i>	ma
AVERAGE CATHODE CURRENT.....	90 <i>max</i>	ma
GRID-NO.2 INPUT.....	2.5 <i>max</i>	watts
PLATE DISSIPATION.....	9 <i>max</i>	watts
PEAK HEATER-CATHODE VOLTAGE:		
Heater negative with respect to cathode.....	200 <i>max</i>	volts
Heater positive with respect to cathode.....	200 <i>max</i>	volts
BULB TEMPERATURE (At hottest point).....	190 <i>max</i>	°C

**Maximum Circuit Value:**

Grid-No.1-Circuit Resistance:  
For grid-resistor-bias operation..... 1 *max* megohm

# The duration of the voltage pulse must not exceed 15 per cent of one horizontal scanning cycle. In a 525-line, 30-frame system, 15 per cent of one horizontal scanning cycle is 10 microseconds.

- Under no circumstances should this absolute value be exceeded.
- An adequate bias resistor or other means is required to protect the tube in the absence of excitation.
- The dc component must not exceed 100 volts.

**REMOTE-CUTOFF PENTODE**

**18FW6  
18FW6-A**

Miniature type used as rf- and if-amplifier tube in ac/dc radio receivers. Outline 11, OUTLINES SECTION. Tube requires miniature seven-contact socket and may be mounted in any

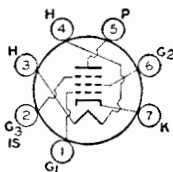

position. Heater volts (ac/dc), 18; amperes, 0.1; warm-up time (average), 18-FW6-A, 20 seconds.

**CLASS A<sub>1</sub> AMPLIFIER**

**Maximum Ratings, (Design-Maximum Values):**

PLATE VOLTAGE.....	150 <i>max</i>	volts
GRID-NO.3 (SUPPRESSOR GRID).....	Connect to cathode at socket	
GRID-NO.2 (SCREEN-GRID) SUPPLY VOLTAGE.....	150 <i>max</i>	volts
GRID-NO.2 VOLTAGE.....	See curve page 66	
GRID-NO.1 (CONTROL-GRID) VOLTAGE, Positive-bias value.....	0 <i>max</i>	volts
GRID-NO.2 INPUT:		
For grid-No.2 voltages up to 75 volts.....	0.6 <i>max</i>	watt
For grid-No.2 voltages between 75 and 150 volts.....	See curve page 66	
PLATE DISSIPATION.....	2.5 <i>max</i>	watts
PEAK HEATER-CATHODE VOLTAGE:		
Heater negative with respect to cathode.....	100 <i>max</i>	volts
Heater positive with respect to cathode.....	100 <i>max</i>	volts

**Characteristics:**

Plate Supply Voltage.....	100	volts
Grid No.3.....	Connected to cathode at socket	
Grid-No.2 Supply Voltage.....	100	volts

Cathode-Bias Resistor .....	68	ohms
Plate Resistance (Approx.) .....	0.25	megohm
Transconductance .....	4400	$\mu$ mhos
Plate Current .....	11	ma
Grid-No.2 Current .....	4.4	ma
Grid-No.1 Voltage (Approx.) for transconductance of 25 $\mu$ mhos .....	-20	volts

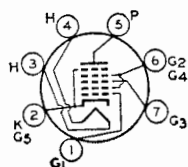

### PENTAGRID CONVERTER

Miniature type used for converter applications in ac/dc radio receivers. Outline 11, OUTLINES SECTION. Tube requires miniature seven-contact socket and may be mounted in

**18FX6**  
**18FX6-A**

any position. Heater volts (ac/dc), 18; amperes, 0.1; warm-up time (average), 18FX6-A, 20 seconds.

#### CONVERTER

**Maximum Ratings, (Design-Maximum Values):**

PLATE VOLTAGE .....	150 <i>max</i>	volts
GRIDS-NO.2-AND-NO.4 (SCREEN-GRID) SUPPLY VOLTAGE .....	150 <i>max</i>	volts
GRIDS-NO.2-AND-NO.4 VOLTAGE .....	110 <i>max</i>	volts
GRIDS-NO.2-AND-NO.4 INPUT .....	1.2 <i>max</i>	watts
PLATE DISSIPATION .....	1 <i>max</i>	watt
<b>PEAK HEATER-CATHODE VOLTAGE:</b>		
Heater negative with respect to cathode .....	100 <i>max</i>	volts
Heater positive with respect to cathode .....	100 <i>max</i>	volts

**Typical Operation (Separate Excitation):\***

Plate Voltage .....	100	volts
GRIDS-NO.2-AND-NO.4 (SCREEN-GRID) VOLTAGE .....	100	volts
Grid-No.3 (Control-Grid) Voltage .....	-1.5	volts
Grid-No.1 (Oscillator-Grid) Resistor .....	20000	ohms
Plate Resistance (Approx.) .....	0.4	megohm
Conversion Transconductance .....	480	$\mu$ mhos
Grid-No.3 Voltage (Approx.) for conversion transconductance of 10 $\mu$ mhos .....	-21	volts
Plate Current .....	2.3	ma
GRIDS-NO.2-AND-NO.4 CURRENT .....	6.2	ma
Grid-No.1 Current .....	0.5	ma
Total Cathode Current .....	9	ma

Note: The transconductance between grid No.1 and grids No.2 and No.4 connected to plate (not oscillating) is approximately 7000  $\mu$ mhos under the following conditions: grids No.1 and No.3 at 0 volts; grids No.2 and No.4 and plate at 100 volts. Under the same conditions, the plate current is 24 ma., and the amplification factor is 22.

\* The characteristics shown with separate excitation correspond very closely with those obtained in a self-excited oscillator circuit operating with zero bias.

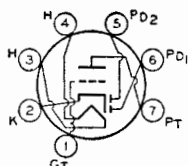

### TWIN DIODE—HIGH-MU TRIODE

Miniature type used for combined detector, amplifier, and avc tube in compact ac/dc radio receivers. Outline 11, OUTLINES SECTION. Tube requires miniature seven-contact socket and may be mounted in any position. Heater volts (ac/dc), 18; amperes, 0.1;

**18FY6**  
**18FY6-A**

warm-up time (average), 18FY6-A, 20 seconds.

#### TRIODE UNIT AS CLASS A<sub>1</sub> AMPLIFIER

**Maximum Ratings, (Design-Maximum Values):**

PLATE VOLTAGE .....	150 <i>max</i>	volts
GRID VOLTAGE, Positive-bias value .....	0 <i>max</i>	volts
PLATE DISSIPATION .....	0.5 <i>max</i>	watt
<b>PEAK HEATER-CATHODE VOLTAGE:</b>		
Heater negative with respect to cathode .....	100 <i>max</i>	volts
Heater positive with respect to cathode .....	100 <i>max</i>	volts

**Characteristics:**

Plate Voltage.....	100	volts
Grid Voltage.....	-1	volt
Amplification Factor.....	100	
Plate Resistance (Approx.).....	77000	ohms
Transconductance.....	1300	$\mu$ mhos
Plate Current.....	0.6	ma

**DIODE UNITS (Each Unit)**

**Maximum Ratings, (Design-Maximum Values):**

PLATE CURRENT.....	1 max	ma
--------------------	-------	----

# 18GD6-A

## SHARP-CUTOFF PENTODE

Miniature type used in the if, rf, and converter stages of ac/dc AM radioreceivers. Outline 11, OUTLINES SECTION. Tube requires miniature seven-contact socket and may be operated in any position.

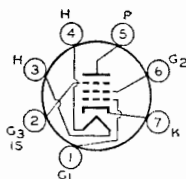

HEATER VOLTAGE (AC/DC).....	18	volts
HEATER CURRENT.....	0.1	ampere
WARM-UP TIME (AVERAGE).....	20	seconds
<b>DIRECT INTERELECTRODE CAPACITANCES:</b>		
Grid-No.1 to Plate.....	0.0035	$\mu$ fd
Grid No.1 to Cathode, Heater, Grid No.2, Grid No.3, and Internal Shield.....	6.0	$\mu$ fd
Plate to Cathode, Heater, Grid No.2, Grid No.3 and Internal Shield.....	5.0	$\mu$ fd

° Values are same without external shield, or with external shield connected to cathode.

## CLASS A<sub>1</sub> AMPLIFIER

**Characteristics:**

Plate Supply Voltage.....	100	volts
Grid No.3 (Suppressor Grid).....	Connected to cathode at socket	
Grid-No.2 (Screen-Grid) Voltage.....	100	volts
Cathode-Bias Resistor.....	150	ohms
Plate Resistance (Approx.).....	0.5	megohm
Transconductance.....	4300	$\mu$ mhos
Plate Current.....	5	ma
Grid-No.2 Current.....	2	ma
Grid-No.1 Voltage (Approx.), for plate current of 10 $\mu$ a.....	-4.7	volts

## RF AMPLIFIER AND CONVERTER

**Maximum Ratings, (Design-Maximum Values):**

PLATE VOLTAGE.....	150 max	volts
GRID-NO.2 SUPPLY VOLTAGE.....	150 max	volts
GRID-NO.2 VOLTAGE.....	See curve page 66	
PLATE DISSIPATION.....	2.5 max	watts
<b>GRID-NO.2 INPUT:</b>		
For grid-No.2 voltages up to 75 volts.....	0.6 max	watt
For grid-No.2 voltages between 75 and 150 volts.....	See curve page 66	
<b>PEAK HEATER-CATHODE VOLTAGE:</b>		
Heater negative with respect to cathode.....	100 max	volts
Heater positive with respect to cathode.....	100 max	volts

## HJGH-MU TWIN POWER TRIODE

Glass type used in output stage of battery-operated receivers. Outline 34 or 35, OUTLINES SECTION. Tube requires six-contact socket. Filament volts (dc), 2.0; amperes, 0.26. Except for filament current, this type is electrically identical with type 1J6-GT. Type 19 is a DISCONTINUED type listed for reference only.

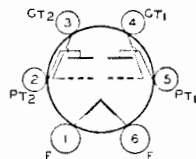

19

# 19AU4 19AU4- GTA

## HALF-WAVE VACUUM RECTIFIER

Glass octal types used as damper diode in horizontal-deflection circuits of black-and-white television receivers employing series-connected heater strings. Outline 29, OUTLINES SEC-

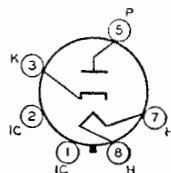

TION. Tubes require octal socket and may be mounted in any position. These types may be supplied with pin 1 omitted. Socket terminals 1, 2, 4, and 6 should not be used as tie points. It is especially important that these tubes, like other power-handling tubes, be adequately ventilated. Heater volts (ac/dc), 18.9; amperes, 0.6; warm-up time (average), 11 seconds. Type 19AU4-GTA is used principally for renewal purposes.

**DAMPER SERVICE**

*For operation in a 525-line, 30-frame system*

**Maximum Ratings:**

	19AU4-GTA <i>Design Maximum</i>	19AU4 <i>Design Center</i>	
PEAK INVERSE PLATE VOLTAGE <sup>‡</sup> .....	4500 max	4500 <sup>°</sup> max	volts
PEAK PLATE CURRENT.....	1300 max	1050 max	ma
DC PLATE CURRENT.....	210 max	175 max	ma
PLATE DISSIPATION.....	6.5 max	6 max	watts
<b>PEAK HEATER-CATHODE VOLTAGE:</b>			
Heater negative with respect to cathode.....	4500 <sup>†</sup> max	4500 <sup>°†</sup> max	volts
Heater positive with respect to cathode.....	300 <sup>‡</sup> max	300 <sup>‡</sup> max	volts

<sup>‡</sup> The duration of the voltage pulse must not exceed 15 per cent of one horizontal scanning cycle. In a 525-line, 30-frame system, 15 per cent of one horizontal scanning cycle is 10 microseconds.

<sup>°</sup> Under no circumstances should this absolute value be exceeded.

<sup>†</sup> The dc component must not exceed 900 volts.

<sup>‡</sup> The dc component must not exceed 100 volts.

**BEAM POWER TUBE**

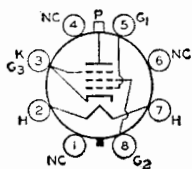

Glass octal types used as output amplifiers in horizontal deflection circuits of television equipment of the "transformerless" type where high pulse voltages occur during short duty cycles. Outlines 52 and 46, respectively, OUTLINES SECTION. Tubes require octal socket. Vertical tube mounting is preferred but horizontal operation is permissible if pins No.2 and No.7 are in vertical plane. Heater volts (ac/dc),

18.9; amperes, 0.3. Except for heater rating and interelectrode capacitances, type 19BG6-GA is electrically identical with glass octal type 6BG6-G. Type 19BG6-G is a DISCONTINUED type listed for reference only. Type 19BG6-GA is used principally for renewal purposes.

**19BG6-G**

**19BG6-GA**

**MEDIUM-MU TRIODE—  
SHARP-CUTOFF PENTODE**

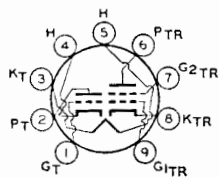

Miniature type used as combined vhf oscillator and mixer in television receivers employing series-connected heater strings. Outline 12, OUTLINES SECTION. Tube requires miniature

nine-contact socket and may be operated in any position. Heater volts (ac/dc), 18.9; amperes, 0.15; warm-up time (average), 11 seconds. Except for heater rating, this type is identical with miniature type 6CL8-A.

**19CL8-A**

**MEDIUM-MU TRIODE—  
SHARP-CUTOFF PENTODE**

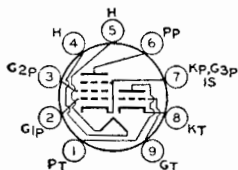

Miniature type used as combined oscillator and mixer in television receivers employing series-connected heater strings and using an intermediate frequency in the order of 40 megacycles

per second. Outline 12, OUTLINES SECTION. Tube requires miniature nine-contact socket and may be operated in any position. Heater volts (ac/dc), 18.9; amperes, 0.15; warm-up time (average), 11 seconds. Except for heater rating this type is identical with miniature type 6EA8.

**19EA8**

**MEDIUM-MU TWIN TRIODE**

**19J6**

Miniature type used for converter service in ac/dc AM and FM receivers and as oscillator, amplifier, or mixer in television receivers of the "transformerless" type. Outline 11, OUTLINES SECTION. Tube requires miniature seven-contact socket and may be mounted in any position. Heater volts (ac/dc), 18.9; amperes, 0.15. For direct interelectrode capacitances, ratings, and typical operation as a class A<sub>1</sub> amplifier, and curves, refer to type 6J6. Maximum ratings and characteristics for mixer service (each unit): plate volts, 150 (300 max); cathode-bias resistor, 810 ohms; peak oscillator volts, 3; plate resistance, 10200 ohms; conversion transconductance, 1900 μmhos; plate ma., 4.8; plate dissipation, 1.5 max watts; peak heater-cathode volts, 90 max. Type 19J6 is used principally for renewal purposes.

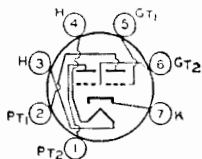

ances, ratings, and typical operation as a class A<sub>1</sub> amplifier, and curves, refer to type 6J6. Maximum ratings and characteristics for mixer service (each unit): plate volts, 150 (300 max); cathode-bias resistor, 810 ohms; peak oscillator volts, 3; plate resistance, 10200 ohms; conversion transconductance, 1900 μmhos; plate ma., 4.8; plate dissipation, 1.5 max watts; peak heater-cathode volts, 90 max. Type 19J6 is used principally for renewal purposes.

**TRIPLE DIODE-HIGH-MU TRIODE**

**19T8**

Miniature type used as combined audio amplifier, AM detector, and FM detector in AM/FM receivers of the a/c or "transformer" type. Outline 12, OUTLINES SECTION. Tube requires miniature nine-contact socket and may be mounted in any position. Heater volts (ac/dc), 18.9; amperes, 0.15. Except for heater rating, this type is identical with miniature type 6T8-A. Type 19T8 is used principally for renewal purposes.

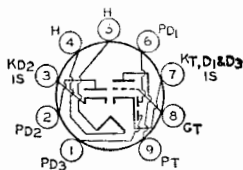

Except for heater rating, this type is identical with miniature type 6T8-A. Type 19T8 is used principally for renewal purposes.

**MEDIUM-MU TRIODE—SHARP-CUTOFF PENTODE**

**19X8**

Miniature type used as combined oscillator and mixer tube in "transformerless" AM/FM receivers. Outline 12, OUTLINES SECTION. Tube requires miniature nine-contact socket



and may be mounted in any position. Heater volts (ac/dc), 18.9; amperes, 0.15. Except for heater rating, this type is identical with miniature type 6X8.

**POWER TRIODE**

**20**

Glass type used as output amplifier in dry-battery-operated receivers. Filament volts (dc), 3.3; amperes, 0.132. Characteristics as class A<sub>1</sub> amplifier: plate volts, 135 max; grid volts, -22.5; plate ma., 6.5; plate resistance, 6300 ohms; amplification factor, 3.3; transconductance, 525 μmhos; load resistance, 6500 ohms; output mw., 110. This is a DISCONTINUED type listed for reference only.

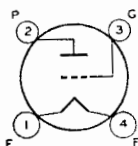

**DIODE-REMOTE-CUTOFF PENTODE**

**20EQ7**

Miniature type used as combined if amplifier and AM detector in AM and AM/FM radio receivers. Outline 14, OUTLINES SECTION. Tube requires miniature nine-contact socket

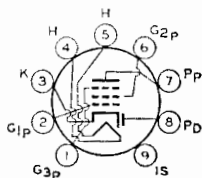

and may be operated in any position. Heater volts (ac/dc), 20; amperes, 0.1. Except for heater rating, this type is identical with miniature type 6EQ7.



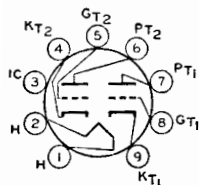

### HIGH-MU TWIN TRIODE

Miniature type used in high-gain, resistance-coupled, low-level audio amplifiers operating at low-signal levels, such as preamplifiers for stereo phonographs. Outline 12, OUTLINES SECTION.

# 20EZ7

For typical operation as resistance-coupled amplifier, refer to RESISTANCE-COUPLED AMPLIFIER SECTION. Tube requires miniature nine-contact socket and may be operated in any position.

HEATER VOLTS (AC/DC).....	20	volts
HEATER CURRENT.....	0.1	amperes
HEATER WARM-UP TIME (AVERAGE).....	20	seconds
DIRECT INTERELECTRODES CAPACITANCES: <sup>o</sup>	<i>Unit No.1</i>	<i>Unit No.2</i>
Grid to Plate.....	1.5	1.5
Grid to Cathode and Heater.....	1.6	1.6
Plate to Cathode and Heater.....	0.2	0.3

### CLASS A<sub>1</sub> AMPLIFIER (Each Unit)

Maximum Ratings, (Design-Maximum Values):

PLATE VOLTAGE.....	330 <i>max</i>	volts
GRID VOLTAGE:		
Negative-bias value.....	55 <i>max</i>	volts
Positive-bias value.....	0 <i>max</i>	volts
PLATE DISSIPATION.....	1.2 <i>max</i>	watts
PEAK HEATER-CATHODE VOLTAGE:		
Heater negative with respect to cathode.....	200 <i>max</i>	volts
Heater positive with respect to cathode.....	200 <sup>■</sup> <i>max</i>	volts

### Characteristics:

Plate Voltage.....	100	250	volts
Grid Voltage.....	-1	-2	volts
Amplification Factor.....	100	100	
Plate Resistance (Approx.).....	8000	62500	ohms
Transconductance.....	1250	1600	μmhos
Plate Current.....	0.5	1.2	ma

<sup>o</sup> Without external shield.

<sup>■</sup> The dc component must not exceed 100 volts.

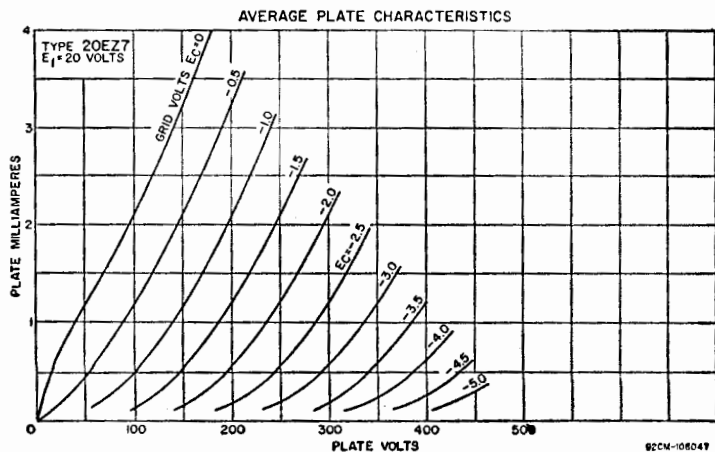

## 21EX6

### BEAM POWER TUBE

Glass octal type used as horizontal-deflection amplifier in television receivers employing series-connected heater strings. Outline 46, OUTLINES SECTION. Tube requires octal socket

and should be operated vertically (base down or up) or horizontally with pins 2 and 7 in a vertical plane. Heater volts (ac/dc), 21.5; amperes, 0.6; warm-up time (average), 11 seconds. Except for heater ratings, this tube is identical with glass octal type 6EX6.

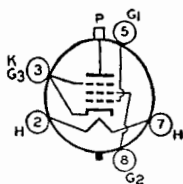

## 22

### SHARP-CUTOFF TETRODE

Glass type used as rf amplifier in dry-battery-operated receivers. Maximum over-all length, 5-1/32 inches; maximum diameter, 1-13/16 inches. Filament volts (dc), 3.3; amperes, 0.132. Characteristics as class A<sub>1</sub> amplifier; plate volts, 135 *max*; grid-No.2 (screen-grid) volts, 67.5 *max*; grid-No.1 volts, -1.5; plate ma., 3.7; grid-No.2 ma., 1.3; plate resistance, 325000 ohms; transconductance, 500  $\mu$ hos. This is a DISCONTINUED type listed for reference only.

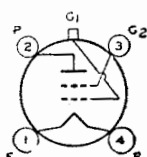

### HALF-WAVE VACUUM RECTIFIER

## 22BH3

Novar type used as damper tube in horizontal deflection circuits of black-and-white television receivers employing series-connected heater strings. Outline 54, OUTLINES SECTION.

Heater volts (ac/dc), 22.4; amperes, 0.450; warm-up time (average), 11 seconds. Except for heater rating, this type is identical with novar type 6BH3.

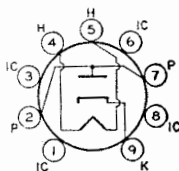

### HALF-WAVE VACUUM RECTIFIER

## 22DE4

Glass octal type used as damper tube in horizontal-deflection circuits of black-and-white television receivers employing series-connected heater strings. Outline 29, OUTLINES SECTION.

Heater volts (ac/dc), 22.4; amperes, 0.45; warm-up time (average), 11 seconds. Except for heater rating, this type is identical with glass octal type 6DE4.

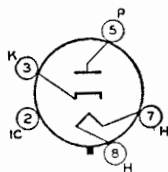

### SHARP-CUTOFF TETRODE

## 24-A

Glass type used as rf amplifier or biased detector in ac-operated receivers. Maximum over-all length, 5-1/32 inches; maximum diameter, 1-13/16 inches. Tube requires five-contact socket. Heater volts (ac/dc), 2.5; amperes, 1.75. Typical operation and maximum ratings as class A<sub>1</sub> amplifier; plate volts, 250 (275 *max*); grid-No.2 volts, 90; grid-No.1 volts, -3; plate re-

sistance, 0.6 megohm; transconductance, 1050  $\mu$ hos; plate ma., 4; grid-No.2 ma., 1.7 *max*. This type is used principally for renewal purposes.

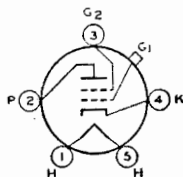

**POWER PENTODE**

Metal type 25A6 and glass octal type 25A6-GT used in output stage of ac/dc receivers. Outlines 6 and 22, respectively, OUTLINES SECTION. Tubes require octal socket. Heater volts (ac/dc), 25; amperes, 0.3. Maximum ratings as class A<sub>1</sub> amplifier: plate volts, 160; grid-No.2 volts, 135; plate dissipation, 5.3 watts; grid-No.2 input, 1.9 watts. These are DISCONTINUED types listed for reference only.

**25A6  
25A6-GT**

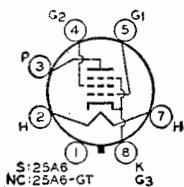

**RECTIFIER—POWER PENTODE**

Glass octal type used as combined half-wave rectifier and power amplifier. Outline 22, OUTLINES SECTION. Heater volts (ac/dc), 25; amperes, 0.3. Typical operation of pentode unit as class A<sub>1</sub> amplifier: plate volts and grid-No.2 volts, 100 (117 max); grid-No.1 volts, -15; plate ma., 20.5; grid-No.2 ma., 4; plate resistance, 50000 ohms, transconductance, 1800

**25A7-GT**

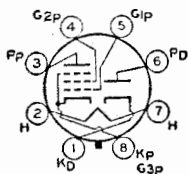

μmhos; load resistance, 4500 ohms; output watts, 0.77. Maximum ratings of rectifier unit: peak inverse plate volts, 350; peak plate ma., 450; dc output ma., 75; peak heater-cathode volts, 175. This is a DISCONTINUED type listed for reference only.

**HIGH-MU POWER TRIODE**

Glass octal type used in output stage of ac/dc receivers. Outline 22, OUTLINES SECTION. Heater volts (ac/dc), 25; amperes, 0.3. Maximum ratings: plate volts, 180 max; plate dissipation, 10 max watts. This is a DISCONTINUED type listed for reference only.

**25AC5-GT**

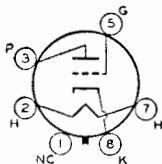

**BEAM POWER TUBE**

Glass octal type used as horizontal-deflection amplifier tube in television receivers employing either transformer coupling or direct coupling to the deflecting yoke. Outline 33, OUTLINES SECTION. Heater volts (ac/dc), 25; amperes, 0.3. Except for heater rating, this type is identical with glass octal type 6AV5-GA.

**25AV5-  
GA**

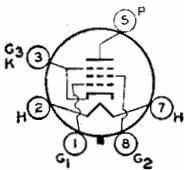

Heater volts (ac/dc), 25; amperes, 0.3. Except for heater rating, this type is identical with glass octal type 6AV5-GA.

**HALF-WAVE VACUUM RECTIFIER**

Glass octal type used as a damper tube in horizontal deflection circuits of television receivers. Outline 22, OUTLINES SECTION. This type may be supplied with pin No.1 omitted.

**25AX4-  
GT**

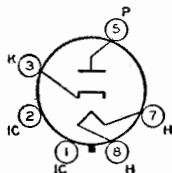

Heater volts (ac/dc), 25; amperes, 0.3. Except for heater rating, this type is identical with glass octal type 6AX4-GT.

**DIRECT-COUPLED POWER AMPLIFIER**

Glass type used as class A<sub>1</sub> power amplifier. One triode, the driver, is directly connected within the tube to the second, or output, triode. Heater volts (ac/dc), 25; amperes, 0.3. Maximum ratings and characteristics are the same as for type 25N6-G. Type 25B5 is a DISCONTINUED type listed for reference only.

**25B5**

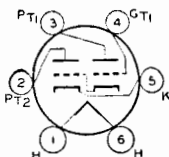

**POWER PENTODE**

Glass octal type used in output stage of ac/dc receivers. Outline 42, OUTLINES SECTION. Heater volts (ac/dc), 25; amperes, 0.3. Typical operation as class A<sub>1</sub> amplifier: plate volts, 200 max; grid-No.2 volts, 135 max; grid-No.1 volts, -23; plate ma., 62; grid-No.2 ma., 1.8; plate resistance, 18000 ohms; transconductance, 5000  $\mu$ mhos; load resistance, 2500 ohms; output watts, 7.1. This is a DISCONTINUED type listed for reference only.

**25B6-G**

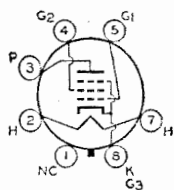

**TRIODE—PENTODE**

Glass octal type used as amplifier. High-mu triode unit and remote-cutoff pentode unit are independent. Outline 22, OUTLINES SECTION. Heater volts (ac/dc), 25; amperes, 0.15. Typical operation of pentode unit as class A<sub>1</sub> amplifier: plate and grid-No.2 volts, 100; grid-No.1 volts, -3; plate ma., 7.6; grid-No.2 ma., 2; plate resistance, 185000 ohms; transconductance, 2000  $\mu$ mhos. Triode unit: plate volts, 100; grid volts, -1; plate ma., 0.6; amplification factor, 112; plate resistance, 75000; transconductance, 1500  $\mu$ mhos. This is a DISCONTINUED type listed for reference only.

**25B8-GT**

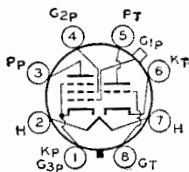

**BEAM POWER TUBE**

Miniature type used in audio output stages of television and radio receivers. Also used as video amplifier. Outline 14, OUTLINES SECTION. Heater volts (ac/dc), 25; amperes, 0.3. Except for heater rating, this type is identical with miniature type 6BK5.

**25BK5**

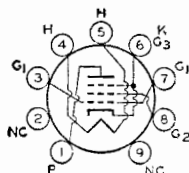

**BEAM POWER TUBE**

Glass octal types used as horizontal deflection amplifiers in circuits of television equipment. Outline 30, OUTLINES SECTION. These types may be supplied with pin No.1 omitted. Tubes require octal socket and may be mounted in any position. Heater volts

**25BQ6-GT**  
**25BQ6-GTB**  
**/25CU6**

(ac/dc), 25; amperes, 0.3. Except for heater rating, these types are identical with glass octal types 6BQ6-GT and 6BQ6-GTB/6CU6, respectively. Type 25BQ6-GT is a DISCONTINUED type listed for reference only.

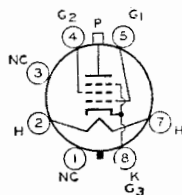

**BEAM POWER TUBE**

Miniature type used in the audio output stage of radio receivers. Because of its high power sensitivity and high efficiency at low plate and screen-grid voltages, it is capable of providing

**25C5**

a relatively high power output. Outline 13, OUTLINES SECTION. Tube requires miniature seven-contact socket and may be mounted in any position. Heater volts (ac/dc), 25; amperes, 0.3. Except for heater rating, this type is identical with miniature type 50C5.

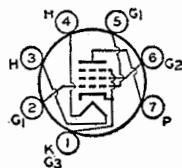

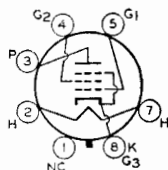

**BEAM POWER TUBE**

Glass octal type used as output amplifier. Outline 42, OUTLINES SECTION. Heater volts (ac/dc), 25; amperes, 0.3. Refer to type 6Y6-G for typical operation as a class A<sub>1</sub> amplifier. Type 25C6-G is a DISCONTINUED type listed for reference only.

**25C6-G**

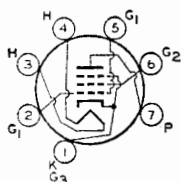

**BEAM POWER TUBE**

Miniature type used in audio-output stage of radio and television receivers. Outline 13, OUTLINES SECTION. Heater volts (ac/dc), 25; amperes, 0.3. Except for heater rating, this type is identical with miniature type 12CA5.

**25CA5**

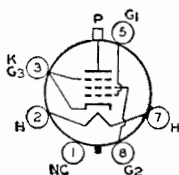

**BEAM POWER TUBE**

Glass octal types used as horizontal deflection amplifiers in television receivers employing series-connected heater strings. Outlines 52 and 46, respectively, OUTLINES SECTION. Heater volts (ac/dc), 25; amperes, 0.6; warm-up time (average), 11 seconds. Except for heater ratings, these types are identical with glass octal types 6CD6-G and 6CD6-GA, respectively. Type 25CD6-GA is a DISCONTINUED type listed for reference only.

**25CD6-GA  
25CD6-GB**

Refer to type 25BQ6-GTB/25CU6

**25CU6**

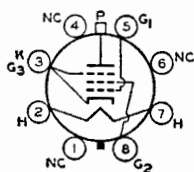

**BEAM POWER TUBE**

Glass octal type used as horizontal deflection amplifier in television receivers employing series-connected heater strings. Outline 46, OUTLINES SECTION. Tube requires octal socket. Vertical tube mounting is preferred but horizontal operation is permissible if pins 1 and 3 are in vertical plane.

**25DN6**

HEATER VOLTAGE (AC/DC).....	25	volts
HEATER CURRENT.....	0.6	ampere
HEATER WARM-UP TIME (Average).....	11	seconds
PLATE RESISTANCE (Approx.)†.....	4000	ohms
TRANSCONDUCTANCE†.....	9000	μmhos
MU-FACTOR,† Grid No.2 to Grid No.1.....	4.35	

† For plate and grid-No.2 volts, 125; grid-No.1 volts, -18; plate ma., 70; grid-No.2 ma., 6.3.

**HORIZONTAL DEFLECTION AMPLIFIER**

*For operation in a 525-line, 30-frame system*

**Maximum Ratings:**

DC PLATE VOLTAGE.....	700 max	volts
PEAK POSITIVE-PULSE PLATE VOLTAGE <sup>‡</sup> (Absolute Maximum).....	6600 <sup>‡</sup> max	volts
PEAK NEGATIVE-PULSE PLATE VOLTAGE.....	-1500 max	volts
DC GRID-NO.2 (SCREEN-GRID) VOLTAGE.....	175 max	volts
PEAK NEGATIVE-PULSE GRID-NO.1 (CONTROL-GRID) VOLTAGE.....	-200 max	volts
PEAK CATHODE CURRENT.....	700 max	ma
AVERAGE CATHODE CURRENT.....	200 max	ma
GRID-NO.2 INPUT.....	3 max	watts
PLATE DISSIPATION†.....	15 max	watts

**PEAK HEATER-CATHODE VOLTAGE:**

Heater negative with respect to cathode.....	200 <i>max</i>	volts
Heater positive with respect to cathode.....	200 <i>max</i>	volts
BULB TEMPERATURE (At hottest point).....	225 <i>max</i>	°C

**Maximum Circuit Value:**

Grid-No.1-Circuit Resistance.....	0.47 <i>max</i>	megohm
-----------------------------------	-----------------	--------

‡ The duration of the voltage pulse must not exceed 15 per cent of one horizontal scanning cycle. In a 525-line, 30-frame system, 15 per cent of one horizontal scanning cycle is 10 microseconds.

□ Under no circumstances should this absolute value be exceeded.

† An adequate bias resistor or other means is required to protect the tube in the absence of excitation.

▪ The dc component must not exceed 100 volts.

## BEAM POWER TUBE

Glass octal type used as horizontal deflection amplifier in television receivers employing series-connected heater strings. Outline 44, OUTLINES SECTION, except vertical dimensions are  $\frac{1}{8}$  inch shorter. Tube requires octal socket and may be operated in any position.

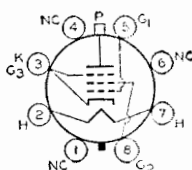

## 25EC6

HEATER VOLTAGE (AC/DC).....	25	volts
HEATER CURRENT.....	0.6	ampere
WARM-UP TIME (AVERAGE).....	11	seconds
DIRECT INTERELECTRODE CAPACITANCES: <sup>2</sup>		
Grid No.1 to Plate.....	0.6	μf
Grid No.1 to Cathode, Heater, Grid No.3, and Grid No.2.....	24	μf
Plate to Cathode, Heater, Grid No.3, and Grid No.2.....	10	μf

### CLASS A<sub>1</sub> AMPLIFIER

**Characteristics:**

Plate Voltage.....	60	135	volts
Grid-No.2 (Screen-Grid) Voltage.....	135	135	volts
Grid-No.1 (Control-Grid) Voltage.....	0	-22.5	volts
Triode Amplification Factor.....	-	3.8	
Plate Resistance (Approx.).....	-	4700	ohms
Transconductance.....	-	7500	μmhos
Plate Current.....	350 <sup>■</sup>	70	ma
Grid-No.2 Current.....	40 <sup>■</sup>	4.5	ma
Grid-No.1 Voltage (Approx.) for plate current of 1 ma.....	-	-42	volts

### HORIZONTAL-DEFLECTION AMPLIFIER

*For operation in a 525-line, 30-frame system*

**Maximum Ratings, (Design-Maximum Values):**

DC PLATE SUPPLY VOLTAGE.....	700 <i>max</i>	volts
PEAK POSITIVE-PULSE PLATE VOLTAGE <sup>1</sup> .....	7000 <i>max</i>	volts
PEAK NEGATIVE-PULSE PLATE VOLTAGE.....	1500 <i>max</i>	volts
DC GRID-NO.2 VOLTAGE.....	175 <i>max</i>	volts
PEAK NEGATIVE-PULSE GRID-NO.1 VOLTAGE.....	300 <i>max</i>	volts
PEAK CATHODE CURRENT.....	700 <i>max</i>	ma
AVERAGE CATHODE CURRENT.....	200 <i>max</i>	ma
GRID-NO.2 INPUT.....	4 <i>max</i>	watts
PLATE DISSIPATION <sup>2</sup> .....	10 <i>max</i>	watts
PEAK HEATER-CATHODE VOLTAGE:		
Heater negative with respect to cathode.....	200 <i>max</i>	volts
Heater positive with respect to cathode.....	200 <i>max</i>	volts
BULB TEMPERATURE (At hottest point).....	225 <i>max</i>	°C

**Maximum Circuit Values:**

Grid-No.1-Circuit Resistance:	
For grid resistor-bias operation.....	1.5 <i>max</i> megohms

° Without external shield.

▪ This value can be measured by a method involving a recurrent waveform such that the maximum ratings of the tube will not be exceeded.

• This rating is applicable where the duration of the voltage pulse does not exceed 15 per cent of the horizontal scanning cycle. In a 525-line, 30-frame system, 15 per cent of the horizontal scanning cycle is 10 microseconds.

† An adequate bias resistor or other means is required to protect the tube in the absence of excitation.

• The dc component must not exceed 100 volts.

**POWER PENTODE**

**25EH5**

Miniature type used in the audio output stage of radio and television receivers and in phonographs. Outline 13, OUTLINES SECTION. Heater volts (ac/dc), 25; amperes, 0.3. Except for heater rating, this type is identical with miniature type 6EH5.

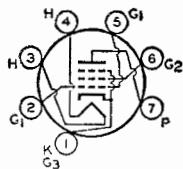

**BEAM POWER TUBE**

**25L6  
25L6-GT**

Metal type 25L6 and glass octal type 25L6-GT used in output stage of ac/dc receivers. Outlines 6 and 22, respectively, OUTLINES SECTION. These tubes require octal sockets and

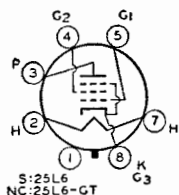

may be mounted in any position. Type 25L6-GT may be supplied with pin No.1 omitted. Heater volts (ac/dc), 25; amperes, 0.3. For maximum ratings and typical operation, refer to type 50L6-GT. Refer to miniature type 50C5 for curves, installation, and application information, but take into consideration the differences in heater ratings. Type 25L6 is used principally for renewal purposes.

**DIRECT-COUPLED TWIN  
POWER AMPLIFIER**

**25N6-G**

Glass octal type used as class A<sub>1</sub> power amplifier. Heater volts (ac/dc), 25; amperes, 0.3. Characteristics as class A<sub>1</sub> amplifier—input triode: plate volts, 100 (180 max); grid volts, 0; peak af grid volts, 29.7; plate ma., 5.8. Output triode: plate volts, 180 max; plate ma., 46; load resistance, 4000 ohms; output watts, 3.8. This is a DISCONTINUED type listed for reference only.

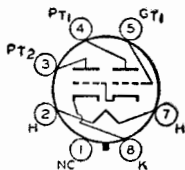

**HALF-WAVEVACUUM RECTIFIER**

**25W4-GT**

Glass octal type used as damper tube in magnetic-deflection circuits of television receivers. Outline 22, OUTLINES SECTION. This type may be supplied with pin No.1 omitted. Tube requires octal socket and may be mounted in any position. It is especially important that this tube, like other power-handling tubes, be adequately ventilated. Type 25W4-GT is used principally for renewal purposes.

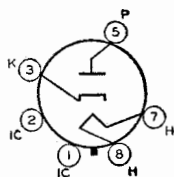

HEATER VOLTAGE (AC).....	25	volts
HEATER CURRENT.....	0.3	ampere

**DAMPER SERVICE**

<i>For operation in a 525-line, 30-frame system</i>		
Maximum Ratings:		
PEAK INVERSE PLATE VOLTAGE# (Absolute Maximum).....	3850 <sup>■</sup> max	volts
PEAK PLATE CURRENT.....	750 max	ma
DC PLATE CURRENT.....	125 max	ma
PLATE DISSIPATION.....	3.5 max	watts
PEAK HEATER-CATHODE VOLTAGE:		
Heater negative with respect to cathode (Absolute Maximum).....	500 <sup>■</sup> max	volts
Heater positive with respect to cathode.....	200 <sup>▲</sup> max	volts

# The duration of the voltage pulse must not exceed 15 per cent of one horizontal scanning cycle. In a 525-line, 30-frame system, 15 per cent of one horizontal scanning cycle is 10 microseconds.

■ Under no circumstances should this absolute maximum value be exceeded.

▲ The dc component must not exceed 100 volts.

**VACUUM RECTIFIER-DOUBLER**

**25Y5**

Glass type used as half-wave rectifier or voltage doubler in ac/dc receivers. Outline 34 or 35, OUTLINES SECTION. Heater volts (ac/dc), 25; amperes, 0.3. Maximum ratings: peak inverse plate volts, 700; peak plate ma. per plate, 450; peak heater-cathode volts, 350; dc output ma. per plate, 75. This is a DISCONTINUED type listed for reference only.

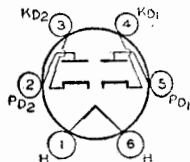

**VACUUM RECTIFIER-DOUBLER**

**25Z5**

Glass type used as half-wave rectifier or voltage doubler in ac/dc receivers. Outline 34 or 35, OUTLINES SECTION. Tube requires six-contact socket and may be mounted in any position. Heater volts (ac/dc), 25; amperes, 0.3. This type is electrically identical with metal type 25Z6. Type 25Z5 is used principally for renewal purposes.

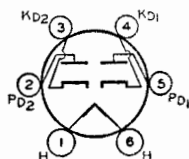

**VACUUM RECTIFIER-DOUBLER**

**25Z6  
25Z6-GT**

Metal type 25Z6 and glass octal type 25Z6-GT used as half-wave rectifiers or voltage-doublers in ac/dc receivers. These types are used particularly in "transformerless" receivers of

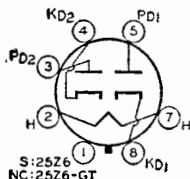

either the ac/dc type or the voltage-doubler type. Outlines 6 and 22, respectively, OUTLINES SECTION. Type 25Z6-GT may be supplied with pin No.1 omitted. Tubes require octal socket and may be mounted in any position. Type 25Z6 is a DISCONTINUED type listed for reference only.

HEATER VOLTAGE (AC/DC) .....	25	volts
HEATER CURRENT .....	0.3	ampere

<b>Maximum Ratings:</b>		<b>HALF-WAVE RECTIFIER</b>	
PEAK INVERSE PLATE VOLTAGE .....	700 max	volts	
PEAK PLATE CURRENT (Per Plate) .....	450 max	ma	
DC OUTPUT CURRENT (Per Plate) .....	75 max	ma	
PEAK HEATER-CATHODE VOLTAGE .....	350 max	volts	

**Typical Operation (Capacitor-Input Filter):<sup>o</sup>**

(Unless otherwise indicated, values are for both plates in parallel.)

AC Plate-Supply Voltage per Plate (rms) .....	117	150	235	volts
Filter-Input Capacitor .....	16	16	16	μf
Min. Total Effective Plate-Supply Impedance per Plate† .....	15	40	100	ohms
DC Output Current per Plate .....	75	75	75	ma
DC Output Voltage At Input to Filter (Approx.):				
At half-load current (75 ma.) .....	115	-	255	volts
At full-load current (150 ma.) .....	80	-	200	volts
Voltage Regulation (Approx.):				
Half-load to full-load current .....	35	-	55	volts

**VOLTAGE DOUBLER**

Maximum Ratings: (Same as for Half-Wave Rectifier.)

<b>Typical Operation:</b>		<i>Half-Wave</i>	<i>Full-Wave</i>	
AC Plate-Supply Voltage per Plate (rms) .....	117	117	117	volts
Filter-Input Capacitor (Each) .....	16	16	16	μf
Min. Total Effective Plate-Supply Impedance per Plate† .....	30	15	15	ohms
DC Output Current .....	75	75	75	ma

<sup>o</sup> In half-wave rectifier service, the two units may be used separately or in parallel.

† When a filter-input capacitor larger than 40 μf is used, it may be necessary to use more plate-supply impedance than the minimum value shown to limit the peak plate current to the rated value.



**MEDIUM-MU TRIODE**

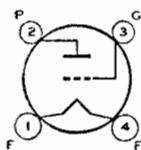

Glass type used as rf voltage amplifier in ac-operated receivers. Outline 43, OUTLINES SECTION. Tube requires four-contact socket. Filament volts (ac/dc), 1.5; amperes, 1.05. Typical operation as class A<sub>1</sub> amplifier: plate volts, 180 max; grid volts, -14.5, plate ma., 6.2; plate resistance, 7300 ohms; transconductance, 1150 μmhos; amplification factor, 8.3. This is a DISCONTINUED type listed for reference only.

26

**LOW-MU TRIODE**

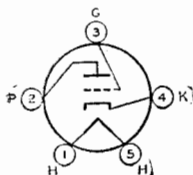

Glass type used as voltage amplifier or detector in ac-operated receivers. Outline 34 or 35, OUTLINES SECTION. Tube requires five-contact socket. Heater volts (ac/dc), 2.5; amperes, 1.75. Maximum ratings and characteristics as class A<sub>1</sub> amplifier: plate volts, 250 max; grid volts, -21; amplification factor, 9; plate resistance, 9250 ohms; transconductance, 975 μmhos; plate ma., 5.2. This type is used principally for renewal purposes.

27

**MEDIUM-MU TRIODE**

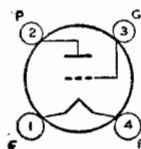

Glass type used as voltage amplifier or detector in battery-operated receivers. Outline 34 or 35, OUTLINES SECTION. Tube requires four-contact socket. Filament volts (dc), 2.0; amperes, 0.06. Except for interelectrode capacitances, this type is electrically identical with glass-octal type 1H4-G. Type 30 is a DISCONTINUED type listed for reference only.

30

**POWER TRIODE**

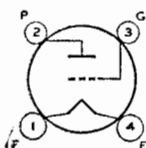

Glass type used in output stage of battery-operated receivers. Outline 34 or 35, OUTLINES SECTION. Tube requires four-contact socket. Filament volts (dc), 2.0; amperes, 0.13. Typical operation as class A<sub>1</sub> amplifier: plate volts, 180 max; grid volts, -30; plate ma., 12.3; plate resistance, 3600 ohms; amplification factor, 3.8; transconductance, 1050 μmhos; load resistance, 5700 ohms; output watts, 0.375. This is a DISCONTINUED type listed for reference only.

31

**SHARP-CUTOFF TETRODE**

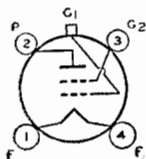

Glass type used as rf amplifier or biased detector in battery-operated receivers. Maximum over-all length, 5-1/32 inches; maximum diameter, 1-13/16 inches. Tube requires four-contact socket. Filament volts (dc), 2.0; amperes, 0.06. Typical operation as class A<sub>1</sub> amplifier: plate volts, 180 max; grid-No.2 ma., 0.4 max; plate resistance, greater than 1 megohm; plate ma., 1.7; transconductance, 650 μmhos. This is a DISCONTINUED type listed for reference only.

32

**POWER PENTODE**

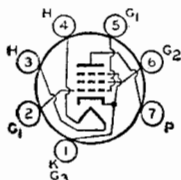

Miniature type used in audio output stage of compact ac/dc radio receivers. Outline 13, OUTLINE SECTION. Tube requires miniature seven-contact socket and may be mounted in any position. Heater volts (ac/dc), 32; amperes, 0.1.

32ET5

## CLASS A<sub>1</sub> AMPLIFIER

### Maximum Ratings, (Design-Maximum Values):

PLATE VOLTAGE.....	150 <i>max</i>	volts
GRID-NO.2 (SCREEN-GRID) VOLTAGE.....	130 <i>max</i>	volts
GRID-NO.2 INPUT.....	1.2 <i>max</i>	watts
PLATE DISSIPATION.....	5.4 <i>max</i>	watts
<b>PEAK HEATER-CATHODE VOLTAGE:</b>		
Heater negative with respect to cathode.....	200 <i>max</i>	volts
Heater positive with respect to cathode.....	200 <i>max</i>	volts

### Typical Operation and Characteristics:

Plate Voltage.....	110	volts
Grid-No.2 Voltage.....	110	volts
Grid-No.1 (Control-Grid) Voltage.....	-7.5	volts
Peak AF Grid-No.1 Voltage.....	7.5	volts
Zero-Signal Plate Current.....	30	ma
Zero-Signal Grid-No.2 Current.....	2.8	ma
Plate Resistance (Approx.).....	21500	ohms
Transconductance.....	5500	$\mu$ mhos
Load Resistance.....	2800	ohms
Total Harmonic Distortion.....	10	per cent
Maximum-Signal Power Output.....	1.2	watts

### Maximum Circuit Values:

<b>Grid-No.1-Circuit Resistance:</b>		
For fixed-bias operation.....	0.1 <i>max</i>	megohm
For cathode-bias operation.....	0.5 <i>max</i>	megohm

■ The dc component must not exceed 100 volts.

## RECTIFIER—BEAM POWER TUBE

### 32L7-GT

Glass octal type used as combined half-wave rectifier and output amplifier in ac/dc receivers. Outline 23, OUTLINES SECTION. Tube requires octal socket. Heater volts (ac/dc), 32.5; amperes, 0.3. Maximum ratings for rectifier unit: ac plate volts (rms), 125; dc output ma., 60. Typical operation of beam power unit as class A<sub>1</sub> amplifier: plate and grid-No.2 volts,

90; grid-No.1 volts, -7; plate ma., 27; grid-No.2 ma., 2; plate resistance, 17000 ohms; transconductance, 1800  $\mu$ mhos; load resistance, 2600 ohms; maximum-signal output watts, 1.0. This is a DISCONTINUED type listed for reference only.

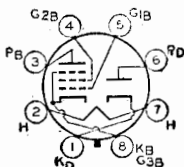

## POWER PENTODE

### 33

Glass type used in output stage of battery-operated receivers. Outline 42, OUTLINES SECTION. Tube requires five-contact socket. Filament volts (dc), 2.0; amperes, 0.26. Typical operation as class A<sub>1</sub> amplifier: plate and grid-No.2 volts, 180 *max*; grid-No.1 volts, -18; plate ma., 22; grid-No.2 ma., 5; plate resistance, 55000 ohms; transconductance, 1750  $\mu$ mhos;

load resistance, 6000 ohms; output watts, 1.4. This is a DISCONTINUED type listed for reference only.

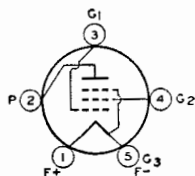

## REMOTE-CUTOFF PENTODE

### 34

Glass type used as rf or if amplifier in battery-operated radio receivers, particularly those employing avc. Maximum over-all length, 5-1/32 inches; maximum diameter, 1-13/16 inches. Tube requires four-contact socket. Filament volts (dc), 2.0; amperes, 0.06. Characteristics as class A<sub>1</sub> amplifier: plate volts, 180 *max*; grid-No.2 volts, 67.5 *max*; grid-No.1 volts, -3

*min*: plate ma., 2.8; grid-No.2 ma., 1.0; plate resistance, 1.0 megohm; transconductance, 620  $\mu$ mhos. This is a DISCONTINUED type listed for reference only.

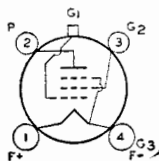

**BEAM POWER TUBE**

Miniature types used in audio output stages of compact ac/dc radio receivers. Outline 13, OUTLINES SECTION. Tubes require miniature seven-contact socket and may be operated in any position.

**34GD5**  
**34GD5-A**

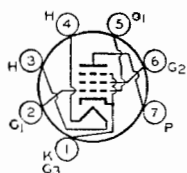

HEATER VOLTAGE (AC/DC).....	34	volts
HEATER CURRENT.....	0.1	ampere
HEATER WARM-UP TIME (AVERAGE) for 34GD5-A.....	20	seconds
DIRECT INTERELECTRODE CAPACITANCES (Approx.): <sup>o</sup>		
Grid No.1 to Plate.....	0.6	$\mu\text{f}$
Grid No.1 to Cathode, Heater, Grid No.2, and Grid No.3.....	12	$\mu\text{f}$
Plate to Cathode, Heater, Grid No.2, and Grid No.3:		
For 34GD5.....	6	$\mu\text{f}$
For 34GD5-A.....	9	$\mu\text{f}$

<sup>o</sup>Without external shield.

**CLASS A<sub>1</sub> AMPLIFIER**

Maximum Ratings, (Design-Maximum Values):

PLATE VOLTAGE.....	150 max	volts
GRID-NO.2 (SCREEN-GRID) VOLTAGE.....	130 max	volts
GRID-NO.1 (CONTROL-GRID) VOLTAGE:		
Negative-bias value.....	50 max	volts
Positive-bias value.....	0 max	volts

**AVERAGE CHARACTERISTICS**

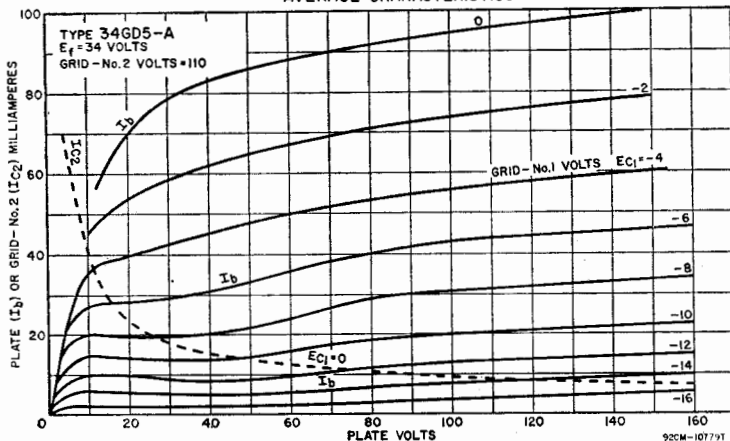

GRID-NO.2 INPUT.....	1.1 max	watts
PLATE DISSIPATION.....	5 max	watts
PEAK HEATER-CATHODE VOLTAGE:		
Heater negative with respect to cathode.....	200 max	volts
Heater positive with respect to cathode.....	200 max	volts
BULB TEMPERATURE (At hottest point):		
For 34GD5.....	180 max	$^{\circ}\text{C}$
For 34GD5-A.....	250 max	$^{\circ}\text{C}$

**Typical Operation and Characteristics:**

Plate Voltage.....	110	volts
Grid-No.2 Voltage.....	110	volts
Grid-No.1 Voltage.....	-7.5	volts
Peak AF Grid-No.1 Voltage.....	7.5	volts
Zero-Signal Plate Current.....	35	ma
Zero-Signal Grid-No.2 Current.....	3	ma
Plate Resistance (Approx.).....	13000	ohms
Transconductance.....	5700	$\mu\text{mhos}$
Load Resistance.....	2500	ohms
Total Harmonic Distortion.....	10	per cent
Maximum-Signal Power Output.....	1.4	watts

**Maximum Circuit Values:**

Grid-No.1-Circuit Resistance:	
For fixed-bias operation.....	0.1 max megohm
For cathode-bias operation.....	0.5 max megohm

■ The dc component must not exceed 100 volts.

**REMOTE-CUTOFF TETRODE**

Glass type used as rf or if amplifier in ac receivers. Maximum over-all length, 5-1/32 inches; maximum diameter, 1-13/16 inches. Tube requires five-contact socket. Heater volts (ac/dc), 2.5; amperes, 1.75. Characteristics as class A<sub>1</sub> amplifier: plate volts, 250 (275 max); grid-No.2 volts, 90 max; grid-No.1 volts, -3 min; plate ma., 6.5; grid-No.2 ma., 2.5; trans-

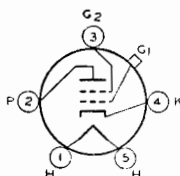

**35**

conductance, 1050  $\mu$ mhos. This is a DISCONTINUED type listed for reference only.

**BEAM POWER TUBE**

Glass lock-in type used in output stage of ac/dc receivers. Outline 20, OUTLINES SECTION. Tube requires lock-in socket. Heater volts (ac/dc), 35; amperes, 0.15. For maximum ratings and typical operation, refer to glass octal type 35L6-GT. Type 35A5 is used principally for renewal purposes.

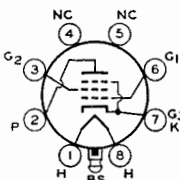

**35A5**

**BEAM POWER TUBE**

Miniature type used in output stage of compact, ac/dc radio receivers. Because of its high power sensitivity at plate and screen-grid voltages available in ac/dc receivers, it is capable of providing a relatively high power output. Outline 13, OUTLINES SECTION. Tube requires miniature seven-contact socket and may be mounted in any position.

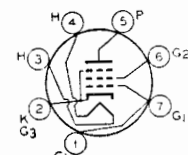

**35B5**

Because of its high power sensitivity at plate and screen-grid voltages available in ac/dc receivers, it is capable of providing a relatively high power output. Outline 13, OUTLINES SECTION. Tube requires miniature seven-contact socket and may be mounted in any position. Within its maximum ratings, type 35B5 is equivalent in performance to glass-octal type 35L6-GT, and miniature type 35C5. Refer to type 35C5 for typical operation, maximum circuit values, installation, application information, and curves.

HEATER VOLTAGE (AC/DC).....	35	volts
HEATER CURRENT.....	0.15	ampere
DIRECT INTERELECTRODE CAPACITANCES (Approx.):		
Grid No.1 to Plate.....	0.6	$\mu$ f
Grid No.1 to Cathode, Heater, Grid No.2, and Grid No.3.....	12	$\mu$ f
Plate to Cathode, Heater, Grid No.2, and Grid No.3.....	9	$\mu$ f

**CLASS A<sub>1</sub> AMPLIFIER**

Maximum Ratings:		
PLATE VOLTAGE.....	117 max	volts
GRID-NO.2 (SCREEN-GRID) VOLTAGE.....		
PLATE DISSIPATION.....	4.5 max	watts
GRID-NO.2 INPUT.....	1.0 max	watt
PEAK HEATER-CATHODE VOLTAGE:		
Heater negative with respect to cathode.....	150 max	volts
Heater positive with respect to cathode.....	150 max	volts

**BEAM POWER TUBE**

Miniature type used in output stage of compact, ac/dc radio receivers. Because of its high power sensitivity and high efficiency at plate and screen-grid voltages available in ac/dc receivers, the 35C5 is capable of providing a relatively high power output. Except

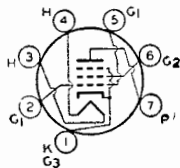

**35C5**

for terminal connections and slightly higher ratings, type 35C5 is equivalent in performance to miniature type 35B5 and, within its maximum ratings, to glass octal type 35L6-GT. The basing arrangement of the 35C5 simplifies the problem of meeting Underwriters' Laboratories requirements in the design of ac/dc receivers.

HEATER VOLTAGE (AC/DC).....	35	volts
HEATER CURRENT.....	0.15	ampere
DIRECT INTERELECTRODE CAPACITANCES (Approx.):		
Grid No.1 to Plate.....	0.6	$\mu\text{f}$
Grid No.1 to Cathode, Heater, Grid No.2, and Grid No.3.....	12	$\mu\text{f}$
Plate to Cathode, Heater, Grid No.2, and Grid No.3.....	9	$\mu\text{f}$

**CLASS A<sub>1</sub> AMPLIFIER**

Maximum Ratings, (Design-Maximum Values):

PLATE VOLTAGE.....	150 max	volts
GRID-NO.2 (SCREEN-GRID) VOLTAGE.....	130 max	volts
PLATE DISSIPATION.....	5.2 max	watts
GRID-NO.2 INPUT.....	1.1 max	watt
PEAK HEATER-CATHODE VOLTAGE:		
Heater negative with respect to cathode.....	200 max	volts
Heater positive with respect to cathode.....	200 max	volts
BULB TEMPERATURE (At hottest point).....	250 max	$^{\circ}\text{C}$

Typical Operation:

Plate Voltage.....	110	volts
Grid-No.2 Voltage.....	110	volts
Grid-No.1 (Control-Grid) Voltage.....	-7.5	volts
Peak AF Grid-No.1 Voltage.....	7.5	volts
Zero-Signal Plate Current.....	40	ma
Maximum-Signal Plate Current.....	41	ma
Zero-Signal Grid-No.2 Current.....	3	ma
Maximum-Signal Grid-No.2 Current.....	7	ma
Plate Resistance (Approx.).....	18000	ohms
Transconductance.....	5800	$\mu\text{mhos}$
Load Resistance.....	2500	ohms
Total Harmonic Distortion.....	10	per cent
Maximum-Signal Power Output.....	1.5	watts

**AVERAGE PLATE CHARACTERISTICS  
PENTODE CONNECTION**

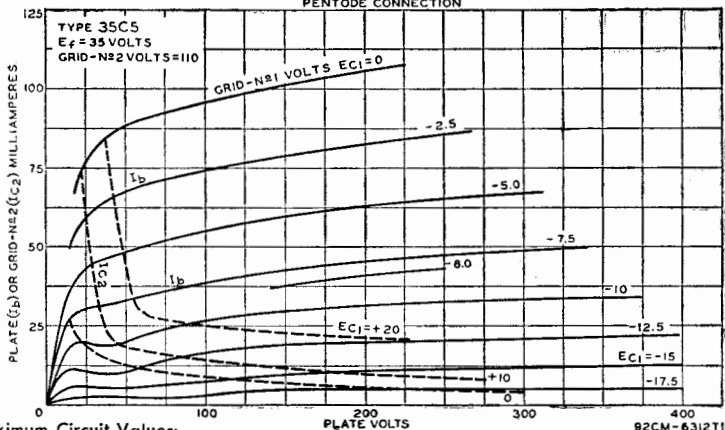

Maximum Circuit Values:

Grid-No.1-Circuit Resistance:		
For fixed-bias operation.....	0.1 max	megohm
For cathode-bias operation.....	0.5 max	megohm

■ The dc component must not exceed 100 volts.

**INSTALLATION AND APPLICATION**

Type 35C5 requires miniature seven-contact socket and may be mounted in any position. Outline 13, OUTLINES SECTION. It is especially important that this tube, like other power-handling tubes, should be adequately ventilated.

The 35-volt heater is designed to operate under the normal conditions of line-voltage variation without materially affecting the performance or serviceability of the 35C5. For operation of the 35C5 in series with other types having 0.15-ampere rating, the current in the heater circuit should be adjusted to 0.15 ampere for the normal supply voltage.

**HIGH-MU TRIODE—  
POWER PENTODE**

**35DZ8**

Miniature type used as two-stage af amplifier where plate supply voltage is obtained from single half-wave rectifier connected directly to 120-volt ac line. Similar to Outline 18, OUTLINES

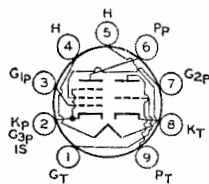

SECTION but maximum seated length is 2 7/8 inches and other vertical dimensions are 1/16 inch shorter than shown. Tube requires miniature nine-contact socket and may be operated in any position.

HEATER VOLTAGE (AC/DC).....	35	volts
HEATER CURRENT.....	0.15	ampere

**CLASS A<sub>1</sub> AMPLIFIER**

**Maximum Ratings:**

	<i>Triode Unit</i>	<i>Pentode Unit</i>	
PLATE VOLTAGE.....	150 max	150 max	volts
GRID-NO.2 (SCREEN-GRID) VOLTAGE.....	—	135 max	volts
CATHODE CURRENT.....	5 max	60 max	ma
PLATE DISSIPATION.....	0.75 max	6.5 max	watts
GRID-NO.2 INPUT.....	—	1.5 max	watts
<b>PEAK HEATER-CATHODE VOLTAGE:</b>			
Heater negative with respect to cathode.....	200 max	200 max	volts
Heater positive with respect to cathode.....	200 <sup>o</sup> max	200 <sup>o</sup> max	volts

**Typical Operation and Characteristics:**

	<i>Triode Unit</i>	<i>Pentode Unit</i>	
Plate Supply Voltage.....	120	145	volts
Grid-No.2 Supply Voltage.....	—	120	volts
Cathode-Bias Resistor.....	1500	180	ohms
Amplification Factor.....	100	—	
Plate Current.....	0.8	45	ma
Grid-No.2 Current.....	—	6	ma
Transconductance.....	1400	7500	μmhos
Load Resistance.....	—	2500	ohms
Power Output.....	—	2	watts
Grid Voltage (Approx.), for plate current of 20 μa.....	-2.5	—	volts

**Maximum Circuit Values:**

	<i>Triode Unit</i>	<i>Pentode Unit</i>	
Grid-No.1-Circuit Resistance.....	5 max	0.5 max	megohms

\* The dc component must not exceed 100 volts.

**POWER PENTODE**

**35EH5**

Miniature type used in the audio output stage of radio and television receivers and in phonographs. This type has unusually high power sensitivity and is capable of providing relatively

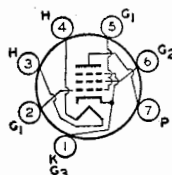

high power output at low plate and screen-grid voltages with a low af grid-No.1 driving voltage. Outline 13, OUTLINES SECTION. Tube requires miniature seven-contact socket and may be mounted in any position.

HEATER VOLTAGE (AC/DC).....	35	volts
HEATER CURRENT.....	0.15	amperes
<b>DIRECT INTERELECTRODE CAPACITANCES (Approx.):</b>		
Grid No.1 to Plate.....	0.65	μμf
Grid No.1 to Cathode, Heater, Grid No.2, and Grid No.3.....	17	μμf
Plate to Cathode, Heater, Grid No.2, and Grid No.3.....	9	μμf

**CLASS A<sub>1</sub> AMPLIFIER**

**Maximum Ratings, (Design-Maximum Values):**

PLATE VOLTAGE.....	150 max	volts
GRID-NO.2 (SCREEN-GRID) VOLTAGE.....	130 max	volts
GRID-NO.1 (CONTROL-GRID) VOLTAGE, Positive-bias value.....	0 max	volts
PLATE DISSIPATION.....	5 max	watts
GRID-NO.2 INPUT.....	1.75 max	watts

## Technical Data

### PEAK HEATER-CATHODE VOLTAGE:

Heater negative with respect to cathode.....	200 <i>max</i>	volts
Heater positive with respect to cathode.....	200 <i>max</i>	volts
BULB TEMPERATURE (At hottest point).....	225 <i>max</i>	°C

### Typical Operation:

Plate Supply Voltage.....	110	volts
Grid-No.2 Supply Voltage.....	115	volts
Cathode-Bias Resistor.....	62	ohms
Peak AF Grid-No.1 Voltage.....	3	volts
Zero-Signal Plate Current.....	32	ma
Maximum-Signal Plate Current.....	32	ma
Zero-Signal Grid-No.2 Current.....	7.2	ma
Maximum-Signal Grid-No.2 Current.....	12	ma
Plate Resistance (Approx.).....	14000	ohms
Transconductance.....	3000	$\mu$ hos
Load Resistance.....	3000	ohms
Total Harmonic Distortion.....	8	per cent
Maximum-Signal Power Output.....	1.2	watts

■ The dc component must not exceed 100 volts.

### Maximum Circuit Values:

Grid-No.1-Circuit Resistance:		
For fixed-bias operation.....	0.1 <i>max</i>	megohm
For cathode-bias operation.....	0.5 <i>max</i>	megohm

In a series-heater circuit of the "dc power line" type employing several 0.15-ampere types and one or two 35C5s, the heater(s) of the 35C5(s) should be placed on the positive side of the line. Under these conditions, heater-cathode voltage of the 35C5 must not exceed the value given under maximum ratings. In a series-heater circuit of the "universal" type employing rectifier tube 35W4, one or two 35C5s and several 0.15-ampere types, it is recommended that the heater(s) of the 35C5(s) be placed in the circuit so that the higher values of heater-cathode bias will be impressed on the 35C5(s) rather than on the other 0.15-ampere types. This is accomplished by arranging the 35C5(s) on the side of the supply line which is connected to the cathode of the rectifier, i.e., the positive terminal of the rectified voltage supply. Between this side of the line and the 35C5(s), any necessary auxiliary resistance and the heater of the 35W4 are connected in series.

As a power amplifier (class A<sub>1</sub>), the 35C5 is recommended for use either singly or in push-pull combination in the power-output stage of ac/dc receivers. The operating values shown under typical operation have been determined on the basis that grid-No.1 current does not flow during any part of the input cycle.

AVERAGE CHARACTERISTICS

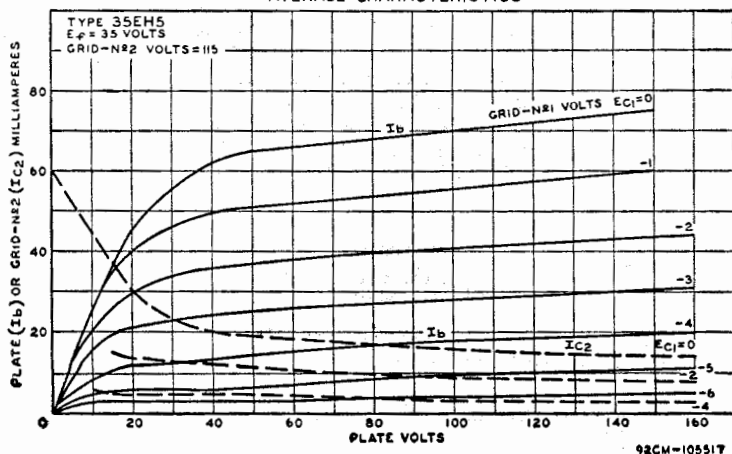

**BEAM POWER TUBE**

**35GL6**

Miniature type used in af power-output stage of radio receivers. Outline 13, OUTLINES SECTION. Tube has heater tap which may be used for operating a 6.3-volt, 150-ma. panel

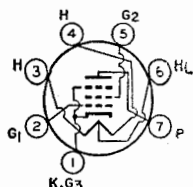

lamp in equipment using semiconductor rectifiers. For dc output currents greater than 70 ma., a resistor shunting the panel lamp is required. Tube requires miniature seven-contact socket and may be operated in any position.

	Without Panel Lamp	With No.40 or 47 Panel Lamp	
HEATER VOLTAGE (AC/DC):			
ENTIRE HEATER (PINS 3 AND 4) . . . . .	35	32	volts
PANEL LAMP SECTION (PINS 4 AND 6) . . . . .	7	5.5	volts
HEATER CURRENT:			
BETWEEN PINS 3 AND 4 . . . . .	0.15	-	ampere
BETWEEN PINS 3 AND 6 . . . . .	-	0.15	ampere

**CLASS A<sub>1</sub> AMPLIFIER**

**Maximum Ratings, (Design-Maximum Values):**

RMS HEATER-TAP VOLTAGE, when panel lamp fails . . . . .	14 max	volts
PLATE VOLTAGE . . . . .	150 max	volts
GRID-NO.2 (SCREEN-GRID) VOLTAGE . . . . .	130 max	volts
PLATE DISSIPATION . . . . .	5.5 max	watts
GRID-NO.2 INPUT . . . . .	1.1 max	watts
PEAK HEATER-CATHODE VOLTAGE:		
Heater negative with respect to cathode . . . . .	200 max	volts
Heater positive with respect to cathode . . . . .	200 max	volts
BULB TEMPERATURE (At hottest point) . . . . .	225 max	°C

**Typical Operation and Characteristics:**

Plate Voltage . . . . .	110	volts
Grid-No.2 Voltage . . . . .	110	volts
Grid-No.1 (Control-Grid) Voltage . . . . .	-7.5	volts
Peak AF Grid-No.1 Voltage . . . . .	7.5	volts
Zero-Signal Plate Current . . . . .	45	ma
Maximum-Signal Plate Current . . . . .	47	ma
Zero-Signal Grid-No.2 Current . . . . .	3	ma
Maximum-Signal Grid-No.2 Current . . . . .	9	ma
Plate Resistance (Approx.) . . . . .	12000	ohms
Transconductance . . . . .	7500	μmhos
Load Resistance . . . . .	2500	ohms
Total Harmonic Distortion . . . . .	8	per cent
Maximum-Signal Power Output . . . . .	1.8	watts

**Maximum Circuit Values:**

Grid-No.1-Circuit Resistance:		
For fixed-bias operation . . . . .	0.1 max	megohm
For cathode-bias operation . . . . .	0.5 max	megohm

**BEAM POWER TUBE**

**35L6-GT**

Glass octal type used in output stage of ac/dc radio receivers. Outline 22, OUTLINES SECTION. Tube requires octal socket and may be mounted in any position. This type

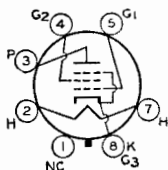

may be supplied with pin No.1 omitted. Refer to miniature type 35C5 for installation, application information, and curves.

HEATER VOLTAGE (AC/DC) . . . . .	35	volts
HEATER CURRENT . . . . .	0.15	ampere
DIRECT INTERELECTRODE CAPACITANCES (Approx.):		
Grid No.1 to Plate . . . . .	0.6	μf
Grid No.1 to Cathode, Heater, Grid No.2, and Grid No.3 . . . . .	13	μf
Plate to Cathode, Heater, Grid No.2, and Grid No.3 . . . . .	9.5	μf



**Maximum Ratings:**
**CLASS A<sub>1</sub> AMPLIFIER**

PLATE VOLTAGE	200 max	volts
GRID-NO.2 (SCREEN-GRID) VOLTAGE	125 max	volts
PLATE DISSIPATION	8.5 max	watts
GRID-NO.2 INPUT	1.0 max	watt
<b>PEAK HEATER-CATHODE VOLTAGE:</b>		
Heater negative with respect to cathode	90 max	volts
Heater positive with respect to cathode	90 max	volts

**Typical Operation:**

	<i>Fixed Bias</i>	<i>Cathode Bias</i>	
Plate Supply Voltage	110	200	volts
Grid-No.2 Supply Voltage	110	125	volts
Grid-No.1 (Control-Grid) Voltage	-7.5	-	volts
Cathode-Bias Resistor	-	180	ohms
Peak AF Grid-No.1 Voltage	7.5	8	volts
Zero-Signal Plate Current	40	43	ma
Maximum-Signal Plate Current	41	43	ma
Zero-Signal Grid-No.2 Current	3	2	ma
Maximum-Signal Grid-No.2 Current	7	5.5	ma
Plate Resistance (Approx.)	14000	34000	ohms
Transconductance	5800	6100	μmhos
Load Resistance	2500	5000	ohms
Total Harmonic Distortion	10	10	per cent
Maximum-Signal Power Output	1.5	3.0	watts

**Maximum Circuit Values:**

<b>Grid-No.1-Circuit Resistance:</b>		
For fixed-bias operation	0.1 max	megohm
For cathode-bias operation	0.5 max	megohm

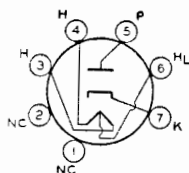

## HALF-WAVE VACUUM RECTIFIER

Miniature type used in power supply of ac/dc receivers. Equivalent in performance to glass-octal type 35Z5-GT. The heater is provided with a tap for operation of a panel lamp.

# 35W4

<b>HEATER VOLTAGE (AC/DC):</b>	*	**	
ENTIRE HEATER (PINS 3 AND 4)	35	32	volts
PANEL LAMP SECTION (PINS 4 AND 6)	7.5	5.5	volts
<b>HEATER CURRENT:</b>			
BETWEEN PINS 3 AND 4	0.15	-	ampere
BETWEEN PINS 3 AND 6	-	0.15	ampere

\* Without panel lamp.

\*\* With No.40 or No.47 panel lamp.

## HALF-WAVE RECTIFIER

**Maximum Ratings, (Design-Maximum Values):**

PEAK INVERSE PLATE VOLTAGE	360 max	volts
PEAK PLATE CURRENT	660 max	ma
<b>DC OUTPUT CURRENT:</b>		
With Panel Lamp and { No Shunting Resistor	66 max	ma
Without Panel Lamp { Shunting Resistor	100 max	ma
PANEL-LAMP-SECTION VOLTAGE (rms):	110 max	ma
When Panel Lamp Falls	17 max	volts
<b>PEAK HEATER-CATHODE VOLTAGE:</b>		
Heater negative with respect to cathode	360 max	volts
Heater positive with respect to cathode	360 max	volts

**Typical Operation with Panel Lamp:†**

AC Plate-Supply Voltage (rms)	117	117	117	117	volts
Filter-Input Capacitor	40	40	40	40	μf
Minimum Total Effective Plate-Supply Impedance	15	15	15	15	ohms
Panel-Lamp Shunting Resistor	-	300	150	100	ohms
DC Output Current	60	70	80	90	ma

† No.40 or No.47 panel lamp used in circuit given below with capacitor-input filter.

**Typical Operation without Panel Lamp:**

AC Plate-Supply Voltage (rms)	117	volts
Filter-Input Capacitor	40	μf
Minimum Total Effective Plate-Supply Impedance	15	ohms
DC Output Current	100	ma
<b>DC Output Voltage at Input to Filter (Approx.):</b>		
At half-load current (50 ma.)	135	volts
At full-load current (100 ma.)	120	volts
<b>Voltage Regulation (Approx.):</b>		
Half-load to full-load current	15	volts

Maximum Circuit Values:

Panel-Lamp Shunting Resistor\*:

For dc output current of	{ 70 ma.....	800 max	ohms
	{ 80 ma.....	400 max	ohms
	{ 90 ma.....	250 max	ohms

\* Required when dc output current is greater than 60 milliamperes.

INSTALLATION AND APPLICATION

Tube requires miniature seven-contact socket and may be mounted in any position. Outline 13, OUTLINES SECTION. For heater considerations, refer to miniature type 35C5.

With the panel lamp connected as shown in the diagram, the drop across R and all heaters (with panel lamp) should equal 117 volts at 0.15 ampere. The shunting resistor  $R_s$  is required when dc output current exceeds 60 milliamperes. Values of  $R_s$  for dc output currents greater than 60 milliamperes are given in tabulated data.

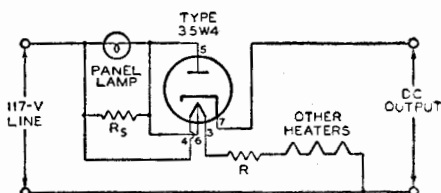
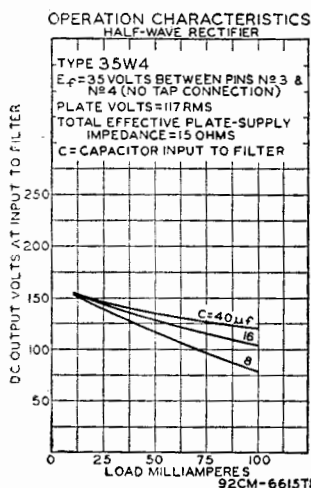

HALF-WAVE VACUUM RECTIFIER

Glass lock-in type used in power supply of ac/dc receivers. The heater is provided with tap for the operation of a panel lamp. Outline 20, OUTLINES SECTION. Tube requires lock-in socket. Heater volts (ac/dc), 35; amperes, 0.15. For maximum ratings, refer to glass octal type 35Z5-GT. For typical operation and curves, refer to miniature type 35W4. Type 35Y4 is used principally for renewal purposes.

35Y4

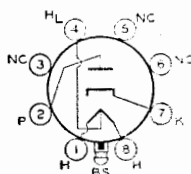

HALF-WAVE VACUUM RECTIFIER

Glass lock-in type used in power supply of ac/dc receivers. Outline 20, OUTLINES SECTION. Tube requires lock-in socket. Heater volts (ac/dc), 35; amperes, 0.15. For maximum ratings and typical operation, refer to glass octal type 35Z5-GT without panel lamp. Type 35Z3 is used principally for renewal purposes.

35Z3

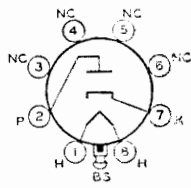

HALF-WAVE VACUUM RECTIFIER

Glass octal type used in power supply of ac/dc receivers. Outline 22, OUTLINES SECTION. Tube requires octal socket. This type may be supplied with pin No.1 omitted. Heater volts (ac/dc), 35; amperes, 0.15. For maximum ratings and typical operation, refer to glass octal type 35Z5-GT without panel lamp. Type 35Z4-GT is used principally for renewal purposes.

35Z4-GT

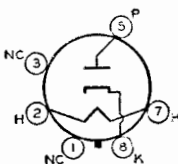

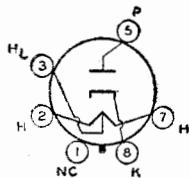

### HALF-WAVE VACUUM RECTIFIER

# 35Z5-GT

Glass octal type used in power supply of ac/dc receivers. The heater is provided with a tap for operation of a panel lamp. Outline 22, OUTLINES SECTION. Tube requires

octal socket and may be mounted in any position. This type may be supplied with pin No.1 omitted. For installation and application considerations, refer to miniature type 35W4.

HEATER VOLTAGE (AC/DC):	*	**	
ENTIRE HEATER (PINS 2 AND 7) .....	35	32	volts
PANEL LAMP SECTION (PINS 2 AND 3) .....	7.5	6.5	volts
HEATER CURRENT:			
BETWEEN PINS 2 AND 7 .....	0.15	-	ampere
BETWEEN PINS 3 AND 7 .....	-	0.15	ampere

\* Without panel lamp.      \*\* With No.40 or No. 47 panel lamp.

### Maximum Ratings: HALF-WAVE RECTIFIER

PEAK INVERSE PLATE VOLTAGE .....	700 max	volts
PEAK PLATE CURRENT .....	600 max	ma
DC OUTPUT CURRENT:		
With Panel Lamp and { No Shunting Resistor .....	60 max	ma
{ Shunting Resistor .....	90 max	ma
Without Panel Lamp .....	100 max	ma
PANEL-LAMP-SECTION VOLTAGE (rms):		
When Panel Lamp Fails .....	15 max	volts
PEAK HEATER-CATHODE VOLTAGE:		
Heater negative with respect to cathode .....	350 max	volts
Heater positive with respect to cathode .....	350 max	volts

### Typical Operation with Panel Lamp:†

AC Plate-Supply Voltage (rms) .....	117	117	117	235	volts
Filter-Input Capacitor .....	40	40	40	40	μf
Minimum Total Effective Plate-Supply Impedance .....	15	15	15	15	ohms
Panel-Lamp Shunting Resistor .....	-	300	150	100	ohms
DC Output Current .....	60	70	80	90	ma

† No.40 or No.47 panel lamp used in circuit with capacitor-input filter given under type 35W4.

### Typical Operation without Panel Lamp:

AC Plate-Supply Voltage (rms) .....	117	235	volts
Filter-Input Capacitor .....	40	40	μf
Minimum Total Effective Plate-Supply Impedance .....	15	100	ohms
DC Output Current .....	100	100	ma
DC Output Voltage at Input to Filter (Approx.):			
At half-load current (50 ma.) .....	140	280	volts
At full-load current (100 ma.) .....	120	235	volts
Voltage Regulation (Approx.):			
Half-load to full-load current .....	20	45	volts

### Maximum Circuit Values:

Panel-Lamp Shunting Resistor:*			
For dc output current of { 70 ma. ....	800 max	ohms	
{ 80 ma. ....	400 max	ohms	
{ 90 ma. ....	250 max	ohms	

\* Required when dc output current is greater than 60 milliamperes.

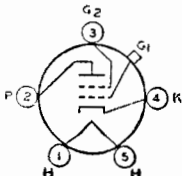

### SHARP-CUTOFF TRODE

Glass type used as rf or if amplifier or as biased or grid-resistor detector in radio receivers. Outline 40, OUTLINES SECTION. Tube requires five-contact socket. Heater volts (ac/dc), 6.3; amperes, 0.3. Characteristics as class A<sub>1</sub> amplifier: plate volts, 250 max; grid-No.2 volts, 90 max; grid-No.1 volts, -3; plate ma., 3.2; grid-No.2 ma., 1.7 max; plate resistance, 0.55 megohm; transconductance, 1080 μmhos. This is a DISCONTINUED type listed for reference only.

# 36

**36AM3**  
**36AM3-A**  
**36AM3-B**

**HALF-WAVE VACUUM RECTIFIER**

Miniature types used in power supply of ac/dc receivers. These types have a tapped heater so that the heater section between pins 4 and 6 can be used as a limiting resistance in the rectifier

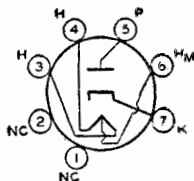

plate circuit. This heater section is not to be used as a panel-lamp shunt. Outline 13, OUTLINES SECTION. Tubes require miniature seven-contact socket and may be operated in any position.

**HEATER VOLTAGE (AC/DC):**

ENTIRE HEATER (PINS 3 AND 4).....	36	volts
TAP SECTION (PINS 3 AND 6).....	32	volts
HEATER CURRENT (PINS 3 AND 6).....	0.1	ampere
HEATER WARM-UP TIME (Average), For 36AM3-B.....	20	seconds

**HALF-WAVE RECTIFIER**

**Maximum Ratings, (Design-Maximum Values):**

	36AM3-A	36AM3-B	
PEAK INVERSE PLATE VOLTAGE.....	365 max	365 max	volts
PEAK PLATE CURRENT.....	580 max	530 max	ma
DC OUTPUT CURRENT.....	82 max	82 max	ma
PEAK HEATER-CATHODE VOLTAGE:			
Heater negative with respect to cathode.....	350*max	350*max	volts
Heater positive with respect to cathode.....	200■max	200■max	volts

**Typical Operation with Capacitor Input to Filter:**

AC Plate-Supply Voltage (rms).....	120	117	volts
Filter-Input Capacitor.....	40	40	μf
Total Effective Plate Supply Resistance.....			See text above
DC Output Current.....	75	75	ma
DC Output Voltage.....	118	105	volts

**Characteristics:**

Tube Voltage Drop, For plate current of 150 ma.....	16	20	volts
---	----	----	-------

- The dc component must not exceed 350 volts.
- The dc component must not exceed 100 volts.

**MEDIUM-MU TRIODE**

Glass type used as voltage amplifier or detector in radio receivers. Outline 34 or 35, OUTLINES SECTION. Tube requires five-contact socket. Heater volts (ac/dc), 6.3; amperes, 0.3. Characteristics as class A<sub>1</sub> amplifier: plate volts, 250 max; grid volts, -18; plate ma., 7.5; plate resistance, 8400 ohms; amplification factor, 9.2; transconductance, 1100 μmhos. This is a DISCONTINUED type listed for reference only.

37

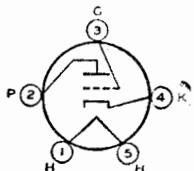

**POWER PENTODE**

Glass type used in output stage of radio receivers. Outline 40, OUTLINES SECTION. Tube requires five-contact socket. Heater volts (ac/dc), 6.3; amperes, 0.3. Characteristics as class A<sub>1</sub> amplifier: plate and grid-No.2 volts, 250 max; grid-No.1 volts, -25; plate ma., 22; grid-No.2 ma., 3.8; plate resistance, 0.1 megohm; transconductance, 1200 μmhos; load resistance, 10000 ohms; output watts, 2.5. This is a DISCONTINUED type listed for reference only.

38

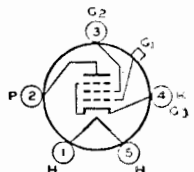

**REMOTE-CUTOFF PENTODE**

Glass type used as rf or if amplifier in radio receivers, particularly those employing avc. Outline 40, OUTLINES SECTION. Tube requires five-contact socket. Heater volts (ac/dc), 6.3; amperes, 0.3. Characteristics as class A<sub>1</sub> amplifier: plate volts, 250 max; grid-No.2 volts, 90 max; grid-No.1 volts, -3 min; plate ma., 5.8; grid-No.2 ma., 1.4; plate resistance, 1.0 meg-

39/44



ohm; transconductance, 1050 μmhos. This is a DISCONTINUED type listed for reference only.

**MEDIUM-MU TRIODE**

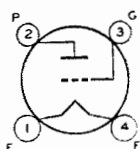

Glass type used as resistance-coupled or impedance-coupled amplifier in battery-operated receivers. Outline 43, OUTLINES SECTION. Filament volts (dc), 5; amperes, 0.25. Characteristics as class A<sub>1</sub> amplifier: plate-supply volts, 180; load resistance, 250000 ohms; grid volts, -3; plate ma., 0.2; plate resistance, 150000 ohms; amplification factor, 30; transconductance, 200  $\mu$ mhos. This is a DISCONTINUED type listed for reference only.

40

**POWER PENTODE**

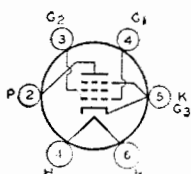

Glass type used in output stage of radio receivers. Outline 34 or 35, OUTLINES SECTION. Tube requires six-contact socket. Heater volts (ac/dc), 6.3; amperes, 0.4. This type is electrically identical with type 6K6-GT. Type 41 is used principally for renewal purposes.

41

**POWER PENTODE**

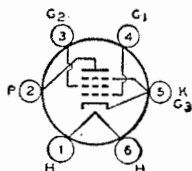

Glass type used in audio output stage of ac receivers. Outline 43, OUTLINES SECTION. Tube requires six-contact socket. Heater volts (ac/dc), 6.3; amperes, 0.7. This type is electrically identical with type 6F6. Type 42 is used principally for renewal purposes.

42

**POWER PENTODE**

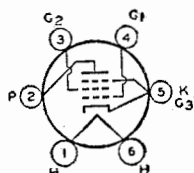

Glass type used in audio output stage of ac/dc receivers. Outline 43, OUTLINES SECTION. Tube requires six-contact socket. Heater volts (ac/dc), 2.5; amperes, 0.3. This type is electrically identical with type 25A6. Type 43 is used principally for renewal purposes.

43

**POWER TRIODE**

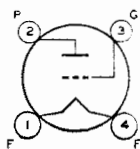

Glass type used in output stage of radio receivers. Outline 43, OUTLINES SECTION. Tube requires four-contact socket. Filament volts (ac/dc), 2.5; amperes, 1.5. Typical operation as class A<sub>1</sub> amplifier: plate supply volts, 275 *max*; grid volts, -56; cathode-bias resistor, 1550 ohms; amplification factor, 3.5; plate resistance, 1700 ohms; transconductance, 2050

45

$\mu$ mhos; plate ma., 36; load resistance, 4600 ohms; undistorted power output, 2 watts. This is a DISCONTINUED type listed for reference only.

**HALF-WAVE VACUUM RECTIFIER**

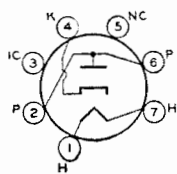

Miniature type used in power supply of small, portable, ac/dc/battery receivers where small size and low heat dissipation are important. Outline 11, OUTLINES SECTION. Tube requires miniature seven-contact socket and may be mounted in any position. Heater volts (ac/dc), 4.5; amperes, 0.075. Maximum ratings: peak inverse plate volts, 350 *max*; peak plate

45Z3

ma., 390 *max*; dc output ma., 65 *max*; peak heater-cathode volts, 175 *max*. Typical operation with capacitor-input filter: ac plate volts (rms), 117; minimum total effective plate-supply impedance, 15 ohms; dc output ma., 65. This is a DISCONTINUED type listed for reference only.

**HALF-WAVE VACUUM RECTIFIER**

**45Z5-GT**

Glass octal type used in power supply of ac/dc receivers. The heater is provided with a tap for operation of a panel lamp. Outline 22, OUTLINES SECTION. Tube requires octal socket. Without panel lamp, heater volts (ac/dc) of entire heater (pins 2 and 7), 45; amperes, 0.15. With panel lamp, heater volts (ac/dc) of panel-lamp section (pins 2 and 3 with 0.15 ampere between pins 2 and 7), 5.5. Except for difference in heater voltage, this type has the

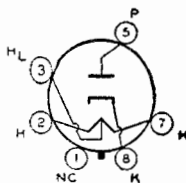

same ratings and typical operation values as glass octal type 35Z5-GT. Type 45Z5-GT is a DISCONTINUED type listed for reference only.

**DUAL-GRID POWER AMPLIFIER**

**46**

Glass type used as class A<sub>1</sub> or class B amplifier in radio equipment. Outline 51, OUTLINES SECTION. Tube requires five-contact socket. Filament volts (ac/dc), 2.5; amperes, 1.75. Typical operation as class A<sub>1</sub> amplifier (grid No.2 connected to plate at socket): plate volts, 250 *max*; grid volts, -33; plate ma., 22; plate resistance, 2380 ohms; am-

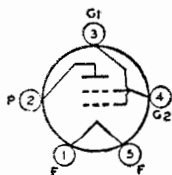

plification factor, 5.6; transconductance, 2350  $\mu$ hos; load resistance for maximum undistorted power output, 6400 ohms; output watts, 1.25. This is a DISCONTINUED type listed for reference only.

**POWER PENTODE**

**47**

Glass type used in audio output stage of radio receivers. Outline 51, OUTLINES SECTION. Tube requires five-contact socket and should preferably be mounted in vertical position. Horizontal operation is permissible if pins 1 and 5 are in vertical plane. Filament volts (ac/dc), 2.5; amperes, 1.75. Typical operation as class A<sub>1</sub> amplifier: plate and grid-No.2 volts,

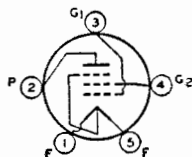

250 *max*; cathode-bias resistor, 450 ohms; plate ma., 31; grid-No.2 ma., 6; plate resistance, 60000 ohms; transconductance, 2500  $\mu$ hos; load resistance, 7000 ohms; power output, 2.7 watts. This type is used principally for renewal purposes.

**POWER TETRODE**

**48**

Glass type used in audio output stage of radio receivers designed to operate from dc power lines. Outline 51, OUTLINES SECTION. Heater volts (dc), 30; amperes, 0.4. Typical operation as class A<sub>1</sub> amplifier: plate volts, 125 *max*; grid-No.2 volts, 100 *max*; grid-No.1 volts, -20; plate ma., 56; grid-No.2 ma., 9.5; transconductance, 3900  $\mu$ hos; load resistance, 1500 ohms; output watts, 2.5. This is a DISCONTINUED type listed for reference only.

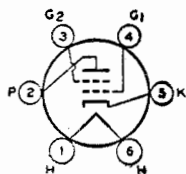

**DUAL-GRID POWER AMPLIFIER**

**49**

Glass type used in output stage of battery-operated receivers. Outline 43, OUTLINES SECTION. Tube requires five-contact socket. Filament volts (dc), 2.0; amperes, 0.12. Typical operation as class A<sub>1</sub> amplifier (grid No.2 connected to plate at socket): plate volts, 135 *max*; grid volts, -20; plate ma., 6; plate resistance, 4175 ohms; amplification factor, 4.7; transcon-

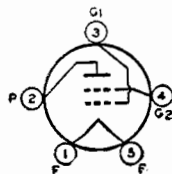

ductance, 1125  $\mu$ hos; load resistance, 11000 ohms; output watts (approx.), 0.17. This is a DISCONTINUED type listed for reference only.

**POWER TRIODE**

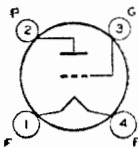

50

Glass type used in output stage of af amplifiers employing transformer input coupling. Maximum over-all length, 6-1/4 inches; maximum diameter, 2-7/16 inches. Tube requires four-contact socket and should be mounted in vertical position with base down. Filament volts (ac/dc), 7.5; amperes, 1.25. Characteristics as class A<sub>1</sub> amplifier: plate volts, 450 max; grid volts, -84; cathode resistor, 1530 ohms; plate

ma., 55; plate resistance, 1800 ohms; amplification factor, 3.8; transconductance, 2100 μmhos; load resistance, 4350 ohms; output watts, 4.6. This is a DISCONTINUED type listed for reference only.

**BEAM POWER TUBE**

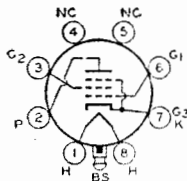

50A5

Glass lock-in type used in output stage of ac/dc receivers. Outline 20, OUTLINES SECTION. Tube requires lock-in socket. Heater volts (ac/dc), 50; amperes, 0.15. For ratings and data, refer to glass-octal type 50L6-GT. Type 50A5 is used principally for renewal purposes.

**BEAM POWER TUBE**

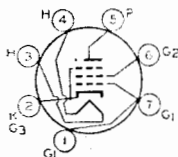

50B5

Miniature type used in output stage of compact ac/dc receivers. Because of its high power sensitivity at plate and screen-grid voltages available in ac/dc receivers, it is capable of

providing a relatively high power output. Outline 13, OUTLINES SECTION. Tube requires miniature seven-contact socket and may be mounted in any position. Except for basing arrangement, type 50B5 is identical with miniature type 50C5.

**BEAM POWER TUBE**

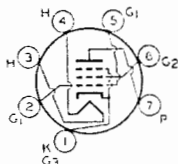

50C5

Miniature type used in output stage of compact, ac/dc radio receivers. Because of its high power sensitivity and high efficiency at plate and screen-grid voltages available in ac/dc receivers, the 50C5 is capable of providing a relatively high power output.

Within its maximum ratings, type 50C5 is equivalent in performance to glass octal type 50L6-GT. The basing arrangement of the 50C5 simplifies the problem of meeting Underwriters' Laboratories requirements in the design of ac/dc receivers.

HEATER VOLTAGE (AC/DC).....	50	volts
HEATER CURRENT.....	0.15	ampere
DIRECT INTERELECTRODE CAPACITANCES (Approx.):		
Grid No.1 to Plate.....	0.6	μf
Grid No.1 to Cathode, Heater, Grid No.2, and Grid No.3.....	13	μf
Plate to Cathode, Heater, Grid No.2, and Grid No.3.....	8.5	μf

**CLASS A<sub>1</sub> AMPLIFIER**

Maximum Ratings, (Design-Maximum Values):

PLATE VOLTAGE.....	150 max	volts
GRID-NO.2 (SCREEN-GRID) VOLTAGE.....	130 max	volts
GRID-NO.1 (CONTROL-GRID) VOLTAGE, Positive bias value.....	0 max	volts
PLATE DISSIPATION.....	7 max	watts
GRID-NO.2 INPUT.....	1.4 max	watts
PEAK HEATER-CATHODE VOLTAGE:		
Heater negative with respect to cathode.....	200 max	volts
Heater positive with respect to cathode.....	200 max	volts
BULB TEMPERATURE (At hottest point).....	220 max	°C

■ The dc component must not exceed 100 volts.

**Typical Operation:**

Plate Voltage.....	120	volts
Grid-No.2 Voltage.....	110	volts
Grid-No.1 (Control-Grid) Voltage.....	-8	volts
Peak AF Grid-No.1 Voltage.....	8	volts
Zero-Signal Plate Current.....	49	ma
Maximum-Signal Plate Current.....	50	ma
Zero-Signal Grid-No.2 Current.....	4	ma
Maximum-Signal Grid-No.2 Current.....	8.5	ma
Plate Resistance (Approx.).....	10000	ohms
Transconductance.....	7500	μmhos
Load Resistance.....	2500	ohms
Total Harmonic Distortion.....	10	per cent
Maximum-Signal Power Output.....	2.3	watts

**Maximum Circuit Values:**

Grid-No.1-Circuit Resistance:		
For fixed-bias operation.....	0.1 max	megohm
For cathode-bias operation.....	0.5 max	megohm

**INSTALLATION AND APPLICATION**

Type 50C5 requires miniature seven-contact socket and may be mounted in any position. Outline 13, OUTLINES SECTION. It is especially important that this tube, like other power-handling tubes, be adequately ventilated.

The 50-volt heater is designed to operate under the normal conditions of line-voltage variation without materially affecting the performance or serviceability of the 50C5. For operation of the 50C5 in series with other types having 0.15-ampere rating, the current in the heater circuit should be adjusted to 0.15 ampere for the normal supply voltage.

In a series-heater circuit of the "dc power line" type employing several 0.15-ampere types and one or two 50C5s, the heater(s) of the 50C5(s) should be placed on the positive side of the line. Under these conditions, heater-cathode voltage of the 50C5 must not exceed the value given under maximum ratings. In a series-heater circuit of the "universal" type employing rectifier tube 35W4, one or two 50C5s, and several 0.15-ampere types, it is recommended that the heater(s) of the 50C5(s) be placed in the circuit so that the higher values of heater-cathode bias will be impressed on the 50C5(s) rather than on the other 0.15-ampere types. This is accomplished by arranging the 50C5(s) on the side of the supply line which is connected to the cathode of the rectifier, i.e., the positive terminal of the rectified voltage supply. Between this side of the line and the 50C5(s), any necessary auxiliary resistance and the heater of the 35W4 are connected in series.

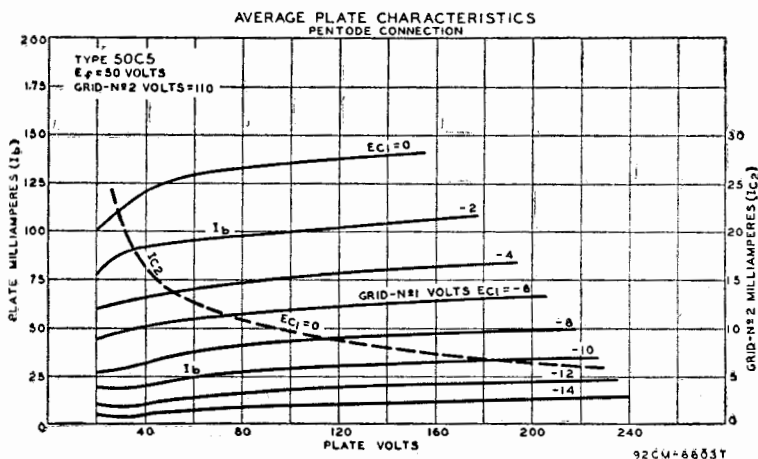



As a power amplifier (class  $A_1$ ), the 50C5 is recommended for use either singly or in push-pull combination in the power-output stage of "ac/dc" receivers. The operating values shown under typical operation have been determined on the basis that grid-No.1 current does not flow during any part of the input cycle.

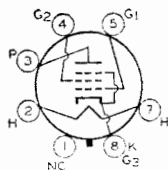

**BEAM POWER TUBE**

Glass octal type used in output stage of ac/dc receivers. Outline 42, OUTLINES SECTION. Heater volts (ac/dc), 50; amperes, 0.15. Except for heater rating, this type is identical with glass octal type 6Y6-G. Type 50C6-G is a DISCONTINUED type listed for reference only.

**50C6-G**

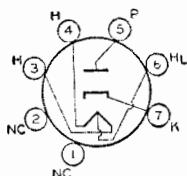

**HALF-WAVE VACUUM RECTIFIER**

Miniature type used in power supply of ac/dc radio receivers. The heater is provided with a tap for operation of a panel lamp. For typical circuit, refer to type 35W4. Outline 13, OUTLINES SECTION.

**50DC4**

SECTION. Tube requires seven-contact socket and may be mounted in any position.

HEATER VOLTAGE (AC/DC):	*	**	volts
ENTIRE HEATER (PINS 3 AND 4) .....	50	45	volts
PANEL-LAMP SECTION (PINS 4 AND 6) .....	7.5	5.5	volts
HEATER CURRENT:			
BETWEEN PINS 3 AND 4 .....	0.15	-	ampere
BETWEEN PINS 3 AND 6 .....	-	0.15	ampere

\* Without panel lamp.

\*\* With No.40 or No.47 panel lamp.

**HALF-WAVE RECTIFIER**

Maximum Ratings, (Design-Maximum Values):

PEAK INVERSE PLATE VOLTAGE .....	330 max	volts
PEAK PLATE CURRENT .....	720 max	ma
DC OUTPUT CURRENT:		
With Panel Lamp and No Shunting Resistor .....	70 max	ma
Without Panel Lamp and Shunting Resistor* .....	110 max	ma
Without Panel Lamp .....	120 max	ma
PANEL-LAMP-SECTION VOLTAGE (rms):		
When Panel Lamp Fails .....	16.5 max	volts
PEAK HEATER-CATHODE VOLTAGE:		
Heater negative with respect to cathode .....	330 max	volts
Heater positive with respect to cathode .....	330 max	volts

**Typical Operation with Panel Lamp:†**

AC Plate-Supply Voltage (rms) .....	117	117	117	117	volts
Filter-Input Capacitor .....	40	40	40	40	$\mu$ f
Minimum Total Effective Plate-Supply Impedance .....	15	15	15	15	ohms
Panel-Lamp Shunting Resistor .....	450	200	100	75	ohms
DC Output Current .....	70	80	90	100	ma

† No.40 or No.47 panel lamp used in circuit with capacitor-input filter given under type 35W4.

**Typical Operation without Panel Lamp:**

AC Plate-Supply Voltage (rms) .....	117	volts
Filter-Input Capacitor .....	40	$\mu$ f
Minimum Total Effective Plate-Supply Impedance .....	15	ohms
DC Output Current .....	110	ma
DC Output Voltage at Input to Filter (Approx.):		
At half-load current (55 ma.) .....	130	volts
At full-load current (110 ma.) .....	110	volts
Voltage Regulation (Approx.):		
Half-load to full-load current .....	20	volts

\* Required when dc output current is greater than 70 milliamperes.

**POWER PENTODE**

**50EH5**

Miniature type used in the audio output stage of radio and television receivers and in phonographs. Outline 13, OUTLINES SECTION. Heater volts (ac/dc), 50; amperes, 0.15. Except for heater rating, this type is identical with miniature type 6EH5.

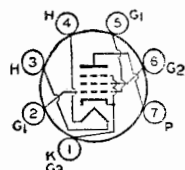

**BEAM POWER TUBE**

**50FE5**

Glass octal type used in audio-output stages of compact stereophonic and monophonic phonographs and radio and television receivers. Outline 29, OUTLINES SECTION. Tube requires octal socket and may be mounted

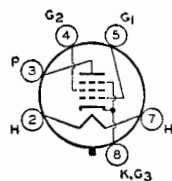

in any position. Heater volts (ac/dc), 50; amperes, 0.15. Peak heater-cathode volts, heater negative with respect to cathode, 200 *max*. Except for heater ratings and heater-cathode voltage, this type is identical with glass octal type 6FE5.

**POWER PENTODE**

**50FK5**

Miniature type used as audio output amplifier in ac/dc radio receivers. Outline 13, OUTLINES SECTION. Tube requires seven-contact socket and may be operated in any position.

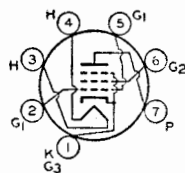

HEATER VOLTAGE (AC/DC).....	50	volts
HEATER CURRENT.....	0.1	ampere
DIRECT INTERELECTRODE CAPACITANCES: <sup>o</sup>		
Grid No.1 to Plate.....	0.65	$\mu$ f
Grid No.1 to Cathode, Heater, Grid No.2, and Grid No.3.....	17	$\mu$ f
Plate to Cathode, Heater, Grid No.2, and Grid No.3.....	9	$\mu$ f

**CLASS A<sub>1</sub> AMPLIFIER**

<b>Maximum Ratings, (Design-Maximum Values):</b>		
PLATE VOLTAGE.....	150 <i>max</i>	volts
GRID-NO.2 (SCREEN-GRID) VOLTAGE.....	130 <i>max</i>	volts
GRID-NO.1 (CONTROL-GRID) VOLTAGE, Positive-bias value.....	0 <i>max</i>	volts
PLATE DISSIPATION.....	5 <i>max</i>	watts
GRID-NO.2 INPUT.....	1.75 <i>max</i>	watts
<b>PEAK HEATER-CATHODE VOLTAGE:</b>		
Heater negative with respect to cathode.....	200 <i>max</i>	volts
Heater positive with respect to cathode.....	200 <i>max</i>	volts
BULB TEMPERATURE (At hottest point).....	225 <i>max</i>	$^{\circ}$ C

**Typical Operation and Characteristics:**

Plate Supply Voltage.....	110	volts
Grid-No.2 Supply Voltage.....	115	volts
Cathode-Bias Resistor.....	62	ohms
Peak A <sub>1</sub> Grid-No.1 Voltage.....	3	volts
Zero-Signal Plate Current.....	32	ma
Maximum-Signal Plate Current.....	32	ma
Zero-Signal Grid-No.2 Current.....	8.5	ma
Maximum-Signal Grid-No.2 Current.....	12	ma
Plate Resistance (Approx.).....	14000	ohms
Transconductance.....	12800	$\mu$ mhos
Load Resistance.....	3000	ohms
Total Harmonic Distortion.....	8	per cent
Maximum-Signal Power Output.....	1.2	watts

**Maximum Circuit Values:**

Grid-No.1-Circuit Resistance:		
For fixed-bias operation.....	0.1	megohm
For cathode-bias operation.....	0.5	megohm

<sup>o</sup> Without external shield.

▪ The dc component must not exceed 100 volts.

AVERAGE PLATE CHARACTERISTICS

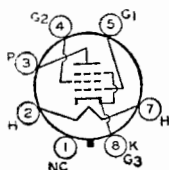
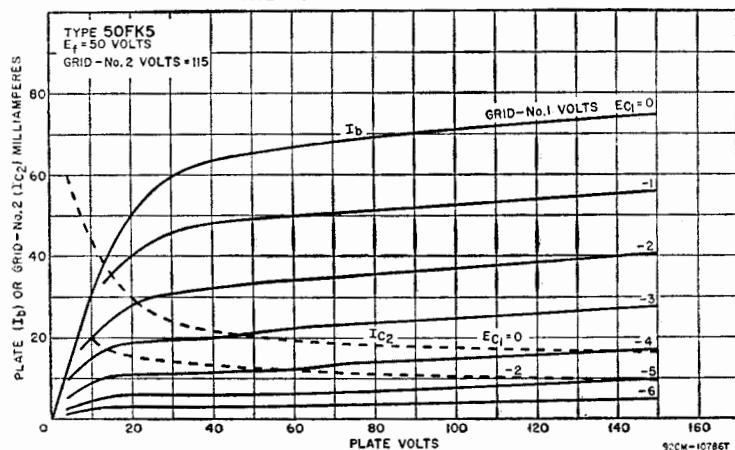

BEAM POWER TUBE

Glass octal type used in output stage of ac/dc radio receivers. Outline 22, OUTLINES SECTION. Tube requires octal socket and may be mounted in any position. This type may be supplied with pin No.1 omitted.

50L6-GT

Refer to miniature type 50C5 for installation and application information.

HEATER VOLTAGE (AC/DC) .....	50	vols
HEATER CURRENT .....	0.15	ampere
DIRECT INTERELECTRODE CAPACITANCES (Approx.):		
Grid No.1 to Plate .....	0.6	$\mu$ f
Grid No.1 to Cathode, Heater, Grid No.2, and Grid No.3 .....	15	$\mu$ f
Plate to Cathode, Heater, Grid No.2, and Grid No.3 .....	9.5	$\mu$ f

CLASS A<sub>1</sub> AMPLIFIER

Maximum Ratings:

PLATE VOLTAGE .....	200 <i>max</i>	vols
Grid-No.2 (SCREEN-GRID) VOLTAGE .....	125 <i>max</i>	vols
PLATE DISSIPATION .....	10 <i>max</i>	watts
GRID-NO.2 INPUT .....	1.25 <i>max</i>	watts
PEAK HEATER-CATHODE VOLTAGE:		
Heater negative with respect to cathode .....	90 <i>max</i>	vols
Heater positive with respect to cathode .....	90 <i>max</i>	vols

Typical Operation:

	Fixed Bias	Cathode Bias	
Plate Supply Voltage .....	110	200	vols
Grid-No.2 Supply Voltage .....	110	125	vols
Grid-No.1 (Control-Grid) Voltage .....	-7.5	-	vols
Peak AF Grid-No.1 Voltage .....	7.5	8.0	vols
Cathode-Bias Resistor .....	-	180	ohms
Zero-Signal Plate Current .....	49	46	ma
Maximum-Signal Plate Current .....	50	47	ma
Zero-Signal Grid-No.2 Current .....	4	2.2	ma
Maximum-Signal Grid-No.2 Current .....	10	8.5	ma
Plate Resistance (Approx.) .....	13000	28000	ohms
Transconductance .....	8000	8000	ohms
Load Resistance .....	2000	4000	ohms
Total Harmonic Distortion .....	10	10	per cent
Maximum-Signal Power Output .....	2.1	3.8	watts

**VACUUM RECTIFIER-DOUBLER**

**50X6**

Lock-in type used as half-wave rectifier or voltage doubler in ac/dc receivers. Outline 20, OUTLINES SECTION. Tube requires lock-in socket. Heater volts (ac/dc), 50; amperes, 0.15. This type is electrically identical with glass octal type 50Y6-GT and, except for heater rating, with glass octal type 25Z6-GT. Refer to type 25Z6-GT for maximum ratings, typical operation, and curves. Type 50X6 is used principally for renewal purposes.

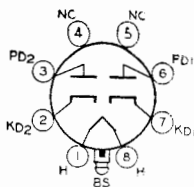

**VACUUM RECTIFIER-DOUBLER**

**50Y6-GT**

Glass octal type used as half-wave rectifier or voltage doubler in ac/dc receivers. This type is used particularly in "transformerless" receivers of either the ac/dc type or the voltage-doubler type. Outline 22, OUTLINES SECTION. This type may be supplied with pin No.1 omitted. Tube requires octal socket. Heater volts (ac/dc), 50; amperes, 0.15. Except for heater rating, this type is electrically identical with type 25Z6-GT.

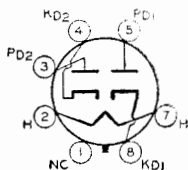

SECTION. This type may be supplied with pin No.1 omitted. Tube requires octal socket. Heater volts (ac/dc), 50; amperes, 0.15. Except for heater rating, this type is electrically identical with type 25Z6-GT.

**VACUUM RECTIFIER-DOUBLER**

**50Y7-GT**

Glass octal type used as half-wave rectifier or voltage doubler in ac/dc receivers. This type is used particularly in "transformerless" receivers of either the ac/dc type or the voltage-doubler type. The heater is provided with a tap for operation of a panel lamp. Outline 22, OUTLINES SECTION. Tube requires octal socket. Without panel lamp, heater volts (ac/dc) of

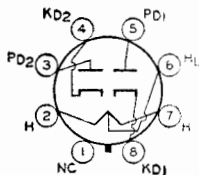

entire heater (pins 2 and 7), 50; amperes, 0.15. With panel lamp, heater volts (ac/dc) of panel-lamp section (pins 6 and 7 with 0.15 ampere between pins 2 and 7), 5.5. For maximum ratings and typical operation as half-wave rectifier or voltage doubler without panel lamp, refer to glass octal type 25Z6-GT. When operated with a panel lamp and 250-ohm panel-lamp shunting resistor, ratings and typical operation are the same as for type 25Z6-GT, except that dc output current per plate is 65 ma. Type 50Y7-GT is used principally for renewal purposes.

**VACUUM RECTIFIER-DOUBLER**

**50Z7-G**

Glass octal type used as half-wave rectifier or voltage doubler in ac/dc receivers. Outline 36, OUTLINES SECTION. The heater is provided with a tap for operation of a panel lamp. Without panel lamp, heater volts (ac/dc) of entire heater (pins 2 and 7), 50; amperes, 0.15. With panel lamp, heater volts (ac/dc) of panel-lamp section (pins 6 and 7 with 0.15 ampere

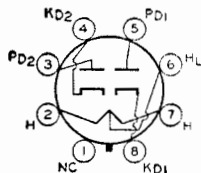

between pins 2 and 7), 2. Maximum ratings as rectifier or doubler: peak inverse plate volts, 700 max; peak plate ma. per plate, 400 max; dc output ma. per plate with panel lamp, 65 max; peak heater-cathode volts, 350 max; panel lamp section volts (pins 6 and 7), 2.5 max. This is a DISCONTINUED type listed for reference only.

**HIGH-MU TWIN POWER TRIODE**

**53**

Glass type used in output stage of ac-operated receivers as a class B power amplifier. Outline 43, OUTLINES SECTION. Tube requires medium seven-contact (0.855-inch pin-circle diameter) socket. Heater volts (ac/dc), 2.5; amperes, 2.0. Except for heater rating, this type is electrically identical with metal type 6N7. Type 53 is a DISCONTINUED type listed for reference only.

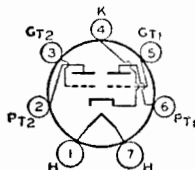

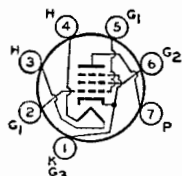

### POWER PENTODE

Miniature type used in output stages of audio amplifiers, especially in two-tube series-string stereo systems. This type has extremely high power-sensitivity and can be driven to

# 60FX5

full output by a ceramic or crystal phonograph pickup. Outline 13, OUTLINES SECTION. Tube requires seven-contact socket and may be mounted in any position.

HEATER VOLTAGE (AC/DC) .....	60±6	volts
HEATER CURRENT .....	0.1	ampere
DIRECT INTERELECTRODE CAPACITANCES (Approx.):		
Grid No.1 to Plate .....	0.65	µuf
Grid No.1 to Cathode, Heater, Grid No.2, and Grid No.3 .....	17	µuf
Plate to Cathode, Heater, Grid No.2, and Grid No.3 .....	9	µuf

#### CLASS A<sub>1</sub> AMPLIFIER

Maximum Ratings, (Design-Maximum Values):		
PLATE VOLTAGE .....	150 max	volts
GRID-NO.2 (SCREEN-GRID) VOLTAGE .....	130 max	volts
PLATE DISSIPATION .....	5.5 max	watts
GRID-NO.2 INPUT .....	2 max	watts
PEAK HEATER-CATHODE VOLTAGE:		
Heater negative with respect to cathode .....	200 max	volts
Heater positive with respect to cathode .....	200*max	volts
BULB TEMPERATURE (At hottest point) .....	225 max	°C

#### Typical Operation:

Plate Supply Voltage .....	110	volts
Grid-No.2 Supply Voltage .....	115	volts
Cathode-Bias Resistor .....	62	ohms
Peak AF Grid-No.1 Voltage .....	3	volts
Zero-Signal Plate Current .....	36	ma
Maximum-Signal Plate Current .....	35	ma
Zero-Signal Grid No.2 Current .....	10	ma
Maximum-Signal Grid No.2 Current .....	12	ma
Plate Resistance .....	17500	ohms
Transconductance .....	13500	µmhos
Load Resistance .....	3000	ohms
Total Harmonic Distortion .....	8	per cent
Maximum-Signal Power Output .....	1.3	watts

#### Maximum Circuit Values:

Grid-No.1-Circuit Resistance:		
For fixed-bias operation .....	0.1 max	megohm
For cathode-bias operation .....	0.5 max	megohm

#### AVERAGE CHARACTERISTICS

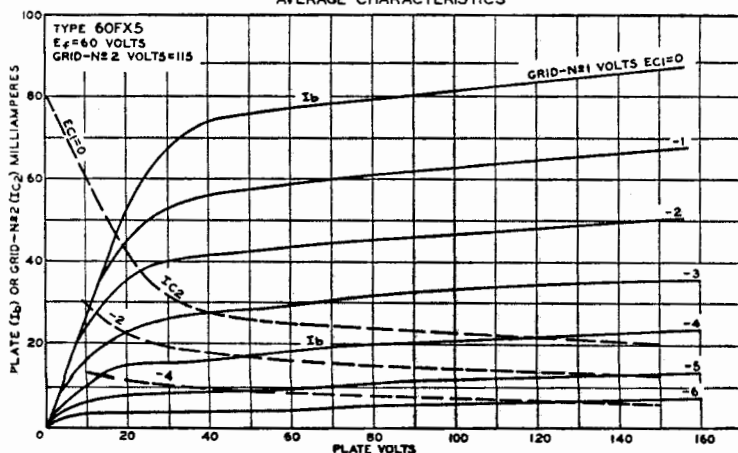

92CM-10546T

## 70L7-GT

### RECTIFIER—BEAM POWER TUBE

Glass octal type used as combined half-wave rectifier and output amplifier in ac/dc receivers. Outline 26, OUTLINES SECTION. Tube requires octal socket. Heater volts (ac/dc), 70; amperes, 0.15. Maximum ratings of rectifier unit: peak inverse plate volts, 350; peak plate ma., 420; dc output ma., 70; peak heater-cathode volts, 175; minimum total effective

plate-supply impedance, 15 ohms. Typical operation and maximum ratings of beam power unit as class A<sub>1</sub> amplifier: plate and grid-No.2 volts, 110 (117 *max*); grid-No.1 volts, -7.5; plate ma., 40; grid-No.2 ma., 3; plate resistance, 15000 ohms; transconductance, 7500  $\mu$ mhos; load resistance, 2000 ohms; output watts, 1.8; plate dissipation, 5 *max* watts; grid-No.2 input, 1 *max* watt. This type is used principally for renewal purposes.

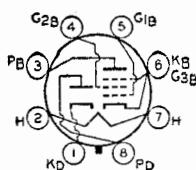

## 75

### TWIN DIODE—HIGH-MU TRIODE

Glass type used as combined detector, amplifier, and avc tube in radio receivers. Outline 40, OUTLINES SECTION. Tube requires six-contact socket. Heater volts (ac/dc), 6.3; amperes, 0.3. Except for interelectrode capacitances and plate volts of 250 *max*, this type is identical electrically with metal type 6SQ7. Type 75 is used principally for renewal purposes.

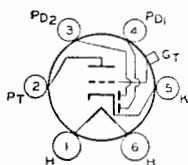

## 78

### REMOTE-CUTOFF PENTODE

Glass type used in rf and if stages of radio receivers, particularly those employing avc. Outline 40, OUTLINES SECTION. Tube requires six-contact socket. Heater volts (ac/dc), 6.3; amperes, 0.3. Except for capacitances, this type is identical electrically with metal type 6K7. Type 78 is used principally for renewal purposes.

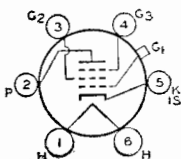

## 80

### FULL-WAVE VACUUM RECTIFIER

Glass type used in power supply of radio equipment having moderate direct-current requirements. Outline 43 and 34, OUTLINES SECTION, except maximum over-all length 4 inches; maximum seated length, 3-3/8 inches. Tube requires four-contact socket and should be mounted preferably in a vertical position. Horizontal mounting is permissible if pins 1 and 4 are in a horizontal plane. Filament volts (ac),

5.0; amperes, 2.0. For filament operation, refer to type 5U4-G. Type 80 is electrically identical with glass octal type 5Y3-GT. Type 80 is used principally for renewal purposes.

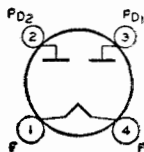

## 84/6Z4

### FULL-WAVE VACUUM RECTIFIER

Glass type used in power supply of automobile and ac-operated radio receivers. Outline 34 or 35, OUTLINES SECTION. Tube requires five-contact socket. Heater volts (ac/dc), 6.3; amperes, 0.5. Maximum ratings: peak inverse plate volts, 1250 *max*; peak plate ma., 180 *max*; dc output ma., 60 *max*; peak heater-cathode volts, 450 *max*. Typical operation with capaci-

tor-input filter: ac plate-to-plate supply volts (rms), 650; minimum total effective plate-supply impedance per plate, 150 ohms; dc output ma., 60. Typical operation with choke-input filter: ac plate-to-plate supply volts (rms), 900; minimum filter-input choke, 10 henries; dc output ma., 60. This type is used principally for renewal purposes.

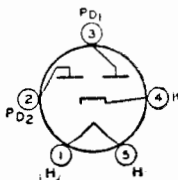

**RECTIFIER—BEAM POWER TUBE**

**117L7/  
M7-GT**

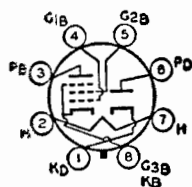

Glass octal type used as combined half-wave rectifier and output amplifier in ac/dc receivers. Outline 26, OUTLINES SECTION. Tube requires octal socket. Heater volts (ac/dc), 117; amperes, 0.09. For ratings and operation of rectifier unit, refer to type 117N7-GT. Typical operation of beam power unit as class A<sub>1</sub> amplifier: plate and grid-No.2 volts, 105 (117 max); grid-No.1 volts, -5.2; peak at grid-No.1 volts, 5.2; plate ma., 43; grid-No.2 ma., 4 (zero-signal); 5.5 (maximum-signal); plate input, 6 max watts; grid-No.2 dissipation, 1 max watt; plate resistance (approx.), 17000 ohms; transconductance, 5300 μmhos; load resistance, 4000 ohms; total harmonic distortion, 5 per cent; maximum-signal power output, 0.85 watt. Type 117L7/M7-GT is used principally for renewal purposes.

**RECTIFIER—BEAM POWER TUBE**

**117N7-GT**

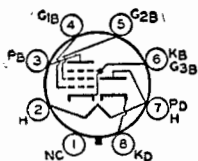

Glass octal type used as combined half-wave rectifier and output amplifier in ac/dc receivers. Outline 26, OUTLINES SECTION. Tube requires octal socket and may be mounted in any position. Heater volts (ac/dc), 117; amperes, 0.09. Maximum ratings of rectifier unit as half-wave rectifier: peak inverse plate volts, 350 max; peak plate ma., 450 max; dc output ma., 75 max; peak heater-cathode volts (heater negative with respect to cathode), 175 max. Typical operation with capacitor-input filter: ac plate supply volts (rms), 177; minimum total effective plate-supply impedance, 15 ohms; dc output ma., 75; dc output volts at input to filter, 122. Typical operation of beam power unit as class A<sub>1</sub> amplifier: plate and grid-No.2 volts, 100 (117 max); grid-No.1 volts, -6; peak at grid-No.1 volts, 6; plate ma., 51; grid-No.2 ma., 5; plate dissipation, 5.5 max watts; grid-No.2 input, 1 max watt; plate resistance (approx.), 16000 ohms; transconductance, 7000 μmhos; load resistance, 3000 ohms; total harmonic distortion, 6 per cent; maximum-signal power output, 1.2 watts. This type is used principally for renewal purposes.

**RECTIFIER—BEAM POWER TUBE**

**117P7-GT**

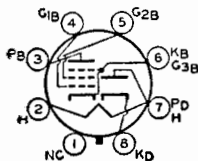

Glass octal type used as combined half-wave rectifier and output tube. Outline 26, OUTLINES SECTION. Tube requires octal socket. Heater volts (ac/dc), 117; amperes, 0.09. This type is electrically identical with glass-octal type 117L7/M7-GT. Type 117P7-GT is used principally for renewal purposes.

**HALF-WAVE VACUUM RECTIFIER**

**117Z3**

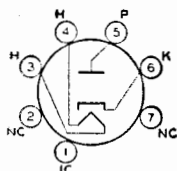

Miniature type used in power supply of ac/dc/battery radio receivers. The heater is designed for operation directly across a 117-volt ac or dc supply line. Outline 13, OUTLINES SECTION.

Tube requires miniature seven-contact socket and may be mounted in any position. It is especially important that this tube, like other power-handling tubes, be adequately ventilated.

HEATER VOLTAGE (AC/DC) .....	117	volts
HEATER CURRENT .....	0.04	ampere
<b>Maximum Ratings:</b>		
PEAK INVERSE PLATE VOLTAGE .....	330 max	volts
PEAK PLATE CURRENT .....	540 max	ma
DC OUTPUT CURRENT .....	90 max	ma
<b>PEAK HEATER-CATHODE VOLTAGE:</b>		
Heater negative with respect to cathode .....	175 max	volts
Heater positive with respect to cathode .....	100 ma	volts
<b>Typical Operation, (Capacitor-Input to Filter):</b>		
AC Plate-Supply Voltage (rms) .....	117	volts
Filter-Input Capacitor .....	30	μf
Minimum Total Effective Plate-Supply Impedance† .....	20	ohms
DC Output Current .....	90	ma
<b>DC Output Voltage at Input to Filter (Approx):</b>		
At half-load current (45 ma.) .....	130	volts
At full-load current (90 ma.) .....	110	volts

**Voltage Regulation (Approx.):**

Half-load to full-load current. . . . . 20 volts

† When a filter-input capacitor larger than 40  $\mu$ f is used, it may be necessary to use more plate-supply impedance than the minimum value shown to limit the peak plate current to the rated value.

**HALF-WAVE VACUUM RECTIFIER**

**117Z4-GT**

Glass octal type used in power supply of ac/dc/battery radio receivers. Maximum overall length, 3 inches; maximum diameter, 1-5/16 inches. Tube requires octal socket. Heater volts (ac/dc), 117; amperes, 0.04. Maximum ratings as half-wave rectifier: peak inverse plate volts, 350 *max*; peak plate ma., 540 *max*; peak heater-cathode volts, 175 *max*. Typical operation with capacitor-input filter: ac plate supply volts

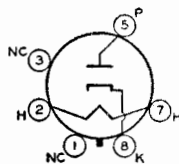

(rms), 117; minimum total effective plate-supply impedance, 30 ohms; dc output ma., 90. This is a DISCONTINUED type listed for reference only.

**VACUUM RECTIFIER-DOUBLER**

**117Z6-GT**

Glass octal type used as half-wave rectifier or voltage doubler in ac/dc receivers. Outline 22, OUTLINES SECTION. Tube requires octal socket and may be mounted in any position. This type may be supplied with pin No.1 omitted. Heater volts (ac/dc), 117; amperes, 0.075. Maximum ratings: peak inverse plate volts, 700 *max*; peak plate ma. per plate, 360 *max*; dc output ma. per plate, 60 *max*; peak heater-

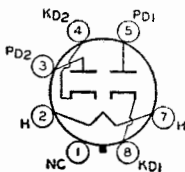

cathode volts, 350 *max*. Typical operation as half-wave rectifier with capacitor-input filter or as half-wave or full-wave voltage doubler: ac plate supply volts per plate (rms), 117; filter-input capacitor, 50  $\mu$ f; minimum total effective plate-supply impedance per plate, 15 (30 for half-wave doubler service); dc output ma. per plate, 60. This type is used principally for renewal purposes.

**SHARP-CUTOFF PENTODE**

**5879**

Miniature type used as audio amplifier in applications requiring reduced microphonics, leakage noise, and hum. Especially useful in the input stages of medium-gain public-address

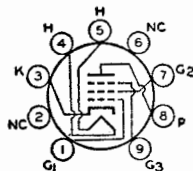

systems, home sound recorders, and general-purpose audio systems. Outline 12, OUTLINES SECTION. Tube requires miniature nine-contact socket and may be mounted in any position. For operation as resistance-coupled amplifier, refer to RESISTANCE-COUPLED AMPLIFIER SECTION.

HEATER VOLTAGE (AC/DC) . . . . .	6.3	volts
HEATER CURRENT . . . . .	0.15	ampere
DIRECT INTERELECTRODE CAPACITANCES:		
Pentode Connection:		
Grid No.1 to Plate . . . . .	0.11 <i>max</i>	$\mu$ f
Grid No.1 to Cathode, Heater, Grid No.2, and Grid No.3 . . . . .	2.7	$\mu$ f
Plate to Cathode, Heater, Grid No.2, and Grid No.3 . . . . .	2.4	$\mu$ f
Triode Connection*:		
Grid No.1 to Plate . . . . .	1.4	$\mu$ f
Grid No.1 to Cathode and Heater . . . . .	1.4	$\mu$ f
Plate to Cathode and Heater . . . . .	0.85	$\mu$ f

\* Grid No.2 and grid No.3 connected to plate.

**CLASS A<sub>1</sub> AMPLIFIER**

**Maximum Ratings, (Design-Maximum Values):**

	Triode Connection*	Pentode Connection	
PLATE VOLTAGE . . . . .	275 <i>max</i>	330 <i>max</i>	volts
GRID NO.3 (SUPPRESSOR GRID) . . . . .	-	Connect to cathode at socket	
GRID-NO.2 (SCREEN-GRID) VOLTAGE . . . . .	-	See curve page 66	
GRID-NO.2 SUPPLY VOLTAGE . . . . .	-	330 <i>max</i>	volts
GRID-NO.1 (CONTROL-GRID) VOLTAGE:			
Negative bias value . . . . .	-55 <i>max</i>	-55 <i>max</i>	volts
Positive bias value . . . . .	0 <i>max</i>	0 <i>max</i>	volts
PLATE DISSIPATION . . . . .	1.7 <i>max</i>	1.25 <i>max</i>	watts
GRID-NO.2 INPUT:			
For grid-No.2 voltages up to 165 volts . . . . .	-	0.25 <i>max</i>	watt
For grid-No.2 voltages between 165 and 330 volts . . . . .	-	See curve page 66	



# Technical Data

**PEAK HEATER-CATHODE VOLTAGE:**

Heater negative with respect to cathode.....	100 max	100 max	volts
Heater positive with respect to cathode.....	100 max	100 max	volts

**Characteristics:**

	Triode Connection*		Pentode Connection		
Plate Voltage.....	.100	250	250		volts
Grid No.3.....	-	-	Connected to cathode at socket		volts
Grid-No.2 Voltage.....	-	-	100		volts
Grid-No.1 Voltage.....	-3	-8	-3		volts
Amplification Factor.....	21	21	-		
Plate Resistance (Approx.).....	0.017	0.0137	2		megohms
Transconductance.....	1240	1530	1000		$\mu$ mhos
Grid-No.1 Voltage (Approx.) for plate current of 10 $\mu$ a	-	-	-8		volts
Plate Current.....	2.2	5.5	1.8		ma
Grid-No.2 Current.....	-	-	0.4		ma

**Maximum Circuit Value:**

Grid-No.1-Circuit Resistance.....	2.2 max	megohms
-----------------------------------	---------	---------

\* Grid No.2 and grid No.3 connected to plate.

**AVERAGE CHARACTERISTICS**  
PENTODE CONNECTION

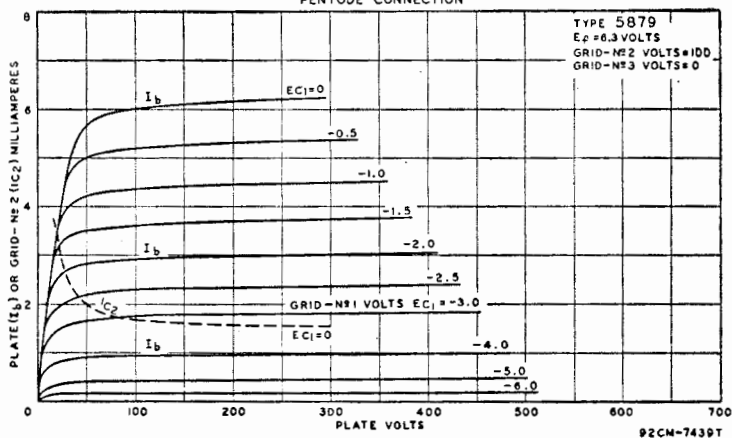

**AVERAGE CHARACTERISTICS**  
TRIODE CONNECTION

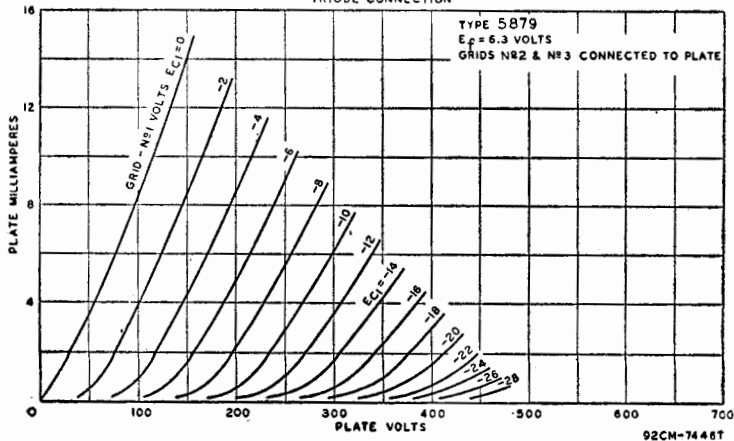

**5881**

**BEAM POWER TUBE**

Glass octal type used in the output stages of radio receivers and audio amplifiers, particularly in the push-pull stages of high-fidelity audio amplifiers. Outline 27, OUTLINES SECTION.

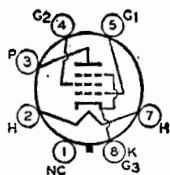

Tube requires octal socket and may be mounted in any position. For typical operation as push-pull class A<sub>1</sub>, class AB<sub>1</sub> (within maximum ratings), and class AB<sub>2</sub> amplifier, and for curves of average plate characteristics, refer to type 6L6-GC.

HEATER VOLTAGE (AC/DC).....	6.3	volts
HEATER CURRENT.....	0.9	ampere

**CLASS A<sub>1</sub> AMPLIFIER**

**Maximum Ratings:**

	<i>Triode Connection*</i>	<i>Pentode Connection</i>	
PLATE VOLTAGE.....	400 max	400 max	volts
GRID-NO.2 (SCREEN-GRID) VOLTAGE.....	-	400 max	volts
PLATE DISSIPATION.....	26 max	23 max	watts
GRID-NO.2 INPUT.....	-	3 max	watts
<b>PEAK HEATER-CATHODE VOLTAGE:</b>			
Heater negative with respect to cathode.....	200 max	200 max	volts
Heater positive with respect to cathode.....	200 max	200 max	volts

**Typical Operation and Characteristics:**

	<i>Triode Connection*</i>		<i>Pentode Connection</i>		
Plate Voltage.....	250	300	250	350	volts
Grid-No.2 Voltage.....	-	-	250	250	volts
Grid-No.1 (Control-Grid) Voltage.....	-18	-20	-14	-18	volts
Peak AF Grid-No.1 Voltage.....	18	20	14	18	volts
Zero-Signal Plate Current.....	52	78	75	53	ma
Maximum-Signal Plate Current.....	58	85	80	65	ma
Zero-Signal Grid-No.2 Current.....	-	-	4.3	2.5	ma
Maximum-Signal Grid-No.2 Current.....	-	-	7.6	8.5	ma
Amplification Factor.....	8	-	-	-	
Plate Resistance (Approx.).....	-	-	30000	48000	ohms
Transconductance.....	5250	-	6100	5200	μmhos
Load Resistance.....	4000	4000	2500	4200	ohms
Total Harmonic Distortion.....	6	5.5	10	13	per cent
Maximum-Signal Power Output.....	1.4	1.8	6.7	11.3	watts

**Maximum Circuit Values:**

Grid-No.1-Circuit Resistance:	
For fixed-bias operation.....	0.1 max megohm
For cathode-bias operation.....	0.5 max megohm

\* Grid No.2 connected to plate.

**BEAM POWER TUBE**

**6973**

Miniature type used as power amplifier in compact high-fidelity audio equipment. Tube features linear operation over a wide range of power, high power sensitivity, high stability, and

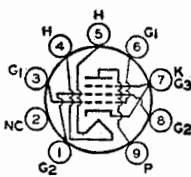

low heater power, and is capable of delivering high power output at low distortion. Double base-pin connections for both grid No.1 and grid No.2 provide cool operation of grids and thus minimize grid emission and permit use of high values of grid-circuit resistance to reduce driving power. Outline 18, OUTLINES SECTION. Tube requires miniature nine-contact socket and may be mounted in any position.

HEATER VOLTAGE (AC/DC).....	6.3	volts
HEATER CURRENT.....	0.45	ampere
<b>DIRECT INTERELECTRODE CAPACITANCES:</b>		
Grid No.1 to Plate.....	0.4 max	μuf
Grid No.1 to Cathode, Heater, Grid No.2, and Grid No.3.....	9	μuf
Plate to Cathode, Heater, Grid No.2, and Grid No.3.....	6	μuf

# Technical Data

## Characteristics:

### CLASS A<sub>1</sub> AMPLIFIER

Plate Voltage.....	250	volts
Grid-No.2 (Screen-Grid) Voltage.....	250	volts
Grid-No.1 (Control-Grid) Voltage.....	-15	volts
Plate Resistance (Approx.).....	73000	ohms
Transconductance.....	4800	μmhos
Plate Current.....	46	ma
Grid-No.2 Current.....	3.5	ma
Grid-No.1 Voltage (Approx.) for plate current of 100 μa.....	-40	volts

### PUSH-PULL CLASS AB<sub>1</sub> AMPLIFIER

#### Maximum Ratings, (Design-Maximum Values):

PLATE VOLTAGE.....	440 max	volts
GRID-NO.2 VOLTAGE.....	330 max	volts
PLATE DISSIPATION.....	12 max	watts
GRID-NO.2 INPUT.....	2 max	watts
PEAK HEATER-CATHODE VOLTAGE:		
Heater negative with respect to cathode.....	200 max	volts
Heater positive with respect to cathode.....	200 max	volts
BULB TEMPERATURE (At hottest point).....	250 max	°C

#### Typical Operation, (Values are for two tubes):

	Fixed Bias			Cathode Bias		
Plate Supply Voltage.....	250	350	400	300	310	volts
Grid-No.2 Supply Voltage.....	250	280	290	300	310	volts
Grid-No.1 Voltage.....	-15	-22	-25	-	-	volts
Cathode-Bias Resistor.....	-	-	-	230	270	ohms
Peak AF Grid-No.1-to-Grid-No.1 Voltage.....	30	44	50	48	55	volts
Zero-Signal Plate Current.....	92	58	50	80	77	ma
Maximum-Signal Plate Current.....	105	106	107	96	92	ma
Zero-Signal Grid-No.2 Current.....	7	3.5	2.5	6	5	ma
Maximum-Signal Grid-No.2 Current.....	16	14	13.7	14	14	ma
Effective Load Resistance (Plate-to-plate).....	8000	7500	8000	5500	6000	ohms
Total Harmonic Distortion.....	2	1.5	2	2	4	per cent
Maximum-Signal Power Output.....	12.5	20	24	15	17	watts

### AVERAGE CHARACTERISTICS

WITH EC<sub>2</sub> AS VARIABLE

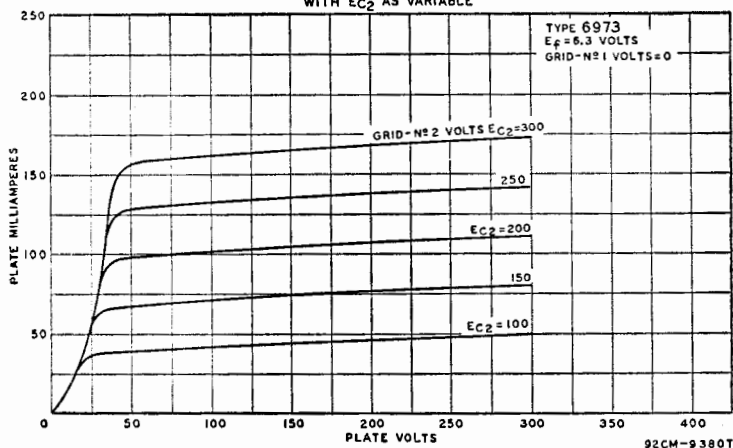

#### Maximum Circuit Values:

Grid-No.1-Circuit Resistance:		
For fixed-bias operation.....	0.5 max	megohm
For cathode-bias operation.....	1 max	megohm

■ The dc component must not exceed 100 volts.

### PUSH-PULL CLASS AB<sub>1</sub> AMPLIFIER

*Grid No.2 of Each Tube Connected to Tap on Plate Winding of Output Transformer*

#### Maximum Ratings, (Design-Maximum Values):

PLATE AND GRID-NO.2 SUPPLY VOLTAGE.....	410 max	volts
PLATE DISSIPATION.....	12 max	watts
GRID-NO.2 INPUT.....	1.75 max	watts
PEAK HEATER-CATHODE VOLTAGE:		
Heater negative with respect to cathode.....	200 max	volts
Heater positive with respect to cathode.....	200 max	volts
BULB TEMPERATURE (At hottest point).....	250 max	°C

### Typical Operation, (Values are for two tubes):

	Fixed Bias	Cathode Bias	
Plate Supply Voltage	375	370	volts
Grid-No.2 Supply Voltage	*	‡	volts
Grid-No.1 Voltage	-33.5	-	volts
Cathode-Bias Resistor	-	355	ohms
Peak AF Grid-No.1-to-Grid-No.1 Voltage	67	62	volts
Zero-Signal Cathode Current	62	74	ma
Maximum-Signal Cathode Current	95	84	ma
Effective Load Resistance (Plate-to-plate)	12500	13000	ohms
Total Harmonic Distortion	1.5	1.2	per cent
Maximum-Signal Power Output	18.5	15	watts

### Maximum Circuit Values:•

#### Grid-No.1-Circuit Resistance:

For fixed-bias operation	0.5 max	megohm
For cathode-bias operation	1 max	megohm

• The dc component must not exceed 100 volts.

\* Obtained from taps on the primary winding of the output transformer. The taps are located on each side of the center tap (B+) so as to apply 50 per cent of the plate signal voltage to grid No.2 of each output tube.

‡ Obtained from taps on the primary winding of the putput transformer. The taps are located on each side of the center tap (B+) so as to supply 43 per cent of the plate signal voltage to grid No.2 of each output tube.

• The type of input-coupling network used should not introduce too much resistance in the grid-No.1 circuit. Transformer- or impedance-coupling devices are recommended.

AVERAGE CHARACTERISTICS  
WITH  $E_{C1}$  AS VARIABLE

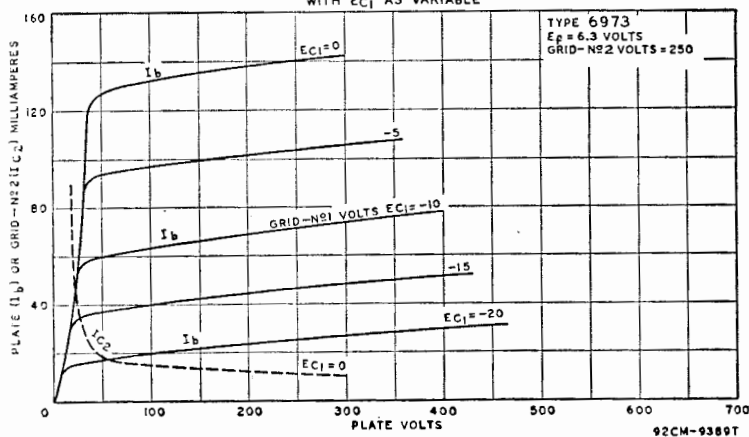

### HIGH-MU TWIN TRIODE

# 7025

Miniature type used as phase inverter or resistance-coupled amplifier in high-quality, high-fidelity audio amplifiers where low noise and hum are primary considerations. Outline

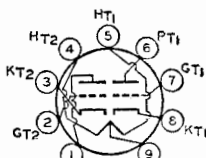

12, OUTLINES SECTION. This type is identical with miniature type 12AX7 except that it has a controlled equivalent noise and hum characteristic. For operation as resistance-coupled amplifier, RESISTANCE-COUPLED AMPLIFIER SECTION.

### Equivalent-Noise and Hum Voltage Referenced to Grid, (Each Unit):

Average Value (rms) †	1.8	μvolts
Maximum Value (rms) •	7	μvolts

† Measured in "true rms" units under following conditions: heater volts (ac), 6.3 (parallel connection); center tap of heater transformer connected to ground; plate supply volts, 250; plate load resistor, 2700 ohms; cathode-bypass capacitor, 100 μf; grid resistor, 0 ohms; and amplifier covering frequency range between 25 to 10000 cycles per second.

• Same conditions as for "Average Value" except: cathode resistor is unbypassed and grid resistor, 0.05 megohm.

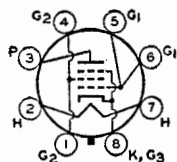

### BEAM POWER TUBE

Glass octal types used in push-pull power amplifier circuits of high-fidelity audio equipment. Tubes provide high powersensitivity and high stability and are capable of delivering high power

**7027**  
**7027-A**

output at low distortion. Double base-pin connections for both grid No.1 and grid No.2 provide for flexibility of circuit arrangement and also cool operation of the grids with the result that reverse grid current is minimized. Outline 41, OUTLINES SECTION. Tubes require octal socket and may be mounted in any position. It is especially important that these tubes, like other power-handling tubes, be adequately ventilated. Type 7027 is a DISCONTINUED type listed for reference only.

HEATER VOLTAGE (AC/DC).....	6.3	volts
HEATER CURRENT.....	0.9	ampere
DIRECT INTERELECTRODE CAPACITANCES (Approx.):		
Grid No.1 to Plate.....	1.5	$\mu\mu\text{f}$
Grid No.1 to Cathode, Heater, Grid No.2, and Grid No.3.....	10	$\mu\mu\text{f}$
Plate to Cathode, Heater, Grid No.2, and Grid No.3.....	7.5	$\mu\mu\text{f}$

### CLASS A<sub>1</sub> AMPLIFIER

#### Characteristics:

Plate Voltage.....	250	volts
Grid-No.2 (Screen-Grid) Voltage.....	250	volts
Grid-No.1 (Control-Grid) Voltage.....	-14	volts
Plate Resistance (Approx.).....	22500	ohms
Transconductance.....	6000	$\mu\text{mhos}$
Plate Current.....	72	ma
Grid-No.2 Current.....	5	ma

### PUSH-PULL CLASS AB<sub>1</sub> AMPLIFIER

#### Maximum Ratings for 7027-A, (Design-Maximum Values):

PLATE VOLTAGE.....	600 max	volts
GRID-NO.2 VOLTAGE.....	500 max	volts
PLATE DISSIPATION.....	35 max	watts
GRID-NO.2 INPUT.....	5 max	watts
PEAK HEATER-CATHODE VOLTAGE:		
Heater negative with respect to cathode.....	200 max	volts
Heater positive with respect to cathode.....	200 max	volts

### AVERAGE PLATE CHARACTERISTICS

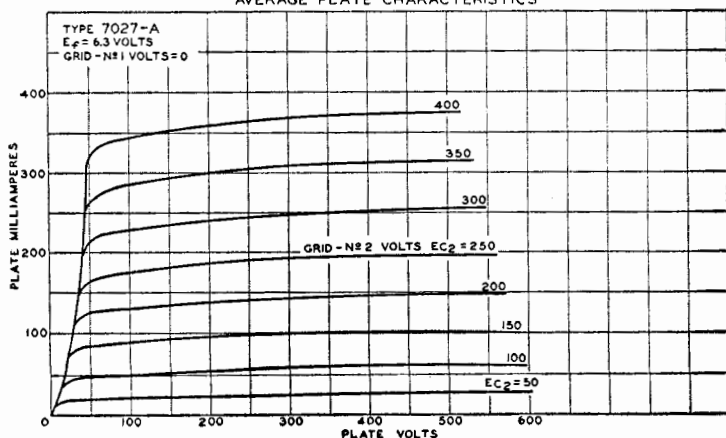

92CM-10132T

## Typical Operation for 7027-A<sub>1</sub> (Values are for two tubes):

	Fixed Bias			Cathode Bias			
	400	450	540	400	380	425	
Plate Supply Voltage.....	400	450	540	400	380	425	volts
Grid-No.2 Supply Voltage.....	300	350	400	300	380	425	volts
Grid-No.1 Voltage.....	-25*	-30*	-38*	-	-	-	volts
Cathode-Bias Resistor.....	-	-	-	200	180	200	ohms
Peak AF Grid-No.1-to-Grid-No.1 Voltage.....	50	60	76	57	68.5	86	volts
Zero-Signal Plate Current.....	102	95	100	112	138	150	ma
Maximum-Signal Plate Current.....	152	194	220	128	170	196	ma
Zero-Signal Grid-No.2 Current.....	6	3.4	5	7	5.6	8	ma
Maximum-Signal Grid-No.2 Current.....	17	19.2	21.4	16	20	20	ma
Effective Load Resistance (Plate-to-Plate).....	6600	6000	6500	6600	4500	3800	ohms
Total Harmonic Distortion.....	2	1.5	2	2	3.5	4	per cent
Maximum-Signal Power Output.....	34	50	76	32	36	44	watts

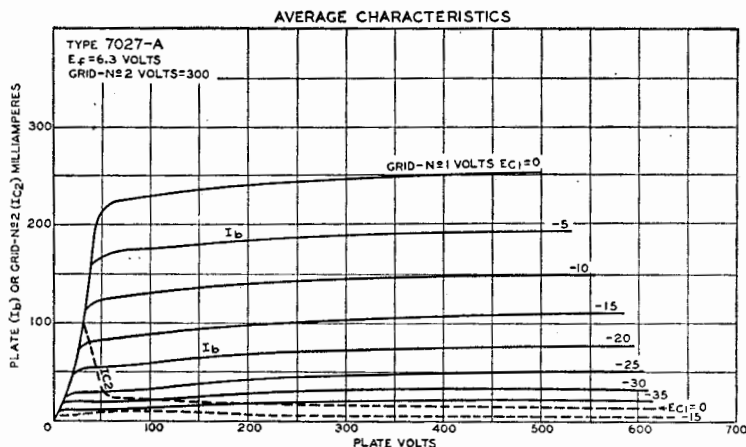

### Maximum Circuit Values:

Grid-No.1-Circuit Resistance:		
For fixed-bias operation.....	0.1 max	megohm
For cathode-bias operation.....	0.5 max	megohm

The dc component must not exceed 100 volts.

- The type of input coupling network used should not introduce too much resistance in the grid-No.1 circuit. Transformer- or impedance-coupling devices are recommended.

### PUSH-PULL CLASS AB<sub>1</sub> AMPLIFIER

*Grid No.2 of Each Tube Connected to Tap on Plate Winding of Output Transformer*

### Maximum Ratings, for 7027-A<sub>1</sub> (Design-Maximum Values):

PLATE AND GRID-NO.2 SUPPLY VOLTAGE.....	600 max	volts
PLATE DISSIPATION.....	35 max	watts
GRID-NO.2 INPUT.....	4.5 max	watts
PEAK HEATER-CATHODE VOLTAGE:		
Heater negative with respect to cathode.....	200 max	volts
Heater positive with respect to cathode.....	200 max	volts

### Typical Operation (Values are for two tubes):

Plate Supply Voltage.....	410	volts
Grid-No.2 Supply Voltage.....	220	volts
Cathode-Bias Resistor.....	220	ohms
Peak AF Grid-No.1-to-Grid-No.1 Voltage.....	68	volts
Zero-Signal Cathode Current.....	134	ma
Maximum-Signal Cathode Current.....	155	ma
Effective Load Resistance (Plate to plate).....	8000	ohms
Total Harmonic Distortion.....	1.6	per cent
Maximum-Signal Power Output.....	24	watts

### Maximum Circuit Value:

Grid-No.1-Circuit Resistance:		
For cathode-bias operation.....	0.5 max	megohm

• The dc component must not exceed 100 volts.

\* Obtained from taps on the primary winding of the output transformer. The taps are located on each side of the center tap (B+) so as to apply 43 per cent of the plate signal voltage to grid No.2 of each output tube.

**POWER PENTODE**

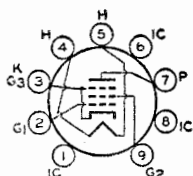

Miniature type used as power amplifier tube in high-fidelity audio equipment. Outline 18, OUTLINES SECTION. Tube requires miniature nine-contact socket and may be mounted in any position. Heater volts (ac/dc), 6.3; amperes, 0.76.

**7189**

**CLASS A<sub>1</sub> AMPLIFIER**

Characteristics:		
Plate Voltage.....	250	volts
Grid-No.2 (Screen-Grid) Voltage.....	250	volts
Grid-No.1 (Control-Grid) Voltage.....	-7.3	volts
Mu-Factor, Grid No.2 to Grid No.1.....	19.5	
Plate Resistance (Approx.).....	40000	ohms
Transconductance.....	11300	amhos
Plate Current.....	48	ma
Grid-No.2 Current.....	5.5	ma

**PUSH-PULL CLASS AB<sub>1</sub> AMPLIFIER**

<b>Maximum Ratings:</b>		<i>Grid-No.2 Special Connection*</i>	
PLATE VOLTAGE.....	400 max	375 max	volts
GRID-NO.2 VOLTAGE.....	300 max	•	volts
CATHODE CURRENT.....	65 max	65 max	ma
PLATE DISSIPATION.....	12 max	12 max	watts
ZERO-SIGNAL GRID-NO.2 INPUT.....	2 max	2 max	watts
MAXIMUM-SIGNAL GRID-NO.2 INPUT.....	4 max	4 max	watts
<b>PEAK HEATER-CATHODE VOLTAGE:</b>			
Heater negative with respect to cathode.....	100 max	100 max	volts
Heater positive with respect to cathode.....	100 max	100 max	volts

**Typical Operation, (Values are for two tubes):**

		<i>Grid-No.2 Special Connection*</i>	
Plate Supply Voltage.....	-	375	volts
Plate Voltage.....	400	-	volts
Grid-No.2 Supply Voltage.....	-	•	
Grid-No.2 Voltage.....	300	•	volts
Grid-No.1 Voltage.....	-15	-	volts
Cathode-Bias Resistor.....	-	220	ohms
Peak AF Grid-No.1 Voltage.....	14.8	17.7	volts
Zero-Signal Plate Current.....	15	70	ma
Maximum-Signal Plate Current.....	105	81	ma
Zero-Signal Grid-No.2 Current.....	1.6	•	ma
Maximum-Signal Grid-No.2 Current.....	25	•	ma
Effective Load Resistance (Plate-to-plate).....	8000	11000	ohms
Total Harmonic Distortion.....	4	3	per cent
Maximum-Signal Power Output.....	24	16.5	watts

**Maximum Circuit Values:**

Grid-No.1-Circuit Resistance.....	<i>Fixed Bias</i>	<i>Cathode Bias</i>
	0.3 max	1 max megohm

\* Grid No.2 of each tube connected to tap on plate winding of output transformer.

• Obtained from taps on primary winding of the output transformer. The taps are located on each side of the center tap (B+) so as to supply 43 per cent of the plate signal voltage to grid No.2 of each output tube.

**MEDIUM-MU TRIODE—  
SHARP-CUTOFF PENTODE**

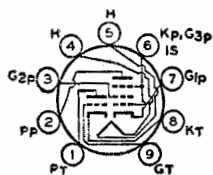

Miniature type used in a wide variety of applications in high-quality, high-fidelity audio equipment, particularly in phase-splitters, tone-control amplifiers, and high-gain voltage

**7199**

amplifiers in which low hum and reduced noise are required. Outline 12, OUTLINES SECTION. Tube requires miniature nine-contact socket and may be mounted in any position. For operation as resistance-coupled amplifier, refer to Charts 14 and 15, RESISTANCE-COUPLED AMPLIFIER SECTION. In direct-coupled voltage-amplifier phase-splitter circuits, the pentode unit should drive the triode unit.

HEATER VOLTAGE (AC/DC) .....	6.3	volts
HEATER CURRENT .....	0.45	amperes
<b>DIRECT INTERELECTRODE CAPACITANCES:</b>		
Triode Unit:		
Grid to Plate .....	2	$\mu\text{f}$
Grid to Cathode and Heater .....	2.3	$\mu\text{f}$
Plate to Cathode and Heater .....	0.3	$\mu\text{f}$
Pentode Unit:		
Grid No.1 to Plate .....	0.06 max	$\mu\text{f}$
Grid No.1 to Cathode, Heater, Grid No.2, Grid No.3, and Internal Shield ..	5	$\mu\text{f}$
Plate to Cathode, Heater, Grid No.2, Grid No.3, and Internal Shield .....	2	$\mu\text{f}$

### Equivalent-Noise and Hum Voltage Referenced to Grid:

	Triode Unit	Pentode Unit	
Median Value (rms) .....	10†	35•	$\mu\text{volts}$
Maximum Value (rms) .....	150†	100•	$\mu\text{volts}$

† Measured in "true rms" units under the following conditions: heater volts (ac), 6.3; center tap of heater transformer connected to ground; plate-supply volts, 250; plate load resistor, 0.1 megohm; cathode resistor, 1500 ohms; grid resistor, 0.05 megohm; and amplifier covering frequency range between 25 and 10000 cycles per second.

• Same conditions as for triode unit except: grid-No.2 supply volts, 250; grid-No.2 resistor, 0.33 megohm; grid-No.2-bypass capacitor, 0.22  $\mu\text{f}$ ; cathode resistor, 1200 ohms; and grid-No.1 resistor, 0.05 megohm.

### CLASS A<sub>1</sub> AMPLIFIER

#### Maximum Ratings, (Design-Maximum Values):

	Triode Unit	Pentode Unit	
PLATE VOLTAGE .....	330 max	330 max	volts
GRID-NO.2 (SCREEN-GRID) VOLTAGE .....	—	See curve page 66	
GRID-NO.2 SUPPLY VOLTAGE .....	—	330 max	volts
GRID-NO.1 (CONTROL-GRID) VOLTAGE, Positive bias value .....	0 max	0 max	volts
PLATE DISSIPATION .....	2.4 max	3 max	watts
GRID-NO.2 INPUT:			
For grid-No.2 voltages up to 165 volts .....	—	0.6 max	watt
For grid-No.2 voltages between 165 and 330 volts .....	—	See curve page 66	
PEAK HEATER-CATHODE VOLTAGE:			
Heater positive with respect to cathode .....	200 max	200 max	volts
Heater negative with respect to cathode .....	200 max	200 max	volts

### AVERAGE CHARACTERISTICS TRIODE UNIT

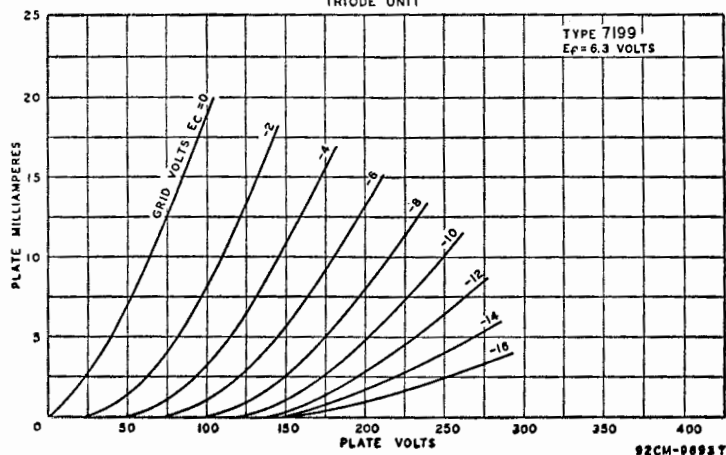



**Characteristics:**

	Triode Unit	Pentode Unit		
Plate Supply Voltage.....	215	100	220	volts
Grid-No.2 Supply Voltage.....	—	50	130	volts
Grid-No.1 Voltage.....	-8.5	—	—	volts
Cathode-Bias Resistor.....	—	1000	62	ohms
Amplification Factor.....	17	—	—	
Plate Resistance (Approx.).....	0.0081	1	0.4	megohm
Transconductance.....	2100	1500	7000	$\mu$ mhos
Grid-No.1 Voltage (Approx.) for plate current of 10 $\mu$ a.....	-40	-4	—	volts
Plate Current.....	9	1.1	12.5	ma
Grid-No.2 Current.....	—	0.35	3.5	ma

**Maximum Circuit Values:**

Grid-No.1-Circuit Resistance:*	Triode Unit	Pentode Unit	
For fixed-bias operation.....	0.5 max	0.25 max	megohm
For cathode-bias operation.....	1.0 max	1.0 max	megohm

\* The dc component must not exceed 100 volts.

\* If either unit is operated at maximum rated conditions, grid-No.1-circuit resistance for both units should not exceed the stated values.

### AVERAGE CHARACTERISTICS PENTODE UNIT

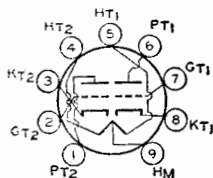
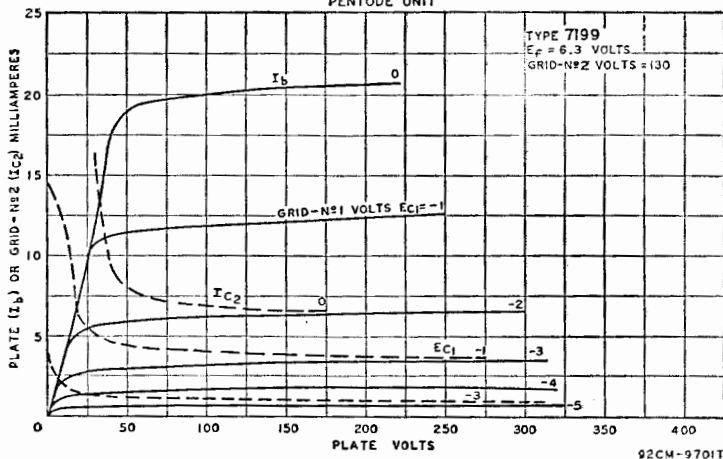

## DUAL TRIODE

Miniature type used for combined first- and second-stage audio preamplification in high-fidelity phonograph or tape equipment. Tube has high- $\mu$  unit and medium- $\mu$  unit. Outline 12,

# 7247

OUTLINES SECTION. Tube requires miniature nine-contact socket and may be operated in any position.

HEATER ARRANGEMENT:	Series	Parallel	
HEATER VOLTAGE (AC/DC).....	12.6	6.3	volts
HEATER CURRENT.....	0.15	0.3	ampere

### CLASS A<sub>1</sub> AMPLIFIER

Maximum Ratings, (Design-Maximum Values):	Unit No.1	Unit No.2	
PLATE VOLTAGE.....	330 max	330 max	volts
GRID VOLTAGE:			
Negative-bias value.....	55 max	55 max	volts
Positive-bias value.....	0 max	0 max	volts
CATHODE CURRENT.....	—	22 max	ma
PLATE DISSIPATION.....	1.2 max	3 max	watts
PEAK HEATER-CATHODE VOLTAGE:			
Heater negative with respect to cathode.....	200 max	200 max	volts
Heater positive with respect to cathode.....	200 <sup>o</sup> max	200 <sup>o</sup> max	volts

**Characteristics:**

	<i>Unit</i> <i>No.1</i>		<i>Unit</i> <i>No.2</i>		
Plate Voltage.....	100	250	100	250	volts
Grid Voltage.....	-1	-2	0	-8.5	volts
Amplification Factor.....	100	100	20	17	
Plate Resistance (Approx.).....	80000	62500	6500	7700	ohms
Transconductance.....	1250	1600	3100	2200	μmhos
Plate Current.....	0.5	1.2	11.8	10.5	ma
Grid Voltage (Approx.), For plate current of 10 μa	-	-	-	-24	volts

**Maximum Circuit Values:**

	<i>Unit</i> <i>No.1</i>		<i>Unit</i> <i>No.2</i>	
Grid-Circuit Resistance:				
For fixed-bias operation.....	15	max	0.5	max megohms
For cathode-bias operation.....	-	-	1	max megohm

**Hum Output Voltage:**

Average Value (rms, cathode bypassed)■.....	1.8	μvolts
Maximum Value (rms, cathode unbypassed)●.....	7	μvolts

° The dc component must not exceed 100 volts.

■ Measured in "true rms" units under the following conditions: heater volts (ac), 6.3 (parallel connection); center tap of heater transformer connected to ground; dc plate supply volts, 250; plate load resistor, 0.1 megohm; cathode resistor, 2700 ohms; cathode-bypass capacitor, 100 μf; grid resistor, 0 ohms; amplifier covering frequency range of 25 to 10000 cps.

● Same conditions as above, except that cathode resistor is unbypassed and grid resistor is 0.05 megohm.

**7543**

**SHARP-CUTOFF PENTODE**

Miniature type used in compact audio equipment, especially in low-hum, low-microphonic, high-gain, resistance-coupled-amplifier applications. Outline 11, OUTLINES SEC-

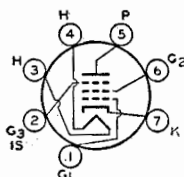

**TION.** This type is identical with miniature type 6AU6 except that it has a controlled hum characteristic.

**Hum Output Voltage:**

Average Value (rms, cathode bypassed).....	1.2†	millivolts
Average Value (rms, cathode unbypassed).....	0.9●	millivolt

† Measured in "true rms" units under the following conditions: heater volts (ac), 6.3; center tap of heater transformer connected to ground; plate and grid-No.2 supply volts, 250; plate load resistor, 0.27 megohm; grid No.3 and internal shield connected to cathode at socket; grid-No.2 resistor, 0.68 megohm; grid-No.1 resistor, 0.1 megohm; cathode resistor, 1000 ohms; grid resistor of following stage, 10 megohms; and stage gain, 340

● Same conditions as above except cathode resistor is unbypassed and stage gain is 110.

**7868**

**POWER PENTODE**

Novar type used in output stages of high-fidelity audio amplifiers or radio receivers; used in applications requiring relatively large power output. Outline 53, OUTLINES SEC-

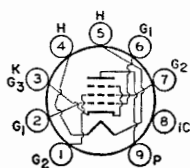

**TION,** except that tube is 0.6 inch shorter in vertical dimensions. Tube requires novar nine-contact socket and may be operated in any position. It is especially important that this tube, like other power-handling tubes, be adequately ventilated.

HEATER VOLTAGE (AC/DC).....	6.3	volts
HEATER CURRENT.....	0.8	ampere
DIRECT INTERELECTRODE CAPACITANCES (Approx.):°		
Grid No.1 to Plate.....	0.15	μμf
Grid No.1 to Cathode, Heater, Grid No.2, and Grid No.3.....	11	μμf
Plate to Cathode, Heater, Grid No.2, and Grid No.3.....	4.4	μμf

° Without external shield.

# Technical Data

## CLASS A<sub>1</sub> AMPLIFIER

### Maximum Ratings, (Design-Maximum System):

PLATE VOLTAGE.....	550 <sup>max</sup>	volts
GRID-NO.2 (SCREEN-GRID) VOLTAGE.....	440 <sup>max</sup>	volts
PLATE DISSIPATION.....	19 <sup>max</sup>	watts
GRID-NO.2 INPUT.....	3.3 <sup>max</sup>	watts
DC CATHODE CURRENT.....	90 <sup>max</sup>	ma
PEAK HEATER-CATHODE VOLTAGE:		
Heater negative with respect to cathode.....	200 <sup>max</sup>	volts
Heater positive with respect to cathode.....	200 <sup>max</sup>	volts
BULB TEMPERATURE (At hottest point).....	240 <sup>max</sup>	°C

### Typical Operation and Characteristics:

Plate Supply Voltage.....	300	volts
Grid-No.2 Voltage.....	300	volts
Grid-No.1 (Control-Grid) Voltage.....	-10	volts
Peak AF Grid-No.1 Voltage.....	10	volts
Zero-Signal Plate Current.....	60	ma
Maximum-Signal Plate Current.....	75	ma
Zero-Signal Grid-No.2 Current.....	8	ma
Maximum-Signal Grid-No.2 Current.....	15	ma
Plate Resistance (Approx.).....	29000	ohms
Transconductance.....	10200	μohms
Effective Load Resistance.....	3000	ohms
Total Harmonic Distortion.....	13	per cent
Maximum-Signal Power Output.....	11	watts

## PUSH-PULL CLASS AB<sub>1</sub> AMPLIFIER

### Maximum Ratings, (Same as for Class A<sub>1</sub> Amplifier)

Typical Operation (Values are for two tubes):	Fixed Bias				Cathode Bias		
Plate Supply Voltage.....	300	350	400	450	450	450	volts
Grid-No.2 Supply Voltage.....	300	350	350	350	400	400	volts
Grid-No.1 Voltage.....	-12.5	-15.5	-16	-16.5	-21	-	volts
Cathode-Bias Resistor (Common to both cathodes).....	-	-	-	-	-	170	ohms
Peak AF Grid-No.1-to-Grid-No.1 Voltage.....	25	31	32	33	42	31	volts
Zero-Signal Plate Current.....	74	72	64	60	40	86	ma
Maximum-Signal Plate Current.....	116	130	135	142	145	94	ma
Zero-Signal Grid-No.2 Current.....	10	9.5	8	7.2	5	10	ma
Maximum-Signal Grid-No.2 Current.....	28	32	28	26	30	20	ma
Effective Load Resistance (Plate-to-plate).....	6600	6600	6600	6600	6600	10000	ohms
Total Harmonic Distortion.....	5	2.5	2	2.5	5	2	per cent
Maximum-Signal Power Output.....	24	30	34	38	44	28	watts

## PUSH-PULL CLASS AB<sub>1</sub> AMPLIFIER

*Grid No.2 of Each Tube Connected to Tap on Plate Winding of Output Transformer\**

### Maximum Ratings: (Same as for Class A<sub>1</sub> Amplifier)

Typical Operation (Values are for two tubes):	Fixed Bias	Cathode Bias	
Plate Supply Voltage.....	400	425	volts
Grid-No.2 Supply Voltage.....	*	*	volts
Grid-No.1 Voltage.....	-20.5	-	volts
Cathode-Bias Resistor (Common to both cathodes).....	-	185	ohms
Peak AF Grid-No.1-to-Grid-No.1 Voltage.....	41	42	volts
Zero-Signal Plate Current.....	60	88	ma
Maximum-Signal Plate Current.....	115	100	ma
Zero-Signal Grid-No.2 Current.....	8	12	ma
Maximum-Signal Grid-No.2 Current.....	18	16	ma
Effective Load Resistance (Plate-to-plate).....	6600	6600	ohms
Total Harmonic Distortion.....	2.5	3.5	per cent
Maximum-Signal Power Output.....	23	21	watts

### Maximum Circuit Values:

#### Grid-No.1-Circuit Resistance:

For fixed-bias operation.....	0.3 <sup>max</sup>	megohm
For cathode-bias operation.....	1 <sup>max</sup>	megohm

■ In push-pull circuits where the grid No.2 of each tube is connected to a tap on the plate winding of the output transformer, this maximum rating is 440 volts.

• Grid No.2 input may reach 6 watts during peak levels of speech and music signals.

□ The dc component must not exceed 100 volts.

\* Grid No.2 supply voltage is obtained from taps on the primary winding of the output transformer. The taps are located on each side of the center tap (B+) so as to apply 50 per cent of the plate signal voltage to the grid No.2 of each output tube.

AVERAGE CHARACTERISTICS

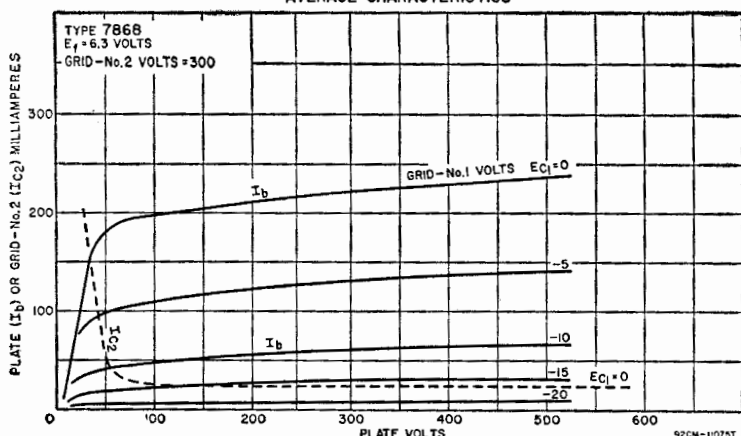

**EM84/  
6FG6**

**ELECTRON-RAY TUBE**

Miniature type with triode unit used to indicate visually by means of a fluorescent target the effects of changes in a controlling voltage. Tube is used for accurate tuning or modulation control.

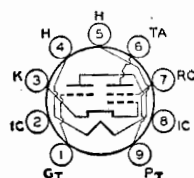

Outline 14, OUTLINES SECTION, except all vertical dimensions of this type are 1/8 inch greater. Tube requires nine-contact socket and may be mounted in any position. Heater volts (ac/dc), 6.3; amperes, 0.27. For additional considerations, refer to *Tuning Indication with Electron-Ray Tubes* in ELECTRON TUBE APPLICATIONS SECTION.

**INDICATOR SERVICE**

**Maximum and Minimum Ratings:**

<b>RAY-CONTROL-ELECTRODE VOLTAGE:</b>		
Without current flowing through series triode-plate resistor.....	550 max	volts
With current flowing through series triode-plate resistor.....	300 max	volts
<b>FLUORESCENT-TARGET VOLTAGE:</b>		
Without current flowing through series triode-plate resistor.....	550 max	volts
With current flowing through series triode-plate resistor.....	300 max	volts
	150 min	volts
<b>CATHODE CURRENT.....</b>	3 max	ma
<b>TRIODE-PLATE DISSIPATION.....</b>	0.5 max	watt
<b>PEAK HEATER-CATHODE VOLTAGE:</b>		
Heater negative with respect to cathode.....	100 max	volts
Heater positive with respect to cathode.....	100 max	volts
<b>BULB TEMPERATURE (At hottest point).....</b>	120 max	°C

**Typical Operation with Ray-Control Electrode Connected to Triode Plate:**

Triode-Plate Supply Voltage.....	250	250	volts
Fluorescent-Target Voltage.....	250	250	volts
Series Triode-Plate Resistor.....	0.47	0.47	megohm
Triode-Grid Supply Voltage.....	0	-22	volts
Triode-Grid Resistor.....	3	3	megohms
Triode-Plate Current.....	0.45	0.06	ma
Fluorescent-Target Current.....	1.1	1.6	ma
Length of Dark Part of Fluorescent Target.....	0.83 ± 0.20	0	inch
Length of Dark Part of Fluorescent Target when triode-grid resistor is 0 ohms.....	0.94 ± 0.20	—	inch

**Maximum Circuit Value:**

Triode-Grid-Circuit Resistance.....	3 max	megohms
-------------------------------------	-------	---------

# RCA Picture Tube Characteristics<sup>†</sup>

 Type	Envelope	Aluminized Screen	Facplate <sup>a</sup>	Minimum Screen Size Inches	Focusing Method	Deflection Method	Approx. Diagonal Deflection Angle Degrees	High Voltage Terminal	Basing	Maximum Final High-Voltage Electrode (Ultra) V <sub>c</sub> Volts	PM Ion-Trap Magnet Required
<b>Black-and-White Types</b>											
5TP4 <sup>d</sup>	G	Yes	CL	4 1/2 Dia.	E	M	50*	Cavity Cap	12C	27000	No
7JP4	G	No	CL	6 Dia.	E	E	(f)	Base Pin	14R	6000	No
8DP4	G	No	FG	7 3/8 x 5 3/8	E	M	90	Cavity Cap	12AB	8000	Yes
10BP4A	G	No	FG	9 1/2 Dia.	M	M	50*	Cavity Cap	12N	12000	Yes
10FP4A	G	Yes	FG	9 1/2 Dia.	M	M	50*	Cavity Cap	12N	12000	No
12KP4A	G	Yes	FG	11 1/2 Dia.	M	M	54*	Cavity Cap	12N	12000	No
12LP4A	G	No	FG	11 Dia.	M	M	54*	Cavity Cap	12N	12000	Yes
14ATP4 <sup>d</sup>	G	Yes	FG	12 1/8 x 9 1/2	E	M	90	Cavity Cap	12L	14000	No
14BP4	G	Yes	FG	11 3/4 x 8 5/8	E	M	70	Cavity Cap	12L	22000 <sup>b</sup>	No
14EP4	G	No	FG	11 3/4 x 8 5/8	M	M	70	Cavity Cap	12N	14000	Yes
14HP4	G	No	FG	11 3/4 x 8 5/8	E	M	70	Cavity Cap	12L	14000	Yes
14QP4A	G	Yes	FG	11 3/4 x 8 5/8	E	M	70	Cavity Cap	12L	11000	Yes
14RP4A	G	Yes	FG	12 1/8 x 9 1/2	E	M	90	Cavity Cap	12L	14000	Yes
14WP4	G	Yes	FG	12 1/8 x 9 1/2	E	M	90	Cavity Cap	12L	14000	No
16AP4A	M	No	FG	14 3/8 Dia.	M	M	53*	Metal-Shell Lip	12D	14000	Yes
16DP4A	G	No	FG	14 3/8 Dia.	M	M	60*	Cavity Cap	12D	15000	Yes
16GP4B	M	No	FFG	14 3/8 Dia.	M	M	70*	Metal-Shell Lip	12D	14000	Yes
16LP4A	G	No	FG	14 3/8 Dia.	M	M	52*	Cavity Cap	12N	14000	Yes
16RP4A	G	Yes	FG	13 1/2 x 10 1/8	M	M	70	Cavity Cap	12N	16000	Yes
16TP4	G	No	FG	13 1/2 x 10 1/8	M	M	70	Cavity Cap	12N	14000	Yes
16WP4A	G	No	FG	14 3/8 Dia.	M	M	70*	Cavity Cap	12N	16000	Yes
17AVP4A	G	Yes	FG	14 5/8 x 11 3/8	E	M	90	Cavity Cap	12L	16000	Yes
17BJP4	G	Yes	FG	14 5/8 x 11 3/8	E	M	90	Cavity Cap	12L	16000	No
17BP4B	G	Yes	FG	14 5/8 x 11 3/8	M	M	70	Cavity Cap	12N	16000	Yes
17BVP4	G	Yes	FG	14 3/4 x 11 1/8	E	M	110	Cavity Cap	7FA	16000	Yes
17BZP4	G	Yes	FG	14 5/8 x 11 3/8	E	M	110	Cavity Cap	8HR	16000	No
17CDP4 <sup>d</sup>	G	Yes	FG	14 3/4 x 11 1/8	E	M	110	Cavity Cap	8HR	16000	No
17CFP4	G	Yes	FG	14 3/4 x 11 1/8	E	M	90	Cavity Cap	12L	16000	No
17CP4	M	No	FFG	14 3/8 x 10 1/8	M	M	70	Metal-Shell Lip	12D	16000	Yes
17CYP4	G	Yes	FG	14 5/8 x 11 3/8	E	M	90	Cavity Cap	12L	16000	No
17DAP4	G	Yes	FG	14 3/4 x 11 1/8	E	M	110	Cavity Cap	8JK	16000	No
17DKP4	G	Yes	FG	14 3/4 x 11 1/8	E	M	110	Cavity Cap	8JR	18000	No
17DSP4	G	Yes	FG	14 3/4 x 11 1/8	E	M	110	Cavity Cap	8HR	18000	No
17DWP4	G	Yes	—	14 5/8 x 11 3/8	E	M	70	Cavity Cap	12L	20000	No
17DXP4 <sup>d</sup>	G	Yes	FG	14 3/4 x 11 1/8	E	M	110	Cavity Cap	8JR	16000	No
17GP4	M	No	FFG	14 3/8 x 10 1/8	E	M	70	Metal-Shell Lip	12M	16000	Yes
17HP4B	G	Yes	FG	14 5/8 x 11 3/8	E	M	70	Cavity Cap	12L	16000	Yes
17LP4A	G	Yes	FG <sup>m</sup>	14 3/4 x 10 3/4	E	M	70	Cavity Cap	12L	16000	Yes
17QP4A	G	Yes	FG <sup>m</sup>	14 3/4 x 10 3/4	M	M	70	Cavity Cap	12N	18000	Yes
17TP4	M	No	FFG	14 3/8 x 10 1/8	E	M	70	Metal-Shell Lip	12M	16000	Yes
19AFP4	G <sup>n</sup>	Yes	FG	15 3/4 x 12	E	M	114	Cavity Cap	8HR	20000 <sup>b</sup>	No
19AJP4 <sup>d</sup>	G	Yes	FG	15 3/8 x 12	E	M	114	Cavity Cap	7FA	19800 <sup>hp</sup>	No
19ANP4 <sup>d</sup>	G	Yes	FG	15 3/8 x 12 1/8	E	M	114	Cavity Cap	8JR	20000 <sup>b</sup>	No
19AP4B	M	No	FFG	17 3/8 Dia.	M	M	66*	Metal-Shell Lip	12D	16000	Yes
19AVP4	G	Yes	FG	15 3/8 x 12	E	M	114	Cavity Cap	8HR	23000 <sup>b</sup>	No
19AXP4 <sup>d</sup>	G	Yes	FG	15 3/8 x 12	E	M	114	Cavity Cap	8HR	20000 <sup>b</sup>	No
19AYP4 <sup>d</sup>	G	Yes	FG	15 3/8 x 12	E	M	114	Cavity Cap	8HR	23000 <sup>b</sup>	No
19BDP4	G	Yes	FG	15 3/8 x 12	E	M	92	Cavity Cap	12L	19800 <sup>hp</sup>	No
19BFP4	G	Yes	FG	15 3/8 x 12	E	M	92	Cavity Cap	12L	20000 <sup>b</sup>	No
19BTP4	G	Yes	FG	15 3/8 x 12	E	M	114	Cavity Cap	8JR	23000 <sup>b</sup>	No
19XP4	G	Yes	FG	15 3/8 x 12	E	M	114	Cavity Cap	8HR	20000 <sup>b</sup>	No
19YP4	G	Yes	FG	15 3/8 x 12	E	M	114	Cavity Cap	8JR	20000 <sup>b</sup>	No
20DP4C	G	Yes	FG	17 x 12 3/4	M	M	70	Cavity Cap	12N	18000	Yes

 Type	Envelope	Aluminized Screen	Facelate <sup>a</sup>	Minimum Screen Size Inches	Focusing Method	Deflection Method	Approx. Diagonal Deflection Angle Degrees	High Voltage Terminal	Basing	Maximum Final High-Voltage Electrode (Ultor) <sup>b,c</sup> Volts	PM Ion-Trap Magnet Required
<b>Black-and-White Types</b>											
20HP4D	G	Yes	FG	17 x 12 $\frac{3}{4}$	E	M	70	Cavity Cap	12L	16000	Yes
21AMP4A	G	Yes	FG	19 $\frac{1}{16}$ x 15 $\frac{1}{16}$	M	M	90	Cavity Cap	12N	18000	Yes
21AP4	M	No	FFG	18 $\frac{1}{8}$ x 13 $\frac{1}{16}$	M	M	70	Metal-Shell Lip	12D	18000	Yes
21AVP4B	G	Yes	FG	19 $\frac{1}{16}$ x 15 $\frac{1}{16}$	E	M	72	Cavity Cap	12L	20000	Yes
21AWP4	G	Yes	FG	19 $\frac{1}{16}$ x 15 $\frac{1}{16}$	M	M	72	Cavity Cap	12N	18000	Yes
21CBP4A	G	Yes	FG	19 $\frac{1}{16}$ x 15 $\frac{1}{16}$	E	M	90	Cavity Cap	12L	20000	No
21CEP4	G	Yes	FG	19 $\frac{1}{16}$ x 15 $\frac{1}{16}$	E	M	110	Cavity Cap	8HR	18000	No
21CQP4	G	Yes	FG	19 $\frac{1}{16}$ x 15 $\frac{1}{16}$	E	M	110	Cavity Cap	7FA	18000	No
21DEP4A	G	Yes	FG	19 $\frac{1}{16}$ x 15 $\frac{1}{16}$	E	M	110	Cavity Cap	8HR	20000	No
21DFP4	G	Yes	FG	19 $\frac{1}{16}$ x 15 $\frac{1}{16}$	E	M	110	Cavity Cap	8HR	18000	No
21DHP4 <sup>d</sup>	G	Yes	FG	19 $\frac{1}{16}$ x 15 $\frac{1}{16}$	E	M	110	Cavity Cap	8HR	18000	No
21DLP4	G	Yes	FG	19 $\frac{1}{16}$ x 15 $\frac{1}{16}$	E	M	90	Cavity Cap	12L	20000	No
21DSP4	G	Yes	FG	19 $\frac{1}{16}$ x 15 $\frac{1}{16}$	E	M	90	Cavity Cap	12L	20000 <sup>p</sup>	No
21EAP4 <sup>q</sup>	G	Yes	FG	19 $\frac{1}{16}$ x 15 $\frac{1}{16}$	E	M	110	Cavity Cap	8JK	18000	No
21EMP4	G	Yes	FG	19 $\frac{1}{16}$ x 15 $\frac{1}{16}$	E	M	110	Cavity Cap	8HR	18000	No
21EP4B	G	Yes	FG <sup>n</sup>	19 $\frac{1}{8}$ x 13 $\frac{3}{8}$	M	M	70	Cavity Cap	12N	18000	Yes
21EQP4	G	Yes	FG	19 $\frac{1}{16}$ x 15 $\frac{1}{16}$	E	M	110	Cavity Cap	8JR	18000	No
21FP4C	G	Yes	FG <sup>n</sup>	19 $\frac{1}{8}$ x 13 $\frac{3}{8}$	E	M	70	Cavity Cap	12L	18000	Yes
21MP4	M	No	FFG	18 $\frac{1}{8}$ x 13 $\frac{1}{16}$	E	M	70	Metal-Shell Lip	12M	16000	Yes
21WP4A	G	Yes	FG	17 $\frac{3}{8}$ x 13 $\frac{3}{8}$	M	M	70	Cavity Cap	12N	18000	Yes
21XP4A	G	Yes	FG	17 $\frac{3}{8}$ x 13 $\frac{3}{8}$	E	M	70	Cavity Cap	12L	18000	Yes
21YP4A	G	Yes	FG	19 $\frac{1}{16}$ x 14 $\frac{1}{16}$	E	M	70	Cavity Cap	12L	18000	Yes
21ZP4	G	Yes	FG	19 $\frac{1}{16}$ x 14 $\frac{1}{16}$	M	M	70	Cavity Cap	12N	18000	Yes
23AFP4	G <sup>n</sup>	Yes	FG	19 $\frac{1}{8}$ x 15 $\frac{1}{4}$	E	M	92	Cavity Cap	12L	25000 <sup>h</sup>	No
23AHP4	G	Yes	FG	19 $\frac{1}{4}$ x 15 $\frac{1}{8}$	E	M	92	Cavity Cap	12L	22000 <sup>h</sup>	No
23ALP4 <sup>i</sup>	G	Yes	FG	19 $\frac{1}{4}$ x 15 $\frac{1}{8}$	E	M	114	Cavity Cap	8HR	22000 <sup>h</sup>	No
23ANP4	G <sup>n</sup>	Yes	FG	19 $\frac{1}{8}$ x 15 $\frac{1}{4}$	E	M	92	Cavity Cap	12L	25000 <sup>h</sup>	No

### Key to Notes

† Active RCA Picture-Tube Types shown here can replace more than 300 different types of industry picture tubes. The RCA Picture Tube Replacement and Interchangeability Chart is available on request.

Unless otherwise noted, all picture tubes listed have 6.3-volt, 600-milliamperes heaters.

G Glass rectangular.

G Glass round.

M Metal rectangular.

M Metal round.

CL Clear glass.

FG Filterglass.

FFG Frosted Filterglass.

M Magnetic.

E Electrostatic.

s Spherical, unless otherwise specified.

b Ultor is defined as the electrode, or the electrode in combination with one or more additional electrodes connected within the tube to it, to which is applied the highest dc voltage for accelerating the electrons in the beam prior to its deflection.

d Design-Center Value, unless otherwise indicated.

## Basing Diagrams for RCA Picture Tubes

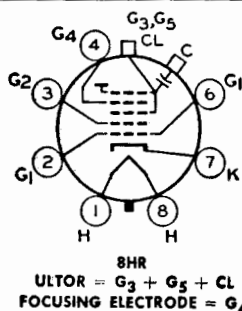
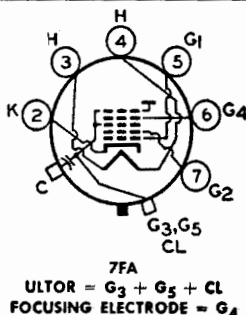

# Picture Tube Characteristics

 Type	Envelope	Aluminized Screen	Faceplate <sup>a</sup>	Minimum Screen Size Inches	Focusing Method	Deflection Method	Approx. Diagonal Deflection Angle Degrees	High Voltage Terminal	Basing	Maximum Final High-Voltage Electrode (Ultor <sup>b</sup> ) <sup>c</sup> Volts	PM Ion-Trap Magnet Required
<b>Black-and-White Types</b>											
23ASP4	[G]	Yes	FG	19 $\frac{1}{4}$ x 15 $\frac{1}{4}$	E	M	92	Cavity Cap	12L	22000 <sup>h</sup>	No
23AVP4	[G] <sup>p</sup>	Yes	FG <sup>r</sup>	19 $\frac{1}{8}$ x 15 $\frac{1}{4}$	E	M	110	Cavity Cap	8HR	22000 <sup>h</sup>	No
23AWP4	[G]	Yes	FG	19 $\frac{1}{4}$ x 15 $\frac{1}{4}$	E	M	92	Cavity Cap	12L	22000 <sup>h</sup>	No
23BJP4	[G]	Yes	FG	19 $\frac{1}{4}$ x 15 $\frac{1}{4}$	E	M	92	Cavity Cap	12L	25000 <sup>h</sup>	No
23BKP4	[G] <sup>p</sup>	Yes	FG	19 $\frac{1}{8}$ x 15 $\frac{1}{4}$	E	M	92	Cavity Cap	12L	25000 <sup>h</sup>	No
23BLP4	[G] <sup>p</sup>	Yes	FG <sup>r</sup>	19 $\frac{1}{8}$ x 15 $\frac{1}{4}$	E	M	92	Cavity Cap	12L	25000 <sup>h</sup>	No
23CP4	[G] <sup>p</sup>	Yes	FG	19 $\frac{1}{8}$ x 15 $\frac{1}{4}$	E	M	110	Cavity Cap	8HR	22000 <sup>h</sup>	No
23EP4	[G] <sup>p</sup>	Yes	FG	19 $\frac{1}{8}$ x 15 $\frac{1}{4}$	E	M	110	Cavity Cap	8KP	22000 <sup>h</sup>	No
23MP4	[G]	Yes	FG	19 $\frac{1}{4}$ x 15 $\frac{1}{4}$	E	M	114	Cavity Cap	8HR	22000 <sup>h</sup>	No
23NP4	[G]	Yes	FG	19 $\frac{1}{4}$ x 15 $\frac{1}{4}$	E	M	114	Cavity Cap	8HR	22000 <sup>h</sup>	No
23XP4	[G] <sup>p</sup>	Yes	FG	19 $\frac{1}{8}$ x 15 $\frac{1}{4}$	E	M	92	Cavity Cap	12L	18000 <sup>h</sup>	No
23YP4	[G] <sup>p</sup>	Yes	FG	19 $\frac{1}{8}$ x 15 $\frac{1}{4}$	E	M	92	Cavity Cap	12L	22000 <sup>h</sup>	No
24AEP4	[G]	Yes	FG	21 $\frac{1}{16}$ x 16 $\frac{7}{8}$	E	M	90	Cavity Cap	12L	20000	No
24AHP4	[G]	Yes	FG	21 $\frac{1}{16}$ x 16 $\frac{7}{8}$	E	M	110	Cavity Cap	8HR	20000	No
24ATP4	[G]	Yes	FG	21 $\frac{1}{16}$ x 16 $\frac{7}{8}$	E	M	90	Cavity Cap	12L	20000 <sup>p</sup>	No
24AUP4	[G]	Yes	FG	21 $\frac{1}{16}$ x 16 $\frac{7}{8}$	E	M	90	Cavity Cap	12L	20000	No
24BAP4	[G]	Yes	FG	21 $\frac{1}{16}$ x 16 $\frac{7}{8}$	E	M	110	Cavity Cap	8HR	20000	No
24CP4A	[G]	Yes	FG	21 $\frac{1}{16}$ x 16 $\frac{7}{8}$	M	M	90	Cavity Cap	12N	22000	Yes
27MP4	[M]	Yes	FFG	23 $\frac{3}{8}$ x 18 $\frac{1}{8}$	M	M	90	Metal-Shell Lip	12D	18000	Yes
27RP4	[G]	Yes	FG	24 $\frac{1}{4}$ x 18 $\frac{5}{8}$	M	M	90	Cavity Cap	12N	20000	Yes
27XP4	[G]	Yes	FG	24 $\frac{1}{4}$ x 18 $\frac{5}{8}$	E	M	90	Cavity Cap	12L	23000 <sup>h</sup>	No

<b>Color Types</b>											
15GP22 <sup>r</sup>	[G]	Yes	CL	11 $\frac{1}{2}$ x 8 $\frac{3}{8}$	E	M	45°	Metal Flange	20A	20000	No
21AXP22A <sup>r</sup>	[M]	Yes	FG	19 $\frac{1}{8}$ x 15 $\frac{1}{4}$	E	M	70°	Metal Shell	14AH	25000	No
21CYP22A <sup>v</sup>	[G]	Yes	FG	19 $\frac{1}{4}$ x 15 $\frac{1}{4}$	E	M	70°	Two Cavity Caps	14AL	25000	No
21FBP22 <sup>r</sup>	[G]	Yes	FG	19 $\frac{1}{4}$ x 15 $\frac{1}{4}$	E	M	70°	Cavity Cap	14AU	27500 <sup>h</sup>	No
21FJP22 <sup>r</sup>	[G] <sup>v</sup>	Yes	FG <sup>r</sup>	19 $\frac{1}{4}$ x 15 $\frac{1}{4}$	E	M	70°	Cavity Cap	14AU	27500 <sup>h</sup>	No

### Key to Notes

- |   |  |  |   |  |
|---|--|--|---|--|
| <p><b>d</b> Projection type.</p> <p><b>e</b> Horizontal deflection angle.</p> <p><b>f</b> Typical deflection factors (volts dc/in.) for ultor voltage of 6000 volts:</p> <table border="1" style="display: inline-table; margin-right: 20px;"> <tr> <td>D<sub>1</sub> &amp; D<sub>2</sub> (nearer screen):<br/>100 to 240</td> <td>D<sub>1</sub> &amp; D<sub>2</sub> (nearer base):<br/>150 to 290</td> </tr> </table> <p><b>g</b> 8.4-volt, 450-milliamper heater.</p> | D <sub>1</sub> & D <sub>2</sub> (nearer screen):<br>100 to 240 | D <sub>1</sub> & D <sub>2</sub> (nearer base):<br>150 to 290 | <p><b>h</b> Design-Maximum Value.</p> <p><b>i</b> 2.68-volt, 450-milliamper heater.</p> <p><b>k</b> 6.3-volt, 450-milliamper heater.</p> <p><b>m</b> Cylindrical faceplate.</p> <p><b>n</b> Bipanel type.</p> <p><b>p</b> Referred to Grid No. 1: Cathode-Drive Service.</p> <p><b>r</b> Treated to reduce specular reflection.</p> | <p><b>q</b> 2.35-volt, 600-milliamper heater.</p> <p><b>s</b> This type has a flat, aluminized, filterglass, phosphor-dot screen plate.</p> <p><b>t</b> 6.3-volt, 1.8-ampere heater (three heaters paralleled internally).</p> <p><b>v</b> 6.3-volt, 1.6-ampere heater (three heaters paralleled internally).</p> <p><b>w</b> This type has an integral protective window.</p> |
| D <sub>1</sub> & D <sub>2</sub> (nearer screen):<br>100 to 240  | D <sub>1</sub> & D <sub>2</sub> (nearer base):<br>150 to 290   |  |   |  |

## Basing Diagrams for RCA Picture Tubes

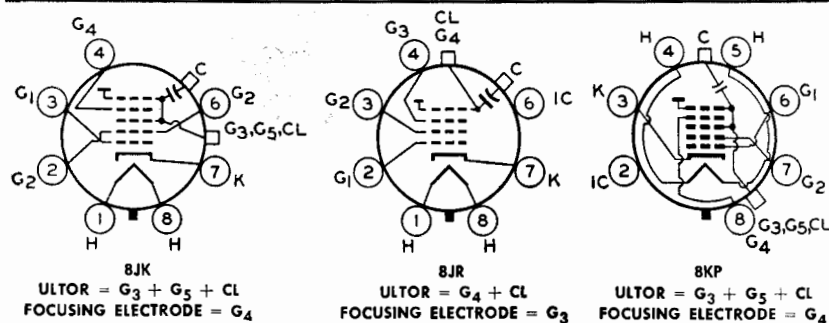

(More diagrams on next page)

Basing Diagrams for RCA Picture Tube (cont'd)

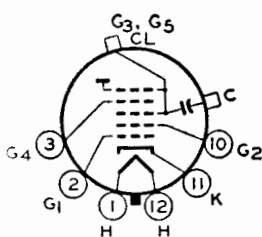

12AB  
ULTOR =  $G_3 + G_5 + CL$   
FOCUSING ELECTRODE =  $G_4$

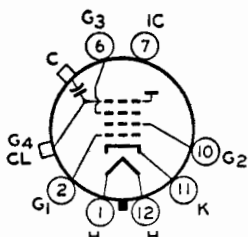

12C  
ULTOR =  $G_4 + CL$   
FOCUSING ELECTRODE =  $G_3$

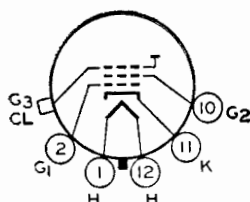

12D  
ULTOR =  $G_3 + CL$

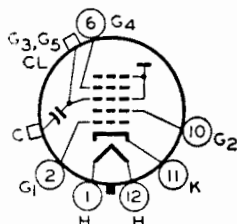

12L  
ULTOR =  $G_3 + G_5 + CL$   
FOCUSING ELECTRODE =  $G_4$

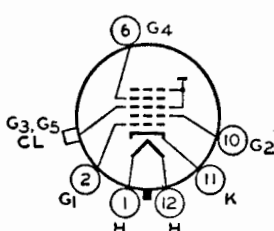

12M  
ULTOR =  $G_3 + G_5 + CL$   
FOCUSING ELECTRODE =  $G_4$

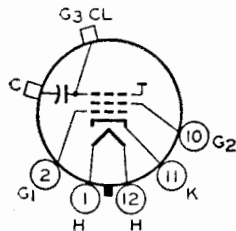

12N  
ULTOR =  $G_3 + CL$

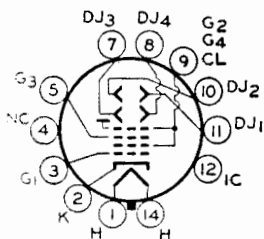

14R  
ULTOR =  $G_2 + G_4 + CL$   
FOCUSING ELECTRODE =  $G_3$

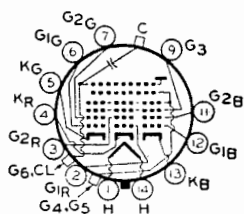

14AL

(14AL)  
CAP OVER PIN No. 1:  
ULTOR =  $G_4 + G_5$   
CAP OVER PIN No. 2:  
 $G_6 + CL$  & HIGH-VOLTAGE  
TERMINAL. Connect High-Volt-  
age Supply to this Cap and also  
connect 50,000 - ohm resistor  
between this Cap and the Cap  
over Pin No. 1 (Ultor Cap).  
FOCUSING ELECTRODE =  $G_3$

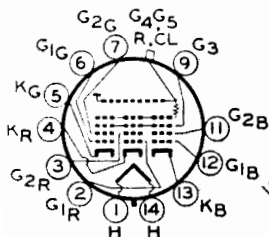

14AH  
ULTOR =  $G_4 + G_5 + CL + R$   
FOCUSING ELECTRODE =  $G_3$

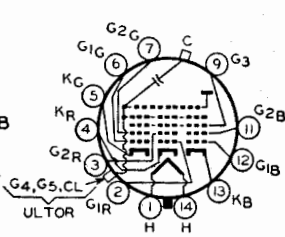

14AU

ULTOR =  $G_4 + G_5 + CL$   
FOCUSING ELECTRODE =  $G_3$

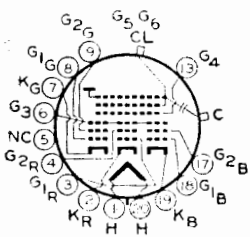

20A

ULTOR =  $G_5 + G_6 + CL$   
FOCUSING ELECTRODE =  $G_3$



# Electron Tube Testing

The electron tube user—service man, experimenter, or non-technical radio listener—is interested in knowing the condition of his tubes, since they govern the performance of the device in which they are used. In order to determine the condition of a tube, some method of test is necessary. Because the operating capabilities and design features of a tube are indicated and described by its electrical characteristics, a tube is tested by measuring its characteristics and comparing them with values established as standard for that type. Tubes which read abnormally high with respect to the standard for the type are subject to criticism just the same as tubes which are too low.

Certain practical limitations are placed on the accuracy with which a tube test can be correlated with actual tube performance. These limitations make it impractical for the service man and dealer to employ complex and costly testing equipment having laboratory accuracy. Because the accuracy of the tube-testing device need be no greater than the accuracy of the correlation between test results and receiver performance, and since certain fundamental characteristics are virtually fixed by the manufacturing technique of leading tube manufacturers, it is possible to employ a relatively simple test in order to determine the serviceability of a tube.

In view of these factors, dealers and service men will find it economically expedient to obtain adequate accuracy and simplicity of operation by employing a device which indicates the status of a single characteristic. Whether the tube is satisfactory or unsatisfactory is judged from the test result of this single characteristic. Consequently, it is very desirable that the characteristic selected for the test be one which is truly representative of the tube's over-all condition.

The following information and circuits are given to describe and illustrate general theoretical and practical tube-tester considerations and not to provide information on the construction of a home-made tube tester. In addition to the problem of determining what tube characteristic is most representative of performance capabilities in all types of receivers, the designer of a home-made tester faces the difficult problem of de-

termining satisfactory limits for his particular tester. Getting information of this nature, if it is to be accurate and useful, is a big job. It requires the testing of many tubes of each type, testing of many types, and correlation of the data with performance in many kinds of equipment.

## Short-Circuit Test

The fundamental circuit of a short-circuit tester is shown in Fig. 100. Although this circuit is suitable for tetrodes and types having less than four electrodes, tubes of more electrodes may be tested by adding more indicator lamps to the circuit. Voltages are applied between the various electrodes with lamps in series with the electrode leads. The value of the voltages applied will depend

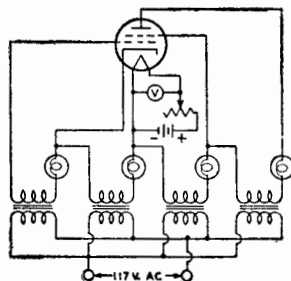

Fig. 100

on the type of tube being tested and its maximum ratings. Any two shorted electrodes complete a circuit and light one or more lamps. Since two electrodes may be just touching to give a high-resistance short, it is desirable that the indicating lamps operate on very low current. It is also desirable to maintain the filament or heater of the tube at its operating temperature during the short-circuit test, because short-circuits in a tube may sometimes occur only when the electrodes are heated. However, a short-circuit tester having too high a sensitivity may indicate very-high-resistance shorts that do not adversely affect tube operation.

## Selection of a Suitable Characteristic for Test

Some characteristics of a tube are far more important in determining its operating worth than are others. The cost of building a device to measure any one of the more important characteristics may be considerably higher than that of a device which measures a less representa-

tive characteristic. Consequently, three methods of test will be discussed, ranging from relatively simple and inexpensive equipment to more elaborate, more accurate, and more costly devices.

An **emission test** is perhaps the simplest method of indicating a tube's condition. (Refer to *Diodes*, in **ELECTRONS, ELECTRODES, AND ELECTRON TUBES SECTION**, for a discussion of electron emission.) Since emission falls off as the tube wears out, low emission is indicative of the end of tube serviceability. However, the emission test is subject to limitations because it tests the tube under static conditions and does not take into account the actual operation of the tube. On the one hand, coated filaments, or cathodes, often develop active spots from which the emission is so great that the relatively small grid area adjacent to these spots cannot control the electron stream. Under these conditions, the total emission may indicate the tube to be normal although the tube is unsatisfactory. On the other hand, coated types of filaments are capable of such large emission that the tube will often operate satisfactorily after the emission has fallen far below the original value.

Fig. 101 shows the fundamental circuit diagram for an emission test. All of the electrodes of the tube, except the

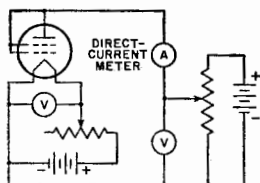

Fig. 101

cathode, are connected to the plate. The filament, or heater, is operated at rated voltage; after the tube has reached constant temperature, a low positive voltage is applied to the plate and the electron emission is read on the meter. Readings which are well below the average for a particular tube type indicate that the total number of available electrons has been so reduced that the tube is no longer able to function properly.

A **transconductance test** takes into account a fundamental operating principle of the tube. (This fact will be seen from the definition of transconduct-

ance in the Section on **ELECTRON TUBE CHARACTERISTICS**.) It follows that transconductance tests, when properly made, permit better correlation between test results and actual performance than does a straight emission test.

There are two forms of transconductance test which can be utilized in a tube tester. In the first form (illustrated by Fig. 102 giving a fundamental circuit with a tetrode under test), appropriate operating voltages are applied to the

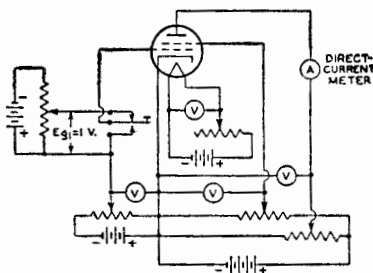

Fig. 102

electrodes of the tube. A plate current depending upon the electrode voltages will then be indicated by the meter. If the bias on the grid is then shifted by the application of a different grid voltage, a new plate-current reading is obtained. The difference between the two plate-current readings is indicative of the transconductance of the tube. This method of transconductance testing is commonly called the "grid-shift" method, and depends on readings under static conditions. The fact that this form of test is made under static conditions imposes limitations not encountered in the second form of test made under dynamic conditions.

The dynamic transconductance test illustrated in Fig. 103 gives a fundamental circuit with a tetrode under test. This method is superior to the static transconductance test in that ac voltage is applied to the grid. Thus, the tube is tested under conditions which approximate actual operating conditions. The alternating component of the plate current is read by means of an ac ammeter of the dynamometer type. The transconductance of the tube is equal to the ac plate current divided by the input-signal voltage. If a one-volt rms signal is applied to the grid, the plate-current-meter reading in milliamperes multi-

plied by one thousand is the value of transconductance in micromhos.

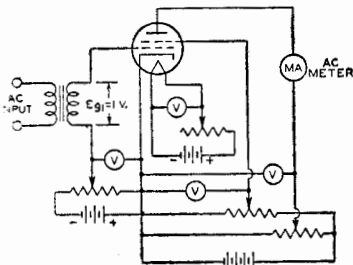

Fig. 103

The power-output test probably gives the best correlation between test results and actual operating performance of a tube. In the case of voltage amplifiers, the power output is indicative of the amplification and output voltages obtainable from the tube. In the case of power-output tubes, the performance of the tube is closely checked. Consequently, although more complicated to set up, the power-output test will give closer correlation with actual performance than any other single test.

Fig. 104 shows the fundamental circuit of a power-output test for class A

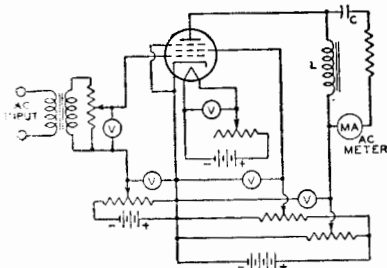

Fig. 104

operation of tubes. The diagram illustrates the method for a pentode. The ac output voltage developed across the plate-load impedance (L) is indicated by the current meter. The current meter is isolated as far as the dc plate current is concerned by the capacitor (C). The power output can be calculated from the current reading and known load resistance. In this way, it is possible to determine the operating condition of the tube quite accurately.

Fig. 105 shows the fundamental circuit of a power-output test for class B

operation of tubes, the current in the plate circuit is read on a dc milliammeter. The power output of the tube is approximately equal to:

$$(I_b^2 \times R_L) / 0.405,$$

where  $P_o$  is the power output in watts,  $I_b$  is the dc current in amperes, and  $R_L$  is the load resistance in ohms.

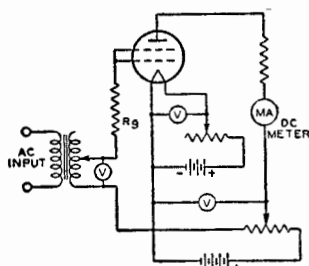

Fig. 105

### Essential Tube-Tester Requirements

1. The tester should provide for making a short-circuit test before measurement of the tube's characteristics.
2. It is important that some means of controlling the voltages applied to the electrodes of the tube be provided. If the tester is ac operated, a line-voltage control permits the supply of proper electrode voltages.
3. It is essential that the rated voltage applied to the filament or heater be maintained accurately.
4. It is suggested that the characteristics test follow one of the methods described. The method selected and the quality of the parts used in the test will depend upon the user's requirements.

### Tube-Tester Limitations

A tube-testing device can only indicate the difference between a given tube's characteristics and those which are standard for that particular type. Since the operating conditions imposed upon a tube of a given type may vary within wide limits, it is impossible for a tube-testing device to evaluate tubes in terms of performance capabilities for all applications. The tube tester, therefore, cannot be looked upon as a final authority in determining whether or not a tube is always satisfactory. Actual operating test in the equipment in which the tube is to be used will give the best possible indication of a tube's worth.

# Resistance-Coupled Amplifiers

Resistance-coupled, audio-frequency voltage amplifiers utilize simple components and are capable of providing essentially uniform amplification over a relatively wide frequency range.

## Suitable Tubes

In this section, data are given for over 50 types of tubes suitable for use in resistance-coupled circuits. These types include low- and high- $\mu$  triodes, twin triodes, triode-connected pentodes, and pentodes. The accompanying key to tube types will assist in locating the appropriate data chart.

## Circuit Advantages

For most of the types shown, the data pertain to operation with cathode bias; for all of the pentodes, the data pertain to operation with series screen-grid resistor. The use of a cathode-bias resistor where feasible and a series screen-grid resistor where applicable offers several advantages over fixed-voltage operation.

The advantages are: (1) effects of possible tube differences are minimized; (2) operation over a wide range of plate-supply voltages without appreciable change in gain is feasible; (3) the low frequency at which the amplifier cuts off is easily changed; and (4) tendency toward motorboating is minimized.

## Number of Stages

These advantages can be enhanced by the addition of suitable decoupling filters in the plate supply of each stage of a multi-stage amplifier. With proper filters, three or more amplifier stages can be operated from a single power-supply unit of conventional design without encountering any difficulties due to coupling through the power unit. When decoupling filters are not used, not more than two stages should be operated from a single power-supply unit.

Type	Chart No.	Type	Chart No.
1S5	1	6CF6	13
1U4	2	6CG7	6
1U5	1	6CN7	3
3AU6	4	6EU7	7
3AV6	7	6J5	6
3BC5	13	6J5-GT	6
3CB6	12	6SH7	4
3CF6	13	6SL7-GT	3
4AU6	4	6SN7-GTB	6
4BC5	13	6T8	3
4BQ7-A	12	6T8-A	3
4BZ7	12	7AU7	5
4CB6	13	8CG7	6
5BK7-A	12	12AT6	3
5BQ7-A	12	12AT7	10
5T8	3	12AU6	4
6AB4	10	12AU7-A	5
6AG5	13	12AV6	7
6AQ6	3	12AX7	7
6AT6	3	12AX7-A	7
6AU6	4	12AY7	11
6AU6-A	4	12SL7-GT	3
6AV6	7	12SN7-GT	6
6BC5	13	12SN7-GTA	6
6BK7-B	12	19T8	3
6BQ7-A	12	20EZ7	7
6BZ7	12	5879P	8
6C4	5	5879T	9
6CB6	13	7025	7
6CB6-A	13	7199P	14
		7199T	15

T=Triode Unit or Triode Connection  
P=Pentode Unit or Pentode Connection

## KEY TO CHARTS

## Symbols Used in Resistance-Coupled Amplifier Charts

- C = Blocking Capacitor ( $\mu\text{f}$ ).
- $C_k$  = Cathode Bypass Capacitor ( $\mu\text{f}$ ).
- $C_{g2}$  = Screen-Grid Bypass Capacitor ( $\mu\text{f}$ ).
- $E_{bb}$  = Plate-Supply Voltage (volts).  
Voltage at plate equals plate-supply voltage minus drop in  $R_p$  and  $R_k$ .
- $R_k$  = Cathode Resistor (ohms).
- $R_{g2}$  = Screen-Grid Resistor (megohms).
- $R_g$  = Grid Resistor (megohms) for following stage.
- $R_p$  = Plate Resistor (megohms).
- V.G. = Voltage Gain.
- $E_o$  = Output Voltage (peak volts).  
This voltage is obtained across  $R_g$  (for following stage) at any frequency within the flat region of the output vs. frequency curve, and is for the condition where the signal level is adequate to swing the grid of the resistance-coupled amplifier tube to the point where its grid starts to draw current.

## General Circuit Considerations

In the discussions which follow, the frequency ( $f_2$ ) is that value at which the high-frequency response begins to fall off. The frequency ( $f_1$ ) is that value at which the low-frequency response drops

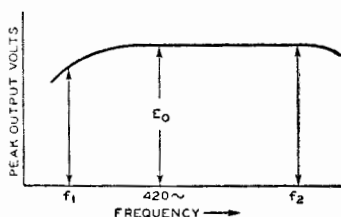

below a satisfactory value, as discussed below. A variation of 10 per cent in values of resistors and capacitors has only slight effect on performance. One-half-watt resistors are usually suitable for  $R_{g2}$ ,  $R_g$ ,  $R_p$ , and  $R_k$  resistors. Capacitors C and  $C_{g2}$  should have a working voltage equal to or greater than  $E_{bb}$ . Capacitor  $C_k$  may have a low working voltage in the order of 10 to 25 volts.

Note: The listed values for  $E_o$  are the peak output voltages available when the grid is driven from a low-impedance source. The listed values for the cathode resistors are optimum for any signal source. With a high-impedance source, protection against severe distortion and loss of gain due to input loading may be obtained by the use of a coupling capacitor connected directly to the input grid and a high-value resistor connected between the grid and ground.

## Triode Amplifier Heater-Cathode Type

Capacitors C and  $C_k$  have been chosen to give an output voltage equal to  $0.8 E_o$  for a frequency ( $f_1$ ) of 100 cycles. For any other value of  $f_1$ , multiply values of C and  $C_k$  by  $100/f_1$ . In the

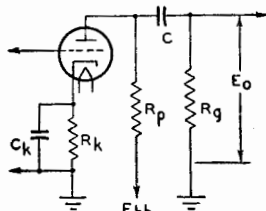

Diagram No. 1

case of capacitor  $C_k$ , the values shown in the charts are for an amplifier with dc heater excitation; when ac is used, depending on the character of the associated circuit, the gain, and the value of  $f_1$ , it may be necessary to increase the value of C to minimize hum disturbances. It may be desirable to operate the heater at a positive voltage of from 15 to 40 volts with respect to the cathode. The voltage output at  $f_1$  of "n" like stages equals  $(0.8)^n \times E_o$ , where  $E_o$  is the peak output voltage of final stage. For an amplifier of typical construction, the value of  $f_2$  is well above the audio-frequency range for any value of  $R_p$ .

## Pentode Amplifier Filament-Type

Capacitors C and  $C_{g2}$  have been chosen to give an output voltage equal to  $0.8 \times E_o$  for a frequency ( $f_1$ ) of 100 cycles. For any other value of  $f_1$ , multiply values of C and  $C_{g2}$  by  $100/f_1$ . The voltage output at  $f_1$  for "n" like stages equals  $(0.8)^n \times E_o$  where  $E_o$  is peak out-

put voltage of final stage. For an amplifier of typical construction, and for  $R_p$  values of 0.1, 0.25, and 0.5 megohm, approximate values of  $f_2$  are 20000, 10000, and 5000 cps, respectively. Note: The

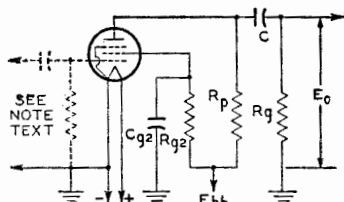

Diagram No. 2

values of input-coupling capacitor in microfarads and of grid resistor in megohms should be such that their product lies between 0.02 and 0.1. Values commonly used are 0.005  $\mu$ f and 10 megohms.

### Pentode Amplifier Heater-Cathode Type

Capacitors C,  $C_k$ , and  $C_{g2}$  have been chosen to give an output voltage equal to  $0.7 \times E_o$  for a frequency ( $f_1$ ) of 100 cycles. For any other value of  $f_1$ , multiply values of C,  $C_k$ , and  $C_{g2}$  by

$100/f_1$ . In the case of capacitor  $C_k$ , the values shown in the charts are for an amplifier with dc heater excitation; when

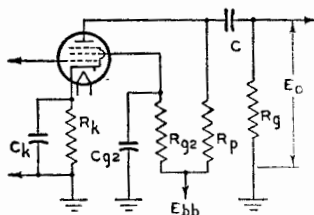

Diagram No. 3

ac is used, depending on the character of the associated circuits, the voltage gain, and the value of  $f_1$ , it may be necessary to increase the value of  $C_k$  to minimize hum disturbances. It may be desirable to operate the heater at a positive voltage of from 15 to 40 volts with respect to the cathode. The voltage output at  $f_1$  for "n" like stages equals  $(0.7)^n \times E_o$  where  $E_o$  is peak output voltage of final stage. For an amplifier of typical construction, and for  $R_p$  values of 0.1, 0.25, and 0.5 megohm, approximate values of  $f_2$  are 20000, 10000, and 5000 cps, respectively.

(See page 435 for explanation of column headings.)

1

1S5  
1U5

See Circuit  
Diagram 2

$E_{bb}$	$R_p$	$R_g$	$R_{g2}$	$R_k$	$C_{g2}$	$C_k$	C	$E_o^*$	V.G.
45	0.22	0.22	0.26	-	0.042	-	0.013	14	17
		0.47	0.36	-	0.035	-	0.006	17	24
		1.0	0.4	-	0.034	-	0.004	18	28
	0.47	0.47	0.82	-	0.025	-	0.0055	14	25
		1.0	1.0	-	0.023	-	0.003	17	33
		2.2	1.1	-	0.022	-	0.002	18	38
	1.0	1.0	1.9	-	0.019	-	0.003	14	31
		2.2	2.0	-	0.019	-	0.002	17	38
		3.3	2.2	-	0.018	-	0.0015	18	43
90	0.22	0.22	0.5	-	0.05	-	0.011	31	25
		0.47	0.59	-	0.05	-	0.006	37	34
		1.0	0.67	-	0.042	-	0.003	40	41
	0.47	0.47	1.2	-	0.035	-	0.005	31	37
		1.0	1.4	-	0.034	-	0.003	35	47
		2.2	1.6	-	0.031	-	0.002	40	57
	1.0	1.0	2.5	-	0.026	-	0.003	31	45
		2.2	2.9	-	0.025	-	0.002	36	58
		3.3	3.1	-	0.024	-	0.0012	38	66
135	0.22	0.22	0.66	-	0.052	-	0.011	45	31
		0.47	0.71	-	0.051	-	0.006	56	41
		1.0	0.86	-	0.039	-	0.003	60	54
	0.47	0.47	1.45	-	0.042	-	0.005	46	44
		1.0	1.8	-	0.034	-	0.003	54	62
		2.2	1.9	-	0.033	-	0.002	60	71
	1.0	1.0	3.1	-	0.03	-	0.003	45	56
		2.2	3.7	-	0.029	-	0.0015	53	76
		3.3	4.3	-	0.026	-	0.0014	56	88

\*Peak volts.

## Resistance-Coupled Amplifiers

(See page 435 for explanation of column headings)

E <sub>bb</sub>	R <sub>p</sub>	R <sub>g</sub>	R <sub>g2</sub>	R <sub>k</sub>	C <sub>g2</sub>	C <sub>k</sub>	C	E <sub>o</sub> *	V.G.
45	0.22	0.22	0.06	-	0.046	-	0.011	11	23
		0.47	0.07	-	0.045	-	0.006	15	33
		1.0	0.011	-	0.04	-	0.003	17	39
	0.47	0.47	0.34	-	0.025	-	0.005	13	34
		1.0	0.44	-	0.022	-	0.003	16	46
		2.2	0.5	-	0.022	-	0.002	18	55
1.0	1.0	1.0	-	0.016	-	0.003	14	43	
	2.2	1.0	-	0.016	-	0.002	17	51	
	3.3	1.1	-	0.015	-	0.001	17	60	
90	0.22	0.22	0.3	-	0.046	-	0.01	27	37
		0.47	0.36	-	0.04	-	0.006	36	54
		1.0	0.4	-	0.038	-	0.003	39	63
	0.47	0.47	0.9	-	0.027	-	0.0045	29	61
		1.0	1.0	-	0.023	-	0.003	35	82
		2.2	1.1	-	0.022	-	0.002	38	96
	1.0	1.0	1.9	-	0.02	-	0.0025	30	77
		2.2	2.0	-	0.02	-	0.002	35	98
		3.3	2.2	-	0.018	-	0.001	37	114
135	0.22	0.22	0.4	-	0.052	-	0.011	44	46
		0.47	0.49	-	0.037	-	0.005	55	71
		1.0	0.52	-	0.034	-	0.003	60	83
	0.47	0.47	1.1	-	0.029	-	0.0045	45	77
		1.0	1.3	-	0.023	-	0.003	53	106
		2.2	1.4	-	0.022	-	0.002	59	123
	1.0	1.0	2.3	-	0.021	-	0.0025	45	104
		2.2	2.5	-	0.019	-	0.0015	53	136
		3.3	2.9	-	0.016	-	0.001	56	163

2

1U4

See Circuit  
Diagram 2

90	0.1	0.1	-	4200	-	2.5	0.025	5.4	22
		0.22	-	4600	-	2.2	0.014	7.5	27
		0.47	-	4800	-	2.0	0.0065	9.1	30
	0.22	0.22	-	7000	-	1.5	0.013	7.3	30
		0.47	-	7800	-	1.3	0.007	10	34
		1.0	-	8100	-	1.1	0.0035	12	37
0.47	0.47	-	12000	-	0.83	0.006	10	36	
	1.0	-	14000	-	0.7	0.0035	14	39	
	2.2	-	15000	-	0.6	0.002	16	41	
180	0.1	0.1	-	1900	-	3.6	0.027	19	30
		0.22	-	2200	-	3.1	0.014	25	35
		0.47	-	2500	-	2.8	0.0065	32	37
	0.22	0.22	-	3400	-	2.2	0.014	24	38
		0.47	-	4100	-	1.7	0.0065	34	42
		1.0	-	4600	-	1.5	0.0035	38	44
0.47	0.47	-	6600	-	1.1	0.0065	29	44	
	1.0	-	8100	-	0.9	0.0035	38	46	
	2.2	-	9100	-	0.8	0.002	43	47	
300	0.1	0.1	-	1500	-	4.4	0.027	40	34
		0.22	-	1800	-	3.6	0.014	54	38
		0.47	-	2100	-	3.0	0.0065	63	41
	0.22	0.22	-	2600	-	2.5	0.013	51	42
		0.47	-	3200	-	1.9	0.0065	65	46
		0.1	-	3700	-	1.6	0.0035	77	48
	0.47	0.47	-	5200	-	1.2	0.006	61	48
		1.0	-	6300	-	1.0	0.0035	74	50
		2.2	-	7200	-	0.9	0.002	85	51

3

5T8  
6AQ6  
6AT6  
6CN7  
6SL7-GT\*  
6T8  
6T8-A  
12AT6  
12SL7-GT\*  
19T8

See Circuit  
Diagram 1

• One triode unit. \* Peak volts.

(See page 435 for explanation of column headings)

**4**

**3AU6  
4AU6  
6AU6  
6AU6-A  
6SH7  
12AU6  
12SH7**

See Circuit  
Diagram 3

E <sub>bb</sub>	R <sub>p</sub>	R <sub>g</sub>	R <sub>g2</sub>	R <sub>k</sub>	C <sub>g2</sub>	C <sub>k</sub>	C	E <sub>o</sub> *	V.G.
90	0.22	0.22	0.340	2700	0.057	5.8	0.0081	16	79
		0.47	0.370	2900	0.050	5.4	0.0055	22	104
		1.0	0.380	3100	0.050	5.3	0.0034	25	125
	0.47	0.47	1.00	6000	0.027	2.8	0.0042	13	105
		1.0	1.00	6200	0.023	2.7	0.0027	17	137
		2.2	1.00	6300	0.027	2.8	0.0019	25	161
1.0	1.0	1.90	10800	0.017	1.7	0.0025	10	139	
	2.2	2.40	13100	0.017	1.7	0.0017	19	184	
180	0.22	0.22	0.520	1340	0.059	8.8	0.0081	31	143
		0.47	0.520	1390	0.059	8.7	0.0053	43	192
		1.0	0.520	1420	0.059	8.6	0.0032	48	223
	0.47	0.47	1.05	2700	0.039	5.5	0.0041	34	189
		1.0	1.15	2880	0.037	5.4	0.0027	43	249
		2.2	1.20	2960	0.036	5.4	0.0019	50	294
	1.0	1.0	2.40	5500	0.028	3.2	0.0023	33	230
		2.2	2.70	6000	0.022	2.8	0.0015	40	323
300	0.22	0.22	0.530	780	0.077	13.2	0.0082	53	200
		0.47	0.540	783	0.077	13.2	0.0053	65	270
		1.0	0.540	800	0.077	13.1	0.0033	74	316
	0.47	0.47	1.15	1590	0.057	8.4	0.0045	56	275
		1.0	1.22	1650	0.049	7.4	0.0027	72	357
		2.2	1.31	1720	0.045	7.2	0.0017	82	418
	1.0	1.0	2.50	3300	0.036	5.3	0.0022	57	352
		2.2	2.80	3500	0.031	4.2	0.0015	72	466

**5**

**6C4  
7AU7\*  
12AU7-A\***

See Circuit  
Diagram 1

90	0.047	0.047	-	1600	-	3.2	0.061	9	10
		0.1	-	1840	-	2.5	0.033	11	11
		0.22	-	2000	-	2.0	0.015	14	11
	0.1	0.1	-	3000	-	1.6	0.032	10	11
		0.22	-	3800	-	1.1	0.015	15	11
		0.47	-	4500	-	1.0	0.007	18	11
0.22	0.22	-	6800	-	0.7	0.015	14	11	
	0.47	-	9500	-	0.5	0.0065	20	11	
	1.0	-	11500	-	0.43	0.0035	24	11	
180	0.047	0.047	-	920	-	3.9	0.062	20	11
		0.1	-	1200	-	2.9	0.037	26	12
		0.22	-	1400	-	2.5	0.016	29	12
	0.1	0.1	-	2000	-	1.9	0.032	24	12
		0.22	-	2800	-	1.4	0.016	33	12
		0.47	-	3600	-	1.1	0.007	40	12
	0.22	0.22	-	5300	-	0.8	0.015	31	12
		0.47	-	8300	-	0.56	0.007	44	12
		1.0	-	10000	-	0.48	0.0035	54	12
300	0.047	0.047	-	870	-	4.1	0.065	38	12
		0.1	-	1200	-	3.0	0.034	52	12
		0.22	-	1500	-	2.4	0.016	68	12
	0.1	0.1	-	1900	-	1.9	0.032	44	12
		0.22	-	3000	-	1.3	0.016	68	12
		0.47	-	4000	-	1.1	0.007	80	12
	0.22	0.22	-	5300	-	0.9	0.015	57	12
		0.47	-	8800	-	0.52	0.007	82	12
		1.0	-	11000	-	0.46	0.0035	92	12

• One triode unit. \* Peak volts.



## Resistance-Coupled Amplifiers

(See page 435 for explanation of column headings)

Ebb	R <sub>p</sub>	R <sub>g</sub>	R <sub>g2</sub>	R <sub>k</sub>	C <sub>g2</sub>	C <sub>k</sub>	C	E <sub>o</sub> *	V.G.
90	0.047	0.047	-	1870	-	3.1	0.063	14	13
		0.1	-	2230	-	2.5	0.031	18	14
		0.22	-	2500	-	2.1	0.016	20	14
	0.1	0.1	-	3370	-	1.8	0.034	15	14
		0.22	-	4100	-	1.3	0.015	20	14
		0.47	-	4800	-	1.1	0.006	23	15
	0.22	0.22	-	7000	-	0.80	0.013	16	14
		0.47	-	9100	-	0.65	0.007	22	14
		1.00	-	10500	-	0.60	0.004	25	15
180	0.047	0.047	-	1500	-	3.6	0.066	33	14
		0.1	-	1860	-	2.9	0.055	41	14
		0.22	-	2160	-	2.2	0.015	47	15
	0.1	0.1	-	2750	-	1.8	0.028	35	15
		0.22	-	3550	-	1.4	0.015	45	15
		0.47	-	4140	-	1.3	0.007	51	16
	0.22	0.22	-	5150	-	1.0	0.016	36	16
		0.47	-	7000	-	0.71	0.007	45	16
		1.00	-	7800	-	0.61	0.004	51	16
300	0.047	0.047	-	1300	-	3.6	0.061	59	14
		0.1	-	1580	-	3.0	0.032	73	15
		0.22	-	1800	-	2.5	0.015	83	16
	0.1	0.1	-	2500	-	1.9	0.031	68	16
		0.22	-	3130	-	1.4	0.014	82	16
		0.47	-	3900	-	1.2	0.0065	96	16
	0.22	0.22	-	4800	-	0.95	0.015	68	16
		0.47	-	6500	-	0.69	0.0065	85	16
		1.00	-	7800	-	0.58	0.0035	96	16
90	0.1	0.1	-	4400	-	2.7	0.023	5	29
		0.22	-	4700	-	2.4	0.013	6	35
		0.47	-	4800	-	2.3	0.007	8	41
	0.22	0.22	-	7000	-	1.6	0.001	6	39
		0.47	-	7400	-	1.4	0.006	9	45
		1.0	-	7600	-	1.3	0.003	11	48
	0.47	0.47	-	12000	-	0.9	0.006	9	48
		1.0	-	13000	-	0.8	0.003	11	52
		2.2	-	14000	-	0.7	0.002	13	55
180	0.1	0.1	-	1800	-	4.0	0.025	18	40
		0.22	-	2000	-	3.5	0.013	25	47
		0.47	-	2200	-	3.1	0.006	32	52
	0.22	0.22	-	3000	-	2.4	0.012	24	53
		0.47	-	3500	-	2.1	0.006	34	59
		1.0	-	3900	-	1.8	0.003	39	63
	0.47	0.47	-	5800	-	1.3	0.006	30	62
		1.0	-	6700	-	1.1	0.003	39	66
		2.2	-	7400	-	1.0	0.002	45	68
300	0.1	0.1	-	1300	-	4.6	0.027	43	45
		0.22	-	1500	-	4.0	0.013	57	52
		0.47	-	1700	-	3.6	0.006	66	57
	0.22	0.22	-	2200	-	3.0	0.013	54	59
		0.47	-	2800	-	2.3	0.006	69	65
		1.0	-	3100	-	2.1	0.003	79	68
	0.47	0.47	-	4300	-	1.6	0.006	62	69
		1.0	-	5200	-	1.3	0.003	77	73
		2.2	-	5900	-	1.1	0.002	92	75

• One triode unit. \* Peak volts.

6

**6CG7\***  
**6J5**  
**6J5-GT**  
**6SN7-GTB\***  
**8CG7**  
**12SN7-GT\***  
**12SN7-GTA\***

See Circuit  
Diagram 1

7

**3AV6**  
**6AV6**  
**6EU7\***  
**12AV6**  
**12AX7\***  
**12AX7-A\***  
**20E27\***  
**7025\***

See Circuit  
Diagram 1

(See page 435 for explanation of column headings)

<b>E<sub>bb</sub></b>	<b>R<sub>p</sub></b>	<b>R<sub>g</sub></b>	<b>R<sub>g2</sub></b>	<b>R<sub>k</sub></b>	<b>C<sub>g2</sub></b>	<b>C<sub>k</sub></b>	<b>C</b>	<b>E<sub>o</sub>* </b>	<b>V.G.</b>	
<b>8</b>	90	0.1	0.1	0.35	1700	0.044	4.6	0.020	13	29
			0.22			0.046	4.5	0.012	17	39
			0.47			0.047	4.4	0.006	20	47
	90	0.22	0.22	0.80	3000	0.034	3.2	0.010	15	43
			0.47			0.035	3.1	0.005	21	59
			1.0			0.036	3.0	0.003	24	67
	90	0.47	0.47	1.9	7000	0.021	1.8	0.005	21	59
			1.0			0.022	1.7	0.003	25	75
			2.2			0.023	1.7	0.002	28	87
<b>180</b>	0.1	0.1	0.35	700	0.060	7.4	0.020	24	39	
		0.22			0.062	7.3	0.012	28	56	
		0.47			0.064	7.2	0.006	33	65	
	180	0.22	0.22	0.80	1200	0.045	5.5	0.010	24	65
			0.47			0.046	5.3	0.005	31	87
			1.0			0.048	5.2	0.003	34	101
180	0.47	0.47	1.9	2500	0.033	3.5	0.005	27	98	
		1.0			0.034	3.4	0.003	32	122	
		2.2			0.035	3.3	0.002	37	140	
<b>300</b>	0.1	0.1	0.35	300	0.075	10.8	0.020	25	51	
		0.22			0.077	10.6	0.012	32	68	
		0.47			0.080	10.5	0.006	35	83	
	300	0.22	0.22	0.80	600	0.056	7.9	0.010	28	81
			0.47			0.057	7.5	0.005	37	109
			1.0			0.058	7.4	0.003	41	123
300	0.47	0.47	1.3	1200	0.044	5.3	0.005	34	125	
		1.0			0.046	5.2	0.003	42	152	
		2.2			0.047	5.1	0.002	48	174	

See Circuit Diagram 3

**9**

As Triode:

**5879**

See Circuit Diagram 1

<b>90</b>	0.047	0.047	-	1800	-	2.9	0.060	9	10
		0.1	-	2100	-	2.4	0.033	12	11
		0.22	-	2200	-	2.3	0.016	14	21
	0.1	0.1	-	3200	-	1.8	0.027	10	12
		0.22	-	3900	-	1.3	0.015	13	13
		0.47	-	4300	-	1.0	0.007	16	13
<b>180</b>	0.22	0.22	-	6200	-	0.87	0.015	12	13
		0.47	-	8100	-	0.53	0.006	16	13
		1.00	-	9000	-	0.49	0.003	19	14
	0.047	0.047	-	1200	-	3.5	0.063	21	12
		0.1	-	1600	-	2.6	0.033	29	13
		0.22	-	1800	-	2.4	0.016	35	13
0.1	0.1	-	2200	-	1.9	0.031	26	13	
	0.22	-	2900	-	1.35	0.015	33	14	
	0.47	-	3400	-	1.1	0.007	40	14	
0.22	0.22	-	4500	-	0.92	0.015	28	14	
	0.47	-	6400	-	0.61	0.006	39	14	
	1.00	-	8200	-	0.52	0.003	47	14	
<b>300</b>	0.047	0.047	-	1100	-	3.9	0.063	42	13
		0.1	-	1500	-	2.8	0.033	65	13
		0.22	-	1700	-	2.5	0.016	71	14
	0.1	0.1	-	2000	-	2.1	0.032	45	15
		0.22	-	3400	-	1.4	0.015	74	15
		0.47	-	3700	-	1.1	0.007	83	15
0.22	0.22	-	4300	-	0.97	0.015	50	15	
	0.47	-	7200	-	0.63	0.007	88	15	
	1.00	-	7400	-	0.63	0.003	94	15	

\* Peak volts.

## Resistance-Coupled Amplifiers

(See page 435 for explanation of column headings)

Ebb	R <sub>p</sub>	R <sub>g</sub>	R <sub>g2</sub>	R <sub>k</sub>	C <sub>g2</sub>	C <sub>k</sub>	C	E <sub>o</sub> *	V.G.
90	0.1	0.1	-	2680	-	2.4	0.026	8	24
		0.22	-	3060	-	2.00	0.014	11	25
		0.47	-	3390	-	1.84	0.0074	13	28
	0.22	0.22	-	5500	-	1.33	0.0136	10	25
		0.47	-	6300	-	1.01	0.0067	14	28
		1.0	-	6930	-	0.92	0.0038	15	28
	0.47	0.47	-	10900	-	0.63	0.007	13	26
		1.0	-	12500	-	0.52	0.0043	14	28
		2.2	-	13500	-	0.47	0.0031	18	28
180	0.1	0.1	-	1407	-	3.6	0.029	20	31
		0.22	-	1674	-	3.0	0.016	28	33
		0.47	-	1786	-	2.6	0.0083	31	34
	0.22	0.22	-	2890	-	1.75	0.0140	24	33
		0.47	-	3860	-	1.34	0.0077	35	33
		1.0	-	4660	-	1.14	0.0047	42	33
	0.47	0.47	-	6960	-	0.83	0.0075	31	31
		1.0	-	8450	-	0.67	0.0046	39	32
		2.2	-	9600	-	0.55	0.0032	45	32
300	0.1	0.1	-	974	-	4.0	0.028	37	34
		0.22	-	1404	-	3.1	0.015	57	34
		0.47	-	2169	-	2.5	0.0083	78	33
	0.22	0.22	-	2510	-	1.9	0.015	50	33
		0.47	-	4200	-	1.3	0.0074	78	33
		1.0	-	4950	-	1.1	0.0046	85	32
	0.47	0.47	-	5700	-	0.90	0.0076	57	33
		1.0	-	8720	-	0.62	0.0041	81	32
		2.2	-	9700	-	0.57	0.0030	88	32
900	0.1	0.24	-	1800	-	- <sup>▲</sup>	-	13	24
	.24	0.51	-	3700	-	-	-	14	26
	0.51	1.0	-	7800	-	-	-	16	27
180	0.1	0.24	-	1300	-	-	-	31	27
	0.24	0.51	-	2800	-	-	-	33	29
	0.51	1.0	-	5700	-	-	-	33	30
300	0.1	0.24	-	1200	-	-	-	58	28
	0.24	0.51	-	2300	-	-	-	30	30
	0.51	1.0	-	4800	-	-	-	56	31

10

**6AB4  
12AT7\***

See Circuit  
Diagram 1

11

**12AY7\***

See Circuit  
Diagram 2

● One triode unit. \* Peak volts.

▲ Coupling capacitors should be selected to give desired frequency response. Cathode resistors should be adequately bypassed.

# RCA Receiving Tube Manual

(See page 435 for explanation of column headings)

12

**4BQ7-A\***  
**4BZ7\***  
**5BK7-A\***  
**5BQ7-A\***  
**6BK7-B\***  
**6BQ7-A\***  
**6BZ7\***

See Circuit Diagram 1

E <sub>bb</sub>	R <sub>p</sub>	R <sub>g</sub>	R <sub>g2</sub>	R <sub>k</sub>	C <sub>g2</sub>	C <sub>k</sub>	C	E <sub>o</sub> *	V.G.
90	0.047	0.047	-	1580	-	4.0	0.058	9	18
		0.10	-	1760	-	3.5	0.032	13	19
		0.22	-	1820	-	3.0	0.015	16	20
	0.1	0.1	-	2920	-	2.1	0.029	12	19
		0.22	-	3570	-	1.7	0.015	17	20
		0.47	-	4020	-	1.4	0.0075	20	20
0.22	0.22	-	6040	-	0.98	0.0135	16	19	
	0.47	-	7500	-	0.78	0.0075	21	20	
	1.0	-	8800	-	0.63	0.0036	25	20	
180	0.047	0.047	-	694	-	6.0	0.062	25	23
		0.1	-	817	-	4.4	0.032	32	24
		0.22	-	905	-	4.0	0.0155	35	25
	0.10	0.1	-	1596	-	2.80	0.030	30	23
		0.22	-	1630	-	2.30	0.0152	32	24
		0.47	-	1860	-	2.00	0.0073	38	24
	0.22	0.22	-	3950	-	1.24	0.0150	35	22
		0.47	-	4500	-	0.96	0.0072	41	23
		1.0	-	5530	-	0.79	0.0038	49	23
300	0.047	0.047	-	438	-	6.70	0.062	38	26
		0.1	-	542	-	5.50	0.032	48	27
		0.22	-	644	-	4.30	0.016	57	27
	0.10	0.10	-	1009	-	3.5	0.031	42	25
		0.22	-	1332	-	2.5	0.015	56	26
		0.47	-	1609	-	2.1	0.0074	64	25
	0.22	0.22	-	2623	-	1.5	0.015	50	24
		0.47	-	3900	-	1.1	0.0073	70	24
		1.0	-	4920	-	0.88	0.0039	84	24

13

**3BC5**  
**3CB6**  
**3CF6**  
**4BC5**  
**4CB6**  
**6AG5**  
**6BC5**  
**6CB6**  
**6CB6-A**  
**6CF6**

See Circuit Diagram 3

90	0.22	0.22	0.480	3800	0.046	5.5	0.0084	10	89
		0.47	0.480	3800	0.049	5.5	0.0054	16	114
		1.0	0.500	4400	0.045	5.3	0.0034	23	128
	0.47	0.47	1.04	7200	0.033	2.9	0.0044	10	111
		1.0	1.04	7700	0.033	2.8	0.0029	15	133
		2.2	1.10	8400	0.031	2.6	0.0020	18	152
1.0	1.0	2.50	16000	0.018	1.4	0.0023	10	118	
	2.2	2.50	18600	0.016	1.2	0.0017	11	139	
	0.22	0.22	0.550	1600	0.072	9.5	0.0090	30	161
0.47		0.620	1800	0.062	8.5	0.0053	36	208	
1.0		0.650	1900	0.062	8.5	0.0034	43	239	
180	0.47	0.47	1.00	3400	0.059	6.0	0.0048	34	183
		1.0	1.00	3500	0.059	6.0	0.0031	41	229
		2.2	1.00	3800	0.059	5.8	0.0020	46	262
	1.0	1.0	2.60	7300	0.029	2.7	0.0022	33	227
		2.2	2.60	7400	0.029	2.7	0.0016	38	281
		0.22	0.22	0.600	980	0.085	13.0	0.0085	51
0.47	0.680		1090	0.084	12.0	0.0055	64	288	
1.0	0.700		1150	0.081	11.0	0.0033	74	334	
300	0.47	0.47	1.25	2000	0.064	7.9	0.0045	52	285
		1.0	1.34	2150	0.061	7.6	0.0029	67	363
		2.2	1.53	2350	0.057	7.1	0.0019	79	416
	1.0	1.0	2.60	4000	0.044	5.2	0.0023	51	334
		2.2	3.00	4700	0.038	4.3	0.0015	69	427
		0.22	0.22	0.600	980	0.085	13.0	0.0085	51
0.47	0.680		1090	0.084	12.0	0.0055	64	288	
1.0	0.700		1150	0.081	11.0	0.0033	74	334	

● One triode unit. \* Peak volts.

## Resistance-Coupled Amplifiers

(See page 435 for explanation of column headings)

Ebb	R <sub>p</sub>	R <sub>g</sub>	R <sub>g2</sub>	R <sub>k</sub>	C <sub>g2</sub>	C <sub>k</sub>	C	E <sub>o</sub> *	V.G.
90	0.22	0.22	0.560	3700	0.046	4.50	0.0090	12	73
		0.47	0.600	3900	0.043	4.30	0.0055	17	95
		1.0	0.640	4200	0.039	4.00	0.0033	19	109
	0.47	0.47	0.870	6000	0.036	2.70	0.0046	16	95
		1.0	0.980	6700	0.044	3.00	0.0030	22	113
		2.2	1.00	6700	0.043	2.80	0.0020	25	131
	1.0	1.0	2.00	12200	0.021	1.44	0.0028	15	119
		2.2	2.20	12800	0.024	1.74	0.0016	21	167
	180	0.22	0.22	0.530	1570	0.069	7.50	0.0088	32
0.47			0.600	1730	0.064	7.40	0.0064	38	164
1.0			0.650	1820	0.061	7.30	0.0034	45	190
0.47		0.47	1.12	3200	0.053	5.30	0.0046	35	147
		1.0	1.40	3500	0.042	5.10	0.0028	40	209
		2.2	1.57	3740	0.040	5.40	0.0019	45	250
1.0		1.0	2.50	6500	0.039	2.80	0.0024	34	179
		2.2	3.40	7500	0.026	2.30	0.0015	39	277
300		0.22	0.22	0.600	9200	0.086	11.2	0.0085	52
	0.47		0.670	1010	0.076	10.5	0.0052	66	236
	1.0		0.720	1100	0.076	10.0	0.0033	77	257
	0.47	0.47	1.25	1950	0.060	7.0	0.0044	41	221
		1.0	1.43	3210	0.053	6.4	0.0027	72	296
		2.2	1.45	2200	0.055	6.3	0.0019	82	345
	1.0	1.0	3.00	4100	0.040	4.2	0.0022	57	295
		2.2	3.30	4340	0.037	3.6	0.0016	74	378

14

7199

Pentode  
Unit

See Circuit  
Diagram 3

90	0.047	0.047	-	1292	-	3.3	0.060	8	12
		0.1	-	1401	-	2.8	0.032	10	13
		0.22	-	1470	-	2.4	0.016	11	13
	0.10	0.1	-	2630	-	1.60	0.029	9	13
		0.22	-	3090	-	1.24	0.015	12	13
		0.47	-	3440	-	1.10	0.008	14	14
	0.22	0.22	-	6550	-	0.70	0.015	12	12
		0.47	-	8270	-	0.51	0.0077	16	12
		1.0	-	9130	-	0.44	0.0045	18	12
180	0.047	0.047	-	723	-	4.0	0.061	16	14
		0.1	-	836	-	3.5	0.032	20	14
		0.22	-	948	-	2.9	0.016	24	15
	0.10	0.1	-	1543	-	2.0	0.031	17	14
		0.22	-	2002	-	1.6	0.016	24	14
		0.47	-	2522	-	1.2	0.0082	30	13
	0.22	0.22	-	4390	-	0.79	0.015	24	13
		0.47	-	6122	-	0.57	0.0078	33	12
		1.0	-	8060	-	0.47	0.0046	41	12
300	0.047	0.047	-	534	-	4.0	0.061	27	15
		0.1	-	726	-	3.6	0.031	38	15
		0.22	-	840	-	3.0	0.015	44	15
	0.10	0.1	-	1117	-	2.3	0.031	26	15
		0.22	-	1613	-	1.7	0.0155	41	14
		0.47	-	2043	-	1.31	0.0078	51	14
	0.22	0.22	-	3133	-	0.93	0.015	36	13
		0.47	-	4480	-	0.69	0.0079	51	13
		1.0	-	4930	-	0.56	0.0045	55	13

15

7199

Triode Unit

See Circuit  
Diagram 1

\* Peak volts.

## Circuits

The circuits in this section include several representative broadcast receivers, a 144-Mc receiver and a 10-meter preamplifier for amateur use, two two-channel amplifiers for stereophonic use, five amplifier circuits ranging in power output from 1 watt to 50 watts, several preamplifier, mixer, and tone control circuits, a code-practice oscillator, an intercommunication set, and an electronic volt-ohm meter.

These circuits are included in this Manual to illustrate some of the more important applications of RCA receiving tubes; they are not necessarily examples of commercial practice. These circuits have been conservatively designed and are capable of excellent performance. Electrical specifications are given for circuit components to assist those interested in home construction. Layouts and mechanical details are omitted because they vary widely with the requirements of individual set builders and with the sizes and shapes of the components employed.

Performance of these circuits depends as much on the quality of the components selected and the care employed in layout and construction as on the circuits themselves. Good signal reproduction from receivers and amplifiers requires the use of good-quality speakers, transformers, chokes, and input sources (microphones, phonograph pickups, etc).

Coils for the receiver circuits may be purchased at local parts dealers by

specifying the characteristics required: for rf coils, the circuit position (antenna or interstage), tuning range desired, and tuning capacitances employed; for if coils or transformers, the intermediate frequency, circuit position (1st if, 2nd if, etc.), and, in some cases, the associated tube types; for oscillator coils, the receiver tuning range, intermediate frequency, type of converter tube, and type of winding (tapped or transformer-coupled).

The voltage ratings specified for capacitors are the minimum dc working voltages required. Paper, mica, or ceramic capacitors having higher voltage ratings than those specified may be used except insofar as the physical sizes of such capacitors may affect equipment layout. However, if electrolytic capacitors having substantially higher voltage ratings than those specified are used, they may not "form" completely at the operating voltage, with the result that the effective capacitances of such units may be below their rated value. The wattage ratings specified for resistors assume methods of construction that provide adequate ventilation; compact installations having poor ventilation may require resistors of higher wattage ratings.

Information on the characteristics and application features of each tube will be found in the TUBE TYPES SECTION. This information will prove of assistance in understanding and utilizing the circuits.

(21-1)

## PORTABLE BATTERY-OPERATED SUPERHETERODYNE RECEIVER

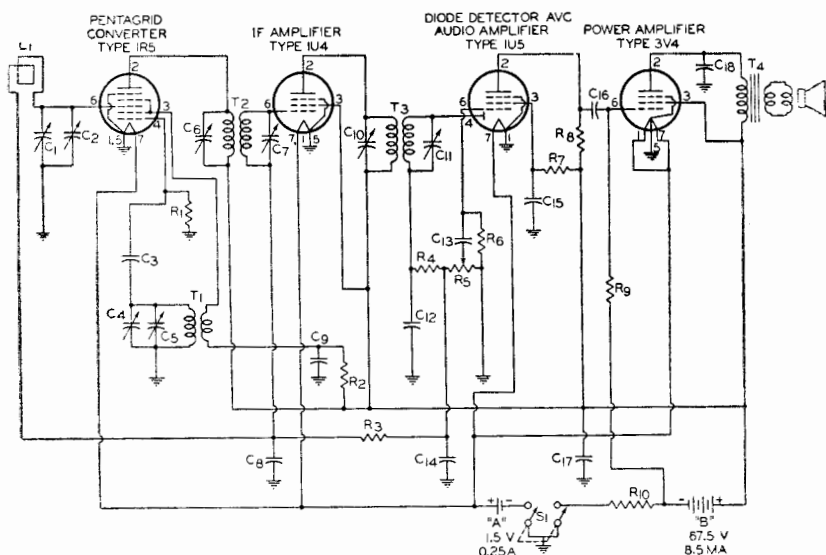

$C_1$   $C_4$  = Ganged tuning capacitors:  $C_1$ , 10-274  $\mu\text{f}$ ;  $C_4$ , 7.5-122.5  $\mu\text{f}$   
 $C_2$   $C_3$  = Trimmer capacitors, 2-15  $\mu\text{f}$   
 $C_4$  = 56  $\mu\text{f}$ , ceramic  
 $C_6$   $C_7$   $C_{10}$   $C_{11}$  = Trimmer capacitors for if transformers  
 $C_8$  = 0.05  $\mu\text{f}$ , paper, 50 v.  
 $C_9$   $C_{15}$  = 0.02  $\mu\text{f}$ , paper, 100 v.  
 $C_{12}$  = 82  $\mu\text{f}$ , ceramic  
 $C_{13}$   $C_{14}$  = 0.002  $\mu\text{f}$ , paper, 150 v.  
 $C_{16}$  = 33  $\mu\text{f}$ , ceramic

$C_{17}$  = 10  $\mu\text{f}$ , electrolytic, 100 v.  
 $C_{18}$  = 0.0022  $\mu\text{f}$ , paper, 600 v.  
 $L_1$  = Loop antenna, 540-1600 Kc  
 $R_1$  = 100000 ohms, 0.25 watt  
 $R_2$  = 15000 ohms, 0.25 watt  
 $R_3$  = 3.3 megohms, 0.25 watt  
 $R_4$  = 68000 ohms, 0.25 watt  
 $R_5$  = Volume control, potentiometer, 2 megohms  
 $R_6$  = 10 megohms, 0.25 watt  
 $R_7$  = 4.7 megohms, 0.25 watt  
 $R_8$   $R_9$  = 1 megohm, 0.25 watt

$R_{10}$  = 390 ohms, 0.25 watt  
 $S_1$  = Switch, double-pole, single-throw  
 $T_1$  = Oscillator coil for use with tuning capacitor of 7.5-122.5  $\mu\text{f}$ , and 455 Kc if transformer  
 $T_2$   $T_3$  = Intermediate-frequency transformers, 455 Kc  
 $T_4$  = Output transformer for voice coil to 10000-ohm tubeload

(21-2)

PORTABLE 3-WAY SUPERHETERODYNE RECEIVER

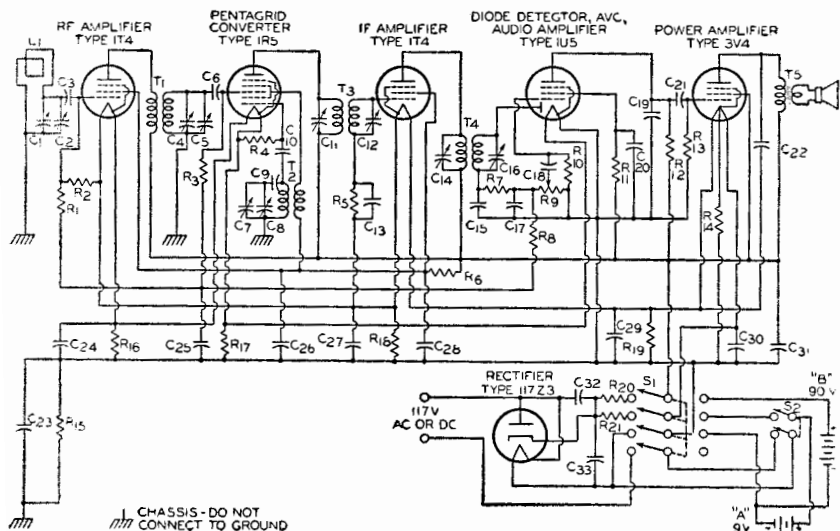

C<sub>1</sub> C<sub>4</sub> C<sub>5</sub> = Ganged tuning capacitors, 20-450  $\mu$ f  
 C<sub>2</sub> C<sub>6</sub> C<sub>7</sub> = Trimmer capacitors, 4-30  $\mu$ f  
 C<sub>3</sub> C<sub>10</sub> C<sub>13</sub> C<sub>17</sub> = 100  $\mu$ f, ceramic  
 C<sub>8</sub> = 82  $\mu$ f, ceramic  
 C<sub>9</sub> = 560  $\mu$ f, ceramic  
 C<sub>11</sub> C<sub>12</sub> C<sub>14</sub> C<sub>15</sub> = Trimmer capacitors for if transformers  
 C<sub>11</sub> = 0.01  $\mu$ f, paper, 400 v.  
 C<sub>12</sub> = 0.002  $\mu$ f, paper, 400 v.  
 C<sub>13</sub> = 270  $\mu$ f, ceramic  
 C<sub>14</sub> = 0.02  $\mu$ f, paper, 400 v.  
 C<sub>15</sub> = 0.005  $\mu$ f, paper, 400 v.  
 C<sub>16</sub> = 0.1  $\mu$ f, paper, 400 v.  
 C<sub>17</sub> = 0.05  $\mu$ f, paper, 200 v.  
 C<sub>18</sub> = 0.05  $\mu$ f, paper, 50 v.  
 C<sub>19</sub> C<sub>20</sub> = 0.05  $\mu$ f, paper, 400 v.  
 C<sub>21</sub> = 40  $\mu$ f, electrolytic, 25 v.

C<sub>10</sub> = 160  $\mu$ f, electrolytic, 25 v.  
 C<sub>21</sub> C<sub>22</sub> = 20  $\mu$ f, electrolytic, 150 v.  
 L<sub>1</sub> = Loop antenna, 540-1600 Kc  
 R<sub>1</sub> R<sub>2</sub> R<sub>11</sub> = 4.7 megohms, 0.25 watt  
 R<sub>3</sub> = 2.2 megohms, 0.25 watt  
 R<sub>4</sub> = 100000 ohms, 0.25 watt  
 R<sub>5</sub> = 5.6 megohms, 0.25 watt  
 R<sub>6</sub> = 27000 ohms, 0.25 watt  
 R<sub>7</sub> = 68000 ohms, 0.25 watt  
 R<sub>8</sub> = 3.3 megohms, 0.25 watt  
 R<sub>9</sub> = Volume control, potentiometer, 1 megohm  
 R<sub>10</sub> = 10 megohms, 0.25 watt  
 R<sub>12</sub> = 220000 ohms, 0.25 watt  
 R<sub>13</sub> = 1 megohm, 0.25 watt  
 R<sub>14</sub> R<sub>16</sub> = 1800 ohms, 0.25 watt  
 R<sub>15</sub> = 220000 ohms, 0.5 watt  
 R<sub>17</sub> = 1000 ohms, 0.25 watt

R<sub>18</sub> = 2700 ohms, 0.25 watt  
 R<sub>19</sub> = 1500 ohms, 0.25 watt  
 R<sub>20</sub> = 1800 ohms, 10 watts  
 R<sub>21</sub> = 2300 ohms, 10 watts  
 S<sub>1</sub> = Switch, 4-pole double-throw  
 S<sub>2</sub> = Switch, double-pole, single-throw  
 T<sub>1</sub> = RF transformer, 540-1600 Kc  
 T<sub>2</sub> = Oscillator coil for use with a 560- $\mu$ f padder, 20-450  $\mu$ f tuning capacitor, and 455 Kc if transformer  
 T<sub>3</sub> T<sub>4</sub> = Intermediate-frequency transformers, 455 Kc  
 T<sub>5</sub> = Output transformer for matching impedance of voice coil to 10000-ohm tube load



(21-3)

## AC-OPERATED SUPERHETERODYNE RECEIVER

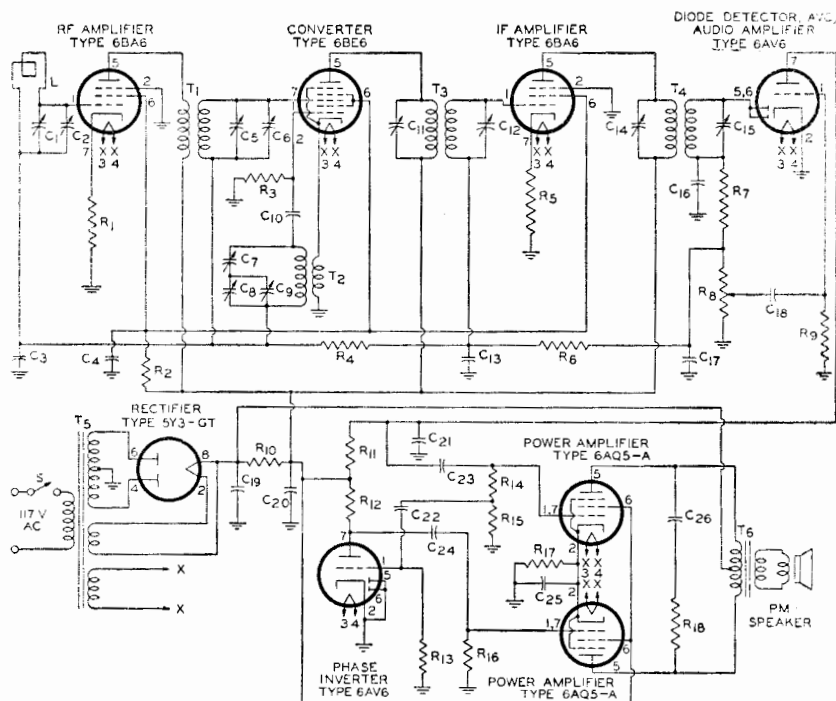

$C_1$   $C_2$   $C_3$  = Ganged tuning capacitors, 10-365  $\mu\text{mf}$   
 $C_2$   $C_3$  = Trimmer capacitors, 4-30  $\mu\text{mf}$   
 $C_4$   $C_{11}$  = 0.05  $\mu\text{f}$ , paper, 50 v.  
 $C_5$  = 0.05  $\mu\text{f}$ , paper, 400 v.  
 $C_6$  = Oscillator padding capacitor—follow oscillator-coil manufacturer's recommendation  
 $C_{10}$  = 56  $\mu\text{mf}$ , mica  
 $C_{11}$   $C_{12}$   $C_{14}$   $C_{15}$  = Trimmer capacitors for if transformers  
 $C_{16}$   $C_{17}$  = 180  $\mu\text{mf}$ , mica  
 $C_{18}$   $C_{22}$  = 0.01  $\mu\text{f}$ , paper, 400 v.  
 $C_{19}$   $C_{20}$  = 20  $\mu\text{f}$ , electrolytic, 450 v.

$C_{21}$  = 120  $\mu\text{mf}$ , mica  
 $C_{22}$   $C_{23}$  = 0.02  $\mu\text{f}$ , paper, 400 v.  
 $C_{24}$  = 20  $\mu\text{f}$ , electrolytic, 50 v.  
 $C_{25}$  = 0.05  $\mu\text{f}$ , paper, 600 v.  
 $L$  = Loop antenna, 540-1600 Kc  
 $R_1$   $R_5$  = 180 ohms, 0.5 watt  
 $R_2$  = 12000 ohms, 2 watts  
 $R_3$  = 22000 ohms, 0.5 watt  
 $R_4$   $R_6$  = 2.2 megohms, 0.5 watt  
 $R_7$  = 100000 ohms, 0.5 watt  
 $R_8$  = Volume control, potentiometer, 1 megohm  
 $R_9$   $R_{13}$  = 10 megohms, 0.5 watt  
 $R_{10}$  = 1800 ohms, 2 watts  
 $R_{11}$   $R_{12}$  = 220000 ohms, 0.5 watt  
 $R_{14}$   $R_{16}$  = 470000 ohms, 0.5 watt  
 $R_{15}$  = 8200 ohms, 0.5 watt

$R_{17}$  = 270 ohms, 5 watts  
 $R_{18}$  = 15000 ohms, 1 watt  
 $S$  = Switch on volume control  
 $T_1$  = RF transformer, 540-1600 Kc  
 $T_2$  = Oscillator coil for use with 10-365- $\mu\text{mf}$  tuning capacitor and 455-Kc if transformer  
 $T_3$   $T_4$  = Intermediate-frequency transformers, 455 Kc  
 $T_5$  = Power transformer, 250-0-250 volts rms, 120 ma. dc  
 $T_6$  = Output transformer for matching impedance of voice coil to a 10000-ohm plate-to-plate tube load

(21-4)

AC/DC SUPERHETERODYNE RECEIVER

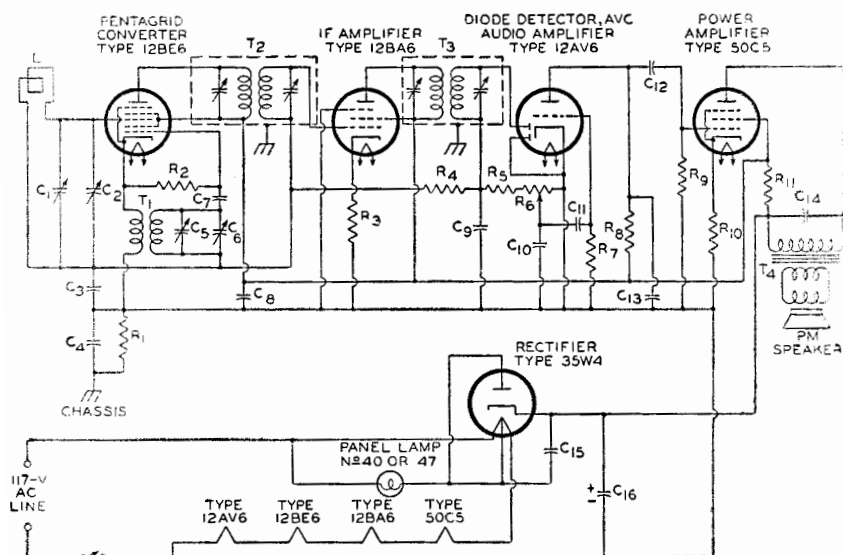

C<sub>1</sub> C<sub>2</sub> = Ganged tuning capacitors; C<sub>1</sub>, 10-365  $\mu$ f; C<sub>2</sub>, 7-115  $\mu$ f  
 C<sub>2</sub> = Trimmer capacitor, 4-30  $\mu$ f  
 C<sub>3</sub> = 0.05  $\mu$ f, paper, 50 v.  
 C<sub>4</sub> = 0.1  $\mu$ f, paper, 400 v.  
 C<sub>5</sub> = Trimmer capacitor, 2-17  $\mu$ f  
 C<sub>6</sub> = 56  $\mu$ f, ceramic  
 C<sub>7</sub> = 50  $\mu$ f, electrolytic, 150 v.  
 C<sub>8</sub> C<sub>9</sub> = 150  $\mu$ f, ceramic  
 C<sub>10</sub> C<sub>11</sub> = 0.02  $\mu$ f, paper, 400 v.  
 C<sub>12</sub> = 0.002  $\mu$ f, paper, 400 v.

C<sub>13</sub> = 330  $\mu$ f, mica  
 C<sub>15</sub> = 0.05  $\mu$ f, paper, 400 v.  
 C<sub>16</sub> = 30  $\mu$ f, electrolytic, 150 v.  
 L = Loop antenna, 540-1600 Kc  
 R<sub>1</sub> R<sub>3</sub> = 220000 ohms, 0.5 watt  
 R<sub>2</sub> = 22000 ohms, 0.5 watt  
 R<sub>4</sub> = 100 ohms, 0.5 watt  
 R<sub>5</sub> = 3.3 megohms, 0.5 watt  
 R<sub>6</sub> = 47000 ohms, 0.5 watt  
 R<sub>7</sub> = Volume control, potentiometer, 50000 ohms  
 R<sub>8</sub> = 4.7 megohms, 0.5 watt

R<sub>9</sub> = 470000 ohms, 0.5 watt  
 R<sub>10</sub> = 150 ohms, 0.5 watt  
 R<sub>11</sub> = 1200 ohms, 1 watt  
 T<sub>1</sub> = Oscillator coil for use with 7-115- $\mu$ f tuning capacitor and 455-Kc intermediate-frequency transformer  
 T<sub>2</sub> T<sub>3</sub> = Intermediate-frequency transformers, 455 Kc  
 T<sub>4</sub> = Output transformer for matching impedance of volume coil to 2500-ohm tube load

(21-5)

## AUTOMOBILE RECEIVER

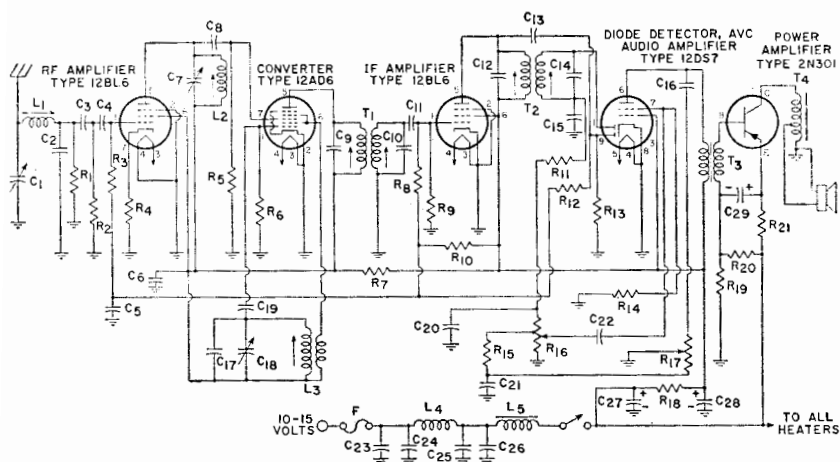
92CL-11302  
RC-21  
21-5

$C_1, C_2, C_{13}$ —Ganged tuning capacitors;  $C_1, 7$ —100  $\mu\text{f}$ ;  
 $C_7, C_{15}$ ; 80–350  $\mu\text{f}$   
 $C_3, C_4, C_8, C_{12}, C_{19}, C_{20}$ —100  $\mu\text{f}$ , mica  
 $C_5$ —27  $\mu\text{f}$ , mica  
 $C_6$ —0.047  $\mu\text{f}$ , paper, 100 volts  
 $C_9, C_{14}$ —0.1  $\mu\text{f}$ , paper, 100 volts  
 $C_9, C_{10}, C_{12}, C_{13}$ —Trimmer capacitors for if transformers  
 $C_{11}$ —330  $\mu\text{f}$ , mica  
 $C_{13}$ —125  $\mu\text{f}$ , mica  
 $C_{17}$ —130  $\mu\text{f}$ , mica  
 $C_{18}$ —0.0056  $\mu\text{f}$ , paper, 100 volts  
 $C_{22}$ —0.01  $\mu\text{f}$ , paper, 100 volts  
 $C_{23}, C_{26}$ —0.47  $\mu\text{f}$ , paper, 100 volts  
 $C_{24}, C_{25}$ —300  $\mu\text{f}$ , mica  
 $C_{27}$ —500  $\mu\text{f}$ , electrolytic, 25 v.  
 $C_{28}$ —250  $\mu\text{f}$ , electrolytic, 25 v.  
 $C_{29}$ —500  $\mu\text{f}$ , electrolytic, 3 v.  
 $F$ —Fuse, 5 a.  
 $L_1$ —Antenna Coil for use with  $C_1$

$L_2$ —RF coil for use with  $C_7$   
 $L_3$ —Oscillator coil, tapped, for use with  $C_{15}$ , and 262.5-Kc if transformer  
 $L_4$ —RF choke, 5 a.  
 $L_5$ —Filter choke, 10 mh., 5 a.  
 $R_1$ —560000 ohms, 0.5 watt  
 $R_2$ —470000 ohms, 0.5 watt  
 $R_3, R_{12}$ —2.2 megohm, 0.5 watt  
 $R_4$ —150 ohms, 0.5 watt  
 $R_5$ —1 megohm, 0.5 watt  
 $R_6$ —33000 ohms, 0.5 watt  
 $R_7$ —100 ohms, 0.5 watt  
 $R_8, R_9, R_{13}$ —4.7 megohms, 0.5 watt  
 $R_{10}$ —22 megohms, 0.5 watt  
 $R_{11}$ —47000 ohms, 0.5 watt  
 $R_{14}$ —10 megohms, 0.5 watt  
 $R_{15}$ —82000 ohms, 0.5 watt  
 $R_{16}$ —Volume control, potentiometer, 1 megohm, tapped at 300000 ohms  
 $R_{17}$ —Tone control,

potentiometer, 1 megohm  
 $R_{18}$ —47 ohms, 1 watt  
 $R_{19}$ —220 ohms, 1 watt  
 $R_{20}$ —15 ohms, 0.5 watt  
 $R_{21}$ —1 ohm, 1 watt  
 $S$ —Speaker, 3.2-ohm voice coil  
 $T_1$ —IF input transformer, 262.5 Kc  
 $T_2$ —IF output transformer, 262.5 Kc  
 $T_3$ —Audio driver transformer: impedance of primary, 2200 ohms; of secondary, 10 ohms; dc resistance of primary, 180 ohms; of secondary, 1.6 ohms; primary current, 15 ma. dc.  
 $T_4$ —Audio output transformer: impedance of primary, 20 ohms; of secondary, 4 ohms; dc resistance of primary, 2 ohms max.; primary current, 0.5 amperes dc.

(21-6)

### 144-Mc SUPERREGENERATIVE RECEIVER

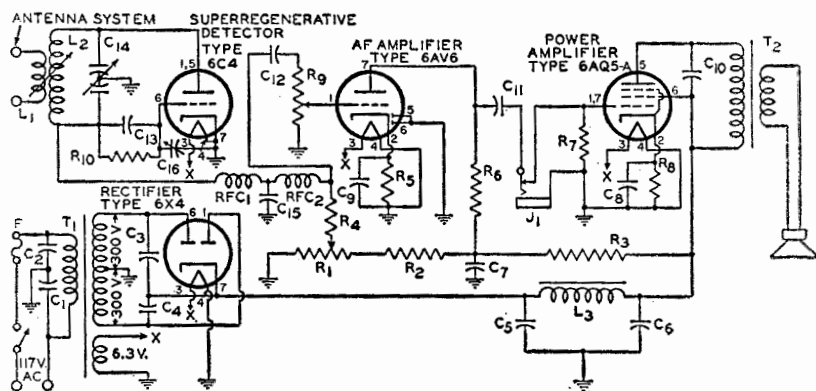

$C_1, C_2 = 0.1 \mu\text{f}$ , paper, 400 v.  
 $C_3, C_4 = 100 \mu\text{mf}$ , mica, 500 v.  
 $C_5, C_6, C_7 = 20 \mu\text{f}$ , electrolytic, 450 v.  
 $C_8 = 25 \mu\text{f}$ , electrolytic, 50 v.  
 $C_9 = 25 \mu\text{f}$ , electrolytic, 25 v.  
 $C_{10} = 0.002 \mu\text{f}$ , paper, 600 v.  
 $C_{11} = 0.01 \mu\text{f}$ , paper, 400 v.  
 $C_{12} = 0.005 \mu\text{f}$ , paper, 400 v.  
 $C_{13} = 50 \mu\text{mf}$ , silver mica, 300 v.  
 $C_{14}$  = Ganged or split-stator tuning capacitor, 10  $\mu\text{mf}$  max. per section  
 $C_{15} = 0.006 \mu\text{f}$ , mica, 300 v.  
 $C_{16}$  = Quench-frequency control,

trimmer capacitor, 3-30  $\mu\text{mf}$ , ceramic or mica  
 $J_1$  = Jack for earphones  
 $L_1$  = Antenna pickup winding  
 $L_2 = 4$  turns of No. 12 Enam. copper wire on a  $\frac{1}{2}$ " I.D. form (144 Mc): adjust spacing to set band  
 $L_3$  = Speaker field or filter choke, 12 henries, 70 ma.  
 $R_1$  = Potentiometer, 50000 ohms, 1 watt, wire wound  
 $R_2, R_3 = 47000$  ohms, 1 watt  
 $R_4 = 27000$  ohms, 0.5 watt  
 $R_5 = 2700$  ohms, 1 watt

$R_6, R_7 = 100000$  ohms, 0.5 watt  
 $R_8 = 270$  ohms, 1 watt  
 $R_9$  = Volume control, potentiometer, 500000 ohms  
 $R_{10} = 4.7$  megohms, 0.5 watt  
 $\text{RFC}_1$  = One-quarter wavelength (20.5 inches at 144 Mc) of No. 23 Enam. close wound on a  $\frac{1}{4}$ " form  
 $\text{RFC}_2$  = RF choke, 8 mh.  
 $T_1$  = Power transformer, 300-0-300 volts rms, 70 ma.  
 $T_2$  = Output transformer for matching impedance of voice coil to 5000-ohm tube load

(21-7)

## TRF AM TUNER

For High-Fidelity Local Broadcast Reception

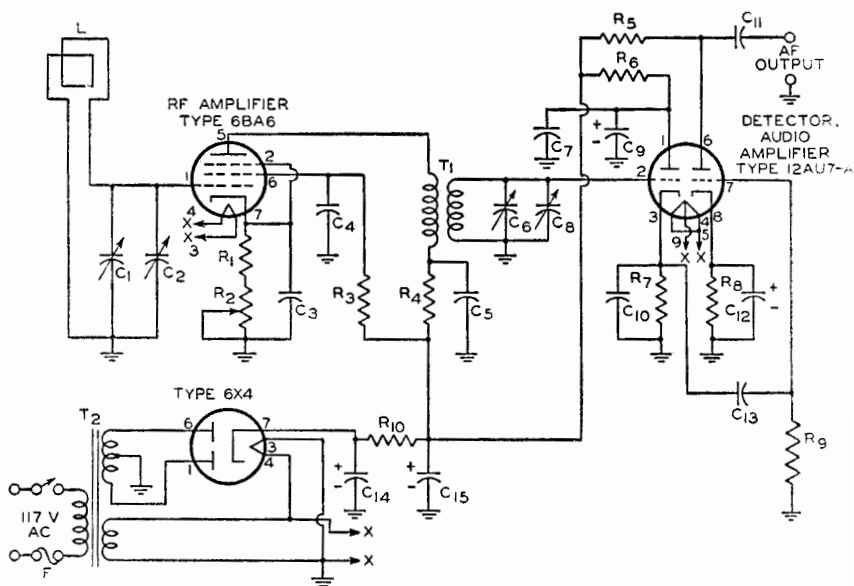

$C_1, C_2$ —Ganged tuning capacitors, 10-365  $\mu\text{f}$

$C_3$ —Trimmer capacitors, 1-30  $\mu\text{f}$

$C_4$ —0.01  $\mu\text{f}$ , paper or ceramic, 200 v.

$C_5$ —0.01  $\mu\text{f}$ , paper or ceramic, 400 v.

$C_6, C_{11}$ —0.1  $\mu\text{f}$ , paper, 400 v.

$C_7$ —250  $\mu\text{f}$ , mica or ceramic, 400 v.

$C_8$ —10  $\mu\text{f}$ , electrolytic, 350 v.

$C_{10}$ —250  $\mu\text{f}$ , mica or ceramic, 200 v.

$C_{13}$ —25  $\mu\text{f}$ , electrolytic, 25 v.

$C_{14}$ —0.05  $\mu\text{f}$ , paper, 200 v.

$C_{14}, C_{15}$ —20  $\mu\text{f}$ , electrolytic, 450 v.

$F$ —Fuse, 1 ampere

$L$ —Loop antenna, 540-1600 Kc.

$R_1$ —180 ohms, 0.5 watt

$R_2$ —Sensitivity control, potentiometer, 5000 ohms

$R_3$ —33000 ohms, 1 watt

$R_4, R_6$ —1000 ohms, 0.5 watt

$R_5$ —100000 ohms, 0.5 watt

$R_7$ —150000 ohms, 0.5 watt

$R_8$ —1500 ohms, 0.5 watt

$R_9$ —470000 ohms, 0.5 watt

$R_{10}$ —7000 ohms, 10 watts

$T_1$ —RF transformer, 540-1600 Kc.

$T_2$ —Power transformer, 250-0-

250 volts rms, 40 ma.

(21-8)

FM TUNER

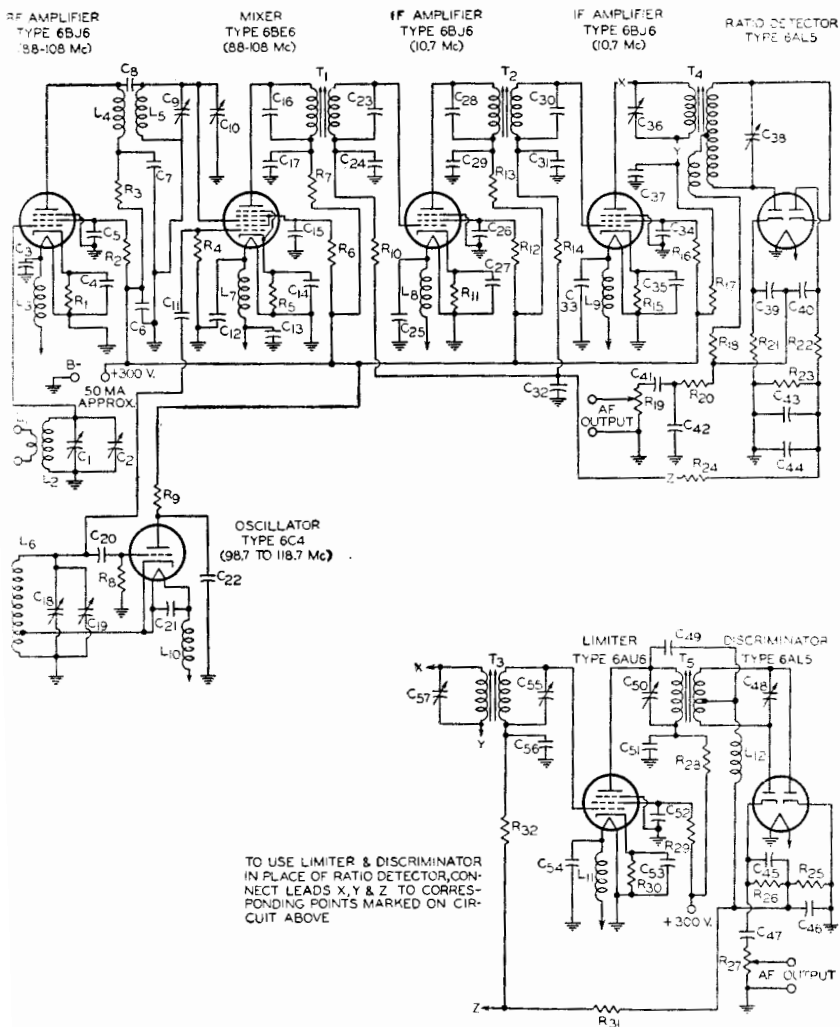

(21-8)

## FM TUNER (Cont'd)

C <sub>1</sub> C <sub>2</sub> C <sub>15</sub> = Gauged tuning capacitors, 7.5-20 $\mu$ f	C <sub>41</sub> C <sub>46</sub> =250 $\mu$ f, ceramic or mica, 200 v.	R <sub>1</sub> R <sub>11</sub> R <sub>15</sub> R <sub>20</sub> =120 ohms, 0.5 watt
C <sub>3</sub> C <sub>19</sub> C <sub>19</sub> = Trimmer capacitors, 1.5-5.0 $\mu$ f, ceramic	C <sub>47</sub> =0.1 $\mu$ f, paper, 200 v.	R <sub>2</sub> R <sub>12</sub> R <sub>16</sub> =39000 ohms, 0.5 watt
C <sub>5</sub> =0.01 $\mu$ f, ceramic or mica, 200 v.	C <sub>51</sub> =500 $\mu$ f, ceramic or mica, 400 v.	R <sub>3</sub> R <sub>7</sub> R <sub>13</sub> R <sub>17</sub> =470 ohms, 0.5 watt
C <sub>7</sub> C <sub>14</sub> C <sub>21</sub> C <sub>27</sub> C <sub>31</sub> C <sub>35</sub> C <sub>38</sub> C <sub>38</sub> = 1500 $\mu$ f, ceramic or mica, 200 v.	L <sub>1</sub> =1 turn of No.14 Enam. wound on a $\frac{3}{4}$ " diam. coil form	R <sub>4</sub> R <sub>24</sub> R <sub>28</sub> =10000 ohms, 0.5 watt
C <sub>8</sub> C <sub>9</sub> C <sub>12</sub> C <sub>17</sub> C <sub>22</sub> C <sub>26</sub> C <sub>29</sub> C <sub>34</sub> C <sub>37</sub> C <sub>42</sub> =1500 $\mu$ f, ceramic or mica, 400 v.	L <sub>2</sub> =2.5 turns of No.14 Enam. spaced 1 wire diameter wound on same form as L <sub>1</sub> with the ground end of L <sub>2</sub> spaced $\frac{1}{4}$ " from L <sub>1</sub>	R <sub>5</sub> =47 ohms, 0.5 watt
C <sub>6</sub> =0.1 $\mu$ f, paper, 400 v.	L <sub>3</sub> L <sub>4</sub> L <sub>7</sub> L <sub>8</sub> L <sub>9</sub> L <sub>10</sub> L <sub>11</sub> = Choke, 1 mh (approx.), 25 turns of No.24 Enam. close-wound on resistor (47000 ohms, 0.5 watt), connected in parallel with resistor.	R <sub>6</sub> =33000 ohms, 1 watt
C <sub>10</sub> =33 $\mu$ f, mica, 400 v.	L <sub>5</sub> =2.5 turns of No.14 Enam. spaced 1 wire diameter, wound on $\frac{3}{4}$ " form.	R <sub>7</sub> =47000 ohms, 0.5 watt
C <sub>11</sub> =3 $\mu$ f, silver mica, 200 v.	L <sub>6</sub> =2 turns of No.14 Enam. spaced 1 wire diameter, wound on $\frac{3}{4}$ " form.	R <sub>8</sub> =4700 ohms, 1 watt
C <sub>13</sub> C <sub>13</sub> C <sub>20</sub> C <sub>22</sub> C <sub>25</sub> C <sub>33</sub> =0.01 $\mu$ f, ceramic or mica, 200 v.	L <sub>7</sub> =2 turns of No.14 Enam. spaced 1 wire diameter, wound on $\frac{3}{4}$ " form, tapped at $\frac{1}{2}$ turn from ground end	R <sub>9</sub> =4700 ohms, 1 watt
C <sub>16</sub> C <sub>23</sub> C <sub>25</sub> C <sub>30</sub> C <sub>36</sub> C <sub>38</sub> C <sub>43</sub> C <sub>45</sub> C <sub>49</sub> C <sub>52</sub> C <sub>57</sub> = Trimmer capacitors, 22-50 $\mu$ f, mica, usually part of if transformer	L <sub>12</sub> =Choke, 2.5 mh. (may not be required: follow transformer manufacturer's recommendation)	R <sub>10</sub> R <sub>14</sub> R <sub>22</sub> =220000 ohms, 0.5 watt
C <sub>20</sub> =33 $\mu$ f, silver mica, 200 v.		R <sub>18</sub> =56 ohms, 0.5 watt
C <sub>31</sub> =100 $\mu$ f, ceramic or mica, 200 v.		R <sub>19</sub> R <sub>27</sub> =Volume controls, potentiometers, 1 megohm
C <sub>35</sub> C <sub>36</sub> =330 $\mu$ f, ceramic or mica, 200 v.		R <sub>20</sub> =15000 ohms, 0.5 watt
C <sub>41</sub> =0.05 $\mu$ f, paper, 200 v.		R <sub>21</sub> =820 ohms, 0.5 watt
C <sub>42</sub> C <sub>43</sub> =0.005 $\mu$ f, ceramic or paper, 200 v.		R <sub>22</sub> =560 ohms, 0.5 watt
C <sub>44</sub> =10 $\mu$ f, electrolytic, 200 v.		R <sub>23</sub> R <sub>24</sub> =2.2 megohms, 0.5 watt
		R <sub>25</sub> R <sub>26</sub> =190000 ohms, 0.5 watt
		R <sub>29</sub> =150000 ohms, 1 watt
		T <sub>1</sub> T <sub>2</sub> T <sub>3</sub> =Intermediate-frequency transformers, 10.7 Mc
		T <sub>4</sub> =Ratio-detector transformer, 10.7 Mc
		T <sub>5</sub> =Discriminator transformer, 10.7 Mc

NOTE: A high-frequency de-emphasis network having a time constant of 75 microseconds (such as that formed by R<sub>29</sub> and C<sub>47</sub>) should be inserted between R<sub>26</sub> and C<sub>47</sub> in the discriminator output lead.

Fig. 21-8 illustrates a circuit for an FM broadcast tuner. The basic circuit has been arranged to show the use of a ratio detector, but the limiter/discriminator circuit shown in the lower right-hand corner of the diagram can be substituted as indicated at points X, Y, and Z in the schematic.

A word of caution is necessary in connection with this circuit. Because it works at very high frequencies and is required to handle a very wide bandwidth, its construction requires more than ordinary skill and experience. Placement of component parts is quite critical and may require considerable experimentation. All rf leads to components including bypass capacitors must be kept short and must be properly dressed to minimize undesirable coupling and capacitance effects. Correct circuit alignment and oscillator tracking require the use of a cathode-ray oscilloscope, a high-impedance vacuum-tube voltmeter, and a signal generator capable of supplying a frequency-modulated signal on 10.7 Mc as well as accurate marker signals in the 88-108-Mc band. Unless the builder has the necessary equipment and has had considerable experience with broad-band, high-frequency circuits, he should not undertake the construction of this circuit.

(21-9)

**PHONOGRAPH AMPLIFIER**

Power Output, 1 Watt

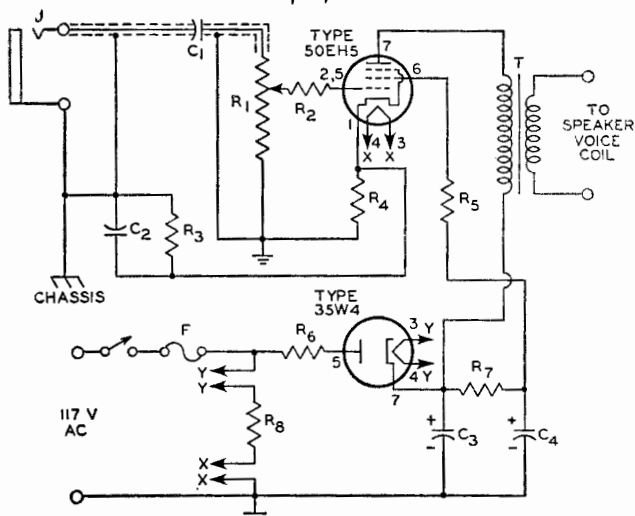

$C_1 = 0.02 \mu\text{f}$ , paper, 400 v.  
 $C_2 = 0.082 \mu\text{f}$ , paper, 400 v.  
 $C_3, C_4 = 40 \mu\text{f}$ , electrolytic, 150 v.  
 F = Fuse, 1 ampere  
 J = Input connector, shielded,  
 for crystal phonograph  
 pickup.

$R_1$  = Volume control, potentiometer, 0.5 megohm, audio taper  
 $R_2 = 10000$  ohms, 0.5 watt  
 $R_3 = 220000$  ohms, 0.5 watt  
 $R_4, R_5 = 56$  ohms, 0.5 watt  
 $R_6 = 22$  ohms, 0.5 watt

$R_7 = 3300$  ohms, 1 watt  
 $R_8 = 210$  ohms, 10 watts  
 T = Output transformer for matching impedance of voice coil to 3000-ohm tube load.

(21-10)

**TWO-CHANNEL STEREOPHONIC AMPLIFIER**

Power Output, 1 Watt Each Channel

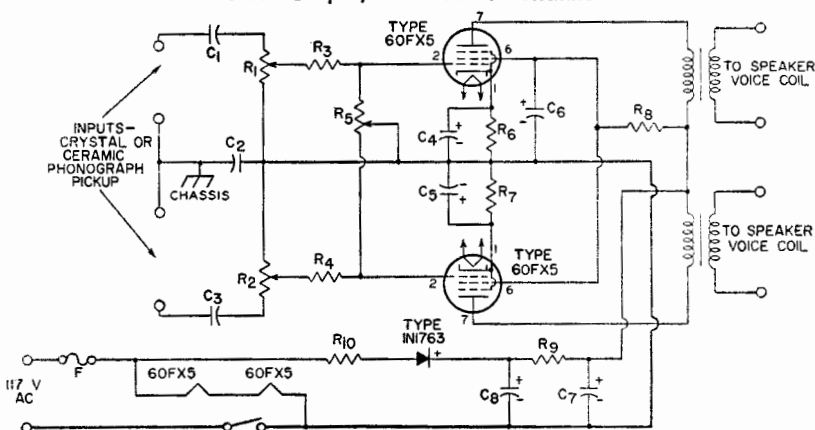

$C_1, C_2 = 0.22 \mu\text{f}$ , 400 v., paper  
 $C_2 = 0.1 \mu\text{f}$ , 400 v., paper  
 $C_3, C_4 = 50 \mu\text{f}$ , 25 v., electrolytic  
 $C_5 = 50 \mu\text{f}$ , 150 v., electrolytic  
 $C_7, C_8 = 50 \mu\text{f}$ , 150 v., electrolytic  
 F = Fuse, 3 amperes

$R_1, R_2$  = Volume control, potentiometer, 1.5 megohms, ganged  
 $R_3, R_4 = 47000$  ohms, 0.5 watt  
 $R_5$  = Balance control, potentiometer, 2 megohms  
 $R_6, R_7 = 60$  ohms, 1 watt

$R_8 = 220$  ohms, 2 watts  
 $R_9 = 280$  ohms, 2 watts  
 $R_{10} = 12$  ohms, 1 watt  
 $T_1, T_2$  = Output transformer for matching impedance of voice coil to 3000-ohm tube load.



(21-11)

## TWO-CHANNEL STEREPHONIC AMPLIFIER

Power Output, 3.5 Watts Each Channel

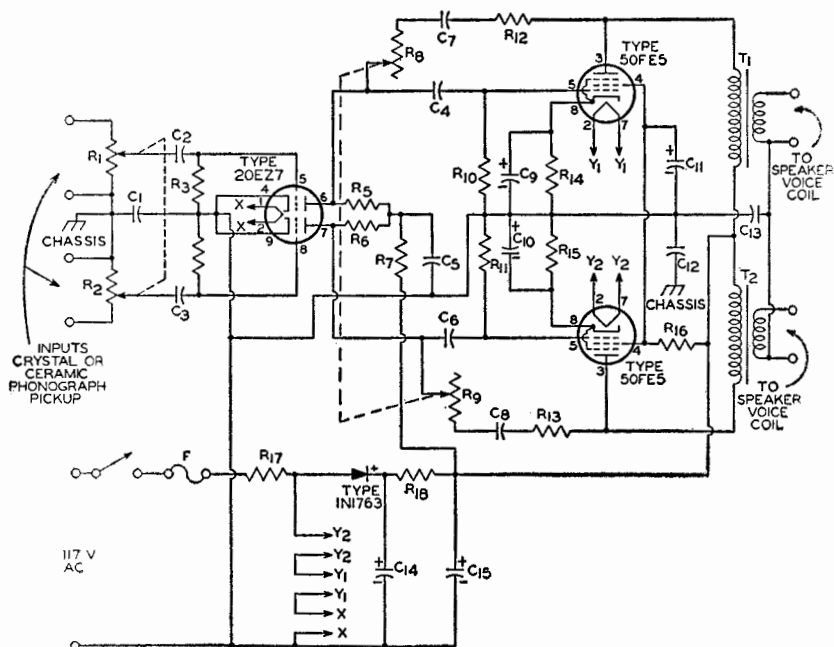

$C_1 C_{12}=0.047 \mu\text{f}$ , paper, 150 v.  
 $C_2 C_3=0.01 \mu\text{f}$ , paper, 150 v.  
 $C_4 C_8=0.022 \mu\text{f}$ , paper, 150 v.  
 $C_5 C_{11}=8 \mu\text{f}$ , electrolytic, 150 v.  
 $C_7 C_8=680 \mu\text{f}$ , ceramic or mica, 400 v.  
 $C_9 C_{10}=50 \mu\text{f}$ , electrolytic, 25 v.  
 $C_{13}=0.068 \mu\text{f}$ , paper, 150 v.  
 $C_{14}=200 \mu\text{f}$ , electrolytic, 150 v.  
 $C_{15}=100 \mu\text{f}$ , electrolytic, 150 v.  
 F=Fuse, 2 amperes

$R_1 R_2$ =Volume control, potentiometer, 2 megohms, ganged.  
 $R_3 R_4=10$  megohms, 0.5 watt  
 $R_5 R_6=0.22$  megohm, 1 watt  
 $R_7=0.022$  megohm, 2 watts  
 $R_8 R_9$ =Tone control, potentiometer, 2 megohms, ganged.  
 $R_{10} R_{11}=0.47$  megohm, 0.5 watt  
 $R_{12} R_{13}=0.22$  megohm, 0.5 watt

$R_{14} R_{15}=120$  ohms, 2 watts  
 $R_{16}=750$  ohms, 2 watts  
 $R_{17}=6.8$  ohms, 2 watts  
 $R_{18}=100$  ohms, 10 watts  
 $T_1 T_2$ =Output transformer for matching impedance of voice coil to 1000-ohm plate tube load. Turns ratio 20 to 1; primary current 90 ma. dc; power-handling capacity, 3.5 watts minimum.

(21-12)

**MICROPHONE AND PHONOGRAPH AMPLIFIER**

Power Output, 8 Watts

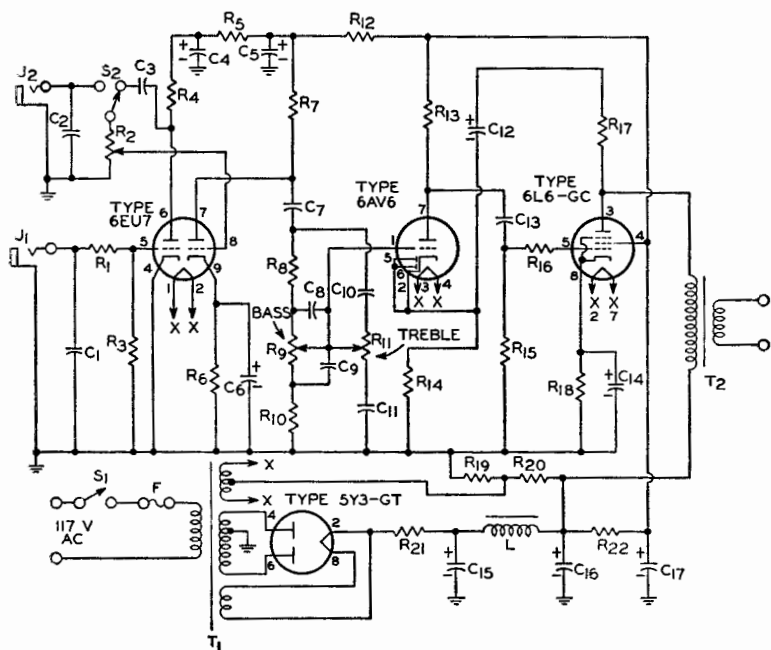

C<sub>1</sub> C<sub>2</sub>=100  $\mu$ f, disc-ceramic, 300 v.  
 C<sub>3</sub>=0.05  $\mu$ f, paper, 200 v.  
 C<sub>4</sub>=8  $\mu$ f, electrolytic, 450 v.  
 C<sub>5</sub>=16  $\mu$ f, electrolytic, 450 v.  
 C<sub>6</sub>=25  $\mu$ f, electrolytic, 450 v.  
 C<sub>7</sub>=0.1  $\mu$ f, paper, 200 v.  
 C<sub>8</sub>=0.001  $\mu$ f, disc-ceramic, 300 v.  
 C<sub>9</sub>=0.01  $\mu$ f, disc-ceramic, 300 v.  
 C<sub>10</sub>=470  $\mu$ f, disc-ceramic, 300 v.  
 C<sub>11</sub>=4700  $\mu$ f, disc-ceramic, 300 v.  
 C<sub>12</sub>=4  $\mu$ f, electrolytic, 450 v.  
 C<sub>13</sub>=0.05  $\mu$ f, paper, 600 v.  
 C<sub>14</sub>=25  $\mu$ f, electrolytic, 25 v.  
 C<sub>15</sub> C<sub>16</sub> C<sub>17</sub>=20  $\mu$ f, electrolytic, 450 v.  
 F=Fuse, 1 a.

J<sub>1</sub>=Jack for high-impedance crystal microphone input; max. input: 2 millivolts peak  
 J<sub>2</sub>=Jack for crystal phonopickup input; max. input: 0.5 volt peak  
 L=Filter choke, 5 henries, 200 ma.  
 R<sub>1</sub> R<sub>16</sub>=10000 ohms, 0.5 watt  
 R<sub>2</sub>=Volume Control, potentiometer, 1 megohm  
 R<sub>3</sub>=2.2 megohms, 0.5 watt  
 R<sub>4</sub> R<sub>5</sub> R<sub>20</sub>=220000 ohms, 0.5 watt  
 R<sub>6</sub>=27000 ohms, 0.5 watt  
 R<sub>7</sub>=1200 ohms, 0.5 watt  
 R<sub>8</sub> R<sub>11</sub>=100000 ohms, 0.5 watt  
 R<sub>9</sub> R<sub>11</sub>=Tone control, potentiometer, 0.5 megohm

R<sub>10</sub>=22000 ohms, 0.5 watt  
 R<sub>12</sub>=12000 ohms, 0.5 watt  
 R<sub>14</sub>=1800 ohms, 0.5 watt  
 R<sub>15</sub>=470000 ohms, 0.5 watt  
 R<sub>17</sub>=150000 ohms, 0.5 watt  
 R<sub>18</sub>=180 ohms, 2 watts  
 R<sub>19</sub>=47000 ohms, 1 watt  
 R<sub>21</sub>=50 ohms, 10 watts  
 R<sub>22</sub>=8200 ohms, 2 watts  
 S<sub>1</sub>=Switch, SPST  
 S<sub>2</sub>=Switch, SPDT  
 T<sub>1</sub>=Power transformer, 300-0-300, 90 ma.; 6.3 v., 3.5 a. center tapped; 5 v., 2 a.  
 T<sub>2</sub>=Output transformer for matching impedance of voice coil to 4000-ohm tube load; 10 watts audio

(21-13)

## HIGH-FIDELITY AUDIO AMPLIFIER

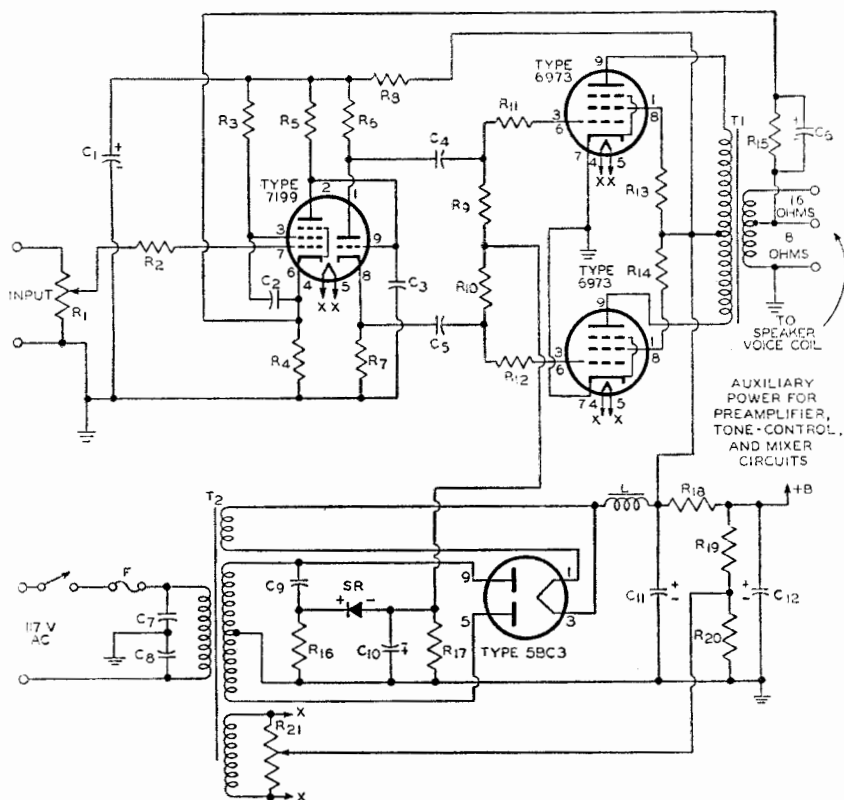
Class AB<sub>1</sub>; Power Output, 15 Watts

$C_1 = 10 \mu\text{f}$ , electrolytic, 450 v.  
 $C_2, C_4, C_5 = 0.25 \mu\text{f}$ , paper, 400 v.  
 $C_3 = 3.3 \mu\text{f}$ , ceramic or mica, 600 v.  
 $C_6 = 150 \mu\text{f}$ , ceramic or mica, 400 v.  
 $C_7, C_8 = 0.05 \mu\text{f}$ , paper, 400 v.  
 $C_9 = 0.02 \mu\text{f}$ , paper, 600 v.  
 $C_{10} = 100 \mu\text{f}$ , electrolytic, 50 v.  
 $C_{11} = 80 \mu\text{f}$ , electrolytic, 450 v.  
 $C_{12} = 40 \mu\text{f}$ , electrolytic, 450 v.  
 F = Fuse, 3 amperes  
 L = Choke, 3 h., 160 ma., dc resistance 75 ohms or less  
 $R_1$  = Volume control, potentiometer, 1 megohm

$R_2 = 10000 \text{ ohms}$ , 0.5 watt  
 $R_3 = 0.82 \text{ megohm}$ , 0.5 watt  
 $R_4 = 820 \text{ ohms}$ , 0.5 watt  
 $R_5 = 0.22 \text{ megohm}$ , 0.5 watt  
 $R_6, R_7 = 15000 \text{ ohms} \pm 5 \text{ per cent}$ , 2 watts  
 $R_8 = 3900 \text{ ohms}$ , 2 watts  
 $R_9, R_{10} = 0.1 \text{ megohm}$ , 0.5 watt  
 $R_{11}, R_{12} = 1000 \text{ ohms}$ , 0.5 watt  
 $R_{13}, R_{14} = 100 \text{ ohms}$ , 0.5 watt  
 $R_{15} = 8200 \text{ ohms}$ , 0.5 watt  
 $R_{16} = 15000 \text{ ohms}$ , 1 watt  
 $R_{17} = 68000 \text{ ohms}$ , 0.5 watt  
 $R_{18} = 4700 \text{ ohms}$ , 2 watts  
 $R_{19} = 0.27 \text{ megohm}$ , 1 watt  
 $R_{20} = 47000 \text{ ohms}$ , 0.5 watt

$R_{21}$  = Hum balance adjustment, potentiometer, 100 ohms, 0.5 watt  
 SR = Selenium rectifier, 20 ma., 135 volts rms  
 $T_1$  = Output transformer, (having 8-ohm tap for feedback connection) for matching impedance of voice coil to 6600-ohm plate-to-plate tube load; 50 watts; frequency response, 10 to 50000 cps.  
 $T_2$  = Power transformer, 360-0-360 volts rms, 120 ma.; 6.3 v., 3.5 a.; 5v., 3a.

(21-14)

### HIGH-FIDELITY AUDIO AMPLIFIER

Class AB<sub>1</sub>; Power Output, 30 Watts

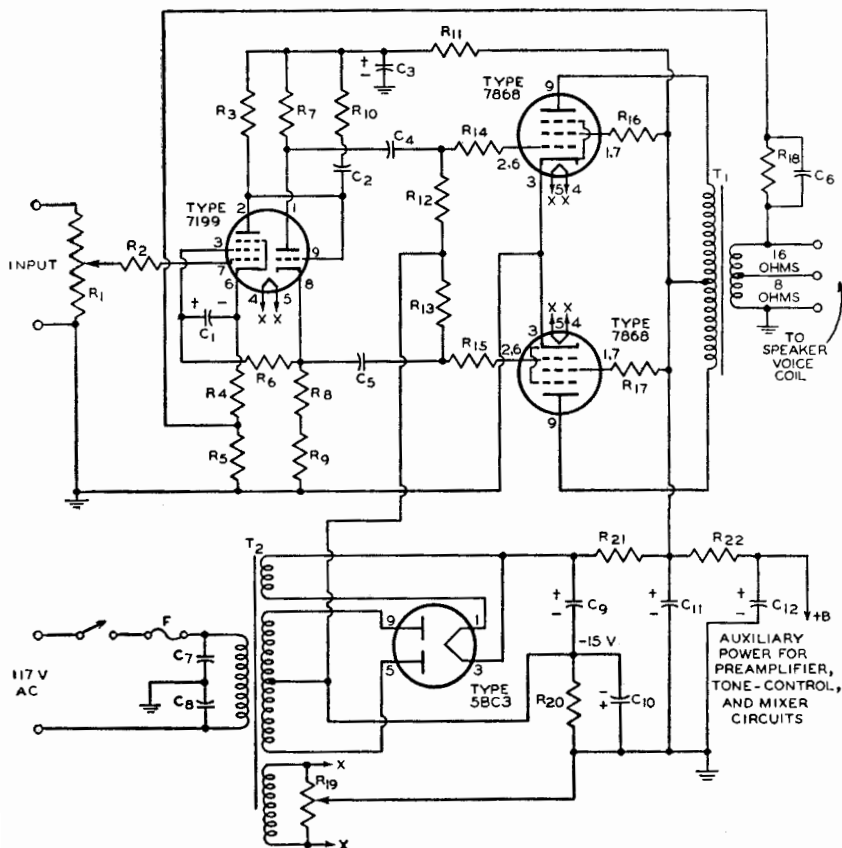

$C_1 = 25 \mu\text{f}$ , electrolytic, 50 v.  
 $C_2 = 22 \mu\text{f}$ , ceramic or mica, 600 v.  
 $C_3 = 80 \mu\text{f}$ , electrolytic, 600 v.  
 $C_4, C_5 = 0.25 \mu\text{f}$ , paper, 600 v.  
 $C_6 = 0.01 \mu\text{f}$ , paper, 600 v.  
 $C_7, C_8 = 0.05 \mu\text{f}$ , paper, 600 v.  
 $C_9, C_{11} = 40 \mu\text{f}$ , electrolytic, 600 v.  
 $C_{10} = 100 \mu\text{f}$ , electrolytic, 50 v.  
 $C_{12} = 20 \mu\text{f}$ , electrolytic, 450 v.  
 $F = \text{Fuse}$ , 3 amperes, 150 v.  
 $R_1 = \text{Volume control}$ , potentiometer, 1 megohm  
 $R_2 = 10000 \text{ ohms}$ , 0.5 watt

$R_3 = 220000 \text{ ohms}$ , 0.5 watt  
 $R_4 = 820 \text{ ohms}$ , 0.5 watt  
 $R_5 = 10 \text{ ohms}$ , 0.5 watt  
 $R_6 = 180000 \text{ ohms}$ , 0.5 watt  
 $R_7 = 15000 \text{ ohms} \pm 5 \text{ per cent}$ , 2 watts  
 $R_8 = 15000 \text{ ohms} \pm 5 \text{ per cent}$ , 0.5 watt  
 $R_9 = 1000 \text{ ohms}$ , 0.5 watt  
 $R_{10} = 22000 \text{ ohms}$ , 0.5 watt  
 $R_{11} = 2000 \text{ ohms}$ , 2 watts  
 $R_{12}, R_{13} = 100000 \text{ ohms}$ , 0.5 watt  
 $R_{14}, R_{15} = 1000 \text{ ohms}$ , 0.5 watt  
 $R_{16}, R_{17} = 56 \text{ ohms}$ , 0.5 watt  
 $R_{18} = 270 \text{ ohms}$ , 0.5 watt

$R_{19} = \text{Hum balance adjustment}$ , potentiometer, 100 ohms, 0.5 watt  
 $R_{20} = 120 \text{ ohms}$ , 10 watts  
 $R_{21} = 50 \text{ ohms}$ , 10 watts  
 $R_{22} = 10000 \text{ ohms}$ , 2 watts  
 $T_1 = \text{Output transformer}$  (having 16-ohm tap for feedback connection) for matching impedance of voice coil to 6600-ohm plate-to-plate tube load; 50 watts; frequency response, 10 to 50000 cps.  
 $T_2 = \text{Power transformer}$ , 375-0-375 volts rms, 160 ma.; 6.3 v., 5 a.; 5 v., 3 a.

(21-15)

## HIGH-FIDELITY AUDIO AMPLIFIER

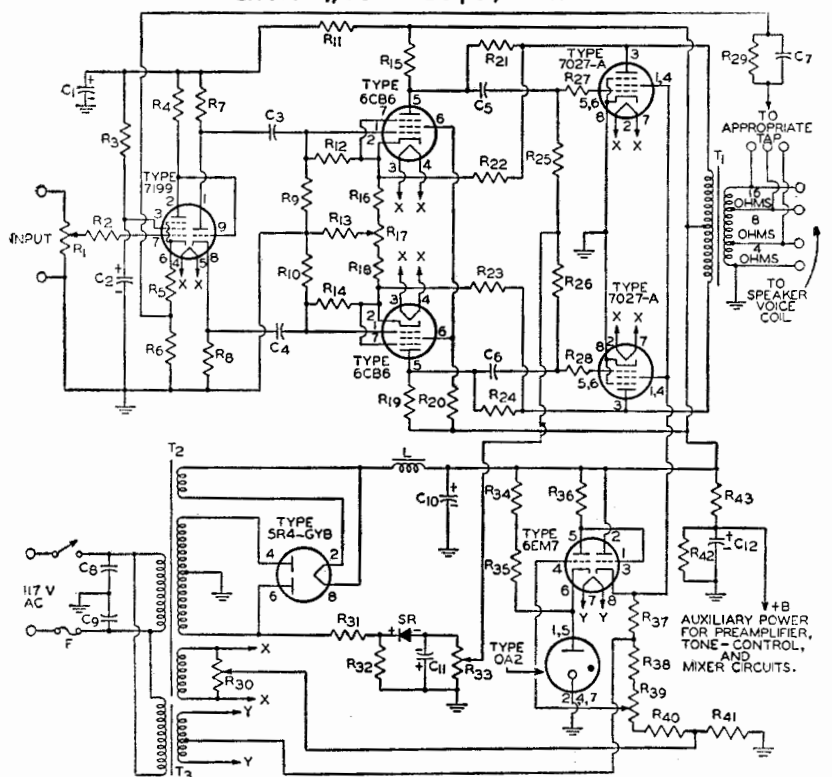
Class AB<sub>1</sub>; Power Output, 50 Watts

C<sub>1</sub>, C<sub>2</sub> = 40  $\mu$ f, electrolytic, 450 v.

C<sub>3</sub>, C<sub>4</sub> = 0.02  $\mu$ f, paper, 400 v.

C<sub>5</sub>, C<sub>6</sub> = 1  $\mu$ f, paper, 400 v.

C<sub>7</sub> = 0.002  $\mu$ f to 4-ohm tap;

0.0015  $\mu$ f to 8-ohm tap; or

0.001  $\mu$ f to 16-ohm tap;

paper, 400 v.

C<sub>8</sub>, C<sub>9</sub> = 0.05  $\mu$ f, paper, 600 v.

C<sub>10</sub> = 20  $\mu$ f, electrolytic, 600 v.

C<sub>11</sub> = 100  $\mu$ f, electrolytic, 150 v.

C<sub>12</sub> = 40  $\mu$ f, electrolytic, 450 v.

F = Fuse, 5 amperes

L = Choke, 8 h., 250 ma., dc

resistance 60 ohms, or less

R<sub>1</sub> = Volume control, potenti-

ometer, 0.5 megohm

R<sub>2</sub> = 4700 ohms, 0.5 watt

R<sub>3</sub> = 0.82 megohm, 0.5 watt

R<sub>4</sub> = 0.22 megohm, 0.5 watt

R<sub>5</sub> = 820 ohms, 0.5 watt

R<sub>6</sub> = 10 ohms, 0.5 watt

R<sub>7</sub>: R<sub>8</sub> = 15000 ohms, 2 watts

R<sub>9</sub>: R<sub>10</sub> = 1.5 megohms, 0.5 watt

R<sub>11</sub> = 33000 ohms, 2 watts

R<sub>12</sub>: R<sub>14</sub> = 1.3 megohms, 0.5 watt

R<sub>15</sub> = 47 ohms, 0.5 watt

R<sub>16</sub>: R<sub>18</sub> = 0.15 megohm, 0.5 watt

R<sub>19</sub>: R<sub>20</sub> = 390 ohms, 0.5 watt

R<sub>21</sub>: AC balance control,

potentiometer, 500 ohms,

Note 4

R<sub>22</sub> = 0.15 megohm, 1 watt

R<sub>23</sub>: R<sub>24</sub> = 0.33 megohm, 1 watt

R<sub>25</sub>: R<sub>26</sub> = 0.12 megohm, 2 watts

R<sub>27</sub>: R<sub>28</sub> = 0.1 megohm, 0.5 watt

R<sub>29</sub>: R<sub>30</sub> = 4700 ohms, 0.5 watt

R<sub>31</sub> = 600 ohms to 4-ohm tap;

820 ohms to 8-ohm tap; or,

1200 ohms to 16-ohm tap;

0.5 watt

R<sub>32</sub>: Hum balance adjustment,

potentiometer, 100 ohms,

Note 3

R<sub>33</sub> = 0.12 megohm, 5 watts

R<sub>34</sub>: R<sub>35</sub>: R<sub>37</sub> = 33000 ohms,

2 watts

R<sub>36</sub>: Bias adjustment, potenti-

ometer 50000 ohms, Note 1

R<sub>38</sub> = 0.27 megohm, 1 watt

R<sub>39</sub> = 10000 ohms, 1 watt

R<sub>40</sub> = Screen-grid voltage ad-

justment, potentiometer,

25000 ohms, 2 watts, Note 2

R<sub>41</sub> = 15000 ohms, 2 watts

R<sub>42</sub> = 12000 ohms, 2 watts

R<sub>43</sub> = 0.22 megohm, 2 watts

R<sub>44</sub> = 22000 ohms, 2 watts

SR = Selenium rectifier, 20 ma.,

135 volts rms

T<sub>1</sub> = Output transformer for

matching impedance of voice

coil to 5000-ohm plate-to-

plate tube load; 50 watts;

frequency response, 10 to

50000 cps.

T<sub>2</sub> = Power transformer, 600-0-

600 volts rms, 200 ma., 6.3

v., 5 a.; 5 v., 3 a.

T<sub>3</sub> = Filament transformer, 6.3

volts, center tapped,

1 ampere

NOTES: All of the following adjustments should be made before amplifier is placed into operation.

- (1) Make this adjustment with 5R4-GYB rectifier out of socket so that there is no B+ applied to power output tubes. Adjust R<sub>33</sub> for reading of -40 volts between junction of R<sub>25</sub> and R<sub>26</sub> and B-ground bus. (2) Make this adjustment with speaker connected. Adjust R<sub>32</sub> for reading of 400 volts between pin 3 of 6EM7 and -B (ground bus). (3) With input shorted, adjust R<sub>30</sub> for minimum hum from speaker. (4) With input open and volume control R<sub>1</sub> set for maximum volume, adjust R<sub>2</sub> for minimum hum from speaker.

(21-16)

### TWO-CHANNEL AUDIO MIXER

Voltage Gain From Each Grid of 6EU7 to Output is Approximately 20

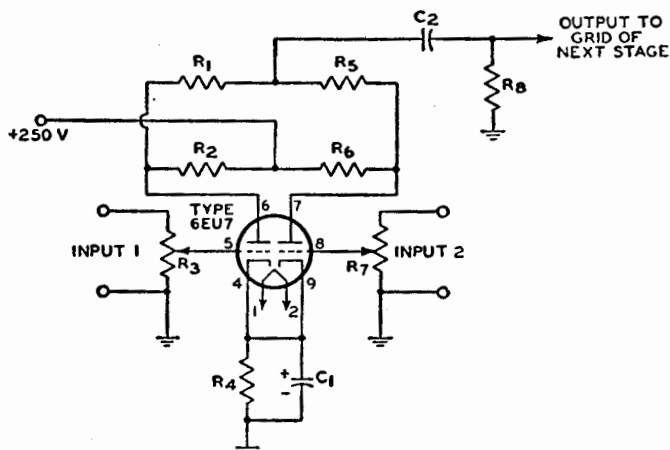

$C_1=10 \mu\text{f}$ , electrolytic, 25 v.  
 $C_2=0.05 \mu\text{f}$ , paper, 400 v.

$R_1 R_2 R_3=1 \text{ megohm}$ , 0.5 watt  
 $R_4 R_5=100000 \text{ ohms}$ , 0.5 watt

$R_6 R_7$ =Potentiometers, 100000 ohms, audio taper  
 $R_8=1200 \text{ ohms}$ , 0.5 watt

(21-17)

### PREAMPLIFIER FOR MAGNETIC PHONO PICKUP

With RIAA Equalization

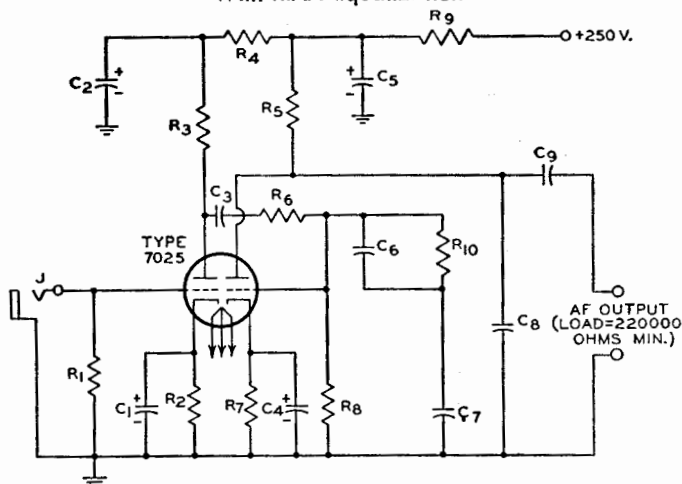

$C_1 C_4=25 \mu\text{f}$ , electrolytic, 25 v.  
 $C_2 C_3=20 \mu\text{f}$ , electrolytic, 450 v.  
 $C_5=0.1 \mu\text{f}$ , paper, 600 v.  
 $C_6=0.0033 \mu\text{f}$ , paper, 600 v.  
 $C_7=0.01 \mu\text{f}$ , paper, 600 v.  
 $C_8=180 \mu\text{f}$ , ceramic or mica  
 500 v.  
 $C_9=0.22 \mu\text{f}$ , paper, 600 v.

J=Input connector, shielded,  
 for high-impedance magnetic  
 phono pickup (10 mv. output,  
 approx.)  
 $R_1$ =Value depends on type of  
 magnetic pickup used. Fol-  
 low pickup manufacturer's  
 recommendations.

$R_2 R_7=2700 \text{ ohms}$ , 0.5 watt  
 $R_3 R_4=100000 \text{ ohms}$ , 0.5 watt  
 $R_5=39000 \text{ ohms}$ , 0.5 watt  
 $R_6=470000 \text{ ohms}$ , 0.5 watt  
 $R_8=680000 \text{ ohms}$ , 0.5 watt  
 $R_9=15000 \text{ ohms}$ , 1 watt  
 $R_{10}=22000 \text{ ohms}$ , 0.5 watt

(21-18)

**PREAMPLIFIER FOR CERAMIC PHONOGRAPH PICKUP**

Cathode-Follower (Low-Impedance) Output

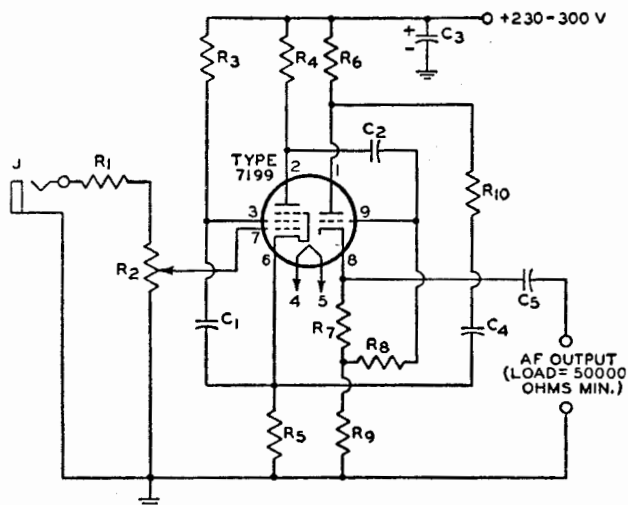

$C_1=0.1 \mu\text{f}$ , paper, 400 v.  
 $C_2=0.01 \mu\text{f}$ , paper, 400 v.  
 $C_3=20 \mu\text{f}$ , electrolytic, 400 v.  
 $C_4=0.25 \mu\text{f}$ , paper, 400 v.  
 $C_5=0.22 \mu\text{f}$ , paper, 600 v.  
 J=Input connector, shielded,  
 for high-impedance ceramic

phono pickup (0.5 v. output)  
 $R_1=1.8$  megohms, 0.5 watt  
 $R_2$ =Volume control, potentiometer,  
 500000 ohms, audio taper  
 $R_3=820000$  ohms, 0.5 watt

$R_4=220000$  ohms, 0.5 watt  
 $R_5=1000$  ohms, 0.5 watt  
 $R_6 R_9=47000$  ohms, 0.5 watt  
 $R_7=4700$  ohms, 0.5 watt  
 $R_8=1$  megohm, 0.5 watt  
 $R_{10}=1800$  ohms, 0.5 watt

(21-19)

**LOW-DISTORTION PREAMPLIFIER**

For Low-Output High-Impedance Microphones

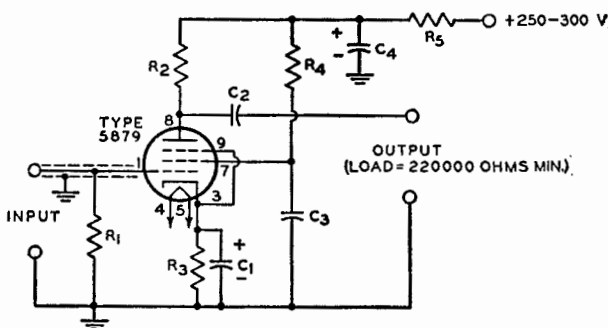

$C_1=25 \mu\text{f}$ , electrolytic, 25 v.  
 $C_2=0.047 \mu\text{f}$ , paper, 400 v.  
 $C_3=0.22 \mu\text{f}$ , paper, 400 v.

$C_4=40 \mu\text{f}$ , electrolytic, 450 v.  
 $R_1=2.2$  megohms, 0.5 watt  
 $R_2=0.1$  megohm, 0.5 watt

$R_3=1000$  ohms, 0.5 watt  
 $R_4=0.47$  megohm, 0.5 watt  
 $R_5=22000$  ohms, 0.5 watt

Sensitivity=3 millivolts for output of 220 millivolts

(21-20)

### TWO-STAGE INPUT AMPLIFIER Cathode-Follower (Low-Impedance) Output

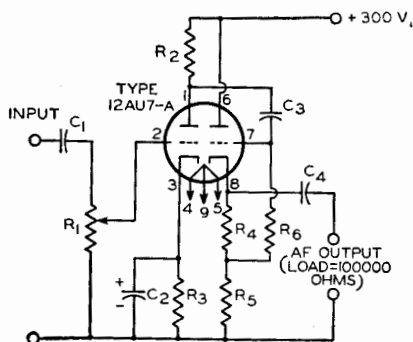

$C_1$   $C_3$  = 0.1  $\mu$ f, paper, 400 v.  
 $C_2$  = 25  $\mu$ f, electrolytic, 25 v.  
 $C_4$  = 0.5  $\mu$ f, paper, 200 v.

$R_1$  = Volume control, potentiometer, 500000 ohms  
 $R_4$  = 220000 ohms, 0.5 watt

$R_2$   $R_3$  = 5600 ohms, 0.5 watt  
 $R_5$  = 27000 ohms, 0.5 watt  
 $R_6$  = 560000 ohms, 0.5 watt

(21-21)

### BASS AND TREBLE TONE-CONTROL AMPLIFIER STAGE

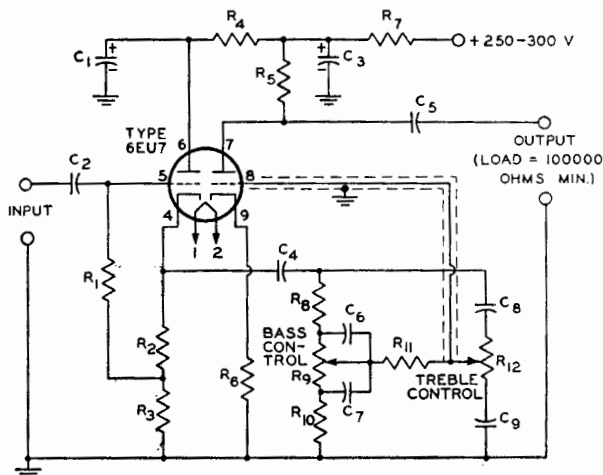

$C_1$   $C_2$  = 20  $\mu$ f, electrolytic, 450 v.  
 $C_3$  = 0.047  $\mu$ f, paper, 400 v.  
 $C_4$  = 0.1  $\mu$ f, paper, 400 v.  
 $C_5$  = 0.22  $\mu$ f, paper, 400 v.  
 $C_6$  = 0.0022  $\mu$ f, paper, 400 v.  
 $C_7$  = 0.022  $\mu$ f, paper, 400 v.  
 $C_8$  = 220  $\mu$ f, ceramic or mica, 500 v.

$C_9$  = 0.0022  $\mu$ f, paper, 400 v.  
 $R_1$  = 0.47 megohm, 0.5 watt  
 $R_2$  = 1500 ohms, 0.5 watt  
 $R_3$   $R_7$  = 15000 ohms, 0.5 watt  
 $R_4$  = 22000 ohms, 0.5 watt  
 $R_8$   $R_9$   $R_{11}$  = 0.1 megohm, 0.5 watt

$R_6$  = 1000 ohms, 0.5 watt  
 $R_9$  = Bass control, potentiometer, 1 megohm  
 $R_{10}$  = 10000 ohms, 0.5 watt  
 $R_{12}$  = Treble control, potentiometer, 1 megohm

Sensitivity = 0.5 volt rms for output of 1.25 volts with controls set for flat response.



(21-22)

### AUDIO CONTROL UNIT With Volume and Tone Controls

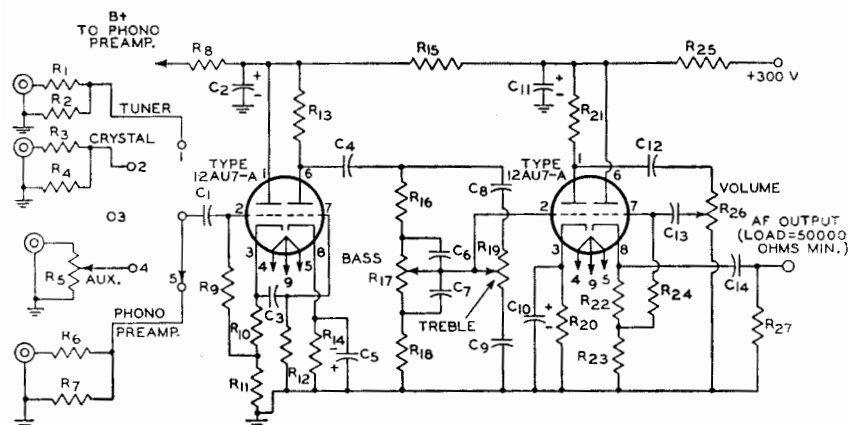

$C_1$   $C_7$  = 0.01  $\mu$ f, paper, 400 v.  
 $C_2$   $C_{11}$  = 20  $\mu$ f, electrolytic, 450 v.  
 $C_3$   $C_4$  = 0.1  $\mu$ f, paper, 400 v.  
 $C_5$   $C_{13}$  = 25  $\mu$ f, electrolytic, 25 v.  
 $C_6$  = 0.001  $\mu$ f, paper, 400 v.  
 $C_8$  = 470  $\mu$ f, mica, 300 v.  
 $C_9$  = 4700  $\mu$ f, mica, 300 v.  
 $C_{12}$   $C_{14}$  = 0.47  $\mu$ f, paper, 400 v.  
 $C_{13}$  = 0.033  $\mu$ f, paper, 400 v.  
 $R_1$   $R_2$   $R_3$  = 270000 ohms, 0.5 watt  
 $R_4$  = 1.5 megohms, 0.5 watt

$R_4$  = 2 megohms, 0.5 watt  
 $R_5$  = Potentiometer, 500000 ohms, audio taper  
 $R_6$  = 330000 ohms, 0.5 watt  
 $R_7$   $R_{13}$   $R_{21}$  = 15000 ohms, 0.5 watt  
 $R_8$  = 560000 ohms, 0.5 watt  
 $R_{10}$  = 2200 ohms, 0.5 watt  
 $R_{11}$   $R_{16}$  = 220000 ohms, 0.5 watt  
 $R_{12}$   $R_{27}$  = 1 megohm, 0.5 watt  
 $R_{13}$   $R_{21}$  = 100000 ohms, 0.5 watt

$R_{14}$  = 1200 ohms, 0.5 watt  
 $R_{17}$   $R_{19}$  = Potentiometers, 500000 ohms, audio taper  
 $R_{18}$  = 22000 ohms, 0.5 watt  
 $R_{20}$  = 2700 ohms, 0.5 watt  
 $R_{22}$  = 5600 ohms, 0.5 watt  
 $R_{23}$  = 27000 ohms, 0.5 watt  
 $R_{24}$  = 470000 ohms, 0.5 watt  
 $R_{25}$  = Potentiometer, 100000 ohms, audio taper

(21-23)

### PREAMPLIFIER FOR AMATEUR RECEIVER FOR 10-METER (30-MEGACYCLE) BAND Power Gain, 25 to 35 db

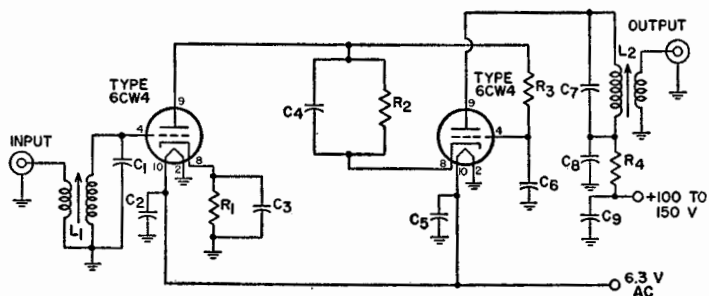

$C_1$   $C_7$  = 5  $\mu$ f, 500 v., mica  
 $C_2$   $C_3$   $C_4$   $C_5$   $C_6$   $C_8$   $C_9$  = 0.001  $\mu$ f, 500 v., ceramic  
 $L_1$   $L_2$  = 18 turns, Input and output Enam. copper wire wound

on  $\frac{1}{4}$ " I.D. slug-tuned form.  
 $L_1$  tuned to 32 Mc;  $L_2$  to 29.5 Mc. Input and output link,  $1\frac{1}{2}$  turns. Input and output impedance, 75 ohms.

$R_1$   $R_2$  = 100 ohms, 0.5 watt  
 $R_3$  = 470000 ohms, 0.5 watt  
 $R_4$  = 1000 ohms, 0.5 watt

(21-24)

### INTERCOMMUNICATION SET

With Master Unit and Two or More Remote Units

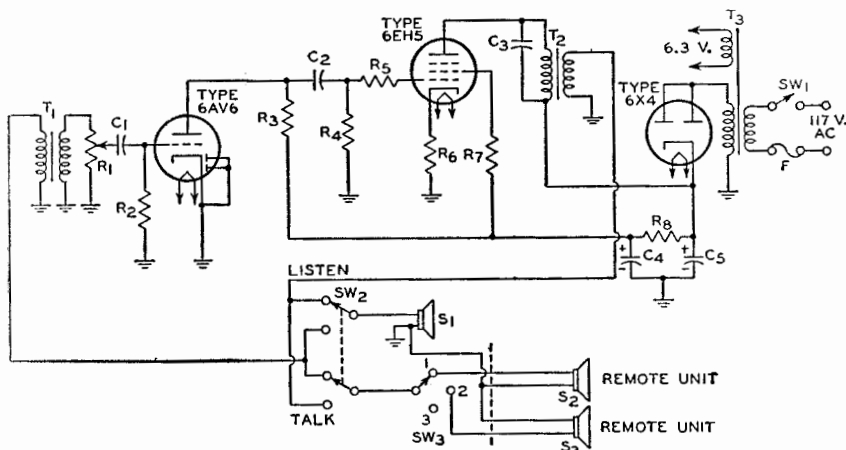

$C_1$   $C_2$ =0.0022  $\mu$ f, paper, 200 v.  
 $C_3$ =0.005  $\mu$ f, paper, 200 v.  
 $C_4$   $C_5$ =60  $\mu$ f, electrolytic, 150 v.  
 F=Fuse, 1 ampere  
 $R_1$ =Volume control, potentiometer, 500000 ohms, audio taper  
 $R_2$ =6.8 megohms, 0.5 watt  
 $R_3$   $R_4$ =470000 ohms, 0.5 watt  
 $R_5$ =10000 ohms, 0.5 watt

$R_6$   $R_7$ =68 ohms, 0.5 watt  
 $R_8$ =2500 ohms, 1 watt  
 $S_1$   $S_2$   $S_3$ =Speaker, permanent-magnet, voice-coil impedance 3-4 ohms  
 $SW_1$ =On-off switch, single-pole single-throw, attached to volume control  $R_1$   
 $SW_2$ =Talk-listen switch, double-pole double-throw

$SW_3$ =Station-selector switch, rotary  
 $T_1$ =Input transformer, 4-ohm primary, 25000-ohm secondary  
 $T_2$ =Output transformer, 3000-ohm primary, 4-ohm secondary  
 $T_3$ =Power transformer, 125 volts rms, 50 ma., 6.3 volts rms, 2 amperes

NOTES: The leads from the LISTEN-TALK switch to  $T_1$  and  $T_2$  should be kept as far apart as possible to prevent undesirable regeneration effects.  
 Connections to the remote speaker units should be made with low-resistance wire, preferably shielded "intercom" cable.

(21-25)

### CODE-PRACTICE OSCILLATOR

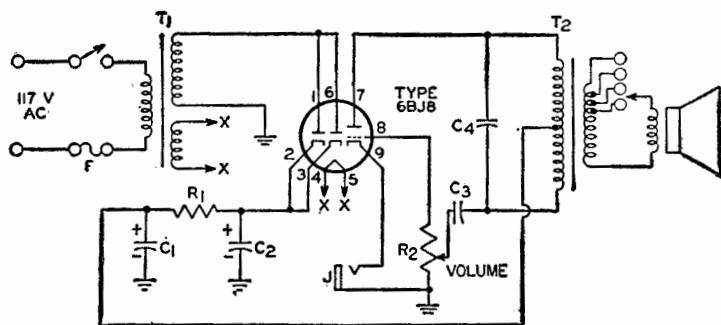

$C_1$   $C_2$ =20  $\mu$ f, electrolytic, 150 v.  
 $C_3$ =0.001  $\mu$ f, paper, 200 v.  
 $C_4$ =0.03  $\mu$ f, paper, 200 v.  
 F=1/8 ampere

J=Input jack for key  
 $R_1$ =1500 ohms, 1 watt  
 $R_2$ =Potentiometer, 100000 ohms, 0.5 watt  
 $T_1$ =Power transformer, 125

volts rms, 15 ma; 6.3 volts, 0.6 ampere  
 $T_2$ =Output transformer, universal

NOTE: Select any two terminals of secondary of  $T_2$  to give desired tone.

(21-26)

## ELECTRONIC VOLT-OHM METER

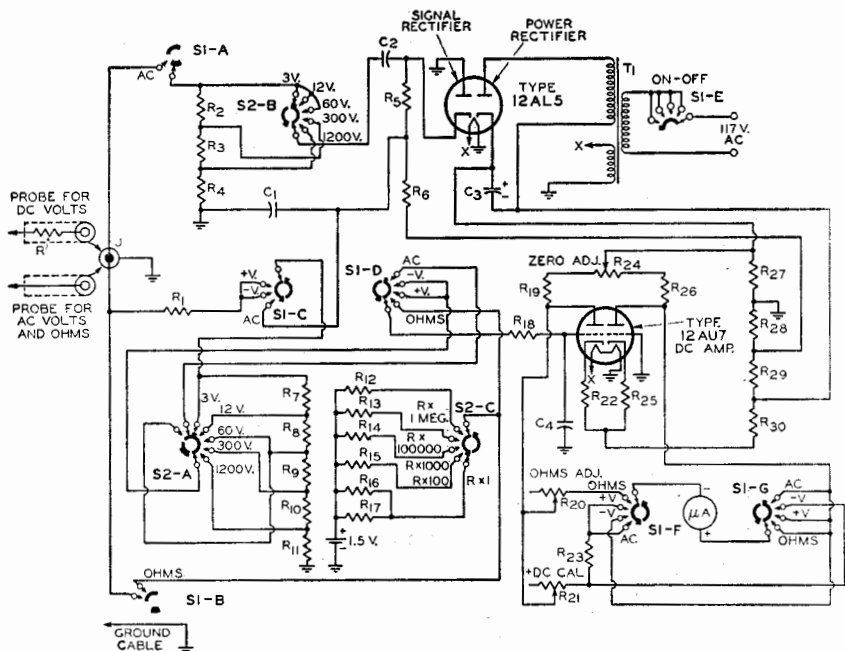

$C_1 = 0.1 \mu\text{f}$ , paper, 200 v.  
 $C_2 = 0.33 \mu\text{f} \pm 10$  per cent, paper, 400 v.  
 $C_3 = 10 \mu\text{f}$ , electrolytic, 250 v.  
 $C_4 = 0.01 \mu\text{f}$ , paper, 400 v.  
 $R$  = DC-voltage probe isolating resistor, 1 megohm  $\pm 5$  per cent, 0.5 watt  
 $R_1 = 5$  megohms  $\pm 1$  per cent, 0.5 watt  
 $R_2 = 800000$  ohms  $\pm 1$  per cent, 0.5 watt  
 $R_3 = 1.36$  megohms  $\pm 1$  per cent, 0.5 watt  
 $R_4 = 250000$  ohms  $\pm 1$  per cent, 0.5 watt  
 $R_5 = 678000$  ohms  $\pm 1$  per cent, 0.5 watt  
 $R_6 = 361000$  ohms  $\pm 1$  per cent, 0.5 watt  
 $R_7 = 3.75$  megohms  $\pm 1$  per cent, 0.5 watt  
 $R_8 = 1$  megohm  $\pm 1$  per cent, 0.5 watt

$R_9 = 200000$  ohms  $\pm 1$  per cent, 0.5 watt  
 $R_{10} = 37500$  ohms  $\pm 1$  per cent, 0.5 watt  
 $R_{11} = 12500$  ohms  $\pm 1$  per cent, 0.5 watt  
 $R_{12} = 10$  megohms  $\pm 5$  per cent, 0.5 watt  
 $R_{13} R_{18} = 1$  megohm  $\pm 5$  per cent, 0.5 watt  
 $R_{14} = 10000$  ohms  $\pm 5$  per cent, 0.5 watt  
 $R_{15} = 1000$  ohms  $\pm 5$  per cent, 1 watt  
 $R_{16} = 10$  ohms  $\pm 5$  per cent, 2 watts  
 $R_{17} = 330$  ohms  $\pm 5$  per cent, 0.5 watt  
 $R_{19} = 15000$  ohms  $\pm 5$  per cent, 0.5 watt  
 $R_{20} =$  Potentiometer, 15000 ohms, 0.5 watt  
 $R_{21} =$  Potentiometer, 7500 ohms, 0.5 watt

$R_{22} R_{25} = 1500$  ohms  $\pm 5$  per cent, 0.5 watt  
 $R_{23} = 470$  ohms  $\pm 5$  per cent, 0.5 watt  
 $R_{24} =$  Potentiometer, 12500 ohms, 0.5 watt  
 $R_{26} = 12000$  ohms  $\pm 5$  per cent, 0.5 watt  
 $R_{27} = 47000$  ohms  $\pm 5$  per cent, 0.5 watt  
 $R_{28} = 130$  ohms  $\pm 5$  per cent, 0.5 watt  
 $R_{29} R_{30} = 68000$  ohms  $\pm 5$  per cent, 0.5 watt  
 $S_1 =$  Function-selector switch, 7-circuit, 5-position  
 $S_2 =$  Range-selector switch, 4-circuit, 5-position  
 $T_1 =$  Power transformer, 125 volts rms, 2.75 ma; 10 volts rms, 0.25 ampere  
 $\mu\text{A} =$  Meter, dc, 0-200  $\mu\text{A}$

In the diagram the FUNCTION-SELECTOR SWITCH ( $S_1$ ) and RANGE-SELECTOR SWITCH ( $S_2$ ) are shown in their *maximum counterclockwise* positions ( $S_1 =$  "OFF";  $S_2 =$  "3 VOLTS,  $R \times 1$ ")

**NOTE:** This electronic volt-ohm meter circuit, similar to those used in RCA VoltOhmyst†, is included here solely to illustrate a particular application of RCA Receiving Tubes. It is not recommended for home construction because of the large number of special components required.

For home construction of an electronic volt-ohm meter, a complete kit such as RCA-WV-77E (K) is recommended.

† Trade Mark Reg. U. S. Pat. Off.

# Outlines

## METAL TUBES—Outlines 1-7A

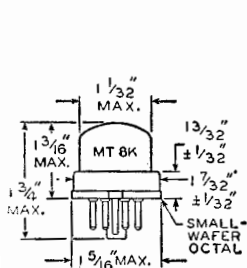

-1-

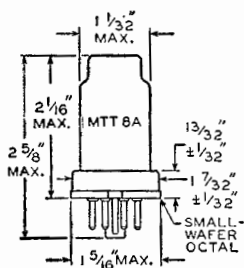

-2-

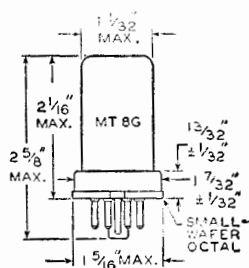

-3-

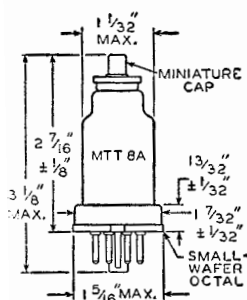

-4-

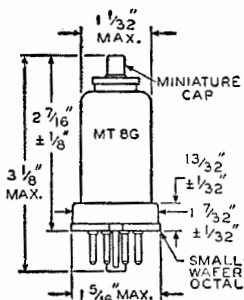

-5-

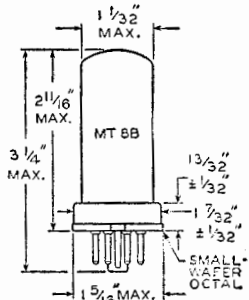

-6-

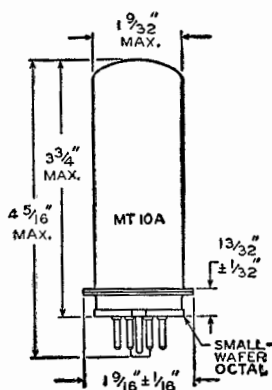

-7-

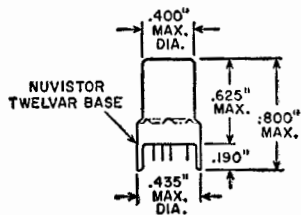

-7A-

GLASS TUBES—Outlines 8-19

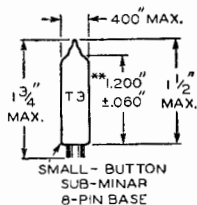

-8-

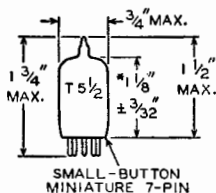

-9-

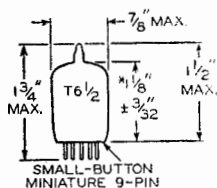

-10-

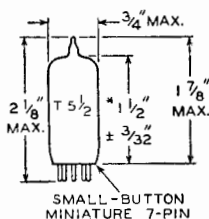

-11-

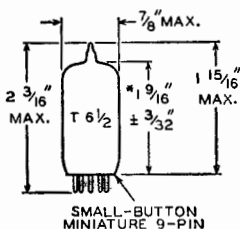

-12-

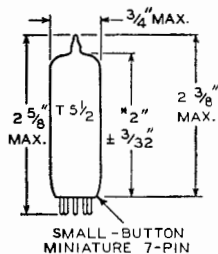

-13-

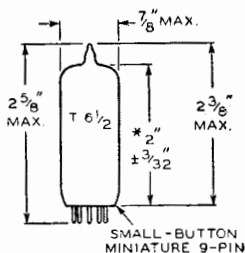

-14-

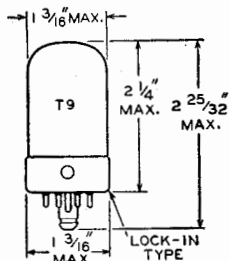

-15-

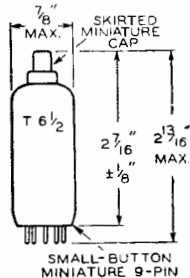

-16-

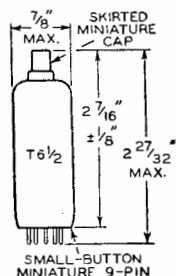

-17-

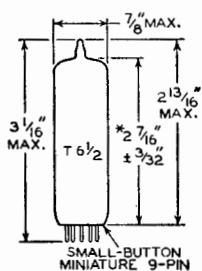

-18-

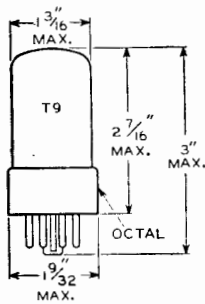

-19-

\* MEASURED FROM BASE SEAT TO BULB TOP LINE AS DETERMINED BY RING GAUGE OF 7/16" I.D.  
 \*\* MEASURED FROM BASE SEAT TO BULB TOP LINE AS DETERMINED BY RING GAUGE OF .210" I.D.

GLASS TUBES—Outlines 20-28

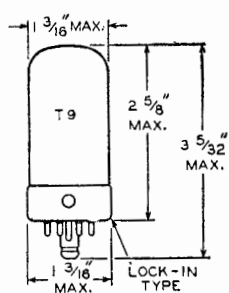

-20-

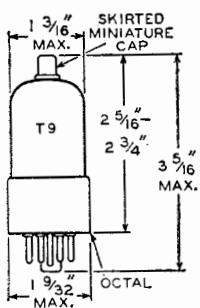

-21-

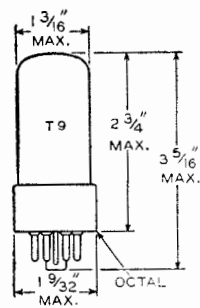

-22-

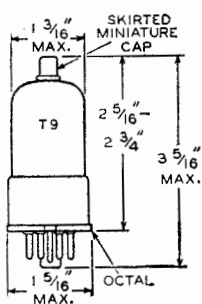

-23-

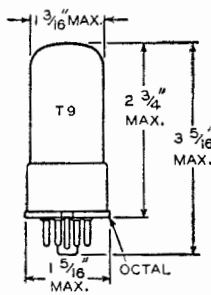

-24-

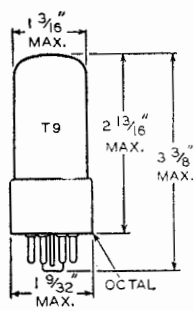

-25-

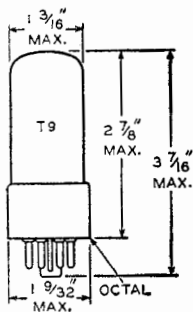

-26-

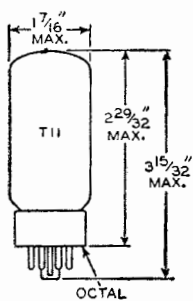

-27-

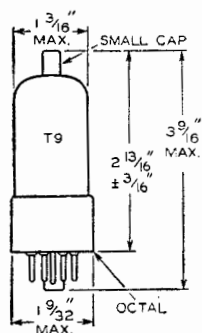

-28-

GLASS TUBES—Outlines 29-37

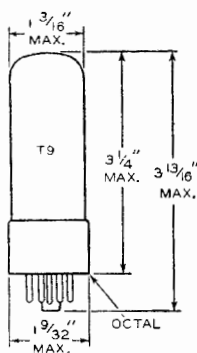

-29-

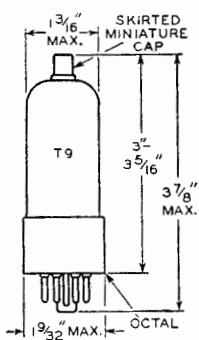

-30-

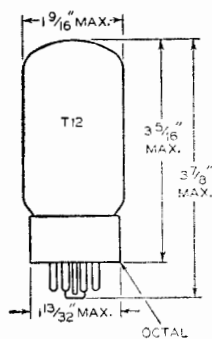

-31-

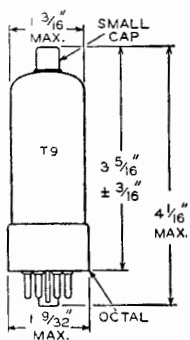

-32-

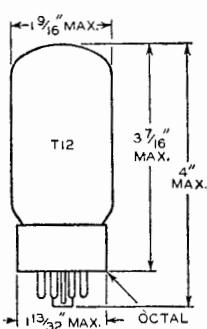

-33-

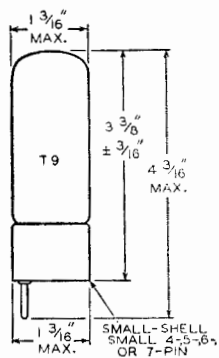

-34-

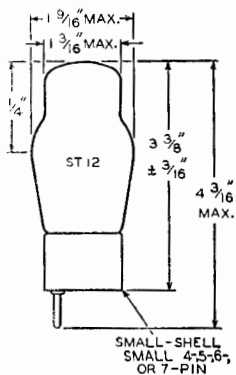

-35-

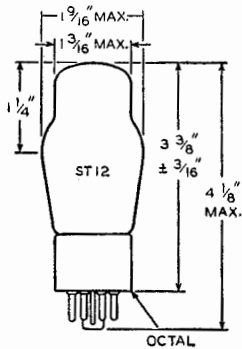

-36-

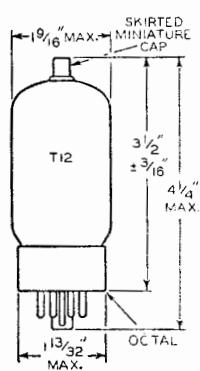

-37-

GLASS TUBES—Outlines 38-46

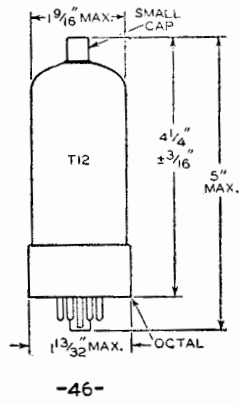
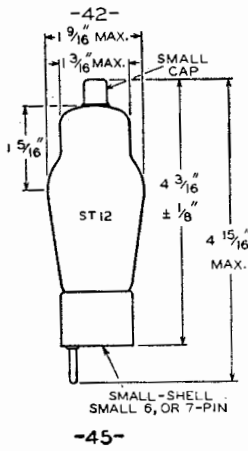
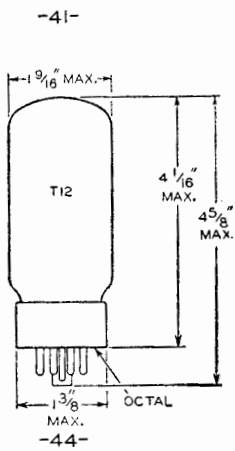
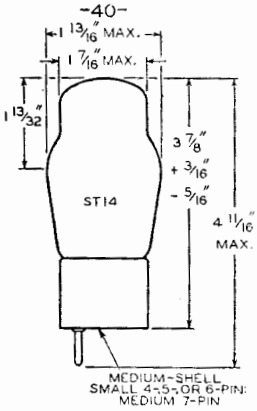
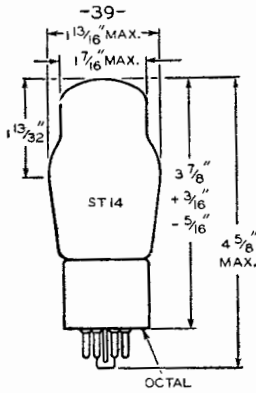
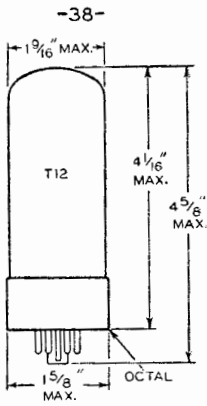
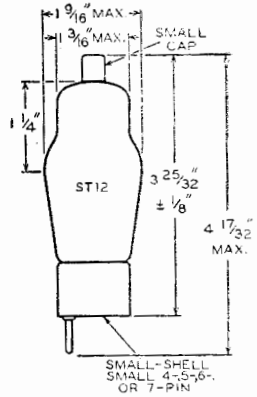
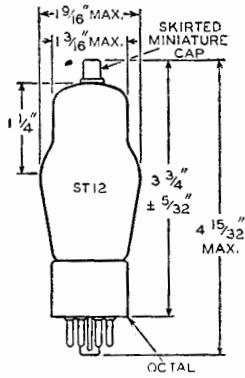
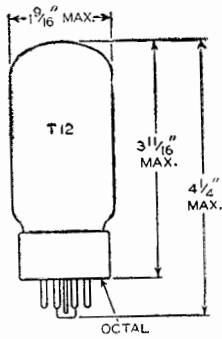



GLASS TUBES—Outlines 47-55

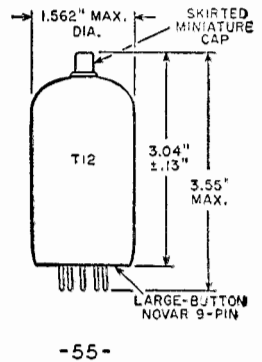
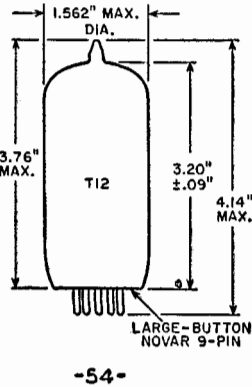
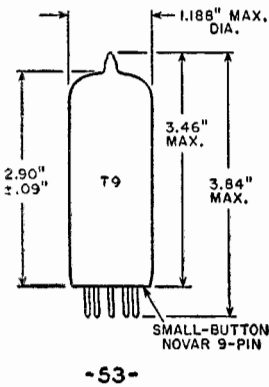
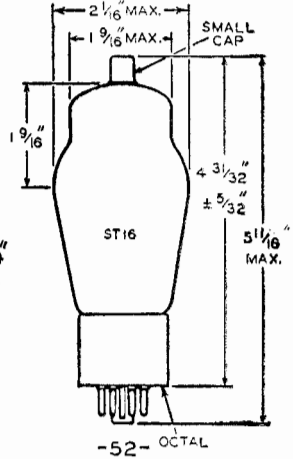
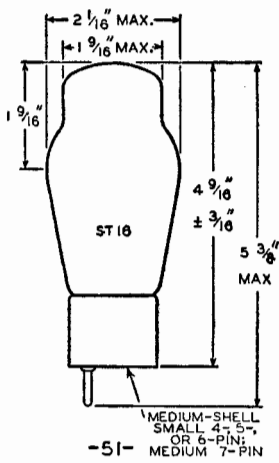
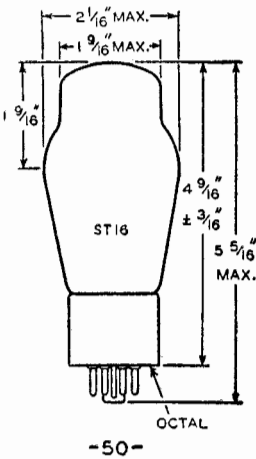
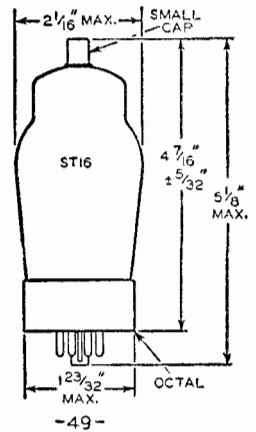
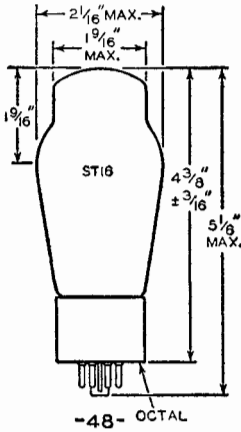
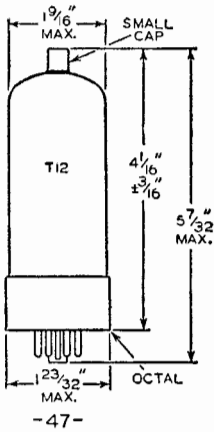

# Index

## A

	<i>Page</i>
Absolute Maximum System of Ratings.....	65
AC/DC Superheterodyne Receiver.....	448
AC-Operated Superheterodyne Receiver.....	447
Admittance, Input.....	15
Amplification Factor ( $\mu$ ).....	11
Amplifier:	
audio control unit, circuit.....	463
audio-frequency.....	13
audio mixer, circuit.....	460
cathode-drive.....	25
cathode-follower.....	25, 28
cathode-follower, circuit.....	462
class A.....	13, 16
class AB.....	13, 21
class AB <sub>1</sub> .....	22
class AB <sub>2</sub> .....	24
class B.....	13, 25
class C.....	13
de.....	47
high-fidelity.....	457-459
limiter.....	34, 43
low-distortion input, circuit.....	461
luminance.....	35
parallel.....	16
phase-inverter.....	31
preamplifier, circuit.....	460, 461
push-pull.....	16, 19
radio-frequency.....	13, 34
remote-cutoff.....	15, 47
resistance-coupled.....	14, 27, 434
sharp-cutoff.....	47
sync.....	36
television.....	34
tone-control.....	32
tone-control, circuit.....	462
video.....	35
voltage.....	13
volume-expander.....	31
Amplitude Modulation (AM).....	39
Anode.....	5
Arc-Back Limit.....	68
Audio Control Unit with Volume and Tone Controls.....	463
Audio Mixer.....	460
Automatic Frequency Control (AFC).....	53
Automatic Gain Control (AGC).....	44, 45
Automatic Volume Control (AVC).....	44
Automobile Receiver.....	449

## B

Bass and Treble Tone-Control Amplifier Stage.....	462
Beam Power Tubes.....	8
Bias:	
battery.....	57
cathode (self).....	57
diode.....	41
grid-resistor.....	42, 57, 58
self-cathode.....	57

## C

Calculation of: amplification factor.....	11
--	----

## Page

cathode (self-bias) resistor.....	57
cathode load resistor.....	30
control-grid-plate transconductance.....	12
filament resistor power dissipation.....	56
filament (or heater) resistor value.....	55
harmonic distortion.....	18, 20, 21
heater warm-up time.....	65
load resistance.....	18, 19
operating conditions from conversion nomograph.....	20
peak in verse plate voltage.....	68
plate efficiency.....	12
plate resistance.....	11
power output.....	17, 19, 20, 23
power sensitivity.....	12
screen-grid voltage dropping resistor.....	66
transconductance.....	12, 29
voltage amplification (gain).....	14, 28, 30
Capacitor-Input Filter.....	62
Cathode:	
bias.....	57
bypassing.....	58
connection.....	57
current.....	56
directly heated.....	3
drive.....	25
follower.....	25, 28, 462
indirectly heated.....	4
ionic-heated.....	6
resistor.....	58
types.....	3
Characteristic Curves, Interpretation of.....	67
Characteristics:	
amplification factor.....	11
control-grid-plate transconductance.....	12
conversion transconductance.....	12
dynamic.....	11
plate resistance.....	11
static.....	11
Charts and Tables:	
grid-No. 2 input rating chart.....	66
picture tube characteristics chart.....	427
outline drawings.....	466
resistance-coupled amplifier.....	434
tube-part materials.....	70
types not recommended for new equipment design.....	Inside Back Cover
Choke-Input Filter.....	62
Chrominance Channel.....	36
Circuit Diagram of:	
ac/dc superheterodyne receiver (21-4).....	448
ac-operated superheterodyne receiver (21-3).....	447
audio-control unit (21-22).....	463
automobile receiver (21-5).....	449
bass and treble tone-control amplifier stage (21-21).....	462
code practice oscillator (21-25).....	464
electronic volt-ohm meter (21-26).....	465
FM tuner (21-8).....	452
high-fidelity, 15-w audio amplifier (21-13).....	457
high-fidelity, 30-w audio amplifier (21-14).....	458
high-fidelity, 50-w audio amplifier (21-15).....	459

# INDEX (Continued)

	<i>Page</i>		<i>Page</i>
intercommunication set (21-24) . . . . .	464	<b>E</b>	
low-distortion preamplifier (21-19) . . . . .	461	Electron:	
microphone and phonograph preamplifier (21-12) . . . . .	456	considerations . . . . .	3
phonograph amplifier (21-9) . . . . .	454	secondary . . . . .	8, 9
portable superheterodyne receiver (21-1) . . . . .	445	Electronic Volt-Ohm Meter . . . . .	465
portable 3-way superheterodyne receiver (21-2) . . . . .	446	Electrons, Electrodes, and Electron Tubes . . . . .	3
preamplifier for 10-m, 30-Mc amateur receiver (21-23) . . . . .	463	Electron Tube Application . . . . .	13
preamplifier for ceramic phonograph- pickup (21-18) . . . . .	461	Electron Tube Characteristics . . . . .	11
preamplifier for magnetic phonograph- pickup (21-17) . . . . .	460	Electron Tube Installation . . . . .	55
superregenerative (144-Mc) receiver (21-6) . . . . .	450	Electron Tube Testing . . . . .	131
TRF AM tuner (21-7) . . . . .	451	Electron-Ray Tubes . . . . .	46
two-channel audio mixer (21-16) . . . . .	460	Emission:	
two-channel, 1-w stereo amplifier (21-10) . . . . .	454	current . . . . .	5
two-channel, 3.5-w stereo amplifier (21-11) . . . . .	455	secondary . . . . .	8, 9
two-stage input amplifier (21-20) . . . . .	462	test . . . . .	132
Code Practice Oscillator . . . . .	464	<b>F</b>	
Contact Potential . . . . .	59	Feedback, Inverse . . . . .	26
Conversion Nomograph, Use of . . . . .	20	Filament (also see Heater and Cathode):	
Conversion Transconductance . . . . .	12	operation . . . . .	3, 55
Corrective Filter . . . . .	30	resistor . . . . .	56
Cross-Modulation . . . . .	15, 59	series operation . . . . .	55
Current:		shunt resistor . . . . .	56
cathode . . . . .	56	supply voltage . . . . .	55
de output . . . . .	67	Filter:	
grid . . . . .	13, 22	capacitor-input . . . . .	62
peak plate . . . . .	68	choke-input . . . . .	62
plate . . . . .	5	corrective . . . . .	30
Curves, Interpretation of Characteristic . . . . .	69	radio-frequency . . . . .	62
Cutoff . . . . .	15, 71	smoothing . . . . .	62
<b>D</b>		FM Tuner . . . . .	152
DC Amplifier . . . . .	47	Formulas (see Calculation)	
Deflection Circuits:		Frequency Conversion . . . . .	51
horizontal output . . . . .	50	Frequency Modulation (FM) . . . . .	39, 42
vertical output . . . . .	49	Full-Wave Diode Detection . . . . .	40
Degeneration (See Inverse Feedback) . . . . .	26	Full-Wave Rectifier . . . . .	5, 38
Delayed Automatic Volume Control (DAVC) . . . . .	45	Fuses, Use of . . . . .	57
Demodulation . . . . .	39	<b>G</b>	
Design-Center System of Ratings . . . . .	65	Gain (Voltage Amplification) . . . . .	14
Design-Maximum System of Ratings . . . . .	65	Generic Tube Types . . . . .	4
Detection:		Grid:	
diode . . . . .	40	anode . . . . .	52
discriminator . . . . .	43	bias . . . . .	57-60
full-wave diode . . . . .	40	bias detection . . . . .	41
grid bias . . . . .	41	control . . . . .	6, 7
grid resistor and capacitor . . . . .	42	current . . . . .	13, 22
ratio detector . . . . .	43	resistor . . . . .	14, 57, 58
Diode:		resistor and capacitor detection . . . . .	41
biasing . . . . .	41	screen . . . . .	7
considerations . . . . .	5	suppressor . . . . .	8
detection . . . . .	40	voltage supply . . . . .	57, 58
loud resistor . . . . .	41	Grid-Plate Capacitance . . . . .	7
Discriminator . . . . .	43	Grid-Plate Transconductance . . . . .	12
Dress of Circuit Leads . . . . .	61	<b>H</b>	
Driver . . . . .	16, 22, 24	Half-Wave Rectifier . . . . .	5, 38
Dynamic Characteristics . . . . .	11	Harmonic Distortion . . . . .	18, 20, 24
		Heater:	
		cathode . . . . .	4
		cathode bias . . . . .	57

## INDEX (Continued)

	<i>Page</i>		<i>Page</i>
cathode connection.....	57	Outlines of Tubes.....	466
resistor.....	57	Output Capacitance.....	69
series operation.....	56	Output Circuits:	
shunt resistor.....	57	horizontal.....	50
supply voltage.....	55	vertical.....	49
warm-up time.....	65	Output-Coupling Devices.....	63
Hexode Mixer.....	53		
High-Fidelity, 15-w Audio Amplifier.....	457	<b>P</b>	
High-Fidelity, 30-w Audio Amplifier.....	458	Parallel Operation.....	16, 38
High-Fidelity, 50-w Audio Amplifier.....	459	Peak Inverse Plate Voltage.....	68
High-Voltage Regulation.....	51	Peak Plate Current.....	68
Horizontal Output Circuits.....	50	Pentagrid Converter.....	9, 52
Hum and Noise Characteristics.....	69	Pentagrid Mixer.....	31, 53
		Pentode Considerations.....	8
<b>I</b>		Phase Inverter.....	31
Impedance, Input.....	15	Phonograph Amplifier.....	454
Input Capacitance.....	69	Picture Tube:	
Instantaneous Peak Voltage.....	62	basing diagrams.....	428-430
Intercommunication Set.....	464	characteristics chart.....	427
Interelectrode Capacitances.....	7, 69	corona considerations.....	63
Intermediate Frequency, Production of.....	51	deflection.....	10
Interpretation of Tube Data.....	65	dust considerations.....	63
Inverse Feedback:		essential elements.....	10
constant-current type.....	27	handling precautions.....	64
constant-voltage type.....	26	high-voltage considerations.....	63
		humidity considerations.....	63
<b>K</b>		safety considerations.....	64
Key: Basing Diagrams.....	Inside Front Cover	screen.....	10
Kinescopes.....	10	structure.....	10
		x-ray radiation precautions.....	64
		Plate:	
<b>L</b>		current.....	5
Limiters.....	34	dissipation.....	65
Load:		efficiency.....	12
resistance.....	19, 20	load.....	19
resistance line.....	17, 22	resistance.....	11
Low-Distortion preamplifier.....	461	voltage supply.....	57
Luminance Amplifier.....	35	Plate-Cathode Capacitance.....	7, 69
		Portable Superheterodyne Receiver.....	445
<b>M</b>		Portable 3-Way Superheterodyne Receiver.....	446
Mercury-Vapor Rectifier:		Power Output:	
considerations.....	6	calculations.....	17, 19, 20, 23
interference from.....	62	test.....	433
Mho-micromho.....	12	Power Sensitivity.....	12
Microphone and Phonograph Amplifier.....	456	Power Supply.....	55
Mixer:		Preamplifier for Ceramic Phonograph Pickup.....	461
audio.....	460	Preamplifier for Magnetic Phonograph Pickup.....	460
hexode.....	53	Push-Pull Operation.....	16, 19
pentagrid.....	53		
Modulated Wave.....	39, 42	<b>R</b>	
Modulation.....	39	Radio-Frequency:	
Modulation-Distortion.....	15, 59	amplifier.....	13, 34
Multi-Electrode and Multi-Unit Tubes.....	9	filter.....	62
Multivibrator.....	48	Ratings:	
Mutual Conductance (see Transconductance)		absolute-maximum system.....	65
		design-center system.....	65
<b>O</b>		design-maximum system.....	65
Oscillator:		Ratio Detector.....	43
considerations.....	47	Reading List.....	480
multivibrator.....	48	Receiving Tube Chart.....	71
relaxation.....	48		
synchroguide.....	48		

# INDEX (Continued)

	<i>Page</i>		<i>Page</i>
Rectifiers:		Television RF Amplifiers	34
full-wave	5, 37	Television Sync Circuits	36
half-wave	5, 37	Testing Electron Tubes	431
ionic-heated cathode	6	Tetrode Considerations	7
parallel operation of	38	Tone-Control Amplifier Stage	462
plate-characteristics curves	67	Tone Control	32
voltage doubler	38	Transconductance:	
Relaxation Oscillator	48	conversion	12
Remote-Cutoff Tubes	15, 47	grid-plate	12
Resistance-Coupled Amplifier	14, 27, 434	test	432
Resistance Coupling	31	TRF AM Tuner	451
Resistor:		Triode Considerations	6
cathode (self-biasing)	57	Tube:	
center tap	57	outlines	466
filament	55	ratings, interpretation of	65
filter	61	tester requirements	433
grid	14	Tube Types, Technical Data	77
plate load	19, 20	Tuner:	
screen-grid	60, 66	FM	452
		TRF AM	451
<b>S</b>		Tuning Indicators	46
Saturation Current	5	Twin diode—triode	9, 40
Screen Grid (Grid No. 2):		Two-Channel Audio Mixer	460
considerations	7	Two-Channel Stereophonic Amplifier	454, 455
input	66	Two-Stage Input Amplifier, Cathode-Follower (Low-Impedance) Output	462
voltage supply	60	Typical Operation Values, Interpretation of	69
Secondary Electrons	8, 9	Typical Tube-Part Materials	70
Secondary Emission	8		
Self Bias (cathode bias)	57	<b>V</b>	
Shielding	60	Vertical Output Circuits	49
Short-Circuit Test	431	Video Amplifiers	35
Space Charge	5, 9	Voltage:	
Static Characteristics	11	amplification, class A	13
Superheterodyne Receiver:		doubler rectifier	38
ac dc	448	peak heater-cathode	67
ac-operated	447	peak inverse plate	68
portable	445	supply	55
portable 3-way	446	Voltage Doubler	38
Superregenerative Receiver	450	Volume Control:	
Suppressor Grid (Grid No. 3)	8	automatic (AVC)	44
Symbols Used in Resistance-Coupled Amplifier Charts	435	by grid-voltage variation	59
Sync Circuits	36	by screen-grid-voltage variation	60
Synchroguide	48	delayed automatic (DAVC)	45
		Volume Expander	31
<b>T</b>			
Tables and Charts (see Charts and Tables)	77	<b>Z</b>	
Technical Data for Tube Types	77	Zero-Bias Operation	57
Television Picture Tubes	10		

# RCA Technical Publications

*on Tubes, Semiconductor Products, Electronic Components, Batteries, and Test and Measuring Equipment*

Copies of the publications listed below may be obtained from your RCA distributor or from Commercial Engineering, Radio Corporation of America, Harrison, N. J.

## Electron Tubes

- **RCA ELECTRON TUBE HANDBOOK**—HB-3. Five binders, each  $7\frac{3}{8}''$  L x  $5\frac{5}{8}''$  W x  $2\frac{7}{8}''$  D, having gold-imprinted black covers. The "bible" of the industry—contains over 5000 pages of loose-leaf data and curves on RCA receiving tubes, transmitting tubes, cathode-ray tubes, picture tubes, photocells, phototubes, camera tubes, ignitrons, vacuum and gas rectifiers, magnetrons, traveling-wave tubes, premium tubes, pencil tubes, and other miscellaneous types for special applications. Available on subscription basis. Price \$20.00\* including service for first year. Also available with RCA Semiconductor Products Handbook HB-10 at special combination price of \$25.00.\* Write to Commercial Engineering for descriptive flyer and order form.
- **RCA RECEIVING TUBE MANUAL**—RC-21 ( $8\frac{1}{4}''$  x  $5\frac{5}{8}''$ )—480 pages. Revised, expanded, and brought up to date. Contains technical data on 903 receiving tubes and 106 picture tubes for black-and-white and color television. Features tube theory written for the layman, application data for radio and television circuits, Resistance-Coupled Amplifier Section, new receiving-tube and picture-tube charts, and several circuits for high-fidelity audio amplifiers. Features lie-flat binding. Price \$1.00.\*
- **RADIOTRON† DESIGNER'S HANDBOOK**—4th Edition ( $8\frac{3}{4}''$  x  $5\frac{1}{2}''$ )—1500 pages. Comprehensive reference thoroughly covering the design of radio and audio circuits and equipment. Written for the design engineer, student, and experimenter. Contains 1000 illustrations, 2500 references, and cross-referenced index of 7000 entries. Edited by F. Langford-Smith of Amalgamated Wireless Valve Co., Pty., Ltd. in Australia. Price \$7.00.\*
- **RCA MAGNETRONS AND TRAVELING-WAVE TUBES**—MT-301A ( $10\frac{7}{8}''$  x  $8\frac{3}{8}''$ )—48 pages. Operating theory for magnetrons and traveling-wave tubes, application considerations, and techniques for measurement of electrical parameters. Price 60 cents.\*
- **RCA TRIPLE PINDEX**—PINDEX-109 ( $8\frac{1}{4}''$  x  $5\frac{1}{4}''$ )—240 pages. Gives base diagrams for more than 2000 JEDEC-registered receiving types including picture tubes. Base diagrams of over 1500 receiving types are presented in triplicate to provide the user with any three base diagrams at any one time. More than 200 small industrial-receiving types and more than 200 foreign receiving types are cross-referenced to the receiving-tube section for base diagrams. Price \$1.75.\*
- **RCA INTERCHANGEABILITY DIRECTORY OF FOREIGN vs. U.S.A. RECEIVING-TYPE ELECTRON TUBES**—1CE-197A ( $8\frac{3}{8}''$  x  $10\frac{7}{8}''$ )—4 pages. Covers approximately 500 foreign tube types used principally in AM and FM radios, TV receivers, and audio amplifiers. Indicates U.S.A. direct replacement type or similar type if available. Single copy free on request.
- **RCA HIGH-FIDELITY AMPLIFIER CIRCUITS BOOKLET**—HF-110 ( $8\frac{3}{8}''$  x  $10\frac{7}{8}''$ )—28 pages. Includes circuit diagrams with parts lists, design considerations and performance requirements, and characteristics chart of RCA high-fidelity tube types. For hobbyists, technicians, and others interested in construction of their own high-fidelity amplifier systems. Price 35 cents.\*
- **RCA COLOR TELEVISION PICT-O-GUIDE**—( $9\frac{5}{8}''$  x  $5\frac{3}{8}''$ )—200 pages. Developed and written by John R. Meagher, RCA's nationally recognized authority on practical TV servicing. Prepared to aid TV technicians in trouble-shooting and adjusting color TV receivers. Color photographs are included to assist in recognizing and understanding visible symptoms of troubles and misadjustments. Price \$4.50.\*

● **RCA POWER AND GAS TUBES**—PG-101E (10 $\frac{7}{8}$ " x 8 $\frac{3}{8}$ ")—46 pages. Completely revised and brought up to date. Technical information on 200 RCA vacuum power tubes, rectifier tubes, thyratrons, and ignitrons. Includes terminal connections. Price 75 cents.\*<sup>o</sup>

● **RCA RECEIVING-TYPE TUBES FOR INDUSTRY AND COMMUNICATIONS**—RIT-104B (10 $\frac{7}{8}$ " x 8 $\frac{3}{8}$ ")—32 pages. Technical information on over 190 RCA "special red" tubes, premium tubes, nuvistors, computer tubes, pencil tubes, glow-discharge tubes, small thyratrons, low-microphonic amplifier tubes, vacuum-gauge tubes, mobile communications tubes, and other special types. Includes socket-connection diagrams. Price 30 cents.\*<sup>o</sup>

● **RCA RECEIVING TUBES AND PICTURE TUBES**—1275-J (10 $\frac{7}{8}$ " x 8 $\frac{3}{8}$ ")—48 pages. New booklet contains classification chart, characteristics chart, and base and envelope connection diagrams on more than 900 entertainment receiving tubes and picture tubes. Price 35 cents.\*<sup>o</sup>

● **TECHNICAL BULLETINS**—Authorized information on RCA transmitting tubes and other tubes for communications and industry. Be sure to mention tube-type bulletin desired. Single copy on any type free on request.

● **RCA PHOTOSENSITIVE DEVICES AND CATHODE-RAY TUBES**—CRPD-105B (10 $\frac{7}{8}$ " x 8 $\frac{3}{8}$ ")—36 pages. Contains technical information on 151 RCA tubes including single-unit, twin-unit, and multiplier phototubes; photocells; camera and image-converter tubes; flying-spot tubes; monitor, projection, transcriber, and view-finder kinescopes; oscillograph and storage tubes. Price 50 cents.\*<sup>o</sup>

● **RCA INTERCHANGEABILITY DIRECTORY OF INDUSTRIAL-TYPE ELECTRON TUBES**—ID-1020C (10 $\frac{7}{8}$ " x 8 $\frac{3}{8}$ ")—16 pages. Lists more than 1450 basic type designations for 18 classes of industrial tube types; shows the RCA Direct Replacement Type or the RCA Similar Type, when available. Price 35 cents.\*<sup>o</sup>

● **RCA PENCIL TUBES**—1CE-219 (10 $\frac{7}{8}$ " x 8 $\frac{3}{8}$ ")—28 pages. Contains operating theory for pencil tubes, electrical and mechanical circuit-design considerations, environmental considerations, application considerations, and data for commercial types. Price 50 cents.\*<sup>o</sup>

● **RCA PHOSPHORS**—TPM-1508A (10 $\frac{7}{8}$ " x 8 $\frac{3}{8}$ ")—20 pages. Contains defining data for over 25 different industrial phosphors, spectral-energy emission curves, persistence curves, and quick-reference classification charts. Price 75 cents.\*<sup>o</sup>

## Semiconductor Products

● **RCA SEMICONDUCTOR PRODUCTS HANDBOOK**—HB-10. Two binders, each 7 $\frac{3}{8}$ " L x 5 $\frac{5}{8}$ " W x 2 $\frac{7}{8}$ " D, having gold-imprinted red covers. Contains over 1000 pages of loose-leaf data and curves on RCA semiconductor devices such as germanium transistors, silicon transistors, silicon rectifiers, and semiconductor diodes. Available on subscription basis. Price \$10.00\* including service for first year. Also available with RCA Electron Tube Handbook HB-3 at special combination price of \$25.00\*. Write to Commercial Engineering for descriptive flyer and order form.

● **RCA SEMICONDUCTOR PRODUCTS GUIDE**—60S16R2 (10 $\frac{7}{8}$ " x 8 $\frac{3}{8}$ ")—10 pages. Contains classification chart, index, and ratings and characteristics on RCA's line of transistors, silicon rectifiers, semiconductor diodes, and photocells. Single copy free on request.

● **RCA SILICON POWER TRANSISTORS APPLICATION GUIDE**—1CE-215 (10 $\frac{7}{8}$ " x 8 $\frac{3}{8}$ ")—28 pages. Describes outstanding features of RCA silicon power transistors and their use in many critical industrial and military applications. Includes construction details, discussion of voltage ratings, thermal stability conditions, and equivalent circuits for these transistors. Price 50 cents.\*<sup>o</sup>

● **RCA SILICON VHF TRANSISTORS APPLICATION GUIDE**—1CE-228 (10 $\frac{7}{8}$ " x 8 $\frac{3}{8}$ ")—20 pages. Describes unique capabilities of RCA silicon vhf transistors and their use in critical industrial and military applications up to 300 Mc. Price 50 cents.\*<sup>o</sup>

● **TECHNICAL BULLETINS**—Authorized information on RCA transistors. Be sure to mention transistor-type bulletin desired. Single copy on any type free on request.

● **RCA SILICON RECTIFIERS**—Technical bulletins containing authorized information on 69 silicon rectifiers of the diffused-junction type. Bulletin includes

characteristics and performance curves. Single copy free on request.

## Components and Service Parts

### • SERVICE PARTS DIRECTORIES FOR RCA VICTOR TV RECEIVERS

SP-1007—1946-1950 (10 $\frac{7}{8}$ " x 16 $\frac{3}{4}$ ")—80 pages. Schematic diagrams and replacement parts lists for all RCA Victor TV receivers manufactured from 1946 through June 1950 (56 models). Each schematic diagram faces its corresponding parts list for quick reference. Price 75 cents.\*°

SP-1014—1950-1951 (10 $\frac{7}{8}$ " x 16 $\frac{3}{4}$ ")—142 pages. Schematic diagrams, replacement parts lists, and top and bottom chassis views for the 71 models of 1950 and 1951 RCA Victor TV receivers. The comprehensive index for model and chassis numbers provides a ready source of reference. Price \$1.50.\*°

SP-1021—1952 (10 $\frac{7}{8}$ " x 16 $\frac{3}{4}$ ")—36 pages. Schematic diagrams, wiring diagrams, replacement parts lists, and top and bottom chassis views for the 27 models of 1952 RCA Victor TV receivers. The comprehensive index cross-references RCA TV model names to model numbers, and model numbers to the publication in which information may be found. Price 50 cents.\*°

SP-1028—1953 (10 $\frac{7}{8}$ " x 16 $\frac{3}{4}$ ")—84 pages. Schematic diagrams, wiring diagrams, replacement parts lists, and top and bottom chassis views for the 108 models of 1953 RCA Victor TV receivers. Also includes schematic diagrams, replacement parts, and other information for radio chassis used in radio-TV combination receivers. Cross-references model names to model numbers of all RCA TV receivers from 1946 through 1953. Cross-references all model numbers and chassis numbers to the publication in which information may be found. Price \$1.35.\*°

SP-1035—1954 (10 $\frac{7}{8}$ " x 16 $\frac{3}{4}$ ")—72 pages. Schematic diagrams, top and bottom chassis views, replacement parts lists, and top and bottom chassis adjustments for the 106 models of 1954 RCA Victor TV receivers. Also included is information on the CT-100 and the 21-CT55 Color Television Receivers, and the RP-197 and RP-198 3-speed record

changers. The comprehensive index references model names to model numbers of all RCA Victor TV receivers from 1946 through 1954, and all model and chassis numbers to the Service Parts Directory in which information may be found. Price \$1.25.\*°

SP-1042—1955-1957 (10 $\frac{7}{8}$ " x 16 $\frac{3}{4}$ ")—128 pages. Schematic diagrams, top and bottom chassis views, replacement parts lists, and chassis adjustments for more than 250 models of 1955, 1956, and 1957 RCA Victor black-and-white and color TV receivers. Includes servicing information on printed circuit boards and adjustment and trouble-shooting information on the RP-205 and RP-208 record changers. Cross-references all RCA model names to model numbers, and model numbers to the publication in which information may be found. Price \$2.00.\*°

• TV SERVICING. Bulletin TVS-1030 (10 $\frac{7}{8}$ " x 8 $\frac{3}{8}$ ")—48 pages. Contains articles on TV trouble shooting, TV tuner alignment, and TV circuit analysis by RCA's expert in the field of TV servicing and test equipment—John R. Meagher. Price 35 cents.\*°

• TV SERVICING, SUPPLEMENT 1. Bulletin TVS-1031 (10 $\frac{7}{8}$ " x 8 $\frac{3}{8}$ ")—12-page booklet by John R. Meagher on solving trouble shooting problems in those hard-to-service television receivers known to service technicians as "tough" sets or "dogs." Price 15 cents.\*°

• RCA VICTOR TV SERVICE PARTS GUIDE —SP-2001B (10 $\frac{7}{8}$ " x 8 $\frac{3}{8}$ ")—16 pages. Lists stock numbers of major replacement parts for RCA Victor TV sets by receiver-model number and corresponding receiver-chassis number. Also lists stock numbers of tuner-replacement parts for individual tuner chassis. Covers period from 1946 through 1956. Price 25 cents.\*°

• PRACTICAL COLOR TELEVISION — Revised Edition (11" x 8 $\frac{1}{2}$ ")—84 pages. Black-and-white and color illustrations. Comprehensive information on color principles, color signal, color camera, and color picture tubes. Covers commercial-model receiver circuit using the RCA-15GP22 picture tube, as well as installation and service of color receivers. Provides detailed description of color-test equipment. Price \$2.00.\*°

• PRACTICAL COLOR TELEVISION, SUP-



MENT 1—(11" x 8½")—36 pages. Describes theory, operation and servicing of large-screen color television receiver utilizing RCA-21AXP22 color picture tube. Includes 55 black-and-white and color illustrations, wave-forms, and explanations of color circuits and adjustments. Price 75 cents.\*°

• **RADIO AND RECORD CHANGER SERVICE PARTS DIRECTORY—SP-1008B** (10¾" x 10¾")—16 pages. Lists stock numbers of major replacement parts by receiver model number for all RCA Victor radios from 1954 through June 1958. Also includes stock numbers of major replacement parts for RCA phonographs, and an index cross-reference of RCA record changers to cartridge and styli. Price 25 cents.\*°

## Batteries

• **RCA BATTERIES—BAT-134E** (10¾" x 8¾")—16 pages. Technical data on 106 Leclanché, alkaline, and mercury-type dry batteries, for radios, industrial applications, flashlights, lanterns, electronic toys, and for photoflash service. Price 35 cents.\*°

• **RCA BATTERIES FOR TRANSISTOR APPLICATIONS—TBA-107A** (10¾" x 8¾")—12 pages. Contains technical data on 25 Leclanché and mercury-type dry cells and batteries. Specifically designed for use in compact portable radio receivers, communications equipment, and other applications utilizing transistors. Price 25 cents.\*°

• **RCA ALKALINE BATTERIES—1CE-237** (10¾" x 8¾")—2 pages. Contains technical data, curves, and dimensional outlines for 4 alkaline batteries in applications having a wide range of current-drain requirements. No recovery period required; batteries have exceptionally long shelf life. Single copy free on request.

## Test and Measuring Equipment

**INSTRUCTION BOOKLETS**—Illustrated instruction booklets, containing specifications, operating and maintenance data, application information, schematic diagrams, and replacement parts lists, are available for all RCA test instruments. Booklets for the following popular instruments are available at the prices indicated. Prices for booklets on other instruments are available on request.

WA-44A (Audio Signal Generator).....	\$0.50*
WA-44C (Audio Oscillator).....	1.00*
WO-33A (Super-Portable Oscilloscope).....	1.00*
WO-88A (5-in. Oscilloscope)....	0.50*
WO-91A (5-in. Oscilloscope)....	1.00*
WR-36A (Dot-Bar Generator)....	0.50*
WR-39C (TV Calibrator).....	0.50*
WR-46A (Video Dot/Crosshatch Generator).....	0.75*
WR-49A (RF Signal Generator)....	0.50*
WR-49B (RF Signal Generator)....	1.00*
WR-61B (Color-Bar Generator)....	1.00*
WR-64A (Color-Bar/Dot/Crosshatch Generator)....	1.00*
WR-67A (Test-Oscillator).....	0.25*
WR-69A (TV-FM Sweep Generator).....	1.00*
WR-70A (RF-IF-VF Marker Adder).....	0.75*
WR-86A (UHF Sweep Generator).....	0.50*
WR-99A (Marker Calibrator)....	1.00*
WV-37B (Radio Battery Tester)....	0.25*
WV-38A (Volt-Ohm-Milliammeter).....	0.50*
WV-65A (VoltOhmyst†).....	0.25*
WV-74A (High-Sensitivity AC VTVM).....	0.75*
WV-75A (VoltOhmyst†).....	0.25*
WV-77A (VoltOhmyst†).....	0.25*
WV-77B (VoltOhmyst†).....	0.25*
WV-77E (VoltOhmyst†).....	1.00*
WV-84C (Ultra-Sensitive DC Microammeter)....	0.75*
WV-95A (VoltOhmyst†).....	0.25*
WV-97A (VoltOhmyst†).....	0.50*
WV-98A (VoltOhmyst†).....	1.00*
WV-98B (Senior VoltOhmyst†)....	1.00*
195-A (VoltOhmyst†).....	0.25*
WT-100A (Electron-Tube MicroMhoMeter)....	1.75*
WT-100A (Electron-Tube MicroMhoMeter, Ser. No. 1001 and over) ..	2.00*
WT-100A (Tube Chart 1CE-163).....	3.00*
WT-110A (Automatic Electron-Tube Tester).....	1.00*
WT-110A (1CE-174 Card Punch Data).....	0.25*
WT-110A (1CE-234 Card Punch Data).....	1.00*

†Trade Mark Reg. U.S. Pat. Off.

\*Prices shown apply in U.S.A. and are subject to change without notice.

°Optional List Price.

# Reading List

This list includes references of both elementary and advanced character. Obviously, the list is not inclusive, but it will guide the reader to other references.

- ALBERT, A. L. *Electrons and Electron Devices*, The MacMillan Co.
- BECK, A. H. W. *Thermionic Valves*, Cambridge University Press.
- CHUTE, G. M. *Electronics in Industry*. McGraw-Hill Book Co., Inc.
- DOMB, R. B. *Television Principles*. McGraw-Hill Book Co., Inc.
- DOW, W. G. *Fundamentals of Engineering Electronics*. John Wiley and Sons, Inc.
- EASTMAN, A. V. *Fundamentals of Vacuum Tubes*. McGraw-Hill Book Co., Inc.
- EDSON, W. A. *Vacuum Tube Oscillators*, John Wiley and Sons, Inc.
- FINK, D. G. *Television Engineering*. McGraw-Hill Book Co., Inc.
- GHIRARDI, A. A. *Radio and Television Receiver Circuitry and Operation*. Rinehart and Co., Inc.
- GRAY, T. S. *Applied Electronics*. John Wiley and Sons, Inc.
- GROB, B. *Basic Television*. McGraw-Hill Book Co., Inc.
- HENNEY, KEITH. *Radio Engineering Handbook*. McGraw-Hill Book Co., Inc.
- HOAG, J. B. *Basic Radio*. D. Van Nostrand Co., Inc.
- KOLLER, L. R. *Physics of Electron Tubes*. McGraw-Hill Book Co., Inc.
- MAEDEL, G. F. *Basic Mathematics for Television and Radio*. Prentice-Hall, Inc.
- MARCUS, A. *Elements of Radio*. Prentice-Hall, Inc.
- MARKUS AND ZELUFF. *Handbook of Industrial Electronic Circuits*. McGraw-Hill Book Co., Inc.
- MILLMAN AND SEELY. *Electronics*. McGraw-Hill Book Co., Inc.
- MOYER AND WOSTREL. *Radio Receiving and Television Tubes*. McGraw-Hill Book Co., Inc.
- PENDER, DELMAR, AND MCILWAIN. *Handbook for Electrical Engineers—Communications and Electronics*. John Wiley and Sons, Inc.
- PREISMAN, A. *Graphical Constructions for Vacuum Tube Circuits*. McGraw-Hill Book Co., Inc.
- HICKEY, H. V., and VILLINES, JR., W. M. *Elements of Electronics*. McGraw-Hill Book Co., Inc.
- RCA TECHNICAL BOOK SERIES. *Electron Tubes, Vol. I and Vol. II*. RCA Review.
- REICH, H. J. *Theory and Applications of Electron Tubes*. McGraw-Hill Book Co., Inc.
- RICHTER, WALTHER. *Fundamentals of Industrial Electronic Circuits*. McGraw-Hill Book Co., Inc.
- SEELY, S. *Electron Tube Circuits*. McGraw-Hill Book Co., Inc.
- SPANGENBERG, K. R. *Vacuum Tubes*. McGraw-Hill Book Co., Inc.
- STURLEY, K. R. *Radio Receiver Design*. Chapman and Hall, Ltd.
- TERMAN, F. E. *Fundamentals of Radio*. McGraw-Hill Book Co., Inc.
- TERMAN, F. E. *Radio Engineers Handbook*. McGraw-Hill Book Co., Inc.
- The Radio Amateurs Handbook*. American Radio Relay League.
- ZWORYKIN AND MORTON. *Television: The Electronics of Image Transmission*. John Wiley and Sons, Inc.

## RCA Receiving Types NOT Recommended For New Equipment Design

In the design of new equipment, the use of certain receiving tubes should be avoided because they are approaching obsolescence or are in limited demand; such RCA types are listed below. For further assistance in the selection of tube types for new equipment, refer to the Receiving Tube Chart and Technical Data Section of this manual.

OZ4	5Z3	6FW8	7B6	12BV7	17H3
OZ4-G	6A7	6G6-G	7B7	12C8	18A5
OZ4-A	6A8	6J7-GT	7B8	12CN5	19AU4-GTA
1A5-GT	6A8-G	6K7	7C5	12CT8	19BG6-GA
1A7-GT	6A8-GT	6K7-GT	7C6	12CX6	19J6
1AX2	6AB5/6N5	6N7	7C7	12DL8	19T8
1C5-GT	6AB7	6Q7	7E7	12DQ7	24A
1DN5	6AC5-GT	6Q7-GT	7F7	12EA6	25L6
1H5-GT	6AD7-G	6R7	7F8	12EG6	25W4-GT
1L6	6AH4-GT	6S7	7G7	12EL6	25Z5
1LA6	6AL7-GT	6S8-GT	7H7	12EN6	27
1LB4	6AM4	6SA7-GT	7J7	12J5-GT	35A5
1LC6	6AQ7-GT	6SB7-Y	7K7	12J7-GT	35Y4
1LD5	6AR5	6SF5-GT	7N7	12J8	35Z3
1LE3	6B8	6SF7	7Q7	12K7-GT	35Z4-GT
1LG5	6BD6	6SJ7-GT	7R7	12K8	41
1LH4	6BF5	6SK7-GT	7V7	12L6-GT	42
1LN5	6BG6-G	6SQ7-GT	7W7	12Q7-GT	43
1S4	6BK5	6SR7	7X7	12SA7-GT	47
1-v	6BY5-GA	6SS7	7Y4	12SF7	50A5
1X2-A	6BZ8	6T4	7Z4	12SH7	50X6
2BN4	6C6	6U5	9BR7	12SK7-GT	50Y7-GT
2EN5	6C8-G	7A4	10C8	12SR7	70L7-GT
3A2	6CK4	7A5	12A8-GT	12U7	75
3B2	6D6	7A6	12AC6	14A7	78
3LF4	6DN6	7A7	12AH7-GT	14AF7	80
3Q4	6EH8	7A8	12AJ6	14B6	84/6Z4
3Q5-GT	6EX6	7AF7	12AV7	14C7	117L7/
5AZ4	6F6-G	7AG7	12BA7	14F7	M7-GT
5BE8	6F6-GT	7AH7	12BD6	14F8	117N7-GT
5BT8	6F7	7B4	12BK5	14Q7	117P7-GT
5T4	6F8-G	7B5	12BR7	14R7	117Z6-GT
5X4-G					



Trade Mark(s) Registered  
Marca(s) Registrada(s)

Information furnished by RCA is believed to be accurate and reliable. However, no responsibility is assumed by RCA for its use; nor for any infringements of patents or other rights of third parties which may result from its use. No license is granted by implication or otherwise under any patent or patent rights of RCA.

