

\$1<sup>00</sup>  
Original  
List Price

# RCA

## *Transmitting Tubes*

TO 4 KW PLATE INPUT



TECHNICAL MANUAL TT-5

# Contents

POWER-TUBE FUNDAMENTALS . . . . .	3
Basic Considerations, Vacuum Tubes, Gas Tubes, Generic Tube Types, Diodes, Triodes, Tetrodes, Pentodes, Beam Power Tubes	
CONSTRUCTION AND MATERIALS . . . . .	10
Cathodes, Plates, Grids, Getters, Envelopes	
POWER-TUBE APPLICATIONS . . . . .	15
Amplification, Class A Amplifiers, Class B Amplifiers, Class AB Amplifiers, Class C Amplifiers, Class C Telegraphy, Modulated Class C Amplifiers, Frequency Multiplication, Oscillators, Circuit Configuration	
POWER-TUBE CIRCUIT-DESIGN CONSIDERATIONS . . . . .	28
Tube Selection, Multiple-Tube Stages, AF Power Amplifiers, Modulators, RF Power Amplifiers, Linear RF Power Amplifiers, Driving Power, Grid-Bias Considerations, Frequency Multipliers, Oscillators, Parallel-Tuned Tank Circuits, Inter-stage Coupling, Output Coupling, Stabilization, Parasitic Oscillations, Power-Supply Considerations	
POWER-TUBE OPERATING CONDITIONS AND ADJUSTMENTS . . . . .	46
Calculation of Operating Conditions; Use of Curves; Class C Telegraphy Service—Multigrid Tubes, Triodes; Plate-Modulated Class C Telephony Service; Frequency Multipliers—Multigrid Tubes, Triodes; Class AB, SSB Service—Multigrid Tubes, Triodes; Class AB and Class B AF Amplifier Service; Class AB <sub>2</sub> Amplifiers—Multigrid Tubes; Class B Amplifiers—Triodes; Conversion Factors; Adjustment and Tuning; Tuning Procedure; Neutralizing Adjustments	
POWER-TUBE INSTALLATION . . . . .	63
Ventilation and Cooling, Wiring Considerations, Circuit Returns, Filament or Heater Supply, Plate Supply, Suppressor-Grid Supply, Screen-Grid Supply, Control-Grid (Bias) Supply, Supply-Voltage Variations, Protective Devices, Safety Considerations	
RECTIFIER CONSIDERATIONS . . . . .	71
Mercury-Vapor Tubes, Filament Heating Time, Mercury Temperature, Shielding, Tube Ratings, Circuits, Quadrature Operation, Regulation, Filters, Design of Choke-Input Filters	
INTERPRETATION OF TUBE DATA . . . . .	84
APPLICATION TABLES . . . . .	88
TUBE TYPES—TECHNICAL DATA . . . . .	95
OUTLINES . . . . .	274
CIRCUITS . . . . .	292
INDEX . . . . .	313
READING LIST . . . . .	320



Trade Mark(s) Registered  
Marca(s) Registrada(s)

Information furnished by RCA is believed to be accurate and reliable. However, no responsibility is assumed by RCA for its use; nor for any infringements of patents or other rights of third parties which may result from its use. No license is granted by implication or otherwise under any patent or patent rights of RCA.

# **RCA**

## ***Transmitting Tubes***

**THIS NEW EDITION**, like preceding editions, has been prepared for those who work or experiment with transmitting tubes or circuits. It will be useful to engineers, technicians, educators, radio amateurs, students, experimenters, and many others technically concerned with transmitting tubes.

The manual has been comprehensively revised and updated to keep abreast of the advances in power-tube technology since its last publication. Information has been prepared for the latest RCA transmitting tubes, including new or improved cermolox, ceramic-and-metal, pencil, and pulse-rated types. New material has also been provided for application tables, single-sideband information (new ratings, linear rf power amplifiers, calculations for two-tone modulation), and typical transmitting and industrial circuits.

In the *Tube Types—Technical Data* Section, information is given for RCA power tubes having plate input ratings up to four kilowatts and for associated rectifier types. Detailed data and curves are given for all the newer and more important types. For reference purposes, basic information is also provided for a number of discontinued types still of some interest.

## **RADIO CORPORATION OF AMERICA**

ELECTRON TUBE DIVISION

HARRISON, N. J.

Copyright 1962 by Radio Corporation of America. (All Rights Reserved)

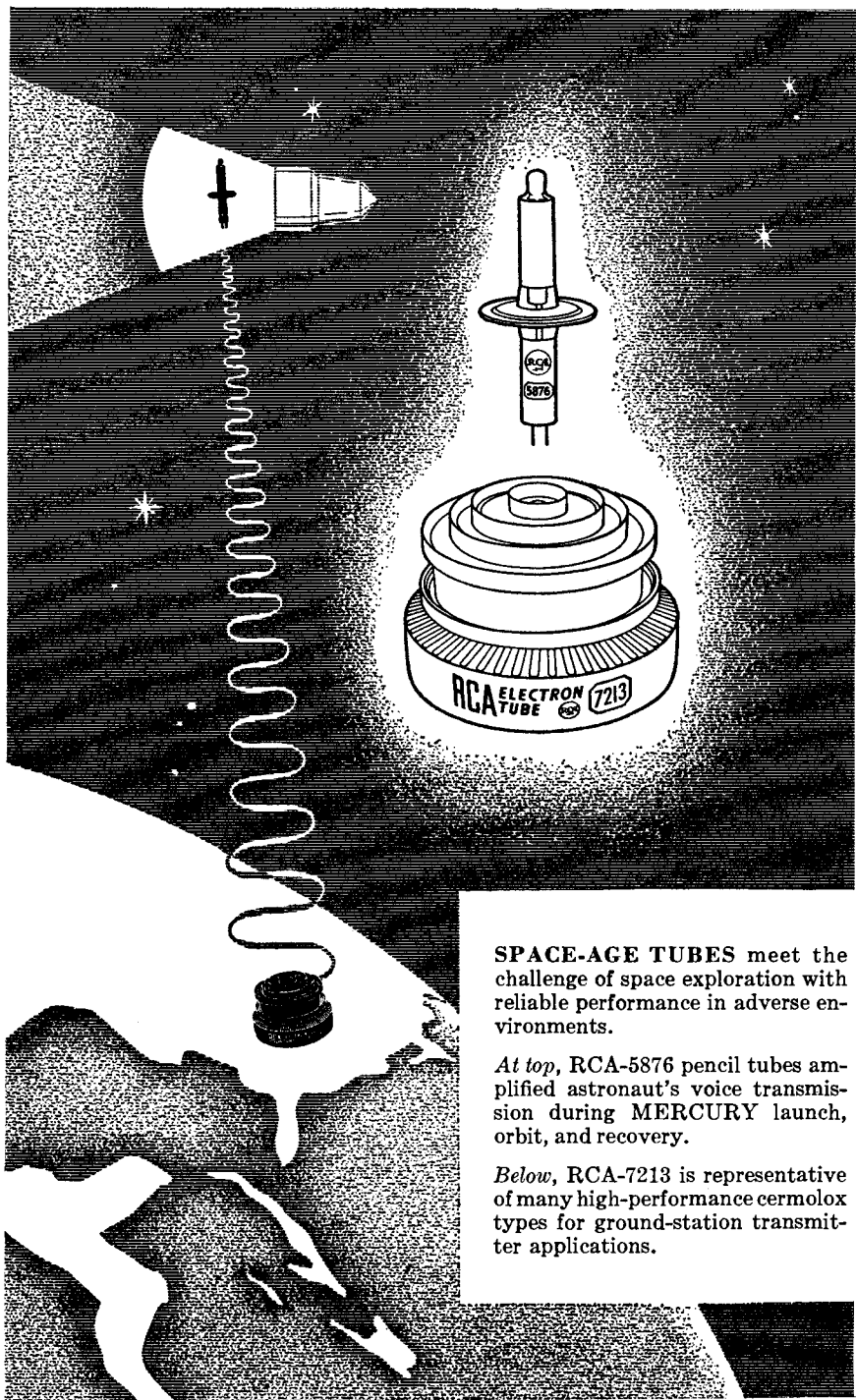

**SPACE-AGE TUBES** meet the challenge of space exploration with reliable performance in adverse environments.

*At top*, RCA-5876 pencil tubes amplified astronaut's voice transmission during MERCURY launch, orbit, and recovery.

*Below*, RCA-7213 is representative of many high-performance cermet types for ground-station transmitter applications.

# RCA Transmitting Tubes

## Power-Tube Fundamentals

Power tubes are devices for controlling the transfer of energy in electrical circuits. In this respect they are similar to rheostats, switches, and other circuit-type control devices. Tubes, however, permit much more rapid, precise, and efficient control of electrical energy than mechanically operated devices.

The transfer of electrical energy through a circuit involves control of two factors, rate and direction. The rate of energy transfer is determined by the number of individual electron charges moving unidirectionally through the circuit in a given interval of time and is proportional to the applied voltage. The direction in which the electron charges move is determined by the polarity of the applied voltage.

Electron charges may be transferred through a circuit element by several methods. In one method, kinetic energy is transferred between adjacent electrons within the molecular structure of a conductor. This method is employed in switches, rheostats, and other devices which utilize conductive materials as control electrodes. Because the currents through such devices are controlled by mechanical means, the speed with which the amount or direction of current can be changed is limited by friction and inertia.

In a second method, individual electrons are transferred through a low-density, nonconductive medium, such as a vacuum or a low-pressure gas. This method is used in tubes and has the advantage that both the rate and the direction of current flow may be controlled by electric fields. Because these fields, as well as the electrons, have negligible inertia, tubes can effect changes in the value and direction of electric current at speeds considerably higher than those

obtainable with mechanically operated devices.

In electrical circuits, control of the direction of current flow is necessary when the power source produces ac voltages and currents and the load requires a unidirectional current. Tubes which are used primarily to control the direction of current flow are known as **rectifiers**. All such tubes, however, are also rate-control or rate-limiting devices in the sense that they have a finite current-carrying capability.

Rate-control requirements in electrical circuits range from occasional on-off switching to continuous variations occurring several billion times per second. Tubes which provide this form of control are known generically as **amplifiers**. Power-tube amplifiers are capable of controlling relatively large amounts of energy. All triode and multigridded power tubes are inherently rectifiers as well as amplifiers because they deliver unidirectional current regardless of the kind of energy furnished by the power source.

### Basic Considerations

In its simplest form, an electron tube consists of a **cathode** (the negative electrode) and an **anode** or **plate** (the positive electrode) in a sealed envelope. More complex types may also contain one or more additional electrodes. The purpose of the cathode is to furnish a continuous supply of free electrons; the plate collects these electrons. The rate at which electrons are collected by the plate (the **plate current**) is determined by the number of free electrons available and by the polarity and the strength of the electric field between the plate and cathode. Power tubes and rectifiers are usually operated so that the number of electrons available is constant. Conse-

quently, the rate of collection or current flow is determined principally by the characteristics of the internal electric field.

The internal electric field is established by connection of a source of potential between the plate and cathode. When the plate is at a negative potential with respect to the cathode, the internal field tends to prevent electrons from leaving the vicinity of the cathode, and there is no transfer of energy through the tube. When the plate is operated at a positive potential with respect to the cathode, the field causes a movement of electrons to the plate. The current through the tube is then determined by the strength of the field, or the plate voltage.

### Vacuum Tubes

Under normal operating conditions, the velocity of the electrons emitted by the cathode of a vacuum tube is just sufficient to insure their release from the emitting surface. If no accelerating field is applied, these electrons tend to return to the cathode when their escape energy has been expended. However, the intense negative field created by new electrons reaching the emitting surface repels those previously emitted and they accumulate in the space surrounding the cathode. This accumulation of electrons is called the **space charge**.

The approximate distribution of the space-charge electrons in the absence of an accelerating field is shown in Fig. 1. The concentration is greatest in

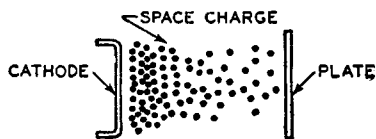

Fig. 1

the region nearest the cathode. The general relationship between plate voltage ( $E_b$ ) and plate current ( $I_b$ ) in a two-electrode vacuum tube is shown in Fig. 2. At very low positive plate voltages (region  $E_0$  to  $E_1$ ), only the loosely bound electrons on the outer surface of the

space charge are attracted to the plate, and the plate current does not change uniformly with equal increments in plate voltage. Over a higher range of plate voltages (region  $E_1$  to  $E_2$ ), the relation between plate voltage and plate current is nearly linear. When operated

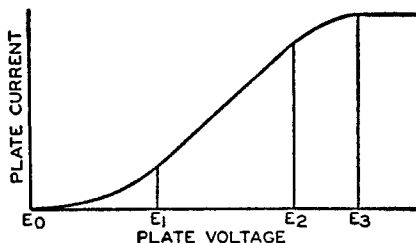

Fig. 2

in this region, a two-electrode vacuum tube has substantially constant internal resistance (called plate resistance, or  $r_p$ ), and the plate current follows the normal Ohm's-Law relationship.

At plate voltages higher than  $E_2$ , an increase in plate voltage does not produce a proportional increase in plate current because practically the full emission capabilities of the cathode are being utilized. The voltage at which essentially all of the electrons emitted by the cathode are collected by the plate is known as the **saturation voltage** and is indicated in Fig. 2 by  $E_3$ .

Two-electrode vacuum tubes are extremely useful as power rectifiers. Because they are entirely nonmechanical in operation, they can be used over a wide range of frequencies. They can operate at both very high and very low temperatures, and can be designed to withstand very high inverse voltages. The substantially linear relationship between plate voltage and plate current in such tubes is also useful as a means of obtaining virtually distortionless rectification (detection) of radio signals.

Like all rectifiers, the two-electrode vacuum tube is a special form of switching device and, therefore, does not provide any power gain. However, the control of circuit currents by means of electric fields can be extended to include amplification, oscillation, and other functions involving actual power gains by

the addition of a third electrode called a **grid** between cathode and plate. When the grid is placed relatively near the cathode, the application of small voltages to the grid can produce the same change in the internal field, and thus in the plate current, as large changes in plate voltage. Large amounts of plate-circuit power can thus be controlled with relatively little energy. Special control characteristics may be obtained by the use of two or more grids or control electrodes in a tube. The construction and characteristics of the principal types of multi-electrode tubes in general use are described in detail later in this section.

Electrons accelerated by even moderately high plate voltages may acquire enough kinetic energy so that they dislodge equal or greater numbers of electrons when they strike the plate. Emission produced in this manner is known as secondary emission.

Like primary electrons, secondary electrons are attracted to a positive electrode in the tube. In a two-electrode tube, they return to the plate and their only effect is to produce a weak negative field similar to a space charge which tends to repel some of the primary electrons approaching the plate. Although an increase in plate voltage beyond the saturation value does not increase the plate current of a tube, it produces a proportional increase in the velocity with which electrons move to the plate, and thus increases secondary emission.

Although secondary emission is frequently employed in special multi-electrode tubes, it may produce effects which interfere with normal operation of power-tube amplifiers. These effects and the methods used to overcome them are discussed in detail later in this section.

### **Gas Tubes**

In a vacuum tube, space charge inhibits the release of electrons from the cathode, and thus limits the plate current at low and moderate plate voltages. Although the space-charge effect may be reduced by a reduction in the spacing between plate and cathode, it cannot be entirely eliminated by this method. The negative space charge can be neutralized,

however, by other methods—for example, by the introduction of a controlled amount of mercury vapor or inert gas in the tube.

When a gas is present in a two-electrode tube, free electrons in the gas are attracted to the positive anode and add to the anode current. Positive ions created continuously by collisions between gas atoms and the free electrons neutralize the space charge so that large currents may be drawn at low anode voltages. In addition, the space-charge neutralization effectively increases the thermal efficiency of the cathode. These advantages make gas tubes particularly suitable for use as power rectifiers. The use of gas tubes, however, requires precautions in circuit design, physical installation, and operation which are not necessary with vacuum tubes. These additional requirements are discussed in the *Rectifier Considerations* Section.

### **Generic Tube Types**

In tube terminology, generic type names such as “diode,” “triode,” “tetrode,” and “pentode” indicate the number of electrodes directly associated with the emission, control, or collection of electrons. Auxiliary elements such as heaters, internal shields, or metal-envelope shields, even when provided with separate electrical connections and shown in the tube symbol, are not counted in establishing generic-type classifications.

### **Diodes**

The diode types listed in this Manual are used principally as rectifiers in equipment for converting low-frequency alternating current from commercial power lines or local sources to direct current.

Tubes which contain a single diode unit, such as the 836 or 866-A, are known as half-wave rectifiers because they are capable of conducting current during only one half of each ac cycle. Tubes which contain two diode units, such as the 5R4-GY, are called full-wave rectifiers because they can be connected so as to conduct current during both halves of each ac cycle. Fig. 3 shows graphical symbols for a filament-type half-wave

rectifier and a heater-cathode-type full-wave rectifier.

Gas rectifiers have a very small internal voltage drop which is practically independent of load current and are, therefore, desirable for applications requiring relatively constant output voltage with varying loads. In mercury-vapor types, and to a smaller degree in inert-gas types, the voltage drop is affected by bulb temperature. Control of bulb temperature and other special considerations involved in the operation of gas rectifier tubes are discussed in the *Rectifier Considerations* Section.

In a vacuum rectifier, the internal voltage drop is approximately proportional to the load current. Consequently, rectifiers of this type, such as the 5R4-GY, 836, and 1616, do not provide as good regulation of output voltage as gas types in applications involving varying load currents.

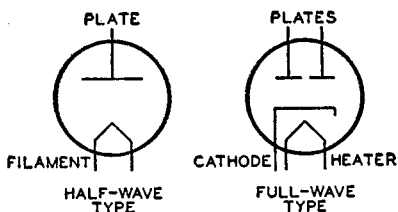

Fig. 3

Vacuum rectifiers, however, are not affected by ambient temperature and do not require special installation and circuit considerations. Certain heater-cathode-type vacuum rectifiers, such as the 836, have very low internal resistance and are capable of providing voltage regulation almost as good as that obtainable with gas types.

### Triodes

In triodes, or three-electrode tubes, an auxiliary control electrode, called a grid, is placed between the cathode and the plate, as shown in Fig. 4. The grid is usually a cylindrical or oval-shaped spiral of fine wire surrounding the cathode, although wire-mesh and grating-type grids may also be used.

Because of its open construction, the grid does not appreciably obstruct

the movement of electrons from cathode to plate. When the grid is made positive or negative with respect to the cathode, however, its electric field can increase or decrease the rate of electron flow. This effect makes it possible for a triode to be

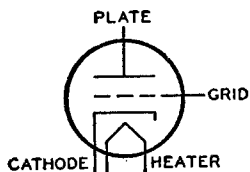

Fig. 4

used as an amplifier. In a typical amplifier circuit, such as that shown in Fig. 5, the energy required to attract electrons to the plate is obtained from a high-voltage dc plate supply and the electrical impulse to be amplified, the **input signal**, is applied between grid and cathode. Because the plate current of the tube flows through the load, variation of the grid-cathode voltage causes the dc power drawn from the plate supply to appear as ac power in the load. The power required by the grid for complete control is ordinarily only a fraction of the power developed in the load circuit. The ac power in the load circuit is always less than 100 per cent of the dc input power, however, because some power is dissipated at the plate of the tube and in the resistance of the load circuit. In addition to their use as audio-frequency and radio-frequency amplifiers, power triodes may be used in suitable circuit arrangements for oscillation,

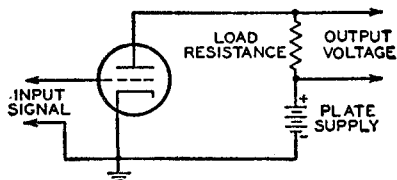

Fig. 5

frequency multiplication, modulation, and various special purposes.

The plate, cathode, and other electrodes of a tube form an electrostatic system, each electrode acting as one plate of a small capacitor. In a triode,



capacitances exist between grid and cathode, grid and plate, and plate and cathode, as shown in Fig. 6. Although these interelectrode capacitances do not have values of more than a few micro-microfarads, they may have substantial

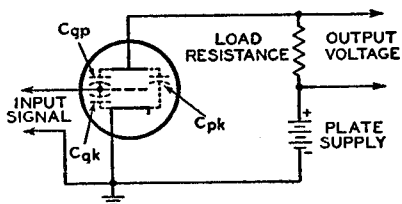

Fig. 6

effects on tube operation, especially at radio frequencies. For example, the grid-plate capacitance,  $C_{gp}$ , provides an internal path between the output and input circuits. When a triode is used as an amplifier at radio frequencies, sufficient energy may be fed back through this path to cause uncontrolled regeneration or oscillation. Although this type of internal feedback is frequently employed in oscillator circuits, it is undesirable in amplifier applications. Triode radio-frequency amplifiers, therefore, require either special circuit arrangements or the use of a feedback-cancelling technique known as **neutralization**. These special considerations are discussed at length in the *Power-Tube Applications* Section.

### Tetrodes

Internal feedback between plate and grid, and the resulting need for neutralization in triode radio-frequency amplifiers, can be minimized by incorporation of a second grid (the **screen grid**) between the grid No.1 (the control grid) and the plate, as shown in Fig. 7. Tubes which employ a grid No.2 or screen grid, cathode, control grid, and plate are known generically as tetrodes.

When a tetrode is used as an amplifier, the screen grid is operated at a fixed positive potential (usually somewhat lower than the plate voltage), and is bypassed to the cathode through a capacitor having a very low impedance at the operating frequency. This capacitor diverts signal-frequency alternating currents from the screen grid to ground, and effectively short-circuits the capacitive feedback path between plate and control

grid. The screen grid acts as an electrostatic shield between the control grid and the plate, and reduces the grid-plate capacitance to such a small value that internal feedback is usually negligible over the range of frequencies for which the tube is designed.

Because the screen grid is operated at a positive potential with respect to the cathode, it collects a substantial number of the available electrons and, therefore, reduces the plate current which can flow at a given plate voltage. The addition of a screen grid thus increases the internal resistance or plate resistance of a tube. However, it also gives the grid No.1 a greater degree of control over the plate resistance, and thus increases the voltage-amplification factor.

The voltage at which the screen grid is operated has a substantial effect on the plate current of a tetrode. This characteristic makes it practicable to control the gain of a tetrode by variation of the dc screen-grid potential, or to modulate the tube output economically by the application of signal voltage to the screen grid, as well as to the

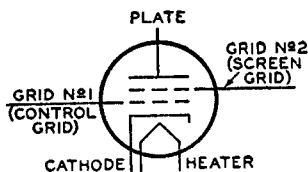

Fig. 7

control grid. It is usually necessary, therefore, to remove ripple and other fluctuations from the screen-grid supply voltage to prevent undesired modulation of the tube output.

Because the use of a grid No.2 or screen grid reduces internal coupling between the output and input circuits, tetrodes can furnish a high degree of stable amplification in relatively simple circuits. Some residual grid-plate capacitance is unavoidable, however, and internal feedback may be a problem. The amount of internal feedback that can be tolerated in any amplifier tube depends on the frequency at which the tube is

operated, the effective gain of the stage, the characteristics of the tube input and output circuits, and the mechanical layout employed. Because of their high power sensitivity, tetrodes used in rf applications generally require shielding from external fields and careful circuit layout to minimize external feedback between the input and output circuits of the tubes. In certain amplifier applications involving high radio frequencies and high stage gains, tetrodes, as well as triodes, may require neutralization. Further information on this subject is given in the *Power-Tube Circuit-Design Considerations* Section.

If the negative excursion of the output signal swings the plate to a voltage less positive than that of the screen grid, electrons moving from the screen grid to the plate tend to reverse their direction and return to the screen grid. The resulting decrease in plate current causes a corresponding rise in plate voltage, which terminates the negative swing of the output signal before it completes a full excursion. This effect, which tends to reduce the power output of a tetrode below that obtainable from a triode having equivalent plate-input rating, is emphasized considerably when there is secondary emission from the plate.

The loss of a portion of the output energy which occurs in a tetrode under these conditions reduces the power-handling capabilities of the tube, and causes serious distortion of the signal waveform. The output of the tube, therefore, contains harmonics of the signal frequency and other spurious frequencies which may cause considerable interference to communications service. Such distortion may also be highly objectionable to the ear or to the eye when a tetrode is used as an audio or video amplifier. Although this effect can be minimized by reducing the amplitude of the plate-voltage swing so that the plate voltage never swings negative with respect to the screen-grid voltage, this expedient imposes further limitations on the tube output.

The abrupt rise in the plate voltage of a tetrode caused by the reversal of electron flow tends to draw both primary and secondary electrons back to the plate. Collection of these electrons then

makes the plate less positive than the screen grid so that the tube current tends to reverse again. This interchange of electrons between plate and screen grid, called **dynatron action**, may continue for several cycles, and is equivalent to an oscillatory current. Although dynatron action forms the basis of certain tetrode oscillator circuits, it is highly objectionable when a tube is used solely as an amplifier.

### Pentodes

The limitation imposed on the plate-voltage swing of a tetrode by "dynatron action" can be overcome by the use of a grid No.3, or **suppressor grid**, between the screen grid (grid No.2) and the plate, as shown in Fig. 8. Tubes which employ five-electrode structures of this type are called pentodes.

When a pentode is used as an amplifier, the grid No.3 or suppressor grid is generally operated at a fixed negative potential with respect to both the screen grid and the plate and thus establishes a negative electrostatic field between them. Although this field is not strong enough to prevent the desired movement of high-velocity primary electrons from screen grid to plate, it effectively prevents both primary and secondary electrons from flowing backward to the screen grid. Consequently, the plate voltage of a pentode may swing negative with respect to the screen-grid voltage without the loss of

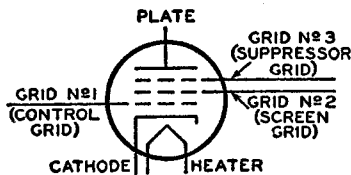

Fig. 8

output power and the waveform distortion that occur under the same conditions in a tetrode.

The grid No.3 or suppressor grid may be connected internally to the cathode, as in the 1613, so that it is automatically maintained at a negative potential with respect to the plate and screen grid. In most power pentodes, however, the suppressor grid is an independent elec-

trode which can either be connected externally to the cathode or operated at a positive or negative potential with respect to the cathode to meet various application requirements. The use of an independent suppressor grid permits the introduction of an auxiliary signal or control voltage into the tube circuit. Although the screen grid can also be used for this purpose, a suppressor grid is generally a more effective control electrode because it requires much less signal power for full modulation of the tube output. In addition, the shielding action of the screen grid minimizes undesirable coupling between the suppressor grid and the control grid when signals are applied simultaneously to these electrodes.

### Beam Power Tubes

The power-handling ability of a tetrode or pentode is limited to some extent because some of the available electrons are collected by the screen grid and, therefore, do not contribute to the plate current. In beam power tubes, however, the lateral wires of the screen grid are aligned with the control-grid wires to direct the flow of electrons through the screen grid to the plate. A sectional view of a typical beam power tube is shown in Fig. 9. As indicated by the dashed lines in the figure, the stream of electrons is divided into sheets or "beams" which tend to pass between the wires of the screen grid. Because relatively few electrons impinge on the screen grid, a substantial portion of the electron energy that would otherwise be absorbed by the screen grid and dissipated as heat is diverted to the plate, where it can be converted into useful output power.

In beam power tubes of the type illustrated in Fig. 9, dynatron action and

other undesirable effects of secondary emission from the plate can be minimized by spacing the electrodes so that a space-charge effect is created in the heavily shaded region. The negative electrostatic field produced by the dense concentration of electrons in this region blocks the escape of secondary electrons from the plate.

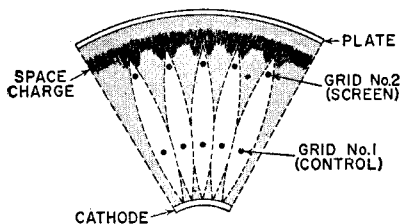

Fig. 9

In parallel-plane beam power tubes, stray secondary electrons may be prevented from reaching the screen grid by paths outside the effective field of the space charge by the incorporation of special beam-confining electrodes operated at cathode potential.

In general, pentodes and beam power tubes have higher power sensitivity than other generic types, *i.e.*, they require very little driving power in relation to obtainable power output. The use of beam power tubes in multi-stage equipment, therefore, minimizes the number of stages required to obtain a specific power gain.

These tube types are especially useful as buffer-amplifier tubes, final-amplifier tubes, and frequency-multiplier tubes in transmitters and other types of radio-frequency power equipment. Beam power tubes are also widely used as audio-frequency power-amplifier tubes and modulator tubes, and in certain types of oscillator circuits.

# Construction and Materials

Although power tubes may vary widely with respect to physical form, size, and terminal arrangement, they utilize two general forms of plate construction. In internal-plate construction, the plate is completely enclosed within the glass envelope, and electrical connection is made to a cap on the envelope or to a base pin, as shown in Fig. 10 (a). In external-plate construction, the plate electrode usually forms part of the tube envelope, so that the outer surface of the plate is exposed, as shown in Fig. 10 (b).

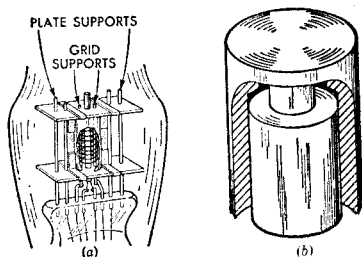

Fig. 10

Generally, internal-plate tubes require either natural convection cooling or forced-air cooling. Because the heat from the plate must first radiate to the envelope before it is dissipated, the power handling capability of such tubes is limited. External-plate types have a greater cooling efficiency because the heat from the plate can be directly dissipated by various methods of cooling. In some tubes, a radiator is attached directly to the plate to increase the area of the cooling surface. Other external-plate tubes use conduction or liquid cooling to improve heat dissipation and increase power handling capability.

Most RCA external-plate tubes have a cylindrical type of construction which provides the following advantages. Short effective heat paths from the control grid and screen grid result in cooler operation and, consequently, in lower grid emission. The larger plate of a cylindrical tube provides greater heat dissipation, and the compact cathode requires less heater power. In addition, uniform thermal expansion of the electrodes results in con-

stant interelectrode spacing over a wide range of temperatures.

## Cathodes

The most efficient practical cathodes for power tubes utilize **thermionic emission**. Because such emission varies exponentially with temperature, a power-tube cathode must be operated at a constant temperature if substantial variations in emission are to be avoided. Because of the practical difficulties involved in measuring the cathode temperature of a tube, proper operating conditions are usually expressed in terms of a specific voltage and a specific current. Specific values of heating voltage and current for each tube type are given in the *Tube Types* Section.

A **directly heated cathode**, or **filamentary cathode**, is a metallic conductor drawn into wire or ribbon form, as shown in Fig. 11. The conductor is heated to emitting temperature by its own resistance to a flow of electric current. Emission may be obtained either from the conductor itself or from a coating of thermoemissive material bonded to its surface. Filamentary cathodes have the basic advantages of mechanical simplicity, high emission efficiency, and rapid heating. A single continuous filament can be wound or folded to provide uniform emission distribution over large areas, or to expose a minimum of surface to destructive positive-ion bombardment. Because of their high efficiency and quick heating, filamentary cathodes are especially suitable for portable and mobile equipment, in which economy of operating power is an important consideration.

Early filamentary cathodes were made of pure tungsten, a dense, tough metal having an extremely high melting point. Because tungsten must be heated to very high temperatures to emit electrons in useful quantities, such filaments require considerable electrical power for excitation. Much higher emission efficiencies can be obtained with thoriated-tungsten filaments, which are drawn from tungsten slugs impregnated with thoria (thorium oxide). During tube processing, some

of the thorium oxide is driven to the surface of the filament and reduced to pure metallic thorium, which emits useful quantities of electrons when heated to a relatively low temperature. This surface thorium evaporates during tube operation, but is continuously replenished from the internal supply of thorium oxide.

Filamentary cathodes may also be made of inexpensive nickel alloys, rather than highly refractory metals, and coated with "alkaline-earth" oxides, which emit electrons freely at much lower temperatures than either pure tungsten or thoriated tungsten. The coating is applied to the filament in the form of a carbonate of the basic element (generally barium carbonate or a mixture of barium, calcium, and strontium carbonates), and is converted to the highly emissive oxide form during tube processing. Oxide-coated filaments are especially suitable for use in gas rectifiers, which require low-temperature cathodes capable of delivering high emission currents and withstanding intense positive-ion bombardment. Quick-heating filaments of specially constructed low-conductivity materials are incorporated in certain tube types designed for use in mobile and emergency-communications equipment. Tubes such as the 4604 are ready for full operation one second after the filament is turned on.

An **indirectly heated cathode**, or **heater-cathode**, is a hollow metal cylinder or sleeve having a coating of thermoemissive material bonded to its outer surface, as shown in Fig. 12. The cathode is heated by radiation from a metal filament, called the heater, which is mounted inside the sleeve. The cathode sleeve is usually electrically insulated from the heater. The emissive material employed is generally the same as that used on coated filamentary cathodes and operates at substantially the same temperature.

The electrical insulation between the heating and emitting elements in a heater-cathode provides several advantages from the standpoints of tube operation and circuit design. Because the current through the heater wire produces no voltage drop in its associated cathode, all points of the emitting surface are at

the same dc potential with respect to the other electrodes of the tube. Because of this feature, this type of cathode is often called a **unipotential cathode**. The emission is substantially uniform over the entire cathode. An indirectly heated cathode may generally be operated at a fixed or variable potential of either polarity with respect to its heater, provided this potential does not exceed the maximum heater-cathode-voltage rating of the tube.

The heater of a heater-cathode is usually a folded or helically wound filament of very fine tungsten or tungsten-alloy wire. The actual form of a heater is determined by the application requirements of the tube, the amount of insulation required between heater and cathode, and the internal dimensions of the cathode sleeve. A refractory metal is required because the heater has very small effective area and, therefore, must be operated at a high temperature to supply the thermal energy required by the

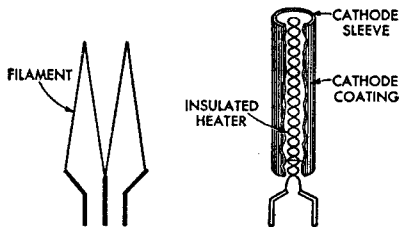

Fig. 11

Fig. 12

cathode. The insulation must be capable of withstanding these high temperatures and, in addition, must possess sufficient flexibility to accommodate bends of very small radius because the heaters must be folded or wound into forms compact enough to fit inside the cathode sleeve. The insulation generally used is aluminum oxide, or a similar material known commercially as "alundum." The insulation is first applied to the heater as a suspension of fine particles in a nitrocellulose binder, and is then sintered into a solid coating by operation of the heater for a carefully controlled period of time at a temperature slightly above its normal operating value.

One of the newer developments in cathode fabrication is the nickel-matrix cathode. A band of extremely fine pure-

nickel powder is sintered on the cathode sleeve at a temperature of 1200 degrees centigrade to form a sponge-like nickel matrix in the active area. After vacuum firing to ensure purity, the nickel matrix is impregnated with a barium-strontium coating. The resulting cathode is free from arcing caused by cathode peeling, is resistant to ion bombardment, and has a reservoir of emissive material which prolongs operating life. This type of cathode is especially suitable for tubes used in rf applications, hard-tube modulator applications, and applications requiring ruggedized types. Although the cathode requires slightly greater heater power, the use of barium-strontium oxide as the emissive coating permits operation at the relatively low cathode temperature of 830 degrees centigrade.

Heater-cathodes have excellent rigidity and dimensional stability, and permit the use of simpler, more compact, and more rugged electrode structures. They can also be placed very close to other tube electrodes, and thus make possible the reduction of internal losses caused by space-charge effects and electron transit time. Because tubes using these cathodes can usually be operated in any position, the equipment designer has greater freedom in locating tubes and components to provide maximum circuit efficiency or accessibility.

### Plates

Plates or anodes of power tubes are designed to collect as many as possible of the electrons made available by the cathode. They must also be capable of dissipating heat. Typical plate designs are shown in Fig. 13. The plates shown at (a) and (b) are typical types used in tubes having internal-plate construction. Figs. 13 (c) and (d) are typical types of external plates having integral radiators. Fig. 13 (e) shows an external plate of the type used in conduction-cooled tubes.

The plate at (a) is simple and extremely rugged. Plates of this type are used principally in low- and medium-frequency power tubes such as the 810 and 813.

The plate shown at (b) has radial fins to provide increased heat-radiating surface without appreciably increasing the capacitances between the plate and

other electrodes. Plates of this type are used in tubes such as the 826.

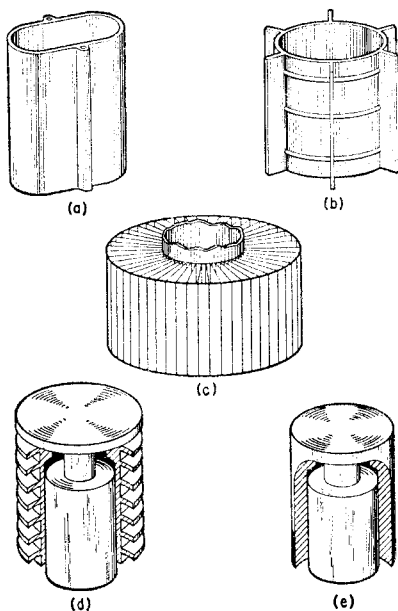

Fig. 13

The radiator design shown at (c) makes it possible to obtain substantial heat dissipation from plates of limited area by the use of forced-air cooling. Two variations of this design are used to increase cooling efficiency, one type has solid radial fins and the other has louvered axial fins.

The radiator design shown at (d) makes possible a simplified arrangement in which forced air flows in a direction transverse to the major axis of the radiator. This type of plate is used in tubes such as the 8121.

The plates shown at (e) has an integral aluminum-alloy conduction cylinder from the plate to the tube surface. The cylinder is treated to prevent diffusion welding of the conduction cylinder to the clamping surface of the conduction cooling system during high-temperature operation. A typical conduction-cooled tube having this type of plate is the 7844.

Internal plates may be made of many

materials, depending on the tube requirements. Nickel is often used for the plates of power tubes which operate at moderate temperatures because it can be formed readily into complex shapes and has the advantage of light weight, so that elaborate support structures are not needed. The heat-radiating ability of nickel plates can be substantially improved by means of a surface treatment called "carbonizing," in which a closely adhering layer of amorphous carbon is deposited on the surface of the nickel.

The thermal advantage of nickel is combined with high mechanical strength in a comparatively new material developed for the plates of small power tubes, which can be roughly described as carbonized nickel-plated steel.

Pure copper is now used extensively in external-plate designs for tubes in various power ranges and physical sizes. In tubes of this type, the copper plate forms part of the envelope, and forced-air or water cooling is used to maintain the temperatures of the copper and of the seal at safe values. With the aid of these cooling methods, tubes of relatively small physical size can handle very large amounts of power.

Other metals used for tube plates include materials such as tungsten, molybdenum, tantalum, and graphite. Zirconium is sometimes applied as a coating. The use of graphite, tantalum, or zirconium provides "getter" action which helps to maintain a high vacuum within a tube by cleaning up residual gases or those which may be given off by parts of the tube during operation. Graphite and molybdenum are usually subjected to some form of surface treatment during processing to improve their thermal efficiency.

### Grids

The grids of internal-plate types are generally constructed of individual wires arranged in parallel and welded to siderods, or of a single wire wound in spiral form and swaged to the siderods, or of a cage formed of individual rods.

In many external-plate beam power tubes, such as the compact ceramic-metal cermolox line of beam-power tubes, the grid cages are formed from concentric cylindrical metal blanks which are brazed

together at the proper spacing for the control and screen electrodes. The blanks are then cut simultaneously to form precision-aligned grids by an electrical-discharge machining process. Fig. 14 shows some of the typical grid structures used in beam power tubes.

Tube grids may be made of pure metals such as tungsten, molybdenum, or tantalum, of various alloys of tungsten and molybdenum, or of a nickel-manganese alloy. Because of its physical position between the cathode and the plate,

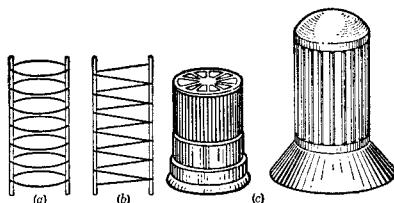

Fig. 14

the grid is subjected to heat radiated from both of these electrodes, and, if gas is present in the tube, may also undergo heavy positive-ion bombardment. As a result, the grid may emit primary electrons. Its tendency to emit electrons is further increased if it becomes contaminated with emissive material evaporated from the cathode. The grids are often coated with gold or platinum to reduce the possibility of primary emission.

Because power tubes are often operated under conditions in which the grid is driven positive with respect to the cathode, the grid can attract electrons which may possess sufficient kinetic energy to liberate large numbers of secondary electrons from the grid. A carbon coating is sometimes applied to the grid to reduce its tendency to secondary emission.

### Getters

A chemical "getter" is often used in electron tubes to absorb residual gases. The getter is usually a mixture of barium oxide and a reducing agent which frees the barium when the getter is "flashed." The getter material is usually concentrated in a small capsule, ribbon, or "tab," and is "flashed" or vaporized after the tube is sealed off. This tab is installed in the tube far enough from the

main electrode structure to assure that the getter will not be flashed by the heat developed during the exhaust process, and that getter material will not be deposited on the tube electrodes during flashing.

### Envelopes

Many small- and medium-sized low-frequency power tubes having internal-plate construction use simple cylindrical soft-glass envelopes and have the low-voltage electrode leads brought out through the base. "Hard" glasses of the borosilicate type are used for the envelopes of many medium- and high-power radiation-cooled tubes, particularly where compact construction is necessary to meet electrical-design requirements or equipment-space limitations. These glasses have relatively high softening temperatures, low rates of expansion, high electrical resistance, and excellent resistance to abrasion and "weathering."

Aside from the insulating materials employed in envelopes and bases, insulation is used in tube construction for electrode spacers. Spacers must be made of material which is unaffected by heat and can be formed with extreme accuracy. In small, glass-bulb type, low-power tubes, spacers are generally disks or wafers of high-quality mica; in larger tubes, they are usually bars or cross-arms of a low-loss refractory insulating material.

In many cases, insulating spacers are also used for centering the electrode assembly within the envelope. The mica wafers used for this purpose in smaller tubes sometimes incorporate special structural features which absorb vibration and mechanical shocks transmitted through the envelope. Refractory spacers are usually equipped with shock-absorbing metal springs at the points of contact with the envelope. However, in some power tubes, the cage grids have a cantilever design which eliminates the need for such insulating spacers and results in a simplified construction using fewer parts.

In some high-power tubes and tubes designed for operation at very-high and ultra-high frequencies, parts of the electrode structure are utilized in the tube

envelope. For example, in metal-glass tubes such as the 6161, the metal sections of the envelopes, which are extensions of the internal electrodes, provide convenient terminal connections, especially in cavity-type circuits. The intermediate glass sections provide the required interelectrode spacing and insulation.

As a result of new processing techniques, high-alumina ceramic is now widely used in tube envelopes and spacers. The flat surfaces of the ceramic spacers can be economically ground and metalized for use in the assembly of the metal parts. In the metalizing process, a finely divided molybdenum powder suspended in a binder is applied to the spacer by an adaptation of the silk-screen printing process and sintered onto the surface. The spacers are then nickel plated to improve the wetting action during brazing. Metalized spacers can be used as part of the tube envelope.

This type of envelope structure permits realization of good tube efficiency at ultra-high frequencies by the virtual elimination of objectionable lead reactances and losses in internal insulation. The metal sections of these envelopes are also used as electrode terminals, mounting facilities, heat-radiating surfaces, and often interelectrode shields. Pure copper is used for most of these envelope sections because of its high thermal and electrical conductivity and its high ductility, which readily permits the fabrication of special shapes.

In several ceramic-metal tubes, the plate sections of the envelopes are fitted with special radiators which make it possible to obtain substantially increased heat dissipation by the use of forced-air cooling and thus permit the use of relatively small tubes in high-power circuits. The grid-No.2 or screen-grid sections of the envelopes of some ultra-high-frequency metal-glass tubes provide external shielding between the grid-No.1 and plate sections. In the 7552 and other "pencil"-type tubes, the flange-type grid sections of the envelopes act as shields between the plate and cathode sections and thus minimize feedback when these tubes are used as amplifiers in ultra-high-frequency cathode-drive circuits.



# Power-Tube Applications

The power tubes listed in this Manual represent the RCA types most frequently used in transmitters and other radio-frequency (rf) power equipment operating at power-input levels up to approximately 4 kilowatts and at frequencies up to approximately 3000 megacycles per second. These tubes may in general be used as audio-frequency (af) or video-frequency power amplifiers or modulators, as modulated or unmodulated rf power amplifiers, as frequency multipliers, or as oscillators. The variety of designs represented includes types suitable for use in practically all forms of communications and industrial or scientific service.

## Amplification

Although power-tube applications may involve different circuit arrangements and operating conditions, they may all be considered forms of amplifier service in which the control voltage is applied between the grid (grid No.1 in a multigrid tube) and the cathode, and the output is taken from the plate circuit. (Oscillator service may be considered a form of amplifier service in which the output is fed back to the input.) Consequently, it is convenient to define tube operation in terms of the relationship between grid voltage and plate current when all other electrode voltages are held constant. This relationship, called the "mutual" or "transfer" characteristic of the tube, has the general form shown in Fig. 15. A system of classification based on this relationship is universally recognized by tube manufacturers and equipment designers.

In this system of classification, a portion of the generalized mutual characteristic is divided, as shown in Fig. 15, into three regions, A, B, and C, representing respectively the "linear" region, the region in the immediate vicinity of plate-current cutoff, and the region beyond cutoff. Tube operation may also be considered in three major categories—class A, class B, and Class C—each of which represents the type of response obtained when the operating point is in

the corresponding region of the characteristic.

In **class A** operation, the operating point is centered in region A so that the tube can respond to both positive and negative excursions of grid voltage. In this type of operation, plate current flows at all times.

In **class B** operation, the operating point is in the vicinity of cutoff so that the tube can respond to positive excursions of grid voltage. In this type of operation, plate current flows for approximately one half (180 degrees) of each cycle of an alternating grid voltage.

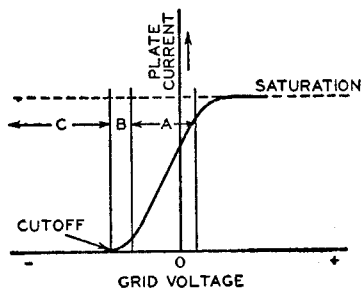

Fig. 15

In **class C** operation, the operating point is in the region beyond cutoff so that the tube can respond only to those portions of positive grid-voltage excursions which are positive with respect to the cutoff point. In this type of operation, plate current flows for less than one half (less than 180 degrees) of each cycle of an alternating grid voltage.

A fourth class of operation, **class AB**, is also used. In this class of operation, the operating point is in the lower portion of region A so that the tube responds unequally to positive and negative grid-voltage excursions above a certain amplitude. Consequently, the duration of plate-current flow on each cycle varies with the amplitude of the alternating grid voltage. In this service, plate current flows for more than one half

(180 degrees) of each cycle, but for less than the entire cycle.

The suffix 1 may be added to the letter or letters of a class identification to denote that grid current does not flow during any part of the grid-voltage cycle. The suffix 2 may be used to denote that grid current flows during some part of the cycle. In most cases, these suffixes are used only for class A<sub>1</sub> or class AB<sub>1</sub> and AB<sub>2</sub> operation.

### Class A Amplifiers

The basic circuit and operating characteristics of a class A amplifier are shown in Fig. 16. The operating point is centered on a linear portion of the dynamic transfer characteristic by the use of a suitable negative grid bias. The amplitude of the driving signal (alternating grid voltage) is controlled so that the grid

choice of operating conditions. For symmetrical driving voltages, the dc plate current remains substantially constant at the quiescent (zero-signal) value.

Because operation of a class A amplifier is restricted to the linear region of the characteristics, the maximum plate-current swing available between cutoff and saturation is not fully utilized. Consequently, the power output, which is proportional to the square of the plate-current swing, is somewhat limited. The highest theoretical plate-circuit efficiency (ratio of output power to input power) obtainable under class A conditions is 50 per cent. Efficiencies in the order of 40 to 45 per cent can be achieved in certain beam power tubes and pentodes, and efficiencies of 25 to 30 per cent in triodes.

Although class A power amplifiers

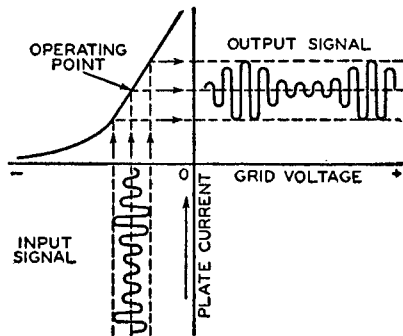
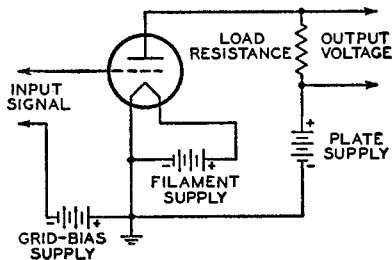

Fig. 16

is never driven sufficiently negative with respect to the cathode to cut off the plate current of the tube. Plate current, therefore, flows during the entire signal cycle (360-degree conduction). Although the general terms of class A operation permit the use of the grid-current region (class A<sub>1</sub> operation), the driving voltage is usually kept smaller than the grid bias so that the grid is not driven positive with respect to the cathode and, consequently, does not draw current. Under these conditions (class A<sub>1</sub> operation), waveform distortion (variation of output-signal waveshape from that of input signal) consists principally of even-order harmonics and can easily be limited to less than 5 per cent of full output in triodes and less than 7 per cent of full output in multigrad tubes by a proper

choice of operating conditions. For symmetrical driving voltages, the dc plate current remains substantially constant at the quiescent (zero-signal) value. Because operation of a class A amplifier is restricted to the linear region of the characteristics, the maximum plate-current swing available between cutoff and saturation is not fully utilized. Consequently, the power output, which is proportional to the square of the plate-current swing, is somewhat limited. The highest theoretical plate-circuit efficiency (ratio of output power to input power) obtainable under class A conditions is 50 per cent. Efficiencies in the order of 40 to 45 per cent can be achieved in certain beam power tubes and pentodes, and efficiencies of 25 to 30 per cent in triodes. Although class A power amplifiers have limited power output and poor efficiency, they are extremely economical from the standpoint of equipment requirements. Because they do not require driving power and, therefore, have high input impedance, they may be driven by low-cost voltage amplifiers employing direct coupling or simple resistance-capacitance coupling networks. Because the average plate currents remain substantially constant, plate supplies need not be designed for good regulation. The constant average plate current and moderate grid-bias voltage requirements also make it practicable to use self-bias without danger of excessive distortion, thus eliminating the expense of special bias supplies.

The power output required for a particular application may be obtained

either from a single tube having suitable ratings, or from two or more tubes operated in parallel, push-pull, or push-pull-parallel. Although single-tube stages are usually the most efficient electrically and the simplest mechanically, parallel and push-pull stages can provide substantial amounts of power output from relatively small and inexpensive tubes operating at low plate voltages.

In general, the power output that can be obtained from a given number of tubes is the same in parallel and in push-pull operation. Each method, however, has advantages. **Parallel** operation improves stability and output regulation because it reduces plate resistance in direct proportion to the number of tubes employed. In addition, it is usually the simplest and most convenient method of adding tubes to an existing stage because it does not require a change in circuit configuration or an increase in driving voltage. It does not, however, reduce harmonic distortion in relation to total power output, and may actually result in an increase in the total harmonic output unless certain precautions discussed in the *Power-Tube Operating Conditions and Adjustments* Section are observed.

A **push-pull** stage requires a driving circuit supplying two signal voltages 180 degrees out of phase (each equal to the voltage required by a single tube) and a center-tapped output transformer or load. Because push-pull operation increases effective plate resistance, it results in poorer output regulation. However, it provides a number of very important advantages.

Even-order harmonics generated in the opposite sides of a push-pull stage develop voltages of opposite polarity and substantially equal amplitude in the load, and are thus cancelled or substantially reduced in relation to the total power output. Consequently, a push-pull stage can deliver output of substantially better quality than a parallel stage using the same tubes and operating under the same conditions, or it can deliver higher output for the same amount of even-harmonic distortion. Higher power output per tube can also be obtained without an increase in plate voltage by the use of a plate-to-plate load

resistance only slightly larger than that recommended for single-tube operation. Although odd-order harmonic distortion is not cancelled or reduced by push-pull operation, this type of distortion is usually negligible in class A amplifiers, and may be minimized by the proper choice of operating conditions or by the use of inverse-feedback circuit arrangements.

Hum caused by the presence of ripple in dc plate, screen-grid (grid-No.2), or bias (grid-No.1) supply voltages, or by the use of ac filament or heater voltages, is also cancelled or substantially reduced in a push-pull stage. Push-pull operation thus simplifies power-supply filter requirements. Furthermore, it frequently eliminates the necessity for attenuating the low-frequency response of an audio or video amplifier to reduce interference from power-supply hum.

Push-pull at power amplifier stages can employ substantially smaller and less expensive output transformers than those required for equivalent single-ended stages. They are also inherently capable of better high-frequency response because corresponding tube and circuit capacitances are in series rather than in parallel, and thus cause substantially less shunting of the input and output circuits.

### Class B Amplifiers

The highest efficiencies and power outputs attainable in linear amplifiers

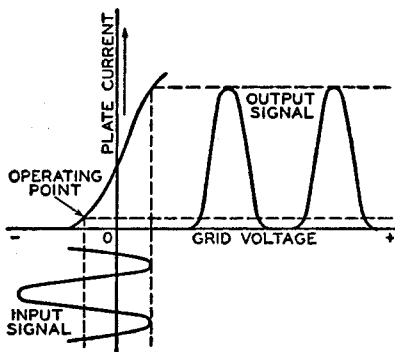

Fig. 17

are obtained under class B conditions. As shown graphically in Fig. 17, a class B amplifier is biased so that its operating point is just above plate-current cutoff. The tube, therefore, draws a very small

zero-signal plate current, and responds only to the positive portions of an ac input signal. Because the operating characteristic is highly asymmetrical, the plate-current waveform contains a large amount of even-harmonic distortion and is similar to that of a half-wave rectifier.

In class B of amplifiers, push-pull circuits such as that shown in Fig. 18 are used to obtain cancellation of the

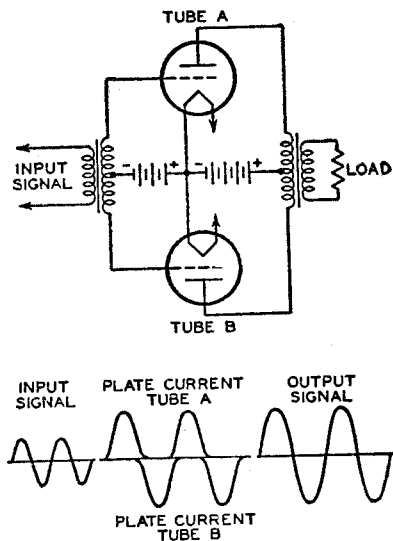

Fig. 18

even-harmonic distortion and amplification of both positive and negative portions of the signal waveform. In class B rf amplifiers, on the other hand, complete oscillations can be obtained from pulses of plate current in single-ended stages by the use of a tuned plate-tank circuit.

Because of the small zero-signal plate current, class B amplifiers may use higher plate voltages than are permissible for class A operation without danger of exceeding maximum plate-input ratings. The use of higher plate voltage and operation in the positive-grid region results in power outputs of four to six times the class A output.

Theoretically, the highest plate-circuit efficiency that can be achieved

under class B conditions is 78.5 per cent. This value may be closely approached in well-designed class B audio amplifiers. To achieve maximum power output and efficiency in a class B stage, however, it is necessary to supply driving power to the grids. Because the average plate current and grid current vary with the amplitude of the driving signal, the plate supply must have very good voltage regulation so that serious distortion and loss of power output will not occur on large input signals. For the same reasons, bias must be obtained from a separate, stable, fixed supply, and not from a grid resistor or cathode resistor.

As a result of the discontinuity in the composite characteristic of a push-pull class B audio amplifier, shown in Fig. 18, the plate current never falls to zero, but transfers abruptly from one tube to the other each time the driving voltage swings through the operating point. This "switching" action results in the generation of an odd-harmonic component which cannot be cancelled by push-pull operation and, because of its steep waveform, may cause spurious oscillations in the output transformer. The amplitude of this harmonic can be minimized by moving the operating point toward the linear region of the tube characteristic, *i.e.*, by increasing the zero-signal plate current and thereby reducing the plate-circuit efficiency. The most desirable tubes for class B audio service, therefore, are those having very steep mutual characteristics and very short "lower bends" so that the discontinuity in the composite characteristic will be small even when the operating point is very close to cutoff.

Because of their linearity and relatively high efficiency, class B amplifiers are particularly suitable for use as output amplifiers in rf transmitters employing "low-level" amplitude modulation. Modulation applied to the final or output stage of a transmitter is called "high-level" modulation; that applied to any stages preceding the final stage is called "low-level" modulation. When "low-level" amplitude modulation is employed, any stages following the modulated amplifier must be linear amplifiers to avoid distortion of the modulated rf waveform. The circuit of a typical class

B linear rf output stage is shown in Fig. 19.

The quiescent plate current of a class B rf amplifier, unlike that of its af counterpart, is not approximately zero but is proportional to the amplitude of the unmodulated rf driving signal or carrier. Consequently, the maximum efficiency is lower than that obtainable in af service, and varies from approximately 33 per cent for an unmodulated carrier to approximately 66 per cent for a fully modulated carrier. With symmetrical modulating voltages, the average plate current remains constant, and it is not necessary to employ a regulated plate supply.

The high degree of linearity required for the reproduction of complex modulated rf waveforms may be obtained by careful control of the position of the operating point and the maximum and minimum amplitudes of the modulated driving signal. Consequently, bias, tuning, and other operating adjustments for class B linear rf amplifiers are usually

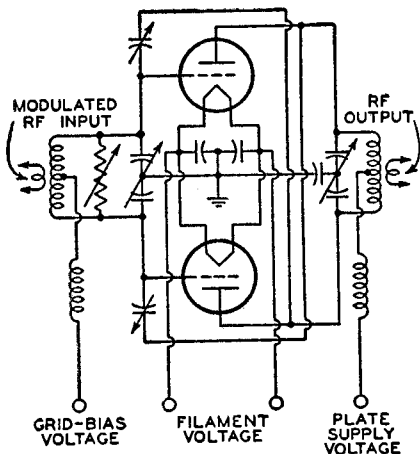

Fig. 19

much more critical than those for other types of rf power amplifiers.

Class B linear amplifiers are used as output amplifiers in **single-sideband, suppressed-carrier** radiotelephone transmitters. Because of the specialized modulation used in this type of transmission, the rf linear amplifiers for this service are discussed under *Power-Tube Circuit-Design Considerations*.

### Class AB Amplifiers

Multigrid tubes and low- $\mu$  triodes are not usually recommended or rated for use as class B audio-frequency amplifiers. Multigrid types generate large amounts of odd-harmonic distortion when operated in the vicinity of plate-current cutoff, and low- $\mu$  triodes require uneconomically large fixed-bias voltages and relatively high driving power. These types can, however, deliver relatively high output with low distortion and good efficiency when operated under class AB conditions.

Class AB operation is an intermediate classification combining certain characteristics of both class A and class B operation, as shown in Fig. 20. Like class B operation, it results in severe

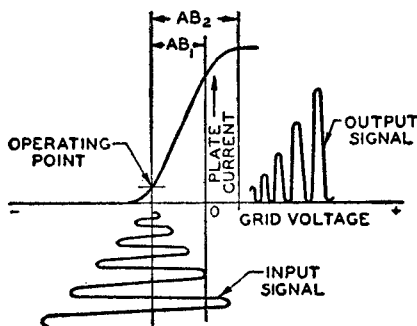

Fig. 20

even-harmonic distortion and, consequently, requires the use of a push-pull circuit when used in audio or video service. The bias is adjusted so that the operating point is in the lower portion of the linear region of the characteristic. Because of the relatively small quiescent plate current, the tube can be operated at a higher plate voltage than would be permissible under class A conditions, and can thus deliver a higher maximum power output.

On small input signals, operation takes place over a substantially linear region of the characteristic, and the tube operates as a class A amplifier. On large input signals, however, the negative grid-voltage excursions extend into the region beyond cutoff, and the tube operates as a class B amplifier.

In class **AB<sub>1</sub>** operation, the grid is never driven sufficiently positive to draw current. Because no driving power is required under these conditions, class **AB<sub>1</sub>** amplifiers, like class **A** amplifiers, may be driven by voltage amplifiers using direct or resistance-capacitance coupling. In class **AB<sub>2</sub>** operation, the grid is driven positive by the larger input signals and, therefore, draws current. Class **AB<sub>2</sub>** amplifiers thus require driving power, but can deliver substantially higher power outputs than class **AB<sub>1</sub>** amplifiers because of the larger plate-current swings that can be achieved.

The average plate current of a class **AB** amplifier varies with the amplitude of the driving signal, although this variation is smaller under class **AB<sub>1</sub>** than under **AB<sub>2</sub>** conditions. Consequently, plate and screen-grid (grid-No.2) supplies for these amplifiers must have good voltage regulation to assure that the full output capabilities of the tubes can be realized and the harmonic distortion kept low. Cathode-resistor bias can be employed for class **AB<sub>1</sub>** amplifiers, although higher power output and lower distortion can usually be obtained by the use of fixed bias. Fixed bias must be used for class **AB<sub>2</sub>** amplifiers.

The plate-circuit efficiencies that can be attained in class **AB<sub>1</sub>** amplifiers range from about 30 to 40 per cent for triodes to as high as 50 to 60 per cent for multigrid tubes. Efficiencies of 60 to 70 per cent can be attained in beam power tubes used as class **AB<sub>2</sub>** amplifiers.

### Class C Amplifiers

Maximum power output and plate-circuit efficiency can be obtained from triodes or multigrid tubes under class **C** conditions. Because these advantages are obtained at the expense of linearity, class **C** amplifiers cannot be used if it is necessary to reproduce variations in the waveform of the driving signal. Class **C** amplifiers can be modulated linearly,

however, and are extremely useful as rf power amplifiers, frequency multipliers, and oscillators.

A class **C** amplifier is operated with a negative control-grid (grid-No.1) bias substantially higher than that required for plate-current cutoff, as shown in Fig. 21. The quiescent plate current, therefore, is zero, and the tube responds only to those portions of positive grid-voltage excursions which are positive with respect to the cutoff voltage (indicated by the shaded areas of the input-signal waveform in Fig. 21). In practice, the grid is excited by an rf voltage having constant amplitude, and the plate-current waveform consists of relatively narrow pulses of equal height which have the same frequency as the excitation voltage but contain very strong odd- and even-order harmonic components. The height of these pulses (the **peak plate current**) is determined by the point on the transfer characteristic to which the tube is driven by the rf driving voltage. For a given pulse height, the average or dc value of the plate current is determined by the pulse width (*i.e.*, the conduction angle employed) and, therefore, varies inversely with the magnitude of the negative voltage for constant peak driving voltage.

The power output of a class **C** amplifier is proportional to the square of the plate voltage. Maximum power output is achieved when the excitation swings the plate current between zero and the saturation value during each conduction interval. To achieve this swing, it is necessary to drive the grid highly positive and, consequently, supply it with a substantial amount of driving power. The plate-circuit efficiency increases as the conduction angle is reduced, and theoretically may reach 100 per cent when the conduction angle is made infinitely small. Very small conduction angles usually cannot be obtained, however, without increasing the bias and excitation voltages to such high values that they exceed the maximum grid-voltage ratings of the tube. Driving-power requirements, which increase as the square of the excitation voltage, are also a limiting factor. However, plate-circuit efficiencies of 75 to 80 per cent are easily achieved.

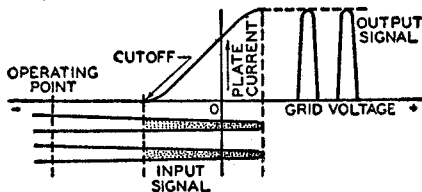

Fig. 21

The large grid-bias voltages required by class C amplifiers are conveniently and economically obtained by grid-rectification of the driving voltage (grid-resistor bias). This type of bias automatically adjusts itself to the amplitude of the excitation voltage to maintain the desired conduction angle, and allows the full plate-supply voltage to be applied between the plate and cathode of the tube. (Because grid-resistor bias depends on the presence of excitation, it is also necessary to employ some means for protecting the tube against damage by excessive plate current in the event that excitation fails or is accidentally removed.)

### Class C Telegraphy

The term "Class C Telegraphy" applies to applications in which power tubes may be operated at their highest ratings. It includes "straight-through" rf power amplifiers which are not "keyed" or modulated as well as those which are actually "keyed" for telegraphy service, oscillators, and amplifiers for frequency-modulated rf carriers.

The circuit of a typical "straight-through" class C rf amplifier employing a beam power tube is shown in Fig. 22.

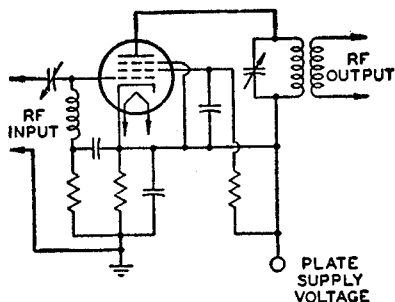

Fig. 22

The output circuit or "plate tank" is tuned to the excitation frequency, and the bias is such that the conduction angle is approximately 140 degrees. The power output is controlled by adjustment of the plate and screen-grid (grid-No.2) supply voltages, the load coupling, and the rf excitation.

Triode "straight-through" rf amplifiers must be neutralized to prevent self-

oscillation resulting from internal feedback through the grid-plate capacitance. Multigrid-tube "straight-through" amplifiers may also require neutralization to assure stability at the higher radio frequencies.

The circuit of a "keyed" class C rf amplifier is essentially the same as the one shown in Fig. 22 except that a "key" (a manually or automatically operated switch) is inserted in the plate, screen-grid, or cathode circuit.

The circuit and operating conditions of a class C amplifier for frequency-modulated signals are the same as those shown in Fig. 23 and described above. The only special consideration involved in the operation of such an amplifier is that the plate-tank circuit must be designed to have constant impedance over the entire frequency band covered by the carrier at maximum deviation.

### Modulated Class C Amplifiers

The plate current of a class C amplifier is proportional to plate voltage and, in the case of a multigrid tube, to screen-grid (grid-No.2) voltage. Within certain limits it is also proportional to control-grid (grid-No.1) bias and, in the case of certain pentodes and beam power tubes, to suppressor-grid (grid-No.3) voltage. Consequently, the output of a class C rf power amplifier can be modulated in amplitude by varying one or more of its dc electrode voltages in accordance with the amplitude variations of an audio or video signal.

Distortionless modulation requires that the relationship between the dc control voltage and the plate current be linear, and that both vary between zero and twice their unmodulated values on the peaks of the modulating signal. Under these ideal conditions, the peak power output of the class C amplifier at full (100-per-cent) modulation is 4 times the unmodulated output, and the average power output 1.5 times the unmodulated output.

Plate input and plate dissipation also increase 50 per cent when a class C amplifier is fully modulated. For plate modulation, therefore, the plate input and dissipation under carrier conditions

must not exceed two-thirds the maximum values for class C telegraphy. For control-grid, screen-grid, suppressor-grid, or cathode modulation, the permissible dc plate input is even smaller. Maximum dc plate-voltage and plate-current ratings for modulated class C amplifiers are usually not more than 80 per cent of the class C telegraphy values.

The audio or video power required for 100-per-cent modulation of a class C amplifier is equal to one-half the dc power input to the modulated circuit. For symmetrical modulating voltages, the dc plate current of the modulated amplifier and the dc supply voltage and current of the modulated-electrode circuit remain constant. The additional power output obtained by amplitude modulation does not increase the carrier power, but is equally divided between two symmetrical "sideband" signals.

The method of modulation that provides the greatest plate-circuit efficiency and linearity is **plate modulation**. In this method, the modulating voltage is connected in series with the dc plate supply for the class C amplifier, as shown in Fig. 23. In a beam power

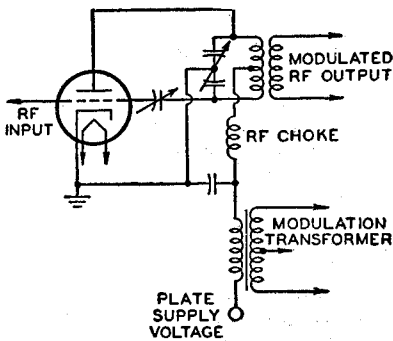

Fig. 23

tube, pentode, or tetrode, 100-per-cent plate modulation can be obtained without serious distortion on modulation peaks if the screen-grid (grid-No.2) voltage is modulated simultaneously with, and in the same proportion as, the plate voltage. The method used to modulate the screen grid depends on the type of screen-grid-supply circuit used. If screen-grid voltage is obtained from a separate

supply, the method shown in Fig. 24(a) may be used. If screen-grid voltage is obtained from the plate supply through a series resistor, the resistor should be connected to the modulated side of the plate supply circuit, as shown in Fig. 24(b). In all such cases, the modulator must be capable of supplying af power at least equal to one-half the combined dc inputs to the plate and screen-grid circuits.

A circuit in which modulation power is applied only to the plate of a beam power tube is shown in Fig. 24(c). The reactance of the af choke at the lowest modulating frequency should be at least equal to the dc screen-grid voltage divided by the dc screen-grid current.

The plate-circuit efficiency of a plate-modulated class C amplifier is usually in the order of 65 to 70 per cent.

**Control-grid (grid-No.1) or "grid-bias" modulation** requires very little modulating power and can provide good linearity. However, the power output obtainable is only one-third to one-half that obtainable with plate modulation, and plate-circuit efficiency is not usually greater than 33 per cent.

In control-grid modulation, the audio or video modulating voltage is connected in series with the bias supply for the class C amplifier. Consequently, the operating point of the modulated amplifier varies with the modulation. In order to obtain 100-per-cent modulation with good linearity, the plate current and effective plate voltage must swing between zero and twice their unmodulated values on the peaks of the modulating signal. The dc plate voltage, therefore, can only be about one-half that for plate modulation. Operating conditions, plate-circuit efficiency, and power output are almost identical with those for class B rf service.

The modulator must be capable of supplying the power required by the grid of the modulated amplifier on the positive peaks of the modulating signal. It must also have good output regulation because of the wide variation in the load impedance presented by the grid-circuit over the entire modulation cycle. The driver supplying the unmodulated car-



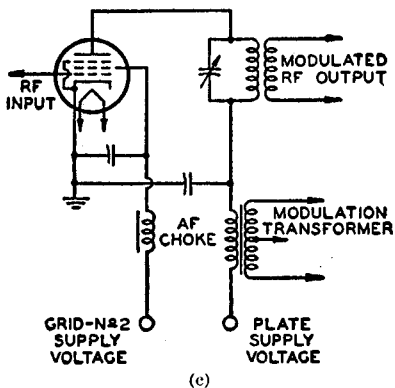
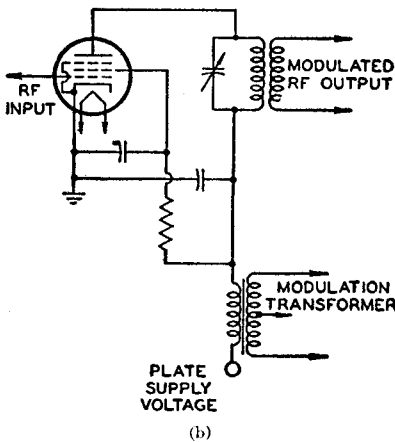
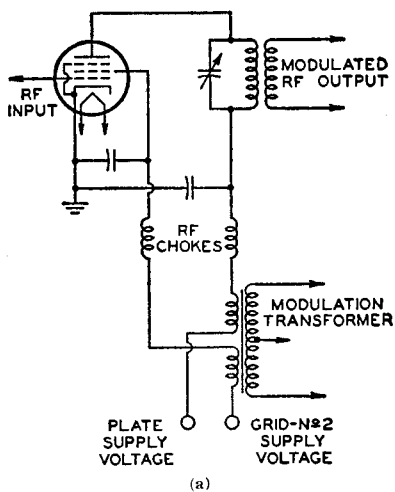

Fig. 24

rier and the bias supply for the modulated amplifier must also have very good regulation to avoid serious distortion. Bias must be obtained from a separate low-impedance, fixed supply, and not from a grid resistor or cathode resistor.

Because pentodes and beam power tubes are substantially free from the secondary-emission effects which occur in other multigrid types when the screen grid (grid No.2) becomes more positive than the plate, they may use screen-grid modulation without danger of serious distortion. **Screen-grid modulation** is similar to grid-bias modulation in that it requires relatively little af power, and provides substantially the same power output and efficiency. Unlike grid-bias modulation, however, it does not require the use of fixed bias or good driver regulation.

When screen-grid voltage is obtained from a separate supply, the modulating voltage may be connected directly in series with the supply circuit, as shown in Fig. 25 (a). When screen-grid voltage is obtained by the series-resistor method, it is generally necessary to use the "clamp-tube" method of modulation shown in Fig. 25 (b).

**Suppressor-grid (grid-No.3) modulation** can be used with certain beam power tubes and pentodes. Operating conditions are similar to those used in screen-grid modulation, except that the suppressor grid is supplied with a fixed negative dc bias voltage in addition to the modulating voltage. This bias voltage is adjusted so that the plate current and rf output current of the modulated amplifier under carrier conditions are one-half those obtained in class C telegraphy service with zero voltage on the suppressor grid. Under these conditions, the modulator is required to supply only a peak voltage equal to the suppressor-grid bias, and does not have to supply power because the suppressor-grid is not driven positive. Suppressor-grid modulation has only limited application, however, because relatively few beam power tubes and pentodes have the necessary linear relation between suppressor-grid voltage and plate current.

**Cathode modulation** combines the characteristics of plate and grid-bias modulation. The modulating voltage is

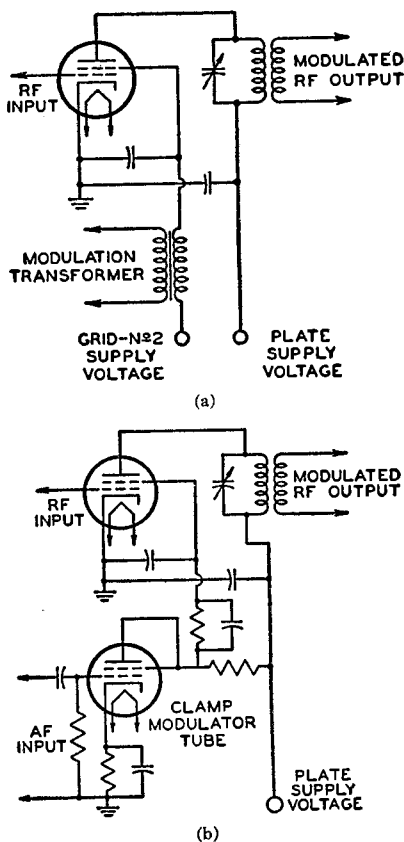

Fig. 25

introduced in the common dc cathode-return circuit of the class C amplifier and, therefore, varies the plate voltage and grid bias simultaneously. This method requires less modulating power than plate modulation, and permits the modulated amplifier to be operated with a plate-circuit efficiency proportional to the amount of modulating power available. However, the power output obtainable is less than that obtainable with plate modulation.

The type of coupling used between a modulator and the modulated circuit of a class C rf amplifier depends primarily on the amount of modulating power required. In suppressor-grid modulation or "clamp-tube" screen-grid modulation, it is usually practicable to use resistance-capacitance or impedance coupling because little or no modulating power is

required. In other cases, it is usually necessary to employ transformer coupling to obtain proper impedance matching and most efficient use of the available modulator power.

The bypass capacitors shown in Figs. 23 through 25 should have very low reactance at the rf carrier and sideband frequencies and high reactance at the highest modulating frequency. The modulation transformer must convert the equivalent resistance of the modulated dc supply circuit into the proper plate or plate-to-plate load resistance,  $Z$ , for the modulator output tubes and, consequently, should have a primary-to-secondary turns ratio,  $N_1/N_2$ , equal to  $\sqrt{ZI/E}$ , where  $I$  and  $E$  are the average current and dc input voltage of the modulated circuit, respectively.

The value used for  $I$  in this calculation is the current under carrier conditions (no modulation). In the case of plate modulation it is the total dc plate current; in the case of combined plate and screen-grid modulation using series-resistor screen-grid supply, it is the sum of the dc plate and screen-grid currents. In the case of grid-bias modulation,  $I$  is the dc grid current and  $E$  the grid-bias voltage.

### Frequency Multiplication

Any amplifier which generates harmonics can be used as a frequency multiplier provided the desired harmonic of the excitation frequency is present in the plate-current pulse. The fundamental and other harmonics may then be eliminated by means of a plate-tank circuit tuned to the desired harmonic. This procedure can be repeated in successive stages as often as desired.

By frequency multiplication, high-frequency carriers having a very high degree of frequency stability can be obtained. Frequency multiplication also makes it possible to obtain output in several harmonically related frequency bands (such as those assigned for amateur service) from a single oscillator circuit. For example, an oscillator operating in the 80-meter band (at a frequency between 3.5 and 3.58 megacycles per second) can be used with a series of frequency-doubler stages to obtain output in the 40-, 20-, and 10-meter bands.

Frequency multipliers are almost invariably class C amplifiers because maximum harmonic output can be achieved under class C conditions. When a class C amplifier is operated under the conditions normally employed for "straight-through" amplifier service, however, its efficiency as a frequency multiplier is relatively poor because even the strongest harmonics represent only a small fraction of the total power output. To obtain good efficiency in multiplier service, it is necessary to select a plate-conduction angle which has high harmonic content at the desired harmonic frequency. Consequently, frequency multipliers require substantially higher bias and excitation voltages and more driving power than "straight-through" class C amplifiers. The plate-circuit efficiency that can be achieved is usually not more than 60 per cent (doubler operation), and decreases rapidly as the degree of multiplication is increased.

Frequency multiplication of more than four is seldom practicable in a single stage because of the relatively small output at the high harmonics and the large amounts of driving power required. Although a triode frequency multiplier does not require neutralization because the grid and plate circuits are not tuned to the same frequency, neutralization can be used to reduce the amplitude of undesired frequency components in the plate-current waveform and thus increase the output at the desired harmonic frequency.

Because of its smaller conduction angle, a frequency multiplier is more sensitive to small changes in excitation voltage and loading than an equivalent "straight-through" class C amplifier and, therefore, has poorer output regulation. From the excitation standpoint, this difficulty can be minimized by the use of beam power tubes or pentodes rather than triodes. Improved regulation can also be obtained by the use of tubes in parallel. Very good output regulation can be obtained in doubler service by the use of a "push-push" circuit such as that shown in Fig. 26. In this type of circuit, the grids are excited in push-pull so that the tubes conduct alternately on successive half-cycles of

the excitation voltage. Because the plates are connected in parallel, two pulses of plate current flow in the common plate-tank circuit for each excitation cycle, doubling the power output and reducing the output impedance to one-half the value for one tube.

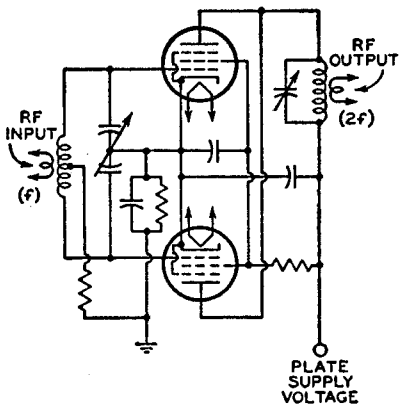

Fig. 26

Additional information on the characteristics of frequency multipliers and the efficiencies obtainable for various degrees of multiplication is given in the *Power-Tube Circuit-Design Considerations* Section.

### Oscillators

RF power oscillators are usually class C amplifiers which obtain excitation from their own output circuits and employ either quartz crystals or inductance-capacitance tuned circuits as frequency-determining elements. Crystal-controlled oscillators can provide the highest degree of frequency stability, and are used in equipment which operates entirely or predominantly on fixed frequencies or on fixed harmonically related frequencies. In general, mechanical considerations make it impracticable to cut crystals for fundamental frequencies higher than about 20 megacycles per second. A technique known as "overtone operation," however, permits crystals to be used for the control of oscillators operating at frequencies up to 100 megacycles per second and higher. Representative crystal oscillators are shown in the *Circuits* Section.

Inductance-capacitance frequency-determining elements are used for oscillators which must be capable of operating at any frequency within a specific band. They are also used for oscillators which must operate at frequencies above and below those for which crystals can be cut. The mechanical form of the LC tank and the type of oscillator circuit employed are usually determined by the operating frequencies involved. At the lower radio frequencies, well-designed electron-coupled oscillators employing conventional coils and tuning capacitors can provide stabilities comparable to those obtained in crystal oscillators. When followed by suitable frequency-multiplier stages, such oscillators can be used to control equipment operating at frequencies up to about 30 megacycles per second. Tuned-line oscillators of the type shown in the *Circuits* Section are usually employed in very-high-frequency (vhf) equipment. Ultra-high-frequency (uhf) oscillators usually require the use of coaxial- or cavity-type circuits as frequency-determining elements.

### Circuit Configuration

The amplifier applications discussed in this chapter have been illustrated by "grid-drive" circuits of the type shown in Fig. 16. In this type of circuit, the grid is employed as the "drive" electrode, the plate as the "output" electrode, and the cathode as the "ground" or reference electrode common to the input and output circuits of the tube.

As mentioned previously, a grid-drive triode rf amplifier must be neutralized to cancel the regenerative feedback which takes place through the grid-plate capacitance of the tube. Neutralization, however, becomes less effective and more difficult to achieve as the operating frequency is increased because of unavoidable resonance effects in the components of the neutralizing circuit. These effects alter the phase of the neutralizing voltage and, in most cases, make it impossible to obtain neutralization at frequencies of more than a few hundred megacycles. Although multigrid tubes capable of operating as grid-drive uhf amplifiers are available, triodes are generally preferable for uhf service because of their lower noise and

shorter electron-transit time, and because their simpler electrode structures and power-supply requirements make them more readily adaptable to installation in coaxial and cavity-type uhf tank-circuit components.

In many cases, this difficulty may be overcome by the use of "cathode-drive" circuits such as that shown in Fig. 27. In this method of operation, the cathode is the "drive" electrode and the grid is the "ground" electrode common to the input and output circuits. The grid thus acts as an electrostatic shield between the input and output terminals,

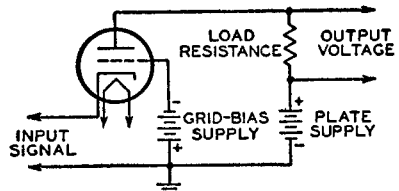

Fig. 27

and reduces internal feedback in the same manner and to approximately the same degree as the screen grid (grid No.2) of a multigrid tube.

A cathode-drive amplifier requires more driving power than a grid-drive amplifier because its input is shunted not only by the grid-cathode capacitance but also by the plate resistance,  $r_p$ , and load resistance,  $R_L$ , in series. This additional power is not wasted, however, but is added to the output because the driving voltage and plate-supply voltage are effectively in series across the load. The input of a cathode-drive amplifier is also shunted by the heater-cathode capacitance or by the capacitance to ground of the filament-supply circuit. This capacitance, however, may be neutralized by the use of suitable rf chokes in the heater or filament circuit.

A "cathode follower," shown in Fig. 28, is a grid-drive amplifier in which the cathode is used as the output electrode and the plate as the ground or common terminal of the input and output circuits. Because the grid-cathode capacitance of the tube does not shunt the driving circuit, the cathode follower has higher input impedance than a conventional grid-drive amplifier and, con-

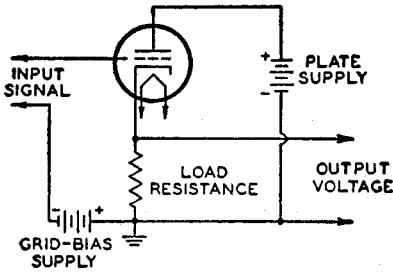

Fig. 28

sequently, requires less driving power for the same power output. The output impedance, which is composed of the ex-

ternal cathode resistance,  $R_k$ , and the plate resistance,  $r_p$ , of the tube in parallel, can be made as low as desired by the use of a suitable cathode resistor. Because the driving voltage and output are both developed across  $R_k$ , the voltage gain cannot exceed unity. Substantial power gains can be achieved, however, by the transformation from a high to a low impedance.

Because the voltage gain of a cathode follower is always less than unity, this type of amplifier cannot oscillate and, therefore, does not require neutralization, regardless of the operating frequency.

# Power-Tube Circuit-Design Considerations

The performance of a power tube depends not only on the conditions under which the tube is operated but also on the design of the associated circuits.

Proper circuit design assures economical and effective use of tubes and other components, simplifies equipment adjustment, provides for stable operation, thereby minimizing the likelihood of interference with other services, and provides a substantial measure of protection for the equipment, as well as greater personal safety.

In the production of moderate to large amounts of power at audio or radio frequencies, a signal or voltage having suitable characteristics is usually generated at a low power level. This signal is then amplified in one or more stages until the desired power level is achieved. In rf equipment, one or more amplifier stages may also be used to modify some characteristic of the signal, such as frequency, phase, or instantaneous amplitude. Consequently, the individual stages usually operate under substantially different conditions. Power-tube equipment, therefore, is designed one stage at a time, the usual procedure being to start with the output stage and work backward through preceding stages to the oscillator or input stage of the equipment. The design of a stage involves selection of the most suitable tube type; design of input and output coupling circuits; design of power-supply circuits; design of circuits for controlling gain or power output, or for varying the instantaneous amplitude, frequency, or phase of the output signal; and provision of means for stabilization against self-oscillation or other conditions which may result in interference, unauthorized radiations, distortion, or other undesirable effects.

In af equipment, all stages usually operate into non-resonant loads and have substantially the same frequency-response characteristics. The dc input to the tubes is constant, and power output is controlled by attenuation of the signal at a relatively low-level point in the system and/or by the use of remote-

cutoff tubes. Input, interstage, and output coupling is fixed, and control of over-all frequency response, where required, is usually accomplished by fixed or adjustable filters in one or more stages. Stabilization seldom involves procedures other than those necessary to prevent self-oscillation or minimize distortion.

In rf power-tube equipment, all stages usually operate into resonant loads. In a transmitter, individual stages may operate at different frequencies and, in many cases, each stage must also be capable of operating at any frequency within one or more bands. The power output of an rf stage is controlled by adjustment of the dc input, rf excitation, and loading. In transmitters, consideration must also be given to the design of "keying" or modulating circuits. Because the input and output impedances of rf amplifier stages vary considerably with changes in operating frequency, excitation, and loading, interstage and output coupling circuits are generally made adjustable.

Stabilization of rf equipment usually involves the elimination not only of self-oscillation, but also of undesired harmonics, and may also involve the isolation and elimination of parasitic oscillations in circuit components and wiring.

## Tube Selection

The selection of the most suitable tube type for a particular application depends to a large extent upon the type of primary power available and the desired power sensitivity. Tubes having the same filament voltage or current ratings should be used throughout the equipment wherever possible to simplify power-supply requirements. Driving-power requirements vary widely with application, operating frequency, type of circuit employed, and other factors. Because of its importance in circuit design, driving power is discussed at greater length later in this section. Mechanical considerations such as equipment space limitations, layout, and ventilation, as well as economic considera-

tions, also affect tube selection.

An initial selection of types having suitable filament-voltage, plate-voltage, plate-input, and plate-dissipation ratings for a particular application can be made from the power-tube selection guides in the *Application Tables* Section. The final selection is then made by comparison of the technical data for the individual types.

In the selection of a tube for use as an unmodulated rf amplifier, frequency multiplier, or oscillator, the maximum plate-input and plate-dissipation ratings and the relative plate-circuit efficiency of the tube at the highest frequency at which the equipment is to operate must be considered. When ability to change frequency quickly is an important consideration in the design of a transmitter, it is desirable to select types which require few or relatively minor changes in operating conditions with changes in frequency. In this respect beam power tubes and other multigrid types are generally superior to triodes.

Additional factors which must be considered in the selection of tubes for use as modulated rf amplifiers depend on the type and degree of modulation to be employed. These factors are discussed in the *Power-Tube Applications* Section and in the *Technical Data* Section.

### Multiple-Tube Stages

Most satisfactory operation of parallel, push-pull, or push-pull-parallel stages is obtained when the plate currents of the individual tubes are equal. Equalization of average plate currents minimizes the danger of excessive plate dissipation in one or more tubes, particularly in stages which obtain bias from a common fixed supply or a common grid resistor. Equalization of zero-signal plate currents in push-pull af amplifier stages substantially aids the cancellation of even-order harmonic distortion. For complete cancellation of even-order harmonics, the plate-current excursions in the two sides of a push-pull stage must also be equal. This type of equalization (dynamic balance) is difficult to achieve, however, because of the large number of tube and circuit variables involved.

Zero-signal or average plate currents in multiple-tube stages are most

easily equalized by means of individual grid-bias adjustments. The particular method used in any case depends on the type of cathode employed in the tubes and on the circuit configuration. Two methods in general use are shown in Fig. 29.

Multiple-tube stages employing beam power tubes and other multigrid

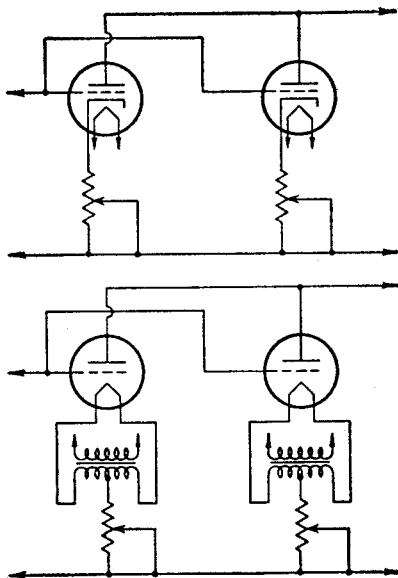

Fig. 29

types should be provided with individual adjustments for screen-grid (grid-No.2) voltage as well as for control-grid (grid-No.1) bias. Such adjustments make it possible to avoid excessive screen-grid dissipation in individual tubes and are frequently of considerable aid in obtaining plate-current equalization.

### AF Power Amplifiers

**Class A af power amplifiers** do not normally draw grid current or require driving power. Furthermore, they draw substantially constant plate and screen-grid currents and, therefore, can employ simple cathode-resistor (self) bias. After the most suitable tube type has been selected and the tube operating conditions determined, the principal considerations in the design of a class A amplifier are: (1) the selection of a driver capable of supplying the required

peak driving voltage; (2) the selection of input and output coupling devices having the desired frequency and impedance characteristics; (3) the selection of bypassing and decoupling components necessary to minimize hum, assure stability, or improve the over-all frequency response.

For this class of amplifier, the driver may be a class A voltage amplifier and the input-coupling device a simple resistance-capacitance network. Resistance-capacitance coupling provides good frequency-response characteristics economically and permits the use of simple

class AB<sub>1</sub> af power amplifiers are substantially the same as those for class A amplifiers, except that special consideration must be given to the characteristics of plate and screen-grid (grid-No.2) supply circuits, and to the method used for obtaining grid bias. Because the average plate and screen-grid currents of a class AB<sub>1</sub> amplifier vary with the amplitude of the driving signal, serious distortion and inadequate power output may result on large input signals unless plate and screen-grid supply voltages are well regulated and the bias is extremely stable. For optimum performance, plate-

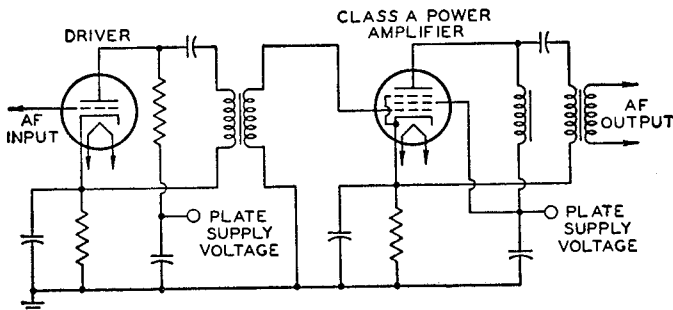

Fig. 30

phase-inverter circuits for driving push-pull stages. Transformer coupling can also be used between the driver and the class A power amplifier. Interstage transformers having wide frequency response are relatively expensive, however, and are seldom used unless a substantial voltage step-up must be obtained between driver and class A power amplifier.

Plate- and screen-grid-supply circuits for single-ended class A power amplifiers must be well filtered to minimize hum and undesired coupling with other stages in the equipment. These circuits, as well as the cathode-bias resistor, must also be adequately bypassed to the cathode at the lowest frequency to be reproduced to assure full output from a single-ended stage. When particularly good response at low audio frequencies is required in a single-ended stage, it may be necessary to use parallel feed, as shown in Fig. 30, to eliminate unbalanced dc from the output transformer and the driver transformer.

Circuit-design considerations for

supply regulation should be within 10 per cent, screen-grid-supply regulation within 5 per cent, and grid-bias-supply regulation within 3 per cent.

**Class B and class AB<sub>2</sub> af power amplifiers** normally draw grid current on large input signals and, therefore, require appreciable driving power. Power output, frequency response, and harmonic distortion are critically dependent on the circuit constants employed in the amplifier and in the driving circuit. Consequently, the design of a class B or class AB<sub>2</sub> amplifier involves the design of a complete system, including the driver stage, the interstage coupling circuit, the output (class B or class AB<sub>2</sub>) stage, and the power-supply and bias circuits for both stages.

The driver must be capable of supplying both the signal power required to drive the class B or class AB<sub>2</sub> stage to full output and the power lost in the interstage coupling circuit.

The driving circuit must also have very good regulation characteristics be-



cause the input impedance of a class B stage varies from a very high value on small input signals (open-circuit value when no grid current is drawn) to a very low value on large input signals (when maximum grid current is drawn). Consequently, it is usually necessary to use an amplifier having very low output impedance as the driver, and an efficient transformer as the interstage coupling device. For minimum over-all harmonic distortion, the driver should be a push-pull class A or class AB<sub>1</sub> amplifier. If the driver stage uses triodes, it may be operated into a load impedance higher than that normally used for the tube type employed to minimize distortion at some reduction of available output power.

The interstage or "driver" transformer must provide the proper load for the driver under maximum-drive conditions (*i.e.*, when the input impedance of the output stage is minimum) and, therefore, is usually designed as a step-down transformer. The step-down ratio required will depend on the specific tube types used in the driver and output stages, the load resistance used for the output stage, the peak power efficiency of the driver transformer, and the amount of harmonic distortion that can be tolerated in the output.

The driver transformer must also have the desired frequency-response characteristics when operated into a very high load impedance (or even an open circuit) such as that presented by the grid circuit of the class B or class AB<sub>2</sub> stage on very small driving signals. To assure good response at the higher audio frequencies, the transformer must also be designed to have low leakage reactance. In addition, the resistance of the secondary windings must be kept low to minimize dc voltage drops which might affect the operating bias during grid-current flow.

For maximum power output and minimum harmonic distortion, the operating point of a class B or class AB<sub>2</sub> amplifier must not be affected by the normal variations in average plate, screen-grid, and control-grid currents. Consequently, bias must be obtained from a separate fixed supply, such as a battery or a rectifier having very low in-

ternal resistance, and plate and screen-grid supplies must have exceptionally good regulation characteristics. For optimum performance, plate-supply regulation for class B and class AB<sub>2</sub> amplifiers should be within 5 per cent, and screen-grid-supply and grid-bias-supply regulation should be within 3 per cent.

Output transformers for class B and class AB<sub>2</sub> amplifiers should have low-resistance windings to minimize power losses at the large plate currents which flow under maximum-signal conditions. They should also have very low leakage inductance to assure good response at the higher audio frequencies and to minimize the danger of parasitic oscillations and "ringing."

### Modulators

An af power amplifier used to modulate a class C rf amplifier must be capable of delivering an undistorted power output equal to one-half the average power in the modulated circuit to permit 100-per-cent modulation. In addition, the modulation transformer must convert the equivalent resistance of the modulated circuit into the proper plate-load resistance for the modulator stage.

The average power,  $W_a$ , in watts in the modulated circuit is equal to  $EI$ , and the effective resistance,  $R_2$ , is equal to  $E/I$ , where  $E$  is the dc potential across the modulated circuit in volts and  $I$  is the total direct current in amperes. The proper turns ratio (primary to secondary),  $N_1/N_2$ , for the modulation transformer is then given by

$$\frac{N_1}{N_2} = \sqrt{\frac{R_1}{R_2}}$$

where  $R_1$  is the effective plate (or plate-to-plate) load resistance required for the af amplifier and  $R_2$  is the effective resistance of the modulated circuit in ohms.

**Example (1):** Determine the amount of af power,  $W_0$ , required for 100-per-cent plate modulation of push-pull class C 812-A triodes operating under ICAS conditions. (Values are given in the technical data for the 812-A under Plate-Modulated RF Power Amplifier—Class C Telephony, Typical Operation.)

$$W_0 = \frac{W_a}{2} = \frac{(1250)(2 \times 0.140)}{2} = 175 \text{ watts.}$$

This amount of af power can be obtained from a push-pull 811-A class B amplifier operating under CCS conditions at a dc plate potential of 750 volts. (Values are given in the technical data for the 811-A under AF Power Amplifier and Modulator—Class B, Typical Operation.) The effective plate-to-plate load resistance required for the 811-A's is 5100 ohms. The equivalent resistance of the 812-A plate circuit is

$$R_2 = \frac{1250}{2 \times 0.140} = 4464$$

or approximately 4500 ohms.

Consequently, the turns ratio (primary to secondary) required for the modulation transformer is

$$\frac{N_1}{N_2} = \sqrt{\frac{5100}{4500}} = \frac{1.1}{1} \text{ (approx.)}$$

**Example (2):** Determine the amount of af power,  $W_o$ , required for 100-per-cent simultaneous plate and screen-grid modulation of a single 813 class C amplifier operating under ICAS conditions. (Values are given in the technical data for the 813 under Plate-Modulated RF Power Amplifier—Class C Telephony, Typical Operation.) Screen-grid voltage for the 813 is obtained through a series voltage-dropping resistor from the plate supply, as shown in Fig. 24(c).

$$W_o = \frac{W_a}{2} = \frac{(2000)(0.200+0.040)}{2} = 240 \text{ watts}$$

This amount of power can be obtained from a push-pull 811-A class B amplifier operating under ICAS conditions at a dc plate potential of 1000 volts. (Values are given in the technical data for the 811-A under AF Power Amplifier and Modulator—Class B, Typical Operation.) The effective plate-to-plate load required for the 811-A's is 7400 ohms. The equivalent resistance of the 813 plate and screen-grid circuit is

$$R_2 = \frac{2000}{0.200+0.040} = 8333$$

or approximately 8400 ohms.

Consequently, the turns ratio (primary to secondary) required for the modulation transformer is

$$\frac{N_1}{N_2} = \sqrt{\frac{7400}{8400}} = \frac{0.94}{1} \text{ (approx.)}$$

In the design of af power amplifiers for modulator service, consideration

should also be given to the magnetizing effect of the unbalanced dc current flowing in the secondary windings of the modulation transformer. If this current is large enough to cause a decrease in low-frequency response, a suitable blocking capacitor and af choke should be used to isolate the unbalanced dc current from the secondary winding.

### RF Power Amplifiers

**Class B and class C rf power amplifiers** normally operate into resonant load circuits which can be designed to filter out undesired harmonics of any order. Consequently, push-pull circuits do not have to be used to minimize even-order harmonics. Push-pull operation is sometimes used for "straight-through" class B and class C amplifier stages, however, as a means of obtaining increased output or improved operation at the higher radio frequencies. It is also used in frequency-multiplier service as a means of emphasizing odd-order harmonic frequencies.

### Linear RF Power Amplifiers

For **single-sideband suppressed-carrier (SSB) operation**, only one sideband is transmitted, and the carrier is suppressed to the point of nonexistence, as shown in Fig. 31. In an SSB transmit-

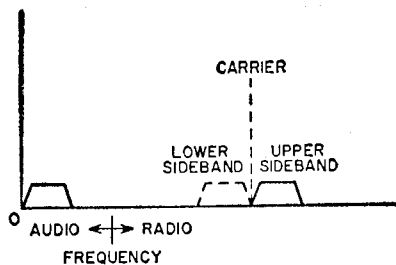

Fig. 31

ter, the signal to be transmitted is usually generated at a low frequency, converted to the transmitted frequency in one or more stages of frequency conversion, and amplified to the desired power level by linear rf power amplifiers. An SSB receiver performs similar functions in the inverse order and, except for the demodulating stage, does not differ significantly from the conventional superheterodyne communications receiver.

The generation of SSB signals is

simplified by use of a low-level stage called an *exciter*, which amplifies the signal to the level necessary to drive the power amplifiers of the system. The driving power required is usually small because high-gain beam power tubes are used in most power amplifiers. This driving power, which may be as small as a fraction of a watt, can be easily obtained with receiving-type tubes; however, in the special case of zero-bias cathode-driven power amplifiers, drive requirements are substantially higher.

Single-sideband transmission requires the use of linear rf power amplifiers because the amplitude and phase relationships of the sideband components of the signal must be faithfully maintained. The required fidelity may be achieved by choosing a power amplifier tube having a linear transfer characteristic, using feedback circuits to enhance the linearity of the stage, and operating the power-amplifier tube at almost class A operation, within plate dissipation ratings. High efficiency, however, is best achieved by operation at close to class B conditions. These conflicting demands require a compromise between linearity and efficiency.

Linear rf power tubes should be capable of high gain and high plate dissipation. High gain permits the use of receiving-type tubes in the exciter stage and enhances reliability by reducing the number of stages necessary to achieve a specified power level. Power-conversion efficiency must also be considered, but compromise with linearity should be made only after satisfactory distortion levels have been achieved.

The classes of operation suitable for linear rf power amplifiers include: class A, class AB<sub>1</sub>, class AB<sub>2</sub>, class B with bias, and class B with zero bias. Class A operation is the most linear, but is also the least efficient. Application is generally limited to low-power-level amplification. Class AB<sub>1</sub> is the best compromise of linearity, efficiency, and gain, except for the special cases noted for the other classes of operation. In special cases, beam power tubes are operated as class AB<sub>2</sub> amplifiers when the power level must be maintained at the expense of linearity; under similar conditions, low- and medium-mu triodes are operated at class B with

bias. For high-mu triodes, operation as class B with zero bias provides circuit simplicity, good linearity, and efficiency, but has poor gain and requires high driving power.

### Driving Power

One of the most important considerations in the design of a class B or class C rf power-amplifier stage is the provision of adequate driving power. The data for most newer tube types lists "typical" **driver-power output**, which represents circuit and tube losses. This value is the actual power measured at the input to the grid-No.1 circuit and, therefore, changes as the stated conditions change. The "typical" **driving power** listed in the data for many older types indicates only the signal power dissipated in the internal grid-cathode circuit of the tube and in the resistance of the bias circuit. These figures do not normally include driving power that may be lost in tube sockets or in the components and wiring of driving circuits, or tube losses due to electron-transit-time phenomena, internal lead impedances, or other factors.

The driver stage must be capable of delivering sufficient signal power to supply all the tube and circuit losses. Although these losses vary with frequency, tube operating conditions, circuit configuration, and the components and layout of the circuit, they can be estimated with reasonable accuracy for "straight-through" amplifiers. At frequencies up to about 30 megacycles per second, total tube and circuit losses are approximately twice the driving-power figures given in the tube data. At higher frequencies, electron-transit-time losses and other tube and circuit losses increase so rapidly that it is generally necessary to use a driver stage capable of supplying 3 to 10 times the driving power shown in the tube data.

The driving power available for a class C amplifier or frequency multiplier should be sufficient to permit **saturation** of the driven tube, *i.e.*, a substantial increase or decrease in driving power should produce no appreciable change in the output of the driven stage. This consideration is particularly important



sources having high internal resistance should not be used as fixed-bias supplies. If such devices are used, the normal flow of grid current may charge the batteries to voltages greater than their rated values, or may increase the voltage drop in the rectifier bleeder. The resulting increase in total operating bias may cause a substantial reduction in the power output of the stage.

Class C amplifiers generally use **grid-resistor bias** obtained by grid rectification of the driving signal because large bias voltages are required (approximately twice cutoff value, or more).

The value required for the grid resistor (in ohms) is equal to the negative grid bias (in volts) divided by the dc grid current (in amperes). If the dc grid current of two tubes in parallel or push-pull flows through a common grid resistor, the value of the resistor is one half that for a single tube. Typical class C amplifier stages using grid-resistor bias are shown in the *Circuits* Section.

Although grid-resistor bias is economical as regards supply requirements and circuit components, and adjusts itself automatically to the amplitude of the driving signal, it provides protection only when adequate excitation is applied to the stage. Consequently, class C amplifiers should generally be supplied with sufficient fixed or self bias to limit the zero-signal plate and screen-grid currents to safe values in the event that excitation fails or is accidentally removed.

The value required for a **self-bias cathode resistor** (in ohms) is equal to the required self-bias voltage (in volts) divided by the total cathode current (in amperes). In a triode, the total cathode current is the sum of the dc plate current and dc grid current. In a beam power tube or tetrode, dc screen-grid (grid-No.2) current must be included in the cathode current. In a pentode having an independent suppressor grid (grid No.3), any current drawn by the suppressor grid must also be included.

Plate-modulated class C amplifiers are usually operated with higher grid-bias voltages than unmodulated amplifiers because a linear modulation characteristic usually requires the bias to vary with the modulating voltage, and this variation is easier to obtain if it is

not too large a fraction of the total bias. It is usually necessary to use a combination of fixed and grid-resistor bias to provide the desired variation in bias voltage. The grid resistor should not be bypassed for audio frequencies.

Grid bias for grid-modulated class C amplifiers must be extremely stable to avoid distortion of the modulated carrier and excessive dissipation. Consequently, bias should be obtained from a fixed supply having very good regulation characteristics, and not from a grid resistor or cathode resistor.

Grid bias for screen-grid or suppressor-grid modulated rf amplifiers is not particularly critical and may be obtained by any of the methods described above. Cathode-bias resistors used in such amplifiers, however, should be bypassed for the lowest modulating frequency as well as for rf.

Highly stable fixed-bias voltages can be obtained from electronically regulated bias supplies or by the use of **voltage-regulator tubes** in place of a load resistor in the output of a bias rectifier. Voltage regulator tubes having regulated-voltage ratings between approximately 75 and 150 volts are available. When regulated fixed-bias potentials greater than 150 volts are required, tubes having suitable voltage ratings and similar current ratings may be connected in series. When it is necessary to accommodate larger currents than can be safely handled by a single regulator tube, types having the same voltage rating can be connected in parallel. In parallel arrangements, a resistor having a value of approximately 100 ohms must be connected in series with each tube to assure equal division of the total load current. Examples of the use of voltage-regulator tubes are shown in Fig. 33.

### Frequency Multipliers

The principal considerations in the design of frequency multipliers are the choice of suitable tube types and the determination of operating conditions which will provide maximum power output at the desired harmonic.

For a fixed value of peak plate current, the harmonic output of a class C amplifier increases at first as the width of the plate-current pulse is decreased,

but then begins to decrease as the pulse width is decreased still further. There is a value of conduction angle, therefore, at which the ratio of any harmonic components to the peak value of the plate-current pulse is a maximum. These maxima occur at conduction angles of about

bias rating of the tube, as well as by the peak-emission capabilities of the cathode. The over-all efficiencies obtainable in frequency-multiplier service are also limited by driving-power requirements, which increase as the square of the grid-driving voltage. Tube types for use in frequency-multiplier stages should have high-wattage filaments or cathodes capable of supplying the very high peak-emission currents required, and high trans-conductance or high amplification factors to provide high power sensitivity.

### Oscillators

The principal consideration in the design of an oscillator is usually frequency stability, rather than high efficiency or high power output. The frequency stability of an oscillator is determined partly by the mechanical characteristics of a crystal or an inductance-capacitance tuned circuit, and partly by the conditions under which the tube is operated.

It is usually necessary to employ one or more of the following measures to obtain a high degree of frequency stability:

- (1) Minimize mechanical vibration and variations in ambient temperature which might alter the characteristics of the frequency-determining crystal or tuned circuit.
- (2) Limit the amplitude of oscillation to minimize internal heating in the frequency-determining crystal or tuned circuit which might alter its characteristics.
- (3) Minimize variations in supply voltages by the use of regulated plate and screen-grid (grid-No.2) supplies.
- (4) Minimize variations in loading, or isolate the oscillator from a varying load by means of a "buffer" stage (usually a class A or class AB<sub>1</sub> amplifier).
- (5) Use special components or circuit arrangements to compensate for variations in temperature, load, or supply voltage.

The frequency stability of a crystal oscillator is determined principally by the temperature coefficient and mounting of the crystal, and only to a limited extent by tube operating conditions and loading. Consequently, it is not usually

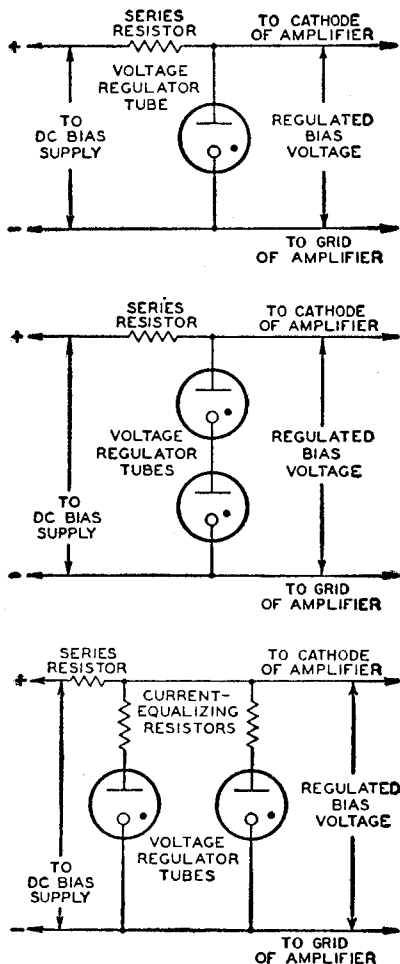

Fig. 33

120 degrees for frequency doublers, 80 degrees for triplers, and 60 degrees for quadruplers.

Because the use of small conduction angles usually requires the use of large values of negative bias, power output and plate-circuit efficiency at the higher harmonics are limited by the grid-

necessary to use regulated plate and screen supplies for such oscillators, or to isolate them from varying loads by means of buffer stages. When extremely high stability is required, however, (*e.g.*, in frequency standards and commercial transmitters), it is usually necessary to employ all of the stabilizing measures described above and to maintain the crystal at a constant temperature in a thermostatically controlled oven.

Crystals, particularly those which are ground, "grown," or otherwise dimensioned for the higher radio frequencies, are extremely fragile and may be destroyed by overloading or the use of excessive feedback. Triodes used in crystal oscillators should, therefore, be low-power types, or be operated at substantially reduced plate voltages to minimize crystal loading and limit the amplitude of oscillation. Beam power tubes, pentodes, and tetrodes cause relatively little crystal loading because of their small driving-power requirements, and provide limited feedback even when operated at full plate voltage because of their internal shielding. Consequently, these types are especially suitable for use in crystal oscillators. They can also deliver substantially higher power outputs than triodes of comparable size, and thus permit the use of fewer stages in achieving a desired final power output.

When multigrad tubes having very good internal shielding are used in crystal-oscillator circuits, it may be necessary to use external capacitive feedback to obtain oscillation. This feedback may be provided by a small adjustable capacitor (usually not more than 2 or 3 micromicrofarads) connected between the grid-No.1 terminal and the plate terminal of the tube. Under no circumstances should the external feedback capacitance be larger than necessary for oscillation, because even small excess values may provide sufficient feedback to destroy the crystal.

To obtain good frequency stability in a variable-frequency oscillator, it is usually necessary to use all the stabilizing measures described above. It is particularly important to employ good components and sturdy mechanical construction, and generally desirable to enclose the entire oscillator tank circuit in a

heavy metal shield having good thermal stability. Good isolation from load variations can be obtained without a buffer stage by the use of an electron-coupled circuit. In this type of oscillator circuit, the control grid (grid No.1) and screen grid (grid No.2) of a multigrad tube are the actual oscillator terminals, the screen grid acting as the anode. Power output is taken from the plate circuit, which is coupled to the oscillator only by the internal electron stream.

Crystal oscillators and variable-frequency oscillators can also be used as harmonic generators and frequency multipliers. Electron-coupled oscillators are particularly suitable for use as frequency multipliers because selection of desired harmonics can be accomplished in the plate circuit without affecting the oscillator frequency.

### Parallel-Tuned Tank Circuits

The performance of an rf power amplifier, frequency multiplier, or oscillator is critically dependent on the characteristics of the circuit which forms its plate load. The characteristics of the load circuit affect the power output, harmonic output, plate dissipation, and driving-power requirements of the stage.

The plate-circuit load of a class B or class C rf amplifier is usually a parallel-tuned resonant tank of the type shown schematically in Fig. 34. The resonant

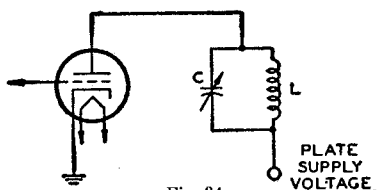

Fig. 34

frequency,  $f$ , of such a circuit in megacycles per second is given by

$$f = \frac{10^3}{2\pi\sqrt{LC}} \quad (1)$$

where  $L$  is inductance in microhenries, and  $C$  is capacitance in micromicrofarads.

This expression shows that the resonant frequency varies inversely as the square root of the product  $LC$ . Doubling both  $L$  and  $C$  halves the resonant frequency. For any given frequency,  $f$ , the product of  $L$  and  $C$  is a constant.

Except in circuits operating at ultra-high and higher frequencies,  $L$  is usually "lumped" or concentrated in a coil or specially formed conductor, and  $C$  is a combination of lumped and distributed capacitance. The lumped capacitance component is usually a variable capacitor, and the distributed component is composed of the self-capacitance of the tank, tube capacitances, and the stray capacitance of the circuit. Consequently, distributed capacitance should always be taken into account, particularly in calculations for the higher radio frequencies, at which it is usually either the principal component or the entire tank capacitance.

The plate-tank circuit of a class B or class C rf amplifier must resonate at the desired output frequency, and must also convert relatively short, unidirectional pulses of plate current into complete oscillations at this frequency. In other words, it must act as an electrical "flywheel." The plate tank must also have sufficient impedance at resonance to limit the no-load plate current of the stage to a safe value.

The effectiveness of a tank circuit's flywheel action is indicated by the ratio of the "wattless" power (in volt-amperes) developed in the tank to the actual power (in watts) delivered by the tube. This ratio is known as the "operating  $Q$ " of the tank, and is proportional to the tank capacitance. Its approximate value in terms of tube operating conditions is given by

$$Q = \frac{C \times f \times E_b}{300 \times I_b} \quad (2)$$

where  $C$  is the total capacitance across the tank in micromicrofarads,  $f$  is the frequency in megacycles per second,  $E_b$  is the dc plate potential in volts, and  $I_b$  is the total dc plate current of the stage in milliamperes.

The impedance of a parallel-tuned circuit at resonance (its equivalent resistance,  $R_{eq}$ ) is proportional to the tank inductance and inversely proportional to the tank capacitance and the tank-coil resistance. The approximate value  $R_{eq}$  in ohms is given by

$$R_{eq} = \frac{L}{Cr} \quad (3)$$

where  $L$  is the tank inductance in microhenries,  $C$  is the tank capacitance in

microfarads, and  $r$  is the ac resistance of the tank-circuit inductor in ohms.

Because there is a conflict between the characteristics required for high operating  $Q$  and those required for high equivalent resistance, determination of proper values for plate-tank circuits is one of the most important considerations in rf amplifier design.

The first step in the design of a plate-tank circuit is the determination of the most suitable operating  $Q$  for the type of service in which the stage is to be used. The use of too low a  $Q$  results in a distorted waveform containing very strong harmonics and, therefore, is wasteful of power and likely to result in serious interference. The use of too high a  $Q$ , on the other hand, usually results in large circulating currents and, therefore, in substantial tank-circuit losses. A value between 10 and 15 is generally recommended for rf telegraphy or telephony service. A value of 12 is most frequently used in the design of amateur and industrial equipment.

The next step is the determination of the tank capacitance,  $C$ , for the  $Q$  value and tube operating conditions selected. This value is obtained from equation (2) transposed to the form

$$C = \frac{300 \times Q \times I_b}{f \times E_b} \quad (4)$$

Fig. 35 shows  $C$  as a function of the ratio  $E_b/I_b$  for a  $Q$  value of 12. The curves in Fig. 35 can be used to determine values of tank-circuit capacitance suitable for use in equipment operating in the amateur bands. Values of  $C$  obtained from this chart or calculated by the use of Equation (4) apply only for single-ended tank circuits which are not split for neutralization or other purposes, such as that shown in Fig. 36 (a). These values represent the total capacitance required for resonance at the corresponding frequencies, and include tube and stray circuit capacitance. Values slightly higher than those indicated can generally be used without appreciable reduction of power output.

When a split tank circuit is employed for a single-ended stage, as shown in Fig. 36 (b), the total tank capacitance should be one-fourth that indicated by Fig. 35 or Equation (4). The corresponding tank inductance, therefore, is 4 times



that required for a tank circuit which is not split. If the tank tuning capacitor is a split-stator type, such as that shown in Fig. 36 (c), each section should have one-half the capacitance indicated by Fig. 35 or Equation (4).

A push-pull stage operating at the same dc plate voltage and total dc plate current as a single-ended stage also requires one-fourth the tank-circuit capacitance indicated in Fig. 35 or Equation (4), or if the tuning capacitor is a split-stator type, each section should have one-half the capacitance indicated. A push-pull stage operated at the same plate voltage but drawing twice as much plate current as a single-ended stage requires one-half the tank-circuit capacitance indicated. In this case, each section of a split-stator tank capacitor should have the capacitance indicated in Fig. 35 and in Equation (4).

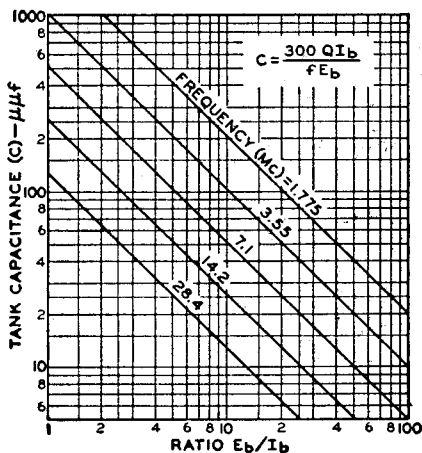
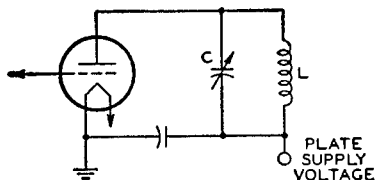

Fig. 35

When the required tank-circuit capacitance is known, the tank inductance required for resonance at the desired frequency can be determined by substitution of the value of C in Equation (1). Approximate winding data for single-layer coils, such as that shown in Fig. 37, suitable for use in amateur transmitters can then be obtained from the following formula:

$$L = \frac{R^2 \times N^2}{9R + 10B}$$

where L is the inductance of the coil in microhenries, R is the mean radius in



(a)

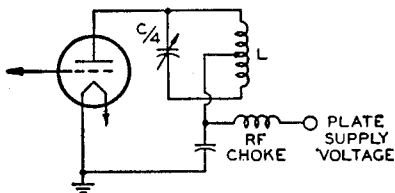

(b)

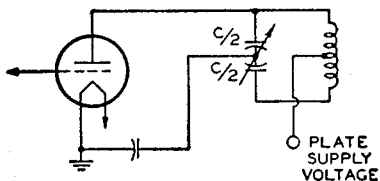

(c)

Fig. 36

inches, N is the number of turns, and B is the length in inches.

It is sometimes impracticable to limit the operating Q of a plate-tank circuit to the desired value under the proposed operating conditions. For example, in parallel-tube stages or stages operating at the higher radio frequencies, tube and stray circuit capacitance may be larger than the optimum total capacitance indicated in Equation (4). In such cases, the designer has a choice of the following procedures:

- (1) Retain the proposed tube-operating conditions and design the plate-

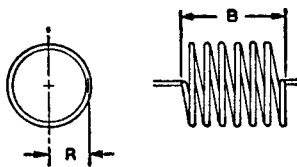

Fig. 37

tank circuit for the lowest  $Q$  value obtainable under these conditions;

(2) Modify the tube-operating conditions (provided the tube ratings are not exceeded) to obtain the proper  $E_b/I_b$  ratio for the desired operating  $Q$ ;

(3) Design the stage for push-pull operation, thereby reducing tube output capacitance to one-half that of a single tube, or to one-fourth that of parallel tubes;

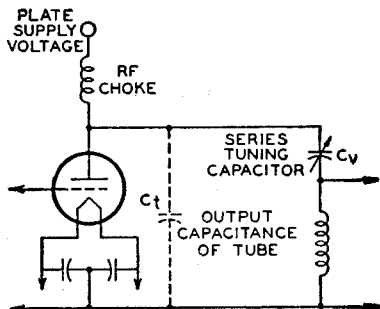

Fig. 38

(4) Employ a "series-tuned" tank circuit of the type shown in Fig. 38, in which the variable capacitance  $C_v$  is several times larger than the tube capacitance  $C_t$ .

### Interstage Coupling

One of the most important considerations in rf circuit design is the method used for coupling the input of an amplifier or frequency multiplier to the output of the preceding stage. An interstage rf coupling circuit must permit efficient transfer of energy at the desired frequency; discriminate, if possible, against harmonics of the desired frequency; and, where necessary, provide dc isolation between the driver and the driven stage. It should also permit adjustment of the loading for the driver and the excitation supplied to the following stage. Three principal types of interstage coupling are employed in rf equipment: capacitive coupling, direct inductive coupling, and indirect inductive ("link") coupling.

In **capacitive coupling**, a capacitor having very low reactance at the

desired frequency is connected between the plate-tank circuit of the driver stage and the grid of the following tube. This capacitor should be designed for use at radio frequencies, and should have a voltage-breakdown rating adequate to withstand the maximum potential difference developed between the driver plate circuit and the grid of the following tube. The input side of the coupling capacitor may be connected directly to the driver plate, as shown in Fig. 39 (a), or to a tap on the plate-tank coil, as shown in Fig. 39 (b).

A tapped plate-tank coil provides a convenient means for controlling loading and excitation, and generally makes it unnecessary to tune the grid circuit of the driven stage. Unused portions of tapped tank coils, however, frequently resonate with stray capacitances to form unloaded "parasitic" tank circuits which are readily shocked into oscillation and may interfere with the operation of the equipment. Consequently, it is usually preferable to use an untapped plate-tank

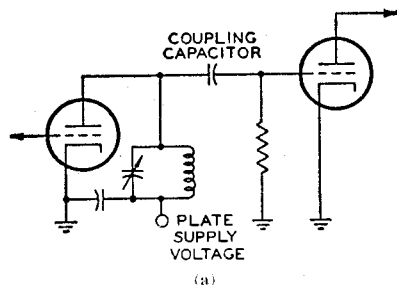

(a)

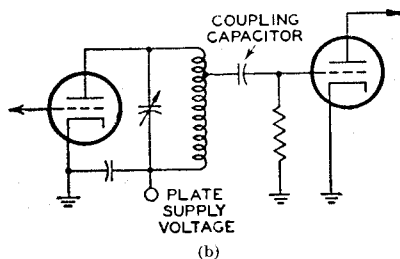

(b)

coil in the driver stage and a non-resonant grid circuit for the following stage, and to control the excitation by variation of the coupling capacitance. Because

of the relatively high impedances on both sides of the coupling capacitor, the driver and the driven stage should be in close proximity. Capacitive coupling tends to increase the transfer of harmonics because the reactance of the coupling capacitor decreases as the frequency increases.

**Direct inductive coupling**, shown in Fig. 40, is very efficient, but also involves high coupling impedances and, therefore, requires that the driver and driven stage be in close proximity. The

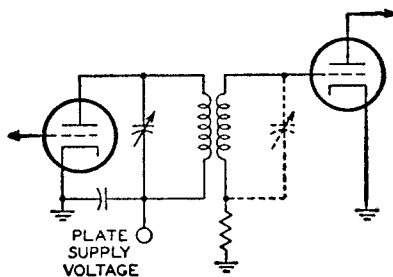

Fig. 40

coupling between the plate and grid windings may be fixed or adjustable. Adjustable coupling provides a convenient means for controlling loading and excitation. The grid winding may be either tuned or untuned. Although the tuned type provides maximum efficiency, the additional control complicates tuning and is rather critical of adjustment.

**Indirect inductive coupling** or "link" coupling is used extensively in rf power equipment. Although it does not provide the high efficiency obtainable with direct inductive coupling, it allows considerable flexibility in equipment design because it does not require close physical proximity between the coupled stages. "Link" coupling is especially useful for equipment which is frequently modified or which must be designed to permit concentration of principal control functions in a particular stage or unit of the equipment.

In this method of coupling, shown in Fig. 41, substantially identical "link" windings of a few turns each are inductively coupled to the plate-tank coil of the driver and to the grid-tank coil of the following stage. Because of their low impedance, these link windings may be

connected together through suitable transmission lines of considerable length with little danger of excessive radiation or interference pickup. Because the links are inductively coupled to the plate and grid circuits, the transmission lines are not required to carry dc and, therefore, may be grounded. These interstage transmission lines may be any of the various types commercially available, such as twisted pair, ribbon line, open-wire line, or coaxial cable, depending on the requirements of the circuit.

The coupling between link windings and their respective tank coils may be either fixed or adjustable. Fixed links should be coupled as tightly as possible to their tank coils in order to assure maximum energy transfer. When variable coupling is desired, it is usually sufficient to have only one of the links adjustable. Link windings should always be coupled to their tank coils at points of minimum rf potential. In single-ended tank circuits (not split), the correct location for a link winding is at the end of the plate-tank coil connected to the plate-voltage supply or at the ground (or bias-supply) end of the grid-tank coil. In split single-ended circuits or push-pull circuits, link windings should

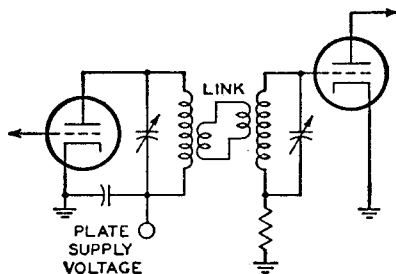

Fig. 41

be coupled to the centers of their respective tank coils.

Both direct inductive coupling and link coupling inherently provide better discrimination against harmonics than capacitive coupling.

### Output Coupling

Output coupling circuits must deliver as much as possible of the power supplied to them because there is no subsequent amplification to make up for

any losses. Because these circuits are usually required to work into low-impedance antennas, transmission lines, or other load devices, they must also deliver heavy output currents. Consequently, they must be designed to have the highest possible efficiency. In addition, any harmonics present in the output of the final stage must be eliminated in the output coupling circuit so that they will not enter the antenna or output transmission line.

Safety considerations usually require that the load side of an output coupling circuit be completely insulated from the ac and dc power-supply circuits of the equipment, and particularly from the plate-supply voltage of the output stage. In some cases the antenna, transmission line, or load device must also be insulated from ground.

**Capacitive output coupling** has the advantage of simplicity. It also permits matching to loads of substantially different impedance by the selection of a suitable feed point on the plate-tank coil of the output stage. However, it does not discriminate against harmonics which may be present in the output of the final stage, and may create serious safety hazards if leakage or voltage breakdown occurs in the coupling capacitor.

Probably the simplest and most convenient type of output coupling is **inductive coupling**. This type permits accurate impedance matching to high- or low-impedance antennas, transmission lines, or other loads, and inherently tends to discriminate against harmonics. Because it does not involve the use of series capacitors, it also minimizes the possibility of breakdowns which might place the plate voltage of the output stage across the rf output terminals and load.

When the load winding of an inductively coupled output circuit is untuned, the turns ratio between the input and output windings must be such that the proper load impedance is reflected in the plate circuit of the final amplifier. This turns ratio (primary to secondary) is equal to  $Z_p/Z_s$ , where  $Z_p$  is the plate-load impedance desired for the final amplifier, and  $Z_s$  is the impedance of the antenna, transmission line, or other load

device. The plate-load impedance,  $Z_p$ , in ohms can be determined approximately from the following relations:

For unmodulated or plate-modulated class C amplifiers,  $Z_p = E_b/2I_b$ ; for class B amplifiers and grid- or suppressor-grid-modulated class C amplifiers,  $Z_p = E_b/(4 I_b)$ ; where  $E_b$  is the dc plate potential in volts and  $I_b$  is the dc plate current in amperes. These values of  $Z_p$  are for unbalanced, single-ended output circuits. For split-tank or push-pull circuits, the values of  $Z_p$  determined from these relations should be multiplied by four.

### Stabilization

Any amplifier will oscillate if sufficient energy having the same frequency and the same phase as the grid voltage is fed back from the plate circuit to the grid circuit. Feedback of the proper phase for oscillation (regenerative feedback) may take place through the grid-plate capacitance of the tube, or through external capacitive or inductive coupling between plate and grid circuits. The amount of feedback necessary to cause self-oscillation is inversely proportional to the power sensitivity of the amplifier and, therefore, is much smaller for beam power tubes and other multigrid types than for triodes. In most multigrid types, however, the internal shielding provided by the screen grid (grid No.2) is so effective that any tendency to self-oscillation is usually the result of external, rather than internal, feedback. To assure stability in a multigrid rf amplifier stage, therefore, it is essential that the input and output circuits be completely shielded from each other. In some cases, it may also be necessary to shield these circuits from the tube.

In a triode, the relatively large grid-plate capacitance provides a low-impedance path for regenerative feedback which cannot be eliminated by the use of external shielding. The effect of this capacitance can be nullified, however, by taking voltage from the plate circuit and feeding it back to the grid in the proper phase and amplitude to cancel the regenerative feedback. This technique, known as "neutralization," can also be employed with multigrid

tubes to improve their stability at the higher radio frequencies.

The method of neutralization most frequently used, **plate neutralization**, is shown in Fig. 42. This method employs a balanced plate-tank circuit having its mid-point effectively at rf ground potential, so that rf voltages of substantially equal amplitude and opposite phase are developed across the two halves of the tank. The neutralizing voltage is taken from the bottom end of the tank and applied to the grid through the neutralizing capacitor,  $C_n$ . Although the theoretical value of  $C_n$  is exactly equal to the grid-plate capacitance of the tube, the value actually required may vary because of stray capacitances.

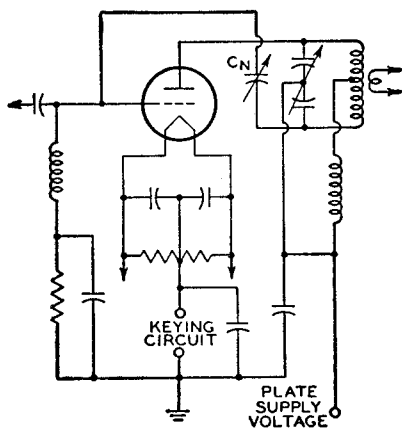

Fig. 42

Consequently,  $C_n$  is usually made adjustable over a small range on either side of the theoretical value.

Another method of neutralization for single-ended stages, **grid neutralization**, is similar to plate neutralization except that the split tank circuit which provides the neutralizing voltage is located in the grid circuit.

### Parasitic Oscillations

Parasitic oscillations are oscillations which occur in a circuit at frequencies other than the desired signal frequency, its harmonics, or its subharmonics. They may be continuous, or occur only during keying, modulation, or surges in the power-supply circuits of the equipment.

Because they absorb power from the circuits in which they occur, parasitics reduce efficiency and performance at the desired operating frequency. They may also be responsible for voltage flashover, instability, or premature failure of tubes and other circuit components, and may create serious interference by causing radiation of spurious carrier and side-band frequencies.

Parasitics are generated when resonance at some frequency other than the normal operating frequency occurs simultaneously in the input and output circuits of a tube. Under these conditions the stage functions as a "tuned-grid-tuned-plate" oscillator, the grid-plate capacitance of the tube providing the feedback path. These simultaneous resonance conditions may be created by the use of similar circuit constants in the plate and grid circuits (e.g., the use of identical rf chokes in both circuits) or by the "secondary" characteristics (small amounts of capacitance and inductance) of the tubes, circuit components, or circuit conductors.

Parasitics in multistage equipment must be eliminated on a stage-by-stage basis. Identification of the particular components forming a parasitic circuit often requires considerable study and "cut-and-try" experimentation. The first step is to distinguish true parasitics from self-oscillation in the stage in question, and to determine the frequency or frequencies of the parasitics. For this step, excitation is removed from the offending stage, and also from the preceding stage to minimize the possibility of feed-through at the normal operating frequency or a subharmonic. The stage is then operated at about one-half normal plate and screen-grid (grid-No.2) voltage and checked for oscillations.

When the presence of parasitics has been verified, and their frequency or frequencies determined, vhf parasitics should be eliminated first. VHF parasitics can usually be traced to one or more of the following sources:

- (1) Long connecting leads between grid and plate terminals of tubes and the corresponding tank circuits.
- (2) Push-pull tank circuits employing split-stator tank capacitors in which

the common terminals of the tank capacitors are not at rf ground potential.

(3) Inadequate bypassing, or the use of long connecting leads to bypass capacitors, particularly in the screen-grid-to-cathode circuits of multigrid tubes.

(4) Long leads in neutralizing circuits.

(5) Tapped tank-circuit coils. (Unused portions of tapped tank coils are particularly troublesome in this respect because they are not loaded and, therefore, can form resonant circuits of very high  $Q$ .)

(6) Inadequate separation between components in the input and output circuits of the stage.

Two methods can be used to minimize parasitics in resonant circuits. In one method, the constants of one of the circuits involved are changed to shift its resonant frequency. The lengths of the leads to the circuit may be reduced (preferably to a minimum), or the position of a connecting lead or component may be shifted to reduce its capacitance. When such a change is made, however, the new resonant frequency of the circuit may be the same as that of another combination of circuit elements, with the result that a new parasitic oscillation is created.

The second method is the insertion in one of the tube circuits (grid, plate, or cathode circuit) of a special load which will rapidly dissipate parasitic oscillations but will not appreciably affect the performance of the stage at the desired frequency. In a low-current circuit, this load may be a non-inductive resistor having a value between 10 and 100 ohms inserted directly at the tube socket. In a high-current circuit, a small rf choke (5 to 10 turns of wire) should be connected in parallel with the resistor.

Fig. 43 shows a beam power tube in an rf amplifier which has been stabilized to eliminate parasitics.  $L_g$ ,  $L_k$ , and  $L_p$  represent the distributed inductance of the grid, cathode, and plate leads, respectively.  $C_{gp}$  and  $C_{gk}$  are the grid-plate and plate-cathode capacitances of the tube.  $L_1$ ,  $C_1$ ,  $L_2$ , and  $C_2$  are the normal grid and plate tank-circuit components. The following stabilization meas-

ures are shown in the circuit:

(1) The screen grid (grid No.2) is bypassed to the cathode directly at the tube socket with a mica or ceramic capacitor of not less than 0.002 microfarad having extremely short leads.

(2) Because the tube has an indirectly heated cathode, an unbypassed

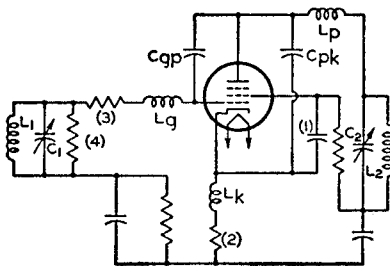

Fig. 43

non-inductive resistor having a value of 25 ohms or less is installed in the cathode-return lead directly at the tube socket.

(3) A non-inductive resistor having a value of 50 ohms or less is installed in series with the grid-tank circuit directly at the grid terminal of the tube socket.

(4) The grid-tank circuit is loaded with a non-inductive resistor having a value between 5000 and 50000 ohms.

Besides the measures shown in the circuit, the screen-grid voltage is reduced proportionally when the tube is operated at less than the maximum rated value of plate current. In addition, ample driving power is provided. If necessary, the grid current and bias are increased to provide ample driving power, but the maximum ratings for grid current and grid voltage should not be exceeded. A "saturated" tube (*i.e.*, one supplied with ample driving power) is relatively immune to parasitics.

When all vhf parasitics have been eliminated, attention should be directed to the elimination of low-frequency parasitics. Low-frequency parasitics are frequently caused by:

(1) The use of rf chokes in series with both the plate and grid circuits of the amplifier, particularly when identical chokes are used in both circuits.

(2) Resonance conditions in power-supply filter circuits.

(3) Resonance conditions in modulation-circuit components.

(4) The use of high-impedance RC circuits in screen-grid-supply circuits for multigrid tubes.

(5) The use of parallel feed in both the grid and plate circuits of a tube.

In addition to the stabilization of individual stages in power-tube equipment, it is also necessary to prevent undesired coupling and feedback between stages operating at the same frequency. Over-all stabilization of multistage equipment may require shielding of individual tubes or entire stages, the use of filtering and decoupling networks in power-supply leads and in grid-, plate-, or other

circuit-return leads, or combinations of such measures.

### **Power-Supply Considerations**

Because class B and class C rf amplifiers may be operated without plate, screen-grid, or bias voltages (or at voltages substantially below normal values) during certain tuning adjustments, they should incorporate means for reducing or completely removing these voltages independently in each stage. It is also desirable that plate, screen-grid, and fixed-bias voltages for individual rf amplifier stages be adjustable up to the maximum values for the tubes employed so that maximum operating efficiency is attainable at a particular power output or frequency.

# Power Tube Operating Conditions and Adjustments

## Calculation of Operating Conditions

The only restrictions on tube operating values are those imposed by the published maximum ratings. When it is necessary or desirable to operate tubes under conditions other than those shown under "Typical Operation" in published data, suitable values may be approximated by simple calculations. These approximate values may then be used in a tentative operating setup, and adjustments made, if necessary, to assure that desired output and efficiency are obtained without any of the maximum ratings for the tube being exceeded.

Simple calculations can be used to determine operating conditions for any type of service in which plate current flows for less than the entire signal cycle. They can be used for triode and multi-grid-tube class C amplifiers (both modulated and unmodulated), for push-pull class AB and class B audio amplifiers and for class AB and class B linear rf amplifiers.

The basic factors used in these calculations are the peak plate current of the tube, and the corresponding instantaneous plate voltage, grid voltages, and grid currents. The peak plate current is determined by the average or dc plate current and by the plate-conduction angle (*i.e.*, the fraction of the signal cycle during which plate current flows). For a given dc plate current, peak plate current varies inversely with conduction angle and is equal to the dc value times a conversion factor  $K_1$ , given in Table I. The corresponding instantaneous values of the other tube currents and voltages are obtained from the "Average Characteristics" curves for the tube.

Table I

Conduction Angle (degrees)	$K_1$	$K_2$	$K_3$	$K_4$	$K_5$
210	2.75	0.723	0.205	0.795	0.284
200	2.87	0.745	0.148	0.852	0.273
190	3.00	0.765	0.081	0.919	0.262
180	3.14	0.785	0.000	1.000	0.250
170	3.32	0.805	0.095	1.095	0.237
160	3.50	0.825	0.210	1.210	0.224
150	3.75	0.844	0.350	1.350	0.213
140	4.00	0.862	0.520	1.520	0.200
130	4.25	0.880	0.732	1.732	0.187
120	4.60	0.897	1.000	2.000	0.174
110	5.00	0.913	1.345	2.345	0.160
100	5.50	0.927	1.800	2.800	0.145
90	6.10	0.940	2.410	3.410	0.130

Table I also gives four other conversion factors or constants ( $K_2$ ,  $K_3$ ,  $K_4$ , and  $K_5$ ) used in these calculations. A sixth factor,  $K_6$ , which is a function of grid bias and driving voltage, is given in Table II. The values given for constants  $K_1$ ,  $K_2$ ,  $K_3$ ,  $K_4$ ,  $K_5$  are based on the use of sinusoidal signal waveforms and conduction angles between 90 and 180 degrees. Angles between 100 and 160 degrees are generally used in "straight-through" class C amplifiers. Angles of 90 degrees are usually employed only in frequency multipliers, and angles of 180 degrees in class AB and class B amplifiers.

Experience has shown that the most satisfactory relation between power output and power gain in "straight-through" class C amplifier service is achieved at a conduction angle of about 140 degrees. The use of larger conduction angles reduces driving-power requirements, but

Table II

$E_{c1}/E_{g1}$	$K_6$	$E_{c1}/E_{g1}$	$K_6$
0.25	4.67	0.65	6.95
0.30	4.84	0.70	7.52
0.35	5.04	0.75	8.25
0.40	5.26	0.80	9.25
0.45	5.50	0.85	10.70
0.50	5.78	0.90	13.12
0.55	6.10	0.95	18.63
0.60	6.49		



results in substantially reduced plate-circuit efficiency. The use of smaller conduction angles, on the other hand, tends to increase plate-circuit efficiency, but makes it necessary to provide substantially higher driving power.

### Use of Curves

Average characteristics of power tubes are usually given in the form of sets or "families" of curves, such as those shown in the *Tube Types* Section. The separate "plate," "grid-No.1," and "grid-No.2" families given for the RCA-6146 beam power tube are typical of curves furnished for multigrid types. Combined "plate" and "grid" families such as those given for the RCA-812-A are usually furnished for triodes.

Plate families show the simultaneous relationships between plate voltage, control-grid voltage, and plate current. Consequently, they may be used for determining effective minimum plate voltages and peak positive control-grid voltages corresponding to desired or calculated values of peak plate current. They also may be used for determination of the grid-bias voltages required to obtain desired values of quiescent (zero-signal) plate current in class A, class AB, and class B amplifiers. In addition, they permit such factors as plate-load resistance, power output, plate dissipation, and harmonic distortion to be determined graphically.

Grid families are used in determining the peak currents in the corresponding grid circuits. Like peak plate current, these peak grid currents flow at the instant control-grid voltage is at positive peak value, and plate voltage is minimum.

A single set of curve families for a multigrid tube shows the characteristics of the tube at a particular grid-No.2 (or screen-grid) voltage. If a different grid-No.2 voltage is to be used, appropriate "Average Characteristics" curves must be obtained, or values shown in the available curves must be converted mathematically. A simple method of conversion is given later.

### Class C Telegraphy Service Multigrid Tubes

(1) Choose a plate voltage ( $E_b$ ), a dc grid-No.2 (screen-grid) voltage ( $E_{c2}$ ),

and a dc plate current ( $I_b$ ) which provide a plate input ( $P_i$ ) within the maximum rating for the tube. Also select a conduction angle smaller than 180 degrees (preferably 140 degrees).

(2) Using the value of  $K_1$  given in Table I for the conduction angle selected, calculate the peak plate current ( $i_{bmax}$ ) as follows:

$$i_{bmax} = K_1 \times I_b$$

(3) Determine the effective minimum plate voltage ( $e_{bmin}$ ) and peak positive grid-No.1 voltage ( $ec_{1max}$ ) from the plate-family curves for the chosen value of  $E_{c2}$  and the calculated value of  $i_{bmax}$ . For maximum plate-circuit efficiency and maximum power gain, both  $e_{bmin}$  and  $ec_{1max}$  should be as small as possible. Because of other considerations, however,  $e_{bmin}$  should be slightly above and to the right of the "knee" in the appropriate grid-No.1 voltage curve. The use of  $e_{bmin}$  and  $ec_{1max}$  values below the knee causes excessive grid-No.1 and grid-No.2 current; the use of values too far to the right of the knee reduces power output and may result in excessive plate dissipation.

(4) Using the value of  $K_2$  given in Table I for the conduction angle selected, calculate power output ( $P_o$ ) as follows:

$$P_o = K_2 \times (E_b - e_{bmin}) \times I_b$$

(5) Plate dissipation or plate loss ( $P_p$ ) is then given by

$$P_p = (E_b \times I_b) - P_o$$

If this value exceeds the maximum plate-dissipation rating for the tube, it will be necessary to recalculate steps (1) through (5) using a smaller conduction angle.

(6) Using the values of  $K_3$  and  $K_4$  given in Table I, calculate the dc grid-No.1 voltage or bias ( $E_{c1}$ ) as follows:

$$E_{c1} = -(K_3 \times ec_{1max}) - \frac{K_4 \times E_{c2}}{\mu_{B2G1}}$$

where  $\mu_{B2G1}$  is the mu-factor (grid No.2 to grid No.1) of the tube.

(7) The peak rf grid-No.1 voltage ( $E_{g1}$ ) required to drive the tube to full output is given by

$$E_{g1} = -E_{c1} + ec_{1max}$$

(8) Determine peak grid-No.1 current ( $i_{c1max}$ ) from the grid-current characteristics curves for the appropriate

value of  $E_{c2}$ . (Like peak plate current, peak grid-No.1 current flows at the instant that plate voltage is equal to  $e_{b\min}$  and grid-No. 1 voltage is equal to  $e_{c1\max}$ ). Then, using the value of  $K_6$  given in Table II for the calculated values of  $E_{c1}$  and  $E_{g1}$ , determine the dc grid current ( $I_{c1}$ ) as follows:

$$I_{c1} = i_{c1\max}/K_6$$

(9) The approximate driving power ( $P_d$ ) required by the grid-cathode circuit of the tube is then given by

$$P_d = 0.9 \times E_{g1} \times I_{c1}$$

(It should be noted that this value of  $P_d$  does not represent the total power that must be delivered by the driver stage, which must be sufficient to supply the various tube and circuit losses described previously.)

(10) It is now necessary to calculate the dc grid-No.2 current ( $I_{c2}$ ) and grid-No.2 input ( $W_{c2}$ ). First determine the peak grid-No.2 current ( $i_{c2\max}$ ) from the screen-grid-current characteristics curves for the appropriate value of  $E_{c2}$ . (The value of  $i_{c2\max}$  is determined at the intersection of the plate-voltage coordinate corresponding to  $e_{b\min}$  with the grid-No.1 voltage coordinate corresponding to  $e_{c1\max}$ ). Then, using the value of  $K_5$  given in Table I for the conduction angle employed, calculate the dc grid-No.2 current ( $I_{c2}$ ) as follows:

$$I_{c2} = K_5 \times i_{c2\max}$$

Grid-No.2 input ( $W_{c2}$ ) is then given by

$$W_{c2} = E_{c2} \times I_{c2}$$

If this value of  $W_{c2}$  exceeds the maximum rating for grid-No.2 input given in the tube data, it will be necessary either to reduce  $E_{c2}$  or to employ a smaller conduction angle.

**Example:**

Calculate operating values for the RCA-6146 in Class C Telegraphy Service under CCS conditions. The basic operating values are selected to be:  $E_b=600$  volts;  $I_b=112$  milliamperes;  $E_{c2}=150$  volts; plate-conduction angle=140 degrees.

(1) Plate input ( $P_1$ ) = 600 volts  $\times$  0.112 ampere = 67.2 watts. This value is just within the maximum CCS rating of 67.5 watts.

(2) From Table I,  $K_1$  for a conduction angle of 140 degrees is 4. Therefore,

peak plate current ( $i_{b\max}$ ) = 0.112 ampere  $\times$  4 = 0.448 ampere, or 448 milliamperes.

(3) From the plate family for the 6146 given in Fig. 44 ( $E_{c2}=150$  volts), a suitable value for effective minimum plate voltage ( $e_{b\min}$ ) to the right of the "knee" is 70 volts. The corresponding peak positive grid-No.1 voltage ( $e_{c1\max}$ , determined from  $E_{c1}$  curves) for a peak plate current of 448 milliamperes is approximately +16 volts.

(4) From Table I,  $K_2$  for a conduction angle of 140 degrees is 0.862. Therefore, power output ( $P_o$ ) = 0.862  $\times$  (600-70)  $\times$  0.112 = 51 watts.

(5) Plate dissipation ( $P_p$ ) = (600  $\times$  0.112) - 51 = 16.2 watts. This value is well within the maximum plate-dissipation rating of the 6146 for class C telegraphy under CCS conditions (20 watts).

(6) The dc grid-No.1 or bias voltage ( $E_{c1}$ ) and peak rf grid-No.1 voltage ( $E_{g1}$ ) are calculated next. (Note that bias voltage  $E_{c1}$  is not the  $E_{c1}$  shown in the characteristics curves, which represents total grid voltage, i.e., the algebraic sum of the bias  $E_{c1}$  and peak rf grid-No.1 voltage  $e_{c1\max}$ ). From table I,  $K_3$  and  $K_4$  for a conduction angle of 140 degrees are, respectively, 0.520 and 1.520. From the technical data for the 6146, mu-factor ( $\mu_{g2g1}$ ) is 4.5. Therefore,

$$E_{c1} = -(0.520 \times 16) - \frac{1.520 \times 150}{4.5} = -8.3$$

-50.6 = -58.9, or approximately -59 volts.

(7) Peak rf grid-No.1 voltage ( $E_{g1}$ ) = -(-59) + 16 = 75 volts.

(8) The next step is to determine dc grid-No.1 current ( $I_{c1}$ ). From the grid-No.1 average characteristics curves shown in the tube data ( $E_{c2} = 150$  volts), for  $e_{b\min}$  of 70 volts and  $e_{c1\max}$  of +16 volts, peak grid-No.1 current ( $i_{c1\max}$ ) = 28 milliamperes.

From Table II,  $K_6$  for the ratio  $E_{c1}/E_{g1} = 59/75 = 0.787$  is between the values given for ratios of 0.75 and 0.80, and is approximately 9. Consequently,  $I_{c1} = 0.028/9 = 0.0031$  ampere, or approximately 3 milliamperes.

(9) The driving power required by the grid ( $P_d$ ) = 0.9  $\times$  75  $\times$  0.003 = 0.203, or approximately 0.2 watt.

(10) From the grid-No.2 characteristics curves shown in the tube data

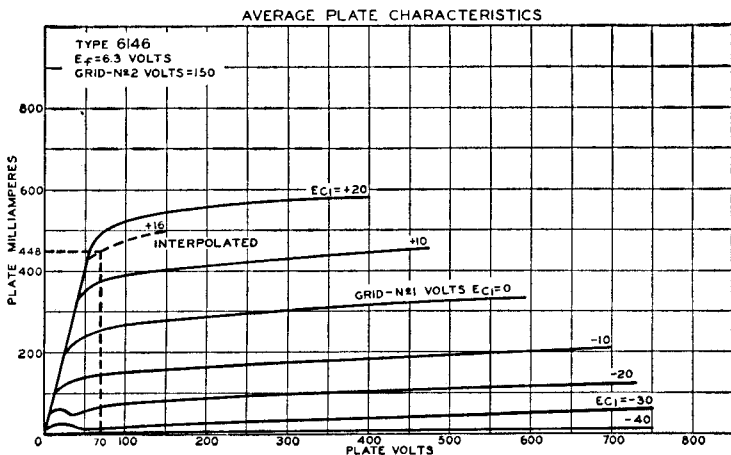

Fig. 44

( $E_{c2} = 150$  volts), for  $E_b = 70$  volts and  $E_{c1} = +16$  volts, peak grid-No.2 current ( $i_{c2max}$ ) = 59 milliamperes (approx.)

From Table I,  $K_5$  for a conduction angle of 140 degrees is 0.200. Consequently, dc grid-No.2 current ( $I_{c2}$ ) =  $0.200 \times 0.059 = 0.0118$  ampere, or 11.8 milliamperes. Grid-No.2 input ( $W_{c2}$ ) =  $150 \times 0.0118 = 1.77$  or approximately 1.8 watts. This value is well within the maximum rating for the 6146 (3 watts).

These calculated values are compared below with the "Typical Operation" values given in the published data for the 6146 in Class C Telephony Service, CCS conditions, as amplifier up to 60 Mc:

	Calculated	Published	
DC Plate Voltage ( $E_b$ ) . . .	600	600	volts
DC Grid-No.2 Voltage ( $E_{c2}$ ) . . . . .	150	150	volts
DC Grid-No.1 Voltage ( $E_{c1}$ ) . . . . .	-59	-58	volts
Peak RF Grid-No.1 Voltage ( $e_{g1max}$ ) . . . . .	75	73	volts
DC Plate Current ( $I_b$ ) . . . . .	112	112	ma
DC Grid-No.2 Current ( $I_{c2}$ )	11.8	9	ma
DC Grid-No.1 Current ( $I_{c1}$ ) . . . . .	3	2.8	ma
Driving Power (Approx., $P_d$ ) . . . . .	0.2	0.2	watt
Power Output (Approx., $P_o$ ) . . . . .	51	52	watts

### Class C Telephony Service Triodes

Calculations for triode class C amplifiers are similar to those described for multigrad tubes except that somewhat different considerations are involved in the determination of effective minimum plate voltage ( $e_{bmin}$ ) and peak positive grid voltage ( $e_{gmax}$ ), and that calculations for grid-No.2 current and input are not required.

(1) Choose a plate voltage ( $E_b$ ) and a dc plate current ( $I_b$ ) which provide a plate input ( $P_i$ ) within the maximum rating for the tube. Also select a suitable conduction angle (preferably 140 degrees).

(2) Using the value of  $K_1$  given in Table I for the conduction angle selected, calculate the peak plate current ( $i_{bmax}$ ) as follows:

$$i_{bmax} = I_b \times K_1$$

(3) Determine peak positive grid voltage ( $e_{gmax}$ ) and effective minimum plate voltage ( $e_{bmin}$ ) for this value of  $i_{bmax}$  from the plate-family curves for the tube.

The maximum permissible value of  $e_{gmax}$  and the minimum permissible value of  $e_{bmin}$  are determined at the point where the horizontal coordinate

representing the peak current intersects the " $E_c = E_b$ " line (sometimes called "Diode Line"). It is generally desirable that  $e_{bmin}$  be slightly more positive than  $e_{cmax}$ . If  $e_{bmin}$  is smaller than  $e_{cmax}$ , the grid will be driven more positive than the plate and will draw excessive current, and the peak plate current will be reduced. In addition, the harmonic output of the stage will be greatly increased.

(4) Using the value of  $K_2$  given in Table I, calculate the power output ( $P_o$ ) as follows:

$$P_o = K_2 \times (E_b - e_{bmin}) \times I_b$$

(5) Plate dissipation or plate loss ( $P_p$ ) is then given by

$$P_p = (E_b \times I_b) - P_o$$

If this value exceeds the maximum plate-dissipation rating of the tube, it will be necessary to recalculate steps (1) through (5) using a smaller conduction angle.

(6) Using the value of  $K_3$  given in Table I, calculate the grid bias ( $E_c$ ) required as follows:

$$E_c = -[K_3 \times (e_{cmax} + e_{bmin}/\mu) + E_b/\mu]$$

where  $\mu$  is the amplification factor shown in the published data for the tube.

(7) The peak rf grid voltage ( $E_g$ ) required to drive the grid from bias level to the peak positive value determined in step (3) is given by

$$E_g = -E_c + e_{cmax}$$

(8) Determine peak grid current ( $i_{cmax}$ ) from the grid-current characteristics curves. (The value of  $i_{cmax}$  is shown at the intersection of the plate-voltage coordinate corresponding to  $e_{bmin}$  with the grid-voltage curve corresponding to  $e_{cmax}$ ). Then, using the value of  $K_6$  given in Table II for the calculated values of  $E_c$  and  $E_g$ , determine the dc grid current ( $I_c$ ) as follows:

$$I_c = i_{cmax}/K_6$$

If this value of  $I_c$  is greater than the maximum grid-current rating for the tube, or is undesirably large, it will be necessary to recalculate using a higher value for  $e_{bmin}$ .

(9) The approximate driving power ( $P_d$ ) required by the tube is then given by

$$P_d = 0.9 \times E_g \times I_c$$

**Example:**

Calculate operating values for the

RCA-812-A for Class C Telegraphy Service under ICAS conditions. The plate voltage is selected to be 1500 volts; the plate input, the maximum rated value for the tube; and the plate-conduction angle, 140 degrees.

(1) From the published data for the 812-A, the maximum plate-input rating is 260 watts. The dc plate current ( $I_b$ ) required to provide this input at a plate voltage, ( $E_b$ ) of 1500 volts is  $I_b = 260/1500 = 0.173$  ampere, or 173 milliamperes.

(2) From Table I,  $K_1$  for a conduction angle of 140 degrees is 4. Therefore, peak plate current ( $i_{bmax}$ ) =  $0.173 \times 4.00 = 0.692$  ampere, or 692 milliamperes.

(3) The average characteristics curves given in Fig. 45 show that a peak plate current of 692 milliamperes is obtained at a peak positive grid voltage ( $e_{cmax}$ ) of 118 volts and an effective minimum plate voltage ( $e_{bmin}$ ) of 140 volts.

(4) From Table I,  $K_2$  for a conduction angle of 140 degrees is 0.862. Therefore, power output ( $P_o$ ) =  $0.862 \times (1500 - 140) \times 0.173 = 203$  watts (approx.).

(5) Plate dissipation ( $P_p$ ) =  $(1500 \times 0.173) - 203 = 57$  watts (approx.)

This value is well within the 65-watt maximum rating for the 812-A for class C telegraphy under ICAS conditions.

(6) From Table I,  $K_3$  is 0.520. From the published data, the amplification factor  $\mu$  is 29. Therefore, the dc grid voltage or bias ( $E_c$ ) =  $-[0.520 \times (118 + 140/29) + 1500/29] = -[0.520 \times (118 + 4.8) + 52] = -(64 + 52) = -116$  volts.

(7) Peak rf grid voltage ( $E_g$ ) =  $-(-116) + 118 = 234$  volts.

(8) From the average characteristics curves shown in Fig. 45, for  $e_{cmax}$  of +118 volts and  $e_{bmin}$  of 140 volts, peak grid current ( $i_{cmax}$ ) = 195 milliamperes (approx.).

From Table II,  $K_6$  for the ratio  $E_c/E_g = 116/234$ , or approximately 0.5, is 5.78. Consequently, the dc grid current ( $I_c$ ) =  $0.195/5.78 = 0.0337$  ampere, or 34 milliamperes (approx.).

(9) The driving power required at the grid ( $P_d$ ) =  $0.9 \times 234 \times 0.034 = 7.2$  watts.

These calculated values are com-

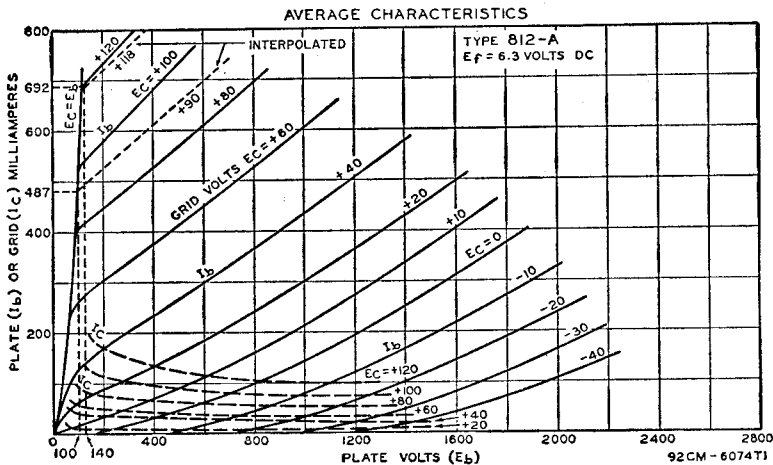

Fig. 45

pared below with the "Typical Operation" values given in the published data for the RCA-812-A in Class C Telegraphy Service, ICAS conditions:

	Calcu- lated	Pub- lished	
DC Plate Voltage (Eb) . . . . .	1500	1500	volts
DC Grid Voltage (Ec) . . . . .	-116	-120	volts
Peak RF Grid Voltage (Eg) . . . . .	234	240	volts
DC Plate Current (Ib) . . . . .	173	173	ma
DC Grid Current, (Approx., Ic) . . . . .	34	30	ma
Driving Power (Approx., Pd) . . . . .	7.2	6.5	watts
Power Output (Approx., Po) . . . . .	203	190	watts

### Plate-Modulated Class C Telephony Service

Operating values for plate-modulated class C amplifiers may also be calculated by the procedure described above. As mentioned previously, however, dc plate-voltage and dc plate-input values selected for plate-modulated amplifiers must be within the maximum ratings given in the tube data for this type of service.

In general, adequate protection against excessive dc plate input is obtained when the dc plate voltage and plate current do not exceed 80 per cent of the maximum class C telegraphy values. It is also usually desirable to employ a conduction angle smaller than that used in telegraphy service to assist in obtaining linear modulation, as discussed previously.

### Frequency Multipliers Multigrad Tubes

Operating values for multigrad tubes used as frequency multipliers are also calculated as described above under Class C Telegraphy Service, except that values for the constants  $K_1$ ,  $K_2$ ,  $K_3$ ,  $K_4$ , and  $K_5$  are obtained from Table III instead of Table I.

Table III

	$K_1$	$K_2$	$K_3$	$K_4$	$K_5$
Doubler	4.60	0.63	1.00	2.00	0.174
Tripler	6.90	0.63	3.27	4.27	0.116
Quadrupler	9.00	0.63	6.46	7.46	0.089

### Triodes

Operating values for triodes used as frequency multipliers are also calculated as described above, except that values for the K constants are obtained from Table III instead of Table I, and the following equation is used to determine the value of grid-bias voltage:

$$E_0 = - (K_3 \times E_{gmax}) + \frac{K_4}{2\mu} (3 E_b - e_{bmin})$$

### Class AB<sub>1</sub> SSB Service Multigrad Tubes

The operating conditions for a class AB<sub>1</sub> linear rf amplifier used in single-sideband service can be estimated from the load line plotted on a set of plate characteristics. The typical plate and grid-No.2 characteristic curves shown in Figs. 46 and 47 are used in the following

procedure. All published maximum ratings must be observed for each step.

- (1) Choose values of plate voltage ( $E_b$ ) and grid-No.2 voltage ( $E_{c2}$ ) within the published maximum ratings.
- (2) Determine peak plate current

higher-valued fraction places the static current level in the more linear portion of the dynamic transfer curve.

- (4) Determine the minimum plate voltage ( $E_{bmin}$ ) from point of  $I_{bmax}$  found in (2).

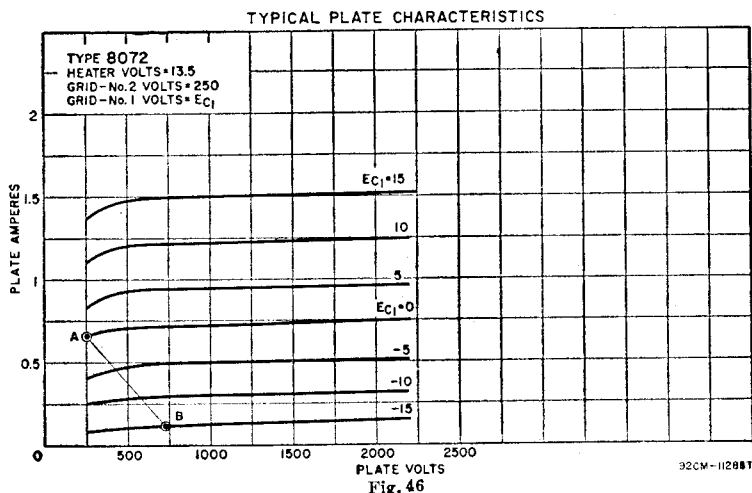

Fig. 46

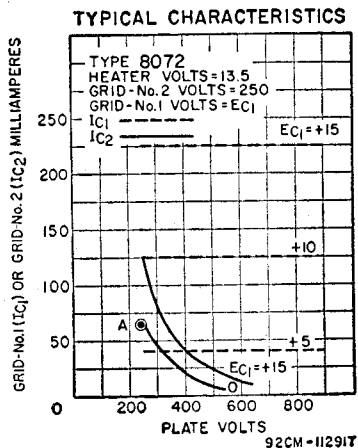

Fig. 47

- (3) Select a value of zero-signal plate current ( $I_{b0}$ ) between 1/6 and 1/10 of  $I_{bmax}$  found in (2). Locate  $I_{b0}$  at selected  $E_b$  and construct a load line to the point found in (2). In general, the

- (5) Determine the grid-No.1 bias ( $E_{c1}$ ) from graph at the point of zero signal found in (3).

- (6) DC plate current at peak of envelope ( $I_{be}$ ) is approximately equal to  $I_{bmax}/3$ .

- (7) Average dc plate current ( $I_b$ ) is equal to  $I_{be}/1.4$ .

- (8) Determine peak grid-No.2 current ( $I_{c2max}$ ) from Fig. 47 at conditions in (2).

- (9) DC grid-No.2 current at peak of envelope ( $I_{c2e}$ ) is approximately equal to  $I_{c2max}/4$ .

- (10) Average grid-No.2 current ( $I_{c2}$ ) is approximately equal to  $I_{c2e}/1.4$ .

- (11) Average grid-No.2 dissipation ( $P_{c2}$ ) is approximately equal to  $E_{c2} \times I_{c2}$ .

- (12) Peak Envelope Power input ( $P_{Ine}$ ) is equal to  $E_b \times I_{be}$ .

- (13) Peak Envelope Power output (PEP) is equal to  $(I_{bmax}/4) (E_b - E_{bmin})$ .

- (14) Average Plate Dissipation ( $P_p$ ) is equal to  $0.7 P_{Ine} - 0.5 PEP$ .

- (15) Average Power Output ( $P_o$ ) is equal to  $PEP/2$ .

- (16) Effective rf load resistance ( $R_p$ ) is equal to  $2(E_b - E_{bmin})/I_{b0}$ .

**Example:**

Calculate operating values for the

RCA-8072 linear rf power amplifier for single-sideband service with two-tone modulation.

(1) The plate voltage is selected to be 700 volts; grid-No.2 voltage, 250 volts.

(2) On Fig. 46 plot the maximum-signal point at knee of  $E_{c1} = 0$  curve (point A). Read  $I_{b_{max}} = 0.65$  ampere. Locate  $E_{b_{min}}$  at 250 volts.

(3)  $I_{b_0} = (1/6.5) \times 0.65 = 0.10$  ampere.

(4) On Fig. 46 plot the minimum-signal point at  $E_b = 700$  volts and  $I_{b_0} = 0.10$  ampere (point B).

(5) On Fig. 46 read  $E_{c1}$  at -15 volts at minimum-signal point B.

(6) Calculate:  $I_{b_e} = I_{b_{max}}/3 = 0.650/3 = 0.22$  ampere.

(7) Calculate:  $I_b = I_{b_e}/1.4 = 0.22/1.4 = 0.16$  ampere.

(8) On Fig. 47 locate point A at  $E_b = 250$  volts and  $E_{c1} > 0$  on grid-No.2 current curves. Read  $I_{c_{2max}} = 0.065$  ampere.

(9) Calculate:  $I_{c_{2e}} = I_{c_{2max}}/4 = 0.065/4 = 0.016$  ampere.

(10) Calculate:  $I_{c_2} = I_{c_{2e}}/1.4 = 0.016/1.4 = 0.011$  ampere.

(11) Calculate:  $P_{c_2} = E_{c_2} \times I_{c_2} = 250 \times 0.011 = 2.7$  watts. Verify that grid-No.2 dissipation is within rating.

(12) Calculate:  $P_{I_{b_e}} = E_b I_{b_e} = 700 \times 0.22 = 154$  watts.

(13) Calculate:  $PEP = (I_{b_{max}}/4)(E_b - E_{b_{min}}) = (0.650/4)(700 - 250) = 73$  watts.

(14) Calculate:  $P_D = 0.7 P_{I_{b_e}} - 0.5 PEP = 0.7(154) - 0.5(73) = 71$  watts.

(15) Calculate:  $P_0 = PEP/2 = 73/2 = 36.5$  watts.

(16) Calculate:  $R_p = 2(E_b - E_{b_{min}})/I_{b_{max}} = 2(700-250)/0.65 = 1384$  ohms.

### Triodes

Operating conditions for high-mu triodes at zero-bias grid-drive conditions with two-tone modulation may be calculated as follows.

(1) Select a plate voltage ( $E_b$ ) within the maximum rating of the tube.

(2) Determine dc plate current at peak of envelope ( $I_{b_e}$ ) which gives a plate input approximately 90 per cent of the plate input at the peak of envelope rating:

$$I_{b_e} = 0.9 P_{I_{b_{max}}}/E_b$$

Verify value to be within maximum ratings.

(3) Determine peak plate current ( $I_{b_{max}}$ ) as 3  $I_{b_e}$  found in (2).

(4) Determine average plate current ( $I_b$ ) as  $I_{b_e}/1.4$ .

(5) Determine peak positive grid voltage ( $E_{c_{max}}$ ) and effective minimum plate voltage ( $E_{b_{min}}$ ) for this value of  $I_{b_{max}}$  from the typical plate characteristics for the tube.

The maximum permissible value of  $E_{c_{max}}$  and the minimum permissible value of  $E_{b_{min}}$  are determined at the point where the horizontal coordinate representing the peak current intersects the  $E_c = E_b$  line (sometimes called "Diode Line"). It is generally desirable for  $E_{c_{max}}$  to be 75 per cent of  $E_{b_{min}}$ .

(6) Zero-signal dc plate current ( $I_{b_0}$ ) is equal to  $I_{b_e}/5$ .

(7) Peak of envelope power input ( $P_{I_{b_e}}$ ) is equal to  $E_b$  in (1) times  $I_{b_e}$  in (2).

(8) Calculate peak envelope power output (PEP) as follows:

$$PEP = (I_{b_{max}}/4)(E_b - E_{b_{min}})$$

(9) Average plate dissipation ( $P_D$ ) is equal to  $0.7 P_{I_{b_e}} - 0.5 PEP$ . Verify value to be within maximum ratings. If exceeded, reduce  $I_{b_{max}}$  slightly; if still exceeded, reduce  $E_b$ .

(10) Peak rf grid voltage ( $E_g$ ) is equal to  $E_{c_{max}}$  for zero-bias conditions.

(11) Determine peak grid current ( $I_{c_{max}}$ ) from the grid-current characteristics curves. The value of  $I_{c_{max}}$  is shown at the intersection of the plate-voltage coordinate corresponding to  $E_{b_{min}}$  with the grid voltage curve corresponding to  $E_{c_{max}}$ .

(12) Peak-envelope grid current ( $I_{c_e}$ ) is equal to one-third  $I_{c_{max}}$  in (11).

(13) Average dc grid current ( $I_c$ ) to  $1/1.4 I_{c_e}$  in (12).

(14) Calculate driving power of tube ( $P_d$ ) as follows:  $P_d = E_g(I_{c_{max}}/4)$ .

(15) Calculate effective rf load resistance ( $R_p$ ) as follows:  $R_p = 2(E_b - E_{b_{min}})/I_{b_{max}}$ .

For cathode-drive conditions, it is necessary to calculate the feedthrough driving power ( $P_{ft}$ ) as follows:

$$P_{ft} = E_g(I_{b_{max}}/4)$$

The feedthrough power must then be added to both the driving power ( $P_d$ ) in (12) and the peak-envelope power (PEP) in (10). The effective rf load re-

sistance ( $R_p$ ) in (13) must be modified as follows:  $R_p = 2(E_b - E_{bmin} + E_g)/I_{bmax}$ .

**Example:**

Calculate operating values for the RCA-811A for linear rf power amplifier service under ICAS conditions. Refer to Fig. 48 for curve values.

(15) Calculate:  $R_p = 2(E_b - E_{bmin})/I_{bmax} = 2(1250 - 80)/0.36 = 6500$  ohms.

**Class AB and Class B AF Amplifier Service**

Push-pull class AB and class B af amplifiers are assumed to have a con-

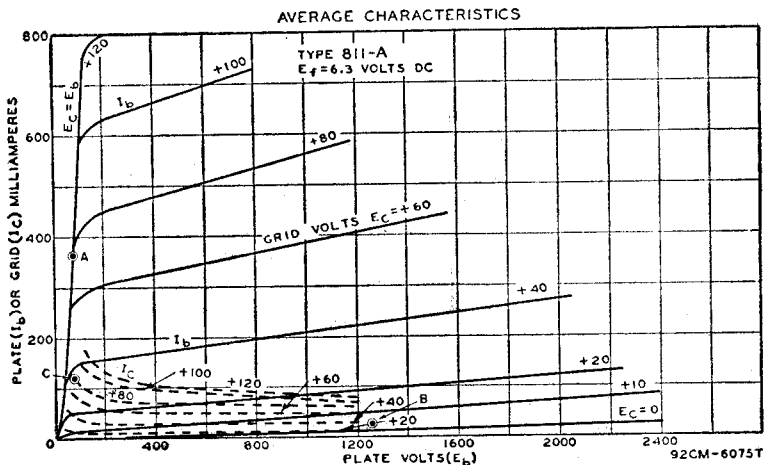

Fig. 48

- (1) Select  $E_b = 1250$  volts.
- (2) Calculate:  $I_{b0} = 0.9 P_{ine}/E_b = 0.9 \times 165/1250 = 0.12$  ampere.
- (3) Calculate:  $I_{bmax} = 3 I_{b0} = 3 \times 0.12 = 0.36$  ampere.
- (4) Calculate:  $I_b = I_{b0}/1.4 = 0.12/1.4 = 0.09$  ampere.
- (5) On Fig. 48 locate  $I_{bmax} = 0.36$  ampere at Point A. Read  $E_{cmax} = 80$  volts;  $E_{bmin} = 80$  volts.
- (6) Calculate  $I_{b0} = I_{b0}/5 = 0.12/5 = 0.024$  ampere.
- (7)  $P_{ine} = E_b I_{b0} = 1250 \times 0.12 = 150$  watts.
- (8) Calculate:  $PEP = (I_{bmax}/4)(E_b - E_{bmin}) = (0.36/4)(1250 - 80) = 0.09(1170) = 105$  watts.
- (9)  $P_p = 0.7 P_{ine} - 0.5 PEP = (0.7) 150 - (0.5) 105 = 52.5$  watts.
- (10) Record:  $E_g = E_{cmax} = 80$  volts.
- (11) On Fig. 48 locate  $I_{cmax} = 0.12$  ampere at Point C.
- (12) Calculate:  $I_{ce} = I_{cmax}/3 = 0.12/3 = 0.04$  ampere.
- (13) Calculate:  $I_c = I_{ce}/1.4 = 0.04/1.4 = 0.028$  ampere.
- (14) Calculate:  $P_d = E_g (I_{cmax}/4) = 80(0.12/4) = 2.4$  watts.

duction angle of 180 degrees.

This assumption is permissible (even though the actual conduction angle per tube is slightly greater than 180 degrees) because any plate currents drawn simultaneously by the two sides of the circuit are effectively cancelled in the output transformer and do not appear in the composite plate-current waveform. DC voltage, current, input, and dissipation values for af amplifiers are calculated on a per-tube basis; ac values such as power output, driving voltage, and driving power are calculated for the entire stage.

The plate-circuit loads for af amplifiers are usually iron-core transformers, which are not adjustable to the same degree as the resonant tank circuits used as loads for rf amplifiers. To assure proper loading for a class AB or B stage, therefore, it is necessary to calculate the plate-to-plate load resistance required, and to provide an output transformer or coupling device which presents this resistance to the plate circuit of the amplifier when connected to the external load. Because the dc plate current of a class AB or class B af amplifier is small under



zero-signal conditions and increases with amplitude of the driving signal, it is also necessary to calculate both the zero-signal plate current ( $I_{b_0}$ ) and the maximum-signal plate current ( $I_{b_{max}}$ ). The maximum-signal value should not be confused with the peak plate current ( $i_{b_{max}}$ ), which is the highest instantaneous value and, at the assumed conduction angle of 180 degrees, is equal to  $3.14 \times I_{b_{max}}$ .

### Class AB<sub>2</sub> Amplifiers Multigrid Tubes

(1) Choose a plate voltage ( $E_b$ ), a dc grid-No.2 (screen-grid) voltage ( $E_{c_2}$ ), and a maximum-signal dc plate current ( $I_{b_{max}}$ ) which provide a maximum-signal plate input within the maximum ratings for the tube. Assume a plate-conduction angle of 180 degrees.

(2) Using the value  $K_1 = 3.14$  given in Table I for a conduction angle of 180 degrees, calculate the peak plate current ( $i_{b_{max}}$ ) per tube as follows:

$$i_{b_{max}} = K_1 \times I_{b_{max}} = 3.14 I_{b_{max}}$$

(3) Determine peak positive grid-No.1 voltage ( $e_{c_{1max}}$ ) and effective minimum plate voltage ( $e_{b_{min}}$ ) from the plate-family curves for the tube for the calculated value of  $i_{b_{max}}$  and the chosen value of  $E_{c_2}$ . As mentioned earlier for class C amplifiers, the best compromise from the standpoints of plate-circuit efficiency and power sensitivity is obtained when  $e_{b_{min}}$  is slightly to the right of the "knee" in the appropriate grid-voltage curve.

(4) Using the value of  $K_2 = 0.785$  given in Table I, calculate the power output ( $P_o$ ) for the stage (two tubes in push-pull) as follows:

$$P_o = 2K_2 \times (E_b - e_{b_{min}}) \times I_{b_{max}} \\ = 1.57 \times (E_b - e_{b_{min}}) \times I_{b_{max}}$$

(5) The plate dissipation ( $P_p$ ) per tube is then given by

$$P_p = (E_b \times I_{b_{max}}) - P_o/2$$

If this value exceeds the maximum plate dissipation rating per tube for class AB<sub>2</sub> service, it will be necessary to recalculate steps (1) through (5) using either a smaller peak plate current (and, consequently, a smaller maximum-signal dc plate current), or a lower value of  $e_{b_{min}}$ .

(6) The zero-signal dc plate current ( $I_{b_0}$ ) per tube is selected to provide a

combination of high power output with low odd-harmonic distortion. A small value of  $I_{b_0}$  is desirable for high power output, but a value above the "knee" of the tube characteristic must be used to minimize distortion.

In most cases, a suitable value for  $I_{b_0}$  is one which results in a zero-signal plate dissipation per tube of one-third to one-half the maximum rated value ( $P_{p_{max}}$ ). For one-third maximum dissipation, the zero-signal plate current ( $I_{b_0}$ ) per tube is given by

$$I_{b_0} = P_{p_{max}} / (3 \times E_b)$$

(7) The dc grid-No.1 bias voltage ( $E_{c_1}$ ) required to obtain the desired value of  $I_{b_0}$  can then be determined from the plate-family curves for the chosen value of  $E_{c_2}$ .

(8) The peak of grid-No.1 (driving) voltage ( $E_{g_1}$ ) required for each tube is given by

$$E_{g_1} = -E_{c_1} + e_{c_{1max}}$$

The total driving voltage ( $E_{g_1-g_1}$ ) required for the stage, therefore, is given by

$$E_{g_1-g_1} = 2 \times (E_{g_1}) = 2 \times (-E_{c_1} + e_{c_{1max}})$$

(9) The plate-to-plate load resistance ( $R_{LP-p}$ ) required for a push-pull class AB<sub>2</sub> or class B amplifier is given by

$$R_{LP-p} = 1.27 \times (E_b - e_{b_{min}}) / I_{b_{max}}$$

This value is four times the resistance represented by a load line drawn on the appropriate plate-family curves for the tube from the  $i_{b_{max}}$ ,  $e_{b_{min}}$  point to the intersection of the plate-voltage ( $E_b$ ) coordinate with the  $I_b = 0$  axis.

(10) Determine the peak grid-No.1 current ( $i_{c_{1max}}$ ) per tube from the grid-No.1-current curves given for the tube. The value of  $i_{c_{1max}}$  is shown at the intersection of the  $e_{b_{min}}$  coordinate with the  $e_{c_{1max}}$  curve.

(11) The maximum-signal driving power ( $P_d$ ) required by the push-pull stage is given by

$$P_d = i_{c_{1max}} \times E_{g_1} / 2$$

(12) The peak grid-No.2 current per tube ( $i_{c_{2max}}$ ) is obtained from the grid-No.2 characteristics curves for the chosen grid-No.2 voltage.

(13) Using the value  $K_3 = 0.25$  given in Table I for a conduction angle of 180 degrees, calculate the maximum-signal

grid-No.2 current ( $I_{c_{2max}}$ ) per tube as follows:

$$I_{c_{2max}} = K_4 \times i_{c_{2max}} = 0.25 i_{c_{2max}}$$

(14) The maximum-signal grid-No.2 input ( $W_{e_2}$ ) per tube is then given by

$$W_{e_2} = E_{e_2} \times I_{c_{2max}}$$

If this value of  $W_{e_2}$  exceeds the maximum rating for the tube, it will be necessary to reduce either  $e_{b_{min}}$  or  $E_{e_2}$ .

The zero-signal grid-No.2 current ( $I_{e_{20}}$ ) is usually a small fraction of the maximum-signal current ( $I_{c_{2max}}$ ). Consequently, it has little or no effect on the maximum grid-No.2 input, and is not an important consideration.

**Example:**

Calculate operating values for a push-pull class AB<sub>2</sub> af amplifier stage using two RCA-6146 tubes operating under ICAS conditions. The basic operating values are  $E_b = 600$  volts,  $E_{e_2} = 200$  volts, and  $I_{b_{max}} = 135$  milliamperes per tube.

(1) Plate input per tube ( $P_1$ ) =  $600 \times 0.135 = 81$  watts. This value is well within the maximum rating of the 6146 for this type of service (90 watts).

(2) For a conduction angle of 180 degrees, peak plate current per tube ( $i_{b_{max}}$ ) =  $3.14 \times 0.135 = 0.424$  ampere, or 424 milliamperes.

(3) From the average plate characteristics curves for  $E_{e_2} = 200$  volts given in the data section, the peak positive grid-No.1 voltage per tube ( $e_{c_{1max}}$ ) = +5 volts (approx.) and the effective minimum plate voltage ( $e_{b_{min}}$ ) = 65 volts (approx.).

(4) Power output for two tubes in push-pull ( $P_o$ ) =  $1.57 \times (600-65) \times 0.135 = 113.5$  watts.

(5) Plate dissipation per tube ( $P_p$ ) =  $(600 \times 0.135) - 113.5/2 = 24.2$  watts.

(6) For one-third maximum rated plate dissipation, zero-signal dc plate current ( $I_{b_0}$ ) =  $25/(3 \times 600) = 0.0139$  ampere, or 14 milliamperes (approx.) per tube.

(7) From the plate-family curves for  $E_{e_2} = 200$  volts, the dc grid-No.1 voltage or bias ( $E_{c_1}$ ) required to produce a zero-signal plate current of 14 milliamperes per tube at a plate voltage of 600 volts is approximately -51 volts.

(8) The peak af grid-No.1-to-grid-

No.1 (driving) voltage ( $E_{g_1-g_1}$ ) =  $2[-(-51) + 5] = 112$  volts.

(9) The effective plate-to-plate load resistance ( $R_{LP-p}$ ) =  $\frac{1.27 \times (600 - 65)}{0.135} = 5033$ , or approximately 5000 ohms.

(10) From the grid-No.1 curves given in the data section for  $E_{e_2} = 200$  volts, peak grid-No.1 current ( $i_{c_{1max}}$ ) is 8 milliamperes (approx.) for  $e_{c_{1max}} = +5$  volts and  $e_{b_{min}} = 65$ .

(11) The driving power required to produce maximum power output ( $P_d$ ) =  $(0.008 \times 56)/2 = 0.22$  watt.

(12) From the grid-No.2 curves for  $E_{e_2} = 200$  volts given in the data section, for  $e_{c_{1max}} = +5$  volts and  $e_{b_{min}} = 65$  volts, peak grid-No.2 current per tube ( $i_{c_{2max}}$ ) = 45 milliamperes.

(13) The dc maximum-signal grid-No.2 current per tube ( $I_{c_2 \text{ max}}$ ) =  $0.25 \times 45 = 11.2$  milliamperes.

(14) Maximum-signal grid-No.2 input per tube ( $W_{e_2}$ ) =  $200 \times 0.0112 = 2.24$  watts. This value is well within the maximum rating for the 6146 (3 watts per tube).

These calculated values are compared below with the nearest "Typical Operation" shown in the published data for the 6146 in Class AB Operation, ICAS conditions.

Values are for two tubes	Calculated	Published
DC Plate Voltage ( $E_b$ )..	600	600 volts
DC Grid-No.2 Voltage ( $E_{e_2}$ ).....	200	190 volts
DC Grid-No.1 Voltage (Fixed Bias, $E_{c_1}$ )....	-51	-48 volts
Peak AF Grid-No.1-to-Grid-No.1 Voltage ( $E_{g_1-g_1}$ ).....	112	109 volts
Zero-Signal DC Plate Current ( $2I_{b_0}$ ).....	27	28 ma
Maximum-Signal DC Plate Current ( $2I_{b_{max}}$ )	270	270 ma
Zero-Signal DC Grid-No.2 Current ( $2I_{c_{20}}$ )...	—	1.0 ma
Maximum-Signal DC Grid-No.2 Current ( $2I_{c_{2max}}$ )	22.4	20 ma
Effective Load Resistance (Plate to plate, $R_{LP-p}$ )	5000	5000 ohms
Maximum-Signal Driving Power, (Approx., $P_d$ )	0.22	0.3 watt
Maximum-Signal Power Output, (Approx., $P_o$ )	113.5	110 watts

**Class B Amplifiers  
Triodes**

The procedure for calculating oper-

ating values for push-pull triode class B stages is substantially the same as that given above for multigrid-tube class AB<sub>2</sub> stages, but does not involve calculations for grid-No.2 voltage, current, input, or dissipation.

**Example:**

Calculate operating values for a class B modulator stage using two RCA-812-A's operating under ICAS conditions. The dc plate voltage ( $E_p$ ) is 1500 volts, and the maximum-signal dc plate current ( $I_{pmax}$ ) per tube is 155 milliamperes.

(1) Plate input per tube ( $P_1$ ) =  $1500 \times 0.155 = 232.5$  watts. This value is slightly less than the maximum plate-input rating of the 812-A for ICAS operation (235 watts).

(2) For a conduction angle of 180 degrees, the peak plate current per tube ( $i_{pmax}$ ) =  $3.14 \times 0.155 = 0.487$  ampere, or 487 milliamperes.

(3) From the average plate characteristics curves shown in Fig. 45, for  $i_{pmax} = 487$  milliamperes, the peak positive grid voltage ( $e_{cmax}$ ) = +90 volts (approx.) and the effective minimum plate voltage ( $e_{vmin}$ ) = 100 volts.

(4) Power output for two tubes ( $P_o$ ) =  $1.57 \times (1500-100) \times 0.155 = 340$  watts (approx.).

(5) Plate dissipation per tube ( $P_p$ ) =  $(1500 \times 0.155) - 340/2 = 62.5$  watts. This value is within the maximum rating for the 812-A (65 watts).

(6) For one-third maximum rated dissipation, zero-signal dc plate current per tube ( $I_{p0}$ ) =  $65/(3 \times 1500) = 0.0145$  ampere = 14.5 milliamperes.

(7) From the plate characteristics curves given in Fig. 45, dc grid voltage or bias ( $E_c$ ) required to produce this value of plate current at a plate voltage of 1500 volts is approximately -45 volts.

(8) The peak of grid-to-grid driving voltage required for maximum power output ( $E_{g-g}$ ) =  $2E = 2[-(-45) + 90] = 270$  volts.

(9) The effective plate-to-plate load resistance ( $R_{L(p-p)}$ ) =  $\frac{1.27 \times (1500-100)}{0.155} = 11500$  ohms (approx.).

(10) From the grid-current curves

shown in Fig. 45, peak grid current ( $i_{cmax}$ ) for  $e_{cmax} = +90$  volts and  $e_{vmin} = 100$  volts is 140 milliamperes (approx.).

(11) The driving power required for maximum output ( $P_d$ ) =  $(0.140 \times 135)/2 = 9.45$ , or approximately 9.5 watts. These calculated values are compared below with the "Typical Operation" values for ICAS conditions shown in the published data for the RCA-812-A in Class B Modulator Service, ICAS conditions.

Values are for two tubes	Calculated	Published
DC Plate Voltage ( $E_p$ )..	1500	1500 volts
DC Grid Voltage ( $E_c$ )..	-45	-48 volts
Peak AF Grid-to-Grid Voltage ( $E_{g-g}$ ).....	270	270 volts
Zero-Signal DC Plate Current ( $2I_{p0}$ ).....	29	28 ma
Maximum-Signal DC Plate Current ( $2I_{pmax}$ )....	310	310 ma
Effective Load Resistance (Plate-to-plate, $R_{L(p-p)}$ )	11500	13200 ohms
Maximum-Signal Driving Power (Approx., $P_d$ )..	9.5	5 watts
Maximum-Signal Power Output (Approx., $P_o$ )..	340	340 watts

**Conversion Factors**

Operating conditions for voltage values other than those shown in the published data can be obtained by the use of the **nomograph** shown in Fig. 49 when all electrode voltages are changed simultaneously in the same ratio. The nomograph includes conversion factors for current ( $F_i$ ), power output ( $F_p$ ), plate resistance or load resistance ( $F_r$ ), and transconductance ( $F_{gm}$ ) for voltage ratios between 0.5 and 2.0. These factors are expressed as functions of the ratio between the desired or new voltage for any electrode ( $E_{des}$ ), and the published or original value of that voltage ( $E_{pub}$ ). The relations shown are applicable to triodes and multigrid types in all classes of service.

To use the nomograph, simply place a straight-edge across the page so that it intersects the scales for  $E_{des}$  and  $E_{pub}$  at the desired values. The desired conversion factor may then be read directly or estimated at the point where the straight-edge intersects the  $F_i$ ,  $F_p$ ,  $F_r$ , or  $F_{gm}$  scale.

For example, the dashed lines on the nomograph show that for a ratio  $E_{des}/E_{pub}$  of 2/2.5 (all electrode voltages reduced 20 per cent),  $F_i$  is approximately 0.72,  $F_p$  is approximately 0.57,

$F_r$  is 1.12, and  $F_{gm}$  is approximately 0.892. These factors may be applied directly to operating values shown in the tube data, or to values calculated by the methods described previously.

When only one electrode voltage of a tube is changed, for example in the calculation of operating conditions for a multigrid tube operated at a grid-No.2 voltage for which curve families are not available, the nomograph is used twice. The procedure is shown in the following example:

Determine operating values for an RCA-6146 beam power tube in Class C Telegraphy Service at its maximum ICAS plate-voltage ( $E_b$ ) and plate-input ( $P_1$ ) ratings of 750 volts and 90 watts, and at a grid-No.2 voltage ( $E_{c2}$ ) of 160

volts. (The dc plate current  $I_b$  of the tube under the desired conditions is 90 watts/750 volts, or 120 milliamperes.)

Because curve families are not available for an  $E_{c2}$  of 160 volts, operating conditions must first be calculated for the nearest value of  $E_{c2}$  for which curves are available (*i.e.*, 150 volts). For this calculation, the chosen values of  $E_b$  and  $I_b$  must be converted to the corresponding values for  $E_{c2} = 150$ . The plate voltage ( $E_b$ ) becomes  $\frac{750 \times 150}{160}$ , or approximately 703 volts. Using conversion-factor values obtained from the nomograph for the voltage ratio 150/160, the plate current ( $I_b$ ) =  $F_1 \times I_b = 0.91 \times 120$ , or approximately 109 milliamperes.

For a conduction angle of 140 de-

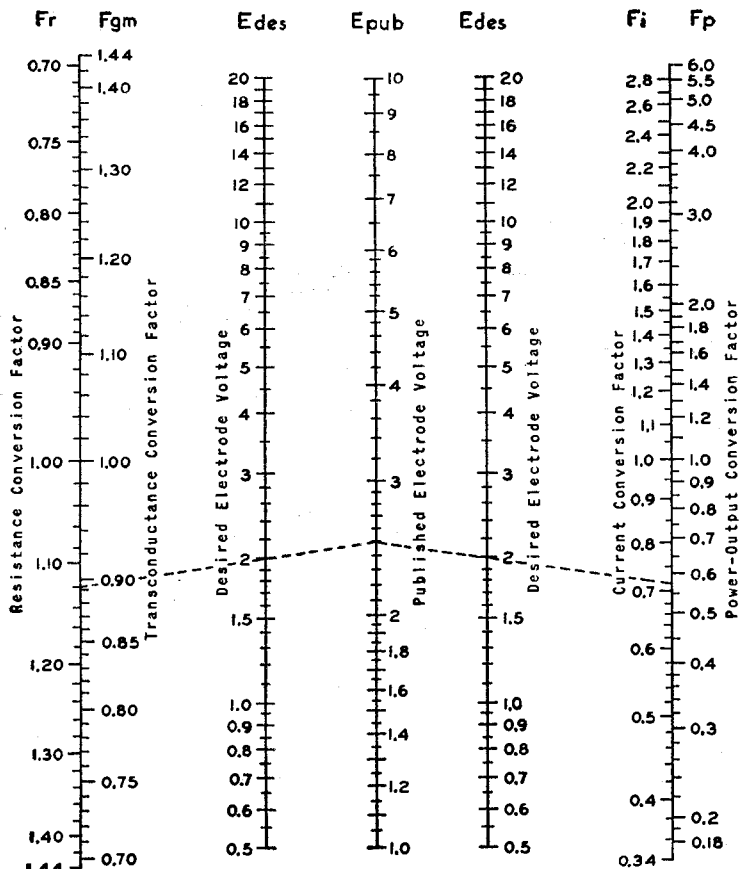

Fig. 49

grees,  $K_1 = 4$  and the peak plate current ( $i_{b_{max}}$ ) =  $4 \times 109 = 436$  milliamperes.

From the plate-family curves of the 6146 for  $E_{c2} = 150$  volts shown in the tube data, the effective minimum plate voltage ( $e_{b_{min}}$ ) = 75 volts and the peak positive grid voltage ( $e_{c1_{max}}$ ) = +15 volts.

From the corresponding grid-No.1 and grid-No.2 curve families, peak grid-No.1 current ( $i_{c1_{max}}$ ) = 24.5 milliamperes and peak grid-No.2 current ( $i_{c2_{max}}$ ) = 39.5 milliamperes.

These instantaneous voltages and currents can now be converted to corresponding values for the desired  $E_{c2}$  of 160 volts. For the voltage ratio 160/150, or 1.066,  $e_{b_{min}} = 75 \times 1.066$ , or approximately 80 volts, and  $e_{c1_{max}} = +15 \times 1.066$ , or approximately 16 volts.

From the nomograph, the current conversion factor  $F_i$  for the ratio 160/150 is 1.1. Consequently,  $i_{c1_{max}} = 24.5 \times 1.1$ , or approximately 27 milliamperes, and  $i_{c2_{max}} = 39.5 \times 1.1$ , or approximately 43.5 milliamperes.

The remaining operating values can then be calculated: Power output ( $P_o$ ) =  $K_2 \times (E_b - e_{b_{min}}) \times I_b = 0.862 (750 - 80) \times 0.120 = 69.3$  watts.

The dc grid-No.1 voltage or bias ( $E_{c1}$ ) =  $-(K_3 \times e_{c1_{max}}) - \frac{K_4 \times E_{c2}}{g_{m1}} = -(0.52 \times 16) - 1.52 (160/4.5)$ , or approximately -62 volts.

The peak rf grid-No.1 voltage ( $E_{g1}$ ) =  $-(-62) + 16 = 78$  volts.

From Table II, the constant  $K_6 = 9.15$  (approx.) for an  $E_{c1}/E_{g1}$  ratio of 62/78, or 0.795. Consequently, the dc grid-No.1 current ( $I_{c1}$ ) =  $27/9.15$ , or approximately 3 milliamperes.

The dc grid-No.2 current ( $I_{c2}$ ) =  $K_5 \times i_{c2_{max}} = 0.2 \times 43.5$ , or 8.7 milliamperes. The dc grid-No.2 input ( $W_{c2}$ ) =  $160 \text{ volts} \times 0.0087 \text{ amperes}$ , or approximately 1.4 watts.

These calculated values are compared below with the published "Typical Operation" values for the 6146 in Class C Telephony, ICAS conditions:

	Calculated	Published	
DC Plate Voltage ( $E_b$ ) . . . . .	750	750	volts
DC Grid-No.2 Voltage ( $E_{c2}$ ) . . . . .	160	160	volts

DC Grid-No.1 Voltage ( $E_{c1}$ ) . . . . .	-62	-62	volts
Peak RF grid-No.1 Voltage ( $E_{g1}$ ) . . . . .	78	79	volts
DC Plate Current ( $I_b$ ) . . . . .	120	120	ma
DC Grid-No.2 Current ( $I_{c2}$ ) . . . . .	8.7	11	ma
DC Grid-No.1 Current ( $I_{c1}$ ) . . . . .	3	3.1	ma
Driving Power, (Approx., $P_d$ ) . . . . .	0.21	0.2	watt
Power Output, (Approx., $P_o$ ) . . . . .	69.3	70	watts
Plate-input power ( $P_i$ ) . . . . .	90	90	watts
Plate dissipation ( $P_d$ ) . . . . .	21	20	watts
Grid-No.2 Input ( $W_{c2}$ ) . . . . .	1.39	1.76	watts

Because this method for conversion of characteristics is necessarily an approximation, the accuracy of the nomograph decreases progressively as the ratio  $E_{des}/E_{pub}$  departs from unity. In general, results are substantially correct when the value of the ratio  $E_{des}/E_{pub}$  is between 0.7 and 1.5. Beyond these limits, the accuracy decreases rapidly, and the results obtained must be considered rough approximations.

The nomograph does not take into consideration the effects of contact potential or secondary emission in tubes. Because contact-potential effects become noticeable only at very small dc grid-No.1 (bias) voltages, they are generally negligible in power tubes. Secondary emission may occur in conventional tetrodes, however, if the plate voltage swings below the grid-No.2 voltage. Consequently, the conversion factors shown in the nomograph apply to such tubes only when the plate voltage is greater than the grid-No.2 voltage. Because secondary emission may also occur in certain beam power tubes at very low values of plate current and plate voltage, the conversion factors shown in the nomograph do not apply when these tubes are operated under such conditions.

### Adjustment and Tuning

AF equipment does not normally require tuning or preliminary adjustments other than those necessary for obtaining plate-current balance in push-pull stages. Subsequent operating adjustments of gain or input-signal level and "tone" or frequency response can usually be made without the aid of auxiliary equipment.

Tuning and operating adjustments in rf power equipment, however, are nu-

merous and complex and require the use of instruments for accurate measurement of frequency, dc grid current, dc plate voltage and current, and dc screen-grid (grid-No.2) voltage and current of multi-grid tubes. Other equipment which may be necessary or useful includes: a grid-dip oscillator for preliminary tuning of resonant tank circuits and for neutralization adjustments; a "dummy load" (an incandescent lamp or non-inductive resistor having suitable resistance and wattage rating) used to absorb the power output of the final stage so that unauthorized frequencies or other improper signals which may be produced during preliminary adjustments are not radiated by the antenna system or load; simple rf indicators, such as a neon lamp or a small flashlight bulb which is connected to a one- or two-turn loop of wire; and simple devices for measuring approximate frequency, such as absorption-type wavemeters. A cathode-ray oscilloscope is desirable for proper adjustment of radiotelephone, television, and facsimile transmitters.

Because a class C stage may draw excessive plate current if operated even momentarily into an improperly tuned plate-tank circuit, all plate-tank circuits should be tuned to their approximate operating frequencies (with the aid of a grid-dip oscillator) before actual operating adjustments are begun. During this preliminary tuning procedure, all plate, screen-grid, and grid-bias supplies should be turned off, but all tubes and circuit components should be in place and normal filament or heater voltages should be applied to the tubes to assure that the stray capacitance and inductance of each stage are substantially the same as those present during operation.

### Tuning Procedure

Tuning and adjustment of rf power equipment starts in the oscillator or input stage, and continues through succeeding stages along the path followed by the rf signal. The procedure used in tuning class C stages is generally the same for all types of service, circuit configurations, and tube types. Consequently, the procedure given below for tuning a "straight-through" rf amplifier stage also applies to frequency multipliers. It

is assumed that the amplifier has been properly neutralized, if required, by the method described later, and that the preceding stage or "driver" has been properly tuned and is delivering full output at the desired frequency.

(1) Make sure that all power to the equipment is off.

(2) Disconnect all positive plate, screen-grid, and suppressor-grid supply leads from the amplifier and from all following stages.

(3) If variable coupling is used between driver and amplifier, adjust the coupling to approximately one-half maximum.

(4) Apply only normal filament or heater voltage to the amplifier, and all normal operating voltages to the driver.

(5) Quickly tune the driver plate circuit to resonance, which is indicated by a dip in driver plate current, as shown in Fig. 50, and by maximum grid current in the amplifier stage. If the amplifier has a tuned grid circuit, this circuit should also be tuned to resonance (indicated by an increase in the amplifier grid current).

(6) Increase the coupling between driver and amplifier, being careful not to exceed the maximum permissible grid current for the amplifier tube or tubes. It should be possible to obtain full rated grid current for the amplifier stage without overloading the driver (overload being indicated by excessive driver plate current at resonance).

(7) Retune the driver plate circuit (and the amplifier grid circuit) to resonance. This procedure should always be

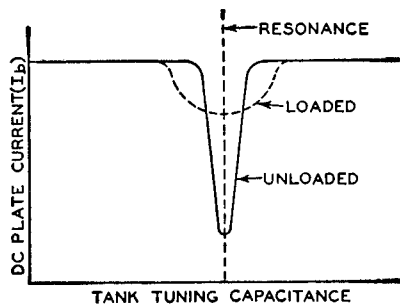

Fig. 50

followed after a change is made in coupling or loading to compensate for the

normal detuning effects of such changes.

(8) Turn on any fixed-bias supplies for the amplifier, and make any circuit changes or adjustments necessary to assure that the plate, screen-grid, and suppressor-grid voltages for the amplifier will not be more than 50 per cent of their normal values when applied. Disconnect the external load from the amplifier plate-tank circuit, or, if this change is not practicable, reduce the coupling between amplifier and external load to minimum. If the load for the amplifier is another tube, remove this tube from its socket.

(9) Apply plate, screen-grid, and suppressor-grid voltages (50 per cent of normal values) to the amplifier, but not to any following stages, and quickly tune the amplifier plate circuit to resonance. When an amplifier is operated without a load connected to its plate tank, its plate current will usually dip at resonance to between 10 and 20 per cent of the normal full-load value. The absolute value of the no-load plate current at resonance depends on the  $Q$  of the plate-tank circuit, the type of bias used, and the rf excitation voltage, and should not be considered an indication of the amplifier efficiency.

If the plate current of an unloaded triode does not dip in the normal manner, the trouble may be caused by inadequate grid excitation, excessive tank-circuit losses, or improper neutralization. If the plate-tank circuit of any class C amplifier cannot be tuned to resonance, the tank-circuit inductance or capacitance, or both, may have to be increased or decreased in value, depending on whether the circuit is found to tune higher or lower than the desired frequency. An absorption-type wavemeter is useful in such adjustments.

If flashover occurs in the plate-tank capacitor during tuning adjustments, reconnect the load to the amplifier output circuit and/or increase the coupling between amplifier and load until the rf voltage is reduced sufficiently to eliminate the flashover.

(10) Connect the external load to the amplifier plate tank. (If this step has already been taken to eliminate flashover, as described above, tighten the load coupling.) When the load is applied

or the load coupling increased, the plate current of the amplifier should rise. Retune the amplifier plate tank to resonance after each change in coupling. The amplifier plate current should still dip at resonance, but its minimum value should be considerably higher than under no-load conditions, as shown by the dashed curve in Fig. 50.

(11) Apply full plate, screen-grid, and suppressor-grid voltages to the amplifier. Increase the coupling between amplifier and load, retuning the amplifier plate tank to resonance as often as necessary, until the plate current at the resonance dip has the desired value. In no case should the plate input (the product of the dc plate voltage and dc plate current) exceed the maximum value given in the tube ratings for the type of service involved.

Because the dc grid current of an amplifier decreases as the load on the amplifier is increased, grid current should be checked after each change in load or load coupling to make sure it has not dropped appreciably below the normal or desired value. If it has, the cause may be insufficient grid excitation or excessive grid bias.

### Neutralizing Adjustments

The procedure used in neutralizing rf amplifiers is substantially the same regardless of the neutralizing circuits or tube types employed. The tube operating conditions used are similar to those employed for preliminary tuning of plate-tank circuits, except that excitation at the highest operating frequency is applied to the stage being neutralized.

(1) Make sure that all power to the equipment is *off*.

(2) Disconnect all positive plate, screen-grid, and suppressor-grid supply leads from the amplifier and from all following stages. Adjust the coupling between driver and amplifier to maximum, and loosely couple a fairly sensitive rf indicator to the amplifier plate-tank coil. Although a simple indicator is usually satisfactory, a sensitive rf meter connected to a one- or two-turn loop or a vacuum-tube voltmeter equipped with a suitable rectifier probe provides more exact indications, particularly for final adjustments.

(3) Apply normal filament or heater voltage to the amplifier, and all normal operating voltages to the driver, and tune the driver plate circuit to resonance.

(4) Tune the plate-tank circuit of the amplifier to resonance (shown by maximum brightness or maximum reading of the rf indicator). Adjust the neutralizing capacitor until the rf indicator shows minimum brightness reading.

(5) Carefully retune the amplifier plate-tank circuit to resonance. The rf indicator should now show a new maximum reading, but one having substantially smaller magnitude than the original reading. Again adjust the neutralizing capacitor for a minimum reading on the rf indicator. The driver plate-tank circuit should be checked and, if necessary, returned to resonance during these adjustments.

Repeat step (5) until a setting for the neutralizing capacitor is found which produces no indication of rf voltage in the amplifier plate circuit. As this setting is approached, it will probably be necessary to increase the coupling between the rf indicator and amplifier plate tank to obtain useful indications. A stage may be considered properly neutralized when the rf indicator shows zero at maximum coupling.

In neutralizing a push-pull amplifier, both neutralizing capacitors should be adjusted simultaneously. However, both capacitors will seldom have the same setting at the point of complete neutralization because of slight differences in tube and stray circuit capacitance, and because split tank circuits are seldom electrically symmetrical.

A dc milliammeter connected in the grid-return circuit of an amplifier can also be used as a very sensitive indicator for neutralizing adjustments. The amplifier is operated without plate, screen-grid, or suppressor-grid voltage, and sufficient rf excitation is applied to produce a normal value of grid current. If the amplifier is not properly neutralized, its grid current will vary when its plate-tank circuit is tuned through resonance. The neutralizing capacitor should then be adjusted slowly while the amplifier plate-tank circuit is tuned back and forth through resonance. As the point of neutralization is approached, the variations in grid current decrease. When the amplifier is perfectly neutralized, tuning of its plate-tank circuit through resonance does not cause even a slight change in the reading of the grid-current meter.

In some cases, it may not be possible to eliminate rf feedthrough entirely by adjustment of the neutralizing capacitor. This difficulty is usually an indication of stray coupling between the amplifier and driver plate tanks, or of stray capacitances in various portions of the amplifier which tend to unbalance the neutralizing circuit. Adequate shielding between the driver and amplifier and between the grid and plate circuits of the amplifier will usually eliminate this difficulty.

The difficulty may also arise in a stage employing a split-stator tank capacitor if the ground lead of the capacitor is not connected by the shortest possible path to the cathode-return point of the stage.



# Power-Tube Installation

Because power tubes usually operate at high voltages and temperatures, draw heavy currents, and are used in high-efficiency circuits, terminal connections for such tubes should have large-area, low-resistance contacts capable of accommodating relatively large wire sizes and utilize high-quality insulation.

**Sockets or mountings** for power tubes having filamentary cathodes should be installed, as a general rule, so that the tubes are operated in a vertical position with the base or filament end down. Vertical operation minimizes the danger of internal short circuits which may be caused by thermal expansion or sagging of the filament. Certain filamentary-cathode vacuum types may be operated in other than vertical positions, provided precautions specified in the tube data are observed. Tubes having indirectly heated cathodes may generally be operated in any position.

If equipment is to be subjected to mechanical shock or vibration, the equipment housing, the tube mountings, or both should include some form of shock-absorbing suspension, and suitable means should be employed to lock the tubes in their sockets or mountings.

## Ventilation and Cooling

All electron tubes have heat losses in the plate which cause the temperature of the tube to rise above the ambient temperature. As a result, the dissipation rating of the plate is limited by the maximum allowable temperature which the envelope and internal elements of the tube are rated to withstand. Therefore, all methods of cooling tubes have the common purpose of transferring dissipated heat from the tube to maintain terminal or bulb temperatures below their specified ratings.

Three basic methods are used to cool power tubes: natural-convection, forced-air, and conduction cooling. Most of the tubes listed in this manual are designed for operation at maximum ratings with natural-convection cooling. Some types, such as the 6161, require forced-air cooling; other types, such as the 826, 829B,

and 833A, can be operated with natural-convection cooling, but carry substantially higher ratings when forced-air cooling is employed. Recently developed tubes having external plates are cooled by forced-air cooling (type 8122) or by conduction cooling (type 8072).

Regardless of the cooling method used, power-tube equipment design should always permit the unimpeded circulation of air around all tubes and include provision for adequate ventilation of tube and equipment enclosures so that the envelope temperatures will not become high enough to damage the tubes or their associated circuit components. No further precautions need be taken for tubes cooled by natural convection, other than ensuring that the maximum permissible seal or bulb temperature is not exceeded. Tubes cooled by natural convection are generally limited to plate-dissipation ratings below 1000 watts.

Tubes designed for forced-air cooling can be made smaller and more compact; however, systems using forced-air-cooled tubes require duct work and additional power for the operation of a fan. Forced-air cooling for power tubes can range from a stream of air directed radially to the major tube axis to a stream directed axially through an elaborate air-flow system. Forced-air-cooled types are fitted with a special radiator which increases the cooling efficiency. Various types of radiators are described under *Construction and Materials*. Forced-air-cooled tubes are generally limited to plate dissipation ratings below 50,000 watts. Maximum permissible envelope temperatures, air flow, and pressure requirements for forced-air-cooled tubes are given in the *Tube Types—Technical Data* section.

To a certain extent, conduction cooling is inherent in all tubes as a result of the physical contact between the tube and its socket and mounting. However, tubes which are specifically designed for conduction cooling can be made smaller and more compact and do not require the fan and duct work necessary for

forced-air cooling. These tubes can be used in enclosed or high-altitude systems where forced-air cooling is precluded. Although conduction cooling requires careful initial design of the thermal circuit, it does not require cooling-system maintenance or operating expense. In conduction-cooled tubes, the plate must be designed as an external electrode and its terminal must be thermally coupled to a constant-temperature device (solid or liquid heat sink) which limits the tube to the specified maximum temperature. The coupling must have low electrical conductance and high thermal conductivity.

Thermal conductivity is defined as the rate of transfer of heat by conduction through unit thickness of a material, across a unit area for a unit difference of temperature. The thermal conductivity  $K_s$  of the entire conduction-cooling system for any given configuration is represented by the equation:

$$K_s = \frac{W_p}{T_2 - T_1}$$

where  $W_p$  is the selected dissipation in watts,  $T_2$  is the temperature at the tube terminal in degrees centigrade ( $T_2$  should never exceed the specified maximum rating), and  $T_1$  is the temperature at the heat sink in degrees centigrade.

For very-high-power requirements, liquid cooling, which is capable of removing large quantities of heat, is required. In this type of cooling, the tube electrodes are either immersed in a liquid or have built-in ducts for conveying the liquid through the internal areas of the electrodes.

Water is the most commonly used coolant because it is readily available and inexpensive. The water must be free from impurities which might make it a conductive medium. Other coolants having lower freezing points are used in systems which may be subjected to freezing temperatures when not in use.

It is essential that high-quality liquid be used to fill the cooling system and that provision be made for continuous purification and elimination of sources of contamination. These precautions are necessary to prevent scale formation, corrosion, and excessive electrolysis, which can reduce tube life.

The glass portions of a tube envelope should not be exposed to the spray of any liquid or be permitted to come in contact with metal objects such as circuit wiring or grounded metal shields because excessive temperature differences may cause envelope fractures. Shields should not fit so closely as to impede the free circulation of air around the tubes. In many cases, they may be designed to produce a "chimney" effect which will increase the draft and improve tube ventilation.

The maximum permissible bulb temperature of a vacuum tube or inert-gas tube is determined principally by the softening point of the glass employed, or by the point at which gas may be released by the envelope. In the case of mercury-vapor tubes, both minimum and maximum bulb-temperature limits are specified to assure satisfactory vaporization of the mercury. Temperature considerations for mercury-vapor tubes are discussed in the *Rectifier Considerations* Section.

### Wiring Considerations

Energy losses in power-tube circuit wiring limit operating efficiencies and may produce undesirable heat. These losses may be caused by conductor resistance ( $I^2R$  losses), leakage ( $E^2/R$  losses), radiation, or stray coupling.

**Excessive  $I^2R$  losses** in power-tube circuit wiring can be avoided by the use of conductors having adequate current-carrying capacity and the lowest possible resistance, and layouts which permit short, direct, connecting leads. Filament and heater-circuit conductors are particularly susceptible to large  $I^2R$  losses because they carry currents of high average (dc) or rms (ac) value, and because their resistance is increased by heat received by direct thermal conduction from the tube filaments or heaters. When an installation requires the use of long filament-supply leads or operation of several high-current tubes from a common filament-supply line, these losses may cause filament voltages to decrease below the minimum values specified in the tube data and the tubes may be damaged. In such cases, conductors of adequate size should be used to avoid excessive losses or sufficient excess voltage

should be provided at the supply to compensate for the resulting losses. In the latter case, means of adjusting the supply voltage and suitable metering facilities should be provided to assure that correct filament or heater voltage is received at all terminals.

Excessive  $I^2R$  losses in signal conductors may also cause improper operation and tube damage, particularly in driving circuits where the signal provides the required operating bias as well as protection of the tube. In the selection of signal conductors, consideration must be given to "skin effect," which causes current to concentrate nearer the surface of a conductor as the frequency increases, as well as to the type of circuit and the waveform of the signal current.

A signal conductor should have low resistance at the highest frequency involved, and be capable of carrying the highest peak currents flowing in the circuit with negligible heating. Solid or stranded conductors are suitable for af applications, and a special type of multiple-strand conductor called "Litzendraht" for low- and medium-power rf applications at frequencies up to approximately 3 megacycles per second. At higher frequencies it is advisable to use tubular conductors, which should be silver-plated, if possible, to obtain maximum surface conductivity and to minimize the effects of oxidation.

**Leakage ( $E^2R$ ) losses** are caused primarily by inadequate or improper insulating materials, or by insufficient separation between air-insulated conductors. In the selection of insulating materials for power-tube installations, consideration should be given to the fact that very high peak-signal voltages may be developed in circuits operating at relatively low dc potentials. In addition, the type of insulating material used at any point must be suitable for the temperature and frequency involved.

As a general rule, conductors having enamel, plastic, or fabric coverings should be used only in supply circuits and low-frequency signal circuits operating at low voltages. Supply-circuit conductors should be installed in comparatively cool locations as far from signal conductors and unshielded signal components as possible. Such conductors,

when completely insulated, may usually be grouped or cabled together on the chassis or framework of the equipment. When high voltages or very high temperatures are involved, it is generally preferable to use bare conductors which are adequately spaced and supported by insulators of suitable mechanical design.

Rf signal conductors, particularly those carrying vhf or uhf currents, should not be insulated, except at points where mechanical support is necessary, because practically all types of surface insulation absorb appreciable energy in the presence of rf fields. These conductors should be isolated from each other, from circuit components, and from the equipment structure.

Losses of signal energy by **radiation** from circuit conductors increase with current and with the length of the conductors, but usually do not become appreciable until conductor length approaches a substantial fraction of a half-wavelength at the operating frequency. Lead length requires careful consideration in vhf and uhf equipment, however, because of the close relationship between practical conductor dimensions and signal wavelengths.

**Stray coupling** in circuit wiring may produce out-of-phase signal currents in a conductor. These currents cause degeneration losses. Such losses may be minimized by the use of short, direct, circuit connections. These considerations are discussed below under "Circuit Returns."

Cap or wire bulb terminals such as those used on the 807 and 6524 should never be used to support coils, capacitors, or other circuit components because the resulting mechanical stresses may fracture the bulb seals. Connections to bulb terminals should always be made with soft metallic braid or ribbon, or with other types of conductors having good mechanical flexibility and low electrical resistance. Under no circumstances should connections be soldered to cap or wire bulb terminals because the high temperatures developed may soften or crack the bulb seals. The long, flexible, wire terminal leads used on subminiature types such as the 5718, however, may be soldered directly to circuit components, provided speed and care are

used to minimize the transmission of heat to the bulb seals.

### **Circuit Returns**

All currents in a power tube (except heater current) originate in and return to the cathode, which is, therefore, a common terminal of all supply and signal circuits associated with the tube. The direct currents drawn by the tube electrodes return to the cathode through the power-supply and bias circuits. Although these circuits also provide return paths to the cathode for signal currents, they usually contain resistive and reactive components which offer considerable impedance to ac signals and thus cause substantial loss of signal energy. When a single power supply is used for more than one stage, its internal impedance may also act as a coupling device between stages and thus introduce undesired degeneration or regeneration. These effects may generally be avoided by the use of separate ac and dc return paths to cathode from each electrode or signal circuit of a tube.

**DC circuit returns** for a power tube employing fixed bias, grid-resistor bias, or a combination of the two, are made to the cathode terminal of the tube. When cathode-resistor bias is used, either alone or in combination with another type of bias, the dc circuit returns are usually connected to the more negative terminal of the cathode resistor. If the dc voltage drop across the cathode resistor is greater than the bias required, however, the grid-circuit dc return for the tube may be connected to a tap on the cathode resistor which provides the desired bias voltage. When an rf choke coil or a resonant network is connected in series with the cathode of a power tube employing fixed or grid-resistor bias, dc circuit returns are made in the same manner as when cathode-resistor bias is used. In a filamentary-cathode power tube, the heating current creates a voltage drop in the cathode which is equivalent to a bias voltage equal to about one-half the filament voltage. The polarity and value of this drop must be considered in determining the point to be used for dc circuit returns.

When dc filament voltage is applied to a filamentary-cathode tube, all dc

circuit returns should be connected to the negative filament terminal of the tube. The use of this point for dc returns provides a small amount of protective bias for the tube because the grid is maintained at a negative potential with respect to the cathode in the event that external bias fails or is accidentally removed.

When ac voltage is applied to a filamentary cathode, dc circuit returns should be made to the mid-point of the filament or filament-supply circuit to minimize hum. A convenient point for these returns is a center tap on the supply winding of the filament transformer, or the junction of two equal resistors connected in series across the filament circuit.

Most heater-cathode tubes have a single cathode terminal which is used for all circuit returns or for connection of a cathode resistor. In some heater-cathode tubes, however, two or more cathode terminals are provided to permit the use of separate ac return leads from the input and output circuits of the tube and thus minimize cathode-lead degeneration. Because these terminals are connected in parallel internally, any one of them may be used as the dc return point of the tube or for connection of a cathode resistor.

When a heater-cathode tube is operated with fixed bias or grid-resistor bias, or with cathode-resistor bias within the maximum heater-cathode voltage rating of the tube, the heater should be connected to the dc return point of the tube. In other cases, the heater should be connected to the tube cathode or to a point having the same dc potential as the cathode. Although either of the heater terminals may generally be used for this connection, it may sometimes be necessary to use a center tap on the heater winding of the supply transformer or a center-tapped resistor across the heater circuit to minimize hum.

The use of separate ac and dc returns in power-tube installations minimizes signal-energy losses in power-supply and bias circuits. It also minimizes degenerative or regenerative effects which may result if common signal-return paths are used for the input and output circuits of a tube or for the cir-

cuits of more than one tube. AC returns are generally made through capacitors directly to the cathode, or to points having the same ac potential as the cathode, regardless of the location of the dc return point.

In all applications, the grid, plate, and screen-grid circuit returns of the tube may be bypassed individually to the chassis or to a common ground bus (and thus to the cathode), as shown in Fig. 51, by capacitors which have very low impedance at audio frequencies. In this case, the length of the portions of chassis or ground bus used as common ac return paths is not critical because the impedance of such paths at audio frequencies is generally negligible.

At radio frequencies, however, a distance of even a fraction of an inch between points on a chassis or ground bus may represent a substantial impedance and produce undesirable coupling effects.

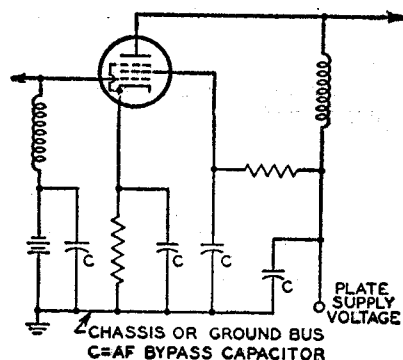

Fig. 51

The ac circuit returns of an rf stage should, therefore, be connected directly to the appropriate cathode terminals of the tube socket or to a single point on the chassis which is at the same ac potential as the cathode. Fig. 52 is a semi-pictorial diagram showing the ac circuit returns required in a high-frequency amplifier stage using a beam power tube. Bypass capacitors are used across each side of the filament center-tap resistor to minimize the rf impedance of the filament circuit. Capacitors used in rf bypass applications should be specifi-

cally designed for use at the required operating frequencies.

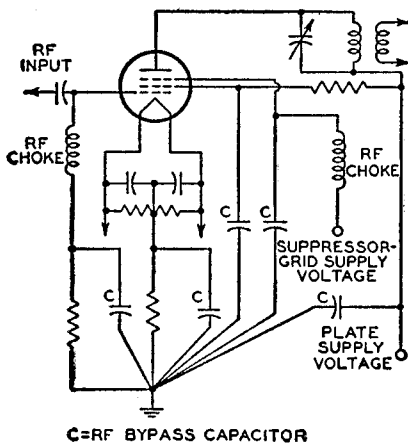

Fig. 52

### Filament or Heater Supply

AC voltage is generally used to heat the cathodes of power tubes because of the convenience and economy with which the relatively low voltages required may be obtained from transformers. The operating voltages applied to thoriated-tungsten or oxide-coated filamentary cathodes should not be permitted to vary more than plus or minus five per cent from the values specified in the tube data. Heater voltages for unipotential cathodes should be maintained within plus or minus ten per cent of rated values unless smaller tolerances are specified in the data for individual tube types. Voltage variations greater than those specified may damage the emitting surface of the cathode, or in other ways cause unsatisfactory tube operation or short life.

When filamentary-cathode power tubes are heated with direct current, any current- or voltage-control devices employed should be placed in the branches of the supply circuit feeding the individual tubes. When alternating current is used, such control devices should be placed in the primary circuits of the filament-supply transformers. When a filamentary cathode is heated

by low-frequency alternating current, hum may be introduced into the tube circuit by (1) a periodic variation in the electron emission as the heating current increases and decreases in value; (2) interaction between the magnetic field of the space-charge and that of the filament; and (3) the electrostatic field of the filament. The principal source is usually the electrostatic field of the filament, which induces hum voltages in the signal electrodes of the tube in proportion to the filament voltage and the capacitance between the filament and other electrodes.

### Plate Supply

The power-rectifier tubes included in this Manual normally obtain their plate-supply voltage from the secondary windings of high-voltage transformers connected to commercial power lines or to local sources of low-frequency ac voltage. Power-amplifier tubes usually obtain plate voltage from rectifiers provided with suitable filter circuits, although batteries or local dc generators are sometimes used, especially in portable and mobile equipment.

### Suppressor-Grid Supply

Voltage for the grid No.3 or suppressor grid of a power pentode ~~may be obtained from any dc source which is substantially free from ripple or other undesirable fluctuations in potential.~~ When an application requires that a suppressor grid draw a varying current, the dc supply should be a battery or other source having good voltage regulation. This requirement is particularly important when a suppressor grid is used as a modulating electrode because the average suppressor-grid current may then vary with the amplitude of the modulating signal.

### Screen-Grid Supply

Grid-No.2 or screen-grid voltage for a beam power tube, pentode, or tetrode may be obtained from a separate dc power supply or from the plate supply for the tube. In the latter case, the required voltage may be obtained either from a suitable tap on a voltage divider or through a dropping resistor from the plate-voltage supply point, depending on the type of multigrid tube used and

on the application.

A multigrid tube may fail prematurely if its screen-grid current, screen-grid voltage, or total screen-grid input exceeds the maximum value shown in the tube data. Excessive screen-grid current may be drawn if the tube is operated without adequate bias or plate voltage. Because the latter condition is most likely to occur when screen-grid and plate voltages are obtained from separate supplies, such supplies should be designed so that plate voltage is always applied before or simultaneously with screen-grid voltage and removed simultaneously with or after the removal of screen-grid voltage. In addition, any means employed for the reduction of plate voltage should automatically produce a proportional reduction in screen-grid voltage.

The danger of excessive screen-grid voltage is present principally when screen-grid voltage is obtained from the plate supply through a series dropping resistor. In this type of supply circuit, sufficient resistance is connected between the screen grid and the plate supply to assure that the screen-grid voltage and dissipation at the values of screen-grid current, bias, and driving voltage required for full output are within the maximum ratings for the tube. Any condition which reduces the current through the screen-grid dropping resistor to a very low value, therefore, may cause the screen-grid voltage to rise to an excessive value.

Such conditions are most likely to occur in telegraphy transmitters employing "blocked-grid" keying or other methods of keying which cut off or substantially reduce plate and screen-grid currents of multigrid tubes when the key is up. Although Class C Telegraphy ratings for most multigrid tubes permit a rise in screen-grid voltage under key-up conditions, the maximum permissible screen-grid voltage under these conditions is generally substantially less than the plate-supply voltage. Screen-grid voltage for a keyed multigrid amplifier should, therefore, be obtained from a separate supply or a voltage-divider arrangement, rather than by the series-resistor method. In cases where a series-resistor screen-grid supply voltage is

used, precautions should be taken to keep the screen-grid voltage within the maximum value specified in the tube data for key-up conditions.

### **Control-Grid (Bias) Supply**

Control-grid voltage or bias for a power tube may be obtained from a separate power supply or a resistor in the grid or cathode circuit. Fixed bias is obtained from an independent battery, dc generator, or rectifier-filter system. Grid-resistor bias is obtained by rectification of a portion of the input signal or driving voltage applied to the tube. Although this type of bias is the most economical, and can provide relatively large bias voltages or voltages which vary with the input signal, it does not provide protection against excessive plate and screen-grid current in the event the driving voltage fails or is removed. Grid-resistor bias, therefore, is usually used in combination with other means to protect the tubes against excessive plate and screen dissipation.

Cathode-resistor bias is obtained from the voltage drop developed across a cathode resistor by the combined dc currents of the tube electrodes. This type of bias provides automatic protection against excessive plate, screen-grid, and control-grid current because any increase in total cathode current produces a corresponding increase in bias voltage. Cathode-resistor bias cannot be used alone if bias voltage equal to or greater than the cutoff voltage is required. Because the effective plate and screen-grid voltages of the tube are reduced by the extent of the voltage drop in the cathode resistor, this type of bias is used principally when relatively small bias voltages are required or as a means of providing a minimum protective bias when the principal operating bias is obtained by the grid-resistor method.

### **Supply-Voltage Variations**

Because a tube may be seriously damaged if its absolute maximum voltage ratings are exceeded, consideration must be given to the variations in electrode voltages which result from line-voltage fluctuations, load variations, and normal manufacturing tolerances in circuit-component values. The operating

voltage for each tube electrode should be low enough so that the absolute maximum rated voltages of the tube will not be exceeded under any combination of these variations, or the voltage supplies should have sufficient regulation to permit the use of maximum rated voltages without danger of exceeding the tube ratings.

### **Protective Devices**

Power-tube installations should always be adequately equipped with protective devices to prevent damage to the equipment and/or personal injury. Devices which provide tube and circuit protection include:

(1) fuses or relays which automatically remove power from the equipment, or from a particular circuit, in the event of improper operation;

(2) meters, or facilities for external metering, to permit checking of important circuit operating conditions.

The most common cause of damage to tubes and equipment in power-tube installations is excessive plate or screen-grid current. For adequate protection, therefore, each stage of a power-tube installation should be equipped with fuses or relays which will remove all positive electrode voltages if the plate or screen-grid current reaches a value about 50 per cent above normal. Separate protective devices should be provided for plate and screen-grid circuits of multigrid tubes.

Facilities should be provided for the measurement of plate, screen-grid, and filament (or heater) voltages, and plate, screen-grid and control-grid currents. Control-grid-current measurements are particularly valuable in rf amplifier and frequency-multiplier stages because they facilitate tuning and neutralizing adjustments in addition to providing indications of drive conditions. Because correct filament and heater voltages are essential for maximum tube life, these voltages should always be measured directly at the tube sockets with meters having high accuracy and low power requirements.

For reasons of economy, a single dc milliammeter is sometimes placed in the cathode-return lead or the negative high-voltage supply lead of a tube for the

measurement of total cathode current. In such cases, the meter should be shunted with a resistor to protect the tube cathode and the meter from high dc potentials with respect to ground in the event of an open circuit in the meter. A shunting resistor having a value of about 100 times the resistance of the meter is generally satisfactory, and introduces an error in meter reading of only about one per cent.

### **Safety Considerations**

*Because the rated plate and screen-grid voltages of most power tubes are high enough to be extremely dangerous to the user, care should be taken during maintenance of power-tube equipment to insure that all primary power is disconnected*

*and all exposed circuit parts are effectively grounded. When circuit adjustments are made on "live" equipment, very great care should be taken to avoid contact with any circuit parts which are not at ground potential. Such adjustments should never be made unless another person capable of applying treatment for electric shock is present.*

*In the design of equipment, personal-safety considerations require the grounding of all operating controls and exposed surfaces, enclosure of all live circuit elements, and the incorporation of "interlock" switches at all points of access to the interior of the equipment. These switches should automatically open the primary circuits of all high-voltage power supplies when access is required.*



# Rectifier Considerations

Rectifier-type power supplies employing electron tubes are used as sources of plate, screen-grid (grid-No.2), and other dc operating voltages in all types of electronic equipment. They are also used extensively in electroplating, in motor-speed control, and in many other applications requiring economical and conveniently controllable dc power.

The glass envelopes of the rectifier tubes used in such supplies normally show some darkening after continued operation. In addition, mercury-vapor tubes exhibit a blue glow in normal operation. These symptoms are characteristic of such tubes, and should not be considered signs of tube deterioration or failure.

## Mercury-Vapor Tubes

A mercury-vapor rectifier tube must be handled with special care to prevent dispersion of the liquid mercury from its normal position at the bottom of the bulb. Spattering of the mercury over other portions of the bulb or on the anode or filament must be avoided because it may lead to internal shorts or arcs when the tube is placed in operation. A mercury-vapor tube should always be transported, stored, and operated in a vertical position with the filament end down, and should never be jarred, shaken, or allowed to rest even momentarily in a horizontal position. The tube should never be rocked or allowed to snap into place in its socket or mounting, and should be protected against excessive equipment vibration.

If spattering occurs, the dispersed mercury must be completely reconcentrated before the tubes are placed in service by means of special preheating and conditioning treatments. In the preheating treatment, the mercury-vapor tube is operated at normal filament voltage, but without anode voltage, for 30 minutes to assure complete vaporization of the mercury content. When filament voltage is removed at the end of this preheating period, most of the vaporized mercury recondenses in a pellet or pool

at the bottom of the bulb. The conditioning treatment is then applied to flash out any mercury which may have condensed on the bulb walls or in the vicinity of the anode and filament seals. In this treatment, the tube is operated at normal filament voltage and at about one-sixth normal anode voltage for 5 minutes. The anode voltage is then gradually increased over a period of about 30 minutes to the normal operating value. If an internal flashover occurs at any time during the conditioning treatment, the anode voltage should be reduced until the flashover ceases. It should then be held at this reduced value for a few minutes to assure complete vaporization of the mercury before the treatment is resumed.

## Filament Heating Time

Voltage should not be applied to the plates or anodes of vacuum, mercury-vapor, or inert-gas rectifier tubes (except receiving types) until the filaments or cathodes of the tubes have reached normal operating temperature. For gas tubes, this delay is necessary to allow the formation of a plasma, (region of electrons and positive ions) which protects the emitting surface against damage from high-velocity positive-ion bombardment. In the case of a mercury-vapor rectifier, the application of anode voltage must also be delayed until the condensed mercury has moved to its normal condensing zone at the bottom of the tube, as discussed above.

Minimum heating times for individual rectifier types are given in the *Tube Types* Section. In each case, the time specified is measured from the instant when the filament voltage reaches its normal operating value and, consequently, may have to be increased if the filament supply has poor regulation.

*It should be noted that measurement of the filament voltage of a power-rectifier tube may involve serious personal-safety hazards because the filament is usually a high-voltage terminal of the rectifier circuit. When continuous measurements are*

required, suitable voltmeters should be permanently incorporated in the equipment. These meters must be insulated to withstand the maximum peak inverse voltage applied to the tubes, and should be recessed in the equipment and protected by glass or plastic viewing panels to prevent any possibility of injury through accidental bodily contact. Portable instruments should not be used for the measurement of rectifier-filament voltages unless adequate personal-safety precautions are taken by the user.

Because a mercury-vapor tube may be severely damaged if the temperature of its filament varies excessively, the filament should be operated from a constant-voltage transformer, or its supply circuit should include under- and over-voltage relays which will open the primary circuit of the rectifier anode supply if the line voltage varies excessively. Relays having small operating delays (less than 10 seconds) may be used in this application to minimize interruptions to operation by normal surges or transient variations in line voltage.

The required delay in application of anode voltage can be obtained conveniently by means of a time-delay relay connected in the primary circuit of the high-voltage transformer, as shown in Fig. 53. This relay should permit adjustment of the delay time to a value sufficient to assure protection for the tubes under the most adverse conditions that can be expected in service.

### Mercury Temperature

The life and performance of a mercury-vapor rectifier are critically dependent on the temperature of the condensed mercury. Low ambient temperatures re-

tard vaporization of the mercury, thus limiting the degree of ionization available at normal filament voltage and raising the anode-cathode potential at which the tube starts to conduct. High ambient temperatures, on the other hand, are conducive to rapid vaporization, but tend to produce over-ionization and thus reduce the peak inverse anode voltage that the tube can withstand without breakdown. Rectifiers using mercury-vapor tubes, therefore, should be equipped with means for measuring condensed-mercury temperatures, and for maintaining these temperatures within limits specified for the tubes employed. Condensed-mercury temperature may be measured with a thermocouple or thermometer attached to the tube by means of a small amount of putty in a region near the bottom of the bulb. The proper measurement zone for each of the mercury-vapor tubes included in this Manual is shown in the *Outlines* Section.

The method used to control condensed-mercury temperature depends on the ambient-temperature conditions under which the tubes operate. If the ambient temperatures are near the minimum values specified in the tube data, some form of heat-conserving enclosure should be provided for the tubes. In extreme cases, it may also be necessary to employ electrical heating, together with suitable means for limiting the maximum temperatures developed. If ambient temperatures are above the maximum values specified in the tube data, forced-air cooling should be employed. The air flow should start when the anode voltage is applied to the tube, and should be directed horizontally onto the bulb about  $\frac{1}{2}$  inch above the base at the filament end of the tube. The air flow may be removed simultaneously with the anode voltage. The rise of mercury-vapor temperature above ambient temperature is given as a function of heating time under no-load and/or full-load conditions for mercury-vapor rectifier types in the *Tube Types—Technical Data* Section.

### Shielding

Rectifier tubes, particularly mercury-vapor types, should be isolated from transformers and other components which produce strong external magnetic

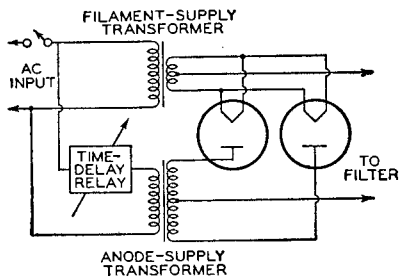

Fig. 53

or electrostatic fields. Such fields are generally detrimental to tube life, tend to produce breakdown effects in mercury vapor, and frequently make it difficult to obtain adequate filtering of rectifier output. When tubes cannot be completely isolated from such fields, they should be enclosed in shields of the type described in the *Power-Tube Installation* Section. Mercury-vapor rectifier tubes used to supply transmitters or other types of rf power equipment should also be protected from large rf voltages. Such voltages should be prevented from entering rectifier circuits by rf filters such as that shown in Fig. 54.

Mercury-vapor rectifier tubes occasionally produce multi-frequency oscillations or "hash" which may cause interference in the af stages of associated

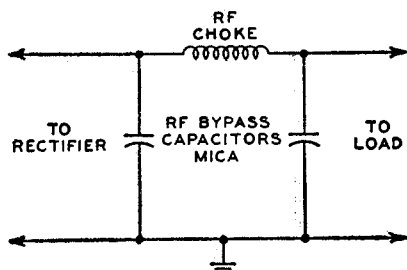

Fig. 54

equipment and in near-by radio receivers. These oscillations are caused by the development of a very steep wave front at the instant conduction begins in each rectifier unit, and may be propagated along internal circuit wiring and external power lines or radiated directly by the tubes. In a receiver, rectifier "hash" can usually be identified as a broadly tunable signal modulated at the rectifier "ripple" frequency. (The "ripple" frequency is equal to the power-line frequency times the number of half-wave rectifier units conducting independently.)

In some cases, this type of interference can be minimized by the use of very short leads to the rectifier anodes. It is usually necessary, however, to determine whether the interference is transmitted by radiation or by conduction, and to select the most effective method for its elimination by experiment. Radiation of such interference can usually be

minimized by shields of the type used to protect rectifier tubes against external fields. The transfer of such interference to a power line can be minimized by the insertion of a low-pass inductance-capacitance filter in the input circuit of the rectifier, as shown in Fig. 55, or by the use of filament and high-voltage supply

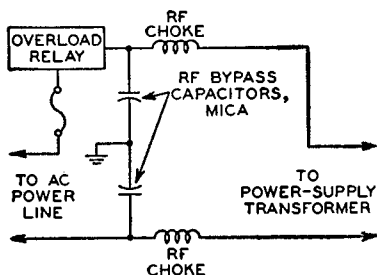

Fig. 55

transformers having electrostatic shields between primary and secondary windings. Low-pass filters of the type shown in Fig. 56 are also useful. The bypass capacitors used in such filters must have a voltage rating at least equal to the peak voltage developed across each half of the transformer secondary (approximately 1.4 times the rms voltage).

Rectifier tubes operated in circuits in which peak inverse voltages are 16000 volts or higher produce X-rays. Because

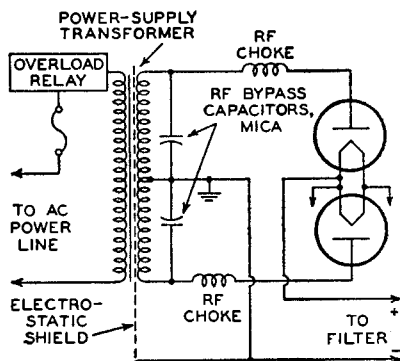

Fig. 56

these rays constitute a serious health hazard, tubes operated in such circuits should be equipped with shielding designed to absorb X-ray radiation.

RCA mercury-vapor and inert-gas rectifier tubes are equipped with internal cathode shields. These shields are

connected to a filament or heater terminal designated as the "cathode-shield" or "anode-return" terminal. When two or more gas-rectifier tubes are operated from a common filament or heater supply, the cathode-shield or anode-return terminals of the tubes must be connected to the same side of the supply.

### Tube Ratings

Rectifier-tube ratings usually include maximum permissible values for peak inverse anode voltage, peak anode current, average anode current, and fault anode current. Before these ratings are defined and their application to rectifier circuit design is discussed, it is desirable to define certain other terms frequently used in connection with rectifiers.

**Forward voltage** is voltage applied between the anode and cathode in the direction in which the tube is designed to pass current, *i.e.*, anode positive with respect to cathode. **Inverse voltage** is voltage applied between the anode and cathode in the direction opposite to that in which the tube is designed to pass current, *i.e.*, anode negative with respect to cathode.

**Forward current** is current flowing through a rectifier as a result of the application of a forward voltage. **Reverse current** is current flowing through a rectifier in the direction opposite to that of normal conduction. The flow of reverse current in a rectifier is an abnormal condition.

**Peak inverse anode voltage** is the highest instantaneous voltage applied between the anode and cathode during the fraction of any input cycle when the tube is normally not conducting. A maximum peak-inverse-voltage rating indicates the highest value this voltage may attain without danger of arc-back in the tube, electrolysis of glass, and reduced tube life.

**Peak anode current** is the highest instantaneous value reached by the forward current during the normal conduction interval. A maximum peak-anode-current rating indicates the highest current the tube can safely conduct during this interval. The peak current is determined by the duration of the conduction interval and, therefore, depends on the

type of rectifier circuit in which the tube is employed.

**Average anode current** is the value obtained by integrating the instantaneous anode currents of a rectifier tube over a specified time and averaging the result. A maximum average-anode-current rating indicates the highest average current that should be permitted to flow through the tube in the direction of normal conduction. This current may be measured by means of a dc meter inserted in the anode circuit of the tube. When the rectifier load is constant, the average anode current may be read directly on the meter. When the rectifier load is varying, the meter readings should be averaged over the period specified in the tube data (usually 15 to 30 seconds).

**Fault anode current** is the highest current flowing through a rectifier tube in the forward direction under abnormal or fault conditions, *e.g.*, during a load short circuit or an arc-back in an associated tube. A maximum fault-current rating indicates the highest current that should be permitted to flow through the tube in the direction of normal conduction over a period not exceeding 0.1 second under fault conditions. Rectifier circuits should be designed to limit fault currents to values within the maximum ratings because even a single fault current of the maximum value will materially shorten or terminate the life of the tube.

Rectifier tubes of the same type can be connected in parallel to provide increased output current. When mercury-vapor or inert-gas types are operated in parallel, it is necessary to employ a resistor or a small inductance in the anode circuit of each tube to assure equal division of the total load current. Stabilizing resistors for high-voltage circuits should produce an average voltage drop of not less than 50 volts. Stabilizing inductors should have a value of approximately one-sixth henry each for a supply frequency of 50 to 60 cycles per second. Stabilizing inductors are generally preferable to resistors because they minimize power losses and help to limit the peak anode currents in the tubes. Center-tapped inductors (interphase reactors) can be used as stabilizing elements

for pairs of parallel tubes. These inductors assure simultaneous starting as well as equal division of current. Vacuum rectifier tubes do not generally require the use of stabilizing devices when operated in parallel.

Corresponding filament terminals of mercury-vapor or inert-gas rectifiers operated in parallel must be connected together. Failure to observe this precaution will seriously unbalance the voltage drops in the paralleled tubes and may make it necessary to use undesirably high stabilizing impedances.

### Circuits

The most suitable type of rectifier circuit for a particular application depends on the dc voltage and current requirements, the amount of rectifier "ripple" that can be tolerated in the output, and the type of ac power available.

The half-wave single-phase circuit shown in Fig. 57 delivers only one pulse of current for each cycle of the ac input

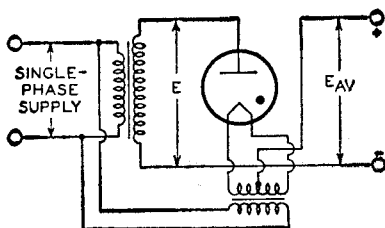

Fig. 57

voltage. Because its output contains a very high percentage of ripple, this type of circuit is used principally in low-voltage, high-current applications (*e.g.*, in power supplies for ac/dc receivers) and in low-current, high-voltage applications (*e.g.*, in ultor-voltage supplies for kinescopes and other types of cathode-ray tubes).

A full-wave single-phase circuit using two half-wave rectifier tubes is shown in Fig. 58, and a series single-phase circuit in Fig. 59. Although the bridge circuit requires four half-wave rectifier tubes and three filament transformers (or three independent filament windings), it can deliver twice as much output voltage as the two-tube circuit for the same anode-transformer voltage, and does not require a center-tapped high-voltage winding.

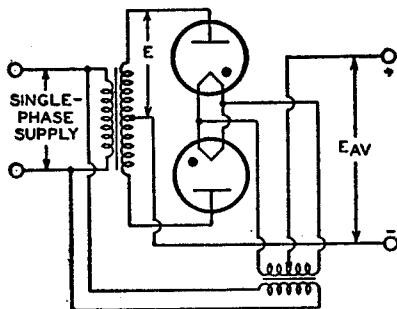

Fig. 58

Fig. 60 shows a half-wave three-phase circuit using three rectifier tubes. This circuit delivers three current pulses per cycle and its output, therefore,

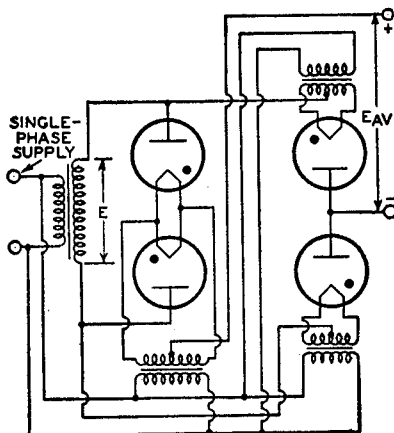

Fig. 59

contains a smaller percentage of ripple than that of a full-wave single-phase circuit. The parallel three-phase circuit employing six half-wave rectifier tubes

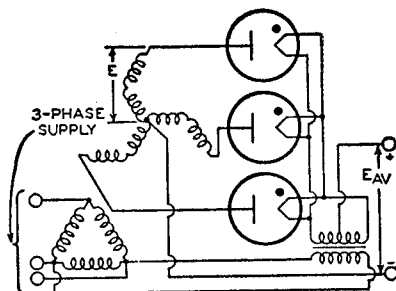

Fig. 60

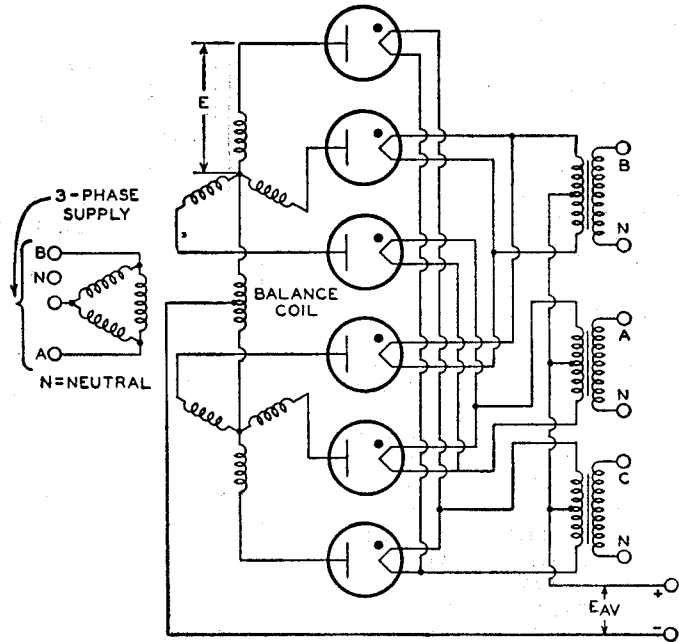

Fig. 61

shown in Fig. 61 delivers six current pulses per cycle. This circuit delivers twice as much output current as the circuit shown in Fig. 60 for the same average anode current per tube. The balance coil used in this circuit assures equal division of the load current and proper phasing in (or simultaneous starting of) the parallel branches.

In the series three-phase circuit shown in Fig. 62, two half-wave rectifier tubes are connected in series across each leg of the high-voltage transformer. This circuit delivers twice as much output voltage as the half-wave three-phase circuit shown in Fig. 60 for the same transformer voltage and peak inverse voltage per tube. Figs. 63 and 64 show

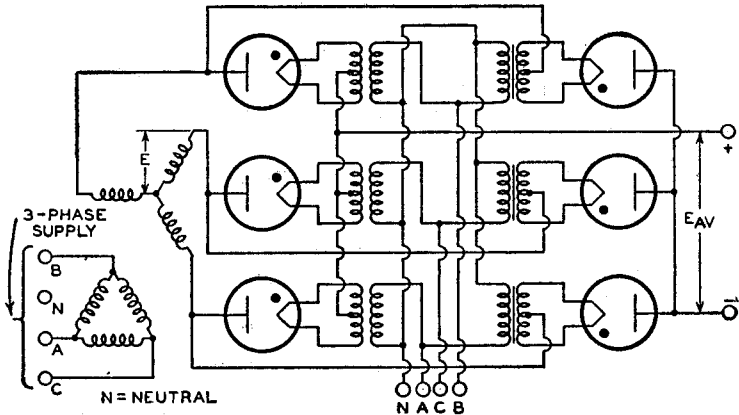

Fig. 62

half-wave four-phase and six-phase circuits, respectively.

### Quadrature Operation

The filament current of a rectifier tube is composed of two components: the normal heating current supplied by the filament transformer, and the anode current, the greater part of which flows through the most negative portion of the filament. When the filament-supply voltage and anode voltage of a rectifier are in phase (the normal relationship when both voltages are obtained from the same ac supply line), the two components of the filament current reach peak value simultaneously during each conduction interval, and cause a localized increase in filament temperature which may seriously shorten the life of the tube.

In single-phase rectifier circuits, which have a conduction interval per tube of 180 degrees, the ratio of peak anode current to peak filament-supply current is relatively small and the effects of "in-phase" operation are usually negligible. In polyphase rectifier circuits having conduction intervals per tube of 120 degrees or less, however, the ratio of peak anode current to peak filament-supply current is relatively large, and

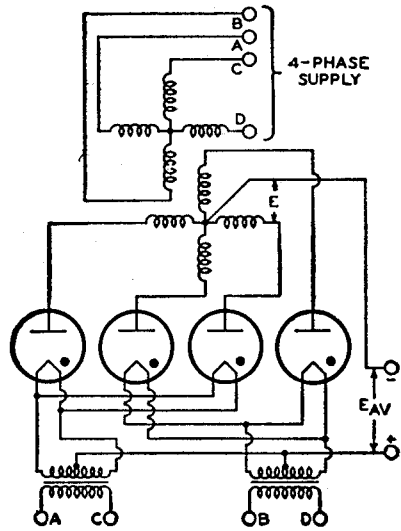

Fig. 63

the use of in-phase filament and anode voltages may result in extremely short tube life.

This difficulty can be minimized by the use of "Quadrature Operation." In this method of operation, the peak value of the total filament current is minimized

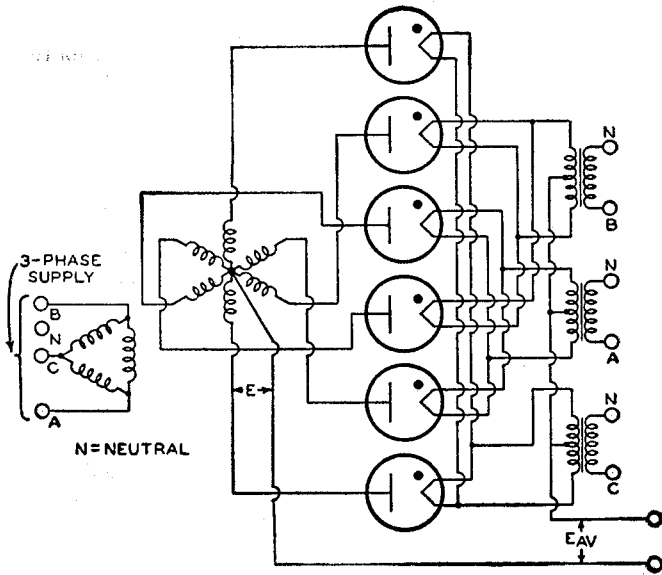

Fig. 64

by supplying the filament of each rectifier tube with voltage out of phase with its anode voltage. Although the ideal phase relationship between filament-supply voltage and anode voltage is 90 degrees (true "Quadrature"), substantial benefits are also realized at phase angles of 60 or 120 degrees, which are readily obtainable in three-phase and six-phase rectifier circuits.

Table IV gives the voltage, frequency, current, and power ratios for the basic rectifier circuits shown in Figs. 57 through 64. These ratios apply for sinusoidal ac input voltages. Current and power ratios given for inductive loads apply only when a filter choke is

used between the output of the rectifier and any capacitor in the filter circuit. This table does not take into consideration voltage drops which occur in the power transformer, the rectifier tubes, or the filter components under load conditions. When a particular tube type has been selected for use in a specific rectifier circuit, the ratios given in Table IV can be used in conjunction with the tube data to determine the parameters and characteristics of the circuit.

### Example of the Use of Table IV

**Problem.** Select the most suitable type of rectifier tube for use in a full-wave single-phase circuit which must de-

TABLE IV

RATIO	Fig. 57	Fig. 58	Fig. 59	Fig. 60	Fig. 61*	Fig. 62	Fig. 63	Fig. 64
<b>Voltage Ratios</b>								
$E/E_{av}$	2.22	1.11	1.11	0.854	0.854	0.427	0.785	0.74
$E_{bmi}/E$	1.41	2.83	1.41	2.45	2.45	2.45	2.83	2.83
$E_{bmi}/E_{av}$	3.14	3.14	1.57	2.09	2.09	1.05	2.22	2.09
$E_m/E_{av}$	3.14	1.57	1.57	1.21	1.05	1.05	1.11	1.05
$E_r/E_{av}$	1.11	0.472	0.472	0.177	0.04	0.04	0.094	0.04
<b>Frequency Ratio</b>								
$f_r/f$	1	2	2	3	6	6	4	6
<b>Current Ratios</b>								
$I_b/I_{av}$	1	0.5	0.5	0.33	0.167	0.33	0.25	0.167
<i>Resistive Load</i>								
$I_p/I_{av}$	1.57	0.785	0.785	0.587	0.294	0.587	0.503	0.408
$I_{pm}/I_{av}$	3.14	1.57	1.57	1.21	0.52	1.05	1.11	1.05
$I_{pm}/I_b$	3.14	3.14	3.14	3.63	3.14	3.14	4.5	6.3
<i>Inductive Load</i> ■								
$I_p/I_{av}$	-	0.707	0.707	0.577	0.289	0.577	0.500	0.408
$I_{pm}/I_{av}$	-	1	1	1	0.5	1	1	1
<b>Power Ratios</b>								
<i>Resistive Load</i>								
$P_{as}/P_{dc}$	3.49	1.74	1.24	-	-	-	-	-
$P_{ap}/P_{dc}$	2.69	1.23	1.24	-	-	-	-	-
$P_{al}/P_{dc}$	2.69	1.23	1.24	-	-	-	-	-
<i>Inductive Load</i> ■								
$P_{as}/P_{dc}$	-	1.57	1.11	1.71	1.48	1.05	1.57	1.81
$P_{ap}/P_{dc}$	-	1.11	1.11	1.21	1.05	1.05	1.11	1.29
$P_{al}/P_{dc}$	-	1.11	1.11	1.21	1.05	1.05	1.11	1.05

\* Bleeder current of 2-per-cent full-load current will provide exciting current for balance coil and thus avoid poor regulation at light loading.

■ The use of a large filter-input choke is assumed.

$E$  = transformer secondary voltage (rms)  
 $E_{av}$  = average dc output voltage  
 $E_{bmi}$  = peak inverse anode voltage  
 $E_m$  = peak dc output voltage  
 $E_r$  = major ripple voltage (rms)  
 $I_{av}$  = average dc output current  
 $I_b$  = average anode current  
 $I_p$  = anode current (rms)

$I_{pm}$  = peak anode current  
 $f$  = supply frequency  
 $f_r$  = major ripple frequency  
 $P_{al}$  = line volt-amperes  
 $P_{ap}$  = transformer primary volt-amperes  
 $P_{as}$  = transformer secondary volt-amperes  
 $P_{dc}$  = dc power ( $E_{av} \times I_{av}$ )

**Note:** Conditions assumed include sine-wave supply, zero voltage drop in tubes, no losses in transformer and circuit, no back emf in the load circuit, and no phase-back.



liver a dc voltage ( $E_{av}$ ) of 2500 volts at an average dc current ( $I_{av}$ ) of 500 milliamperes to the input of a filter. Also determine the rms voltage ( $E$ ) that must be delivered by each half of the high-voltage transformer secondary winding.

**Procedure.** (1) Determine the maximum peak inverse anode voltage which each rectifier tube must withstand. From Table IV, the ratio of peak inverse voltage ( $E_{bml}$ ) to dc output voltage in single-phase full-wave circuits is 3.14.

$$E_{bml} = 3.14 \times 2500 = 7850 \text{ volts.}$$

(2) Determine the average anode current ( $I_b$ ) in each tube. From Table IV,  $I_b$  in a full-wave single-phase circuit is one-half the total dc output current.

$$I_b = 0.5 \times 500 = 250 \text{ milliamperes.}$$

(3) Select a tube having suitable voltage and current ratings from the *Application Tables* Section. The 866A, which has a maximum peak-inverse anode-voltage rating of 10000 volts and a maximum average-anode-current rating of 250 milliamperes, meets the requirements. (Although the 872A, which has a maximum peak-inverse anode-voltage rating of 10000 volts and a maximum average-anode-current rating of 1.25 amperes, would also be more satisfactory, the 866A is the more economical type for this application.)

(4) Determine the rms voltage ( $E$ ) which must be developed by each half of the high-voltage transformer secondary for the rectifier to deliver 2500 volts dc to the filter at the specified load current of 500 milliamperes under full-load conditions.

$$E = 1.11 \times (2500 + 15) = 2790 \text{ volts (1)}$$

The second term within the parentheses represents the voltage drop in the 866A. For exact calculation of  $E$ , the full-load voltage drop in one half of the high-voltage secondary winding must also be added to the values within the parentheses.

### Regulation

The voltage drops in filter-choke windings or current-limiting resistors which follow the rectifier, as well as those in the rectifier tubes and transformer windings, become a very important con-

sideration when a rectifier filter is required to supply a varying load. Except for the drop in a gas-tube rectifier, which is substantially constant at all anode-current values up to the maximum rating for the tube, these drops vary with load current and cause a corresponding variation in output voltage. This variation is known as the **voltage regulation** of the supply, and is usually expressed as the per-cent change in output voltage for load-current variations between zero and the maximum value. For example, a power supply which has a no-load output of 1000 volts and a full-load output of 900 volts has a voltage regulation of 10 per cent. The regulation of well-designed rectifier-type power supplies is usually 10 per cent or less.

For good voltage regulation, the voltage drops in all sections of the supply should be held to a minimum. Voltage drops can be minimized by the use of transformers and chokes having generous overload ratings and low-resistance windings, mercury-vapor or inert-gas rectifier tubes or vacuum types having close anode-cathode spacing, and choke-input filters employing "swinging" chokes of the proper value. In addition, a "bleeder" resistor drawing about 10 per cent of the total output current should be permanently connected across the output of the supply. Although this resistor reduces the maximum useful output current slightly, it prevents the output voltage from rising excessively when the external load is reduced, and thus improves regulation and provides a substantial measure of protection for the filter capacitors. It also discharges the filter capacitors when the equipment is switched off and thus minimizes shock hazards.

Good regulation is desirable even when substantially constant output voltage under varying load conditions is not a primary requirement. Because good regulation minimizes variations in the voltage across the output terminals of a power supply, its effect is similar to that obtained when a very large bypass capacitance is connected across the output of the supply, *i.e.*, the amount of ac ripple in the output is substantially reduced. The internal impedance of the supply is also reduced, so that there is less danger of undesirable coupling and feedback in

associated equipment when the supply is used for two or more stages.

### Filters

The filter employed to minimize ripple in the output of a rectifier may be either a choke-input or a capacitor-input type. Careful consideration must be given to the selection and design of the filter if the maximum ratings of the tubes are not to be exceeded.

One of the most important considerations in the choice and design of a filter is its effect on the peak current in the rectifier circuit, and particularly on the current surge which occurs when the rectifier circuit is turned on. The sudden application of anode voltage to a rectifier causes a sudden flow or surge of current. The maximum value of this current is determined by the instantaneous amplitude of the ac input voltage and the surge impedance of the rectifier circuit. If the rectifier output is shunted by a large capacitor, the surge impedance is low and, therefore, the surge current may reach dangerously high values. On the other hand, if a relatively large choke is connected between the rectifier and the first filter capacitor, the surge impedance is high, and the surge current usually does not exceed the normal peak current through the tubes.

**Choke-input filters** limit surge and normal peak currents and, therefore, make it possible to obtain maximum continuous dc output current from rectifier tubes under the operating conditions most favorable for long tube life. They also provide the best regulation and are especially recommended for use with rectifiers employing mercury-vapor and inert-gas tubes or vacuum tubes having closely spaced electrodes. An additional advantage of choke-input filters is that their performance can be predicted accurately by calculation.

**Capacitor-input filters** provide the highest dc output voltages obtainable from given transformers and rectifier-tube combinations. They cause high current surges when the circuit is turned on, however, and have poor voltage regulation. In addition, the dc load current obtainable from a given rectifier-tube-and-transformer combination is less when a capacitor-input filter is used

than when a choke-input filter is used.

When a capacitor-input filter is used, a current-limiting resistor should be connected between the rectifier tubes and the filter to limit current surges. The total resistance,  $R_t$ , required to limit the surge current to a safe value, including the effective resistance of the power-transformer secondary (or one half of the secondary of a full-wave transformer) is a function of the dc output voltage ( $E_{av}$ ) and the rated peak anode current ( $I_{pm}$ ) of the tube.

$$R_t = \frac{K \times E_{av}}{I_{pm}}$$

The factor  $K$  is equal to 3.14 for the circuit shown in Fig. 57, 1.57 for the circuits shown in Figs. 58 and 59, 1.21 for the circuit of Fig. 60, 1.11 for Fig. 63, and 1.05 for Figs. 62 and 64. The balance coil used in the circuit shown in Fig. 61 limits the peak anode current so that a limiting resistor is not needed. The current-limiting resistor may be short-circuited after the rectifier-filter system has been switched on to avoid a reduction in useful dc output voltage. The resistor must be employed, however, each time the circuit is switched on. Capacitor-input filters may be used in rectifier circuits employing mercury-vapor or inert-gas rectifier tubes only when a current-limiting resistor is used as described above.

### Design of Choke-Input Filters

The filter-design charts shown in Figs. 65 and 66 permit quick determination of inductance and capacitance values for choke-input filters for use with full-wave single-phase rectifier circuits operating from 60-cycle supplies. For other supply frequencies, the inductance and capacitance values indicated by these charts should be multiplied by the ratio  $60/f$ , where  $f$  is the supply frequency used.

The chart shown in Fig. 65 is used to determine component values for single-section choke-input filters or for the first section of a multisection choke-input filter. Single-section and double-section choke input filters are shown in Fig. 67. The  $R_L$  curves in Fig. 65 are used to determine the minimum value of choke inductance required. The equivalent load resistance ( $R_L'$ ) in ohms is equal to the dc output voltage ( $E_{av}$ ) of the rectifier in volts divided by the load current ( $I_b$ )

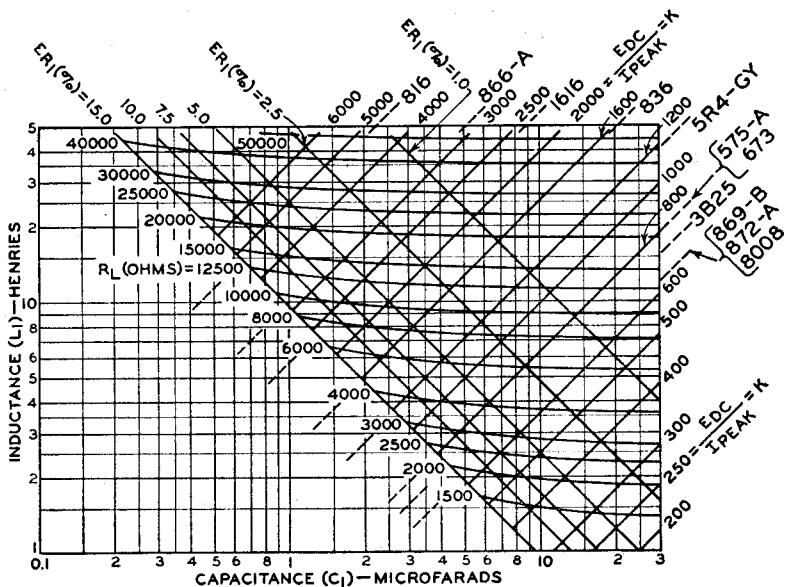

Fig. 65

in amperes. A dc output voltage equal to 90 per cent of the rms voltage ( $E$ ) per rectifier-tube anode is used in this calculation (from Table IV,  $E/E_{av} = 1.11$ ). This value does not include the voltage drops in the power transformer, filter choke, or rectifier tubes. The load current used must assure operation of each rectifier tube within its maximum average-anode-current rating. Inductance and capacitance values must always lie in the region of the chart above the applicable  $R_L$  curve.

The  $K$  curves in Fig. 65 indicate combinations of minimum filter inductance ( $L_1$ ) and maximum filter capacitance ( $C_1$ ) which will keep the peak anode currents ( $I_{pm}$ ) of the rectifier tubes within their maximum ratings at a given rms anode voltage. The factor  $K$  is equal to the dc voltage from the rectifier tubes at the input to the filter (in volts) divided by the maximum peak-anode-current rating of the rectifier tubes (per anode, in amperes). The  $K$  curves shown in Fig. 65 represent the following relation:

$$L_1 = C_1 \times (K/1000)$$

Filter component values must always lie in the region of the chart to the left of the proper  $K$  line.

When a particular rectifier tube is

used at its maximum peak-inverse-anode-voltage rating and maximum peak-anode-current ratings simultaneously, the applicable  $K$  line may be determined directly by placing a ruler across the appropriate pair of dashed lines shown in Fig. 65. When a tube is used at voltages below its maximum peak-inverse anode-voltage rating, a lower value of  $K$  determined from the above equation must be used.

The  $R_L$  and  $K$  curves, therefore, indicate limiting values of inductance and capacitance which will assure that average and peak anode-current ratings of the rectifier tubes will not be exceeded. Filter-component values can now be chosen within the wedge-shaped portion of the chart outlined by the appropriate  $R_L$  and  $K$  curves on or above the  $E_{R1}$  line for the maximum percentage of ripple which can be tolerated in the output of the filter section.

In power supplies for cw transmitters, a ripple of not more than 5 per cent is usually satisfactory. Power supplies for variable-frequency oscillators and phone transmitters generally should have ripple of 0.25 per cent or less. Power-supply ripple in high-gain speech amplifiers and receivers should not exceed

0.1 per cent to prevent hum modulation of output signals.

The most economical method of obtaining ripple voltages below 1 per cent

should always be greater than

$$\frac{3 \times (C_1 + C_2)}{2 \times (C_1 \times C_2)}$$

For applications in which the load resistance ( $R_L$ ) varies over a wide range, some means should be used to limit the resulting variation in output voltage. A bleeder resistor may be inserted across the filter output to restrict the range over which the effective load varies or an input choke having an inductance determined by the maximum load resistance attained may be used. The most economical method for minimizing output-voltage variations, however, is by the use of a "swinging" input choke.

The inductance of a well-designed swinging choke varies inversely with load current. The required minimum and maximum inductance for the choke can be determined from Fig. 65 at the intersections of the appropriate K curve with the curves for maximum and minimum  $R_L$ . It is generally most economical to select low values of swinging-choke inductance and obtain the required smoothing by the use of additional filter sections employing non-swinging ("smoothing") chokes.

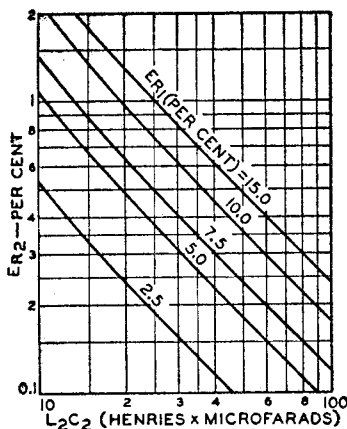

Fig. 66

is by the use of double-section filters of the type shown in Fig. 67(b). Values of  $L_2$  and  $C_2$  for the second section of such filters are determined from the chart shown in Fig. 66. After the value of  $E_{R1}$  for the first section is determined, the values of  $L_2$  and  $C_2$  (as a product) for any desired ripple percentage  $E_{R2}$  at the output of the second filter section may be determined from the appropriate  $E_{R1}$  curve in Fig. 66. Although any values of inductance and capacitance having the indicated product  $L_2 \times C_2$  will provide

### Examples of Filter Design

#### Single-Section Filter

**Problem:** A full-wave rectifier operating from a 60-cycle source and employing two 872-A mercury-vapor tubes has a dc output voltage of 3200 volts. Design a single-section choke-input filter which will (a) limit output ripple to 5 per cent at a load current equal to the combined maximum dc load-current ratings of the tubes ( $2 \times 1.25 = 2.5$  amperes); (b) keep the peak anode current of each tube within its maximum peak-anode-current rating (5 amperes).

**Procedure:**  $R_L = 3200 / 2.5 = 1280$  ohms. The value  $K = 3200 / 5 = 640$ . The curve for  $K = 640$  in Fig. 62 would lie between the curves for  $K = 600$  and  $K = 800$  and, consequently, would be above the position where the curve for  $R_L = 1270$  would be shown. Therefore, any combination of inductance and capacitance along the curve  $E_{R1} = 5$  per cent to the left of  $K = 640$  will satisfy the requirements. A 5-henry choke and a 5-microfarad capacitor would be a

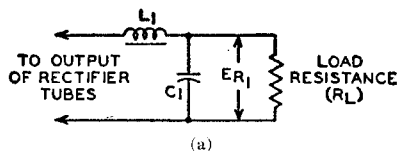

(a)

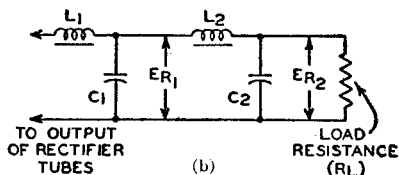

(b)

Fig. 67

the desired filtering, serious instability may result if the combination selected is resonant at or near the ripple frequency. The inductance of  $L_2$ , therefore,

suitable combination.

*Two-Section Filter*

**Problem:** A 60-cycle full-wave rectifier employing two 866-A mercury-vapor tubes delivers 2500 volts dc at full load to the input terminals of the filter. Design a two-section filter which will (a) limit the output ripple to 0.5 per cent at a load current equal to the combined maximum dc load-current ratings of the tubes ( $2 \times 0.25 = 0.5$  ampere); (b) keep the peak anode current of each tube within its maximum peak-anode-current rating (1.0 ampere). Because the voltage regulation must be good from no load to full load, the input choke shall be of the "swinging" type.

**Procedure:** At maximum load,  $R_L = 2500/0.5 = 5000$  ohms.  $K = (2500 \times 1.11)/1.0 = 2775$ . Because the curve in Fig. 62 for  $R_L = 5000$  ohms would be completely below the curve for  $K = 2775$ , the maximum-load value of  $R_L$  (minimum  $R_L$ ) need not be considered in the selection of constants for the first filter section. If an  $E_{R1}$  of 10 per cent at the output of the first filter section is assumed to be satisfactory, the minimum swinging-choke inductance and the corresponding value for the first-section filter capacitor are selected along the curve  $E_{R1} = 10$  per cent to the left of the curve for  $K = 2775$ . Suitable values would be  $L_1 = 13.5$  henries and  $C_1 = 1$  microfarad. The maximum inductance of the swinging choke should be as high as practical. If a maximum value of 25 hen-

ries is chosen, the minimum-load value of  $R_L$  (maximum  $R_L$ ) at which the regulating action of the choke will be effective is indicated by the point at which the 1-microfarad line intersects the line for 25 henries. This point corresponds to an  $R_L$  of 26000 ohms. Therefore, a bleeder having a resistance of not more than 26000 ohms should be used to prevent the dc output voltage from rising excessively when the load is removed. The bleeder draws a current of  $2500/26000$ , or 0.096 ampere, and is required to dissipate  $2500 \times 0.096$ , or 240 watts. Because the maximum average current which can be supplied by two 866-A's in a full-wave circuit is 0.5 ampere, the useful load current available from the rectifier filter combination is  $0.500 - 0.096 = 0.404$  ampere, or 404 milliamperes.

The second filter section ( $L_2C_2$ ) must reduce the ripple from the value of 10 per cent at the output of the first filter section to a value of 0.5 per cent. From Fig. 66, the value of the product  $L_2C_2$  at the intersection of the curve for  $E_{R1} = 10$  per cent with the line for  $E_{R2} = 0.5$  per cent is 37. If  $C_2$  is chosen to be 2 microfarads, then  $L_2$  should have an inductance of 18.5 henries. The value chosen for  $L_2$  should be checked to determine whether resonance effects will be present, *i.e.*,  $L_2$  should be equal to, or greater than,  $3 \times (1+2)/[2 \times (1 \times 2)] = 9/4 = 2.25$ . Because the value of 18.5 henries selected for  $L_2$  is considerably greater than 2.25, the filter design is satisfactory.

# Interpretation of Tube Data

The tube data given in the *Tube Types* Section include maximum ratings, typical operation values, characteristics, and characteristics curves.

A maximum rating, as applied to a tube, is a limit on a particular operating parameter (such as voltage, current, temperature, or frequency) or on a combination of parameters. Operation above these maximum ratings may not only impair the performance of a tube but also shorten its life considerably.

RCA power tubes may carry as many as three different kinds of ratings, based on operating conditions encountered in different types of service. The three general types of service may be defined as follows:

**Continuous Commercial Service (CCS)** covers applications involving continuous tube operation in which maximum dependability and long tube life are the primary considerations.

**Intermittent Commercial and Amateur Service (ICAS)** covers applications in which high tube output is a more important consideration than long tube life. The term "Intermittent Commercial" in this title applies to types of service in which the operating or "on" periods do not exceed 5 minutes each, and are followed by "off" or stand-by periods of the same or greater duration. The term "Amateur Service" covers other applications where operation is of an infrequent or highly intermittent nature, as well as the use of tubes in "amateur" transmitters. ICAS ratings generally are considerably higher than CCS ratings. Although the ability of a tube to produce greater output power is usually accompanied by a reduction in tube life, the equipment designer may decide that a small tube operated at its ICAS ratings meets his requirements better than a larger tube operated within CCS ratings.

**Intermittent Mobile Service (IMS)** covers applications in which very high power output for short periods is required from equipment of the smallest practical size and weight. Tube ratings for IMS service are based on the premise that transmitter "on" periods do not exceed 15 seconds each, and are followed by "off" periods of at least 60

seconds duration. In equipment tests, however, maximum "on" periods of not more than 5 minutes each followed by "off" periods of at least 5 minutes are permissible, provided the total "on" time of such test periods does not exceed 10 hours during the life of the tube. Although tubes operated under IMS ratings may have a life of only about 100 hours, the use of these ratings is economically justified where high power must be obtained intermittently from very small tubes.

Each maximum rating of a tube must be considered with respect to all other ratings given for that tube, so that the use of any one maximum rating will not cause any other maximum rating to be exceeded. For example, if the product of the maximum plate-voltage and maximum plate-current ratings exceeds the maximum permissible dc plate input, then either the plate voltage or the plate current, or both, must be reduced. As an illustration, the maximum CCS ratings for Class C Telegraphy operation of type 812-A are: plate volts, 1250 *max*; plate milliamperes, 175 *max*; plate input, 175 watts *max*. It is apparent that when the maximum plate voltage of 1250 volts is used, the dc plate current must be reduced to 140 milliamperes or less if operation is to be within the 175-watt maximum plate-input rating. On the other hand, if the maximum plate current of 175 milliamperes is to be used, it will be necessary to reduce the plate voltage to 1000 volts or less to avoid exceeding the 175-watt maximum input rating.

The tube ratings given in this Manual are "Absolute Maximum" ratings, unless otherwise indicated. The equipment designer must select operating values which are sufficiently below these absolute-maximum ratings so that no rating will ever be exceeded under any usual condition of supply-voltage variation, load variation, or manufacturing variation in the equipment itself.

A few of the low-power tubes listed in this Manual are rated under the "Design-Center" system. This system, which is used principally for tubes intended for home-instrument applica-

tions, is designed to provide satisfactory average performance in the greatest number of equipments on the premise that they will not be adjusted to local power-supply conditions at time of installation. Equipment for use on ac or dc power lines should be designed so that the design-center maximum values are not exceeded at a line-voltage-center value of 117 volts. In equipment designed for use with storage-battery-with-charger supply or similar supplies, plate voltages, screen-grid supply voltages, dissipations, and rectifier output currents should never exceed 90 per cent of the design-center maximum ratings for a terminal potential at the battery source of 2.2 volts per cell. Equipment for use with "B" batteries should be designed so that under no condition of battery voltage will the plate voltages, screen-grid supply voltages, or dissipations ever exceed the maximum rated values by more than 10 per cent.

In general, tubes are rated at the most severe conditions in a given service. For example, class C telegraphy ratings assume key-down conditions (per tube) without amplitude modulation; class C telephony ratings are established with fully modulated carrier conditions (per tube).

Values shown in tube data under "Typical Operation" should not be interpreted as ratings. These values represent operating conditions within the maximum ratings of a tube that are suitable for a particular application, and do not imply that the tube cannot be operated satisfactorily under other conditions in the same application. The choice of the most suitable tube operating conditions for any particular application should be based on a careful consideration of all pertinent factors.

The values for grid-bias voltages, other electrode voltages, and electrode supply voltages are given with reference to a specified datum point as follows: For tube types having filaments heated with dc, the negative filament terminal is taken as the datum point to which other electrode voltages are referred. For types having filaments heated with ac, the filament mid-point (*i.e.*, the center tap on the filament-transformer secondary, or the mid-point on a resistor shunt-

ing the filament) is taken as the datum point. For types having indirectly heated unipotential cathodes, the cathode is taken as the datum point.

Electrode voltage and current ratings are in general self-explanatory, but a brief explanation of other ratings will aid in the understanding and interpretation of tube data.

**Plate Input** is the total power supplied to the plate. It is the product of the dc plate voltage ( $E_b$ ) and the direct current flowing in the plate circuit ( $I_b$ ).

**Plate Dissipation** is the power lost in the form of heat as a result of electron bombardment of the plate. It is the difference between the power supplied to the plate of the tube (plate input) and the power delivered by the tube to the load circuit.

**Tube Power Output** is the output obtainable from the tube itself and is equal to plate input minus plate dissipation. (The term **power output** is used in some publications.)

**Useful Power Output** is the output measured at the load of the output circuit. Values given in the data are for the stated conditions; actual values depend on the circuit efficiency, operating frequency, and other variable factors.

**Grid-No. 2 (Screen-Grid) Input** is the dc power supplied to the screen grid of a multigrid tube, and is the product of the screen-grid voltage and screen-grid current. This power is dissipated in the form of heat by the screen grid as a result of electron bombardment.

**Grid (or Grid-No. 1) Driving Power** is the actual signal-power input to the control grid plus the power lost in the bias supply. It is given by the formula  $W_d = 0.9 E_g I_c$ , where  $W_d$  is the grid driving power in watts,  $E_g$  is the peak signal voltage applied to the grid in volts, and  $I_c$  is the average grid current in amperes. This value does not include signal-power losses that occur in the tube, grid-tank circuit, socket, or wiring, or tube losses caused by electron transit-time effects (except where the value given in the tube data is for a specific operating frequency).

**Driver Power Output** is the useful power output of the driver stage or the power measured at the input to the grid

circuit of an amplifier. This value includes circuit losses and varies according to the frequency of operation and the circuit used.

**Peak Heater-Cathode Voltage** ratings are given only for tubes that have

separate cathode and heater terminals. These ratings indicate the highest instantaneous voltage that may be applied between a heater and cathode without breakdown of the insulation between these electrodes.



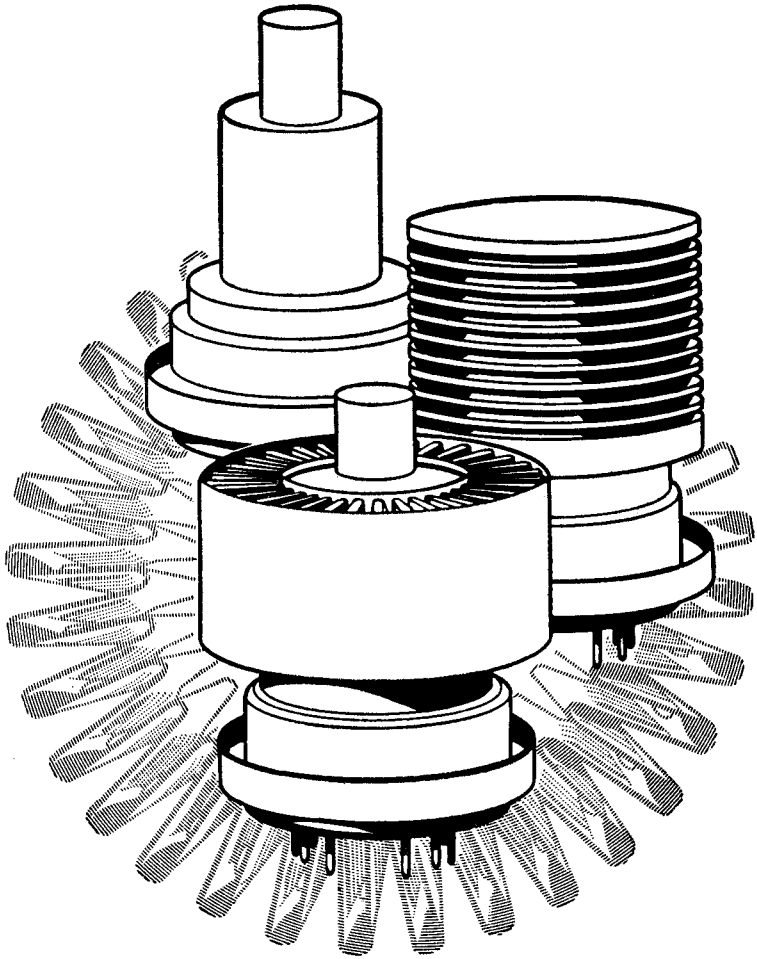

### POWER TUBE COOLING DESIGNS

**EFFICIENT COOLING** is the key to the development of reliable power tubes. Several cooling designs are shown above: (top) RCA-8072, conduction cooled; (center) RCA-8121, and (bottom) RCA-8122, both forced-air cooled. In the background is fin-type, high-efficiency integral radiator used in the 8122.

# Application Tables

The tables in this section are intended to aid in the selection of transmitting tubes for specific applications. Tube types have been classified according to the principal services for which they are rated, but are not necessarily limited to the applications listed. The tube types, together with their ratings and characteristics of primary interest, are listed in each category in order of increasing power output (except Tables

6 and 7). Tubes whose type numbers are printed in bold type are suggested for new equipment design. *Unless otherwise noted*, the ratings given are based on the **absolute maximum** system.

After suitable tube types are selected from the appropriate tables, the final choice should be based on the complete ratings for the types under consideration, as given in the *Tube Types—Technical Data* Section.

## SERVICE APPLICATIONS

- |   |  |
|---|--|
| 1. AF Power Amplifier and Modulator Service       | Sideband Suppressed Carrier, Two-Tone Modulation   |
| 2. Plate-Modulated RF Amplifier—Class C Telephony | 5. Plate- or Grid-pulsed Amplifiers or Oscillators |
| 3. RF Amplifier Service—Class C Telegraphy        | 6. Special Services                                |
| 4. Linear RF Amplifier Service—Single-            | 7. Rectifier Tubes                                 |

### 1. Power Tubes for AF Power Amplifier and Modulator Service

Power Output (Typical)	Cooling <sup>1</sup>	Filament or Heater	Maximum Plate Input	Ratings <sup>2</sup> Dissipation	Kind <sup>3</sup> of Tube	RCA TYPE NO.
Watts <sup>4</sup>		Volts	Volts	Watts	Watts	
<b>CLASS A AMPLIFIERS</b>						
2.7	N	6.3	275	—	825	BP 5686
26.5	N	6.3	375	40	21	BP 51614
<b>CLASS AB<sub>1</sub> AMPLIFIERS<sup>6</sup></b>						
20.5	N	12 to 15	300	21	10	BP 7551
20.5	N	6.3	300	21	10	BP 57558
44	N	6.3/12.6	750	100	30	BPBP 829B
80	FA	6.3	1000	180	115	C 6816
80	FA	26.5	1000	180	115	C 6884
80	FA	6.3	1000	180	115	CR 7457
80	C	6.3	1000	180	—	CR 7842
80	C	26.5	1000	180	—	C 7843
80	C	6.3	1000	180	—	C 7844
82	N	6.3	600	60	20	BP 56146
82	N	26.5	600	60	20	BP 56159
82	N	12.6	600	60	20	BP 56883
82	N	6.3	600	60	20	BPR 57212
82	N	26.5	600	60	20	BPR 57357
380	N	10	2250	360	100	BP 5813

### 1. Power Tubes for AF Power Amplifier and Modulator Service (Cont.)

Power Output (Typical)	Cooling <sup>1</sup>	Filament or Heater	Maximum Plate Input	Ratings <sup>2</sup>	Kind <sup>3</sup> of Tube	RCA TYPE NO.	
Watts <sup>4</sup>		Volts	Volts	Watts	Watts		
590	FA	6	2000	—	250	BP	} 7203/ 4CX250B
590	FA	26.5	2000	—	250	BP	
1600	FA	6.3	3000	1500	600	CR	} 7204/ 4CX250F 7650

#### CLASS AB<sub>2</sub> AMPLIFIERS<sup>6</sup>

42	N	6.3	400	30	10	BPQ	52E24
42	N	6.3	600	30	10	BP	52E26
42	N	12.6	600	30	10	BP	56893
80	N	6.3	600	60	25	BP	5807
80	N	12.6	600	60	25	BP	51625
90	N	6.3	600	62.5	20	BP	56146
90	N	26.5	600	62.5	20	BP	56159
90	N	12.6	600	62.5	20	BP	56883
90	N	6.3	600	62.5	20	BPR	57212
90	N	26.5	600	62.5	20	BPR	57357
140	FA	6.3	1000	180	115	C	6816
140	FA	26.5	1000	180	115	C	6884
140	FA	6.3	1000	180	115	CR	7457
140	C	6.3	1000	180	—	CR	7842
140	C	26.5	1000	180	—	C	7843
140	C	6.3	1000	180	—	C	7844

#### CLASS B AMPLIFIER<sup>6</sup>

10.4	N	6.3	300	—	3	TT	1635
235	N	6.3	1250	165	45	T	5811A
235	N	6.3	1250	165	45	T	5812A
1650	N	10	3000	1125	300	T	5833A
2400	FA	10	4000	1600	400	T	5833A

<sup>1</sup> Cooling: N, natural; FA, forced air; C, conduction.

<sup>2</sup> CCS, unless otherwise noted.

<sup>3</sup> Designations for kind of tube:

BP	Beam power	P	Pentode
BPQ	Quick-heating beam power	PP	Twin pentode
BPR	Ruggedized beam power	PT	Pencil triode
BPBP	Twin beam power	T	Triode
C	Cermolox	TT	Twin triode
CR	Ruggedized cermolox	T-P	Triode-pentode

<sup>4</sup> Approximate.

<sup>5</sup> ICAS ratings also shown in *Technical Data* Section.

<sup>6</sup> Typical power output for two tubes, except twin-unit types.

Except for types listed in Table 7 (*Rectifier Tubes*), tube type numbers in BOLD FACE are suggested for use in new equipment design.

**2. Power Tubes for Plate-Modulated RF Amplifier Service—Class C Telephony**

Typical Operation			Maximum Plate Ratings <sup>2</sup>					Kind <sup>3</sup> of Tube	RCA TYPE NO.
Power Output	Fre- quency	Cool- ing <sup>1</sup>	Filament or Heater	Max Freq for Full Input	DC Input	Dissi- pation			
Watts <sup>4</sup>	(at) Mc		Volts	Mc	Volts	Watts	Watts		
1.7	3000	C	12.6	—	750	45	—	C	7801
1.7	3000	C	6.3	—	750	45	—	C	7870
3.5	500	N	6.3/12.6	500	200	8	4	PP	56939
5.5	500	N	6	2000	260	8.5	5	PT	5893
6.4	30	N	6	—	250	10	8	BP	57663
6.4	30	N	13.5	—	250	10	8	BP	56417
6.5	175	N	6.3	175	250	15	7	BP	107095
6.5	175	N	6.3	175	250	15	7	BP	57558
6.5	175	N	12 to 15	175	250	15	7	BP	7551
6.7	500	N	6	500	275	9	5.5	PT	56263
6.7	500	N	6	500	275	9	5.5	PT	56263A
13.5	—	N	6.3	125	400	20	6.7	BPQ	52E24
13.5	—	N	6.3	125	400	20	6.7	BP	52E26
13.5	—	N	12.6	125	400	20	6.7	BP	56893
7 <sup>17</sup>	—	N	6.3/12.6	200	600	22	10	BPBP	5832A
17	400	C	12.6	—	750	45	—	C	7801
17	400	C	6.3	—	750	45	—	C	7870
28	—	N	6.3	60	475	40	16.5	BP	5807
28	—	N	12.6	60	475	40	16.5	BP	51625
34	—	N	6.3	60	480	45	13.3	BP	56146
34	—	N	26.5	60	480	45	13.3	BP	56159
34	—	N	12.6	60	480	45	13.3	BP	56883
34	60	N	6.3	60	480	45	13.3	BPR	57212
34	60	N	26.5	60	480	45	13.3	BPR	57357
45	400	FA	6.3	1215	800	120	75	C	6816
45	400	FA	26.5	1215	800	120	75	C	6884
45	400	FA	6.3	1215	800	120	75	CR	7457
45	400	C	6.3	1215	800	120	—	CR	7842
45	400	C	26.5	1215	800	120	—	C	7843
45	400	C	6.3	1215	800	120	—	C	7844
750	—	N	6.3/12.6	200	600	67.5	21	BPBP	5829B
770	—	FA	6.3/12.6	200	600	90	28	BPBP	5829B
85	—	N	6.3	30	1000	115	30	T	5812A
88	—	N	6.3	30	1000	115	30	T	5811A
120	900	FA	6.3	900	1300	270	167	T	6161
180	—	N	10	30	1600	240	67	BP	5813
235	175	FA	6	500	1500	—	165	BP	7203/ 4CX250B
235	175	FA	26.5	500	1500	—	165	BP	7204/ 4CX250F
600	400	FA	6.3	1215	2000	1000	400	CR	7650
635	—	N	10	30	2500	835	200	T	5833A
800	600	FA	5.5	1215	2000	1700	1000	C	7213
1000	—	FA	10	20	3000	1250	270	T	5833A

<sup>7</sup> Both sections.  
<sup>10</sup> ICAS ratings only.  
<sup>1</sup>, <sup>2</sup>, <sup>3</sup>, <sup>4</sup>, <sup>5</sup> See Table I.

## Application Tables

### 3. Power Tubes for RF Amplifier Service—Class C Telegraphy

Typical Operation			Maximum Plate Ratings <sup>2</sup>					Kind <sup>3</sup> of Tube	RCA TYPE NO.
Power Output	Fre- quency	Cool- ing <sup>1</sup>	Filament or Heater	Max. Freq. for Full Input	DC Input	Dissi- pation			
Watts <sup>4</sup>	(at) Mc		Volts	Mc	Volts	Watts	Watts		
<b>CLASS C AMPLIFIERS, RF TELEGRAPHY</b>									
1.2	10	N	1.4/2.8	—	150	3	2	P	83A4
1.4	1000	N	6.3	5000	250	—	2.5	PT	7554
2	—	N	1.4/2.8	—	135	2	1	TT	83A5
3.2	3000	C	12.6	—	750	52.5	—	C	7801
3.2	3000	C	6.3	—	750	52.5	—	C	7870
93.5	940	N	12-15	—	9300	—	92.75	T-P	7060
4	40	N	12-15	—	300	—	5	P	8077/ 7054
5	500	N	6.3	1700	360	9	6.25	PT	4037
5	500	N	6.3	1700	360	9	6.25	PT	5876
5	500	N	6.3	1700	360	9	6.25	PT	5876A
5	500	N	6.3/12.6	500	250	12	6	PP	56939
5.25	125	N	6.3	—	275	11	8.25	BP	5686
5.5	1000	N	6	2000	320	11	7	PT	55893
7	500	N	6	500	330	13.2	8	PT	56263
7	500	N	6	500	330	13.2	8	PT	56263A
7	175	N	6.3	175	300	18	10	BP	107095
7.5	500	N	6	500	320	13.2	8	PT	56264A
8.5	175	N	12/15	175	300	21	10	BP	7551
8.5	175	N	6.3	175	300	21	10	BP	57558
10.3	30	N	6	—	300	15	12	BP	55763
10.3	30	N	13.5	—	300	15	12	BP	56417
20	125	N	6.3	125	500	30	10	BPQ	52E24
20	125	N	6.3	125	500	30	10	BP	52E26
20	125	N	12.6	125	500	30	10	BP	56893
21	—	N	6.3	—	375	35	21	BP	51614
726	—	N	6.3/12.6	200	750	36	15	BPBP	5832A
27	400	C	12.6	—	750	52.5	—	C	7801
27	400	C	6.3	—	750	52.5	—	C	7870
30	175	N	6.3	60	750	90	25	BPQ	104604
40	—	N	6.3	60	600	60	25	BP	5807
40	—	N	12.6	60	600	60	25	BP	51625
40	1215	FA	6.3	1215	1000	180	115	C	6816
40	1215	FA	26.5	1215	1000	180	115	C	6884
40	1215	FA	6.3	1215	1000	180	115	CR	7457
40	1215	C	6.3	1215	1000	180	—	CR	7842
40	1215	C	26.5	1215	1000	180	—	C	7843
40	1215	C	6.3	1215	1000	180	—	C	7844
52	60	N	6.3	60	600	67.5	20	BP	56146
52	60	N	26.5	60	600	67.5	20	BP	56159
52	60	N	12.6	60	600	67.5	20	BP	56883

### 3. Power Tubes for RF Amplifier Service—Class C Telegraphy (Cont.)

Typical Operation			Filament or Heater	Max. Freq. for Full Input	Maximum Plate Ratings <sup>2</sup>		Kind <sup>3</sup> of Tube	RCA TYPE NO.
Power Output	Fre- quency	Cool- ing <sup>1</sup>			DC Input	Dissi- pation		
Watts <sup>4</sup>	(at) Mc		Volts	Mc	Volts	Watts	Watts	
52	60	N	6.3	60	600	67.5	20	BPR 57212
52	60	N	26.5	60	600	67.5	20	BPR 57357
770	—	N	6.3/12.6	200	750	90	30	BPBP 5829B
85	470	C	12-15	500	2200	660	—	BP 8072
90	—	FA	6.3/12.6	200	750	120	40	BPBP 5829B
130	—	N	6.3	30	1250	175	45	T 5812A
135	—	N	6.3	30	1250	175	45	T 5811A
180	900	FA	6.3	900	1600	400	250	T 6161
235	470	FA	13.5	500	2200	660	150	BP 8121
250	500	FA	6	500	2000	—	250	BP 7203/ 4CX250B
250	500	FA	26.5	500	2000	—	250	BP 7204/ 4CX250F
275	—	N	10	30	2000	360	100	BP 5813
300	470	FA	13.5	500	2200	660	400	BP 8122
375	1215	FA	6.3	1215	2500	1250	700	CR 7650
1000	—	N	10	30	3000	1250	300	T 5833A
1350	600	FA	5.5	1215	2500	2500	1500	C 7213
1440	—	FA	10	20	4000	1800	400	T 5833A

<sup>7</sup> Both sections.  
<sup>8</sup> Design Center values.  
<sup>9</sup> For pentode unit.  
<sup>10</sup> ICAS—ratings only.  
<sup>11</sup> 2, 3, 4, 5 See Table 1.

### 4. Power Tubes for Linear RF Amplifiers— Single-Sideband Suppressed-Carrier, Two-Tone Modulation

Typical Operation			Filament or Heater	Max. Freq. for Full Input	Maximum Plate Ratings <sup>2</sup>		Kind <sup>3</sup> of Tube	RCA TYPE NO.
Power <sup>12</sup> Output	Fre- quency	Cool- ing <sup>1</sup>			<sup>12</sup> DC Current	Dissi- pation		
Watts <sup>4</sup>	(at) Mc		Volts	Mc	Volts	Ma	Watts	
80	30	C	12-15	500	2200	450	—	BP 8072
120	30	N	6.3	30	1250	175	45	T 811A
170	30	FA	13.5	500	2200	450	150	BP 8121
295	30	FA	6	500	2000	250	250	BP 7203/ 4CX250B
295	30	FA	26.5	500	2000	250	250	BP 7204/ 4CX250F
360	500	FA	6	500	2000	350	250	BP 7580
380	30	FA	13.5	500	2200	450	400	BP 8122
680	30	FA	6.3	1215	2500	500	600	BP 7650

<sup>12</sup> Peak envelope.  
<sup>13</sup> 2, 3, 4 See Table 1.

### 5. Power Tubes for Plate- or Grid-Pulsed Amplifiers or Oscillators

Typical Operation							Maximum Plate Ratings <sup>2</sup>					
Power Output <sup>17</sup>	Pulse Duration	Duty Cycle	Frequency	Cooling <sup>1</sup>	Filament or Heater	Max. Frequency for Full Input	Peak Plate	Peak Plate	Maximum ON Time	Time Interval	Kind of Tube	RCA TYPE NO.
4kw	μsec		Mc		Volts	Mc	Volts	Amp.	μsec	μsec		

#### PLATE-PULSED AMPLIFIERS OR OSCILLATORS<sup>13</sup>

1.2	1	0.001	3300	N	6	4000	1750	3	5	5000	PT	5893
4.5	10	0.01	1215	FA	6.3	1215	3000	3	10	1000	RC	7649
14	5	0.01	1250	FA	6.3	1300	7500	4.5	10	1000	T	5946
39	10	0.01	1215	FA	6.3	1215	8000	9	10	1000	RC	7651
65	10	0.01	1215	FA	5.5	1215	10000	18	10	1000	C	7214

#### GRID-PULSED AMPLIFIERS OR OSCILLATORS<sup>13</sup>

2.3	10	0.01	1215	FA	6.3	1215	142250	3	10	1000	RC	7649
20	10	0.01	1215	FA	5.5	1215	145000	18	10	1000	C	7214
20	10	0.01	1215	FA	6.3	1215	145000	9	10	1000	RC	7651

<sup>13</sup> See *Technical Data Section* for exact classification in each case.

<sup>14</sup> DC Plate Volts.

<sup>17</sup> Peak.

<sup>1, 2, 3, 4</sup> see Table 1.

### 6. Power Tubes for Special Services

See *Technical Data Section* for further information on each type.

Service	RCA TYPE NO.
Balanced Modulator .....	7360
Class C Oscillator .....	4037, 5675, 6026
Control Amplifier .....	3C33
Frequency Multiplier .....	4037, 5763, 5876, 5876A, 5893, 6161, 6264A, 6562/5794A, 6939, 7551, 7554, 7558, 7905, 8077/7054
Integral-Cavity Oscillator .....	6562/5794A, 7533
Linear RF Power Amplifier—AM Telephony .....	7580
Low-Noise Class A Amplifier, RF .....	7552, 7553
Modulator—Rectangular-Wave Modulation .....	3E29, 6293, 7358
Pulse Detector .....	6173
Regulator .....	4600A

**7. Rectifier Tubes**

Filament Or Heater Volts	Maximum Plate Ratings <sup>5</sup>			RCA TYPE NO.
	Peak Inverse Volts	Peak Amperes	Average Amperes	
<b>HALF-WAVE, MERCURY-VAPOR TYPES:</b>				
2.5	7500	0.5	0.125	816
2.5	10000	1	0.25	J866A
2.5	2500	2	0.5	J866A
5	10000	5	1.25	872A, 8008
5	15000	6	1.5	575A, 673
5	20000	8.3	1.8	6894, 6895
5	<sup>16</sup> 15000	<sup>16</sup> 10	<sup>16</sup> 2.5	575A, 673
2.5	2000	10	2.5	615/7018
5	5000	15	2.5	5558
5	<sup>16</sup> 20000	<sup>16</sup> 11.5	<sup>16</sup> 2.5	6894, 6895
5	10000	16	4	5561
2.5	1000	77	6.4	635/7019
				635L/7020
5	3000	40	6.4	5561
<b>HALF-WAVE, GAS TYPES</b>				
2.5	10000	1	0.25	3B28
2.5	4500	2	0.5	3B25
2.5	5000	2	0.5	3B28
<b>HALF-WAVE, VACUUM TYPES</b>				
6.3	375	0.05	0.0055	6173
2.5	12500	0.06	0.0075	2X2A
2.5	5000	1	0.25	836
<b>FULL-WAVE, VACUUM TYPES</b>				
5	3100	0.715	0.147	5R4GYB
5	2800	0.650	0.175	5R4GY
<b>FULL-WAVE, MERCURY-VAPOR TYPES</b>				
5	1550	1	0.225	83
2.5	900	10	2.5	604/7014

<sup>16</sup> In-phase operation, unless otherwise noted.

<sup>18</sup> Quadrature operation.



# RCA Tube Types—Technical Data

This section contains technical descriptions of RCA tubes used in transmitting, industrial, and amateur equipment. It includes data for current types, as well as those RCA discontinued types in which there may still be some interest. Tubes in this section are listed according to the numerical-alphabetical-numerical sequence of their type designations.

Unless otherwise specified, the ratings given are based on the **absolute maximum** system. Class C Telegraphy ratings assume key-down conditions (per tube) without amplitude modulation. Class C Telephony ratings are established with fully modulated carrier conditions (per tube). For **Key to Base and Envelope Connection Diagrams**, see inside back cover.

For an explanation of the terms used in the descriptive data for tube types, reference should be made to the **Interpretation of Tube Data** Section. For assistance in making an initial selection of tube types suitable for specific applications, reference should be made to the **Application Tables** Section.

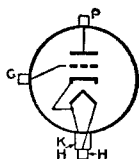

## UHF POWER TRIODE

# 2C39A

Forced-air-cooled type used as rf power amplifier, oscillator, and frequency multiplier. May be used at full input up to 2500 Mc and at higher frequencies in cathode-drive circuits of

the coaxial-cylinder type. Class C Telegraphy maximum CCS plate dissipation, 100 watts. Requires special mounting which should support the tube by the plate-terminal flange only. May be operated in any position. Flexible connectors of the spring-contact type are required for all terminal connections. **OUTLINE 85, Outlines Section.**

HEATER VOLTAGE (AC/DC) <sup>o</sup> .....	6.3	volts
HEATER CURRENT.....	1.0	ampere
TRANSCONDUCTANCE*.....	24000	μmhos
AMPLIFICATION FACTOR.....	100	
<b>DIRECT INTERELECTRODE CAPACITANCES:</b>		
Grid to plate.....	2	μμf
Grid to cathode and heater.....	6.6	μμf
Plate to cathode and heater.....	0.035 max	μμf
SEAL TEMPERATURE (Plate, grid, cathode, and heater).....	175 max	°C

<sup>o</sup> Because the cathode is subjected to considerable back bombardment as the frequency is increased with resultant increase in temperature, the heater voltage should be reduced depending on operating conditions and frequency to prevent overheating of the cathode and resultant short life.

\* Plate volts, 600; plate milliamperes, 70.

### PLATE-MODULATED RF POWER AMPLIFIER—Class C Telephony

#### Maximum CCS Ratings:

DC PLATE VOLTAGE.....	600•max	volts
GRID VOLTAGE:		
DC.....	-150 max	volts
Peak Negative RF.....	400 max	volts
Peak Positive RF.....	30 max	volts
DC GRID CURRENT.....	50 max	ma
DC CATHODE CURRENT.....	100 max	ma
GRID INPUT.....	2 max	watts
PLATE DISSIPATION.....	70 max	watts

• For use with a modulation factor of less than 1.0, it is permissible to use a higher dc plate voltage provided the sum of the peak positive modulation voltage and the dc plate voltage does not exceed 1200 volts.

### RF POWER AMPLIFIER AND OSCILLATOR—Class C Telephony

#### Maximum CCS Ratings:

DC PLATE VOLTAGE.....	1000 max	volts
-----------------------	----------	-------

**GRID VOLTAGE:**

DC .....	-150 <i>max</i>	volts
Peak Negative RF .....	400 <i>max</i>	volts
Peak Positive RF .....	30 <i>max</i>	volts
DC GRID CURRENT .....	50 <i>max</i>	ma
DC CATHODE CURRENT .....	125 <i>max</i>	ma
GRID INPUT .....	2 <i>max</i>	watts
PLATE DISSIPATION .....	100 <i>max</i>	watts

## POWER TRIODE

# 2C40 2C40A

Disk-seal lighthouse types used as rf power amplifier, cw oscillator, and plate-pulsed oscillator (2C40A only) at frequencies up to 3370 Mc. Class C Telegraphy maximum CCS plate dis-

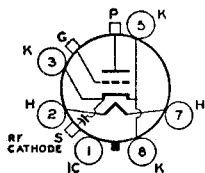

sipation, 6.5 watts. Requires Octal socket and may be operated in any position. OUTLINE 7, *Outlines* Section. The 2C40A is unilaterally interchangeable with type 2C40. Type 2C40 is used principally for renewal purposes. The RCA 4037 replaces the 2C40 in most applications.

HEATER VOLTAGE (AC/DC) .....	2C40	2C40A	
	6.3±5%	6.3±5%	volts
HEATER CURRENT .....	0.75	0.75	ampere
TRANSCONDUCTANCE* .....	4850	5100	μmhos
AMPLIFICATION FACTOR* .....	36	35	
<b>DIRECT INTERELECTRODE CAPACITANCES:</b>			
Grid to plate .....	1.3	1.3	μf
Grid to cathode .....	2.2	2.2	μf
Plate to cathode .....	0.03	0.03	μf
Cathode rf connection to cathode .....	100	100	μf
SEAL TEMPERATURE .....	175	175	°C

\* Plate supply volts, 250; cathode resistor, 200 ohms; plate ma., 17.

### RF POWER AMPLIFIER AND OSCILLATOR—CLASS C Telegraphy

**Maximum CCS Ratings:**

DC PLATE VOLTAGE .....	500 <i>max</i>	volts
DC GRID VOLTAGE .....	-50 <i>max</i>	volts
DC PLATE CURRENT .....	25 <i>max</i>	ma
DC GRID CURRENT .....	8 <i>max</i>	ma
PLATE DISSIPATION .....	6.5 <i>max</i>	watts
<b>PEAK HEATER-CATHODE VOLTAGE:</b>		
Heater negative with respect to cathode .....	90 <i>max</i>	volts
Heater positive with respect to cathode .....	90 <i>max</i>	volts

### PLATE-PULSED OSCILLATOR—Class C (2C40A only)

**Maximum Ratings:**

*For a maximum ON time\* of 10 microseconds*

PEAK PLATE VOLTAGE .....	1400 <i>max</i>	volts
PEAK GRID VOLTAGE .....	-100 <i>max</i>	volts
PEAK PLATE CURRENT .....	2 <i>max</i>	amperes
PEAK GRID CURRENT .....	1 <i>max</i>	amperes
DC PLATE CURRENT .....	3 <i>max</i>	ma
DC GRID CURRENT .....	1.5 <i>max</i>	ma
PLATE DISSIPATION .....	4 <i>max</i>	watts
DUTY FACTOR <sup>■</sup> .....	0.002 <i>max</i>	
PULSE DURATION .....	1.5 <i>max</i>	μsec
<b>PEAK HEATER-CATHODE VOLTAGE:</b>		
Heater negative with respect to cathode .....	90 <i>max</i>	volts
Heater positive with respect to cathode .....	90 <i>max</i>	volts

\* ON time for this tube is the sum of the durations of all the individual pulses which occur during any 5000-microsecond interval. Pulse duration is defined as the time interval between the two points on the pulse at which the instantaneous value is 70 per cent of the peak value. The peak value is defined as the maximum value of a smooth curve through the average of the fluctuations over the top portion of the pulse.

■ Duty factor is the product of pulse duration and repetition rate. For variable pulse durations and pulse repetition rates, the duty factor for this tube is defined as the ratio of time ON to total elapsed time in any 5000-microsecond interval.

## HIGH-MU TRIODE

# 2C43

Disk-seal lighthouse type used as rf power amplifier and cw oscillator at frequencies up to 1500 Mc. Class C Telegraphy maximum CCS plate dissipation, 12 watts. Requires Octal socket and may be operated in any position. OUTLINE 10, *Outlines* Section. The 2C43 is used principally for renewal purposes.

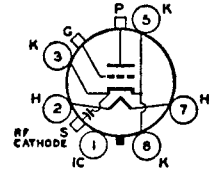

HEATER VOLTAGE (AC/DC).....	6.3 ±5%	volts
HEATER CURRENT.....	0.9	ampere
TRANSCONDUCTANCE*.....	8100	μmhos
AMPLIFICATION FACTOR*.....	50	
DIRECT INTERELECTRODE CAPACITANCES:		
Grid to plate.....	1.8	μf
Grid to cathode.....	3.0	μf
Plate to cathode.....	0.04 max	μf
Cathode rf connection to cathode.....	100	μf
SEAL TEMPERATURE.....	175 max	°C

\* Plate-supply volts, 250; cathode resistor, 100 ohms; plate milliamperes, 21.

### RF POWER AMPLIFIER AND OSCILLATOR—Class C Telegraphy

**Maximum CCS Ratings:**

DC PLATE VOLTAGE.....	500 max	volts
DC PLATE CURRENT.....	40 max	ma
DC CATHODE CURRENT.....	55 max	ma
PLATE DISSIPATION.....	12 max	watts

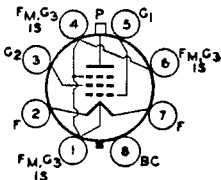

## BEAM POWER TUBE

Glass-octal type having quick-heating coated filament used as af power amplifier and modulator and as rf power amplifier and oscillator in mobile- and emergency-communications

# 2E24

equipment. May be used with full input up to 125 Mc and with reduced input up to 175 Mc. Class C Telegraphy maximum plate dissipation, CCS 10 watts, ICAS 13.5 watts.

FILAMENT VOLTAGE (AC/DC).....	6.3	volts
FILAMENT CURRENT.....	0.65	ampere
FILAMENT HEATING TIME.....	less than 2	seconds
TRANSCONDUCTANCE*.....	3200	μmhos
MU-FACTOR, Grid No.2 to Grid No.1**.....	7.5	
DIRECT INTERELECTRODE CAPACITANCES:°		
Grid No.1 to plate.....	0.11 max	μf
Grid No.1 to filament mid-tap, grid No.3, internal shield, and grid No.2	8.5	μf
Plate to filament mid-tap, grid No.3, internal shield, grid No.2, and base sleeve.....	6.5	μf
BULB TEMPERATURE (At hottest point).....	210 max	°C

\* Plate volts, 500; grid-No.2 volts, 200; plate milliamperes, 16.

\*\* Plate and grid-No.2 volts, 200; plate milliamperes, 16.

° Without external shield; with base sleeve connected to ground.

### AF POWER AMPLIFIER AND MODULATOR—Class AB<sub>2</sub>

**Maximum Ratings:**

	CCS	ICAS	
DC PLATE VOLTAGE.....	400 max	500 max	volts
DC GRID-NO.2 VOLTAGE.....	200 max	200 max	volts
MAXIMUM-SIGNAL DC PLATE CURRENT■.....	75 max	75 max	ma
MAXIMUM-SIGNAL PLATE INPUT■.....	30 max	37.5 max	watts
MAXIMUM-SIGNAL GRID-NO.2 INPUT■.....	2.5 max	2.5 max	watts
PLATE DISSIPATION■.....	10 max	13.5 max	watts

**Typical Operation (Values are for 2 tubes):**

DC Plate Voltage.....	400	500	volts
DC Grid-No.2 Voltage.....	125	125	volts
DC Grid-No.1 Voltage†.....	-15	-15	volts
Peak AF Grid-No.1-to-Grid-No.1 Voltage.....	82	82	volts

## RCA Transmitting Tubes

Zero-Signal DC Plate Current	18	20	ma
Maximum-Signal DC Plate Current	150	150	ma
Zero-Signal DC Grid-No.2 Current	0.6	0.6	ma
Maximum-Signal DC Grid-No.2 Current	26	28	ma
Effective Load Resistance (Plate to plate)	7000	9000	ohms
Maximum-Signal Driving Power (Approx.)	0.43	0.46	watt
Maximum-Signal Power Output (Approx.)	42	54	watts

### Maximum Circuit Values (CCS or ICAS conditions):

Grid-No.1-Circuit Resistance	30000† max	ohms
------------------------------	------------	------

■ Averaged over any audio-frequency cycle of sine-wave form.

† For ac filament supply.

‡ For operation at less than maximum ratings, this value may be as high as 100000 ohms.

### PLATE-MODULATED RF POWER AMPLIFIER—Class C Telephony

Maximum Ratings:	CCS	ICAS	
DC PLATE VOLTAGE	400 max	500 max	volts
DC GRID-NO.2 VOLTAGE	200 max	200 max	volts
DC GRID-NO.1 VOLTAGE	-175 max	-175 max	volts
DC PLATE CURRENT	60 max	70 max	ma
DC GRID-NO.1 CURRENT	3.5 max	3.5 max	ma
PLATE INPUT	20 max	27 max	watts
GRID-NO.2 INPUT	1.7 max	2.3 max	watts
PLATE DISSIPATION	6.7 max	9 max	watts

### Typical Operation:

DC Plate Voltage	400	500	volts
DC Grid-No.2 Voltage <sup>⊙</sup>	180	180	volts
From a series resistor of	27500	40000	ohms
DC Grid-No.1 Voltage† <sup>⊘</sup>	-45	-45	volts
From a grid-No.1 resistor of	18000	18000	ohms
Peak RF Grid-No.1 Voltage	61	62	volts
DC Plate Current	50	54	ma
DC Grid-No.2 Current	8	8	ma
DC Grid-No.1 Current (Approx.)	2.5	2.5	ma
Driving Power (Approx.)	0.15	0.16	watt
Power Output (Approx.)	13.5	18	watts

### Maximum Circuit Values (CCS or ICAS conditions):

Grid-No.1-Circuit Resistance	30000† max	ohms
------------------------------	------------	------

⊙ Obtained preferably from separate source modulated along with plate supply, or from the modulated plate supply through series resistor of value shown.

† For ac filament supply.

⊘ Obtained preferably from grid-No.1 resistor or from a combination of grid-No.1 resistor with either fixed supply or cathode resistor.

‡ For operation at less than maximum ratings, this value may be as high as 100000 ohms.

### RF POWER AMPLIFIER AND OSCILLATOR—Class C Telegraphy and

### RF POWER AMPLIFIER—Class C FM Telephony

Maximum Ratings:	CCS	ICAS	
DC PLATE VOLTAGE	500 max	600 max	volts
DC GRID-NO.2 VOLTAGE	200 max	200 max	volts
DC GRID-NO.1 VOLTAGE	-175 max	-175 max	volts
DC PLATE CURRENT	75 max	85 max	ma
DC GRID-NO.1 CURRENT	3.5 max	3.5 max	ma
PLATE INPUT	30 max	40 max	watts
GRID-NO.2 INPUT	2.5 max	2.5 max	watts
PLATE DISSIPATION	10 max	13.5 max	watts

### Typical CCS Operation:

	125 Mc		
DC Plate Voltage	400	500	volts
DC Grid-No.2 Voltage <sup>⊙</sup>	200	190	volts
From a series resistor of	20000	29000	ohms
DC Grid-No.1 Voltage† <sup>⊘</sup>	-45	-45	volts
From a grid-No.1 resistor of	15000	15000	ohms
Peak RF Grid-No.1 Voltage	62	65	volts
DC Plate Current	75	60	ma
DC Grid-No.2 Current	10	10.5	ma
DC Grid-No.1 Current	8	8	ma

## Technical Data

Driving Power (Approx.)	0.19	0.2	watt
Power Output (Approx.)	20	20	watts
<b>Typical ICAS Operation:</b>	<b>125 Mc</b>	<b>160 Mc</b>	
DC Plate Voltage	600	350	volts
DC Grid-No.2 Voltage <sup>a</sup>	195	170	volts
From a series resistor of	40500	18000	ohms
DC Grid-No.1 Voltage <sup>b</sup>	-50	-50	volts
From a grid-No.1 resistor of	16700	16500	ohms
Peak RF Grid-No.1 Voltage	71	70	volts
DC Plate Current	66	85	ma
DC Grid-No.2 Current	10	10	ma
DC Grid-No.1 Current	3	3	ma
Driving Power (Approx.)	0.21	2	watts
Power Output (Approx.)	27	16.5	watts

**Maximum Circuit Values (CCS or ICAS conditions):**

Grid-No.1-Circuit Resistance ..... 30000 $\frac{1}{2}$  max ohms

<sup>a</sup> Obtained preferably from separate source, or from the plate-supply voltage with a voltage divider, or through a series resistor of value shown. Grid-No.2 voltage must not exceed 600 volts under key-up conditions.

<sup>b</sup> For ac filament supply.

<sup>c</sup> Obtained from fixed supply, by grid-No.1 resistor, by cathode resistor, or by combination methods.

<sup>d</sup> For operation at less than maximum ratings, this value may be as high as 100000 ohms.

**AVERAGE CHARACTERISTICS**

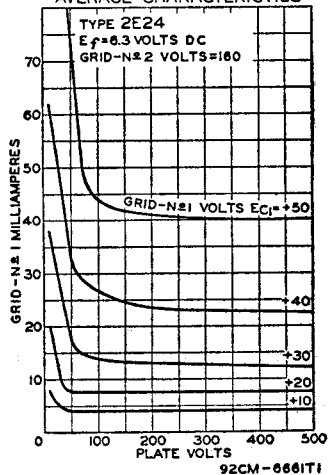

### OPERATING CONSIDERATIONS

Type 2E24 requires Octal socket and may be operated in vertical position with base up or down, or in horizontal position with pins 3 and 7 in vertical plane. Effective rf grounding and simplified shielding of input from output are facilitated by the base sleeve with separate base-pin connection and the single base-pin connection for filament mid-tap, grid No.3, and internal shield. **OUTLINE 15, Outlines Section.**

For operation at 150 Mc, plate voltage and plate input should be reduced to 83 per cent of maximum ratings; at 160 Mc, to 75 per cent; at 175 Mc, to 68 per cent. Plate shows no color when the tube is operated at maximum CCS or ICAS ratings.

**AVERAGE CHARACTERISTICS**

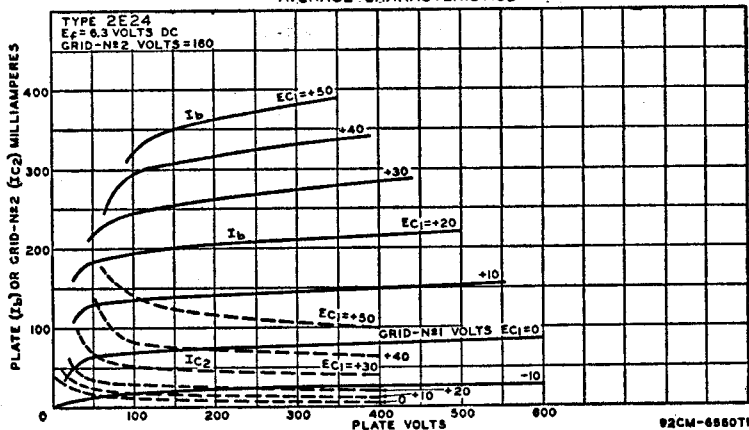

**BEAM POWER TUBE**

**2E26**

Glass-octal heater-cathode type used as af power amplifier and modulator and as rf power amplifier and oscillator. May be used with full input up to 125 Mc and with reduced input

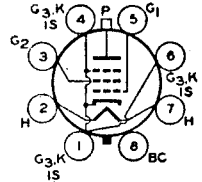

up to 175 Mc. Class C Telephony maximum plate dissipation, CCS 10 watts, ICAS 13.5 watts.

HEATER VOLTAGE (AC/DC).....	6.3	volts
HEATER CURRENT.....	0.8	ampere
TRANSCONDUCTANCE*.....	3500	μmhos
MU-FACTOR, Grid No.2 to Grid No.1**.....	6.5	
DIRECT INTERELECTRODE CAPACITANCES:†		
Grid No.1 to plate.....	0.20 max	μf
Grid No.1 to cathode, grid-No.3, internal shield, grid-No.2, base sleeve, and heater.....	13	μf
Plate to cathode, grid-No.3, internal shield, grid-No.2, and heater.....	7	μf
BULB TEMPERATURE (At hottest point).....	210 max	°C

\* Plate volts, 500; grid-No.2 volts, 200; plate milliamperes, 20.

\*\* Plate and grid-No.2 volts, 200; plate milliamperes, 20.

† Without external shield.

**AF POWER AMPLIFIER AND MODULATOR—Class AB<sub>2</sub>**

Maximum Ratings:	CCS	ICAS	
DC PLATE VOLTAGE.....	600 max	750 max	volts
DC GRID-NO.2 VOLTAGE.....	250 max	250 max	volts
MAXIMUM-SIGNAL DC PLATE CURRENT <sup>‡</sup> .....	75 max	75 max	ma
MAXIMUM-SIGNAL PLATE INPUT <sup>‡</sup> .....	30 max	37.5 max	watts
MAXIMUM-SIGNAL GRID-NO.2 INPUT <sup>‡</sup> .....	2.5 max	2.5 max	watts
PLATE DISSIPATION <sup>‡</sup> .....	10 max	12.5 max	watts
PEAK HEATER-CATHODE VOLTAGE:			
Heater negative with respect to cathode.....	100 max	100 max	volts
Heater positive with respect to cathode.....	100 max	100 max	volts

**Typical Operation (Values are for 2 tubes):**

DC Plate Voltage.....	400	500	volts
DC Grid-No.2 Voltage <sup>††</sup> .....	125	125	volts
DC Grid-No.1 Voltage.....	-15	-15	volts
Peak AF Grid-No.1-to-Grid No.1 Voltage.....	60	60	volts
Zero-Signal DC Plate Current.....	20	22	ma
Maximum-Signal DC Plate Current.....	150	150	ma
Maximum-Signal DC Grid-No.2 Current.....	32	32	ma
Effective Load Resistance (Plate to plate).....	6200	8000	ohms
Maximum-Signal Driving Power (Approx.).....	0.36	0.36	watt
Maximum-Signal Power Output (Approx.).....	42	54	watts

**Maximum Circuit Values (CCS or ICAS conditions):**

Grid-No.1-Circuit Resistance:		
For fixed-bias operation.....	30000‡ max	ohms
For cathode-bias operation.....	Not recommended	

‡ Averaged over any audio-frequency cycle of sine-wave form.

† Preferably obtained from a separate source or from the plate-supply voltage with a voltage divider.  
 †† In applications requiring the use of grid-No.2 voltages above 135 volts, provisions should be made for adjustment of grid-No.1 bias for each tube separately. The necessity for this adjustment at lower grid-No.2 voltages depends on the distortion requirements and on whether the plate-dissipation rating is exceeded at zero-signal plate current.

‡ For operation at less than maximum ratings, this value may be as high as 100000 ohms.

**PLATE-MODULATED RF POWER AMPLIFIER—Class C Telephony**

Maximum Ratings:	CCS	ICAS	
DC PLATE VOLTAGE.....	400 max	500 max	volts
DC GRID-NO.2 VOLTAGE.....	200 max	200 max	volts
DC GRID-NO.1 VOLTAGE.....	-175 max	-175 max	volts
DC PLATE CURRENT.....	60 max	70 max	ma
DC GRID-NO.1 CURRENT.....	3.5 max	3.5 max	ma
PLATE INPUT.....	20 max	27 max	watts

## Technical Data

GRID-NO.2 INPUT.....	1.7 <i>max</i>	2.3 <i>max</i>	watts
PLATE DISSIPATION.....	6.7 <i>max</i>	9 <i>max</i>	watts
<b>PEAK HEATER-CATHODE VOLTAGE:</b>			
Heater negative with respect to cathode.....	100 <i>max</i>	100 <i>max</i>	volts
Heater positive with respect to cathode.....	100 <i>max</i>	100 <i>max</i>	volts

### Typical Operation:

DC Plate Voltage.....	400	500	volts
DC Grid-No.2 Voltage <sup>ⓐ</sup> .....	160	180	volts
From series resistor of.....	32000	35500	ohms
DC Grid-No.1 Voltage <sup>ⓐ</sup> .....	-50	-50	volts
From grid-No.1 resistor of.....	20000	20000	ohms
Peak RF Grid-No.1 Voltage.....	60	60	volts
DC Plate Current.....	50	54	ma
DC Grid-No.2 Current.....	7.5	9	ma
DC Grid-No.1 Current (Approx.).....	2.5	2.5	ma
Driving Power (Approx.).....	0.15	0.15	watt
Power Output (Approx.).....	13.5	18	watts

### Maximum Circuit Values (CCS or ICAS conditions):

Grid-No.1-Circuit Resistance.....	30000‡ <i>max</i>	ohms
-----------------------------------	-------------------	------

ⓐ Obtained preferably from separate source modulated along with plate supply, or from the modulated plate supply through series resistor of value shown.

ⓐ Obtained from the grid-No.1 resistor or from a combination of grid-No.1 resistor with either fixed supply or cathode resistor.

‡ For operation at less than maximum ratings, this value may be as high as 100000 ohms.

## RF POWER AMPLIFIER AND OSCILLATOR—Class C Telegraphy and RF POWER AMPLIFIER—Class C FM Telephony

### Maximum Ratings:

	CCS	ICAS	
DC PLATE VOLTAGE.....	500 <i>max</i>	600 <i>max</i>	volts
DC GRID-NO.2 VOLTAGE.....	200 <i>max</i>	200 <i>max</i>	volts
DC GRID-NO.1 VOLTAGE.....	-175 <i>max</i>	-175 <i>max</i>	volts
DC PLATE CURRENT.....	75 <i>max</i>	85 <i>max</i>	ma
DC GRID-NO.1 CURRENT.....	3.5 <i>max</i>	3.5 <i>max</i>	ma
PLATE INPUT.....	30 <i>max</i>	40 <i>max</i>	watts
GRID-NO.2 INPUT.....	2.5 <i>max</i>	2.5 <i>max</i>	watts
PLATE DISSIPATION.....	10 <i>max</i>	13.5 <i>max</i>	watts
<b>PEAK HEATER-CATHODE VOLTAGE:</b>			
Heater negative with respect to cathode.....	100 <i>max</i>	100 <i>max</i>	volts
Heater positive with respect to cathode.....	100 <i>max</i>	100 <i>max</i>	volts

### Typical CCS Operation:

	125 Mc	160 Mc	
DC Plate Voltage.....	400	300	volts
DC Grid-No.2 Voltage <sup>ⓐ</sup> .....	190	170	volts
From series resistor of.....	19000	21500	ohms
DC Grid-No.1 Voltages <sup>ⓐ</sup> .....	-30	-40	volts
From grid-No.1 resistor of.....	10000	30000	ohms
Peak RF Grid-No.1 Voltage.....	41	85	volts
DC Plate Current.....	75	75	ma
DC Grid-No.2 Current.....	11	6	ma
DC Grid-No.1 Current (Approx.).....	3	2.5	ma
Driving Power (Approx.).....	0.12	1.5	watts
Power Output (Approx.).....	20	13	watts

### Typical ICAS Operation:

	125 Mc	160 Mc	
DC Plate Voltage.....	600	350	volts
DC Grid-No.2 Voltage <sup>ⓐ</sup> .....	185	200	volts
From series resistor of.....	41500	21500	ohms
DC Grid-No.1 Voltage <sup>ⓐ</sup> .....	-45	-90	volts
From grid-No.1 resistor of.....	15000	30000	ohms
Peak RF Grid-No.1 Voltage.....	57	105	volts
DC Plate Current.....	66	85	ma
DC Grid-No.2 Current.....	10	7	ma
DC Grid-No.1 Current (Approx.).....	3	3	ma
Driving Power (Approx.).....	0.17	2	watts
Power Output (Approx.).....	27	16.5	watts

**Maximum Circuit Values (CCS or ICAS conditions):**

Grid-No.1-Circuit Resistance.....300000 max † ohms

\* Obtained preferably from separate source, or from the plate-supply voltage with a voltage divider, or through a series resistor of value shown. A grid-No.2 series resistor should be used only when the 2E26 is used in a circuit which is not keyed. Grid-No.2 voltage must not exceed 600 volts under key-up conditions.

‡ Obtained from fixed supply, by grid-No.1 resistor, by cathode resistor, or by combination methods.

† For operation at less than maximum ratings, this value may be as high as 100000 ohms.

**OPERATING CONSIDERATIONS**

Type 2E26 requires Octal socket and may be operated in any position. Effective rf grounding and simplified shielding are facilitated by the base sleeve with separate base-pin connection and the single base-pin connection for cathode, grid No.3, and internal shield. OUTLINE 15, *Outlines* Section.

For operation at 150 Mc, plate voltage and plate input should be reduced to 83 per cent of maximum ratings; at 160 Mc, to 75 per cent; at 175 Mc, to 68 per cent. Plate shows no color when the tube is operated at maximum CCS or ICAS ratings.

**TYPICAL CHARACTERISTICS**

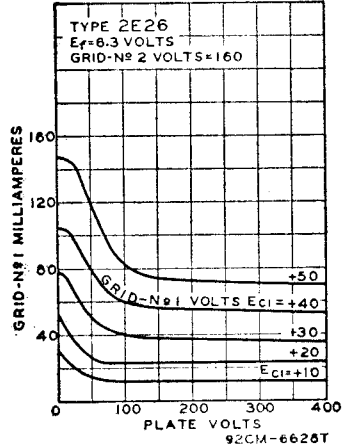

**AVERAGE CHARACTERISTICS**

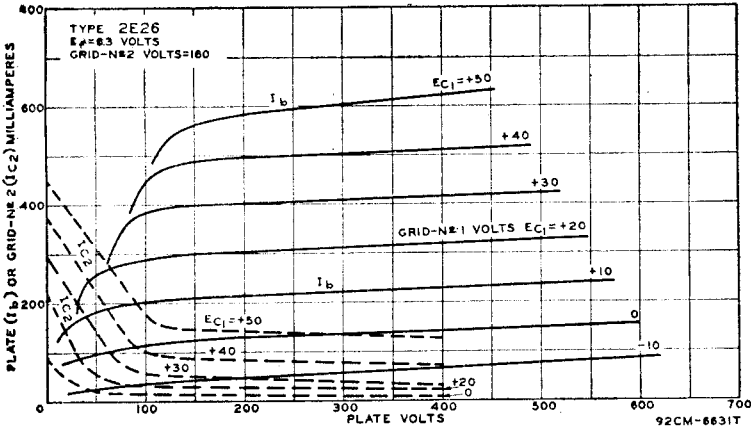

**HALF-WAVE VACUUM RECTIFIER**

**2X2A**

Heater-cathode type used in equipment subject to severe shock and vibration. Maximum peak inverse plate volts, 12500; maximum dc plate milliamperes, 75. Requires Small four-contact socket and may be operated in any position. OUTLINE 26, *Outlines* Section.

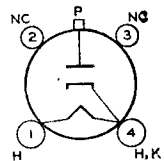



## Technical Data

HEATER VOLTAGE (AC).....	2.5	volts
HEATER CURRENT.....	1.75	amperes

### HALF-WAVE RECTIFIER

#### Maximum Ratings, Design-Center Values:

PEAK INVERSE PLATE VOLTAGE.....	12500 max	volts
PEAK PLATE CURRENT.....	60 max	ma
DC OUTPUT CURRENT.....	7.5 max	ma
HOT-SWITCHING TRANSIENT CURRENT for duration of 0.2 second max.....	100 max	ma
AMBIENT TEMPERATURE.....	70 max	°C

#### Typical Operation:

AC Plate-Supply Voltage (rms).....	5500	volts
Total Effective Plate-Supply Impedance.....	0.3	megohm
Filter Input Capacitor.....	0.1	μf
DC Output Current.....	2	ma
DC Output Voltage, At input to filter.....	4500	volts

## POWER PENTODE

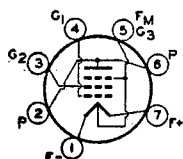

Seven-pin miniature type having coated filament used as rf power amplifier in light-weight, compact, portable, low-power, battery-operated equipment. May be used at full input up to 10 Mc. Class C maximum CCS plate dissipation, 2 watts.

# 3A4

	Series	Parallel	
FILAMENT ARRANGEMENT.....	2, 8	1, 4	volts
FILAMENT VOLTAGE (DC).....	0.1	0.2	ampere
FILAMENT CURRENT.....	2250		μmhos
TRANSCONDUCTANCE*.....	80000		ohms
PLATE RESISTANCE (Approx.)*.....			
DIRECT INTERELECTRODE CAPACITANCES:			
Grid No.1 to plate.....	0.34 max		μf
Grid No.1 to filament mid-tap, grid No.3, and grid No.2.....	4.8		μf
Plate to filament mid-tap, grid No.3, and grid No.2.....	4.2		μf

\* Plate volts, 150; grid-No.2 volts, 90; grid-No.1 volts, -8.4.

### RF POWER AMPLIFIER—Class C

#### Maximum CCS Ratings, Design-Center Values:

DC PLATE VOLTAGE.....	150 max	volts
DC GRID-NO.2 VOLTAGE.....	135 max	volts
DC GRID-NO.1 VOLTAGE.....	-80 max	volts
DC PLATE CURRENT.....	20 max	ma
DC GRID-NO.1 CURRENT.....	0.25 max	ma
TOTAL DC CATHODE CURRENT.....	25 max	ma
PLATE INPUT.....	3 max	watts
GRID-NO.2 INPUT.....	0.9 max	watt
PLATE DISSIPATION.....	2 max	watts

#### Typical Operation at 10 Mc (with Parallel Filament Arrangement):

DC Plate Voltage.....	150	volts
DC Grid-No.2 Voltage.....	135	volts
Grid-No.1 Resistor.....	0.2	megohm
DC Plate Current.....	18.3	ma
DC Grid-No.2 Current.....	6.5	ma
DC Grid-No.1 Current.....	0.13	ma
Power Output (Approx.).....	1.2	watts

■ For each 1.4-volt filament section.

## OPERATING CONSIDERATIONS

Type 3A4 requires miniature seven-contact socket and may be operated in any position. OUTLINE 5, *Outlines* Section.

The filament power supply may be obtained from dry-cell batteries, from storage batteries, or from a power line. With dry-cell battery supply, the filament

may be connected either directly across a battery rated at a terminal potential of 1.5 volts, or in series with the filaments of similar tubes across a power supply consisting of dry cells in series. In any case, the voltage across each 1.4-volt section of filament should not exceed 1.6 volts.

With power-line or storage-battery supply, the filament may be operated in series with the filaments of other tubes of the same filament-current rating. For such operation, design adjustments should be made so that, with tubes of rated characteristics operating with all electrode voltages applied and on a normal line voltage of 117 volts or on a normal storage-battery voltage of 2.0 volts per cell (without a charger) or 2.2 volts per cell (with a charger), the voltage drop across each 1.4-volt section of filament will be maintained within a range of 1.25 to 1.4 volts with a center of 1.3 volts.

For series operation of the sections, a shunting resistor must be connected across the section between pins 1 and 5 to bypass any cathode current in this section which is in excess of the rated maximum per section. When other tubes in a series-filament arrangement contribute to the filament current of the 3A4, an additional shunting resistor may be required across the entire filament (pins 1 and 7).

For series-filament arrangement, filament voltage is applied between pins 1 and 7. For parallel-filament arrangement, filament voltage is applied between pin 5 and pins 1 and 7 connected together. In series-filament arrangement, the grid-No.1 voltage is referred to pin 1. In parallel-filament arrangement, the grid-No.1 voltage is referred to pin 5.

Plate of the 3A4 shows no color when the tube is operated at maximum CCS ratings.

### MEDIUM-MU TWIN TRIODE

## 3A5

Seven-pin miniature type having coated filament used as rf power amplifier and oscillator in light-weight, compact, portable, low-power, battery-operated equipment. May be used at

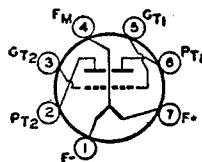

full input up to 40 Mc. Class C Telegraphy maximum CCS plate dissipation (each unit), 1 watt. Requires miniature seven-contact socket and may be operated in any position. OUTLINE 5, *Outlines* Section. For filament considerations, refer to type 3A4, noting that for type 3A5 pin 4 is the filament mid-tap. Plates of the 3A5 show no color when the tube is operated at CCS ratings.

	<i>Series</i>	<i>Parallel</i>	
FILAMENT ARRANGEMENT	2.8	1.4	volts
FILAMENT VOLTAGE (DC) . . . . .	0.11	0.22	ampere
FILAMENT CURRENT . . . . .			μmhos
TRANSCONDUCTANCE* . . . . .		1800	
AMPLIFICATION FACTOR* . . . . .		15	
PLATE RESISTANCE (Approx.)* . . . . .		8300	ohms
DIRECT INTERELECTRODE CAPACITANCES (Each unit):			
Grid to plate . . . . .		3.2	μμf
Grid to filament mid-tap . . . . .		0.9	μμf
Plate to filament mid-tap . . . . .		1.0	μμf
Plate to plate . . . . .		0.32	μμf

\* Plate volts, 90; grid volts, -2.5; plate milliamperes, 3.7.

#### RF POWER AMPLIFIER AND OSCILLATOR—Class C Telegraphy and RF POWER AMPLIFIER—Class C FM Telephony

Maximum CCS Ratings, Design-Center Values for each unit:

DC PLATE VOLTAGE . . . . .	135 max	volts
DC GRID VOLTAGE . . . . .	-30 max	volts
DC PLATE CURRENT . . . . .	15 max	ma
DC GRID CURRENT . . . . .	2.5 max	ma
PLATE INPUT . . . . .	2 max	watts
PLATE DISSIPATION . . . . .	1 max	watt

**Typical Push-Pull Operation (Values are for both units):**

DC Plate Voltage.....	135	volts
DC Grid Voltage.....	-20	volts
From grid resistor of.....	4000	ohms
From cathode resistor of.....	570	ohms
Peak HF Grid-to-Grid Voltage.....	90	volts
DC Plate Current.....	30	ma
DC Grid Current (Approx.).....	5	ma
Driving Power (Approx.).....	0.2	watt
Power Output (Approx.).....	2	watts

• Obtained by fixed supply, by grid resistor, by cathode resistor, or by combination methods.

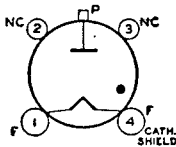

**HALF-WAVE GAS RECTIFIER**

Xenon-filled rectifier of the coated-filament type. May be used in equipment subject to wide range of ambient temperature (-75° to +90°C). Maximum peak inverse anode volts, 4500;

**3B25**

maximum average anode amperes, 0.5. Requires Small four-contact socket and may be operated in any position. **OUTLINE 39, Outlines Section.**

FILAMENT VOLTAGE (AC)°.....	2.5	volts
FILAMENT CURRENT.....	5.0	amperes
PEAK TUBE VOLTAGE DROP (Approx.).....	10	volts

° Filament voltage must be applied at least 15 seconds before application of anode voltage.

**HALF-WAVE RECTIFIER**

<b>Maximum Ratings:</b>		
PEAK INVERSE ANODE VOLTAGE.....	4500 max	volts
ANODE CURRENT:		
Peak.....	2.0 max	amperes
Average $\varnothing$ .....	0.5 max	ampere
Fault, for duration of 0.1 second maximum.....	20 max	amperes
FREQUENCY OF POWER SUPPLY.....	500 max	cps
AMBIENT-TEMPERATURE RANGE.....	-75 to +90	°C

$\varnothing$  Averaged over any period of 30 seconds maximum.

**Operating Values:**

Circuit (For circuit figures, refer to Rectifier Considerations Section)	Fig.	Max. Trans.	Approx. DC	Max. DC	Max. DC
		Sec. Volts (RMS) E	Output Volts To Filter E <sub>av</sub>	Output Amperes I <sub>av</sub>	Output KW To Filter P <sub>dc</sub>
<b>In-Phase Operation</b>					
Half-Wave Single-Phase....	57	3100	1400	0.5	0.7
Full-Wave Single-Phase....	58	1500	1400	1.0	1.4
Series Single-Phase.....	59	3100	2900	1.0	2.7
Half-Wave Three-Phase....	60	1800	2200	1.5	3.3
<b>Quadrature Operation</b>					
Parallel Three-Phase.....	61	1800	2200	3.0	6.6
Series Three-Phase.....	62	1800	4300	1.5	6.4
Half-Wave Four-Phase....	63	1500	2000	1.8* 2.0■	3.6* 4.0■
Half-Wave Six-Phase.....	64	1500	2200	1.9* 2.0■	4* 4.4■

\* Resistive Load

■ Inductive Load

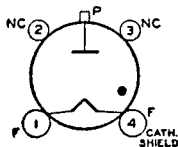

**HALF-WAVE GAS RECTIFIER**

Xenon-filled rectifier of the coated-filament type. May be used in equipment subject to wide range of ambient temperature (-75° to +90°C). Rating I: maximum peak inverse anode volts,

**3B28**

10,000; maximum average anode amperes, 0.25. Rating II: maximum peak inverse anode volts, 5000; maximum average anode amperes, 0.5. Requires Small four-contact socket and may be operated in any position. OUTLINE 36, *Outlines* Section.

FILAMENT VOLTAGE (AC) <sup>o</sup> .....	2.5	volts
FILAMENT CURRENT.....	5.0	amperes
PEAK TUBE VOLTAGE DROP (Approx.).....	10	volts

<sup>o</sup> Filament voltage must be applied at least 10 seconds before the application of anode voltage.

**HALF-WAVE RECTIFIER**

**Maximum Ratings:**

PEAK INVERSE ANODE VOLTAGE.....	5000 <i>max</i>	10000 <i>max</i>	volts
ANODE CURRENT:			
Peak.....	2 <i>max</i>	1 <i>max</i>	amperes
Average <sup>o</sup> .....	0.5 <i>max</i>	0.25 <i>max</i>	ampere
Fault, for duration of 0.1 second maximum.....	20 <i>max</i>	20 <i>max</i>	amperes
FREQUENCY OF POWER SUPPLY.....	500 <i>max</i>	150 <i>max</i>	cps
AMBIENT-TEMPERATURE RANGE.....	-75 to +90	-75 to +90	°C

<sup>o</sup> Averaged over any period of 30 seconds maximum.

**Operating Values:**

Circuit (For circuit figures, refer to <i>Rectifier Considerations</i> Section)	Fig.	Max. Trans. Sec. Volts (RMS) <i>E</i>	Approx. DC Output Volts To Filter <i>E<sub>av</sub></i>	Max. DC Output Amperes <i>I<sub>av</sub></i>	Max. DC Output KW To Filter Pdc
<b>In-Phase Operation</b>					
Half-Wave Single-Phase...	57	7000*	3200	0.25	0.8
		3500*	1600	0.5	0.8
Full-Wave Single-Phase...	58	3500*	3200	0.5	1.6
		1700*	1600	1.0	1.6
Series Single-Phase.....	59	7000*	6400	0.5	3.2
		3500*	3200	1.0	3.2
Half-Wave Three-Phase...	60	4000*	4800	0.75	3.6
		2000*	2400	1.5	3.6
<b>Quadrature Operation</b>					
Parallel Three-Phase.....	61	4000*	4800	1.5	7.2
		2000*	2400	3.0	7.2
Series Three-Phase.....	62	4000*	9600	0.75	7.2
		2000*	4800	1.5	7.2
Half-Wave Four-Phase....	63	3500*	4500	0.9* 1.0 <sup>■</sup>	4.0* 4.5 <sup>■</sup>
		1700*	2250	1.8* 2.0 <sup>■</sup>	4.0* 4.5 <sup>■</sup>
Half-Wave Six-Phase.....	64	3500*	4800	0.95* 1.0 <sup>■</sup>	4.5* 4.8 <sup>■</sup>
		1700*	2400	1.9* 2.0 <sup>■</sup>	4.5* 4.8 <sup>■</sup>

\* For maximum peak inverse anode voltage of 10000 volts.

▲ For maximum peak inverse anode voltage of 5000 volts.

\* Resistive load.

■ Inductive load.

**TWIN POWER TRIODE**

**3C33**

Heater-cathode type containing two high-perveance units used as industrial control amplifier and voltage regulator. Control Amplifier maximum CCS plate dissipation (each unit), 15

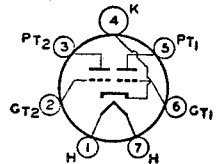

watts. Requires Septar seven-contact socket and may be operated in vertical position with base up or down, or in horizontal position with pins 2 and 6 in horizontal plane. OUTLINE 16, *Outlines* Section. Plates show no color when the tube is operated at maximum CCS ratings.

HEATER VOLTAGE (AC/DC).....	12.6	volts
HEATER CURRENT.....	1.125	amperes
AMPLIFICATION FACTOR (Each unit)*.....	11	

## Technical Data

### DIRECT INTERELECTRODE CAPACITANCES (Each unit):

Grid to plate.....	5.4	$\mu\mu\text{f}$
Grid to cathode and heater.....	7.8	$\mu\mu\text{f}$
Plate to cathode and heater.....	4.2	$\mu\mu\text{f}$

\* Grid volts, -200; plate milliamperes, 90.

### CONTROL AMPLIFIER SERVICE

*Values are for each unit*

<b>Maximum CCS Ratings:</b>		
PEAK PLATE VOLTAGE.....	$\pm 2000$ max	volts
DC GRID VOLTAGE.....	-200 max	volts
PEAK CATHODE CURRENT.....	500 max	ma
AVERAGE PLATE CURRENT.....	120 max	ma
AVERAGE GRID CURRENT.....	7.5 max	ma
PLATE DISSIPATION.....	15 max	watts
<b>PEAK HEATER-CATHODE VOLTAGE:</b>		
Heater negative with respect to cathode.....	100 max	volts
Heater positive with respect to cathode.....	100 max	volts
BULB TEMPERATURE (At hottest point).....	250 max	$^{\circ}\text{C}$

### Maximum Circuit Values:

Grid-Circuit Resistance:		
When grid potential is always negative.....	0.5 max	megohm
When grid potential swings positive.....	0.03 max	megohm

### TWIN BEAM POWER TUBE

Glass-octal heater-cathode type used as push-pull rf power amplifier and oscillator in intermittent mobile-service applications. May be used with full input up to 15 Mc. **OUTLINE 24, Outlines Section.** Heater volts (ac/dc),  $12.6 \pm 10\%$  (series),  $6.3 \pm 10\%$  (parallel); amperes, 0.8 (series), 1.6 (parallel). Direct interelectrode capacitances (each unit): grid No.1 to plate, 0.22 max  $\mu\mu\text{f}$ ; grid No.1 to cathode, grid

## 3E22

No.3, internal shield, grid No.2, and heater, 14  $\mu\mu\text{f}$ ; plate to cathode, grid No.3, internal shield, grid No.2, and heater, 8.5  $\mu\mu\text{f}$ . Maximum IMS ratings as **PUSH-PULL RF POWER AMPLIFIER AND OSCILLATOR, CLASS C TELEGRAPHY** (per tube): dc plate volts, 600 max; dc grid-No.2 volts, 225 max; dc grid-No.1 volts, -175 max; dc plate milliamperes, 175 max; dc grid-No.1 milliamperes, 11 max; plate input, 100 max watts; grid-No.2 input, 6 max watts; plate dissipation, 35 max watts; peak heater-cathode volts,  $\pm 100$  max. Plates show no color when the tube is operated at maximum IMS ratings during the normal cycle of 15 seconds on, 1 minute off. The 3E22 is a **DISCONTINUED** type listed for reference only.

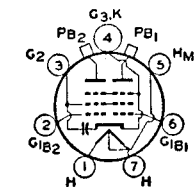

### TWIN BEAM POWER TUBE

Heater-cathode type containing two high-perveance units used as rectangular-wave pulse modulator. Modulator Service maximum CCS plate dissipation (per tube), 15 watts. Re-

## 3E29

quires Septar seven-contact socket and may be operated in vertical position with base up or down, or in horizontal position with pins 2 and 6 in horizontal plane. **OUTLINE 22, Outlines Section.** Plates show no color when the tube is operated at maximum CCS ratings.

<b>HEATER ARRANGEMENT</b>	<i>Series</i>	<i>Parallel</i>	
HEATER VOLTAGE (AC/DC).....	12.6 $^{\circ}$	6.3 $^{\circ}$	volts
HEATER CURRENT.....	1.125	2.25	amperes
TRANSDUCTANCE (Each unit, approx.)*.....	8500		$\mu\text{mhos}$
MU-FACTOR, Grid No.2 to Grid No.1 (Each unit)**.....	9		
<b>DIRECT INTERELECTRODE CAPACITANCES (Each unit):</b>			
Grid No.1 to plate (with external shield).....		0.12 max	$\mu\mu\text{f}$
Grid No.1 to cathode, grid No.3, grid No.2, and heater mid-tap.....		14.0	$\mu\mu\text{f}$
Plate to cathode, grid No.3, grid No.2, and heater mid-tap.....		7.0	$\mu\mu\text{f}$

$^{\circ}$  Should not deviate more than +10% or -5% from value shown.

\* Plate volts, 250; grid-No.2 volts, 175; plate milliamperes, 60.

\*\* Plate and grid-No.2 volts, 225; plate milliamperes, 60.

## MODULATOR—Rectangular-Wave Modulation

*Values are for both units in parallel*  
**Maximum CCS Ratings:** *For Duty Factor<sup>■</sup> between 0.0001 and 1.0 and Maximum Averaging Time of 1200 Microseconds in Any Interval*

DC PLATE-SUPPLY VOLTAGE <sup>▲</sup> . . . . .	5000 <i>max</i>	volts
INSTANTANEOUS PLATE VOLTAGE . . . . .	5750 <i>max</i>	volts
DC GRID-NO.2 SUPPLY VOLTAGE <sup>▲</sup> . . . . .	850 <i>max</i>	volts
DC GRID-NO.1 SUPPLY VOLTAGE <sup>▲</sup> . . . . .	-225 <i>max</i>	volts
INSTANTANEOUS GRID-NO.1 VOLTAGE . . . . .	-600 <i>max</i>	volts
PEAK POSITIVE GRID-NO.1 VOLTAGE . . . . .	250 <i>max</i>	volts
PEAK PLATE CURRENT . . . . .	● <i>max</i>	amperes
PEAK GRID-NO.2 CURRENT . . . . .	3.5 <i>max</i>	amperes
PEAK GRID-NO.1 CURRENT . . . . .	4 <i>max</i>	amperes
PLATE INPUT . . . . .	85 <i>max</i>	watts
GRID-NO.2 INPUT . . . . .	3 <i>max</i>	watts
GRID-NO.1 INPUT . . . . .	1 <i>max</i>	watt
PLATE DISSIPATION . . . . .	15 <i>max</i>	watts
<b>PEAK HEATER-CATHODE VOLTAGE:</b>		
Heater negative with respect to cathode . . . . .	100 <i>max</i>	volts
Heater positive with respect to cathode . . . . .	100 <i>max</i>	volts

■ Duty factor is defined as the ON time in microseconds divided by 1200 microseconds. Pulse duration is defined as the time interval between the two points on the pulse at which the instantaneous value is 70 per cent of the peak value. The peak value is defined as the maximum value of a smooth curve through the average of the fluctuations over the top portion of the pulse.

▲ For tube protection, it is essential that sufficient dc resistance be used in the plate-supply circuit, the grid-No.2-supply circuit, and the grid-No.1-supply circuit so that the short-circuit current is limited to 0.5 ampere in each circuit.

● For a duty factor between 0.0001 and 0.001, the rated peak plate current is 10 amperes maximum. For higher duty factors, the peak plate current must be reduced. The rated peak plate current for a duty factor of 1.0 is 0.3 ampere approx.

## BEAM POWER TUBE

# 4-65A

Small, thoriated-tungsten-filament type used as af power amplifier and modulator and as rf power amplifier and oscillator. May be used with full input up to 150 Mc. Class C Telegraphy

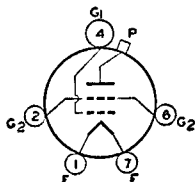

maximum CCS plate dissipation, 65 watts. Requires Septar seven-contact socket and may be operated in vertical position only, base up or down. OUTLINE 23, *Outlines* Section. Plate shows an orange-red color when the tube is operated at maximum CCS ratings.

FILAMENT VOLTAGE (AC/DC) . . . . .	6.0	volts
FILAMENT CURRENT . . . . .	3.5	amperes
TRANSCONDUCTANCE* . . . . .	4000	μmhos
MU-FACTOR, Grid No.2 to Grid No.1 . . . . .	5	
<b>DIRECT INTERELECTRODE CAPACITANCES:</b>		
Grid No.1 to plate . . . . .	0.08 <i>max</i>	μf
Grid No.1 to filament and grid No.2 . . . . .	7.5	μf
Plate to filament and grid No.2 . . . . .	2.2	μf

\* Plate volts, 500; grid-No.2 volts, 250; plate milliamperes, 125.

### PLATE-MODULATED RF POWER AMPLIFIER—Class C Telephony

**Maximum CCS Ratings:**

DC PLATE VOLTAGE . . . . .	2500 <i>max</i>	volts
DC GRID-NO.2 VOLTAGE . . . . .	400 <i>max</i>	volts
DC PLATE CURRENT . . . . .	120 <i>max</i>	ma
GRID-NO.2 INPUT . . . . .	10 <i>max</i>	watts
PLATE DISSIPATION . . . . .	45 <i>max</i>	watts

### RF POWER AMPLIFIER AND OSCILLATOR—Class C Telegraphy and

**Maximum CCS Ratings: RF POWER AMPLIFIER—Class C FM Telephony**

DC PLATE VOLTAGE . . . . .	3000 <i>max</i>	volts
DC GRID-NO.2 VOLTAGE . . . . .	600 <i>max</i>	volts
DC PLATE CURRENT . . . . .	150 <i>max</i>	ma
GRID-NO.2 INPUT . . . . .	10 <i>max</i>	watts
PLATE DISSIPATION . . . . .	65 <i>max</i>	watts

**BEAM POWER TUBE**

See type 6155/4-125A.

**4-125A**

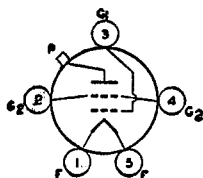

**BEAM POWER TUBE**

Forced-air-cooled, thoriated-tungsten-filament type used as af power amplifier and modulator and as rf power amplifier and oscillator. May be used with full input up to 30 Mc

**4-125A/  
4D21**

with natural cooling, or 120 Mc with forced-air cooling and with reduced input up to 240 Mc. Class C Telephony maximum CCS plate dissipation, 125 watts. Requires Special Metal-Shell Giant five-contact socket and may be operated in vertical position only, base up or down. OUTLINE 33, *Outlines* Section. Plate shows orange-red color when the tube is operated at maximum CCS ratings.

FILAMENT VOLTAGE (AC/DC) .....	5.0	volts
FILAMENT CURRENT .....	6.5	amperes
TRANSCONDUCTANCE* .....	2500	μmhos
MU-FACTOR, Grid No.2 to Grid No.1 .....	5.9	
DIRECT INTERELECTRODE CAPACITANCES:		
Grid-No.1 to plate (Base shell connected to ground) .....	0.05	μμf
Grid No.1 to filament, grid No.2, and base shell .....	11	μμf
Plate to filament, grid No.2, and base shell .....	3.2	μμf
PLATE-SEAL TEMPERATURES:		
Continuous Service .....	170	°C
Intermittent Service (5 minutes <i>On</i> followed by 5 minutes <i>Off</i> ) .....	220	°C

\* Plate volts, 2500; grid-No.2 volts, 400; plate milliamperes, 50.

**AF POWER AMPLIFIER AND MODULATOR—Class AB<sub>2</sub>**

**Maximum CCS Ratings:**

DC PLATE VOLTAGE .....	3000 <i>max</i>	volts
DC GRID-NO.2 VOLTAGE .....	400 <i>max</i>	volts
MAXIMUM-SIGNAL DC PLATE CURRENT <sup>■</sup> .....	225 <i>max</i>	ma
GRID-NO.2 INPUT .....	20 <i>max</i>	watts
PLATE DISSIPATION <sup>■</sup> .....	125 <i>max</i>	watts

**Maximum Circuit Values:**

Grid-No.1-Circuit Resistance .....	0.25 <i>max</i>	megohm
------------------------------------	-----------------	--------

■ Averaged over any audio-frequency cycle of sine-wave form.

**PLATE-MODULATED RF POWER AMPLIFIER—Class C Telephony**

**Maximum CCS Ratings:**

DC PLATE VOLTAGE .....	2500 <i>max</i>	volts
DC GRID-NO.2 VOLTAGE .....	400 <i>max</i>	volts
DC GRID-NO.1 VOLTAGE .....	-500 <i>max</i>	volts
DC PLATE CURRENT .....	200 <i>max</i>	ma
GRID-NO.2 INPUT .....	20 <i>max</i>	watts
GRID-NO.1 INPUT .....	5 <i>max</i>	watts
PLATE DISSIPATION .....	85 <i>max</i>	watts

**RF POWER AMPLIFIER AND OSCILLATOR—Class C Telephony**

and

**RF POWER AMPLIFIER—Class C FM Telephony**

**Maximum CCS Ratings:**

DC PLATE VOLTAGE .....	3000 <i>max</i>	volts
DC GRID-NO.2 VOLTAGE .....	400 <i>max</i>	volts
DC GRID-NO.1 VOLTAGE .....	-500 <i>max</i>	volts
DC PLATE CURRENT .....	225 <i>max</i>	ma
GRID-NO.2 INPUT .....	20 <i>max</i>	watts
GRID-NO.1 INPUT .....	5 <i>max</i>	watts
PLATE DISSIPATION .....	125 <i>max</i>	watts

**BEAM POWER TUBE**

See type 6156/4-250A.

**4-250A**

**BEAM POWER TUBE**

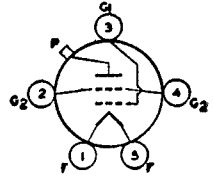

**4-250A/  
5D22**

Forced-air-cooled thoriated-tungsten-filament type used as af power amplifier and modulator and as rf power amplifier and oscillator. May be used with full input up to 30 Mc with

natural cooling, or 75 Mc with forced-air cooling and with reduced input up to 120 Mc. Class C Telephony maximum CCS plate dissipation, 250 watts. Requires Special Metal-Shell Giant five-contact socket and may be operated in vertical position only, base up or down. OUTLINE 40, *Outlines* Section. Plate shows an orange-red color when the tube is operated at maximum CCS ratings.

FILAMENT VOLTAGE (AC/DC) .....	5.0	volts
FILAMENT CURRENT .....	14.5	amperes
TRANSCONDUCTANCE* .....	4000	μmhos
MU-FACTOR, Grid No.2 to Grid No.1 .....	5.1	
DIRECT INTERELECTRODE CAPACITANCES:		
Grid No.1 to plate (Base shell connected to ground) .....	0.12 max	μf
Grid No.1 to filament, grid No.2, and base shell .....	13	μf
Plate to filament, grid No.2, and base shell .....	4.6	μf
PLATE-SEAL TEMPERATURE, Continuous Service .....	170	°C

\* Plate volts, 2500; grid-No.2 volts, 500; plate milliamperes, 100.

**AF POWER AMPLIFIER AND MODULATOR—Class AB**

**Maximum CCS Ratings:**

DC PLATE VOLTAGE .....	4000 max	volts
DC GRID-NO.2 VOLTAGE .....	600 max	volts
MAXIMUM-SIGNAL DC PLATE CURRENT* .....	350 max	ma
GRID-NO.2 INPUT* .....	35 max	watts
GRID-NO.1 INPUT* .....	10 max	watts
PLATE DISSIPATION* .....	250 max	watts

**PLATE-MODULATED RF POWER AMPLIFIER—Class C Telephony**

**Maximum CCS Ratings:**

DC PLATE VOLTAGE .....	3200 max	volts
DC GRID-NO.2 VOLTAGE .....	600 max	volts
DC GRID-NO.1 VOLTAGE .....	-500 max	volts
DC PLATE CURRENT .....	275 max	ma
GRID-NO.2 INPUT .....	35 max	watts
GRID-NO.1 INPUT .....	10 max	watts
PLATE DISSIPATION .....	165 max	watts

**RF POWER AMPLIFIER AND OSCILLATOR—Class C Telephony  
and**

**Maximum CCS Ratings: RF POWER AMPLIFIER—Class C FM Telephony**

DC PLATE VOLTAGE .....	4000 max	volts
DC GRID-NO.2 VOLTAGE .....	600 max	volts
DC GRID-NO.1 VOLTAGE .....	-500 max	volts
DC PLATE CURRENT .....	350 max	ma
GRID-NO.2 INPUT .....	35 max	watts
GRID-NO.1 INPUT .....	10 max	watts
PLATE DISSIPATION .....	250 max	watts

**BEAM POWER TUBE**

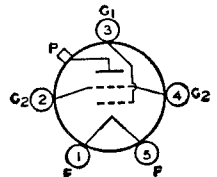

**4-400A**

Forced-air-cooled thoriated-tungsten-filament type used as af power amplifier and modulator and as rf power amplifier and oscillator. May be used with full input up to 110 Mc. Class C

Telephony maximum CCS plate dissipation, 400 watts. Requires Special Metal-Shell Giant five-contact socket and may be operated in vertical position only, base up or down. OUTLINE 40, *Outlines* Section.



## Technical Data

FILAMENT VOLTAGE .....	5.0	volts
FILAMENT CURRENT .....	14.5	amperes
TRANSCONDUCTANCE* .....	4000	$\mu\text{mhos}$
MU-FACTOR, Grid No.2 to Grid No.1 .....	5.1	
DIRECT INTERELECTRODE CAPACITANCES:		
Grid No.1 to plate .....	0.12 <i>max</i>	$\mu\text{f}$
Grid No.1 to filament, grid No.2, and base shell .....	13	$\mu\text{f}$
Plate to filament, grid No.2, and base shell .....	4.6	$\mu\text{f}$
BASE SEAL TEMPERATURE .....	200 <i>max</i>	$^{\circ}\text{C}$
PLATE SEAL TEMPERATURE .....	225 <i>max</i>	$^{\circ}\text{C}$

\* Plate volts, 2500; grid-No.2 volts, 500; plate milliamperes, 100.

### AF POWER AMPLIFIER AND MODULATOR—Class AB

#### Maximum CCS Ratings:

DC PLATE VOLTAGE .....	4000 <i>max</i>	volts
DC GRID-NO.2 VOLTAGE .....	800 <i>max</i>	volts
MAXIMUM-SIGNAL DC PLATE CURRENT <sup>o</sup> .....	350 <i>max</i>	ma
GRID-NO.2 INPUT <sup>o</sup> .....	35 <i>max</i>	watts
GRID-NO.1 INPUT <sup>o</sup> .....	10 <i>max</i>	watts
PLATE DISSIPATION <sup>o</sup> .....	400 <i>max</i>	watts

<sup>o</sup> Averaged over any audio-frequency cycle of sine-wave form.

### PLATE-MODULATED RF POWER AMPLIFIER—Class C Telephony

#### Maximum CCS Ratings:

*At frequencies up to 110 Mc*

DC PLATE VOLTAGE .....	3200 <i>max</i>	volts
DC GRID-NO.2 VOLTAGE .....	600 <i>max</i>	volts
DC GRID-NO.1 VOLTAGE .....	-500 <i>max</i>	volts
DC PLATE CURRENT .....	275 <i>max</i>	ma
GRID-NO.2 INPUT .....	35 <i>max</i>	watts
GRID-NO.1 INPUT .....	10 <i>max</i>	watts
PLATE DISSIPATION .....	270 <i>max</i>	watts

### RF POWER AMPLIFIER AND OSCILLATOR—Class C Telegraphy and

### RF POWER AMPLIFIER—Class C FM Telephony

#### Maximum CCS Ratings:

*At frequencies up to 110 Mc*

DC PLATE VOLTAGE .....	4000 <i>max</i>	volts
DC GRID-NO.2 VOLTAGE .....	600 <i>max</i>	volts
DC GRID-NO.1 VOLTAGE .....	-500 <i>max</i>	volts
DC PLATE CURRENT .....	350 <i>max</i>	ma
GRID-NO.2 INPUT .....	35 <i>max</i>	watts
GRID-NO.1 INPUT .....	10 <i>max</i>	watts
PLATE DISSIPATION .....	400 <i>max</i>	watts

## BEAM POWER TUBE

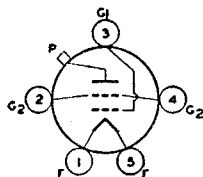

Forced-air-cooled, thoriated-tungsten-filament type used as af power amplifier and modulator and as rf power amplifier and oscillator at frequencies up to 110 Mc. Class C Telegraphy maximum CCS plate dissipation, 1000 watts. Requires Special five-contact socket and may be operated in vertical position only, base up or down. OUTLINE 62, *Outlines* Section. Plate shows an orange-red color when tube is operated at maximum CCS ratings. The 4-1000A is used principally for renewal purposes.

# 4-1000A

FILAMENT VOLTAGE (AC/DC) .....	7.5	volts
FILAMENT CURRENT .....	21	amperes
TRANSCONDUCTANCE* .....	10000	$\mu\text{mhos}$
MU-FACTOR, Grid No.2 to Grid No.1 .....	7	
DIRECT INTERELECTRODE CAPACITANCES:		
Grid No.1 to plate (Base shell connected to ground) .....	0.26	$\mu\text{f}$
Grid No.1 to filament, grid No.2, and base shell .....	28	$\mu\text{f}$
Plate to filament, grid No.2, and base shell .....	8	$\mu\text{f}$

\* Plate volts, 2500; grid No.2 volts, 500; plate milliamperes, 300.

## PLATE-MODULATED RF POWER AMPLIFIER—Class C Telephony

<b>Maximum CCS Ratings:</b>		<i>At frequencies up to 110 Mc</i>	
DC PLATE VOLTAGE.....	5000 <i>max</i>	volts	
DC GRID-NO.2 VOLTAGE.....	1000 <i>max</i>	volts	
DC PLATE CURRENT.....	600 <i>max</i>	ma	
GRID-NO.2 INPUT.....	75 <i>max</i>	watts	
PLATE DISSIPATION.....	670 <i>max</i>	watts	

## RF POWER AMPLIFIER AND OSCILLATOR—Class C Telegraphy and

### RF POWER AMPLIFIER—Class C FM Telephony

<b>Maximum CCS Ratings:</b>		<i>At frequencies up to 110 Mc</i>	
DC PLATE VOLTAGE.....	6000 <i>max</i>	volts	
DC GRID-NO.2 VOLTAGE.....	1000 <i>max</i>	volts	
DC PLATE CURRENT.....	700 <i>max</i>	ma	
GRID-NO.2 INPUT.....	75 <i>max</i>	watts	
PLATE DISSIPATION.....	1000 <i>max</i>	watts	

## POWER TRIODE

Forced-air-cooled heater-cathode type used as Class C plate-pulsed oscillator. May be used with full input up to 625 Mc. Maximum over-all length, 4-7/8 inches; maximum diameter, 2.062 inches. Filament volts (ac/dc), 5.0; amperes, 9.1; starting current, 16 *max* amperes. Direct interelectrode capacitances: grid to plate, 13  $\mu\mu\text{f}$ ; grid to cathode, 34  $\mu\mu\text{f}$ ; plate to cathode, 0.7  $\mu\mu\text{f}$ . Maximum CCS ratings as Plate-Pulsed

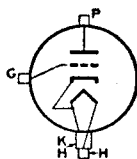

## 4C33

Oscillator—Class C: peak plate pulse supply volts, 18000 *max*; peak grid-bias volts, -2000 *max*; peak plate amperes from pulse supply, 30 *max*; peak rectified grid amperes, 4 *max*; dc plate milliamperes, 30 *max*; dc grid milliamperes, 4 *max*; peak plate input, 390000 *max* watts; plate dissipation, 250 *max* watts; pulse length, 5 *max* microseconds. The 4C33 is a DISCONTINUED type listed for reference only.

## 4CX250B

### BEAM POWER TUBE

See type 7203/4CX250B.

## 4CX250F

### BEAM POWER TUBE

See type 7204/4CX250F.

## 4D21

### BEAM POWER TUBE

See type 4-125A/4D21.

## 4E27/ 8001

### BEAM POWER TUBE

Thoriated-tungsten-filament type used as af power amplifier and modulator and as rf power amplifier and oscillator. May be used with full input up to 75 Mc. Class C Telegraphy

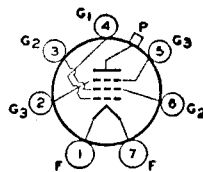

maximum CCS plate dissipation, 75 watts. Requires Giant seven-contact socket and may be operated in vertical position only, base up or down. *OUTLINE 37, Outlines* Section. Plate shows an orange-red color when the tube is operated at maximum CCS ratings.

FILAMENT VOLTAGE (AC/DC).....	5.0	volts
FILAMENT CURRENT.....	7.5	amperes
TRANSCONDUCTANCE (For plate current of 75 milliamperes).....	2800	$\mu\text{mhos}$
<b>DIRECT INTERELECTRODE CAPACITANCES:</b>		
Grid to plate (Base shell connected to ground).....	0.06	$\mu\mu\text{f}$
Grid No.1 to filament, grid No.3, grid No.2, internal shield, and base shell...	11	$\mu\mu\text{f}$
Plate to filament, grid No.3, grid No.2, internal shield, and base shell.....	4.6	$\mu\mu\text{f}$

**RF POWER AMPLIFIER AND OSCILLATOR—Class C Telegraphy  
and  
RF POWER AMPLIFIER—Class C FM Telephony**

**Maximum CCS Ratings:**

DC PLATE VOLTAGE.....	4000 <i>max</i>	volts
DC GRID-NO.2 VOLTAGE.....	750 <i>max</i>	volts
DC GRID-NO.1 VOLTAGE.....	-500 <i>max</i>	volts
DC PLATE CURRENT.....	150 <i>max</i>	ma
DC GRID-NO.2 CURRENT.....	30 <i>max</i>	ma
DC GRID-NO.1 CURRENT.....	25 <i>max</i>	ma
PLATE INPUT.....	300 <i>max</i>	watts
GRID-NO.2 INPUT.....	25 <i>max</i>	watts
PLATE DISSIPATION.....	75 <i>max</i>	watts

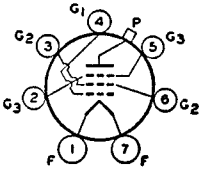

**BEAM POWER TUBE**

Thoriated-tungsten-filament type used as af power amplifier and modulator and as rf power amplifier and oscillator. May be used at full input up to 75 Mc. Class C Telegraphy max-

imum CCS plate dissipation, 125 watts. Requires Giant seven-contact socket and may be operated in vertical position only, base up or down. **OUTLINE 38, Outlines Section.** Plate shows a cherry-red color when the tube is operated at maximum CCS ratings.

FILAMENT VOLTAGE (AC/DC).....	5.0	volts
FILAMENT CURRENT.....	7.5	amperes
TRANSCONDUCTANCE*.....	2500	μmhos
MU-FACTOR, Grid No.2 to Grid No.1.....	5	
<b>DIRECT INTERELECTRODE CAPACITANCES:</b>		
Grid No.1 to plate (Base shell connected to ground).....	0.08 <i>max</i>	μμf
Grid No.1 to filament, grid No.3, grid No.2, and base shell.....	11	μμf
Plate to filament, grid No.3, grid No.2, and base shell.....	4.8	μμf
SEAL TEMPERATURE.....	225 <i>max</i>	°C

\* Plate volts, 2500; grid-No.2 volts, 500; grid-No.3 volts, 0; plate milliamperes, 50.

**RF POWER AMPLIFIER AND OSCILLATOR—Class C Telegraphy  
and  
RF POWER AMPLIFIER—Class C FM Telephony**

**Maximum CCS Ratings:**

DC PLATE VOLTAGE.....	4000 <i>max</i>	volts
DC GRID-NO. 3 VOLTAGE.....	75 <i>max</i>	volts
DC GRID-NO.2 VOLTAGE.....	750 <i>max</i>	volts
DC GRID-NO.1 VOLTAGE.....	-500 <i>max</i>	volts
DC PLATE CURRENT.....	200 <i>max</i>	ma
GRID-NO.3 INPUT.....	20 <i>max</i>	watts
GRID-NO.2 INPUT.....	20 <i>max</i>	watts
GRID-NO.1 INPUT.....	5 <i>max</i>	watts
PLATE DISSIPATION.....	125 <i>max</i>	watts

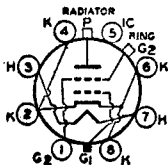

**BEAM POWER TUBE**

Forced-air-cooled heater-cathode types having integral plate radiators used as af power amplifiers and modulators and as rf power amplifiers and oscillators. May be used with full input up to 500 Mc. Maximum over-all length, 2-15/32 inches; maximum diameter, 1.635 inches. Type 4X150A heater volts (ac/dc), 6; amperes, 2.6. Type 4X150D heater volts (ac/dc), 26.5; amperes, 0.58. Direct interelectrode capac-

**4X150A  
4X150D**

itances; grid No.1 to plate, 0.02 μμf; grid No.2 to cathode, grid No.2, and heater, 16 μμf; plate to cathode, grid No.2, and heater, 4.2 μμf. Maximum CCS ratings as RF POWER AMPLIFIER AND OSCILLATOR—Class C Telegraphy: dc plate voltage, 1250 *max*; dc grid-No.2 voltage, 300 *max*; dc grid-No.1 voltage, -250 *max*; dc plate milliamperes, 250 *max*; grid-No.2 input, 12 *max* watts; grid-No.1 input, 2 *max* watts; plate dissipation, 150 *max* watts. The 4X150A and 4X150D are DISCONTINUED types listed for reference only; as replacements, the 7034/4X150A and 7035/4X150D, respectively, are directly interchangeable.

**BEAM POWER TUBE**

**4X500A**

Forced-air-cooled type having integral plate radiator and thoriated-tungsten filament used as rf power amplifier and oscillator. May be used with full input up to 120 Mc. Class C Telegraphy maximum CCS plate dissipation, 500 watts. May be operated in

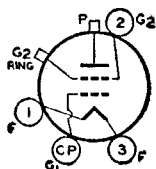

vertical position only, base up or down. OUTLINE 90, *Outlines* Section.

	<i>Min.</i>	<i>Avg.</i>	<i>Max.</i>	
FILAMENT VOLTAGE (AC/DC) .....	—	5.0	—	volts
FILAMENT CURRENT .....	12.2	—	13.7	amperes
TRANSCONDUCTANCE* .....		5200		μmhos
MU-FACTOR, Grid No.2 to Grid No.1 .....	4.5	—	6.5	
<b>DIRECT INTERELECTRODE CAPACITANCES:</b>				
Grid No.1 to plate .....	—	—	0.1	μμf
Grid No.1 to filament and grid No.2 .....	10.5	—	14.4	μμf
Plate to filament and grid No.2 .....	4.9	—	6.9	μμf
RADIATOR-CORE TEMPERATURE .....			150	°C
GLASS-METAL SEALS TEMPERATURE .....			150	°C

\* Plate volts, 2500; grid-No.2 volts, 500; plate milliamperes, 200.

**RF POWER AMPLIFIER AND OSCILLATOR—Class C Telegraphy  
and  
RF POWER AMPLIFIER—Class C FM Telephony**

**Maximum CCS Ratings:**

DC PLATE VOLTAGE .....	4000 <i>max</i>	volts
DC GRID-NO.2 VOLTAGE .....	500 <i>max</i>	volts
DC GRID-NO.1 VOLTAGE .....	-500 <i>max</i>	volts
DC PLATE CURRENT .....	350 <i>max</i>	ma
GRID-NO.2 INPUT .....	30 <i>max</i>	watts
GRID-NO.1 INPUT .....	10 <i>max</i>	watts
PLATE DISSIPATION .....	500 <i>max</i>	watts

**5-125B**

**BEAM POWER TUBE**

See type 4E27A/5-125B.

**5D22**

**BEAM POWER TUBE**

See type 4-250A/5D22.

**FULL-WAVE VACUUM  
RECTIFIER**

**5R4GY**

Coated-filament type used in power supply of transmitting and industrial equipment. Rated for a maximum peak inverse plate voltage of 2800 volts and maximum peak plate current of

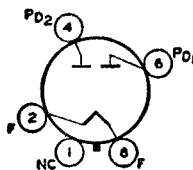

650 milliamperes at altitudes up to 20,000 feet, it may be used at altitudes up to 40,000 feet with reduced plate voltages. Requires Octal socket and may be operated in vertical position, base up or down, or in horizontal position with pins 1 and 4 in vertical plane. OUTLINE 31, *Outlines* Section.

FILAMENT VOLTAGE (AC/DC) .....	5	volts
FILAMENT CURRENT .....	2	amperes
TUBE VOLTAGE DROP (Approx.):		
Measured with applied dc at 250 milliamperes per plate .....	67	volts

**FULL-WAVE RECTIFIER**

<b>Maximum Ratings, Design-Center Values:</b>	<i>For Altitudes up to 40000 Feet</i>		<i>For Altitudes up to 20000 Feet</i>		
PEAK INVERSE PLATE VOLTAGE (No load) . . .	2100 max	2400 max	2800 max		volts
PEAK PLATE CURRENT (Per plate) . . . . .	650 max	650 max	650 max		ma
<b>DC OUTPUT CURRENT:</b>					
With capacitor input to filter . . . . .	250 max	175 max	150 max		ma
With choke input to filter . . . . .	250 max	250* max	175* max		ma

**Typical Operation with Capacitor-Input Filter:**

<b>RMS Plate-to-Plate Supply Voltage:</b>					
Full load . . . . .	1400	1500	1800		volts
No Load . . . . .	1500	1700	2000		volts
Filter Input Capacitor . . . . .	4	4	4		μf
Total Effective Plate-Supply Impedance (Per plate) <sup>Δ</sup>	125	500	575		ohms
DC Output Current . . . . .	250	150	150		ma
<b>DC Output Voltage at Input to Filter (Approx.):</b>					
At Half Load . . . . .	790	900	1060		volts
At Full Load . . . . .	700	810	950		volts
Voltage Regulation, Half-Load to Full-Load Current (Approx.) . . . . .	90	90	110		volts

**Typical Operation with Choke-Input Filter:**

<b>RMS Plate-to-Plate Supply Voltage:</b>					
Full Load . . . . .		1500	1900		volts
No Load . . . . .		1700	2000		volts
Filter Input Choke . . . . .		5	10		henries
DC Output Current . . . . .		250	175		ma
<b>DC Output Voltage at Input to Filter (Approx.):</b>					
At Half Load . . . . .		590	810		volts
At Full Load . . . . .		550	750		volts
Voltage Regulation, Half-Load to Full-Load Current (Approx.) . . . . .		40	60		volts

\* For choke not less than 5 henries.

Δ For choke not less than 10 henries.

Δ Indicated values for conditions shown will limit peak plate current to maximum rated value. When a filter-input capacitor larger than 4 microfarads is used, it may be necessary to use more plate-supply impedance than the value shown to limit the peak plate current to the rated value.

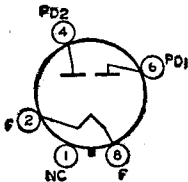

**FULL-WAVE VACUUM RECTIFIER**

5R4GYB

Coated-filament type used in power supply of transmitting and industrial equipment. Rated for a maximum peak inverse plate voltage of 3100 volts and maximum peak plate current of

715 milliamperes at altitudes up to 20,000 feet, it may be used at altitudes up to 40,000 feet with reduced plate voltages. Requires Octal socket and may be operated in vertical position, base up or down, or in horizontal position with pins 2 and 4 in vertical plane. **OUTLINE 20, Outlines Section.**

FILAMENT VOLTAGE (AC/DC) <sup>°</sup> . . . . .	5	volts
FILAMENT CURRENT . . . . .	2	amperes

**HALF-WAVE RECTIFIER**

<b>Maximum Ratings:</b>	<i>For altitudes up to:</i>		40000	20000	feet
PEAK INVERSE PLATE VOLTAGE . . . . .			2650 max	3100 max	volts
AC PLATE SUPPLY VOLTAGE (Per plate, rms, without load) . . .				See Rating Chart I	
PEAK PLATE CURRENT (Per plate) . . . . .			715 max	715 max	ma
DC OUTPUT CURRENT (Per plate) . . . . .				See Rating Chart I	
HOT-SWITCHING TRANSIENT PLATE CURRENT (Per plate) . . . . .			■	■	
BULB TEMPERATURE (At hottest point) . . . . .			230 max	230 max	°C

**Typical Operation with Capacitor-Input Filter:**

	<i>For altitudes up to:</i>		40000	20000	feet
AC Plate-to-Plate Supply Voltage (rms, without load)	1400	1500	2000		volts
Filter-Input Capacitor . . . . .	20	20	20		μf
Total Effective Plate Supply Impedance (Per plate) <sup>•</sup>	225	250	375		ohms

### DC Output Voltage at Input to Filter (Approx.):

At Half Load, $ma=75$ .....	-	910	1210	volts
At Half Load, $ma=125$ .....	750	-	-	volts
At Full Load, $ma=150$ .....	-	800	1040	volts
At Full Load, $ma=250$ .....	605	-	-	volts
Voltage Regulation, Half-Load to Full-Load Current, (Approx.).....	145	110	170	volts
DC Output Current.....	250	150	150	ma

### Typical Operation with Choke-Input Filter:

AC Plate-to-Plate Supply Voltage (rms, without load).....	<i>For altitudes up to:</i>		10000	20000	feet
Filter-Input Choke.....	1500	1900	1500	1900	volts
DC Output Voltage at Input to Filter (Approx.):	5	10	5	10	henries
For dc output:					
$ma=87.5$ .....	-	800	-	800	volts
$ma=125$ .....	600	-	600	-	volts
$ma=175$ .....	-	760	-	760	volts
$ma=250$ .....	560	-	560	-	volts
Voltage Regulation, Half-Load to Full-Load Current, (Approx.).....	40	40	40	40	volts
DC Output Current.....	250	175	250	175	ma

• See accompanying chart for operating conditions requiring delay in application of plate voltage until filament has reached operating temperature.

■ If hot-switching is required in operation, choke-input circuits are recommended. Such circuits limit the hot-switching current to a value no higher than that of the peak plate current. When capacitor-input circuits are used, a maximum value of 3 amperes should not be exceeded.

• Indicated values for conditions shown will limit peak plate current to maximum rated value. When a filter-input capacitor larger than 20 microfarads is used, it may be necessary to use more plate-supply impedance than the value shown to limit the peak plate current to the rated value.

### RATING CHART I

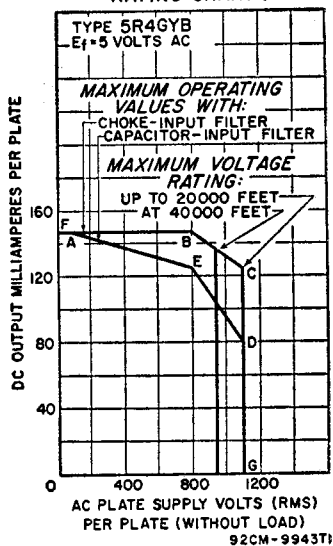

### OPERATING AREAS FOR SIMULTANEOUS AND DELAYED APPLICATION OF PLATE VOLTAGE

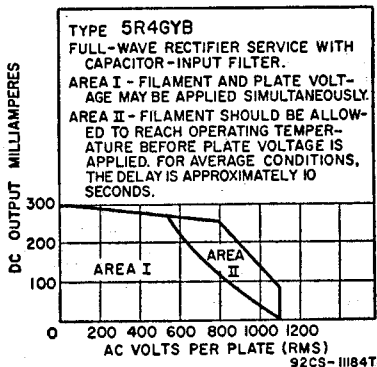

### POWER TRIODE

Forced-air-cooled type having integral radiator used as a power amplifier and modulator and as rf power amplifier and oscillator at frequencies up to 160 Mc. Maximum over-all length, 8-23/32 inches; maximum diameter, 1-29/32 inches. Filament volts (ac/dc), 11.0; amperes, 12.1; starting current, 24 max amperes. Direct interelectrode capacitances: grid to plate, 4.4  $\mu\mu\text{f}$ ; grid to filament, 4.6  $\mu\mu\text{f}$ ; plate to filament, 3.2  $\mu\mu\text{f}$ . Maximum CCS ratings as RF POWER AMPLIFIER AND OSCILLATOR: dc plate volts, 3000 max; dc grid volts, -500 max; dc plate milliamperes, 500 max; dc grid milliamperes, 150 max; plate input, 1500 max watts; plate dissipation 600 max watts. The 6C24 is a DISCONTINUED type listed for reference only. As a replacement, the 5786 is a similar type although not directly interchangeable.

## 6C24

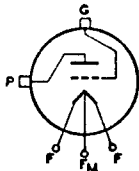

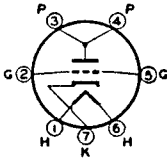

**POWER TRIODE**

**6F4**

Acorn type having heater-cathode used as rf power amplifier and oscillator at frequencies up to 1200 Mc. Class C Telegraphy maximum plate dissipation (design-center value), 2 watts.

Requires Acorn radial 7-contact socket and may be operated in any position. OUTLINE 1, *Outlines* Section. Plate shows no color when tube is operated at maximum CCS ratings.

HEATER VOLTAGE (AC/DC).....	6.3	volts
HEATER CURRENT.....	0.225	ampere
TRANSCONDUCTANCE*.....	5800	$\mu$ hos
AMPLIFICATION FACTOR*.....	17	
PLATE RESISTANCE (Approx.)*.....	2900	ohms

**DIRECT INTERELECTRODE CAPACITANCES:**

Grid to plate.....	1.8	$\mu$ f
Grid to cathode and heater.....	1.9	$\mu$ f
Plate to cathode and heater.....	0.6	$\mu$ f

\* Plate-supply volts, 80; cathode resistor, 150 ohms; plate milliamperes, 13.

**RF POWER AMPLIFIER AND OSCILLATOR—Class C Telegraphy and  
RF POWER AMPLIFIER—Class C FM Telephony**

**Maximum CCS Ratings, Design-Center Values:**

DC PLATE VOLTAGE.....	150 <i>max</i>	volts
DC PLATE SUPPLY VOLTAGE.....	300 <i>max</i>	volts
DC GRID VOLTAGE.....	-50 <i>max</i>	volts
DC PLATE CURRENT.....	20 <i>max</i>	ma
DC GRID CURRENT.....	8 <i>max</i>	ma
PLATE DISSIPATION.....	2 <i>max</i>	watts
<b>PEAK HEATER-CATHODE VOLTAGE:</b>		
Heater negative with respect to cathode.....	80 <i>max</i>	volts
Heater positive with respect to cathode.....	80 <i>max</i>	volts

**POWER TRIODE**

Thoriated-tungsten-filament type used as rf power amplifier and oscillator. May be used with full input up to 8 Mc. Requires Small four-contact socket and may be mounted in vertical position only, base down. OUTLINE 32, *Outlines* Section. Filament volts (ac/dc), 7.5; amperes, 1.25. Direct interelectrode capacitances; grid to plate, 7  $\mu$ f; grid to filament, 4  $\mu$ f; plate to filament, 3  $\mu$ f. Maximum CCS ratings as RF

**10Y**

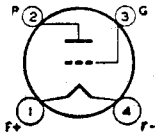

POWER AMPLIFIER AND OSCILLATOR, CLASS C TELEGRAPHY: dc plate volts, 450 *max*; dc grid volts, -200 *max*; dc plate milliamperes, 60 *max*; dc grid milliamperes, 15 *max*; plate input, 27 *max* watts; plate dissipation, 15 *max* watts. Plate shows no color when tube is operated at maximum CCS ratings. The 10Y is a DISCONTINUED type listed for reference only. The 801A is a direct replacement for the 10Y.

**FULL-WAVE MERCURY-VAPOR RECTIFIER**

**83**

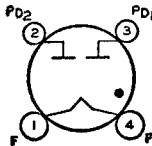

Coated-filament, glass type used to supply dc power of uniform voltage to receivers in which the rectified current requirements are subject to considerable variation. Tube requires four-

contact socket and should be operated in vertical position with base down. OUTLINE 32, *Outlines* Section. Maximum peak inverse plate volts, 1550; maximum peak plate amperes (per plate), 1.

# RCA Transmitting Tubes

FILAMENT VOLTAGE (AC)°.....	5	volts
FILAMENT CURRENT.....	3	amperes
TUBE VOLTAGE DROP (Approx.).....	15	volts

## FULL-WAVE RECTIFIER

### Maximum Ratings, (Design-Center Values):

PEAK INVERSE PLATE VOLTAGE.....	1550 <i>max</i>	volts
PEAK PLATE CURRENT (Per plate).....	1 <i>max</i>	ampere
DC OUTPUT CURRENT.....	225 <i>max</i>	ma
CONDENSED-MERCURY TEMPERATURE RANGE.....	20 to 60	°C

### Typical Operation (With Capacitor-Input Filter):

AC Plate-to-Plate Supply Voltage (rms).....	900	volts
Minimum Total Effective Plate-Supply Impedance (Per Plate)†.....	50	ohms
DC Output Current.....	225	ma

### Typical Operation (With Choke-Input Filter):

AC Plate-to-Plate Supply Voltage (rms).....	1100	volts
Minimum Filter-Input Choke.....	3	henries
DC Output Current.....	225	ma

† When a filter-input capacitor larger than 40  $\mu$ f is used, it may be necessary to use more plate-supply impedance than the minimum value shown to limit the peak plate current to the rated value.

° Plate voltage should not be applied until the filament has reached normal operating temperature.

## POWER TRIODE

Thoriated-tungsten-filament type used as af power amplifier and modulator and rf power amplifier and oscillator. May be used with full input up to 15 Mc and with reduced input up to 80 Mc. Requires Jumbo four-contact socket and may be mounted in vertical position only, base down. Maximum over-all length, 7-7/8 inches; maximum diameter, 2-5/16 inches. Filament volts (ac/dc), 10; amperes, 3.25. Direct

# 203A

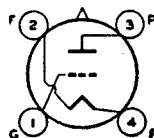

interelectrode capacitances: grid to plate, 14  $\mu$ f; grid to filament, 5.7  $\mu$ f; plate to filament, 4.4  $\mu$ f. Maximum CCS ratings as RF POWER AMPLIFIER AND OSCILLATOR, Class C Telegraphy: dc plate volts, 1250 *max*; dc grid volts, -400 *max*; dc plate milliamperes, 175 *max*; dc grid milliamperes, 60 *max*; plate input, 200 *max* watts; plate dissipation, 100 *max* watts. Plate shows no color when tube is operated at maximum CCS ratings. The 203A is a DISCONTINUED type listed for reference only. As a replacement, the 8005 is a similar type although not directly interchangeable.

## POWER TRIODE

Thoriated-tungsten-filament type used as af power amplifier and modulator and as rf power amplifier and oscillator. May be used with full input up to 3 Mc and with reduced input up to 30 Mc. Requires special end-mounting and may be mounted in vertical position with filament end up, or in horizontal position with plane of plate in vertical plane. Maximum over-all length, 14 5/8 inches; maximum diameter,

# 204A

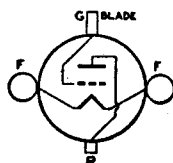

4-1/16 inches. Filament volts (ac/dc), 11; amperes, 3.85. Direct interelectrode capacitances: grid to plate, 15  $\mu$ f; grid to filament, 12.5  $\mu$ f; plate to filament, 2.3  $\mu$ f. Maximum CCS ratings as RF POWER AMPLIFIER AND OSCILLATOR, Class C Telegraphy: dc plate volts, 2500 *max*; dc grid volts, -500 *max*; dc plate milliamperes, 275 *max*; dc grid milliamperes, 80 *max*; rf grid amperes, 10 *max*; plate input, 690 *max* watts; plate dissipation, 250 *max* watts. Plate shows a barely perceptible red color when tube is operated at maximum CCS ratings. The 204A is a DISCONTINUED type listed for reference only.

## POWER TRIODE

Thoriated-tungsten-filament type used as af power amplifier and modulator and as rf power amplifier and oscillator. May be used with full input up to 15 Mc and with reduced input up to 80 Mc. Requires Jumbo four-contact socket and may be mounted in vertical position, base down, or in horizontal position with pins 1 and 3 in vertical plane. OUTLINE 52, Outlines Section. Filament volts (ac/dc), 10; amperes,

# 211

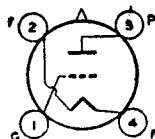



3.25. Direct interelectrode capacitances: grid to plate, 14  $\mu\text{f}$ ; grid to filament, 5.4  $\mu\text{f}$ ; plate to filament, 4.8  $\mu\text{f}$ . Maximum CCS ratings as RF POWER AMPLIFIER AND OSCILLATOR, Class C Telegraphy: dc plate volts, 1250 *max*; dc grid volts, -400 *max*; dc plate milliamperes, 175 *max*; dc grid milliamperes, 50 *max*; plate input, 220 *max* watts; plate dissipation, 100 *max* watts. Plate shows a barely perceptible red color when tube is operated at maximum CCS ratings. The 211 is a DISCONTINUED type listed for reference only.

**HALF-WAVE VACUUM  
RECTIFIER**

**217C**

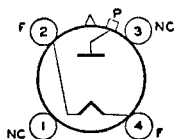

Thoriated-tungsten-filament type used in power supply of transmitting and industrial equipment. Requires Jumbo four-contact socket and may be mounted in vertical position, base down, or in horizontal position with pins 1 and 3 in vertical plane. OUTLINE 53, *Outlines* Section. Filament volts (ac), 10; amperes, 3.25.

Maximum ratings: peak inverse plate volts, 7500 *max*; peak plate amperes, 0.6 *max*; average plate amperes, 0.15 *max*. The 217C is a DISCONTINUED type listed for reference only. As a replacement, the 836 is a similar type although not directly interchangeable.

**HALF-WAVE MERCURY-  
VAPOR RECTIFIER**

**575A**

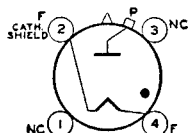

Coated-filament type used in power supply of transmitting and industrial equipment. Maximum peak inverse anode volts, 15000; maximum average anode amperes, 1.5. Requires

Jumbo four-contact socket and may be operated in vertical position only, base down. OUTLINE 65, *Outlines* Section.

FILAMENT VOLTAGE (AC)°	5.0	volts
FILAMENT CURRENT	10.0	amperes
PEAK TUBE VOLTAGE DROP (Approx.)	10	volts

° Filament voltage must be applied at least 30 seconds before application of anode voltage.

**HALF-WAVE RECTIFIER—In-Phase Operation**

*For supply frequency of 60 cps*

<b>Maximum Ratings:</b>			
PEAK INVERSE ANODE VOLTAGE	10000 <i>max</i>	15000 <i>max</i>	volts
ANODE CURRENT:			
Peak	7 <i>max</i>	6 <i>max</i>	amperes
Average $\bigcirc$	1.75 <i>max</i>	1.5 <i>max</i>	amperes
Fault, for duration of 0.1 second maximum	100 <i>max</i>	100 <i>max</i>	amperes
CONDENSED-MERCURY-TEMPERATURE RANGE	20 to 60	20 to 50	°C

**HALF-WAVE RECTIFIER—Quadrature Operation**

*For supply frequency of 60 cps*

<b>Maximum Ratings:</b>			
PEAK INVERSE ANODE VOLTAGE	10000 <i>max</i>	15000 <i>max</i>	volts
ANODE CURRENT:			
Peak	10 <i>max</i>	10 <i>max</i>	amperes
Average $\bigcirc$	2.5 <i>max</i>	2.5 <i>max</i>	amperes
Fault, for duration of 0.1 second maximum	100 <i>max</i>	100 <i>max</i>	amperes
CONDENSED-MERCURY-TEMPERATURE RANGE	20 to 60	20 to 50	°C

$\bigcirc$  Averaged over any interval of 20 seconds maximum.

**FULL-WAVE GAS AND  
MERCURY-VAPOR RECTIFIER**

**604/7014**

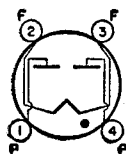

Coated-filament type used in industrial equipment. Maximum peak inverse anode volts, 900; average anode amperes, 2.5. Requires Super-Jumbo four-contact socket and may be operated in vertical position only, base down. OUTLINE 50, *Outlines* Section.

FILAMENT VOLTAGE <sup>°</sup> .....	2.5	volts
FILAMENT CURRENT.....	11.5	amperes
PEAK TUBE VOLTAGE DROP (Approx.).....	10	volts

<sup>°</sup> Filament voltage must be applied at least 15 seconds before application of anode voltage.

**FULL-WAVE RECTIFIER**

**Maximum Ratings:**

PEAK INVERSE ANODE VOLTAGE.....	900 <i>max</i>	volts
ANODE CURRENT:		
Peak.....	10 <i>max</i>	amperes
Average $\varnothing$ .....	2.5 <i>max</i>	amperes
Fault.....	150 <i>max</i>	amperes
CONDENSED-MERCURY-TEMPERATURE RANGE.....	0 to 90	°C

$\varnothing$  Averaged over any interval of 5 seconds maximum.

**HALF-WAVE MERCURY-VAPOR RECTIFIER**

**615/7018**

Coated-filament type used in industrial equipment. Maximum peak inverse anode volts, 2000; average anode amperes, 2.5. Requires Small four-contact socket and may be operated in vertical position only, base down. *OUTLINE 41, Outlines Section.*

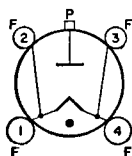

FILAMENT VOLTAGE <sup>°</sup> .....	2.5	volts
FILAMENT CURRENT.....	7	amperes
PEAK TUBE VOLTAGE DROP (Approx.).....	12	volts

<sup>°</sup> Filament voltage must be applied at least 20 seconds before application of anode voltage.

**HALF-WAVE RECTIFIER**

**Maximum Ratings:**

PEAK INVERSE ANODE VOLTAGE.....	2000 <i>max</i>	volts
ANODE CURRENT:		
Peak.....	10 <i>max</i>	amperes
Average $\varnothing$ .....	2.5 <i>max</i>	amperes
Fault.....	250 <i>max</i>	amperes
CONDENSED-MERCURY-TEMPERATURE RANGE.....	35 to 80	°C

$\varnothing$  Averaged over any interval of 5 seconds maximum.

**HALF-WAVE GAS AND MERCURY-VAPOR RECTIFIER**

**635/7019**

**635L/7020**

Coated-filament type used in industrial equipment. Maximum peak inverse anode volts, 1000; average anode amperes, 6.4. Type 635/7019 requires Super-Jumbo four-contact socket and may be operated in vertical position only, base down. Type 635L/7020 requires a special lug-type socket and may be operated in vertical position only, base down. Type 635/7019 *OUTLINE 60, Outlines Section*; type 635/7020 *OUTLINE 61, Outlines Section.*

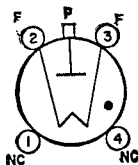

FILAMENT VOLTAGE <sup>°</sup> .....	2.5	volts
FILAMENT CURRENT.....	18	amperes
PEAK TUBE VOLTAGE DROP (Approx.).....	9	volts

<sup>°</sup> Filament voltage must be applied at least 60 seconds before application of anode voltage.

**HALF-WAVE RECTIFIER**

**Maximum Ratings:**

PEAK INVERSE ANODE VOLTAGE.....	1000 <i>max</i>	volts
---------------------------------	-----------------	-------

**ANODE CURRENT:**

Peak .....	77 <i>max</i>	amperes
Average $\bar{C}$ .....	6.4 <i>max</i>	amperes
Fault .....	770 <i>max</i>	amperes

**CONDENSED-MERCURY-TEMPERATURE RANGE** ..... 0 to 100 °C

$\bar{C}$  Averaged over any interval of 20 seconds maximum.

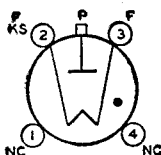

**HALF-WAVE MERCURY-VAPOR RECTIFIER**

Coated-filament type used in power supply of transmitting and industrial equipment. Maximum peak inverse anode volts, 15000; maximum average anode amperes, 1.5. Requires

673

Super-Jumbo four-contact socket and may be operated in vertical position only, base down. *OUTLINE 67, Outlines Section.* The 673 is electrically identical with the 575A.

**POWER TRIODE**

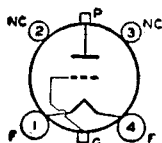

Thoriated-tungsten-filament type used as af power amplifier and modulator and as rf power amplifier and oscillator. May be used with full input up to 60 Mc. Requires Small four-contact socket and may be operated in vertical position only, base up or down. Maximum overall length, 6-3/8 inches; maximum diameter, 2-11/16 inches. Filament volts (ac/dc), 7.5; amperes, 3.1. Direct interelectrode capacitances:

800

grid to plate, 2.5  $\mu\text{f}$ ; grid to filament, 2.8  $\mu\text{f}$ ; plate to filament, 2.8  $\mu\text{f}$ . Maximum CCS ratings as 1R1 **POWER AMPLIFIER AND OSCILLATOR:** dc plate volts, 1250 *max*; dc grid volts, -400 *max*; dc plate milliamperes, 80 *max*; dc grid milliamperes, 25 *max*; plate input, 100 *max* watts; plate dissipation, 35 *max* watts. Plate shows no color when tube is operated at maximum CCS ratings. The 800 is a DISCONTINUED type listed for reference only. As a replacement, the 812A is a similar type although not directly interchangeable.

**POWER TRIODE**

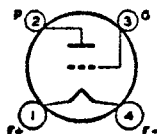

Thoriated-tungsten-filament type used as af power amplifier and modulator and as rf power amplifier and oscillator. May be used with full input up to 60 Mc and with reduced input

801A

up to 120 Mc. Class C Telegraphy maximum plate dissipation, CCS 20 watts. Requires Small four-contact socket and may be operated in vertical position with base down, or in horizontal position with pins 1 and 4 in vertical plane. *OUTLINE 32, Outlines Section.* Plate shows no color at maximum CCS ratings.

<b>FILAMENT VOLTAGE (AC/DC)</b> .....	7.5	volts
<b>FILAMENT CURRENT</b> .....	1.25	amperes
<b>AMPLIFICATION FACTOR</b> .....	8	
<b>DIRECT INTERELECTRODE CAPACITANCES:</b>		
Grid to plate .....	6	$\mu\text{f}$
Grid to filament .....	4.5	$\mu\text{f}$
Plate to filament .....	1.5	$\mu\text{f}$

**AF POWER AMPLIFIER AND MODULATOR—Class B**

**Maximum CCS Ratings:**

<b>DC PLATE VOLTAGE</b> .....	600 <i>max</i>	volts
<b>MAXIMUM-SIGNAL DC PLATE CURRENT</b> <sup>■</sup> .....	70 <i>max</i>	ma
<b>MAXIMUM-SIGNAL PLATE INPUT</b> <sup>■</sup> .....	42 <i>max</i>	watts
<b>PLATE DISSIPATION</b> <sup>■</sup> .....	20 <i>max</i>	watts

<sup>■</sup> Averaged over any audio-frequency of sine-wave form.

**RF POWER AMPLIFIER AND OSCILLATOR—Class C Telegraphy  
and  
RF POWER AMPLIFIER—Class C FM Telephony**

**Maximum CCS Ratings:**

DC PLATE VOLTAGE.....	600 <i>max</i>	volts
DC GRID VOLTAGE.....	-200 <i>max</i>	volts
DC PLATE CURRENT.....	70 <i>max</i>	ma
DC GRID CURRENT.....	15 <i>max</i>	ma
PLATE INPUT.....	42 <i>max</i>	watts
PLATE DISSIPATION.....	20 <i>max</i>	watts

**802**

**POWER PENTODE**

Heater-cathode type used as af power amplifier and modulator and as rf power amplifier and oscillator. May be used with full input up to 30 Mc. For Class C Telegraphy operation at 55

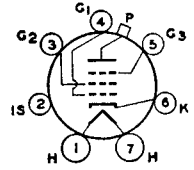

Mc, plate voltage and plate input should be reduced to 77 per cent of maximum ratings; at 100 Mc, to 55 per cent. Class C Telegraphy maximum plate dissipation, CCS 10 watts, ICAS 13 watts. Requires Medium seven-contact socket and may be operated in any position. OUTLINE 34, *Outlines* Section. Plate shows no color when the tube is operated at maximum CCS or ICAS ratings.

HEATER VOLTAGE (AC/DC).....	6.3	volts
HEATER CURRENT.....	0.9	ampere
TRANSCONDUCTANCE (For plate current of 20 milliamperes).....	2250	$\mu$ mhos
<b>DIRECT INTERELECTRODE CAPACITANCES:</b>		
Grid No.1 to plate (With external shielding).....	0.15 <i>max</i>	$\mu$ f
Grid No.1 to cathode, grid No.3, grid No.2, internal shield, and heater.....	11	$\mu$ f
Plate to cathode, grid No.3, grid. No.2, internal shield, and heater.....	6.8	$\mu$ f

**AF POWER AMPLIFIER AND MODULATOR—Class A**

**Maximum Ratings:**

	<i>CCS</i>	<i>ICAS</i>	
DC PLATE VOLTAGE.....	500 <i>max</i>	600 <i>max</i>	volts
DC GRID-NO.2 VOLTAGE.....	250 <i>max</i>	250 <i>max</i>	volts
PLATE INPUT.....	15 <i>max</i>	18 <i>max</i>	watts
GRID-NO.2 INPUT.....	3 <i>max</i>	3 <i>max</i>	watts
<b>PEAK HEATER-CATHODE VOLTAGE:</b>			
Heater negative with respect to cathode.....	100 <i>max</i>	100 <i>max</i>	volts
Heater positive with respect to cathode.....	100 <i>max</i>	100 <i>max</i>	volts

**Maximum Circuit Values (CCS or ICAS conditions):**

<b>Grid-No.1-Circuit Resistance:</b>			
For fixed-bias operation.....	0.01 <i>max</i>	megohm	
For cathode-bias operation.....	0.5 <i>max</i>	megohm	

**RF POWER AMPLIFIER AND OSCILLATOR—Class C Telegraphy  
and  
RF POWER AMPLIFIER—Class C FM Telephony**

**Maximum Ratings:**

	<i>CCS</i>	<i>ICAS</i>	
DC PLATE VOLTAGE.....	500 <i>max</i>	600 <i>max</i>	volts
DC GRID-NO.3 VOLTAGE.....	200 <i>max</i>	200 <i>max</i>	volts
DC GRID-NO.2 VOLTAGE.....	250 <i>max</i>	250 <i>max</i>	volts
DC GRID-NO.1 VOLTAGE.....	-200 <i>max</i>	-200 <i>max</i>	volts
DC PLATE CURRENT.....	60 <i>max</i>	60 <i>max</i>	ma
DC GRID-NO.1 CURRENT.....	7.5 <i>max</i>	7.5 <i>max</i>	ma
PLATE INPUT.....	25 <i>max</i>	33 <i>max</i>	watts
GRID-NO.3 INPUT.....	2 <i>max</i>	2 <i>max</i>	watts
GRID-NO.2 INPUT.....	6 <i>max</i>	6 <i>max</i>	watts
PLATE DISSIPATION.....	10 <i>max</i>	13 <i>max</i>	watts
<b>PEAK HEATER-CATHODE VOLTAGE:</b>			
Heater negative with respect to cathode.....	100 <i>max</i>	100 <i>max</i>	volts
Heater positive with respect to cathode.....	100 <i>max</i>	100 <i>max</i>	volts

### POWER PENTODE

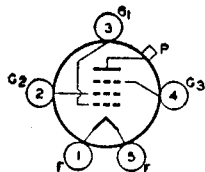

Thoriated-tungsten-filament type used as rf power amplifier and oscillator. May be used with full input up to 20 Mc and with reduced input up to 60 Mc. Class C Telegraphy maximum plate dissipation, CCS 125 watts. Requires Giant five-contact socket and may be operated in vertical position with base up or down, or in horizontal position with pins 2 and 5 in horizontal plane. OUTLINE 59, *Outlines* Section. Plate

# 803

shows a barely perceptible red color when tube is operated at maximum CCS ratings. The 803 is used principally for renewal purposes.

FILAMENT VOLTAGE (AC/DC)	10	volts
FILAMENT CURRENT	5	amperes
TRANSCONDUCTANCE (For plate current of 62.5 milliamperes)	4000	$\mu$ mhos
DIRECT INTERELECTRODE CAPACITANCES:		
Grid No.1 to plate (With external shielding)	0.15 <i>max</i>	$\mu$ f
Grid No.1 to filament, grid No.3, and grid No.2	17	$\mu$ f
Plate to filament, grid No.3, and grid No.2	29	$\mu$ f

#### RF POWER AMPLIFIER AND OSCILLATOR—Class C Telegraphy and

#### Maximum CCS Ratings: RF POWER AMPLIFIER—Class C FM Telephony

DC PLATE VOLTAGE	2000 <i>max</i>	volts
DC GRID-NO.3 VOLTAGE	500 <i>max</i>	volts
DC GRID-NO.2 VOLTAGE	600 <i>max</i>	volts
DC GRID-NO.1 VOLTAGE	-500 <i>max</i>	volts
DC PLATE CURRENT	175 <i>max</i>	ma
DC GRID-NO.1 CURRENT	50 <i>max</i>	ma
PLATE INPUT	350 <i>max</i>	watts
GRID-NO.3 INPUT	10 <i>max</i>	watts
GRID-NO.2 INPUT	30 <i>max</i>	watts
PLATE DISSIPATION	125 <i>max</i>	watts

### POWER PENTODE

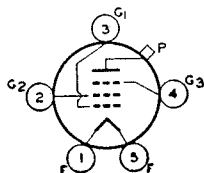

Thoriated-tungsten-filament type used as rf power amplifier and oscillator. May be used with full input up to 15 Mc and with reduced input up to 80 Mc. Class C Telegraphy maximum plate dissipation, CCS 40 watts, ICAS 50 watts. Requires Small five-contact socket and may be operated in vertical position with base down, or in horizontal position with pins 2 and 4 in vertical plane. OUTLINE 51, *Outlines* Section.

# 804

Plate shows no color when tube is operated at maximum CCS or ICAS ratings. The 804 is used principally for renewal purposes.

FILAMENT VOLTAGE (AC/DC)	7.5	volts
FILAMENT CURRENT	3.0	amperes
TRANSCONDUCTANCE (For plate current of 32 milliamperes)	3250	$\mu$ mhos
DIRECT INTERELECTRODE CAPACITANCES:		
Grid No.1 to plate (With external shielding)	0.03 <i>max</i>	$\mu$ f
Grid No.1 to filament, grid No.3, and grid No.2	13	$\mu$ f
Plate to filament, grid No.3, and grid No.2	14	$\mu$ f

#### RF POWER AMPLIFIER AND OSCILLATOR—Class C Telegraphy and

#### RF POWER AMPLIFIER—Class C FM Telephony

Maximum Ratings:	CCS	ICAS	
DC PLATE VOLTAGE	1250 <i>max</i>	1500 <i>max</i>	volts
DC GRID-NO.3 VOLTAGE	200 <i>max</i>	200 <i>max</i>	volts
DC GRID-NO.2 VOLTAGE	300 <i>max</i>	300 <i>max</i>	volts
DC GRID-NO.1 VOLTAGE	-300 <i>max</i>	-300 <i>max</i>	volts
DC PLATE CURRENT	95 <i>max</i>	100 <i>max</i>	ma
DC GRID-NO. 1 CURRENT	15 <i>max</i>	15 <i>max</i>	ma
PLATE INPUT	120 <i>max</i>	150 <i>max</i>	watts
GRID-NO. 3 INPUT	5 <i>max</i>	5 <i>max</i>	watts
GRID-NO. 2 INPUT	15 <i>max</i>	15 <i>max</i>	watts
PLATE DISSIPATION	40 <i>max</i>	50 <i>max</i>	watts

**POWER TRIODE**

**805**

Thoriated-tungsten-filament type used as af power amplifier and modulator and as rf power amplifier and oscillator. May be used with full input up to 30 Mc. For Class C Telegraphy

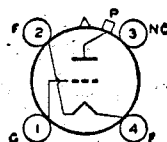

operation at 45 Mc, plate voltage and plate input should be reduced to 82 per cent of maximum ratings; at 80 Mc, to 55 per cent. Class C Telegraphy maximum CCS plate dissipation, 125 watts. Requires Jumbo four-contact socket and may be operated in vertical position with base down, or in horizontal position with pins 1 and 3 in vertical plane. **OUTLINE 53, Outlines Section.** Plate shows no color when tube is operated at maximum CCS ratings.

FILAMENT VOLTAGE (AC/DC).....	10	volts
FILAMENT CURRENT.....	3.25	amperes
DIRECT INTERELECTRODE CAPACITANCES:		
Grid to plate.....	6.0	$\mu\text{f}$
Grid to filament.....	7.5	$\mu\text{f}$
Plate to filament.....	9.0	$\mu\text{f}$

**AF POWER AMPLIFIER AND MODULATOR—Class B**

**Maximum CCS Ratings:**

DC PLATE VOLTAGE.....	1500 <i>max</i>	volts
MAXIMUM-SIGNAL DC PLATE CURRENT <sup>■</sup> .....	210 <i>max</i>	ma
MAXIMUM-SIGNAL PLATE INPUT <sup>■</sup> .....	315 <i>max</i>	watts
PLATE DISSIPATION <sup>■</sup> .....	125 <i>max</i>	watts

■ Averaged over any audio-frequency cycle of sine-wave form.

**RF POWER AMPLIFIER AND OSCILLATOR—Class C Telegraphy  
and  
RF POWER AMPLIFIER—Class C FM Telephony**

**Maximum CCS Ratings:**

DC PLATE VOLTAGE.....	1500 <i>max</i>	volts
DC GRID VOLTAGE.....	-500 <i>max</i>	volts
DC PLATE CURRENT.....	210 <i>max</i>	ma
DC GRID CURRENT.....	70 <i>max</i>	ma
PLATE INPUT.....	315 <i>max</i>	watts
PLATE DISSIPATION.....	125 <i>max</i>	watts

**POWER TRIODE**

**806**

Thoriated-tungsten-filament type used as af power amplifier and modulator and as rf power amplifier and oscillator. May be used with full input up to 30 Mc and with reduced input up to 100 Mc. Requires Jumbo four-contact socket and may be operated in vertical position only, base down. Maximum over-all length, 10 inches; maximum diameter, 3-13/16 inches. Filament volts (ac/dc), 5; amperes, 9.5. Direct interelectrode capacitances: grid to plate, 4  $\mu\text{f}$ ; grid to filament, 5.6  $\mu\text{f}$ ; plate to filament, 0.4  $\mu\text{f}$ . Maximum CCS ratings as AF POWER AMPLIFIER AND MODULATOR: dc plate volts, 3000 *max* (ICAS, 3300 *max*); maximum-signal dc plate milliamperes, 200 *max* (ICAS, 250 *max*); maximum-signal plate input, 500 *max* watts (ICAS, 825 *max* watts); plate dissipation, 150 *max* watts (ICAS, 225 *max* watts). Maximum CCS ratings as RF POWER AMPLIFIER AND OSCILLATOR: dc plate volts, 3000 *max* (ICAS, 3300 *max*); dc grid volts, -1000 *max*; dc plate milliamperes, 200 *max* (ICAS, 305 *max*); dc grid milliamperes, 50 *max*; plate input, 600 *max* watts (ICAS, 1000 *max* watts); plate dissipation, 150 *max* watts (ICAS, 225 *max* watts). Plate shows cherry-red color when tube is operated at maximum CCS ratings, and orange-red color at maximum ICAS ratings. The 806 is a DISCONTINUED type listed for reference only. As a replacement, the 8000 is a similar type although not directly interchangeable.

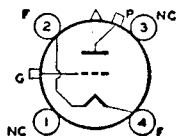

## BEAM POWER TUBE

**807**

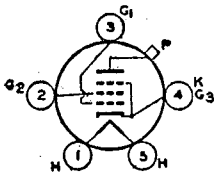

Heater-cathode type used as af power amplifier and modulator and as rf power amplifier and oscillator. May be used with full input up to 60 Mc. For Class C Telephony operation at

80 Mc, plate voltage and plate input should be reduced to 80 per cent of maximum ratings; at 125 Mc, to 55 per cent. Class C Telephony maximum plate dissipation, CCS 25 watts, ICAS 30 watts. Requires Small five-contact socket and may be operated in any position. OUTLINE 34, *Outlines* Section, except has no bayonet pin. Plate shows no color when tube is operated at maximum CCS or ICAS ratings.

HEATER VOLTAGE (AC/DC) .....	6.3 ± 0.6	volts
HEATER CURRENT .....	0.9	ampere
TRANSCONDUCTANCE (Approx.)* .....	6000	μmhos
MU-FACTOR, Grid No.2 to Grid No.1** .....	3	
DIRECT INTERELECTRODE CAPACITANCES:		
Grid No.1 to plate (With external shielding) .....	0.2 max	μf
Grid No.1 to cathode, grid No.3, grid No.2, and heater .....	12	μf
Plate to cathode, grid No.3, grid No.2, and heater .....	7	μf

\* Plate and grid-No.2 volts, 250; grid-No.1 volts, -14.

\*\* Plate and grid-No.2 volts, 250; grid-No.1 volts, -20.

### AF POWER AMPLIFIER AND MODULATOR—Class AB<sub>2</sub>

Maximum Ratings:	CCS	ICAS	
DC PLATE VOLTAGE .....	600 max	750 max	volts
DC GRID-NO.2 VOLTAGE .....	300 max	300 max	volts
MAXIMUM-SIGNAL DC PLATE CURRENT <sup>‡</sup> .....	120 max	120 max	ma
MAXIMUM-SIGNAL PLATE INPUT <sup>‡</sup> .....	60 max	90 max	watts
MAXIMUM-SIGNAL GRID-NO.2 INPUT <sup>‡</sup> .....	3.5 max	3.5 max	watts
PLATE DISSIPATION <sup>‡</sup> .....	25 max	30 max	watts
PEAK HEATER-CATHODE VOLTAGE:			
Heater negative with respect to cathode .....	135 max	135 max	volts
Heater positive with respect to cathode .....	135 max	135 max	volts

#### Typical Operation (Values are for 2 tubes):

	CCS			ICAS	
DC Plate Voltage .....	400	500	600	750	volts
DC Grid-No.2 Voltage <sup>‡</sup> .....	300	300	300	300	volts
DC Grid-No.1 Voltage .....	-28	-30	-32	-35	volts
Peak AF Grid-No.1-to-No.1 Voltage .....	80	86	80	96	volts
Zero-Signal DC Plate Current .....	72	60	48	30	ma
Maximum-Signal DC Plate Current .....	240	240	200	240	ma
Zero-Signal DC Grid-No.2 Current .....	2	0.9	0.7	0.5	ma
Maximum-Signal DC Grid-No.2 Current .....	20	20	18	20	ma
Effective Load Resistance (Plate to plate) .....	3700	4600	6900	7300	ohms
Maximum-Signal Driving Power (Approx.) .....	0.2	0.2	0.1	0.2	watt
Maximum-Signal Power Output (Approx.)* .....	55	75	86	120	watts

#### Maximum Circuit Values (CCS or ICAS conditions):

Grid-No.1-Circuit Resistance		
For fixed-bias operation .....	30000 max	ohms
For cathode-bias operation .....	Not recommended	

‡ Averaged over any audio-frequency cycle of sine-wave form.

‡ Preferably obtained from a separate source, or from the plate-voltage supply with a voltage divider.

\* With zero-impedance driver and perfect regulation, plate-circuit distortion does not exceed 2 per cent.

In practice, regulation of plate voltage, grid-No.2 voltage, and grid-No.1 voltage should not be greater than 5 per cent, 5 per cent, and 3 per cent, respectively.

### PLATE-MODULATED RF POWER AMPLIFIER—Class C Telephony

Maximum Ratings:	CCS	ICAS	
DC PLATE VOLTAGE .....	475 max	600 max	volts
DC GRID-NO.2 VOLTAGE .....	300 max	300 max	volts
DC GRID-NO.1 VOLTAGE .....	-200 max	-200 max	volts
DC PLATE CURRENT .....	83 max	100 max	ma
DC GRID-NO.1 CURRENT .....	5 max	5 max	ma
PLATE INPUT .....	40 max	60 max	watts

## RCA Transmitting Tubes

GRID-NO.2 INPUT .....	2.5 maz	2.5 maz	watts
PLATE DISSIPATION .....	16.5 maz	25 maz	watts
<b>PEAK HEATER-CATHODE VOLTAGE:</b>			
Heater negative with respect to cathode .....	135 maz	135 maz	volts
Heater positive with respect to cathode .....	135 maz	135 maz	volts

<b>Typical Operation:</b>	<i>CCS</i>			<i>ICAS</i>	
DC Plate Voltage .....	325	400	475	600	volts
DC Grid-No.2 Voltage <sup>‡</sup> .....	250	250	250	300	volts
From series resistor of .....	12500	25000	28000	37500	ohms
DC Grid-No.1 Voltage <sup>‡</sup> .....	-75	-75	-85	-85	volts
From grid-No.1 resistor of .....	21400	21400	21200	21200	ohms
Peak RF Grid-No.1 Voltage .....	95	95	108	107	volts
DC Plate Current .....	80	80	83	100	ma
DC Grid-No.2 Current .....	6	6	8	8	ma
DC Grid-No.1 Current (Approx.) .....	3.5	3.5	4	4	ma
Driving Power (Approx.) .....	0.3	0.3	0.4	0.4	watt
Power Output (Approx.) .....	17	22	28	44	watts

**Maximum Circuit Values (CCS or ICAS conditions):**

Grid-No.1-Circuit Resistance..... 30000 maz ohms

<sup>‡</sup> Obtained preferably from separate source modulated along with the plate supply, or from the modulated plate supply through series resistor of value shown.

<sup>‡</sup> Obtained from grid-No.1 resistor of value shown or from a combination of grid-No.1 resistor with either fixed supply or cathode resistor.

### RF POWER AMPLIFIER AND OSCILLATOR—Class C Telegraphy and RF POWER AMPLIFIER—Class C FM Telephony

<b>Maximum Ratings:</b>	<i>CCS</i>		<i>ICAS</i>	
DC PLATE VOLTAGE .....	600 maz	750 maz	750 maz	volts
DC GRID-NO.2 VOLTAGE .....	300 maz	300 maz	300 maz	volts
DC GRID-NO.1 VOLTAGE .....	-200 maz	-200 maz	-200 maz	volts
DC PLATE CURRENT .....	100 maz	100 maz	100 maz	ma
DC GRID-NO.1 CURRENT .....	5 maz	5 maz	5 maz	ma
PLATE INPUT .....	60 maz	75 maz	75 maz	watts
GRID-NO.2 INPUT .....	3.5 maz	3.5 maz	3.5 maz	watts
PLATE DISSIPATION .....	25 maz	30 maz	30 maz	watts
<b>PEAK HEATER-CATHODE VOLTAGE:</b>				
Heater negative with respect to cathode .....	135 maz	135 maz	135 maz	volts
Heater positive with respect to cathode .....	135 maz	135 maz	135 maz	volts

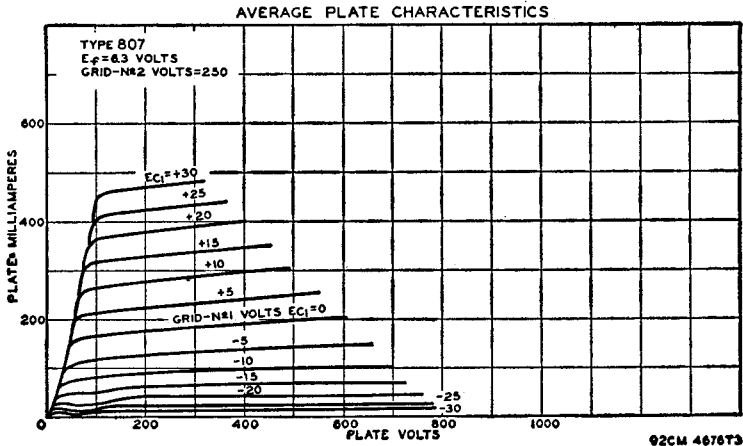

<b>Typical Operation:</b>	<i>CCS</i>			<i>ICAS</i>	
DC Plate Voltage .....	400	500	600	750	volts
DC Grid-No.2 Voltage <sup>‡</sup> .....	250	250	250	250	volts
From series resistor of .....	19000	31000	44000	62000	ohms



## Technical Data

DC Grid-No.1 Voltage •	-45	-45	-45	-45	volts
From grid-No.1 resistor of	11200	11200	11200	11200	ohms
From cathode resistor of	400	400	400	400	ohms
Peak RF Grid-No.1 Voltage	65	65	65	65	volts
DC Plate Current	100	100	100	100	ma
DC Grid-No.2 Current	8	8	8	8	ma
DC Grid-No.1 Current (Approx.)	4	4	4	4	ma
Driving Power (Approx.)	0.3	0.3	0.3	0.3	watt
Power Output (Approx.)	25	32	40	54	watts

### Maximum Circuit Values (CCS or ICAS conditions):

Grid-No.1-Circuit Resistance ..... 30000 *max* ohms

\* Obtained preferably from a separate source, from plate-voltage supply with a voltage divider, or through series resistor of value shown. Grid-No.2 voltage must not exceed 400 volts under key-up conditions.

• Obtained from fixed supply, by grid-No.1 resistor, by cathode resistor, or by combination methods.

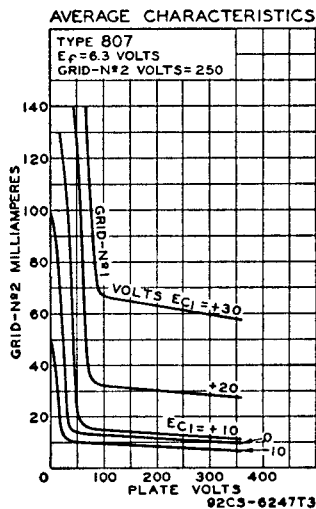
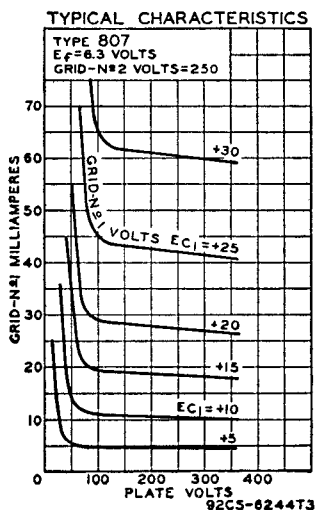

### POWER TRIODE

Thoriated-tungsten-filament type used as rf power amplifier and oscillator. May be used with full input up to 30 Mc and with reduced input up to 130 Mc. Requires Small four-contact socket and may be operated in vertical position only, base down. Maximum over-all length, 6-1/16 inches; maximum diameter, 2-3/16 inches. Filament volts (ac/dc), 7.5; amperes, 4. Direct interelectrode capacitances:

grid to plate, 2.8  $\mu\text{f}$ ; grid to filament, 5.3  $\mu\text{f}$ ; plate to filament, 0.25  $\mu\text{f}$ . Maximum CCS ratings as RF POWER AMPLIFIER AND OSCILLATOR, Class C Telegraphy: dc plate volts, 1500 *max*; dc grid volts, -400 *max*; dc plate milliamperes, 150 *max*; dc grid milliamperes, 35 *max*; plate input, 200 *max* watts; plate dissipation, 50 *max* watts. Plate shows cherry-red color when tube is operated at maximum CCS ratings. The 808 is a DISCONTINUED type listed for reference only. As a replacement, the 812A is a similar type although not directly interchangeable.

**808**

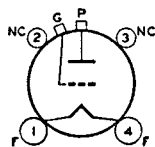

### POWER TRIODE

Thoriated-tungsten-filament type used as rf power amplifier and oscillator. May be used with full input up to 60 Mc and with reduced input up to 120 Mc. Class C Telegraphy maximum

**809**

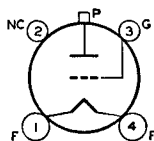

plate dissipation, CCS 25 watts, ICAS 30 watts. Requires Small four-contact socket and may be operated in vertical position with base down, or in horizontal position with pins 1 and 4 in vertical plane. **OUTLINE 44**, *Outlines* Section. Plate shows no color when tube is operated at maximum CCS ratings, and shows a barely perceptible red color at maximum ICAS ratings.

FILAMENT VOLTAGE (AC/DC).....	6.3	volts
FILAMENT CURRENT.....	2.5	amperes
AMPLIFICATION FACTOR.....	55	
DIRECT INTERELECTRODE CAPACITANCES:		
Grid to plate.....	6.7	$\mu\text{f}$
Grid to filament.....	5.7	$\mu\text{f}$
Plate to filament.....	0.9	$\mu\text{f}$

### RF POWER AMPLIFIER AND OSCILLATOR—Class C Telegraphy and

#### RF POWER AMPLIFIER—Class C FM Telephony

<b>Maximum Ratings:</b>	<i>CCS</i>	<i>ICAS</i>	
DC PLATE VOLTAGE.....	750 <i>max</i>	1000 <i>max</i>	volts
DC GRID VOLTAGE.....	-200 <i>max</i>	-200 <i>max</i>	volts
DC PLATE CURRENT.....	100 <i>max</i>	100 <i>max</i>	ma
DC GRID CURRENT.....	35 <i>max</i>	35 <i>max</i>	ma
PLATE INPUT.....	75 <i>max</i>	100 <i>max</i>	watts
PLATE DISSIPATION.....	25 <i>max</i>	30 <i>max</i>	watts

## POWER TRIODE

# 810

Thoriated-tungsten-filament type used as af power amplifier and modulator and as rf power amplifier and oscillator. May be used with full input up to 30 Mc and with reduced input

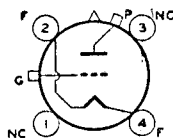

up to 100 Mc. Class C Telegraphy maximum plate dissipation, CCS 125 watts, ICAS 175 watts. Requires Jumbo four-contact socket and may be operated in vertical position with base down, or in horizontal position with pins 1 and 2 in vertical plane. **OUTLINE 55**, *Outlines* Section. Plate shows a barely perceptible red color when tube is operated at maximum CCS ratings, and shows a cherry-red color at maximum ICAS ratings.

FILAMENT VOLTAGE (AC/DC).....	10	volts
FILAMENT CURRENT.....	4.5	amperes
AMPLIFICATION FACTOR.....	36	
DIRECT INTERELECTRODE CAPACITANCES:		
Grid to plate.....	4.8	$\mu\text{f}$
Grid to filament.....	8.7	$\mu\text{f}$
Plate to filament.....	12	$\mu\text{f}$

### AF POWER AMPLIFIER AND MODULATOR—Class B

<b>Maximum Ratings:</b>	<i>CCS</i>	<i>ICAS</i>	
DC PLATE VOLTAGE.....	2500 <i>max</i>	2750 <i>max</i>	volts
MAXIMUM-SIGNAL DC PLATE CURRENT <sup>■</sup> .....	250 <i>max</i>	250 <i>max</i>	ma
MAXIMUM-SIGNAL PLATE INPUT <sup>■</sup> .....	425 <i>max</i>	510 <i>max</i>	watts
PLATE DISSIPATION <sup>■</sup> .....	125 <i>max</i>	175 <i>max</i>	watts

<sup>■</sup> Averaged over any audio-frequency cycle of sine-wave form.

### PLATE-MODULATED RF POWER AMPLIFIER—Class C Telephony

<b>Maximum Ratings:</b>	<i>CCS</i>	<i>ICAS</i>	
DC PLATE VOLTAGE.....	1600 <i>max</i>	2000 <i>max</i>	volts
DC GRID VOLTAGE.....	-500 <i>max</i>	-500 <i>max</i>	volts
DC PLATE CURRENT.....	210 <i>max</i>	250 <i>max</i>	ma
DC GRID CURRENT.....	70 <i>max</i>	75 <i>max</i>	ma
PLATE INPUT.....	335 <i>max</i>	500 <i>max</i>	watts
PLATE DISSIPATION.....	85 <i>max</i>	125 <i>max</i>	watts

**RF POWER AMPLIFIER AND OSCILLATOR—Class C Telegraphy**

and

**RF POWER AMPLIFIER—Class C FM Telephony**

Maximum Ratings:	CCS	ICAS	
DC PLATE VOLTAGE.....	2000 max	2500 max	volts
DC GRID VOLTAGE.....	-500 max	-500 max	volts
DC PLATE CURRENT.....	250 max	300 max	ma
DC GRID CURRENT.....	70 max	75 max	ma
PLATE INPUT.....	500 max	750 max	watts
PLATE DISSIPATION.....	125 max	175 max	watts

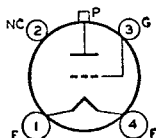

**POWER TRIODE**

Thoriated-tungsten-filament type used as af power amplifier and modulator and as rf power amplifier and oscillator. May be used with full input up to 30 Mc and with reduced input

**811A**

up to 100 Mc. Class C Telegraphy maximum plate dissipation, CCS 45 watts, ICAS 65 watts.

FILAMENT VOLTAGE (AC/DC).....	6.3	volts
FILAMENT CURRENT.....	4	amperes
AMPLIFICATION FACTOR*.....	160	
DIRECT INTERELECTRODE CAPACITANCES:		
Grid to plate.....	5.6	μf
Grid to filament.....	5.9	μf
Plate to filament.....	0.7	μf

\* Grid volts, -1; plate milliamperes, 20.

**AF POWER AMPLIFIER AND MODULATOR—Class B**

Maximum Ratings:	CCS	ICAS	
DC PLATE VOLTAGE.....	1250 max	1500 max	volts
MAXIMUM-SIGNAL DC PLATE CURRENT <sup>†</sup> .....	175 max	175 max	ma
MAXIMUM-SIGNAL PLATE INPUT <sup>†</sup> .....	165 max	235 max	watts
PLATE DISSIPATION <sup>†</sup> .....	45 max	65 max	watts

**Typical Operation (Values are for 2 tubes):**

DC Plate Voltage.....	750	1250	1000	1250	1500	volts
DC Grid Voltage <sup>†</sup> .....	0	0	0	0	-4.5	volts
Peak AF Grid-to-Grid Voltage.....	197	145	185	175	170	volts
Zero-Signal DC Plate Current.....	32	50	44	54	32	ma
Maximum-Signal DC Plate Current.....	350	260	350	350	313	ma
Effective Load Resistance (Plate to plate).....	5100	12400	7400	9200	12400	ohms
Maximum-Signal Driving Power (Approx.).....	9.7	3.8	7.5	6	4.4	watts
Maximum-Signal Power Output (Approx.).....	173	235	243	310	340	watts

† Averaged over any audio-frequency cycle of sine-wave form.

† For ac filament supply.

**LINEAR RF POWER AMPLIFIER—Class AB<sub>2</sub>**

*Single-Sideband Suppressed-Carrier Service*

Maximum Ratings:	Up to 30 Mc	CCS	ICAS	
DC PLATE VOLTAGE.....		1250 max	1500 max	volts
DC PLATE CURRENT AT PEAK OF ENVELOPE.....		175 max	175 max	ma
DC GRID CURRENT.....		50 max	50 max	ma
DC PLATE INPUT AT PEAK OF ENVELOPE.....		165 max	235 max	watts
PLATE DISSIPATION.....		45 max	60 max	watts

**Typical Operation with Two-Tone Modulation at 30 Mc:†**

DC Plate Voltage.....	1250	1500	volts
DC Grid Voltage <sup>†</sup> .....	0	-4.5	volts
Zero-Signal DC Plate Current.....	25	16	ma
Effective RF Load Resistance.....	5700	6000	ohms

## RCA Transmitting Tubes

DC Plate Current:			
Peak Envelope.....	130	157	ma
Average.....	91	110	ma
Average DC Grid Current.....	20	20	ma
Peak-Envelope Driver Power Output (Approx.) <sup>▲</sup> .....	7	8	watts
Output-Circuit Efficiency (Approx.).....	90	90	%
Distortion Products Level: <sup>¶</sup>			
Third Order.....	-26	-25	db
Fifth Order.....	-32	-30	db
Useful Power Output (Approx.): <sup>★</sup>			
Peak Envelope.....	120	160	watts
Average.....	60	80	watts

‡ Two-Tone Modulation operation refers to that class of amplifier service in which the input consists of two equal monofrequency rf signals having constant amplitude. These signals are produced in a single-sideband suppressed-carrier system when two equal-and-constant amplitude audio frequencies are applied to the input of the system.

□ Obtained preferably from a separate, well-regulated supply.

▲ Driver power output represents circuit losses and is the actual power measured at input to the grid circuit. The actual power required depends on the operating frequency and the circuit used.

\* Referenced to either of the two tones and without the use of feedback to enhance linearity.

★ This value of useful power is measured at load of output circuit having indicated efficiency.

### PLATE-MODULATED RF POWER AMPLIFIER—Class C Telephony

Maximum Ratings:	CCS	ICAS	
DC PLATE VOLTAGE.....	1000 max	1250 max	volts
DC GRID VOLTAGE.....	-200 max	-200 max	volts
DC PLATE CURRENT.....	125 max	150 max	ma
DC GRID CURRENT.....	50 max	50 max	ma
PLATE INPUT.....	115 max	175 max	watts
PLATE DISSIPATION.....	30 max	45 max	watts

#### Typical Operation:

DC Plate Voltage.....	1000	1250	volts
DC Grid Voltage <sup>δ</sup> .....	-55	-120	volts
From grid resistor of.....	1200	2700	ohms
Peak RF Grid Voltage.....	150	250	volts
DC Plate Current.....	115	140	ma
DC Grid Current (Approx.).....	45	45	ma
Driving Power (Approx.).....	6.1	10	watts
Power Output (Approx.).....	88	135	watts

δ Obtained from grid resistor of value shown or from a combination of grid resistor with either fixed supply or cathode resistor.

### RF POWER AMPLIFIER AND OSCILLATOR—Class C Telegraphy and

### RF POWER AMPLIFIER—Class C FM Telephony

Maximum Ratings:	CCS	ICAS	
DC PLATE VOLTAGE.....	1250 max	1500 max	volts
DC GRID VOLTAGE.....	-200 max	-200 max	volts
DC PLATE CURRENT.....	175 max	175 max	ma
DC GRID CURRENT.....	50 max	50 max	ma
PLATE INPUT.....	175 max	260 max	watts
PLATE DISSIPATION.....	45 max	65 max	watts

#### Typical Operation:

DC Plate Voltage.....	1250	1500	volts
DC Grid Voltage <sup>‡</sup> .....	-50	-70	volts
From grid resistor of.....	1100	1750	ohms
From cathode resistor of.....	270	330	ohms
Peak RF Grid Voltage.....	140	175	volts
DC Plate Current.....	140	173	ma
DC Grid Current (Approx.).....	45	40	ma
Driving Power (Approx.).....	5.7	7.1	watts
Power Output (Approx.).....	135	200	watts

‡ Obtained from fixed supply, by grid resistor, by cathode resistor, or by combination methods.

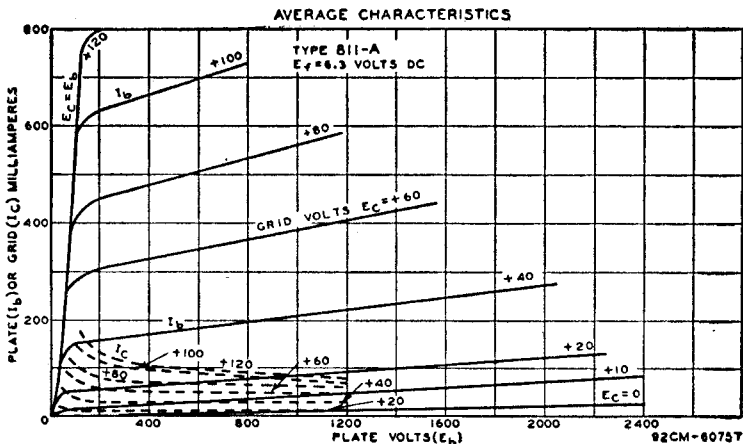

**OPERATING CONSIDERATIONS**

Type 811A requires Small four-contact socket and may be operated in vertical position with base down, or in horizontal position with pins 1 and 4 in vertical plane. OUTLINE 42, *Outlines* Section.

For operation at 60 Mc, plate voltage and plate input should be reduced to 89 per cent of maximum ratings; at 80 Mc, to 70 per cent; at 100 Mc, to 55 per cent. Plate shows no color when tube is operated at maximum CCS ratings, and shows a barely perceptible red color at maximum ICAS ratings.

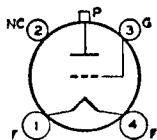

**POWER TRIODE**

Thoriated-tungsten-filament type used as af power amplifier and modulator and as rf power amplifier and oscillator. May be used with full input up to 30 Mc and with reduced input

**812A**

up to 100 Mc. Class C Telegraphy maximum plate dissipation, CCS 45 watts, ICAS 65 watts.

FILAMENT VOLTAGE (AC/DC) .....	6.3	volts
FILAMENT CURRENT .....	4	amperes
AMPLIFICATION FACTOR* .....	29	
DIRECT INTERELECTRODE CAPACITANCES:		
Grid to plate .....	5.5	$\mu\text{f}$
Grid to filament .....	5.4	$\mu\text{f}$
Plate to filament .....	0.77	$\mu\text{f}$

\*Grid volts, -30; plate milliamperes, 30.

**AF POWER AMPLIFIER AND MODULATOR—Class B**

<b>Maximum Ratings:</b>	<i>CCS</i>	<i>ICAS</i>	
DC PLATE VOLTAGE .....	1250 <i>max</i>	1500 <i>max</i>	volts
MAXIMUM-SIGNAL DC PLATE CURRENT <sup>■</sup> .....	175 <i>max</i>	175 <i>max</i>	ma
MAXIMUM-SIGNAL PLATE INPUT <sup>■</sup> .....	165 <i>max</i>	235 <i>max</i>	watts
PLATE DISSIPATION <sup>■</sup> .....	45 <i>max</i>	65 <i>max</i>	watts

**Typical Operation (Values are for 2 tubes):**

DC Plate Voltage .....	1250	1500	volts
DC Grid Voltage <sup>†</sup> .....	-40	-48	volts
Peak AF Grid-to-Grid Voltage .....	225	270	volts
Zero-Signal DC Plate Current .....	22	23	ma
Maximum-Signal DC Plate Current .....	260	310	ma
Effective Load Resistance (Plate to plate) .....	12200	13200	ohms
Maximum-Signal Driving Power (Approx.) .....	3.5	5	watts
Maximum-Signal Power Output (Approx.) .....	235	340	watts

<sup>■</sup> Averaged over any audio-frequency cycle of sine-wave form.

<sup>†</sup> For ac filament supply.

## PLATE-MODULATED RF POWER AMPLIFIER—Class C Telephony

Maximum Ratings:	CCS	ICAS	
DC PLATE VOLTAGE	1000 max	1250 max	volts
DC GRID VOLTAGE	-200 max	-200 max	volts
DC PLATE CURRENT	125 max	150 max	ma
DC GRID CURRENT	35 max	35 max	ma
PLATE INPUT	115 max	175 max	watts
PLATE DISSIPATION	30 max	45 max	watts

### Typical Operation:

DC Plate Voltage	1000	1250	volts
DC Grid Voltage $\delta$	-110	-115	volts
From grid resistor of	3400	3300	ohms
Peak RF Grid Voltage	220	240	volts
DC Plate Current	115	140	ma
DC Grid Current (Approx.)	33	35	ma
Driving Power (Approx.)	6.6	7.6	watts
Power Output (Approx.)	85	130	watts

$\delta$  Obtained from grid resistor of value shown or from a combination of grid resistor with either fixed supply or cathode resistor.

## RF POWER AMPLIFIER AND OSCILLATOR—Class C Telegraphy and RF POWER AMPLIFIER—Class C FM Telephony

Maximum Ratings:	CCS	ICAS	
DC PLATE VOLTAGE	1250 max	1500 max	volts
DC GRID VOLTAGE	-200 max	-200 max	volts
DC PLATE CURRENT	175 max	175 max	ma
DC GRID CURRENT	35 max	35 max	ma
PLATE INPUT	175 max	260 max	watts
PLATE DISSIPATION	45 max	65 max	watts

### Typical Operation:

DC Plate Voltage	1250	1500	volts
DC Grid Voltage $\delta$	-90	-120	volts
From grid resistor of	3000	4000	ohms
From cathode resistor of	530	590	ohms
Peak RF Grid Voltage	200	240	volts
DC Plate Current	140	173	ma
DC Grid Current (Approx.)	30	30	ma
Driving Power (Approx.)	5.4	6.5	watts
Power Output (Approx.)	130	190	watts

$\delta$  Obtained from fixed supply, by grid resistor, by cathode resistor, or by combination methods.

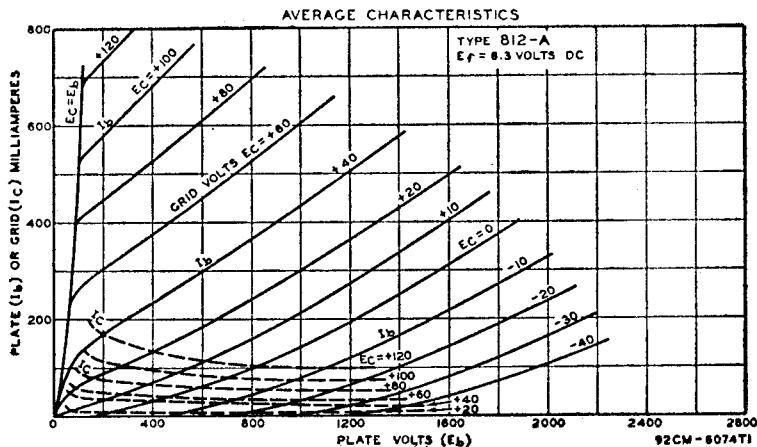

**OPERATING CONSIDERATIONS**

Type 812A requires Small four-contact socket and may be operated in vertical position with base down, or in horizontal position with pins 1 and 4 in vertical plane. OUTLINE 42, *Outlines* Section.

For operation at 60 Mc, plate voltage and plate input should be reduced to 89 per cent of maximum ratings; at 80 Mc, to 70 per cent; at 100 Mc, to 55 per cent. Plate shows no color when tube is operated at maximum CCS ratings, and shows a barely perceptible red color at maximum ICAS ratings.

When the 812A is used in the final amplifier or a preceding stage of a transmitter designed for break-in operation and oscillator keying, a small amount of fixed bias must be used to maintain the plate current at a safe value. With a plate voltage of 1500 volts, a fixed bias of at least -45 volts should be used.

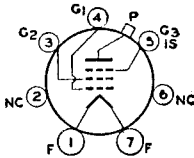

**BEAM POWER TUBE**

Thoriated-tungsten-filament type used as af power amplifier and modulator and as rf power amplifier and oscillator. May be used with full input up to 30 Mc and with reduced input

813

up to 120 Mc. Class C Telegraphy maximum plate dissipation, CCS 100 watts, ICAS 125 watts.

FILAMENT VOLTAGE (AC/DC) .....	10	volts
FILAMENT CURRENT .....	5	amperes
TRANSCONDUCTANCE* .....	3750	μmhos
MU-FACTOR, Grid No.2 to Grid No.1* .....	8.5	
<b>DIRECT INTERELECTRODE CAPACITANCES:</b>		
Grid No.1 to plate .....	0.25 max	μμf
Grid No.1 to filament, grid No.3, internal shield, grid No.2, and base shell .....	16.3	μμf
Plate to filament, grid No.3, internal shield, grid No.2, and base shell .....	14	μμf

\* Plate volts, 2000; grid-No.2 volts, 400; plate milliamperes, 50.

**AF POWER AMPLIFIER AND MODULATOR—Class AB1**

Maximum Ratings:	CCS	ICAS	
DC PLATE VOLTAGE .....	2250 max	2500 max	volts
DC GRID-NO.2 VOLTAGE .....	1100 max	1100 max	volts
MAXIMUM-SIGNAL DC PLATE CURRENT <sup>‡</sup> .....	180 max	225 max	ma
MAXIMUM-SIGNAL PLATE INPUT <sup>‡</sup> .....	360 max	450 max	watts
MAXIMUM-SIGNAL DC GRID-NO.2 INPUT <sup>‡</sup> .....	22 max	22 max	watts
PLATE DISSIPATION <sup>‡</sup> .....	100 max	125 max	watts

**Typical Operation (Values are for 2 tubes):**

DC Plate Voltage .....	1500	2000	2250	2500	volts
DC Grid-No.3 Voltage <sup>‡</sup> .....	0	0	0	0	volts
DC Grid-No.2 Voltage <sup>‡</sup> .....	750	750	750	750	volts
DC Grid-No.1 Voltage <sup>‡</sup> .....	-85	-90	-95	-95	volts
Peak AF Grid-No.1-to-Grid-No.1 Voltage .....	160	160	170	180	volts
Zero-Signal DC Plate Current .....	50	50	50	50	ma
Maximum-Signal DC Plate Current .....	305	265	255	290	ma
Zero-Signal DC Grid-No.2 Current .....	2	2	2	2	ma
Maximum-Signal DC Grid-No.2 Current .....	45	43	53	54	ma
Effective Load Resistance (Plate to plate) .....	9300	16000	20000	19000	ohms
Maximum-Signal Driving Power (Approx.) .....	0	0	0	0	watts
Maximum-Signal Power Output (Approx.) .....	260	335	380	490	watts

**Maximum Circuit Values (CCS or ICAS conditions):**

Grid-No.1-Circuit Resistance .....	30000 max	ohms
------------------------------------	-----------	------

<sup>‡</sup> Averaged over any audio-frequency cycle of sine-wave form.

▲ Grid No.3 should be connected to the mid-tap on the filament-transformer secondary winding or to the negative end of a filament operated on dc.

† Preferably obtained from a separate source or from the plate-voltage supply with a voltage divider.

‡ For ac filament supply.

**PLATE-MODULATED PUSH-PULL RF POWER AMPLIFIER—Class C Telephony**

Maximum Ratings:	CCS	ICAS	
DC PLATE VOLTAGE	1600 max	2000 max	volts
DC GRID-NO.2 VOLTAGE	400 max	400 max	volts
DC GRID-NO.1 VOLTAGE	-300 max	-300 max	volts
DC PLATE CURRENT	150 max	200 max	ma
DC GRID-NO.1 CURRENT	25 max	30 max	ma
PLATE INPUT	240 max	400 max	watts
GRID-NO.2 INPUT	15 max	20 max	watts
PLATE DISSIPATION	67 max	100 max	watts

**Typical Operation:**

DC Plate Voltage	1250	1600	2000	volts
DC Grid-No.3 Voltage <sup>*</sup>	0	0	0	volts
DC Grid-No.2 Voltage <sup>‡</sup>	300	300	350	volts
From series resistor of	27000	43000	41000	ohms
DC Grid-No.1 Voltage <sup>§</sup>	-160	-160	-175	volts
From grid-No.1 resistor of	12500	13500	11000	ohms
Peak RF Grid-No.1 Voltage	250	250	300	volts
DC Plate Current	150	150	200	ma
DC Grid-No.2 Current	35	30	40	ma
DC Grid-No.1 Current (Approx.)	13	12	16	ma
Driving Power (Approx.)	2.9	2.7	4.3	watts
Power Output (Approx.)	140	180	300	watts

**Maximum Circuit Values (CCS or ICAS conditions):**

Grid-No.1-Circuit Resistance	30000 max	ohms
------------------------------	-----------	------

<sup>\*</sup> Grid No.3 should be connected to the mid-tap on the filament-transformer secondary winding or to the negative end of a filament operated on dc.

<sup>‡</sup> Obtained preferably from separate source modulated along with the plate supply, or from the modulated plate supply through series resistor of value shown for each operating condition.

<sup>§</sup> Obtained from a grid-No.1 resistor of value shown or from a combination of grid-No.1 resistor with either fixed supply or cathode resistor.

**RF POWER AMPLIFIER AND OSCILLATOR—Class C Telephony  
and**

**RF POWER AMPLIFIER—Class C FM Telephony**

Maximum Ratings:	CCS	ICAS	
DC PLATE VOLTAGE	2000 max	2250 max	volts
DC GRID-NO.2 VOLTAGE	400 max	400 max	volts
DC GRID-NO.1 VOLTAGE	-300 max	-300 max	volts
DC PLATE CURRENT	180 max	225 max	ma
DC GRID-NO.1 CURRENT	25 max	30 max	ma
PLATE INPUT	360 max	500 max	watts
GRID-NO.2 INPUT	22 max	22 max	watts
PLATE DISSIPATION	100 max	125 max	watts

**Typical Operation:**

DC Plate Voltage	1250	1500	2000	2250	volts
DC Grid-No.3 Voltage <sup>*</sup>	0	0	0	0	volts
DC Grid-No.2 Voltage <sup>‡</sup>	300	300	400	400	volts
From series resistor of	27000	40000	36000	46000	ohms
DC Grid-No.1 Voltage <sup>§</sup>	-75	-90	-120	-155	volts
From grid-No.1 resistor of	6000	7500	12000	10000	ohms
From cathode resistor of	330	400	520	565	ohms
Peak RF Grid-No.1 Voltage	160	175	205	275	volts
DC Plate Current	180	180	180	220	ma
DC Grid-No.2 Current	35	30	45	40	ma
DC Grid-No.1 Current (Approx.)	12	12	10	15	ma
Driving Power (Approx.)	1.7	1.9	1.9	4.0	watts
Power Output (Approx.)	170	210	275	375	watts

**Maximum Circuit Values:**

Grid-No.1-Circuit Resistance	30000 max	ohms
------------------------------	-----------	------

<sup>\*</sup> Grid No.3 should be connected to the mid-tap on the filament-transformer secondary winding or to the negative end of a filament operated on dc.

<sup>‡</sup> Obtained from separate source, from plate-voltage supply with a voltage divider, or through series resistor of value shown for each operating condition. Grid-No. 2 voltage must not exceed 800 volts under key-up conditions.

<sup>§</sup> For ac filament supply.

<sup>\*</sup> Obtained from a grid-No.1 resistor, from cathode resistor, or from a combination of grid-No.1 resistor with either fixed supply or cathode resistor. If preceding stage is keyed, bias must be obtained partially from a fixed supply to limit the plate current and plate dissipation to a safe value.



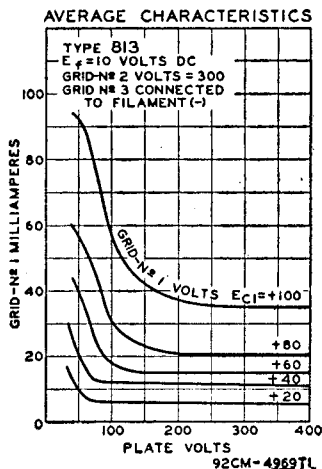
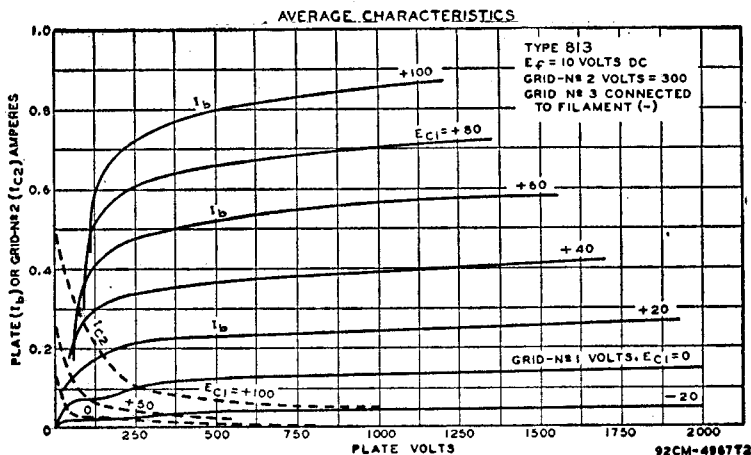

**OPERATING CONSIDERATIONS**

The 813 requires Giant seven-contact socket and may be operated in vertical position with base up or down, or in horizontal position with pins 2 and 6 in vertical plane. OUTLINE 49, *Outlines* Section.

For operation at 45 Mc, plate voltage and plate input should be reduced to 87 per cent of maximum ratings; at 60 Mc, to 75 per cent; at 120 Mc, to 50 per cent. Plate shows no color when tube is operated at maximum CCS or ICAS ratings.

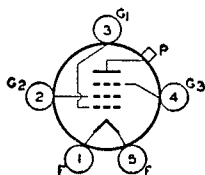

**BEAM POWER TUBE**

Thoriated-tungsten-filament type used as rf power amplifier and oscillator. May be used with full input up to 30 Mc. For operation at 50 Mc, plate voltage and plate input should be re-

**814**

duced to 80 per cent; at 75 Mc, to 64 per cent. Class C Telegraphy maximum plate dissipation, CCS 50 watts, ICAS 65 watts. Requires Small five-contact socket and may be operated in vertical position with base down, or in horizontal position with pins 2 and 4 in vertical plane. **OUTLINE 51, Outlines Section.** Plate shows no color when tube is operated at maximum CCS ratings, and shows a barely perceptible red color at maximum ICAS ratings.

FILAMENT VOLTAGE (AC/DC) .....	10	volts
FILAMENT CURRENT .....	3.25	amperes
TRANSCONDUCTANCE (For plate current of 39 milliamperes) .....	3300	$\mu$ hos
<b>DIRECT INTERELECTRODE CAPACITANCES:</b>		
Grid No.1 to plate .....	0.15 <i>max</i>	$\mu$ f
Grid No.1 to filament, grid No.3, and grid No.2 .....	13.5	$\mu$ f
Plate to filament, grid No.3, and grid No.2 .....	13.5	$\mu$ f

**RF POWER AMPLIFIER AND OSCILLATOR—Class C Telegraphy  
and**

**RF POWER AMPLIFIER—Class C FM Telephony**

<b>Maximum Ratings:</b>	<i>CCS</i>	<i>ICAS</i>	
DC PLATE VOLTAGE .....	1250 <i>max</i>	1500 <i>max</i>	volts
DC GRID-NO.2 VOLTAGE .....	400 <i>max</i>	400 <i>max</i>	volts
DC GRID-NO.1 VOLTAGE .....	-300 <i>max</i>	-300 <i>max</i>	volts
DC PLATE CURRENT .....	150 <i>max</i>	150 <i>max</i>	ma
DC GRID-NO.1 CURRENT .....	15 <i>max</i>	15 <i>max</i>	ma
PLATE INPUT .....	180 <i>max</i>	225 <i>max</i>	watts
GRID-NO.2 INPUT .....	10 <i>max</i>	10 <i>max</i>	watts
PLATE DISSIPATION .....	50 <i>max</i>	65 <i>max</i>	watts

**TWIN BEAM POWER TUBE**

**815**

Heater-cathode type used as af power amplifier and modulator and as rf power amplifier and oscillator. May be used with full input up to 125 Mc. For operation at 175 Mc, plate voltage

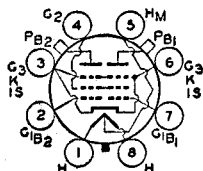

and plate input should be reduced to 80 per cent of maximum ratings; at 200 Mc, to 70 per cent. Class C Telegraphy maximum plate dissipation (per tube), CCS 20 watts, ICAS 25 watts. Requires Octal socket and may be operated in any position. **OUTLINE 24, Outlines Section.** Plates show no color when tube is operated at maximum CCS or ICAS ratings.

<b>HEATER ARRANGEMENT</b>	<i>Series</i>	<i>Parallel</i>	
HEATER VOLTAGE (AC/DC) .....	12.6	6.3	volts
HEATER CURRENT .....	0.8	1.6	amperes
TRANSCONDUCTANCE (Each unit, for plate current of 25 milliamperes.) .....	4000		$\mu$ hos
MU-FACTOR, Grid No.2 to Grid No.1., (Each unit) .....	6.5		
<b>DIRECT INTERELECTRODE CAPACITANCES (Each unit):</b>			
Grid No.1 to plate .....	0.25 <i>max</i>		$\mu$ f
Grid No.1 to cathode, grid No.3, internal shield, grid No.2, and heater mid-tap .....	14		$\mu$ f
Plate to cathode, grid No.3, internal shield, grid No.2, and heater mid-tap .....	8.5		$\mu$ f

**PUSH-PULL AF POWER AMPLIFIER AND MODULATOR—Class AB2**

*Values are on a per-tube basis*

<b>Maximum Ratings:</b>	<i>CCS</i>	<i>ICAS</i>	
DC PLATE VOLTAGE .....	400 <i>max</i>	500 <i>max</i>	volts
DC GRID-NO.2 VOLTAGE .....	225 <i>max</i>	225 <i>max</i>	volts
MAXIMUM-SIGNAL DC PLATE CURRENT <sup>■</sup> .....	150 <i>max</i>	150 <i>max</i>	ma
MAXIMUM-SIGNAL PLATE INPUT <sup>■</sup> .....	60 <i>max</i>	75 <i>max</i>	watts
MAXIMUM-SIGNAL GRID-NO.2 INPUT <sup>■</sup> .....	4.5 <i>max</i>	4.5 <i>max</i>	watts
PLATE DISSIPATION <sup>■</sup> .....	20 <i>max</i>	25 <i>max</i>	watts
<b>PEAK HEATER-CATHODE VOLTAGE:</b>			
Heater negative with respect to cathode .....	100 <i>max</i>	100 <i>max</i>	volts
Heater positive with respect to cathode .....	100 <i>max</i>	100 <i>max</i>	volts

■ Averaged over any audio-frequency cycle of sine-wave form.

**PLATE-MODULATED PUSH-PULL RF POWER AMPLIFIER—Class C Telephony**

Maximum Ratings:	CCS	ICAS	
DC PLATE VOLTAGE.....	325 max	400 max	volts
DC GRID-NO.2 VOLTAGE.....	225 max	225 max	volts
DC GRID-NO.1 VOLTAGE.....	-175 max	-175 max	volts
DC PLATE CURRENT.....	125 max	150 max	ma
DC GRID-NO.1 CURRENT.....	7 max	7 max	ma
PLATE INPUT.....	40 max	60 max	watts
GRID-NO.2 INPUT.....	4 max	4 max	watts
PLATE DISSIPATION.....	13.5 max	20 max	watts
<b>PEAK HEATER-CATHODE VOLTAGE:</b>			
Heater negative with respect to cathode.....	100 max	100 max	volts
Heater positive with respect to cathode.....	100 max	100 max	volts

**Maximum Circuit Values:**

Grid-No.1-Circuit Resistance.....	15000 max	ohms
-----------------------------------	-----------	------

**PUSH-PULL RF POWER AMPLIFIER AND OSCILLATOR—Class C Telegraphy  
and**

**PUSH-PULL RF POWER AMPLIFIER—Class C FM Telephony**

Maximum Ratings:	CCS	ICAS	
DC PLATE VOLTAGE.....	400 max	500 max	volts
DC GRID-NO.2 VOLTAGE.....	225 max	225 max	volts
DC GRID-NO.1 VOLTAGE.....	-175 max	-175 max	volts
DC PLATE CURRENT.....	150 max	150 max	ma
DC GRID-NO.1 CURRENT.....	7 max	7 max	ma
PLATE INPUT.....	60 max	75 max	watts
GRID-NO.2 INPUT.....	4.5 max	4.5 max	watts
PLATE DISSIPATION.....	20 max	25 max	watts
<b>PEAK HEATER-CATHODE VOLTAGE:</b>			
Heater negative with respect to cathode.....	100 max	100 max	volts
Heater positive with respect to cathode.....	100 max	100 max	volts

**Maximum Circuit Values:**

Grid-No.1-Circuit Resistance.....	15000 max	ohms
-----------------------------------	-----------	------

**HALF-WAVE  
MERCURY-VAPOR RECTIFIER**

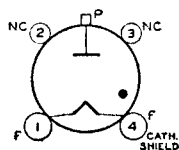

Coated-filament type used in power supply of transmitting and industrial equipment. Maximum peak inverse anode volts, 7500; maximum average anode milliamperes, 125. Re-

816

quires Small four-contact socket and may be operated in vertical position only, base down. OUTLINE 27, *Outlines* Section.

FILAMENT VOLTAGE (AC) °.....	2.5	volts
FILAMENT CURRENT.....	2.0	amperes
TUBE VOLTAGE DROP (Approx.).....	15	volts

° Filament voltage must be applied at least 10 seconds before the application of anode voltage.

**HALF-WAVE RECTIFIER**

**Maximum Ratings** (For power-supply frequency of 60 cps):

PEAK INVERSE ANODE VOLTAGE.....	7500 max	volts
<b>ANODE CURRENT:</b>		
Peak.....	500 max	ma
Average †.....	125 max	ma
Fault, for duration of 0.1 second maximum.....	5 max	amperes
CONDENSED-MERCURY-TEMPERATURE RANGE.....	20 to 60	°C

† Averaged over any interval of 30 seconds maximum.

## Operating Values:

*Circuit*  
(For circuit figures, refer to  
*Rectifier Considerations*  
Section)

	<i>Fig.</i>	<i>Max. Trans. Sec. Volts (RMS) E</i>	<i>Approx. DC Output Volts To Filter Eav</i>	<i>Max. DC Output Amperes Iav</i>	<i>Max. DC Output KW To Filter Pdc</i>
<b>In-Phase Operation</b>					
Half-Wave Single-Phase...	57	5300	2400	0.125	0.3
Full-Wave Single-Phase...	58	2600	2400	0.250	0.6
Series Single-Phase.....	59	5300	4800	0.250	1.2
Half-Wave Three-Phase...	60	3000	3600	0.750	2.7
<b>Quadrature Operation</b>					
Parallel Three-Phase.....	61	3000	3600	1.5	5.4
Series Three-Phase.....	62	3000	7200	0.75	5.4
Half-Wave Four-Phase....	63	2600	3500	0.45* 0.5 <sup>□</sup>	1.55* 1.75 <sup>□</sup>
Half-Wave Six-Phase.....	64	2600	3600	0.47* 0.5 <sup>□</sup>	1.70* 1.80 <sup>□</sup>

\* Resistive load.      □ Inductive load.

## POWER TRIODE

Thoriated-tungsten-filament type used as rf power amplifier and oscillator. May be used with full input up to 250 Mc and with reduced input up to 300 Mc. Requires Septar seven-contact socket and may be operated in vertical position only, base up or down. *OUTLINE 16, Outlines Section.* Filament volts (ac/dc), 7.5; amperes, 4. Direct interelectrode capacitances: grid to plate, 3  $\mu\mu\text{f}$ ; grid to filament, 3  $\mu\mu\text{f}$ , plate

to filament, 1.1  $\mu\mu\text{f}$ . Maximum CCS ratings as RF POWER AMPLIFIER AND OSCILLATOR, Class C Telegraphy with forced-air cooling: dc plate volts, 1000 *max*; dc grid volts, -600 *max*; dc plate milliamperes, 125 *max*; dc grid milliamperes, 40 *max*; plate input, 125 *max* watts; plate dissipation, 60 *max* watts. Plate shows an orange-red color when tube is operated at maximum CCS ratings. The 826 is a DISCONTINUED type listed for reference only.

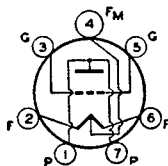

# 826

## BEAM POWER TUBE

Forced-air-cooled type having thoriated-tungsten filament and integral radiator used as rf power amplifier and oscillator at frequencies up to 110 Mc. Class C Telegraphy maximum CCS plate dissipation, 800 watts.

May be operated in vertical position only with grid-No.1 and filament terminals up. *OUTLINE 93, Outlines Section.*

FILAMENT VOLTAGE (AC/DC).....	7.5	volts
FILAMENT CURRENT.....	25	amperes
FILAMENT STARTING CURRENT.....	50 <i>max</i>	amperes
MU-FACTOR, Grid No.2 to Grid No.1*.....	16	
<b>DIRECT INTERELECTRODE CAPACITANCES (With external shielding):</b>		
Grid No.1 to plate.....	0.19 <i>max</i>	$\mu\mu\text{f}$
Grid No.1 to filament and grid No.2.....	18.5	$\mu\mu\text{f}$
Plate to filament and grid No.2.....	11	$\mu\mu\text{f}$
RADIATOR TEMPERATURE (Measured on core at end away from incoming air)	150 <i>max</i>	$^{\circ}\text{C}$
BULB TEMPERATURE, At hottest point.....	150 <i>max</i>	$^{\circ}\text{C}$
SEAL TEMPERATURE (Filament and grid No.1).....	175 <i>max</i>	$^{\circ}\text{C}$

\* Plate volts, 2000; grid-No.2 volts, 1100; plate milliamperes, 350.

### RF POWER AMPLIFIER AND OSCILLATOR—Class C Telegraphy and RF POWER AMPLIFIER—Class C FM Telephony

#### Maximum CCS Ratings:

DC PLATE VOLTAGE.....	3500 <i>max</i>	volts
DC GRID-NO.2 VOLTAGE.....	1000 <i>max</i>	volts
DC GRID-NO.1 VOLTAGE.....	-500 <i>max</i>	volts
DC PLATE CURRENT.....	500 <i>max</i>	ma
DC GRID-NO.1 CURRENT.....	150 <i>max</i>	ma
PLATE INPUT.....	1500 <i>max</i>	watts
GRID-NO.2 INPUT.....	150 <i>max</i>	watts
PLATE DISSIPATION.....	800 <i>max</i>	watts

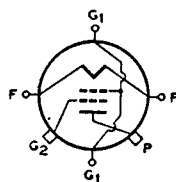

# 827R

**BEAM POWER TUBE**

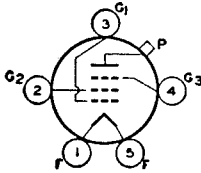

**828**

Thoriated-tungsten-filament type used as af power amplifier and modulator and as rf power amplifier and oscillator at frequencies up to 75 Mc. Filament volts (ac/dc), 10; amperes, 3.25. Direct interelectrode capacitances: grid No.1 to plate, 0.07 *max*  $\mu\text{f}$ ; grid No.1 to filament, grid No.3, and grid No.2, 12  $\mu\text{f}$ ; plate to filament, grid No.3, and grid No.2, 14  $\mu\text{f}$ . Maximum CCS ratings as RF POWER AMPLI-

FIER AND OSCILLATOR: dc plate volts, 1250 *max*; dc grid-No.3 volts, 100 *max*; dc grid-No.2 volts, 400 *max*; dc grid-No.1 volts, -300 *max*; dc plate ma., 160 *max*; dc grid-No.1 ma., 15 *max*; plate input, 200 *max* watts; grid-No.3 input, 5 *max* watts; grid-No.2 input, 16 *max* watts; plate dissipation, 70 *max* watts. Requires Small five-contact socket and may be operated in vertical position with base down, or in horizontal position with pins 2 and 4 in vertical plane. OUTLINE 51, *Outlines* Section. Plate shows no color when tube is operated at maximum CCS ratings, and shows a barely perceptible red color at maximum ICAS ratings. The 828 is a DISCONTINUED type listed for reference only.

**TWIN BEAM POWER TUBE**

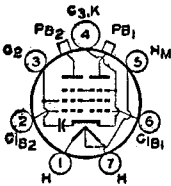

**829B**

Heater-cathode type having mid-tapped heater used as af power amplifier and modulator and as rf power amplifier and oscillator. May be used with full input up to 200 Mc. For operation

at 250 Mc, plate voltage and plate input should be reduced to 89 per cent of maximum ratings. Class C Telegraphy maximum plate dissipation (per tube) with natural cooling, CCS 30 watts, ICAS 40 watts; with forced-air cooling, CCS 40 watts, ICAS 45 watts. Requires Septar seven-contact socket and may be operated in vertical position with base up or down, or in horizontal position with pins 2 and 6 in horizontal plane. OUTLINE 22, *Outlines* Section. Plates show no color when tube is operated at maximum CCS or ICAS ratings.

HEATER ARRANGEMENT	Series	Parallel	
HEATER VOLTAGE (AC/DC) . . . . .	12.6	6.3	volts
HEATER CURRENT . . . . .	1.125	2.25	amperes
TRANSCONDUCTANCE (Each unit)* . . . . .		8500	$\mu\text{hos}$
MU-FACTOR, Grid No.2 to Grid No.1 (Each unit)** . . . . .		9	
DIRECT INTERELECTRODE CAPACITANCES (Each unit): <sup>■</sup>			
Grid No.1 to plate . . . . .		0.12 <i>max</i>	$\mu\text{f}$
Grid No.1 to cathode, grid No.3, grid No.2, and heater mid-tap . . . . .		14.5	$\mu\text{f}$
Plate to cathode, grid No.3, grid No.2, and heater mid-tap . . . . .		7	$\mu\text{f}$

\* Plate volts, 250; grid-No.2 volts, 175; plate milliamperes, 60.

\*\* Plate and grid-No.2 volts, 225; plate milliamperes, 60.

■ With external shield up to flange seal.

**PUSH-PULL AF POWER AMPLIFIER AND MODULATOR—Class AB<sub>1</sub>**

*Values are on a per-tube basis*

Maximum CCS Ratings:	Natural Cooling	
DC PLATE VOLTAGE . . . . .	750 <i>max</i>	volts
DC GRID-NO.2 VOLTAGE . . . . .	225 <i>max</i>	volts
MAXIMUM-SIGNAL DC PLATE CURRENT <sup>■</sup> . . . . .	250 <i>max</i>	ma
MAXIMUM-SIGNAL PLATE INPUT <sup>■</sup> . . . . .	100 <i>max</i>	watts
MAXIMUM-SIGNAL GRID-NO.2 INPUT <sup>■</sup> . . . . .	7 <i>max</i>	watts
PLATE DISSIPATION <sup>■</sup> . . . . .	30 <i>max</i>	watts
PEAK HEATER-CATHODE VOLTAGE:		
Heater negative with respect to cathode . . . . .	100 <i>max</i>	volts
Heater positive with respect to cathode . . . . .	100 <i>max</i>	volts
BULB TEMPERATURE . . . . .	235 <i>max</i>	°C
<b>Typical Operation:</b>		
DC Plate Voltage . . . . .	600	volts
DC Grid-No.2 Voltage <sup>♠</sup> . . . . .	200	volts
DC Grid-No.1 Voltage . . . . .	-18	volts
Peak AF Grid-No.1-to-Grid-No.1 Voltage . . . . .	36	volts

## RCA Transmitting Tubes

Zero-Signal DC Plate Current	40	ma
Maximum-Signal DC Plate Current	110	ma
Zero-Signal DC Grid-No.2 Current	4	ma
Maximum-Signal DC Grid-No.2 Current	26	ma
Effective Load Resistance (Plate to plate)	13750	ohms
Maximum-Signal Driving Power	0	watts
Maximum-Signal Power Output	44	watts

### Maximum Circuit Values:

#### Grid-No.1-Circuit Resistance:

For fixed-bias operation	0.1 max	megohm
For cathode-bias operation	Not recommended	

♣ Averaged over any audio-frequency cycle of sine-wave form.

♠ Obtained preferably from a separate source, or from the plate-voltage supply with a voltage divider.

### PLATE-MODULATED PUSH-PULL RF POWER AMPLIFIER—Class C Telephony

Maximum Ratings:	Natural Cooling		Forced-Air Cooling		
	CCS	ICAS	CCS	ICAS	
DC PLATE VOLTAGE	600 max	600 max	600 max	600 max	volts
DC GRID-No.2 VOLTAGE	225 max	225 max	225 max	250 max	volts
DC GRID-No.1 VOLTAGE	-175 max	-175 max	-175 max	-175 max	volts
DC PLATE CURRENT	212 max	212 max	212 max	240 max	ma
DC GRID-No.1 CURRENT	15 max	15 max	15 max	20 max	ma
PLATE INPUT	67.5 max	90 max	90 max	120 max	watts
GRID-No.2 INPUT	7 max	7 max	7 max	8 max <sup>♠</sup>	watts
PLATE DISSIPATION	21 max	28 max	28 max	40 max	watts
<b>PEAK HEATER-CATHODE VOLTAGE:</b>					
Heater negative with respect to cathode	100 max	100 max	100 max	100 max	volts
Heater positive with respect to cathode	100 max	100 max	100 max	100 max	volts
BULB TEMPERATURE	235 max	235 max	235 max	235 max	°C

### Typical Operation:

DC Plate Voltage	600	425	600	425	600	600	volts
DC Grid-No.2 Voltage <sup>♠</sup>	190	200	200	200	200	200	volts
From series resistor of	32000	11000	25000	11000	25000	20000	ohms
DC Grid-No.1 Voltage <sup>♠</sup>	-60	-60	-60	-60	-60	-70	volts
From grid-No.1 resistor of	15000	4300	8600	4300	8600	5400	ohms

### AVERAGE PLATE CHARACTERISTICS EACH UNIT

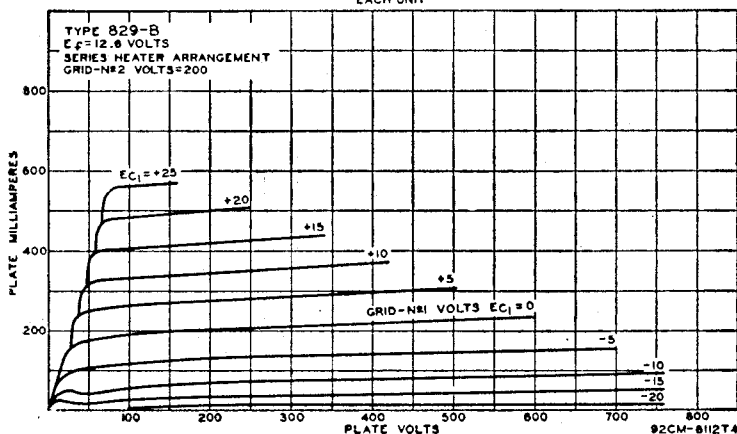

### Peak RF Grid-No.1-to-Grid-No.1

Voltage	138	160	144	160	144	180	volts
DC Plate Current	112	212	150	212	150	200	ma
DC Grid-No.2 Current	13	21	16	21	16	20	ma

## Technical Data

DC Grid-No.1 Current (Approx.)	4	14	7	14	7	13	ma
Driving Power (Approx.)	0.3	1	0.5	1	0.5	1.1	watts
Power Output (Approx.)	50	63	70	63	70	90	watts

### Maximum Circuit Values (CCS or ICAS conditions):

Grid-No.1-Circuit Resistance ..... 15000 max ohms

▲ In ICAS applications, at frequencies less than 20 Mc, where the duty factor does not exceed 0.2, maximum "on" period does not exceed 30 seconds, and average modulation factor does not exceed 0.25, maximum grid-No.2 input of 12 watts is permitted.

♣ Obtained preferably from separate source modulated along with the plate supply, or from the modulated plate supply through series resistor of value shown.

♢ Obtained from grid-No.1 resistor of value shown or from a combination of grid-No.1 resistor with either fixed supply or cathode resistor.

### PUSH-PULL RF POWER AMPLIFIER AND OSCILLATOR—Class C Telegraphy and

### PUSH-PULL RF POWER AMPLIFIER—Class C FM Telephony

Values are on a per-tube basis

Maximum Ratings:	Natural Cooling		Forced-Air Cooling		
	CCS	ICAS	CCS	ICAS	
DC PLATE VOLTAGE	750 max	750 max	750 max	750 max	volts
DC GRID-NO.2 VOLTAGE	225 max	225 max	225 max	250 max	volts
DC GRID-NO.1 VOLTAGE	-175 max	-175 max	-175 max	-175 max	volts
DC PLATE CURRENT	240 max	240 max	240 max	240 max	ma
DC GRID-NO.1 CURRENT	15 max	15 max	15 max	20 max	ma
PLATE INPUT	90 max	120 max	120 max	150 max	watts
GRID-NO.2 INPUT	7 max	7 max	7 max	8 max	watts
PLATE DISSIPATION	30 max	40 max	40 max	45 max	watts
PEAK HEATER-CATHODE VOLTAGE:					
Heater negative with respect to cathode	100 max	100 max	100 max	100 max	volts
Heater positive with respect to cathode	100 max	100 max	100 max	100 max	volts
BULB TEMPERATURE	265 max	265 max	235 max	235 max	°C

### TYPICAL CHARACTERISTICS

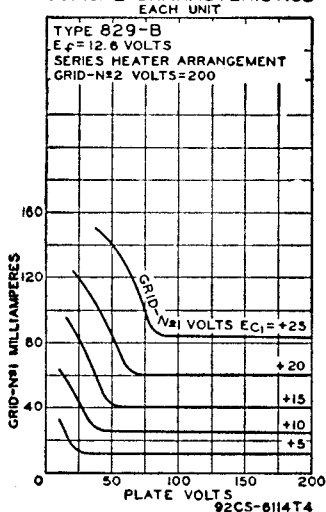

### TYPICAL CHARACTERISTICS

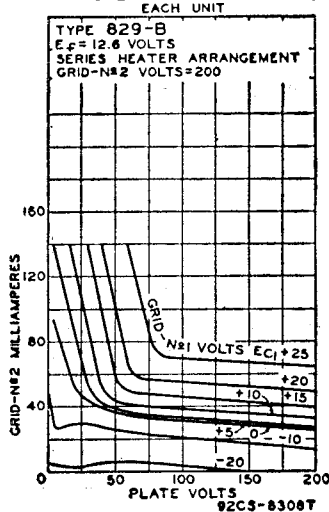

### Typical Operation:

DC Plate Voltage	750	500	750	500	750	750	volts
DC Grid-No.2 Voltage <sup>♣</sup>	190	200	200	200	200	200	volts
From series resistor of	40000	13000	32000	13000	32000	27500	ohms

DC Grid-No.1 Voltage <sup>A</sup> .....	-50	-45	-50	-45	-50	-50	volts
From grid-No.1 resistor of....	12500	3000	7200	3000	7200	4200	ohms
From cathode resistor of.....	360	170	270	170	270	200	ohms
Peak RF Grid-No.1-to-Grid-No.1 Voltage.....	116	128	124	128	124	134	volts
DC Plate Current.....	120	230	160	230	160	200	ma
DC Grid-No.2 Current.....	14	23	17	23	17	20	ma
DC Grid-No.1 Current (Approx.)	4	15	7	15	7	12	ma
Driving Power (Approx.).....	0.3	0.9	0.4	0.9	0.4	0.8	watt
Power Output (Approx.).....	70	83	90	83	90	115	watts

**Maximum Circuit Values (CCS or ICAS conditions):**

Grid-No.1-Circuit Resistance..... 15000 *max* ohms

<sup>\*</sup> Obtained preferably from separate source, from plate-voltage supply with a voltage divider, or through series resistor of value shown. The grid-No.2 voltage must not exceed 600 volts under key-up conditions.

<sup>^</sup> Obtained from fixed supply, by grid-No.1 resistor, by cathode resistor, or by combination methods.

## POWER TRIODE

Thoriated-tungsten-filament type used as af power amplifier and modulator and as rf power amplifier and oscillator. May be used with full input up to 15 Mc and with reduced input up to 60 Mc. Requires Small four-contact socket and may be operated in vertical position with base down, or in horizontal position with pins 1 and 4 in vertical plane. *OUTLINE 46, Outlines Section.* Plate shows no color when tube is operated at maximum CCS ratings. The 830B is used principally for renewal purposes.

# 830B

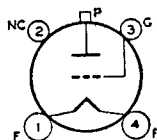

FILAMENT VOLTAGE (AC/DC) .....	10	volts
FILAMENT CURRENT.....	2	amperes
AMPLIFICATION FACTOR.....	25	
<b>DIRECT INTERELECTRODE CAPACITANCES:</b>		
Grid to plate.....	11	$\mu\mu\text{f}$
Grid to filament.....	5	$\mu\mu\text{f}$
Plate to filament.....	1.8	$\mu\mu\text{f}$

**Maximum CCS Ratings:**

	Class B Modulator	Class C Telegraphy	
DC PLATE VOLTAGE.....	1000 <i>max</i>	1000 <i>max</i>	volts
DC GRID VOLTAGE.....		-300 <i>max</i>	volts
DC PLATE CURRENT.....	150 <sup>■</sup> <i>max</i>	150 <i>max</i>	ma
DC GRID CURRENT.....		30 <i>max</i>	ma
PLATE INPUT.....	150 <sup>■</sup> <i>max</i>	150 <i>max</i>	watts
PLATE DISSIPATION.....	60 <i>max</i>	60 <i>max</i>	watts

<sup>\*</sup> For maximum-signal conditions.

<sup>■</sup> Averaged over any audio-frequency cycle of sine-wave form.

## TWIN BEAM POWER TUBE

# 832A

Heater-cathode type having mid-tapped heater used as rf power amplifier and oscillator. May be used with full input up to 200 Mc. For operation at 250 Mc, plate voltage and plate

input should be reduced to 89 per cent of maximum ratings. Class C Telegraphy maximum plate dissipation (per tube), CCS 15 watts, ICAS 20 watts. Requires Septar seven-contact socket and may be operated in any position. *OUTLINE 12, Outlines Section.* Plates show no color when tube is operated at maximum CCS or ICAS ratings.

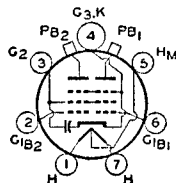

HEATER ARRANGEMENT.....	Series	Parallel	
HEATER VOLTAGE (AC/DC).....	12.6	6.3	volts



## Technical Data

HEATER CURRENT	0.8	1.6	amperes
TRANSCONDUCTANCE (Each unit)*	3500		μmhos
MU-FACTOR, Grid No.2 to Grid No.1 (Each unit)**	6.5		
DIRECT INTERELECTRODE CAPACITANCES (Each unit): <sup>□</sup>			
Grid No.1 to plate	0.07	<i>max</i>	μf
Grid No.1 to cathode, grid No.3, grid No.2, and heater mid-tap	8.0		μf
Plate to cathode, grid No.3, grid No.2, and heater mid-tap	3.8		μf
Grid No. 2 to cathode (including internal Grid-No. 2 bypass capacitor)	65		μf

\* Plate volts, 250; grid-No.2 volts, 135; plate milliamperes, 30.  
 \*\* Plate and grid-No.2 volts, 250; plate milliamperes, 30.  
 □ With external shield in plane of seal flange.

### PLATE-MODULATED PUSH-PULL RF POWER AMPLIFIER—Class C Telephony

Maximum Ratings:	CCS	ICAS	
DC PLATE VOLTAGE	600 <i>max</i>	600 <i>max</i>	volts
DC GRID-NO.2 VOLTAGE	250 <i>max</i>	250 <i>max</i>	volts
DC GRID-NO.1 VOLTAGE	-175 <i>max</i>	-175 <i>max</i>	volts
DC PLATE CURRENT	75 <i>max</i>	95 <i>max</i>	ma
DC GRID-NO.1 CURRENT	6 <i>max</i>	6 <i>max</i>	ma
PLATE INPUT	22 <i>max</i>	36 <i>max</i>	watts
GRID-NO.2 INPUT	3.4 <i>max</i>	5 <i>max</i>	watts
PLATE DISSIPATION	10 <i>max</i>	15 <i>max</i>	watts
PEAK HEATER-CATHODE VOLTAGE:			
Heater negative with respect to cathode	100 <i>max</i>	100 <i>max</i>	volts
Heater positive with respect to cathode	100 <i>max</i>	100 <i>max</i>	volts
BULB TEMPERATURE	200 <i>max</i>	200 <i>max</i>	°C

#### Typical Operation:

DC Plate Voltage	425	600	600	volts
DC Grid-No.2 Voltage <sup>‡</sup>	200	200	200	volts
From series resistor of	14000	25000	20000	ohms
DC Grid-No.1 Voltage <sup>§</sup>	-60	-65	-70	volts
From grid-No.1 resistor of	25000	25000	23000	ohms
Peak RF Grid-No.1-to-Grid-No.1 Voltage	140	150	160	volts
DC Plate Current	52	36	60	ma
DC Grid-No.2 Current	16	16	20	ma
DC Grid-No.1 Current (Approx.)	2.4	2.6	3	ma
Driving Power (Approx.)	0.15	0.18	0.21	watt
Power Output (Approx.)	16	17	26	watts

#### Maximum Circuit Values (CCS or ICAS conditions):

Grid-No.1-Circuit Resistance	25000 <i>max</i>	ohms
------------------------------	------------------	------

<sup>‡</sup> Obtained preferably from separate source modulated along with the plate supply or from the modulated plate supply through series resistor of value shown.

<sup>§</sup> Obtained from grid-No.1 resistor of value shown or from a combination of grid-No.1 resistor with either fixed supply or cathode resistor.

### PUSH-PULL RF POWER AMPLIFIER AND OSCILLATOR—Class C Telegraphy and PUSH-PULL RF POWER AMPLIFIER—Class C FM Telephony

Maximum Ratings:	CCS	ICAS	
DC PLATE VOLTAGE	750 <i>max</i>	750 <i>max</i>	volts
DC GRID-NO.2 VOLTAGE	250 <i>max</i>	250 <i>max</i>	volts
DC GRID-NO.1 VOLTAGE	-175 <i>max</i>	-175 <i>max</i>	volts
DC PLATE CURRENT	90 <i>max</i>	115 <i>max</i>	ma
DC GRID-NO.1 CURRENT	6 <i>max</i>	6 <i>max</i>	ma
PLATE INPUT	36 <i>max</i>	50 <i>max</i>	watts
GRID-NO.2 INPUT	5 <i>max</i>	5 <i>max</i>	watts
PLATE DISSIPATION	15 <i>max</i>	20 <i>max</i>	watts
PEAK HEATER-CATHODE VOLTAGE:			
Heater negative with respect to cathode	100 <i>max</i>	100 <i>max</i>	volts
Heater positive with respect to cathode	100 <i>max</i>	100 <i>max</i>	volts
BULB TEMPERATURE	200 <i>max</i>	200 <i>max</i>	°C

#### Typical Operation:

DC Plate Voltage	500	750	750	volts
------------------	-----	-----	-----	-------

## RCA Transmitting Tubes

DC Grid-No.2 Voltage <sup>a</sup> .....	200	200	200	volts
From series resistor of .....	21000	37000	25000	ohms
DC Grid-No.1 Voltage <sup>a</sup> .....	-65	-65	-50	volts
From grid-No.1 resistor of .....	25000	23000	12500	ohms
From cathode resistor of .....	730	1000	550	ohms
Peak RF Grid-No.1-to-Grid-No.1 Voltage .....	150	150	130	volts
DC Plate Current .....	72	48	65	ma
DC Grid-No.2 Current .....	14	15	22	ma
DC Grid-No.1 Current (Approx.) .....	2.6	2.8	4.0	ma
Driving Power (Approx.) .....	0.18	0.19	0.24	watt
Power Output (Approx.) .....	26	26	35	watts

### Maximum Circuit Values (CCS or ICAS conditions):

Grid-No.1-Circuit Resistance ..... 25000 max ohms

<sup>a</sup> Obtained from separate source, from plate-voltage supply with a voltage divider, or from series resistor of value shown. The grid-No.2 voltage must not exceed 600 volts under key-up conditions.

<sup>b</sup> Obtained from fixed supply, by grid-No.1 resistor, by cathode resistor, or by combination methods.

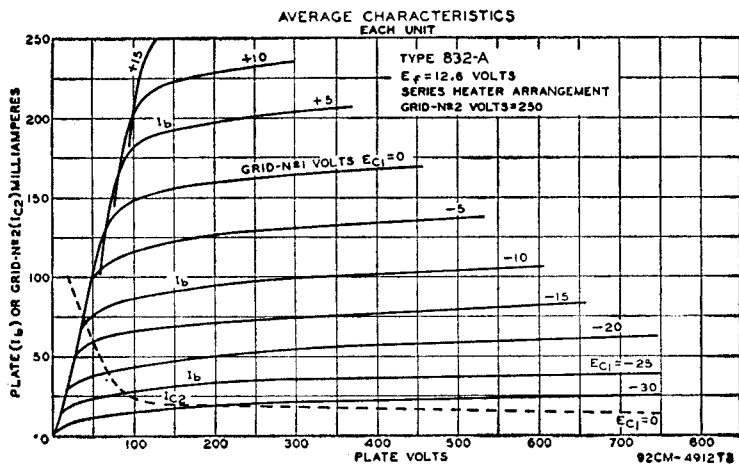
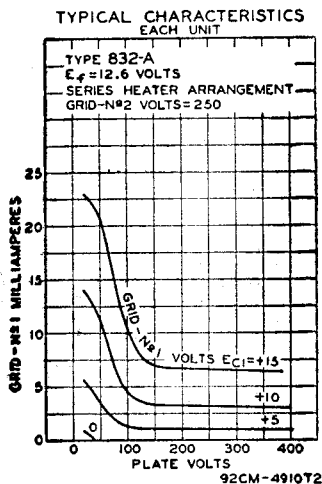

**POWER TRIODE**

**833A**

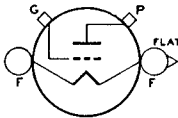

Thoriated-tungsten-filament type used as af power amplifier and modulator and as rf power amplifier and oscillator. May be used with full input up to 30 Mc with natural cooling (20

Mc with forced-air cooling), and with reduced input up to 75 Mc. Class C Telegraphy maximum plate dissipation with natural cooling, CCS 300 watts, ICAS 350 watts; with forced-air cooling, CCS 400 watts, ICAS 450 watts.

FILAMENT VOLTAGE (AC/DC) .....	10	volts
FILAMENT CURRENT .....	10	amperes
AMPLIFICATION FACTOR* .....	35	
DIRECT INTERELECTRODE CAPACITANCES:		
Grid to plate .....	6.3	$\mu\text{f}$
Grid to filament .....	12.3	$\mu\text{f}$
Plate to filament .....	8.5	$\mu\text{f}$

\* Grid volts, -10; plate milliamperes, 200.

**AF POWER AMPLIFIER AND MODULATOR—Class B**

	Natural Cooling		Forced-Air Cooling		
	CCS	ICAS	CCS	ICAS	
Maximum Ratings:					
DC PLATE VOLTAGE .....	3000 max	3300 max	4000 max	4000 max	volts
MAXIMUM-SIGNAL DC PLATE CURRENT <sup>†</sup> .....	500 max	500 max	500 max	500 max	ma
MAXIMUM-SIGNAL PLATE INPUT <sup>†</sup> .....	1125 max	1300 max	1600 max	1800 max	watts
PLATE DISSIPATION <sup>†</sup> .....	300 max	350 max	400 max	450 max	watts

Typical Operation (Values are for two tubes):

DC Plate Voltage .....	3000	3300	4000	4000	volts
DC Grid Voltage .....	-70	-80	-100	-100	volts
Peak AF Grid-to-Grid Voltage .....	400	440	480	510	volts
Zero-Signal DC Plate Current .....	100	100	100	100	ma
Maximum-Signal DC Plate Current .....	750	780	800	900	ma
Effective Load Resistance (Plate to plate) .....	9500	10500	12000	11000	ohms
Maximum-Signal Driving Power (Approx.) .....	20	30	29	38	watts
Maximum-Signal Power Output (Approx.) .....	1650	1900	2400	2700	watts

■ Averaged over any audio-frequency cycle of sine-wave form.

† For ac filament supply.

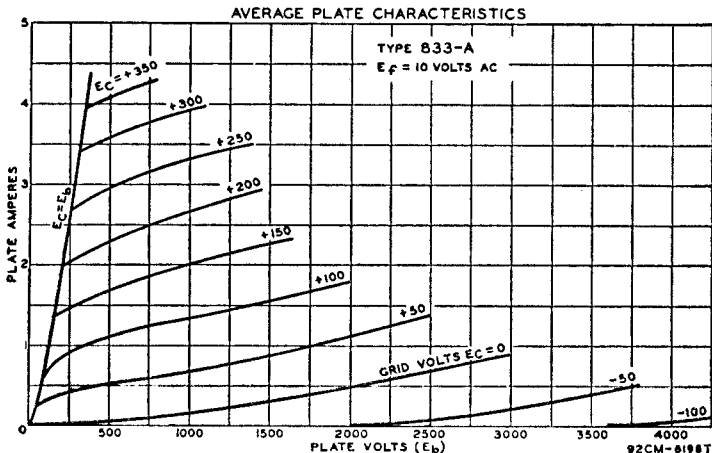

**PLATE-MODULATED RF POWER AMPLIFIER—Class C Telephony**

Maximum Ratings:	Natural Cooling		Forced-Air Cooling		
	CCS	ICAS	CCS	ICAS	
DC PLATE VOLTAGE	2500 max	3000 max	3000 max	4000 max	volts
DC GRID VOLTAGE	-500 max	-500 max	-500 max	-500 max	volts
DC PLATE CURRENT	400 max	400 max	450 max	450 max	ma
DC GRID CURRENT	100 max	100 max	100 max	100 max	ma
PLATE INPUT	835 max	1000 max	1250 max	1800 max	watts
PLATE DISSIPATION	200 max	250 max	270 max	350 max	watts

**Typical Operation:**

DC Plate Voltage	2500	3000	3000	4000	volts
DC Grid Voltage <sup>δ</sup>	-300	-240	-300	-325	volts
From grid resistor of	4000	3400	3600	3600	ohms
Peak RF Grid Voltage	460	410	490	520	volts
DC Plate Current	335	335	415	450	ma
DC Grid Current (Approx.)	75	70	85	90	ma
Driving Power (Approx.)	30	26	37	42	watts
Power Output (Approx.)	635	800	1000	1500	watts

<sup>δ</sup> Obtained from grid resistor of value shown or from a combination of grid resistor with either fixed supply or cathode resistor.

**RF POWER AMPLIFIER AND OSCILLATOR—Class C Telephony  
and**

**RF POWER AMPLIFIER—Class C FM Telephony**

Maximum Ratings:	Natural Cooling		Forced-Air Cooling		
	CCS	ICAS	CCS	ICAS	
DC PLATE VOLTAGE	3000 max	3300 max	4000 max	4000 max	*volts
DC GRID VOLTAGE	-500 max	-500 max	-500 max	-500 max	volts
DC PLATE CURRENT	500 max	500 max	500 max	500 max	ma
DC GRID CURRENT	100 max	100 max	100 max	100 max	ma
PLATE INPUT	1250 max	1500 max	1800 max	2000 max	watts
PLATE DISSIPATION	300 max	350 max	400 max	450 max	watts

**Typical Operation:**

DC Plate Voltage	2250	3000	3000	4000	4000	volts
DC Grid Voltage <sup>Δ</sup>	-125	-200	-155	-200	-225	volts
From grid resistor of	1500	3600	2150	2650	2400	ohms
From cathode resistor of	235	425	270	380	380	ohms
Peak RF Grid Voltage	300	360	350	375	415	volts
DC Plate Current	445	415	500	450	500	ma
DC Grid Current (Approx.)	85	55	70	75	95	ma
Driving Power (Approx.)	23	20	25	26	35	watts
Power Output (Approx.)	780	1000	1150	1440	1600	watts

<sup>Δ</sup> Obtained from fixed supply, by grid resistor, by cathode resistor, or by combination methods.

**OPERATING CONSIDERATIONS**

Type 833A requires special mounting and may be operated in vertical position with filament end up or down, or in horizontal position with all terminals in same vertical plane. OUTLINE 58, *Outlines* Section.

For operation with natural cooling at 50 Mc, plate voltage and plate input should be reduced to 90 per cent of maximum ratings; at 75 Mc, to 72 per cent. For operation with forced-air cooling at 50 Mc, plate voltage and plate input should be reduced to 83 per cent of maximum ratings; at 75 Mc, to 65 per cent.

With forced-air cooling, an air flow of 40 cubic feet per minute from a 2-inch-diameter nozzle directed vertically on the bulb between grid and plate seals is required to limit the temperature between these seals to 145°C.

When the 833-A is used in the final amplifier or a preceding stage of a transmitter designed for break-in operation and oscillator keying, a small amount of fixed bias must be used to maintain the plate current at a safe value. With a plate voltage of 4000 volts, a fixed bias of at least -90 volts should be used.

Plate shows an orange-red color when tube is operated at maximum CCS or ICAS ratings.

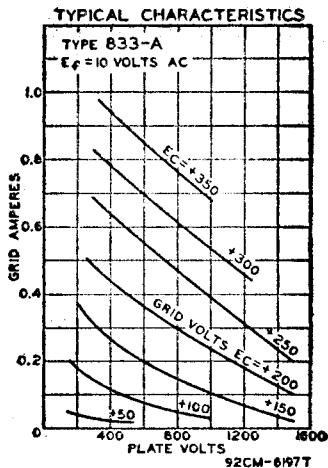

**POWER TRIODE**

**834**

Thoriated-tungsten-filament type used as rf power amplifier and oscillator. May be used with full input up to 100 Mc. For operation at 170 Mc, plate voltage and plate input should

be reduced to 80 per cent of maximum ratings; at 350 Mc, to 53 per cent. Class C Telegraphy maximum CCS plate dissipation, 50 watts. Requires Small four-contact socket and may be operated in vertical position only, base up or down. OUTLINE 47, *Outlines* Section. Plate shows an orange-red color when tube is operated at maximum CCS ratings.

FILAMENT VOLTAGE (AC/DC) .....	7.5	volts
FILAMENT CURRENT .....	3.1	amperes
AMPLIFICATION FACTOR .....	10.5	
DIRECT INTERELECTRODE CAPACITANCES:		
Grid to plate .....	2.4	$\mu\mu\text{f}$
Grid to filament .....	2.2	$\mu\mu\text{f}$
Plate to filament .....	0.6	$\mu\mu\text{f}$

**RF POWER AMPLIFIER AND OSCILLATOR—Class C Telegraphy and**

**RF POWER AMPLIFIER—Class C FM Telegraphy**

**Maximum CCS Ratings:**

DC PLATE VOLTAGE .....	1250 max	volts
DC GRID VOLTAGE .....	-400 max	volts
DC PLATE CURRENT .....	100 max	ma
DC GRID CURRENT .....	20 max	ma
PLATE INPUT .....	125 max	watts
PLATE DISSIPATION .....	50 max	watts

**POWER TRIODE**

**835**

Thoriated-tungsten-filament type used as af power amplifier and modulator and as rf power amplifier and oscillator. May be used with full input up to 20 Mc and with reduced input up to 100 Mc. Requires Jumbo four-contact socket and may be operated in vertical position with base down, or in horizontal position with pins 1 and 3 in vertical plane. OUTLINE 52, *Outlines* Section. Direct interelectrode ca-

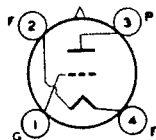

capacitances: grid to plate, 9.25  $\mu\text{f}$ ; grid to filament, 6  $\mu\text{f}$ ; plate to filament, 5  $\mu\text{f}$ . Plate shows a barely perceptible red color when tube is operated at maximum CCS ratings. Except for interelectrode capacitances, the 835 is identical with DISCONTINUED type 211. The 835 is a DISCONTINUED type listed for reference only.

### HALF-WAVE VACUUM RECTIFIER

# 836

Heater-cathode type having two cathodes used in power supply of transmitting and industrial equipment. Maximum peak inverse plate volts, 5000; maximum average plate

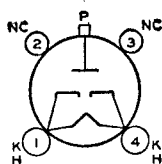

amperes, 0.25. Requires Small four-contact socket and may be operated in any position. **OUTLINE 44**, *Outlines* Section. The 836 has two separate cathodes, each of which is connected to its respective heater terminal. Plate-circuit return should be made to the mid-tap of the heater transformer.

HEATER VOLTAGE (AC) <sup>o</sup> .....	2.5	volts
HEATER CURRENT .....	5.0	amperes

### HALF-WAVE RECTIFIER

**Maximum Ratings:**

PEAK INVERSE PLATE VOLTAGE .....	5000 max	volts
PLATE CURRENT:		
Peak .....	1 max	ampere
Average .....	0.25 max	ampere
Fault, for duration of 0.1 second maximum .....	5 max	amperes

<sup>o</sup> Heater voltage should be applied approximately 40 seconds before the application of plate voltage.

### BEAM POWER TUBE

# 837

Heater-cathode type used as rf power amplifier and oscillator. May be used with full input up to 20 Mc. For operation at 40 Mc, plate voltage and plate input should be reduced to 76

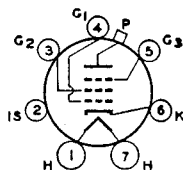

per cent of maximum ratings; at 60 Mc, to 62 per cent. Class C Telegraphy maximum CCS plate dissipation, 12 watts. Requires Medium seven-contact socket and may be operated in any position. **OUTLINE 34**, *Outlines* Section, except has no bayonet pin. Plate shows no color when tube is operated at maximum CCS ratings.

HEATER VOLTAGE (AC/DC) .....	12.6	volts
HEATER CURRENT .....	0.7	ampere
TRANSCONDUCTANCE (For plate current of 24 milliamperes) .....	3400	$\mu\text{mhos}$

**DIRECT INTERELECTRODE CAPACITANCES:**

Grid-No.1 to plate (With external shielding) .....	0.20 max	$\mu\text{f}$
Grid No.1 to cathode, grid No.3, grid No.2, internal shield, and heater .....	16	$\mu\text{f}$
Plate to cathode, grid No.3, grid No.2, internal shield, and heater .....	10	$\mu\text{f}$

### RF POWER AMPLIFIER AND OSCILLATOR—Class C Telegraphy and

### RF POWER AMPLIFIER—Class C FM Telephony

**Maximum CCS Ratings:**

DC PLATE VOLTAGE .....	500 max	volts
DC GRID-NO.3 VOLTAGE .....	200 max	volts
DC GRID-NO.2 VOLTAGE .....	200 max	volts
DC GRID-NO.1 VOLTAGE .....	-200 max	volts
DC PLATE CURRENT .....	80 max	ma
DC GRID-NO.1 CURRENT .....	8 max	ma
PLATE INPUT .....	32 max	watts
GRID-NO.3 INPUT .....	5 max	watts
GRID-NO.2 INPUT .....	8 max	watts
PLATE DISSIPATION .....	12 max	watts
PEAK HEATER-CATHODE VOLTAGE:		
Heater negative with respect to cathode .....	100 max	volts
Heater positive with respect to cathode .....	100 max	volts

**POWER TRIODE**

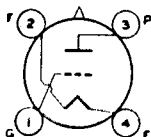

Thoriated-tungsten-filament type used as af power amplifier and modulator and as rf power amplifier and oscillator. May be used with full input up to 30 Mc and with reduced input up to 120 Mc. Requires Jumbo four-contact socket and may be operated in vertical position with base down, or in horizontal position with pins 1 and 3 in vertical plane. **OUTLINE 52, Outlines Section.** Plate shows no color when tube is operated at maximum CCS ratings. The 838 is used principally for renewal purposes.

**838**

FILAMENT VOLTAGE (ac/dc) .....	10	volts
FILAMENT CURRENT .....	3.25	amperes
<b>DIRECT INTERELECTRODE CAPACITANCES:</b>		
Grid to plate .....	7.8	$\mu\text{f}$
Grid to filament .....	6.0	$\mu\text{f}$
Plate to filament .....	4.0	$\mu\text{f}$

**Maximum CCS Ratings:**

	<b>Class B Modulator</b>	<b>Class C Telegraphy</b>	
DC PLATE VOLTAGE .....	1250 <i>max</i>	1250 <i>max</i>	volts
DC GRID VOLTAGE .....	—	-400 <i>max</i>	volts
DC PLATE CURRENT .....	175 <sup>•</sup> <i>max</i>	175 <i>max</i>	ma
DC GRID CURRENT .....	—	70 <i>max</i>	ma
PLATE INPUT .....	220 <sup>••</sup> <i>max</i>	220 <i>max</i>	watts
PLATE DISSIPATION .....	100 <sup>•</sup> <i>max</i>	100 <i>max</i>	watts

- For maximum-signal conditions.
- Averaged over any audio-frequency cycle of sine-wave form.

**POWER TRIODE**

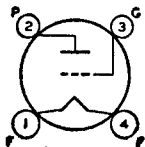

Thoriated-tungsten-filament type used as af power amplifier and modulator and as rf power amplifier and oscillator. May be used with full input up to 6 Mc and with reduced input up to 30 Mc. Requires Small four-contact socket and may be operated in vertical position with base down, or in horizontal position with pins 1 and 4 in vertical plane. **OUTLINE 32, Outlines Section.** Filament volts (ac/dc), 7.5; am-

**841**

peres, 1.25. Direct interelectrode capacitances: grid to plate, 7.5  $\mu\text{f}$ ; grid to filament, 4.0  $\mu\text{f}$ ; plate to filament, 2.6  $\mu\text{f}$ . Maximum CCS ratings as RF POWER AMPLIFIER AND OSCILLATOR: dc plate volts, 450 *max*; dc grid volts, -200 *max*; dc plate ma., 60 *max*; dc grid ma., 20 *max*; plate input, 27 *max* watts; plate dissipation, 15 *max* watts. Plate shows no color when tube is operated at maximum CCS ratings. The 841 is a DISCONTINUED type listed for reference only.

**POWER TRIODE**

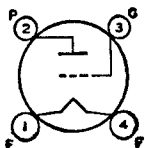

Thoriated-tungsten-filament type used as af power amplifier and modulator. Requires Small four-contact socket and may be operated in vertical position with base down, or in horizontal position with pins 1 and 4 in vertical plane. **OUTLINE 32, Outlines Section.** Filament volts (ac/dc), 7.5; amperes, 1.25. Direct interelectrode capacitances: grid to plate, 6.4  $\mu\text{f}$ ; grid to filament, 3.2  $\mu\text{f}$ ; plate to filament, 2.6

**842**

$\mu\text{f}$ . Maximum CCS ratings as CLASS A AF POWER AMPLIFIER AND MODULATOR: dc plate volts, 425 *max*; plate dissipation, 12 *max* watts. Plate shows no color when tube is operated at maximum CCS ratings. The 842 is a DISCONTINUED type listed for reference only.

**POWER TRIODE**

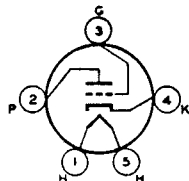

Heater-cathode type used as rf power amplifier and oscillator. May be used with full input up to 6 Mc and with reduced input up to 30 Mc. Requires Small five-contact socket and may be operated in any position. **OUTLINE 32, Outlines Section.** Heater volts (ac/dc), 2.5; amperes, 2.5. Direct interelectrode capacitances: grid to plate, 3.9  $\mu\text{f}$ ; grid to cathode and heater, 4  $\mu\text{f}$ ; plate to cathode and heater,

**843**

2.5  $\mu\text{f}$ . Maximum CCS ratings as RF POWER AMPLIFIER AND OSCILLATOR: dc plate volts, 450 max; dc grid volts, -200 max; dc plate milliamperes, 40 max; dc grid milliamperes, 7.5 max; plate input, 18 max watts; plate dissipation, 15 max watts; peak heater-cathode volts,  $\approx$  45 max. Plate shows no color when tube is operated at maximum CCS ratings. The 843 is a DISCONTINUED type listed for reference only.

### POWER TRIODE

# 845

Thoriated-tungsten-filament type used as af power amplifier and modulator. Class AB<sub>1</sub> maximum CCS plate dissipation, 100 watts. Requires Jumbo four-contact socket and may be

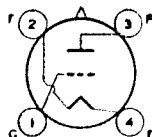

operated in vertical position with base down, or in horizontal position with pins 1 and 3 in vertical plane. OUTLINE 52, *Outlines* Section. Plate shows no color when tube is operated at maximum CCS ratings.

FILAMENT VOLTAGE (AC/DC) .....	10	volts
FILAMENT CURRENT .....	3.25	amperes
AMPLIFICATION FACTOR .....	5.3	
DIRECT INTERELECTRODE CAPACITANCES:		
Grid to plate .....	12.1	$\mu\text{f}$
Grid to filament .....	5.0	$\mu\text{f}$
Plate to filament .....	5.0	$\mu\text{f}$

#### AF POWER AMPLIFIER AND MODULATOR—Class AB<sub>1</sub>

Maximum CCS Ratings:

DC PLATE VOLTAGE .....	1250 max	volts
DC GRID VOLTAGE .....	-400 max	volts
DC PLATE CURRENT .....	120 max	ma
PLATE INPUT .....	150 max	watts
PLATE DISSIPATION .....	100 max	watts

### POWER TRIODE

Thoriated-tungsten-filament type used as af power amplifier and modulator and as rf power amplifier and oscillator. May be used with full input up to 3 Mc and with reduced input up to 30 Mc. Tube may be operated in vertical position with filament end up, or in horizontal position with plate in vertical plane. Maximum over-all length, 1 1/4 inches; maximum diameter, 4 1/8 inches. Filament volts

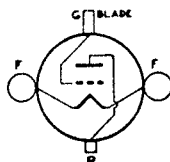

# 849

(ac/dc), 11; amperes, 5. Direct interelectrode capacitances: grid to plate, 34  $\mu\text{f}$ ; grid to filament, 17  $\mu\text{f}$ ; plate to filament, 3  $\mu\text{f}$ . Maximum CCS ratings as RF POWER AMPLIFIER AND OSCILLATOR: dc plate volts, 2500 max; dc grid volts, -500 max; dc plate amperes, 0.35 max; dc grid amperes, 0.125 max; plate input, 875 max watts; plate dissipation, 400 max watts. Plate shows cherry-red color when tube is operated at maximum CCS ratings. The 849 is a DISCONTINUED type listed for reference only.

### POWER TETRODE

Thoriated-tungsten-filament type used as rf power amplifier and oscillator at frequencies up to 15 Mc. Requires Jumbo four-contact socket and may be operated in vertical position with base up or down, or in horizontal position with pins 1 and 3 in vertical plane. OUTLINE 53, *Outlines* Section. Filament volts (ac/dc), 10; amperes, 3.25. Direct interelectrode capacitances: grid No.1 to plate (with external shield-

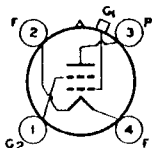

# 850

ing), 0.25 max  $\mu\text{f}$ ; grid No.1 to filament and grid No.2, 17  $\mu\text{f}$ ; plate to filament and grid No.2, 25  $\mu\text{f}$ . Maximum CCS ratings as RF POWER AMPLIFIER AND OSCILLATOR: dc plate volts, 1250 max; dc grid-No.2 volts, 400 max; dc grid-No.1 volts, -400 max; dc plate milliamperes, 175 max dc; grid-No.1 milliamperes, 40 max; plate input, 220 max watts; grid-No.2 input, 10 max watts; plate dissipation, 100 max watts. Plate shows a barely perceptible red color when tube is operated at maximum CCS ratings. The 850 is a DISCONTINUED type listed for reference only.



**POWER TRIODE**

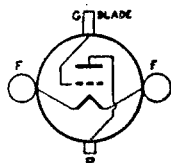

851

Thoriated-tungsten-filament type used as af power amplifier and modulator and as rf power amplifier and oscillator. May be used with full input up to 3 Mc and with reduced input up to 15 Mc. Tube may be operated in vertical position with filament end up, or in horizontal position with plate in vertical plane.

Maximum over-all length, 17-5/8 inches; maximum diameter, 6-1/8 inches. Filament volts (ac/dc), 11.0; amperes, 15.5. Direct interelectrode capacitances: grid to plate, 47  $\mu\mu\text{f}$ ; grid to filament, 25.5  $\mu\mu\text{f}$ ; plate to filament, 4.5  $\mu\mu\text{f}$ . Maximum CCS ratings as RF POWER AMPLIFIER AND OSCILLATOR: dc plate volts, 2500 *max*; dc grid volts, -500 *max*; dc plate amperes, 1 *max*; dc grid amperes, 0.2 *max*; plate input, 2500 *max* watts; plate dissipation, 750 *max* watts. The 851 is a DISCONTINUED type listed for reference only.

**POWER TETRODE**

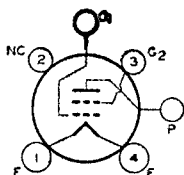

860

Thoriated-tungsten-filament type used as rf power amplifier and oscillator. May be used with full input up to 30 Mc. For operation at 60 Mc, plate voltage and plate input should be reduced to 75 per cent of maximum ratings; at 120 Mc, to 50 per cent. Requires Small four-contact socket and may be operated in vertical position only, base down. OUTLINE 57, *Outlines* Section. Plate shows no color when tube is operated at maximum CCS ratings. The 860 is used principally for renewal purposes.

FILAMENT VOLTAGE (AC/DC)	10	volts
FILAMENT CURRENT	3.25	amperes
TRANSCONDUCTANCE (For plate current of 50 milliamperes)	1100	$\mu\text{mhos}$
AMPLIFICATION FACTOR	200	
DIRECT INTERELECTRODE CAPACITANCES:		
Grid No.1 to plate (With external shielding)	0.08 <i>max</i>	$\mu\mu\text{f}$
Grid No.1 to filament and grid No.2	7.75	$\mu\mu\text{f}$
Plate to filament and grid No.2	7.5	$\mu\mu\text{f}$

**RF POWER AMPLIFIER AND OSCILLATOR—Class C Telegraphy  
and  
RF POWER AMPLIFIER—Class C FM Telephony**

**Maximum CCS Ratings:**

DC PLATE VOLTAGE	3000 <i>max</i>	volts
DC GRID-NO.2 VOLTAGE	500 <i>max</i>	volts
DC GRID-NO.1 VOLTAGE	-800 <i>max</i>	volts
DC PLATE CURRENT	150 <i>max</i>	ma
DC GRID-NO.1 CURRENT	40 <i>max</i>	ma
PLATE INPUT	300 <i>max</i>	watts
GRID-NO.2 INPUT	10 <i>max</i>	watts
PLATE DISSIPATION	100 <i>max</i>	watts

**POWER TETRODE**

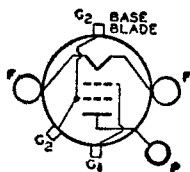

861

Thoriated-tungsten-filament type used as rf amplifier and oscillator up to 60 Mc. Maximum over-all length, 17-7/32 inches; maximum radius, 6-5/8 inches. Filament volts (ac/dc), 11; amperes, 10. Direct interelectrode capacitances: grid No.1 to plate (with external shield), 0.1 *max*  $\mu\mu\text{f}$ ; grid No.1 to filament and grid No.2, 14  $\mu\mu\text{f}$ ; plate to filament and grid No.2, 11  $\mu\mu\text{f}$ . Maximum CCS ratings as RF POWER AM-

PLIFIER AND OSCILLATOR: dc plate volts, 3500 *max*; dc grid-No.2 volts, 745 *max*; dc grid-No.1 volts, -1000 *max*; dc plate ma., 350 *max*; dc grid-No.1 ma., 75 *max*; plate input, 1200 *max* watts; grid-No.2 input, 35 *max* watts; plate dissipation, 400 *max* watts. The 861 is a DISCONTINUED type listed for reference only.

**POWER TETRODE**

Thoriated-tungsten-filament type used as rf power amplifier and oscillator at frequencies up to 60 Mc. **OUTLINE 34, Outlines Section.** Filament volts (ac/dc), 7.5; amperes, 2. Direct interelectrode capacitances: grid No.1 to plate (with external shield), 0.1  $\mu\text{f}$ ; grid No.1 to filament and grid No.2, 8.5 *max*  $\mu\text{f}$ ; plate to filament and grid No.2, 8  $\mu\text{f}$ . Maximum CCS ratings as **RF POWER AMPLIFIER AND**

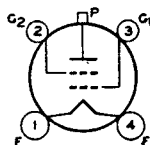

**865**

**OSCILLATOR:** dc plate volts, 750 *max*; dc grid-No.2 volts, 175 *max*; dc grid-No.1 volts, -200 *max*; dc plate ma., 60 *max*; dc grid-No.1 ma., 15 *max*; plate input, 45 *max* watts; grid-No.2 input, 3 *max* watts; plate dissipation, 15 *max* watts. The 865 is a **DISCONTINUED** type listed for reference only.

**HALF-WAVE MERCURY-VAPOR RECTIFIER**

Coated-filament type used in power supply of transmitting and industrial equipment. Maximum peak inverse anode volts, 10,000; at maximum average anode amperes, 0.25. Requires Small four-contact socket and may be operated in vertical position only, base down. **OUTLINE 43, Outlines Section.**

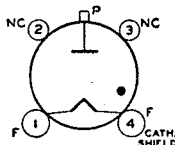

**866A**

FILAMENT VOLTAGE (AC)°	2.5	volts
FILAMENT CURRENT	5.0	amperes
PEAK TUBE VOLTAGE DROP (Approx.)	15	volts

° Filament voltage must be applied at least 15 seconds before the application of anode voltage.

**HALF-WAVE RECTIFIER**

Maximum Ratings, (For power-supply frequency of 60 cps):

PEAK INVERSE ANODE VOLTAGE	2500 <i>max</i>	5000 <i>max</i>	10000 <i>max</i>	volts
ANODE CURRENT:				
Peak	2 <i>max</i>	1 <i>max</i>	1 <i>max</i>	amperes
Average*	0.5 <i>max</i>	0.25 <i>max</i>	0.25 <i>max</i>	ampere
Fault, for duration of 0.1 second maximum	20 <i>max</i>	20 <i>max</i>	20 <i>max</i>	amperes
CONDENSED-MERCURY-TEMPERATURE RANGE•	20 to 80	20 to 70	20 to 60	°C

\* Averaged over any interval of 30 seconds maximum.

• Operation at 40° ± 5°C is recommended.

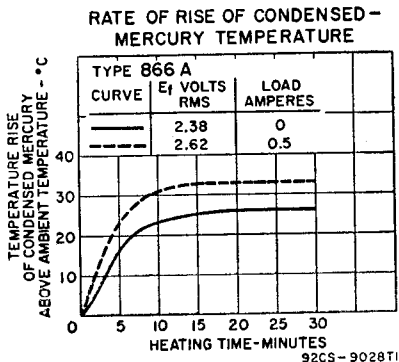

## Technical Data

### Operating Values:

Circuit (For circuit figures, refer to Rectifier Considerations Section)	Fig.	Max. Trans. Sec. Volts (RMS) E	Approx. DC Output Volts To Filter E <sub>av</sub>	Max. DC Output Amperes I <sub>av</sub>	Max. DC Output KW To Filter P <sub>dc</sub>
<b>In-Phase Operation</b>					
Half-Wave Single-Phase . . .	57	7000*	3200	0.25	0.8
		3500 <sup>▲</sup>	1600	0.25	0.4
		1700 <sup>□</sup>	800	0.50	0.4
Full-Wave Single-Phase . . .	58	3500*	3200	0.5	1.6
		1700 <sup>▲</sup>	1600	0.5	0.8
		800 <sup>□</sup>	800	1.0	0.8
Series Single-Phase . . . . .	59	7000*	6400	0.5	3.2
		3500 <sup>▲</sup>	3200	0.5	1.6
		1700 <sup>□</sup>	1600	1.0	1.6
Half-Wave Three-Phase . . .	60	4000*	4800	0.75	3.6
		2000 <sup>▲</sup>	2400	0.75	1.8
		1000 <sup>□</sup>	1200	1.5	1.8
<b>Quadrature Operation</b>					
Parallel Three-Phase . . . . .	61	4000*	4800	1.5	7.2
		2000 <sup>▲</sup>	2400	1.5	3.6
		1000 <sup>□</sup>	1200	3.0	3.6
Series Three-Phase . . . . .	62	4000*	9600	0.75	7.2
		2000 <sup>▲</sup>	4800	0.75	3.6
		1000 <sup>□</sup>	2400	1.5	3.6
Half-Wave Four-Phase . . . .	63	3500*	4500	0.91* 1.0 <sup>■</sup>	4.05* 4.5 <sup>■</sup>
		1700 <sup>▲</sup>	2300	0.91* 1.0 <sup>■</sup>	2.07* 2.3 <sup>■</sup>
		800 <sup>□</sup>	1100	1.82* 2.0 <sup>■</sup>	1.98* 2.2 <sup>■</sup>
Half-Wave Six-Phase . . . . .	64	3500*	4800	0.95* 1.0 <sup>■</sup>	4.60* 4.8 <sup>■</sup>
		1700 <sup>▲</sup>	2400	0.95* 1.0 <sup>■</sup>	2.30* 2.4 <sup>■</sup>
		800 <sup>□</sup>	1200	1.90* 2.0 <sup>■</sup>	2.28* 2.4 <sup>■</sup>

\* For maximum peak inverse anode voltage of 10000 volts and maximum average anode current of 0.25 ampere.

▲ For maximum peak inverse anode voltage of 5000 volts and maximum average anode current of 0.25 ampere.

□ For maximum peak inverse anode voltage of 2500 volts and maximum average anode current of 0.5 ampere.

\* Resistive load.

■ Inductive load.

### HALF-WAVE MERCURY- VAPOR RECTIFIER

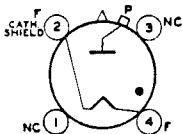

Coated-filament type used in power supply of transmitting and industrial equipment. Maximum peak inverse anode volts, 10,000; maximum average anode amperes, 1.25. Requires

## 872A

Jumbo four-contact socket and may be operated in vertical position only, base down. OUTLINE 54, *Outlines* Section.

FILAMENT VOLTAGE (AC) . . . . .	5.0	volts
FILAMENT CURRENT . . . . .	7.5	amperes
PEAK TUBE VOLTAGE DROP (Approx.) . . . . .	10	volts

° Filament voltage must be applied at least 30 seconds before the application of anode voltage.

### HALF-WAVE RECTIFIER

Maximum Ratings, (For power-supply frequency of 60 cps):

PEAK INVERSE ANODE VOLTAGE . . . . .	5000 max	10000 max	volts
--------------------------------------	----------	-----------	-------

# RCA Transmitting Tubes

## ANODE CURRENT:

Peak .....	5 max	5 max	amperes
Average $\delta$ .....	1.25 max	1.25 max	amperes
Fault, for duration of 0.2 second maximum .....	50 max	50 max	amperes
CONDENSED-MERCURY-TEMPERATURE RANGE .....	20 to 70	20 to 60	°C

$\delta$  Averaged over any interval of 15 seconds maximum.

• Operation at  $40^\circ \pm 5^\circ\text{C}$  is recommended.

## Operating Values:

Circuit (For circuit figures, refer to Rectifier Considerations Section)	Fig.	Max. Trans. Sec. Volts (RMS) E	Approx. DC Output Volts To Filter E <sub>AV</sub>	Max. DC Output Amperes I <sub>AV</sub>	Max. DC Output KW To Filter P <sub>dc</sub>
<b>In-Phase Operation</b>					
Half-Wave Single-Phase...	57	7000* 3500*	3200 1600	1.25 1.25	4.0 2.0
Full-Wave Single-Phase...	58	3500* 1700*	3200 1600	2.5 2.5	8.0 4.0
Series Single-Phase.....	59	7000* 3500*	6400 3200	2.5 2.5	16.0 8.0
Half-Wave Three-Phase...	60	4000* 2000*	4800 2400	3.75 3.75	18.0 9.0
<b>Quadrature Operation</b>					
Parallel Three-Phase.....	61	4000* 2000*	4800 2400	7.5 7.5	36.0 18.0
Series Three-Phase.....	62	4000* 2000*	9600 4800	3.75 3.75	36.0 18.0
Half-Wave Four-Phase....	63	3500* 1700*	4500 2250	4.5* 5.0 <sup>■</sup> 4.5* 5.0 <sup>■</sup>	20.0* 22.5 <sup>■</sup> 10.0* 11.2 <sup>■</sup>
Half-Wave Six-Phase.....	64	3500* 1700*	4800 2400	4.75* 5.0 <sup>■</sup> 4.75* 5.0 <sup>■</sup>	22.8* 24.0 <sup>■</sup> 11.4* 12.0 <sup>■</sup>

• For maximum peak inverse anode voltage of 10000 volts and maximum average anode current of 1.25 amperes.

\* For maximum peak inverse anode voltage of 5000 volts and maximum average anode current of 1.25 amperes.

• Resistive load.      ■ Inductive load.

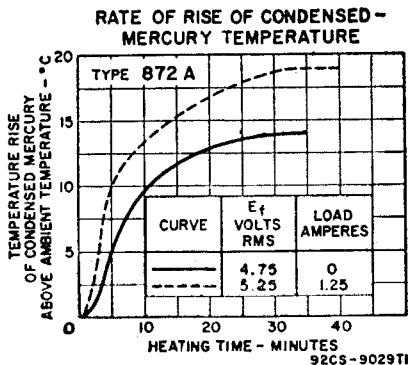



VIEWED FROM SHORT END

### MEDIUM-MU TRIODE

Acorn heater-cathode type used as af amplifier and as rf amplifier and oscillator at frequencies up to 600 Mc. Class A<sub>1</sub> Amplifier maximum CCS plate dissipation (design-center value), 1.6 watts. Requires Acorn five-contact

# 955

socket and may be operated in any position. OUTLINE 2, *Outlines* Section. Plate shows no color when tube is operated at maximum CCS ratings.

HEATER VOLTAGE (AC/DC) .....	6.3	volts
HEATER CURRENT .....	0.15	ampere
TRANSCONDUCTANCE <sup>o</sup> .....	2200	μmhos
AMPLIFICATION FACTOR <sup>o</sup> .....	25	
DIRECT INTERELECTRODE CAPACITANCES:		
Grid to plate .....	1.3	μf
Grid to cathode and heater .....	1.0	μf
Plate to cathode and heater .....	0.4	μf

<sup>o</sup> For dc plate volts, 250; dc grid volts, -7; plate resistance (Approx.), 11400 ohms; dc plate amperes, 6.3.

#### AF AMPLIFIER—Class A<sub>1</sub>

Maximum CCS Ratings, *Design-Center Values*:

DC PLATE VOLTAGE .....	250 max	volts
PLATE DISSIPATION .....	1.6 max	watts
PEAK HEATER-CATHODE VOLTAGE:		
Heater negative with respect to cathode .....	80 max	volts
Heater positive with respect to cathode .....	80 max	volts

#### RF AMPLIFIER AND OSCILLATOR—Class C

Maximum CCS Ratings, *Design-Center Values*:

DC PLATE VOLTAGE .....	180 max	volts
DC PLATE CURRENT .....	8 max	ma
DC GRID CURRENT .....	2 max	ma
PEAK HEATER-CATHODE VOLTAGE:		
Heater negative with respect to cathode .....	80 max	volts
Heater positive with respect to cathode .....	80 max	volts

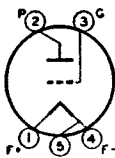

VIEWED FROM SHORT END

### MEDIUM-MU TRIODE

Acorn coated-filament type used as rf power amplifier and oscillator at frequencies up to 350 Mc. Class C Telegraphy maximum CCS plate dissipation (design-center value), 0.6

# 958A

watt. Requires Acorn five-contact socket and may be operated in any position. OUTLINE 2, *Outlines* Section. Plate shows no color when tube is operated at maximum CCS ratings.

FILAMENT VOLTAGE (DC) .....	1.25	volts
FILAMENT CURRENT .....	0.10	ampere
DIRECT INTERELECTRODE CAPACITANCES:		
Grid to plate .....	2.5	μf
Grid to filament .....	0.45	μf
Plate to filament .....	0.6	μf

#### RF POWER AMPLIFIER AND OSCILLATOR—Class C Telegraphy and

#### RF POWER AMPLIFIER—Class C FM Telegraphy

Maximum CCS Ratings, *Design-Center Values*:

DC PLATE VOLTAGE .....	135 max	volts
DC GRID VOLTAGE .....	-30 max	volts

DC PLATE CURRENT .....	7 <i>max</i>	ma
DC GRID CURRENT .....	1 <i>max</i>	ma
PLATE INPUT .....	0.95 <i>max</i>	watt
PLATE DISSIPATION .....	0.6 <i>max</i>	watt

**Maximum Circuit Values:**

Grid-Circuit Resistance:		
For fixed-bias operation .....	0.1 <i>max</i>	megohm
For cathode-bias operation .....	0.5 <i>max</i>	megohm

**POWER TRIODE**

Coated-filament type used as af power amplifier and modulator and as rf power amplifier and oscillator. May be used with full input up to 45 Mc and with reduced input up to 100 Mc. Requires Small four-contact socket and may be mounted in vertical position with base down, or in horizontal position with pins 1 and 4 in vertical plane. OUTLINE 32, *Outlines* Section. Filament volts (ac/dc), 2.5; amperes, 2.5.

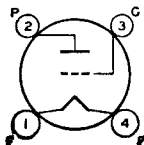

**1608**

Direct interelectrode capacitances: grid to plate, 9  $\mu\text{f}$ ; grid to filament, 8.5  $\mu\text{f}$ ; plate to filament, 3  $\mu\text{f}$ . Maximum CCS ratings as RF POWER AMPLIFIER AND OSCILLATOR: dc plate volts, 425 *max*; dc grid volts, -200; *max* dc plate milliamperes, 95 *max*; dc grid milliamperes, 25 *max*; plate input, 40 *max* watts; plate dissipation, 20 *max* watts. Plate shows no color when tube is operated at maximum CCS ratings. The 1608 is a DISCONTINUED type listed for reference only.

**POWER PENTODE**

Coated-filament type used as rf power amplifier and oscillator. May be used with full input up to 20 Mc and with reduced input up to 110 Mc. Requires Small five-contact socket and may be operated in vertical position only, base up or down. OUTLINE 32, *Outlines* Section. Filament volts (ac/dc), 2.5; amperes, 1.75. Direct interelectrode capacitances: grid-No.1 to plate, 1.2  $\mu\text{f}$ ; grid No.1 to filament mid-tap,

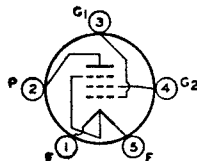

**1610**

grid No.3, and grid No.2, 8.6  $\mu\text{f}$ ; plate to filament mid-tap, grid No.3, and grid No.2, 13  $\mu\text{f}$ . Maximum CCS ratings as RF POWER AMPLIFIER AND OSCILLATOR: dc plate volts, 400 *max*; dc grid-No.2 volts, 200 *max*; dc grid-No.1 volts, -100 *max*; dc plate milliamperes, 30 *max*; dc grid-No.1 milliamperes, 3 *max*; plate input, 9 *max* watts; grid-No.2 input, 2 *max* watts; plate dissipation, 6 *max* watts. Plate shows no color when tube is operated at maximum CCS ratings. The 1610 is a DISCONTINUED type listed for reference only.

**POWER PENTODE**

Heater-cathode type having metal shell used as rf power amplifier and oscillator. May be used with full input up to 45 Mc. For operation at 60 Mc, plate voltage and plate input

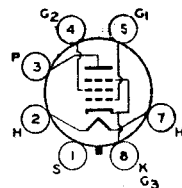

should be reduced to 90 per cent of maximum ratings; at 90 Mc, to 85 per cent. Class C Telegraphy maximum CCS plate dissipation, 10 watts. Requires Octal socket and may be operated in any position. OUTLINE 11, *Outlines* Section.

**1613**

HEATER VOLTAGE (AC/DC) .....	6.3	volts
HEATER CURRENT .....	0.7	ampere
TRANSCONDUCTANCE (For plate current of 31 milliamperes) .....	2500	$\mu\text{hos}$

**DIRECT INTERELECTRODE CAPACITANCES:**

Grid No.1 to plate .....	0.26	$\mu\text{f}$
Grid No.1 to cathode, grid No.3, grid No.2, shell, and heater .....	6.5	$\mu\text{f}$
Plate to cathode, grid No.3, grid No.2, shell, and heater .....	13.5	$\mu\text{f}$

**RF POWER AMPLIFIER AND OSCILLATOR—Class C Telegraphy and**

**RF POWER AMPLIFIER—Class C FM Telephony**

**Maximum CCS Ratings:**

DC PLATE VOLTAGE .....	350 <i>max</i>	volts
------------------------	----------------	-------

DC GRID-NO.2 VOLTAGE .....	275 <i>max</i>	volts
DC GRID-NO.1 VOLTAGE .....	-100 <i>max</i>	volts
DC PLATE CURRENT .....	50 <i>max</i>	ma
DC GRID-NO.1 CURRENT .....	5 <i>max</i>	ma
PLATE INPUT .....	17.5 <i>max</i>	watts
GRID-NO.2 INPUT .....	2.5 <i>max</i>	watts
PLATE DISSIPATION .....	10 <i>max</i>	watts
<b>PEAK HEATER-CATHODE VOLTAGE:</b>		
Heater negative with respect to cathode .....	100 <i>max</i>	volts
Heater positive with respect to cathode .....	100 <i>max</i>	volts

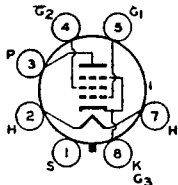

### BEAM POWER TUBE

Heater-cathode type having metal shell used as af power amplifier and modulator and as rf power amplifier and oscillator. May be used with full input up to 80 Mc. For operation

# 1614

at 120 Mc, plate voltage and plate input should be reduced to 75 per cent of maximum ratings. Class C Telegraphy maximum plate dissipation, CCS 21 watts, ICAS 25 watts. Requires Octal socket and may be operated in any position. OUTLINE 21, *Outlines* Section.

HEATER VOLTAGE (AC/DC) .....	6.3	volts
HEATER CURRENT .....	0.9	ampere
TRANSCONDUCTANCE (For plate current of 72 milliamperes) .....	6050	μmhos
<b>DIRECT INTERELECTRODE CAPACITANCES:</b>		
Grid No.1 to plate .....	0.4 <i>max</i>	μμf
Grid No.1 to cathode, grid No.3, grid No.2, shell, and heater .....	10	μμf
Plate to cathode, grid No.3, grid No.2, shell, and heater .....	12	μμf

#### AF POWER AMPLIFIER AND MODULATOR—Class AB1

Maximum Ratings:	<i>CCS</i>	<i>ICAS</i>	
DC PLATE VOLTAGE .....	375 <i>max</i>	550 <i>max</i>	volts
DC GRID-NO.2 VOLTAGE .....	300 <i>max</i>	400 <i>max</i>	volts
DC PLATE CURRENT .....	110 <i>max</i>	110 <i>max</i>	ma
PLATE INPUT .....	40 <i>max</i>	60 <i>max</i>	watts
GRID-NO.2 INPUT .....	3.5 <i>max</i>	3.5 <i>max</i>	watts
PLATE DISSIPATION .....	21 <i>max</i>	25 <i>max</i>	watts
<b>PEAK HEATER-CATHODE VOLTAGE:</b>			
Heater negative with respect to cathode .....	200 <i>max</i>	200 <i>max</i>	volts
Heater positive with respect to cathode .....	200 <i>max</i>	200 <i>max</i>	volts

#### Typical Operation (Values are for 2 tubes):

DC Plate Voltage .....	360	530	volts
DC Grid-No.2 Voltage .....	270	340	volts
DC Grid-No.1 Voltage .....	-22.5	-36	volts
Peak AF Grid-No.-1-to-Grid-No.1 Voltage .....	45	72	volts
Zero-Signal DC Plate Current .....	88	60	ma
Maximum-Signal DC Plate Current .....	132	160	ma
Maximum-Signal DC Grid-No.2 Current .....	15	20	ma
Effective Load Resistance (Plate to plate) .....	6600	7200	ohms
Total Harmonic Distortion .....	2	2.5	per cent
Maximum-Signal Power Output .....	26.5	50	watts

#### RF POWER AMPLIFIER AND OSCILLATOR—Class C Telegraphy and

#### RF POWER AMPLIFIER—Class C FM Telephony

Maximum Ratings:	<i>CCS</i>	<i>ICAS</i>	
DC PLATE VOLTAGE .....	375 <i>max</i>	450 <i>max</i>	volts
DC GRID-NO.2 VOLTAGE .....	300 <i>max</i>	300 <i>max</i>	volts
DC GRID-NO.1 VOLTAGE .....	-125 <i>max</i>	-125 <i>max</i>	volts
DC PLATE CURRENT .....	110 <i>max</i>	110 <i>max</i>	ma

DC GRID-NO.1 CURRENT.....	5 <i>max</i>	5 <i>max</i>	ma
PLATE INPUT.....	35 <i>max</i>	45 <i>max</i>	watts
GRID-NO.2 INPUT.....	3.5 <i>max</i>	3.5 <i>max</i>	watts
PLATE DISSIPATION.....	21 <i>max</i>	25 <i>max</i>	watts
<b>PEAK HEATER-CATHODE VOLTAGE:</b>			
Heater negative with respect to cathode.....	200 <i>max</i>	200 <i>max</i>	volts
Heater positive with respect to cathode.....	200 <i>max</i>	200 <i>max</i>	volts

**Typical Operation:**

DC Plate Voltage.....	375	450	volts
DC Grid-No.2 Voltage*.....	250	250	volts
From series resistor of.....	12500	25000	ohms
DC Grid-No.1 Voltage‡.....	-40	-45	volts
From grid-No.1 resistor of.....	20000	22500	ohms
From cathode resistor of.....	425	410	ohms
Peak RF Grid-No.1 Voltage.....	51	73	volts
DC Plate Current.....	80	100	ma
DC Grid-No.2 Current.....	10	8	ma
DC Grid-No.1 Current (Approx.).....	2	2	ma
Driving Power (Approx.).....	0.1	0.15	watt
Power Output (Approx.).....	21	31	watts

\* Obtained from separate source, from plate-voltage supply with a voltage divider, or through series resistor of value shown.

‡ Obtained from fixed supply, by grid-No.1 resistor, by cathode resistor, or by combination methods.

**HALF-WAVE VACUUM RECTIFIER**

Coated-filament type used in power supply of transmitting and industrial equipment. Requires a Small four-contact socket and may be operated in vertical position with base down, or in horizontal position with pins 1 and 4 in vertical plane. Maximum over-all length, 6-13/16 inches; maximum diameter, 2-1/16 inches. Filament volts (ac), 2.5; amperes, 5. Maximum CCS ratings as HALF-WAVE RECTIFIER:

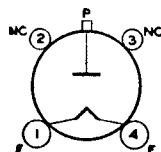

**1616**

peak inverse plate volts, 6000 *max*; peak plate ma., 800 *max*; average plate ma., 130 *max*; fault amperes, 2.5 *max*. The 1616 is a DISCONTINUED type listed for reference only.

**BEAM POWER TUBE**

Coated-filament type having metal shell used as af power amplifier and modulator and as rf power amplifier and oscillator. May be used with full input up to 45 Mc. For operation at 60 Mc, plate voltage and plate input should be reduced to 90 per cent of maximum ratings; at 90 Mc, to 77 per cent. Requires Octal socket and may be operated in vertical position only, base down or up. OUTLINE 21, *Outlines* Section. The 1619 is used principally for renewal purposes.

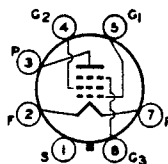

**1619**

FILAMENT VOLTAGE (AC/DC).....	2.5	volts
FILAMENT CURRENT.....	2.0	amperes
TRANSCONDUCTANCE (For plate current of 50 milliamperes).....	4500	μmhos
<b>DIRECT INTERELECTRODE CAPACITANCES:</b>		
Grid No.1 to plate.....	0.45 <i>max</i>	μf
Grid No.1 to filament, grid No.3, grid No.2, and shell.....	9.6	μf
Plate to filament, grid No.3, grid No.2, and shell.....	12.5	μf

**AF POWER AMPLIFIER AND MODULATOR—Class AB1**

**Maximum CCS Ratings:**

DC PLATE VOLTAGE.....	400 <i>max</i>	volts
DC GRID-NO.2 VOLTAGE.....	300 <i>max</i>	volts
MAXIMUM-SIGNAL DC PLATE CURRENT <sup>■</sup> .....	75 <i>max</i>	ma
MAXIMUM-SIGNAL PLATE INPUT <sup>■</sup> .....	30 <i>max</i>	watts
GRID-NO.2 INPUT <sup>■</sup> .....	3.5 <i>max</i>	watts
PLATE DISSIPATION <sup>■</sup> .....	15 <i>max</i>	watts

■ Averaged over any audio-frequency cycle of sine-wave form.



**RF POWER AMPLIFIER AND OSCILLATOR—Class C Telegraphy  
and  
RF POWER AMPLIFIER—Class C FM Telephony**

**Maximum CCS Ratings:**

DC PLATE VOLTAGE .....	400 <i>max</i>	volts
DC GRID-NO.2 VOLTAGE .....	300 <i>max</i>	volts
DC GRID-NO.1 VOLTAGE .....	-125 <i>max</i>	volts
DC PLATE CURRENT .....	75 <i>max</i>	ma
DC GRID-NO.1 CURRENT .....	5 <i>max</i>	ma
PLATE INPUT .....	30 <i>max</i>	watts
GRID-NO.2 INPUT .....	3.5 <i>max</i>	watts
PLATE DISSIPATION .....	15 <i>max</i>	watts

**Maximum Circuit Values:**

Grid-No.1-Circuit Resistance .....	25000 <i>max</i>	ohms
------------------------------------	------------------	------

**POWER TRIODE**

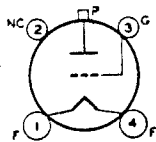

Thoriated-tungsten-filament type used as rf power amplifier and modulator and as rf power amplifier and oscillator. May be used with full input up to 60 Mc and with reduced input up to 100 Mc. Requires Small four-contact socket and may be operated in vertical position with base down, or in horizontal position with pins 1 and 4 in vertical plane. **OUTLINE 44, Outlines Section.** Filament volts (ac/dc),

**1623**

6.3; amperes, 2.5. Direct interelectrode capacitances: grid to plate, 6.7  $\mu\text{f}$ ; grid to filament, 5.2  $\mu\text{f}$ ; plate to filament, 0.9  $\mu\text{f}$ . Maximum CCS ratings as RF POWER AMPLIFIER AND OSCILLATOR: dc plate volts, 750 *max*; dc grid volts, -200 *max*; dc plate ma., 100 *max*; dc grid ma., 25 *max*; plate input, 75 *max* watts; plate dissipation, 25 *max* watts. Plate does not show color when tube is operated at maximum CCS ratings. Type 1623 is a DISCONTINUED type listed for reference only.

**BEAM POWER TUBE**

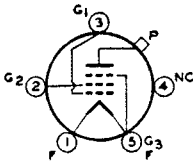

Coated-filament type used as rf power amplifier and oscillator. May be used with full input up to 60 Mc. For operation at 80 Mc, plate voltage and plate input should be reduced to 80 per cent of maximum ratings; at 125 Mc, to 55 per cent. Requires Small five-contact socket and may be operated in vertical position only, base up or down. **OUTLINE 34, Outlines Section,** except has no bayonet pin. Plate shows

**1624**

no color when tube is operated at maximum CCS ratings. The 1624 is used principally for renewal purposes.

FILAMENT VOLTAGE (AC/DC) .....	2.5	volts
FILAMENT CURRENT .....	2.0	amperes
TRANSCONDUCTANCE (For plate current of 50 milliamperes) .....	4000	$\mu\text{mhos}$
<b>DIRECT INTERELECTRODE CAPACITANCES:</b>		
Grid No.1 to plate (With external shielding) .....	0.25 <i>max</i>	$\mu\text{f}$
Grid No.1 to filament, grid No.3, and grid No.2 .....	11	$\mu\text{f}$
Plate to filament, grid No.3, and grid No.2 .....	7.5	$\mu\text{f}$

**RF POWER AMPLIFIER AND OSCILLATOR—Class C Telegraphy  
and  
RF POWER AMPLIFIER—Class C FM Telephony**

**Maximum CCS Ratings:**

DC PLATE VOLTAGE .....	600 <i>max</i>	volts
DC GRID-NO.2 VOLTAGE .....	300 <i>max</i>	volts
DC GRID-NO.1 VOLTAGE .....	-200 <i>max</i>	volts
DC PLATE CURRENT .....	90 <i>max</i>	ma
DC GRID-NO.1 CURRENT .....	5 <i>max</i>	ma
PLATE INPUT .....	54 <i>max</i>	watts
GRID-NO.2 INPUT .....	3.5 <i>max</i>	watts
PLATE DISSIPATION .....	25 <i>max</i>	watts

**Maximum Circuit Values:**

Grid-No.1-Circuit Resistance .....	25000 <i>max</i>	ohms
------------------------------------	------------------	------

### BEAM POWER TUBE

# 1625

Heater-cathode type used as af power amplifier and modulator and as rf power amplifier and oscillator. Requires Medium seven-contact socket and may be operated in any position.

OUTLINE 34, *Outlines* Section, except has no bayonet pin. Heater volts (ac/dc), 12.6; amperes, 0.45. Except for heater rating and base, this type is identical with type 807.

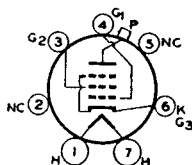

### POWER TRIODE

# 1626

Glass-octal heater-cathode type used as rf power amplifier and oscillator. May be used with full input up to 30 Mc. For operation at 60 Mc, plate voltage and plate input should be reduced to 96 per cent of maximum ratings; at 90 Mc, to 93 per cent. Requires Octal socket and may be operated in any position. OUTLINE 19, *Outlines* Section. Plate shows no color when tube is operated at maximum CCS ratings. The 1626 is used principally for renewal purposes.

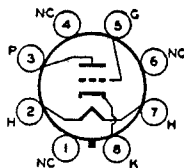

HEATER VOLTAGE (AC/DC) .....	12.6	volts
HEATER CURRENT .....	0.25	ampere
AMPLIFICATION FACTOR .....	5	
DIRECT INTERELECTRODE CAPACITANCES:		
Grid to plate .....	4.4	μf
Grid to cathode and heater .....	3.2	μf
Plate to cathode and heater .....	3.0	μf

### RF POWER AMPLIFIER AND OSCILLATOR—Class C Telegraphy and RF POWER AMPLIFIER—Class C FM Telephony

**Maximum CCS Ratings:**

DC PLATE VOLTAGE .....	250 <i>max</i>	volts
DC GRID VOLTAGE .....	-150 <i>max</i>	volts
DC PLATE CURRENT .....	25 <i>max</i>	ma
DC GRID CURRENT .....	8 <i>max</i>	ma
PLATE INPUT .....	6.25 <i>max</i>	watts
PLATE DISSIPATION .....	5 <i>max</i>	watts
<b>PEAK HEATER-CATHODE VOLTAGE:</b>		
Heater negative with respect to cathode .....	100 <i>max</i>	volts
Heater positive with respect to cathode .....	100 <i>max</i>	volts

### HIGH-MU TWIN TRIODE

# 1635

Glass-octal heater-cathode type used as power amplifier. Class B AF Power Amplifier maximum CCS plate dissipation (design-center value, per plate), 3 watts. Requires Octal socket and may be operated in any position. OUTLINE 13, *Outlines* Section. Plates show no color when tube is operated at maximum ratings. The 1635 is used principally for renewal purposes.

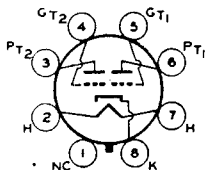

HEATER VOLTAGE (AC/DC) .....	6.3	volts
HEATER CURRENT .....	0.6	ampere

### AF POWER AMPLIFIER—Class B

**Maximum CCS Ratings:**

DC PLATE VOLTAGE .....	300 <i>max</i>	volts
PEAK PLATE CURRENT (Per plate) .....	90 <i>max</i>	ma
PLATE DISSIPATION (Per plate) .....	3 <i>max</i>	watts

**PEAK HEATER-CATHODE VOLTAGE:**

Heater negative with respect to cathode.....	90 max	volts
Heater positive with respect to cathode.....	90 max	volts

**Typical Operation, (Unless otherwise specified, values are for 2 units):**

DC Plate Voltage.....	300	300	volts
DC Grid Voltage.....	0	0	volts
Peak AF Grid-to-Grid Voltage.....	70	108*	volts
Zero-Signal DC Plate Current.....	6.6	6.6	ma
Maximum-Signal DC Plate Current.....	54	54	ma
Peak Grid Current (Per unit).....	38	39	ma
Plate-Supply Impedance.....	0	1000 <sup>m</sup>	ohms
Effective Load Resistance (Plate to plate).....	12000	12000	ohms
Effective Grid-Circuit Impedance (Per unit).....	0	516*	ohms
Total Harmonic Distortion.....	4	5	per cent
Maximum-Signal Power Output.....	10.4	10.4	watts

- Includes peak voltage drop through the grid-circuit impedance.
- Practical design value.
- \* At 400 cycles for class B stage in which the effective resistance per grid circuit is 500 ohms, and the leakage reactance of the coupling transformer is 50 millihenries. The driver stage should be capable of supplying the grids of the class B stage with the specified values at low distortion.

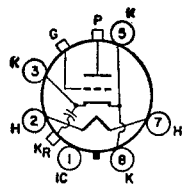

**HIGH-MU TRIODE**

Pencil type used as rf power amplifier or mixer at frequencies up to 1500 Mc and as cw oscillator up to 3500 Mc. Class C Telegraphy maximum plate dissipation, 6.25 watts CCS.

**4037**

Requires Octal socket and may be operated in any position. **OUTLINE 73, Outlines Section.** Will replace 2C40 planar type in most applications.

HEATER VOLTAGE.....	6.3	volts
HEATER CURRENT.....	0.145	ampere
CATHODE WARM-UP TIME, To reach 90 per cent of typical oscillator power output.....	10 max	seconds
AMPLIFICATION FACTOR.....	30	
TRANSCONDUCTANCE <sup>o</sup> .....	5300	μmhos
<b>DIRECT INTERELECTRODE CAPACITANCES (Approx.):</b>		
Grid to plate.....	1.1	μμf
Grid to cathode.....	1.8	μμf
Plate to cathode.....	0.05 max	μμf
Cathode to rf cathode terminal.....	100	μμf
PLATE SEAL TEMPERATURE.....	175 max	°C

<sup>o</sup> Plate volts, 250; plate milliamperes, 18.

**Maximum CCS Ratings: RF AMPLIFIER—Class A<sub>1</sub>**

*For altitudes up to 100,000 feet and frequencies up to 1700 Mc*

DC PLATE VOLTAGE.....	300 max	volts
DC GRID VOLTAGE.....	-100 max	volts
DC PLATE CURRENT.....	25 max	ma
PLATE DISSIPATION <sup>o</sup> .....	6.25 max	watts
<b>PEAK HEATER-CATHODE VOLTAGE:</b>		
Heater negative with respect to cathode.....	90 max	volts
Heater positive with respect to cathode.....	90 max	volts

**Maximum Circuit Values:**

Grid-Circuit Resistance.....	0.5 max	megohm
------------------------------	---------	--------

**RF POWER AMPLIFIER AND OSCILLATOR—Class C Telegraphy**

**Maximum CCS Ratings:**

*For altitudes up to 100,000 feet and frequencies up to 2000 Mc*

DC PLATE VOLTAGE.....	360 max	volts
DC GRID VOLTAGE.....	-100 max	volts
DC PLATE CURRENT.....	25 max	ma
DC GRID CURRENT.....	8 max	ma
PLATE INPUT.....	9 max	watts
PLATE DISSIPATION <sup>o</sup> .....	6.25 max	watts

**PEAK HEATER-CATHODE VOLTAGE:**

Heater negative with respect to cathode.....	90 max	volts
Heater positive with respect to cathode.....	90 max	volts

**Typical CCS Operation as Oscillator in Cathode-Drive Circuit:**

	At			
	500 Mc	2000 Mc	3000 Mc	
DC Plate-to-Grid Voltage.....	262	252	252	volts
DC Cathode-to-Grid Voltage*.....	12	2	2	volts
DC Plate Current.....	23	23	25	ma
DC Grid Current (Approx.).....	6	3	4	ma
Useful Power Output (Approx.).....	3	0.45	0.1	watts

**Typical CCS Operation as RF Power Amplifier in Cathode-Drive Circuit at 500 Mc:**

DC Plate-to-Grid Voltage.....	326	volts
DC Cathode-to-Grid Voltage*.....	51	volts
DC Plate Current.....	23	ma
DC Grid Current (Approx.).....	7	ma
Driver Power Output (Approx.).....	2	watts
Useful Power Output (Approx.).....	5	watts

**Maximum Circuit Values:**

Grid-Circuit Resistance.....	0.1 max	megohm
------------------------------	---------	--------

### PLATE-MODULATED RF POWER AMPLIFIER—Class C Telephony

**Maximum CCS Ratings:**

*For altitudes up to 100,000 feet and frequencies up to 2000 Mc*

DC PLATE VOLTAGE.....	275 max	volts
DC GRID VOLTAGE.....	-100 max	volts
DC PLATE CURRENT.....	22 max	ma
DC GRID CURRENT.....	8 max	ma
PLATE INPUT.....	6 max	watts
PLATE DISSIPATION*.....	4.25 max	watts

**PEAK HEATER-CATHODE VOLTAGE:**

Heater negative with respect to cathode.....	90 max	volts
Heater positive with respect to cathode.....	90 max	volts

**Maximum Circuit Values:**

Grid-Circuit Resistance.....	0.1 max	megohm
------------------------------	---------	--------

### FREQUENCY MULTIPLIER

**Maximum CCS Ratings:**

*For altitudes up to 100,000 feet and frequencies up to 1700 Mc*

DC PLATE VOLTAGE.....	330 max	volts
DC GRID VOLTAGE.....	-100 max	volts
DC PLATE CURRENT.....	22 max	ma
DC GRID CURRENT.....	8 max	ma
PLATE INPUT.....	7.5 max	watts
PLATE DISSIPATION*.....	6.25 max	watts

**PEAK HEATER-CATHODE VOLTAGE:**

Heater negative with respect to cathode.....	90 max	volts
Heater positive with respect to cathode.....	90 max	volts

### AVERAGE CHARACTERISTICS

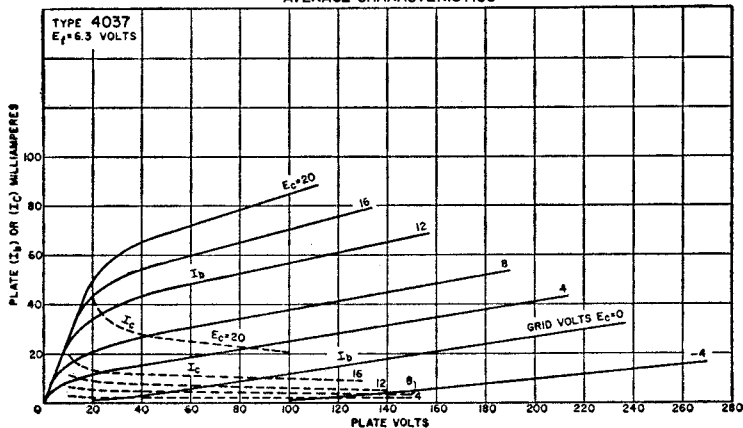

### Typical CCS Operation in Cathode-Drive Circuit:

	Tripler to 480 Mc	Doubler to 960 Mc	
DC Plate-to-Grid Voltage.....	390	370	volts
DC Cathode-to-Grid Voltage.....	90	70	volts
DC Plate Current.....	18	17.3	ma
DC Grid Current (Approx.).....	6	7	ma
Driver Power Output (Approx.).....	2.1	2	watts
Useful Power Output (Approx.).....	2.1	2	watts

### Maximum Circuit Values:

Grid-Circuit Resistance..... 0.1 max megohm

■ In applications where the plate dissipation exceeds 2.5 watts, it is important that a large area of contact be provided between the plate cylinder and the terminal to provide adequate heat conduction.

• Obtained from grid resistor.

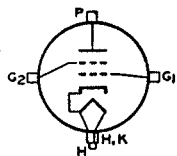

## BEAM POWER TUBE

Small, forced-air-cooled, cermet, heater-cathode type; used as voltage regulator tube in airborne and fixed-station equipment subject to severe vibration. Maximum CCS rat-

# 4600A

ings: plate volts, 3500 max; plate dissipation, 1750 max watts. May be operated in any position. OUTLINE 87, *Outlines Section*. Type 4600A has matrix cathode.

HEATER VOLTAGE (AC/DC).....	5.5 typical	volts
	6.0 max	volts
HEATER CURRENT.....	17.3	amperes
MINIMUM HEATING TIME.....	5	minutes
MU-FACTOR, GRID No.2 TO GRID No.1 <sup>o</sup> .....	17	
TERMINAL TEMPERATURE (Plate, grid No.2, grid-No.1, cathode, and heater):	250 max	°C

<sup>o</sup> Plate volts, 2500; grid-No.2 volts, 600; plate milliamperes, 600.

## VOLTAGE REGULATOR SERVICE

### Maximum CCS Ratings:

DC PLATE VOLTAGE.....	3500 max	volts
DC GRID No.2 VOLTAGE.....	1000 max	volts
DC PLATE CURRENT.....	1 max	ampere
GRID No.2 INPUT.....	50 max	watts
PLATE DISSIPATION.....	1750 max	watts

TYPICAL PLATE CHARACTERISTICS

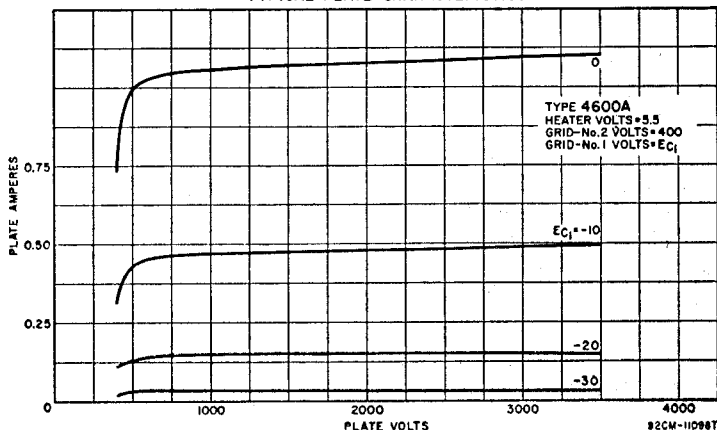

# 4604

## BEAM POWER TUBE

Glass octal type having quick-heating, coated filament; used as rf power amplifier in push-to-talk mobile and emergency-communication equipment. May be used with full input up

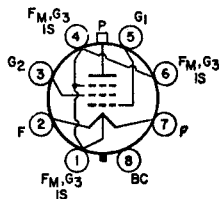

to 60 Mc and with reduced input to 175 Mc. Class C Telephony maximum plate dissipation, ICAS 25 watts.

FILAMENT VOLTAGE (AC/DC) .....	6.3	volts
FILAMENT CURRENT .....	0.65	ampere
FILAMENT HEATING TIME .....	1	second
TRANSCONDUCTANCE <sup>o</sup> .....	6000	μmhos
MU-FACTOR, GRID No.2 TO GRID No.1 <sup>o</sup> .....	4	
DIRECT INTERELECTRODE CAPACITANCES:		
Grid No.1 to Plate .....	0.24 max	μf
Grid No.1 to filament and grid No.3 and internal shield, base sleeve and grid No.2 .....	11	μf
Plate to filament and grid No.3 and internal shield, base sleeve and grid No.2 .....	8.5	μf
BULB TEMPERATURE (At hottest point) .....	220 max	°C

<sup>o</sup> Plate volts, 200; grid-No.2 volts, 200; plate milliamperes, 100.

### RF POWER AMPLIFIER AND OSCILLATOR—Class C Telephony and RF POWER AMPLIFIER—Class C FM Telephony

Maximum ICAS Ratings:		<i>Up to 60 Mc</i>
DC PLATE VOLTAGE .....	750 max	volts
DC GRID-NO.2 VOLTAGE .....	250 max	volts
DC GRID-NO.1 VOLTAGE .....	-150 max	volts
DC PLATE CURRENT .....	150 max	ma
DC GRID-NO.1 CURRENT .....	4 max	ma
PLATE INPUT .....	90 max	watts
GRID-NO.2 INPUT .....	3 max	watts
PLATE DISSIPATION .....	25 max	watts

#### Typical Operation as Amplifier at 175 Mc:

DC Plate Voltage .....	400	volts
DC Grid-No.2 Voltage .....	190	volts
From a series resistor of .....	18000	ohms
DC Grid-No.1 Voltage .....	-60	volts
From a grid resistor of .....	30000	ohms
DC Plate Current .....	150	ma
DC Grid-No.2 Current .....	11	ma
DC Grid-No.1 Current (Approx.) .....	2	ma
Driving Power (Approx.) .....	4.5	watts
Power Output (Approx.) .....	30	watts

#### Maximum Circuit Values:

Grid-No.1 Circuit Resistance .....	30000 max	ohms
------------------------------------	-----------	------

### OPERATING CONSIDERATIONS

Type 4604 requires Octal socket and may be operated in vertical position with base up or down, or in horizontal position with pins 3 and 7 in vertical plane. Effective rf grounding and simplified shielding of input from output are facilitated by the provision of a separate base-pin connection for the base sleeve and a single base-pin connection for filament midtap, grid No.3, and internal shield. OUTLINE 18, *Outlines* Section.

For operation at 150 Mc, plate voltage and plate input should be reduced to 72 per cent and 58 per cent of maximum ratings, respectively; at 160 Mc, to 69 per cent and 55 per cent, respectively; at 175 Mc, to 67 per cent and 54 per cent, respectively. Plate shows no color when the tube is operated at maximum ICAS ratings.

TYPICAL PLATE CHARACTERISTICS

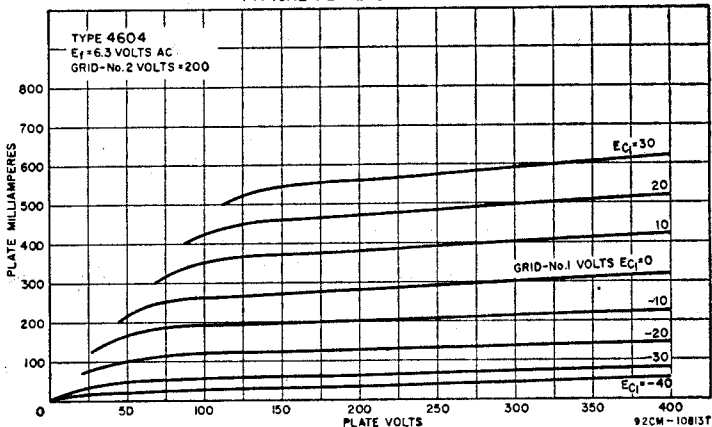

TYPICAL CHARACTERISTICS

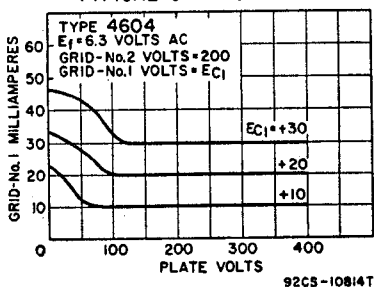

TYPICAL CHARACTERISTICS

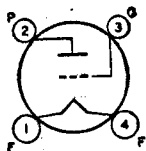
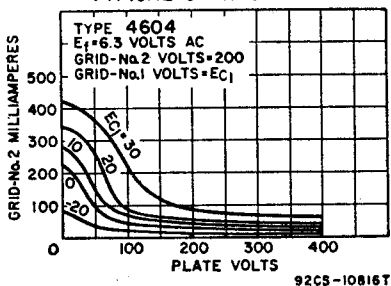

**POWER TRIODE**

Coated-filament type used as af power amplifier and modulator and as rf power amplifier and oscillator. May be used with full input up to 6 Mc and at reduced ratings up to 30 Mc.

**5556**

Requires Small four-contact socket and may be operated in vertical position with base up or down, or in horizontal position with pins 1 and 4 in vertical plane. *OUTLINE 25, Outlines Section.* Plate shows no color when tube is operated at maximum CCS ratings.

FILAMENT VOLTAGE (AC/DC)	4.5	volts
FILAMENT CURRENT	1.1	amperes
AMPLIFICATION FACTOR*	8.5	
TRANSCONDUCTANCE	1330	μmhos
DIRECT INTERELECTRODE CAPACITANCES:		
Grid to plate	6.7	μf
Grid to filament	2.3	μf
Plate to filament	2.2	μf

\* Plate volts, 350; grid volts, -20; plate milliamperes, 19.

**AF POWER AMPLIFIER AND MODULATOR—Class A**

<b>Maximum CCS Ratings:</b>		
DC PLATE VOLTAGE	350 max	volts
PLATE DISSIPATION	7.5 max	watts

## RF POWER AMPLIFIER AND OSCILLATOR—Class C Telegraphy and RF POWER AMPLIFIER—Class C FM Telephony

### Maximum CCS Ratings:

DC PLATE VOLTAGE .....	350 <i>max</i>	volts
DC GRID VOLTAGE .....	-150 <i>max</i>	volts
DC PLATE CURRENT .....	40 <i>max</i>	ma
DC GRID CURRENT (Approx.) .....	10 <i>max</i>	ma
PLATE INPUT .....	14 <i>max</i>	watts
PLATE DISSIPATION .....	10 <i>max</i>	watts

### HALF-WAVE MERCURY- VAPOR RECTIFIER

## 5558

Heater-cathode type used in power supply of transmitting and industrial equipment. Maximum peak inverse anode volts, 5,000; maximum average anode amperes, 2.5. Requires

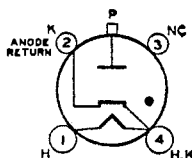

Small four-contact socket and may be operated in vertical position only, base down, OUTLINE 48, *Outlines* Section.

HEATER VOLTAGE*	5.0	volts
HEATER CURRENT .....	4.5	amperes
PEAK TUBE VOLTAGE DROP (Approx.) .....	12	volts

\* Heater voltage must be applied at least 5 minutes before application of anode voltage.

### HALF-WAVE RECTIFIER

<b>Maximum Ratings:</b>			
PEAK INVERSE ANODE VOLTAGE .....	2000 <i>max</i>	5000 <i>max</i>	volts
ANODE CURRENT:			
Peak .....	15 <i>max</i>	15 <i>max</i>	amperes
Average* .....	2.5 <i>max</i>	2.5 <i>max</i>	amperes
Fault, for duration of 0.1 second maximum .....	200 <i>max</i>	200 <i>max</i>	amperes
CONDENSED-MERCURY-TEMPERATURE RANGE .....	35 to 80	35 to 60	°C

\* Averaged over any interval of 15 seconds maximum.

### HALF-WAVE MERCURY- VAPOR RECTIFIER

## 5561

Heater-cathode type used in power supply of transmitting and industrial equipment. Rating I: maximum peak inverse anode volts, 3,000; maximum average anode amperes, 6.4.

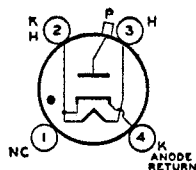

Rating II: maximum peak inverse anode volts, 10,000; maximum average anode amperes, 4. Requires Super-Jumbo four-contact socket and may be operated in vertical position only, base down. OUTLINE 66, *Outlines* Section.

HEATER VOLTAGE*	5	volts
HEATER CURRENT .....	10	amperes
PEAK TUBE VOLTAGE DROP (Approx.) .....	15	volts

\* Heater voltage must be applied at least 5 minutes before application of anode voltage.

### HALF-WAVE RECTIFIER

<b>Maximum Ratings:</b>			
PEAK INVERSE ANODE VOLTAGE .....	3000 <i>max</i>	10000 <i>max</i>	volts
ANODE CURRENT:			
Peak .....	40 <i>max</i>	16 <i>max</i>	amperes
Average* .....	6.4 <i>max</i>	4 <i>max</i>	amperes
Fault, for duration of 0.1 second maximum .....	400 <i>max</i>	160 <i>max</i>	amperes
CONDENSED-MERCURY-TEMPERATURE RANGE .....	40 to 80	25 to 50	°C

\* Averaged over any interval of 15 seconds maximum.



POWER TRIODE

5588

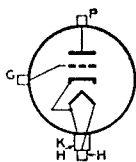

Forced-air-cooled heater-cathode type having integral radiator used in cathode-drive circuits as rf power amplifier and oscillator. May be used with full input up to 1200 Mc and at reduced ratings up to 2000 Mc. Type 5588 may be operated in vertical position only, radiator up or down. OUTLINE 89, *Outlines* Section. A minimum air flow of 10 cubic feet per minute should be directed through the radiator toward

the bulb and grid terminal when the 5588 is operated at maximum rated dissipation. Air flow should start before and continue during the application of any voltages to the tube. Maximum temperatures: incoming air, 45°C; radiator, 180°C; and grid terminal, 140°C. The 5588 is used principally for renewal purposes. For new equipment design, refer to type 6161.

HEATER VOLTAGE (AC/DC)°	6.3	volts
HEATER CURRENT	2.5	amperes
AMPLIFICATION FACTOR	18	
DIRECT INTERELECTRODE CAPACITANCES:		
Grid to plate	6.0	μμ
Grid to cathode and heater	13	μμf
Plate to cathode and heater <sup>□</sup>	0.92 max	μμf

° Rated heater voltage must be applied for a minimum time of one minute before voltages are applied to the other electrodes.

□ External shield connected to grid.

RF POWER AMPLIFIER AND OSCILLATOR—Class C Telegraphy and

RF POWER AMPLIFIER—Class C FM Telephony

Maximum CCS Ratings:

DC PLATE VOLTAGE	1000 max	volts
DC GRID VOLTAGE	-200 max	volts
DC PLATE CURRENT	300 max	ma
DC GRID CURRENT	100 max	ma
PLATE INPUT	250 max	watts
PLATE DISSIPATION	200 max	watts

POWER PENTODE

5618

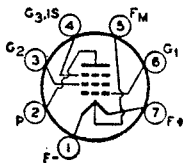

Seven-pin miniature type having quick-heating, mid-tapped, coated filament used as af power amplifier and modulator, rf power amplifier and oscillator, and frequency multiplier in

mobile and other communications equipment when compactness and low filament-power consumption are primary requirements. Designed for intermittent operation only. May be used with full input up to 100 Mc and with reduced input up to 165 Mc. Class C Telegraphy maximum ICAS plate dissipation, 5 watts. Type 5618 requires Miniature seven-contact socket and may be operated in vertical position with base up or down, or in horizontal position with pins 3 and 7 in vertical plane. OUTLINE 8, *Outlines* Section. For operation at 165 Mc, plate input should be reduced to 90 per cent of maximum rating. Plate shows no color when tube is operated at maximum ICAS ratings.

FILAMENT ARRANGEMENT	Series	Parallel	
FILAMENT VOLTAGE (AC/DC)	6	.3	volts
FILAMENT CURRENT	0.23	0.46	ampere
DIRECT INTERELECTRODE CAPACITANCES:			
Grid No.1 to plate		0.24 max	μμf
Grid No.1 to filament mid-tap, grid No.3, internal shield, and grid No.2		7	μμf
Plate to filament mid-tap, grid No.3, internal shield, and grid No.2		5	μμf

AF POWER AMPLIFIER AND MODULATOR—Class A1

Maximum ICAS Ratings:		
DC PLATE VOLTAGE	300 max	volts
DC GRID-NO.2 VOLTAGE	125 max	volts
GRID-NO.2 INPUT	2 max	watts
PLATE DISSIPATION	5 max	watts

<b>Circuit Values:</b>		
Grid-No.1-Circuit Resistance	5000 <i>min</i> 100000 <i>max</i>	ohms ohms

**RF POWER AMPLIFIER AND OSCILLATOR—Class C Telegraphy**  
and  
**RF POWER AMPLIFIER—Class C FM Telephony**

**Maximum ICAS Ratings:**

DC PLATE VOLTAGE	300 <i>max</i>	volts
DC GRID-NO.2 VOLTAGE	125 <i>max</i>	volts
DC GRID-NO.1 VOLTAGE	-125 <i>max</i>	volts
DC PLATE CURRENT	30 <i>max</i>	ma
DC GRID-NO.1 CURRENT	3 <i>max</i>	ma
PLATE INPUT	7.5 <i>max</i>	watts
GRID-NO.2 INPUT	2 <i>max</i>	watts
PLATE DISSIPATION	5 <i>max</i>	watts

<b>Circuit Values:</b>		
Grid-No.1-Circuit Resistance	5000 <i>min</i> 100000 <i>max</i>	ohms ohms

**MEDIUM-MU TRIODE**

5675

Pencil-type tube used in cathode-drive circuits as rf power amplifier and oscillator. Designed for use in coaxial-cylinder-type circuits, it may also be used in parallel-line or lumped cir-

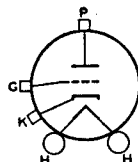

uits. May be used with full input up to 3000 Mc. Class C maximum CCS plate dissipation, 9 watts. The tube may be operated in any position. **OUTLINE 70, Outlines Section.**

HEATER VOLTAGE (AC/DC)	6.3	volts
HEATER CURRENT	0.135	ampere
TRANSCONDUCTANCE*	6200	μmhos
AMPLIFICATION FACTOR*	20	
PLATE RESISTANCE (Approx.)*	3225	ohms
<b>DIRECT INTERELECTRODE CAPACITANCES:</b>		
Grid to plate	1.4	μμf
Grid to cathode and heater	2.3	μμf
Plate to cathode and heater	0.09 <i>max</i>	μμf

\* Plate-supply volts, 135; cathode resistor, 68 ohms; plate milliamperes, 24.

**RF POWER AMPLIFIER AND OSCILLATOR—Class C**

**Maximum CCS Ratings:**

DC PLATE VOLTAGE	300 <i>max</i>	volts
DC GRID VOLTAGE	-90 <i>max</i>	volts
DC PLATE CURRENT	30 <i>max</i>	ma
DC GRID CURRENT	8 <i>max</i>	ma
PLATE INPUT	5 <i>max</i>	watts
PLATE DISSIPATION <sup>■</sup>	5 <i>max</i>	watts
<b>PEAK HEATER-CATHODE VOLTAGE:</b>		
Heater negative with respect to cathode	90 <i>max</i>	volts
Heater positive with respect to cathode	90 <i>max</i>	volts
PLATE-SEAL TEMPERATURE	175 <i>max</i>	°C

**Typical Operation as Cathode-Drive Oscillator at 1700 Mc.●**

DC Plate Voltage	120	volts
DC Grid Voltage	-8	volts
From a grid resistor of	2000	ohms
DC Plate Current	25	ma
DC Grid Current (Approx.)	4	ma
Power Output (Approx.)	475	mw

- In applications where the plate dissipation exceeds 2.5 watts, it is important that a large area of contact be provided between the plate cylinder and its lead connector to provide adequate heat conduction.
- At 3000 Mc, and with full ratings, a useful output of approximately 50 milliwatts may be obtained.

AVERAGE CHARACTERISTICS

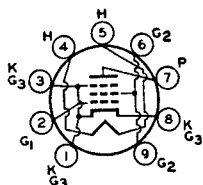
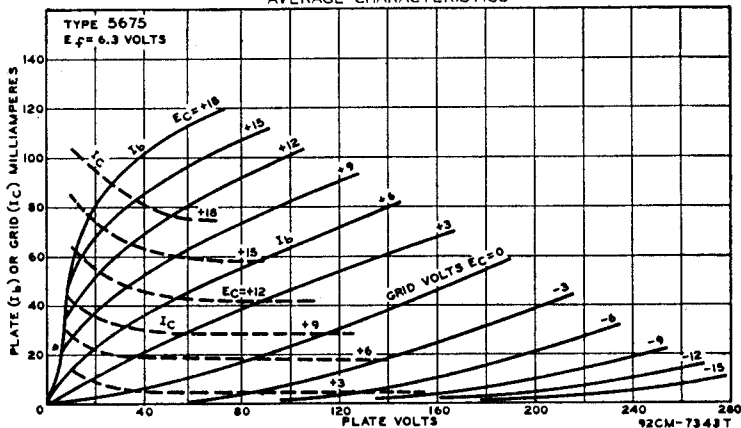

BEAM POWER TUBE

Miniature, heater-cathode type used as af power amplifier or as rf power amplifier at frequencies up to 160 Mc. Requires Noval nine-contact socket and may be operated in any position.

5686

OUTLINE 6, *Outlines* Section. The 5686 is a premium type and is subjected to special tests and controls during manufacture.

HEATER VOLTAGE (AC/DC).....	6.3	volts
HEATER CURRENT.....	0.35	ampere

DIRECT INTERELECTRODE Capacitances:	Without External Shield	With External Shield <sup>o</sup>	
Grid No.1 to plate.....	0.11 max	0.08 max	$\mu\mu\text{f}$
Grid No.1 to cathode, heater, grid No.3, and grid No.2....	6.4	6.5	$\mu\mu\text{f}$
Plate to cathode, heater, grid No.3, and grid No.2.....	4	8.5	$\mu\mu\text{f}$

<sup>o</sup> With external shield connected to cathode and grid No.3.

AF POWER AMPLIFIER—Class A<sub>1</sub>

Maximum Ratings:

PLATE VOLTAGE.....	275 max	volts
GRID-NO.2 VOLTAGE.....	275 max	volts
GRID-NO.2 INPUT.....	3.3 max	watts
PLATE DISSIPATION.....	8.25 max	watts
PEAK HEATER-CATHODE VOLTAGE:		
Heater negative with respect to cathode.....	100 max	volts
Heater positive with respect to cathode.....	100 max	volts

Typical Operation and Characteristics:

Plate Voltage.....	250	volts
Grid-No.2 Voltage.....	250	volts
Grid-No.1 Voltage.....	-12.5	volts
Peak AF Grid-No.1 Voltage.....	12.5	volts
Zero-Signal Plate Current.....	27	ma
Zero-Signal Grid-No.2 Current.....	3	ma
Plate Resistance (Approx.).....	45000	ohms
Transconductance.....	3100	$\mu\text{mhos}$
Load Resistance.....	9000	ohms
Maximum-Signal Power Output.....	2.7	watts

**Maximum Circuit Values:**

Grid-No.1 Circuit Resistance:		
For fixed-bias operation.....	0.1 max	megohm
For cathode-bias operation.....	0.5 max	megohm

**RF POWER AMPLIFIER—Class C**

**Maximum Ratings:**

PLATE VOLTAGE.....	275 max	volts
GRID-NO.2 VOLTAGE.....	275 max	volts
GRID-NO.1 VOLTAGE.....	-165 max	volts
PLATE CURRENT.....	44 max	ma
GRID-NO.2 CURRENT.....	16.5 max	ma
GRID-NO.1 CURRENT.....	3.3 max	ma
PLATE INPUT.....	11 max	watts
GRID-NO.2 INPUT.....	3.3 max	watts
PLATE DISSIPATION.....	8.25 max	watts
PEAK HEATER-CATHODE VOLTAGE:		
Heater negative with respect to cathode.....	100 max	volts
Heater positive with respect to cathode.....	100 max	volts

**Typical Operation:**

*At frequencies up to 160 Mc*

Plate Voltage.....	250	250	volts
Grid-No.2 Voltage.....	180	250	volts
Grid-No.1 Voltage.....	-30	-50	volts
From grid-No.1 resistor of.....	15000	25000	ohms
Peak RF Grid-No.1 Voltage.....	50	75	volts
Plate Current.....	30	40	ma
Grid-No.2 Current (Approx.).....	6.5	10.5	ma
Grid-No.1 Current (Approx.).....	2	2	ma
RF Grid-No.1 Driving Power (Approx.).....	0.1	0.15	watt
Power Output (Approx.).....	5	6.5	watts
Useful Power Output at 125 Mc.....	-	5.25	watts

**Maximum Circuit Values:**

Grid-No.1 Circuit Resistance.....	50000 max	ohms
-----------------------------------	-----------	------

**POWER TRIODE**

**5713**

Forced-air-cooled heater-cathode type having integral radiator used in grid-drive circuits and in cathode-drive circuits up to 220 Mc. Class C Telegraphy maximum CCS plate dis-

sipation, 250 watts. This type may be operated in vertical position only, radiator up or down. OUTLINE 91, *Outlines* Section.

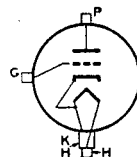

HEATER VOLTAGE (AC/DC) °.....	3.3 ± 0.2	volts
HEATER CURRENT.....	11.5	amperes
AMPLIFICATION FACTOR*.....	25	
DIRECT INTERELECTRODE CAPACITANCES (Approx.):		
Grid to plate.....	10.3	μf
Grid to cathode and heater.....	24	μf
Plate to cathode and heater.....	0.5	μf

° Heater voltage must be applied for a minimum time of 2 minutes before application of plate voltage.

\* Plate volts, 1000; plate milliamperes, 150.

**RF POWER AMPLIFIER AND OSCILLATOR—Class C Telegraphy  
and  
RF POWER AMPLIFIER—Class C FM Telegraphy**

**Maximum CCS Ratings:**

DC PLATE VOLTAGE.....	1500 max	volts
DC GRID VOLTAGE.....	-250 max	volts
DC PLATE CURRENT.....	300 max	ma
DC GRID CURRENT.....	50 max	ma
PLATE INPUT.....	450 max	watts
PLATE DISSIPATION.....	250 max	watts

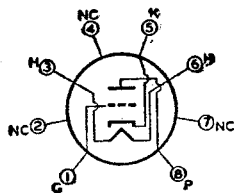

### MEDIUM-MU TRIODE

# 5718

Premium subminiature heater-cathode type used as rf amplifier and oscillator. May be used with full input up to 1000 Mc. Class C maximum CCS plate dissipation, 3.3 watts. Tube

may be operated in any position. **OUTLINE 3, Outlines Section.** The flexible leads of the 5718 are usually soldered to the circuit elements. Soldering of the leads may be made close to the glass stem provided care is taken to conduct excessive heat away from the lead seal. Otherwise, the heat of the soldering operation will crack the seals of the leads and damage the tube. Plate shows no color when tube is operated at maximum CCS ratings.

HEATER VOLTAGE (AC/DC) .....	6.3	volts
HEATER CURRENT .....	0.15	ampere
TRANSCONDUCTANCE* .....	6500	μmhos
AMPLIFICATION FACTOR* .....	27	
PLATE RESISTANCE (Approx.)* .....	4150	ohms
<b>DIRECT INTERELECTRODE CAPACITANCES:</b>		
Grid to plate .....	1.4	μf
Grid to cathode and heater .....	2.2	μf
Plate to cathode and heater .....	0.7	μf

\* Plate-supply volts, 150; cathode resistor, 180 ohms; plate milliamperes, 13.

#### RF AMPLIFIER AND OSCILLATOR—Class C

**Maximum CCS Ratings:**

DC PLATE VOLTAGE .....	165 <i>max</i>	volts
DC GRID VOLTAGE .....	-55 <i>max</i>	volts
DC PLATE CURRENT .....	22 <i>max</i>	ma
DC GRID CURRENT .....	5.5 <i>max</i>	ma
PLATE DISSIPATION .....	3.3 <i>max</i>	watts
<b>PEAK HEATER-CATHODE VOLTAGE:</b>		
Heater negative with respect to cathode .....	200 <i>max</i>	volts
Heater positive with respect to cathode .....	200 <i>max</i>	volts
<b>BULB TEMPERATURE</b> .....	250 <i>max</i>	°C

**Maximum Circuit Values:**

**Grid-Circuit Resistance:**

For cathode-bias operation .....	1.2 <i>max</i>	megohms
For fixed-bias operation .....		Not recommended

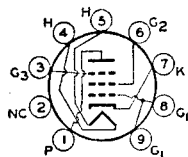

### BEAM POWER TUBE

# 5763

Nine-pin miniature heater-cathode type used as rf power amplifier and oscillator and as frequency multiplier. May be used with full input up to 50 Mc. For operation at 175

Mc, plate input should be reduced to 80 per cent of maximum rating. Class C Telegraphy maximum plate dissipation, CCS 12 watts, ICAS 13.5 watts. Requires Noval nine-contact socket and may be operated in any position. **OUTLINE 9, Outlines Section.** Plate shows no color when tube is operated at maximum CCS or ICAS ratings.

HEATER VOLTAGE (AC/DC) .....	6	volts
HEATER CURRENT .....	0.75	amperes
TRANSCONDUCTANCE* .....	7000	μmhos
MU-FACTOR, Grid No.2 to Grid No.1* .....	16	
<b>DIRECT INTERELECTRODE CAPACITANCES:</b>		
Grid No.1 to plate .....	0.3 <i>max</i>	μf
Grid No.1 to cathode, grid No.3, grid No.2, and heater .....	9.5	μf
Plate to cathode, grid No.3, grid No.2, and heater .....	4.5	μf

\* Plate and grid-No.2 volts, 250; grid-No.1 volts, -7.5; plate milliamperes, 45.

## RCA Transmitting Tubes

### PLATE-MODULATED RF POWER AMPLIFIER—Class C Telephony

Maximum Ratings:	CCS	ICAS	
DC PLATE VOLTAGE	250 max	300 max	volts
DC GRID-NO.3 VOLTAGE	0 max	0 max	volts
DC GRID-NO.2 VOLTAGE	250 max	250 max	volts
DC GRID-NO.1 VOLTAGE	-125 max	-125 max	volts
DC PLATE CURRENT	40 max	50 max	ma
DC GRID-NO.2 CURRENT	15 max	15 max	ma
DC GRID-NO.1 CURRENT	5 max	5 max	ma
PLATE INPUT	10 max	15 max	watts
GRID-NO.2 INPUT	1.5 max	1.5 max	watts
PLATE DISSIPATION	8 max	12 max	watts
<b>PEAK HEATER-CATHODE VOLTAGE:</b>			
Heater negative with respect to cathode	100 max	100 max	volts
Heater positive with respect to cathode	100 max	100 max	volts
BULB TEMPERATURE (At hottest point)	250 max	250 max	°C

#### Typical Operation at Frequencies up to 30 Mc:

DC Plate Voltage	250	300	volts
Grid No.3	Connected to cathode at socket		
DC Grid-No.2 Voltage <sup>‡</sup>	250	250	volts
DC Grid-No.1 Voltage <sup>°</sup>	-39	-42.5	volts
From grid-No.1 resistor of	39000	18000	ohms
Peak RF Grid-No.1 Voltage	46.5	53.5	volts
DC Plate Current	40	50	ma
DC Grid-No.2 Current	5.6	6	ma
DC Grid-No.1 Current (Approx.)	1	2.4	ma
Driving Power (Approx.)	0.05	0.15	watt
Useful Power Output (Approx.)	6.4 <sup>■</sup>	10 <sup>■</sup>	watts

#### Maximum Circuit Values (CCS or ICAS conditions):

Grid-No.1-Circuit Resistance	0.1 max	megohm
------------------------------	---------	--------

<sup>‡</sup> Obtained preferably from separate source modulated along with the plate supply, or from the modulated plate supply through a series resistor.

<sup>°</sup> Obtained from grid-No.1 resistor of value shown or from a combination of grid-No.1 resistor with either fixed supply or cathode resistor.

<sup>■</sup> Measured at load of output circuit.

### RF POWER AMPLIFIER AND OSCILLATOR—Class C Telegraphy and RF POWER AMPLIFIER—Class C FM Telephony

Maximum Ratings:	CCS	ICAS	
DC PLATE VOLTAGE	300 max	350 max	volts
DC GRID-NO.3 VOLTAGE	0 max	0 max	volts
DC GRID-NO.2 VOLTAGE	250 max	250 max	volts
DC GRID-NO.1 VOLTAGE	-125 max	-125 max	volts
DC PLATE CURRENT	50 max	50 max	ma
DC GRID-NO.2 CURRENT	15 max	15 max	ma
DC GRID-NO.1 CURRENT	5 max	5 max	ma
PLATE INPUT	15 max	17 max	watts
GRID-NO.2 INPUT	2 max	2 max	watts
PLATE DISSIPATION	12 max	13.5 max	watts
<b>PEAK HEATER-CATHODE VOLTAGE:</b>			
Heater negative with respect to cathode	100 max	100 max	volts
Heater positive with respect to cathode	100 max	100 max	volts
BULB TEMPERATURE (At hottest point)	250 max	250 max	°C

#### Typical Operation:

DC Plate Voltage	30Mc	50Mc	30Mc	
DC Plate Voltage	300	300	350	volts
Grid No. 3	Connected to cathode at socket			
DC Grid-No.2 Voltage	250	250	250	volts
DC Grid-No.1 Voltage <sup>‡</sup>	-28.5	-60	-28.5	volts
From grid-No.1 resistor of	18000	22000	18000	ohms
Peak RF Grid-No.1 Voltage	37.5	80	37	volts
DC Plate Current	50	50	48.5	ma
DC Grid-No.2 Current	6.6	5	6.2	ma
DC Grid-No.1 Current (Approx.)	1.6	3	1.6	ma
Driving Power (Approx.)	0.1	0.35	0.1	watt
Useful Power Output (Approx.)	10.3 <sup>■</sup>	7 <sup>■</sup>	12 <sup>■</sup>	watts

**Maximum Circuit Values (CCS or ICAS conditions):**

Grid-No.1-Circuit Resistance .....	0.1 max	megohm
♢ Obtained from fixed supply or from grid-No.1 resistor of value shown.		
♣ Measured at load of output circuit.		

**FREQUENCY MULTIPLIER**

Maximum CCS Ratings, Same as for Plate-Modulated RF Power Amplifier, ICAS, except:

GRID-NO.2 INPUT .....	2 max	watts
-----------------------	-------	-------

**Typical Operation at Frequencies up to 175 Mc:**

	Doubler	Tripler	
DC Plate Voltage .....	300	300	volts
Grid No.3 .....	Connected to cathode at socket		
DC Grid-No.2 Voltage .....	**	**	volts
DC Grid-No.1 Voltage $\delta$ .....	-75	-100	volts
From grid-No.1 resistor of .....	75000	100000	ohms
Peak RF Grid-No.1 Voltage .....	95	120	volts
DC Plate Current .....	40	35	ma
DC Grid-No.2 Current .....	4	5	ma
DC Grid-No.1 Current (Approx.) .....	1	1	ma
Driving Power (Approx.) .....	0.6	0.6	watt
Useful Power Output (Approx.) .....	2.1 <sup>♣</sup>	1.3 <sup>♣</sup>	watts

**Maximum Circuit Values:**

Grid-No.1-Circuit Resistance .....	0.1 max	megohm
------------------------------------	---------	--------

\*\* Obtained from 300-volt supply with series resistor of 12,500 ohms.

$\delta$  Obtained from fixed supply or from grid-No.1 resistor of value shown.

♣ Measured at load of output circuit.

**AVERAGE CHARACTERISTICS**

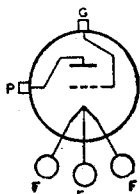
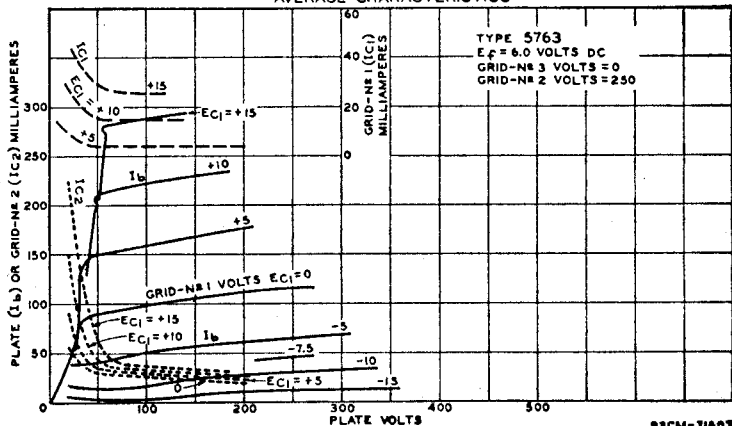

**POWER TRIODE**

Forced-air-cooled thoriated-tungsten-filament type having integral radiator used as af power amplifier and modulator and as rf power amplifier and oscillator. May be used with full

5786

input up to 160 Mc. Class C Telegraphy maximum CCS plate dissipation, 600 watts. May be operated in vertical position only, filament end up or down. OUTLINE 94, Outlines Section.

FILAMENT VOLTAGE (AC/DC) .....	11 $\pm$ 0.6	volts
FILAMENT CURRENT .....	12.5	amperes
FILAMENT STARTING CURRENT .....	50 max	amperes
AMPLIFICATION FACTOR* .....	32	

**DIRECT INTERELECTRODE CAPACITANCES:**

Grid to plate.....	5.3	$\mu\text{f}$
Grid to filament mid-tap.....	4.7	$\mu\text{f}$
Plate to filament mid-tap.....	3.8	$\mu\text{f}$

\* Grid volts, -25; plate milliamperes, 200.

**AF POWER AMPLIFIER AND MODULATOR—Class B**

**Maximum CCS Ratings:**

DC PLATE VOLTAGE.....	4000 max	volts
MAXIMUM-SIGNAL DC PLATE CURRENT <sup>■</sup> .....	500 max	ma
MAXIMUM-SIGNAL PLATE INPUT <sup>■</sup> .....	1500 max	watts
PLATE DISSIPATION <sup>■</sup> .....	600 max	watts

<sup>■</sup> Averaged over any audio-frequency cycle of sine-wave form.

**PLATE-MODULATED RF POWER AMPLIFIER—Class C Telephony**

**Maximum CCS Ratings:**

DC PLATE VOLTAGE.....	2500 max	volts
DC GRID VOLTAGE.....	-500 max	volts
DC PLATE CURRENT.....	400 max	ma
DC GRID CURRENT.....	150 max	ma
PLATE INPUT.....	1000 max	watts
PLATE DISSIPATION.....	400 max	watts

**RF POWER AMPLIFIER AND OSCILLATOR—Class C Telegraphy  
and  
RF POWER AMPLIFIER—Class C FM Telephony**

**Maximum CCS Ratings:**

DC PLATE VOLTAGE.....	3000 max	volts
DC GRID VOLTAGE.....	-500 max	volts
DC PLATE CURRENT.....	500 max	ma
DC GRID CURRENT.....	150 max	ma
PLATE INPUT.....	1500 max	watts
PLATE DISSIPATION.....	600 max	watts

**FIXED-TUNED OSCILLATOR TRIODE**

Pencil-type tube having integral resonators used in radiosonde service at 1680 Mc. Fixed-Tuned Oscillator maximum plate dissipation, 3.6 watts. May be operated in any position. The 5794 is identical with type 6562/5794A except that the 5794 does not have an external connection between the cathode and one side of the heater and requires a socket for the heater pins. OUTLINE 74, *Outlines* Section. The 5794 is a DISCONTINUED type listed for reference only.

**5794**

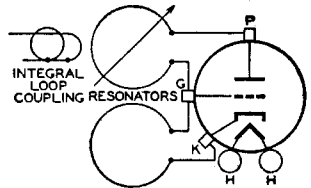

**5794A**

**FIXED-TUNED OSCILLATOR TRIODE**

See type 6562/5794A.

**HIGH-MU TRIODE**

**5876  
5876A**

Pencil types used as rf power amplifier and oscillator in airborne and mobile equipment at altitudes up to 100,000 feet without pressurized chambers. May be used with full input up

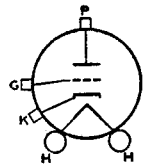

to 1700 Mc and with reduced input up to 3000 Mc. Designed for use in coaxial-cylinder-type circuits, but may also be used in parallel-line and lumped circuits. The 5876A meets the performance and environmental requirements of specification MIL-E-1D 1043 (AF). Type 5876 is used in applications not requiring special performance and environmental characteristics; otherwise, the 5876 is electrically and mechanically identical with type 5876A. Tubes may be operated in any position. OUTLINE 70, *Outlines* Section.



## Technical Data

HEATER VOLTAGE (AC/DC).....	6.3	volts
HEATER CURRENT.....	0.135	ampere
TRANSCONDUCTANCE <sup>o</sup> .....	6500	$\mu$ mhos
AMPLIFICATION FACTOR <sup>o</sup> .....	56	
PLATE RESISTANCE (Approx.) <sup>o</sup> .....	8625	ohms
DIRECT INTERELECTRODE CAPACITANCES:		
Grid to plate.....	1.4	$\mu$ f
Grid to cathode and heater.....	2.4	$\mu$ f
Plate to cathode and heater.....	0.035	$\mu$ f

<sup>o</sup>Plate-supply volts, 250; cathode resistor, 75 ohms; plate milliamperes, 18.

### RF AMPLIFIER—Class AB<sub>1</sub>

<b>Maximum CCS Ratings:</b>		<i>Up to 1700 Mc</i>
DC PLATE VOLTAGE.....	300 max	volts
DC GRID VOLTAGE.....	-100 max	volts
DC PLATE CURRENT.....	25 max	ma
PLATE DISSIPATION <sup>■</sup> .....	6.25 max	watts
PEAK HEATER-CATHODE VOLTAGE:		
Heater negative with respect to cathode.....	90 max	volts
Heater positive with respect to cathode.....	90 max	volts

#### Maximum Circuit Values:

Grid-Circuit Resistance.....	0.5 max	megohm
------------------------------	---------	--------

### RF POWER AMPLIFIER AND OSCILLATOR—Class C Telephony

<b>Maximum CCS Ratings:</b>		<i>Up to 1700 Mc</i>
DC PLATE VOLTAGE.....	360 max	volts
DC GRID VOLTAGE.....	-100 max	volts
DC PLATE CURRENT.....	25 max	volts
DC GRID CURRENT.....	8 max	volts
PLATE INPUT.....	9 max	watts
PLATE DISSIPATION <sup>■</sup> .....	6.25 max	watts
PEAK HEATER-CATHODE VOLTAGE:		
Heater negative with respect to cathode.....	90 max	volts
Heater positive with respect to cathode.....	90 max	volts

#### Typical CCS Operation as Oscillator in Cathode-Drive Circuit:

	<i>At</i>	<i>At</i>	<i>At</i>	
	<i>500 Mc</i>	<i>1700 Mc</i>	<i>3000 Mc</i>	
DC Plate-to-Grid Voltage.....	262	252	252	volts
DC Cathode-to-Grid Voltage.....	12	2	2	volts
DC Plate Current.....	23	23	25	ma
DC Grid Current (Approx.).....	6	3	4	ma
Useful Power Output (Approx.).....	3	0.75	0.1	watts

#### Typical CCS Operation as RF Power Amplifier in Cathode-Drive Circuit at 500 Mc:

DC Plate-to-Grid Voltage.....	326	volts
DC Cathode-to-Grid Voltage.....	51	volts
DC Plate Current.....	23	ma
DC Grid Current (Approx.).....	7	ma
Driver Power Output (Approx.).....	2	watts
Useful Power Output (Approx.).....	5	watts

#### Maximum Circuit Values:

Grid Circuit Resistance.....	0.1 max	megohm
------------------------------	---------	--------

### PLATE-MODULATED RF POWER AMPLIFIER—Class C Telephony

<b>Maximum CCS Ratings:</b>		<i>Up to 1700 Mc</i>
DC PLATE VOLTAGE.....	275 max	volts
DC GRID VOLTAGE.....	-100 max	volts
DC PLATE CURRENT.....	22 max	ma
DC GRID CURRENT.....	8 max	ma
PLATE INPUT.....	6.0 max	watts
PLATE DISSIPATION <sup>■</sup> .....	4.25 max	watts
PEAK HEATER-CATHODE VOLTAGE:		
Heater negative with respect to cathode.....	90 max	volts
Heater positive with respect to cathode.....	90 max	volts

#### Maximum Circuit Values:

Grid-Circuit Resistance.....	0.1 max	megohm
------------------------------	---------	--------

**FREQUENCY MULTIPLIER**

**Maximum CCS Ratings:**

DC PLATE VOLTAGE.....	330 max	Up to 1700 Mc	volts
DC GRID VOLTAGE.....	-100 max		volts
DC PLATE CURRENT.....	22 max		ma
DC GRID CURRENT.....	8 max		ma
PLATE INPUT.....	7.5 max		watts
PLATE DISSIPATION.....	6.25 max		watts
<b>PEAK HEATER-CATHODE VOLTAGE:</b>			
Heater negative with respect to cathode.....	90 max		volts
Heater positive with respect to cathode.....	90 max		volts

**Typical CCS Operation in Cathode-Drive Circuit:**

	<b>Tripler to 480 Mc</b>	<b>Doubler to 960 Mc</b>	
DC Plate-to-Grid Voltage.....	390	370	volts
DC Cathode-to-Grid Voltage.....	90	70	volts
DC Plate Current.....	18	17.3	ma
DC Grid Current (Approx.).....	6	7	ma
Driver Power Output (Approx.).....	2.1	2	watts
Useful Power Output (Approx.).....	2.1	2	watts

**Maximum Circuit Values:**

Grid-Circuit Resistance.....	0.1 max	0.1 max	megohm
------------------------------	---------	---------	--------

■ In applications where the plate dissipation exceeds 2.5 watts, it is important that a large area of contact be provided between the plate cylinder and the terminal to provide adequate heat conduction.

**AVERAGE CHARACTERISTICS**

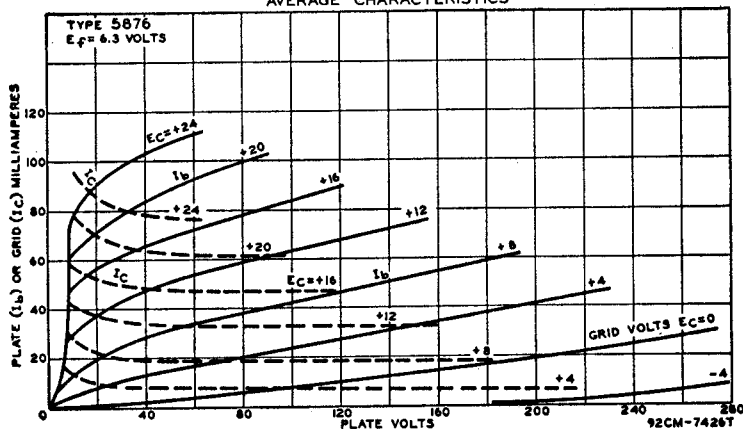

**MEDIUM-MU TRIODE**

**5893**

Pencil-type tube used as plate-pulsed oscillator, as rf power amplifier and oscillator, and as frequency doubler. May be used with full input up to 2000 Mc in cw service and in pulsed

applications up to 4000 Mc. Designed for use in coaxial-cylinder-type circuits, it may also be used in parallel-line and lumped circuits. Class C Telegraphy maximum plate dissipation, CCS 7 watts, ICAS 8 watts. May be operated in any position. OUTLINE 71, *Outlines* Section.

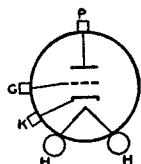

HEATER VOLTAGE (AC/DC):.....	6.0 + 5%	volts
	-10%	
HEATER CURRENT.....	0.280	ampere
TRANSCONDUCTANCE*.....	6000	μmhos
AMPLIFICATION FACTOR*.....	27	

## Technical Data

### DIRECT INTERELECTRODE CAPACITANCES:

Grid to plate . . . . .	1.7	μf
Grid to cathode and heater . . . . .	2.4	μf
Plate to cathode and heater . . . . .	0.07 max	μf

\* Plate-supply volts, 200; cathode resistor, 100 ohms; plate milliamperes, 25.

### RF AMPLIFIER—Class A<sub>1</sub>

<b>Maximum CCS Ratings:</b>	<i>Up to 3,400 Mc</i>	
DC PLATE VOLTAGE . . . . .	330 max	volts
DC GRID VOLTAGE . . . . .	-100 max	volts
DC PLATE CURRENT . . . . .	35 max	ma
PLATE DISSIPATION . . . . .	7 max	watts
<b>PEAK HEATER CATHODE VOLTAGE:</b>		
Heater negative with respect to cathode . . . . .	90 max	volts
Heater positive with respect to cathode . . . . .	90 max	volts
PLATE SEAL TEMPERATURE . . . . .	175 max	°C
<b>Maximum Circuit Value:</b>		
Grid Circuit Resistance . . . . .	0.5 max	megohm

### PLATE-PULSED OSCILLATOR<sup>▲</sup>—Class C

<b>Maximum CCS Ratings:</b>	<i>For a maximum on time<sup>●</sup> of 5 microseconds</i>	<i>Up to 4,000 Mc</i>
PEAK POSITIVE-PULSE PLATE-SUPPLY VOLTAGE <sup>♠</sup> . . . . .	1750 max	volts
PEAK NEGATIVE-PULSE GRID VOLTAGE . . . . .	150 max	volts
PEAK PLATE CURRENT FROM PULSE SUPPLY . . . . .	3 max	amperes
PEAK RECTIFIED GRID CURRENT . . . . .	1.3 max	amperes
DC PLATE CURRENT . . . . .	3 max	ma
DC GRID CURRENT . . . . .	1.3 max	ma
PLATE DISSIPATION <sup>⊙</sup> . . . . .	6 max	watts
DUTY FACTOR <sup>■</sup> . . . . .	0.001 max	
PULSE DURATION . . . . .	1.5 max	μsec
PLATE-SEAL TEMPERATURE . . . . .	175 max	°C

### Typical Operation with Rectangular Wave Shape in Cathode-Drive Circuit at 3300 Mc:

*With duty factor<sup>■</sup> of 0.001*

Peak Positive-Pulse Plate-Supply Voltage <sup>♠</sup> . . . . .	1750	volts
Peak Negative-Pulse Grid Voltage . . . . .	110	volts
From grid resistor of . . . . .	100	ohms
Peak Plate Current from Pulse Supply . . . . .	3.0	amperes
Peak Rectified Grid Current . . . . .	1.1	amperes
DC Plate Current . . . . .	3	ma
DC Grid Current . . . . .	1.1	ma
Useful Power Output at Peak of Pulse <sup>♠</sup> (Approx.) . . . . .	1200	watts
Pulse Duration . . . . .	1	μsec
Pulse Repetition Rate . . . . .	1000	pps

<sup>▲</sup> In this class of service, the heater should be allowed to warm up for a minimum of 60 seconds before plate voltage is applied.

<sup>●</sup> ON time for this tube is the sum of the durations of all the individual pulses which occur during any 5000-microsecond interval. Pulse duration is defined as the time interval between the two points on the pulse at which the instantaneous value is 70 per cent of the peak value. The peak value is defined as the maximum value of a smooth curve through the average of the fluctuations over the top portion of the pulse.

<sup>♠</sup> The magnitude of any spike on the plate voltage pulse should not exceed a value of 2000 volts with respect to cathode, and its duration should not exceed 0.01 microsecond measured at the peak-pulse-voltage level.

<sup>⊙</sup> In applications where the plate dissipation exceeds 2.5 watts, it is important that a large area of contact be provided between the plate cylinder and the connector in order to provide adequate heat conduction.

<sup>■</sup> Duty factor is the product of pulse duration and repetition rate. For variable pulse durations and pulse repetition rates, the duty factor for this tube is defined as the ratio of time "on" to total elapsed time in any 5000-microsecond interval.

<sup>♠</sup> This value is determined from the average power output using the duty factor of the peak power-output pulse. This procedure is necessary because the power-output-pulse duty factor may be less than the applied-voltage-pulse duty factor because of a delay in the start of rf power output.

### PLATE-MODULATED RF POWER AMPLIFIER—Class C Telephony

<b>Maximum Ratings:</b>	<i>Up to 2000 Mc</i>	<i>CCS</i>	<i>ICAS</i>	
DC PLATE VOLTAGE . . . . .	260 max	320 max		volts
DC GRID VOLTAGE . . . . .	-100 max	-100 max		volts
DC PLATE CURRENT . . . . .	33 max	33 max		ma

## RCA Transmitting Tubes

DC GRID CURRENT	15 <i>max</i>	15 <i>max</i>	ma
PLATE INPUT	8.5 <i>max</i>	10.5 <i>max</i>	watts
PLATE DISSIPATION <sup>®</sup>	5 <i>max</i>	5.5 <i>max</i>	watts
<b>PEAK HEATER-CATHODE VOLTAGE:</b>			
Heater negative with respect to cathode	90 <i>max</i>	90 <i>max</i>	volts
Heater positive with respect to cathode	90 <i>max</i>	90 <i>max</i>	volts
PLATE-SEAL TEMPERATURE	175 <i>max</i>	175 <i>max</i>	°C

<b>Typical Operation in Cathode-Drive Circuit at 500 Mc:</b>			
	CCS	ICAS	
DC Plate-to-Grid Voltage	286	345	volts
DC Cathode-to-Grid Voltage $\delta$	36	45	volts
DC Plate Current	30	30	ma
DC Grid Current (Approx.)	11	12	ma
Driver Power Output (Approx.)	1.8	2.0	watts
Useful Power Output (Approx.)	5.5	6.5	watts

**Maximum Circuit Values (CCS or ICAS conditions):**

Grid-Circuit Resistance	0.1 <i>max</i>	megohm
-------------------------	----------------	--------

<sup>®</sup> In applications where the plate dissipation exceeds 2.5 watts, it is important that a large area of contact be provided between the plate cylinder and the connector in order to provide adequate heat conduction.

$\delta$  Obtained from grid resistor.

### RF POWER AMPLIFIER AND OSCILLATOR—Class C Telephony and

### RF POWER AMPLIFIER—Class C FM Telephony

<b>Maximum Ratings:</b>	<i>Up to 2000 Mc</i>	CCS	ICAS	
DC PLATE VOLTAGE		320 <i>max</i>	400 <i>max</i>	volts
DC GRID VOLTAGE		-100 <i>max</i>	-100 <i>max</i>	volts
DC PLATE CURRENT		35 <i>max</i>	40 <i>max</i>	ma
DC GRID CURRENT		15 <i>max</i>	15 <i>max</i>	ma
PLATE INPUT		11 <i>max</i>	16 <i>max</i>	watts
PLATE DISSIPATION <sup>®</sup>		7 <i>max</i>	8 <i>max</i>	watts
<b>PEAK HEATER-CATHODE VOLTAGE:</b>				
Heater negative with respect to cathode		90 <i>max</i>	90 <i>max</i>	volts
Heater positive with respect to cathode		90 <i>max</i>	90 <i>max</i>	volts
PLATE-SEAL TEMPERATURE		175 <i>max</i>	175 <i>max</i>	°C

**Typical Operation as RF Power Amplifier in Cathode-Drive Circuit:**

	<i>500 Mc</i>	<i>1000 Mc</i>	<i>500 Mc</i>	<i>1000 Mc</i>	
DC Plate-to-Grid Voltage	347	330	401	383	volts
DC Cathode-to-Grid Voltage $\delta$	47	30	51	33	volts
DC Plate Current	33	33	35	35	ma
DC Grid Current (Approx.)	13	12	13	13	ma
Driver Power Output (Approx.)	2	1.9	2.5	2.4	watts
Useful Power Output (Approx.)	7.5	5.5	8.5	6.5	watts

**Typical Operation as Oscillator in Cathode-Drive Circuit at 500 Mc:**

DC Plate-to-Grid Voltage	347	401	volts
DC Cathode-to-Grid Voltage $\delta$	47	51	volts
DC Plate Current	33	35	ma
DC Grid Current (Approx.)	13	13	ma
Useful Power Output (Approx.)	5	6	watts

**Maximum Circuit Values (CCS or ICAS conditions):**

Grid-Circuit Resistance	0.1 <i>max</i>	megohm
-------------------------	----------------	--------

### FREQUENCY DOUBLER

<b>Maximum Ratings:</b>	<i>Up to 2000 Mc</i>	CCS	ICAS	
DC PLATE VOLTAGE		260 <i>max</i>	320 <i>max</i>	volts
DC GRID VOLTAGE		-100 <i>max</i>	-100 <i>max</i>	volts
DC PLATE CURRENT		33 <i>max</i>	33 <i>max</i>	ma
DC GRID CURRENT		12 <i>max</i>	12 <i>max</i>	ma
PLATE INPUT		8.5 <i>max</i>	10.5 <i>max</i>	watts
PLATE DISSIPATION <sup>®</sup>		6 <i>max</i>	7.5 <i>max</i>	watts
<b>PEAK HEATER-CATHODE VOLTAGE:</b>				
Heater negative with respect to cathode		90 <i>max</i>	90 <i>max</i>	volts
Heater positive with respect to cathode		90 <i>max</i>	90 <i>max</i>	volts
PLATE-SEAL TEMPERATURE		175 <i>max</i>	175 <i>max</i>	°C

**Typical Operation as Doubler to 1000 Mc in Cathode-Drive Circuit:**

DC Plate-to-Grid Voltage .....	290	350	volts
DC Cathode-to-Grid Voltage $\delta$ .....	40	50	volts
DC Plate Current .....	33	33	ma
DC Grid Current (Approx.) .....	7	8	ma
Driver Power Output (Approx.) .....	3.2	3.5	watts
Useful Power Output (Approx.) .....	2.75	3.0	watts

**Maximum Circuit Values (CCS or ICAS conditions):**

Grid-Circuit Resistance .....

0.1 *max* megohm

\* In applications where the plate dissipation exceeds 2.5 watts, it is important that a large area of contact be provided between the plate cylinder and the connector in order to provide adequate heat conduction.

$\delta$  Obtained from grid resistor.

**AVERAGE CHARACTERISTICS**

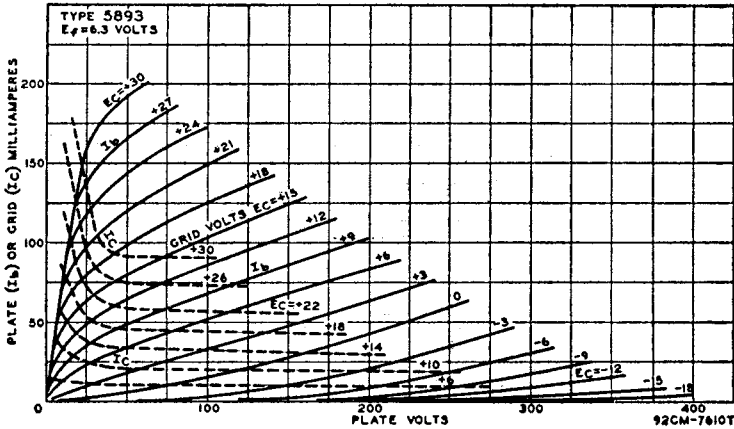

**TWIN BEAM POWER TUBE**

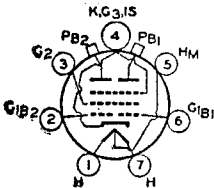

Small, heater-cathode type for af power amplifier and rf power amplifier and oscillator, and frequency-multiplier service at frequencies up to 500 Mc. Heater volts (ac/dc), 6.3 (parallel), 12.6 (series); amperes, 1.8 (parallel), 0.9 (series). Direct interelectrode capacitances (each unit): grid No.1 to plate, 0.08 *max*  $\mu$ f; grid No.1 to cathode, grid No.3, internal shield, grid No.2 and heater, 11  $\mu$ f; plate to cathode,

**5894**

grid No.3, internal shield, grid No.2 and heater, 3.4  $\mu$ f. Requires Septar seven-contact socket and may be operated in vertical position, base up or down, or in horizontal position with plate terminals in horizontal plane. Maximum over-all length, 4-5/16 inches; maximum diameter, 1-15/16 inches. Maximum CCS ratings as PUSH-PULL RF POWER AMPLIFIER AND OSCILLATOR: dc plate volts, 600 *max*; grid-No.2 volts, 250 *max*; dc grid-No.1 volts, -175 *max*; dc plate ma., 220 *max*; dc grid-No.1 ma., 10 *max*; plate input 120 *max* watts; grid-No.2 input, 7 *max* watts; plate dissipation, 40 *max* watts. The 5894 is a DISCONTINUED type listed for reference only.

**POWER TRIODE**

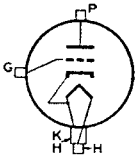

**5946**

Forced-air-cooled heater-cathode type used as plate-pulsed oscillator and amplifier. May be used with full input up to 1300 Mc. For operation at 2000 Mc, plate voltage and plate input should be reduced to 75 per cent of maximum ratings. Class C maximum plate dissipation, 250 watts. Tube may be operated in any position. OUTLINE 89, *Outlines Section*. A minimum air flow of 16 cubic feet per minute should be directed through

the radiator toward the bulb and grid terminal when the 5946 is operated at maximum rated dissipation. Air flow should start before and continue during application of any voltages to the tube. Heater power, plate power, and air may be removed simultaneously. Maximum temperatures: radiator (measured on core at end adjacent to plate ring), 180°C; grid terminal, 150°C; plate, grid, and cathode seals, 150°C.

HEATER VOLTAGE (AC/DC)°	6.3	volts
HEATER CURRENT	3.4	amperes
AMPLIFICATION FACTOR*	25	
DIRECT INTERELECTRODE CAPACITANCES:		
Grid to plate	6	μf
Grid to cathode and heater	11	μf
Plate to cathode and heater <sup>□</sup>	0.19	μf

° Heater voltage must be applied for a minimum period of 1 minute before the application of plate voltage.

\* Grid volts, -15; plate milliamperes, 250.

□ With external shield connected to grid.

### Maximum Ratings: PLATE-PULSED OSCILLATOR AND AMPLIFIER—Class C

For an ON time <sup>□</sup> of	10 max	100 max	μsec
PEAK POSITIVE-PULSE PLATE-SUPPLY VOLTAGE <sup>♦</sup>	7500 max	7500 max	volts
PEAK NEGATIVE-PULSE GRID VOLTAGE	600 max	600 max	volts
PEAK PLATE CURRENT FROM PULSE SUPPLY	4.5 max	3.5 max	amperes
PEAK RECTIFIED GRID CURRENT	1.0 max	0.75 max	amperes
DC PLATE CURRENT	45 max	250 max	ma
DC GRID CURRENT	10 max	70 max	ma
PLATE INPUT	340 max	340 max	watts
PLATE DISSIPATION	250 max	250 max	watts

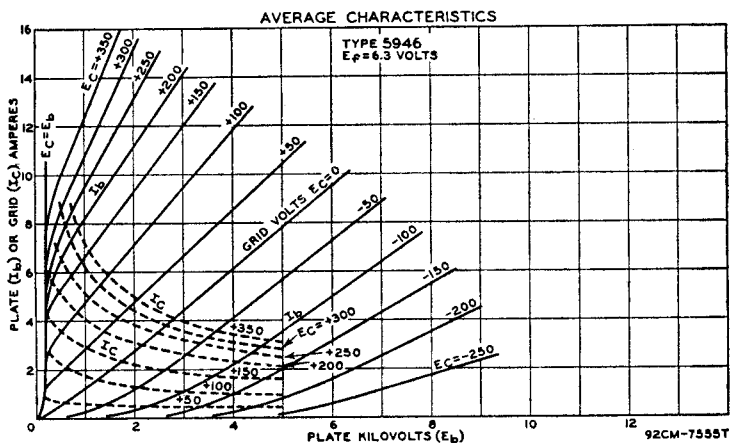

### Typical Operation with Rectangular Wave Shape in Cathode-Drive Oscillator Circuit at 1250 Mc:

With duty factor<sup>■</sup> of 0.01

Peak Positive-Pulse Plate-Supply Voltage <sup>♦</sup>	5500	7500	volts
Peak Negative-Pulse Grid Voltage	375	500	volts
From cathode resistor of <sup>°</sup>	100	100	ohms
Peak RF Grid Voltage	625	850	volts
Peak Plate Current from Pulse Supply	3.5	4.5	amperes
Peak Rectified Grid Current	0.25	0.50	amperes
DC Plate Current	35	45	ma
DC Grid Current	2.5	5	ma
Useful Power Output at Peak of Pulse <sup>♦</sup> (Approx.)	8000	14000	watts

° ON time for this tube is defined as the sum of the durations of all the individual pulses which occur during any 1000-microsecond interval. Pulse duration is defined as the time interval between the two points on the pulse at which the instantaneous value is 70 per cent of the peak value. The peak value is defined as the maximum value of a smooth curve through the average of the fluctuations over the top portion of the pulse.

- ♦ The magnitude of any spike on the plate-voltage pulse should not exceed a value of 8.5 kilovolts with respect to cathode, and its duration should not exceed 0.5 microsecond measured at the peak-pulse-value level.
- Duty factor is the product of pulse duration and repetition rate. For variable pulse durations and pulse repetition rates, the duty factor for this tube is defined as the ratio of "on" to total elapsed time in any 500-microsecond interval.
- △ Obtained preferably from cathode resistor of value shown. In certain applications, partial grid-resistor bias may be used.
- ♣ Determined from the average power output using the duty factor of the peak power output pulse. This procedure is necessary because the power-output-pulse duty factor may be less than the applied-voltage-pulse duty factor because of a delay in the start of rf power output.

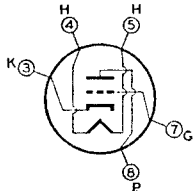

## OSCILLATOR TRIODE

Subminiature heater-cathode type used in radiosonde service at 400 Mc. Class C Telegraphy maximum CCS plate dissipation, 3 watts. May be operated in any position. **OUTLINE**

# 6026

4, *Outlines* Section. The flexible leads of the 6026 are usually soldered to the circuit elements. Soldering of the leads may be made close to the glass-button base provided care is taken to conduct excessive heat away from the lead seal. Otherwise, the heat of the soldering operation will crack the seals of the leads and damage the tube. Plate shows no color when tube is operated at maximum CCS ratings.

HEATER VOLTAGE RANGE (AC/DC) °	5.2 to 6.6	volts
HEATER CURRENT (At 6.3 volts)	0.2	ampere
TRANSCONDUCTANCE*	5900	μmhos
AMPLIFICATION FACTOR*	24	
PLATE RESISTANCE (Approx.)*	4000	ohms
<b>DIRECT INTERELECTRODE CAPACITANCES:</b>		
Grid to plate	1.3	μf
Grid to cathode and heater	2.0	μf
Plate to cathode and heater	0.42	μf

° For radiosonde applications in which the heater is supplied from batteries and the equipment-design requirements of minimum size, light weight, and high efficiency are the primary considerations even though the average life expectancy of the 6026 in such service is only a few hours.  
 \* Plate-supply volts, 120; cathode resistor, 220 ohms; plate milliamperes, 12.

### OSCILLATOR—Class C Telegraphy

**Maximum CCS Ratings:**

DC PLATE VOLTAGE	150 <i>max</i>	volts
DC GRID VOLTAGE	-50 <i>max</i>	volts
TOTAL CATHODE CURRENT	40 <i>max</i>	ma
DC GRID CURRENT	10 <i>max</i>	ma
PLATE INPUT	3.3 <i>max</i>	watts
PLATE DISSIPATION	3.0 <i>max</i>	watts
PEAK HEATER-CATHODE VOLTAGE	0 <i>max</i>	volts

**Typical Operation as an Oscillator at 400 Mc:**

DC Plate Voltage	135	volts
Grid Resistor	1300	ohms
DC Plate Current	20	ma
DC Grid Current (Approx.)	9.5	ma
Useful Power Output	1.25	watts

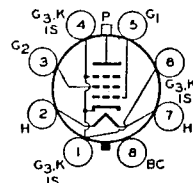

## BEAM POWER TUBE

Small, sturdy, glass-octal heater-cathode type used as af power amplifier and modulator and as rf power amplifier and oscillator. May be used with full input up to 60 Mc and with

# 6146

reduced input up to 175 Mc. Class C Telegraphy maximum plate dissipation, CCS 20 watts, ICAS 25 watts.

## RCA Transmitting Tubes

HEATER VOLTAGE (AC/DC) .....	6.3	volts
HEATER CURRENT .....	1.25	amperes
TRANSCONDUCTANCE* .....	7000	$\mu$ mhos
MU-FACTOR, Grid No.2 to Grid No.1* .....	4.5	
<b>DIRECT INTERELECTRODE CAPACITANCES:</b>		
Grid No.1 to plate .....	0.24 max	$\mu$ f
Grid No.1 to cathode, grid No.3, grid No.2, internal shield, base sleeve, and heater .....	13	$\mu$ f
Plate to cathode, grid No.3, grid No.2, internal shield, base sleeve, and heater .....	8.5	$\mu$ f

\* Plate and grid-No.2 volts, 200; plate milliamperes, 100.

### AF POWER AMPLIFIER AND MODULATOR—Class AB<sub>1</sub>

<b>Maximum Ratings:</b>		<i>CCS</i>	<i>ICAS</i>	
DC PLATE VOLTAGE .....		600 max	750 max	volts
DC GRID-NO.2 VOLTAGE .....		250 max	250 max	volts
MAXIMUM-SIGNAL DC PLATE CURRENT <sup>■</sup> .....		125 max	135 max	ma
MAXIMUM-SIGNAL PLATE INPUT <sup>■</sup> .....		60 max	85 max	watts
MAXIMUM-SIGNAL GRID-NO.2 INPUT <sup>■</sup> .....		3 max	3 max	watts
PLATE DISSIPATION <sup>■</sup> .....		20 max	25 max	watts
<b>PEAK HEATER-CATHODE VOLTAGE:</b>				
Heater negative with respect to cathode .....		135 max	135 max	volts
Heater positive with respect to cathode .....		135 max	135 max	volts

*Values are for 2 tubes*

<b>Typical Operation:</b>		<i>CCS</i>			<i>ICAS</i>		
DC Plate Voltage .....		400	500	600	600	750	volts
DC Grid-No.2 Voltage <sup>⊙</sup> .....		190	185	180	200	195	volts
DC Grid-No.1 Voltage:							
With fixed-bias source .....		-40	-40	-45	-50	-50	volts
Peak AF Grid-No.1-to-Grid-No.1 Voltage <sup>⊙</sup> ..		80	80	90	100	100	volts
Zero-Signal DC Plate Current .....		63	57	26	28	23	ma
Maximum-Signal DC Plate Current .....		228	215	200	229	220	ma
Zero-Signal DC Grid-No.2 Current .....		2.5	2	1	1	1	ma
Maximum-Signal DC Grid-No.2 Current .....		25	25	23	27	26	ma
Effective Load Resistance (Plate to plate) ..		4000	5500	7000	6000	8000	ohms
Maximum-Signal Driving Power (Approx.) ..		0	0	0	0	0	watts
Maximum-Signal Power Output (Approx.) ..		55	70	82	95	120	watts

#### Maximum Circuit Values (CCS or ICAS):

Grid-No.1-Circuit Resistance under any condition: <sup>⊠</sup>		0.1 max	megohm
With fixed bias .....			Not recommended
With cathode bias .....			Not recommended

⊙ The driver stage should be capable of supplying the No.1 grids of the class AB<sub>1</sub> stage with the specified driving voltage at low distortion.

⊠ The type of input coupling network used should not introduce too much resistance in the grid-No.1 circuit. Transformer or impedance coupling devices are recommended.

### AF POWER AMPLIFIER AND MODULATOR—CLASS AB<sub>2</sub>

<b>Maximum Ratings:</b>		<i>CCS</i>			<i>ICAS</i>		
DC PLATE VOLTAGE .....		600 max	750 max	750 max	750 max	750 max	volts
DC GRID-NO.2 (SCREEN-GRID) VOLTAGE .....		250 max	250 max	250 max	250 max	250 max	volts
MAXIMUM-SIGNAL DC PLATE CURRENT <sup>■</sup> .....		125 max	135 max	135 max	135 max	135 max	ma
MAXIMUM-SIGNAL PLATE INPUT <sup>■</sup> .....		62.5 max	90 max	90 max	90 max	90 max	watts
MAXIMUM-SIGNAL GRID-NO.2 INPUT <sup>■</sup> .....		3 max	3 max	3 max	3 max	3 max	watts
PLATE DISSIPATION <sup>■</sup> .....		20 max	25 max	25 max	25 max	25 max	watts
<b>PEAK HEATER-CATHODE VOLTAGE:</b>							
Heater negative with respect to cathode .....		135 max	135 max	135 max	135 max	135 max	volts
Heater positive with respect to cathode .....		135 max	135 max	135 max	135 max	135 max	volts
BULB TEMPERATURE (At hottest point) .....		220 max	220 max	220 max	220 max	220 max	°C

#### Typical Operation (Values are for 2 tubes):

DC Plate Voltage .....		400	500	600	600	750	volts
DC Grid-No.2 Voltage <sup>⊙</sup> .....		175	175	165	190	165	volts
DC Grid-No.1 (Control-Grid) Voltage .....		-41	-44	-44	-48	-46	volts
Peak AF Grid-No.1-to-Grid-No.1 Voltage .....		95	102	97	109	108	volts
Zero-Signal DC Plate Current .....		33	27	22	28	22	ma
Maximum-Signal DC Plate Current .....		232	242	207	270	240	ma
Zero-Signal DC Grid-No.2 Current .....		1.1	0.7	0.6	1.2	0.3	ma
Maximum-Signal DC Grid-No.2 Current .....		18	18	17	20	20	ma
Maximum-Signal DC Grid-No.1 Current .....		1.6	1.9	1.1	2	2.6	ma
Effective Load Resistance (Plate to plate) ..		3700	4600	6800	5000	7400	ohms
Maximum-Signal Driving Power (Approx.) ..		0.2	0.3	0.2	0.3	0.4	watt
Maximum-Signal Power Output (Approx.) ..		62	83	90	113	131	watts



## Technical Data

### Maximum Circuit Values (CCS or ICAS conditions):

Grid-No.1-Circuit Resistance . . . . . 30000‡ max ohms

■ Averaged over any audio-frequency cycle of sine-wave form.

° Obtained preferably from a separate source or from the plate-voltage supply with a voltage divider.

‡ For operation at less than maximum ratings, this value may be as high as 100000 ohms.

### PLATE-MODULATED RF POWER AMPLIFIER—Class C Telephony

Maximum Ratings:	CCS	ICAS	
DC PLATE VOLTAGE . . . . .	480 max	600 max	volts
DC GRID-NO.2 VOLTAGE . . . . .	250 max	250 max	volts
DC GRID-NO.1 VOLTAGE . . . . .	-150 max	-150 max	volts
DC PLATE CURRENT . . . . .	117 max	125 max	ma
DC GRID-NO.1 CURRENT . . . . .	3.5 max	4.0 max	ma
PLATE INPUT . . . . .	45 max	67.5 max	watts
GRID-NO.2 INPUT . . . . .	2 max	2 max	watts
PLATE DISSIPATION . . . . .	13.3 max	16.7 max	watts
<b>PEAK HEATER-CATHODE VOLTAGE:</b>			
Heater negative with respect to cathode . . . . .	135 max	135 max	volts
Heater positive with respect to cathode . . . . .	135 max	135 max	volts
BULB TEMPERATURE (At hottest point) . . . . .	220 max	220 max	°C

### Typical Operation:

DC Plate Voltage . . . . .	400	475	600	volts
DC Grid-No.2 Voltage <sup>°</sup> . . . . .	150	135	150	volts
From series resistor of . . . . .	33000	51000	56000	ohms
DC Grid-No.1 Voltage <sup>°</sup> . . . . .	-87	-77	-87	volts
From grid-No.1 resistor of . . . . .	27000	27000	27000	ohms
Peak RF Grid-No.1 Voltage . . . . .	107	95	107	volts
DC Plate Current . . . . .	112	94	112	ma
DC Grid-No.2 Current . . . . .	7.8	6.4	7.8	ma
DC Grid-No.1 Current (Approx.) . . . . .	3.4	2.8	3.4	ma
Driving Power (Approx.) . . . . .	0.4	0.3	0.4	watt
Power Output (Approx.) . . . . .	32	34	52	watts

### Maximum Circuit Values (CCS or ICAS conditions):

Grid-No.1-Circuit Resistance . . . . . 30000‡ max ohms

♠ Obtained preferably from a separate source modulated along with the plate supply, or from the modulated plate supply through a series resistor of value shown.

° Obtained from grid-No.1 resistor of value shown or from a combination of grid-No.1 resistor with either fixed supply or cathode resistor.

‡ For operation at less than maximum rated conditions, this value may be as high as 100000 ohms.

### RF POWER AMPLIFIER AND OSCILLATOR—Class C Telephony and

### RF POWER AMPLIFIER—Class C FM Telephony

Maximum Ratings:	CCS	ICAS	
DC PLATE VOLTAGE . . . . .	600 max	750 max	volts
DC GRID-NO.2 VOLTAGE . . . . .	250 max	250 max	volts
DC GRID-NO.1 VOLTAGE . . . . .	-150 max	-150 max	volts
DC PLATE CURRENT . . . . .	140 max	150 max	ma
DC GRID-NO.1 CURRENT . . . . .	3.5 max	4.0 max	ma
PLATE INPUT . . . . .	67.5 max	90 max	watts
GRID-NO.2 INPUT . . . . .	3 max	3 max	watts
PLATE DISSIPATION . . . . .	20 max	25 max	watts
<b>PEAK HEATER-CATHODE VOLTAGE:</b>			
Heater negative with respect to cathode . . . . .	135 max	135 max	volts
Heater positive with respect to cathode . . . . .	135 max	135 max	volts
BULB TEMPERATURE (At hottest point) . . . . .	220 max	220 max	°C

### Typical Operation as Amplifier up to 60 Mc:

DC Plate Voltage . . . . .	500	600	600	750	volts
DC Grid-No.2 Voltage <sup>♠</sup> . . . . .	170	150	180	160	volts
From series resistor of . . . . .	36000	51000	43000	56000	ohms
DC Grid-No.1 Voltage <sup>°</sup> . . . . .	-66	-58	-71	-62	volts
From grid-No.1 resistor of . . . . .	27000	20000	24000	20000	ohms
From cathode resistor of . . . . .	470	470	430	470	ohms
Peak RF Grid-No.1 Voltage . . . . .	84	73	91	79	volts
DC Plate Current . . . . .	135	112	150	120	ma
DC Grid-No.2 Current . . . . .	9	9	10	11	ma
DC Grid-No.1 Current (Approx.) . . . . .	2.5	2.8	2.8	3.1	ma
Driving Power (Approx.) . . . . .	0.2	0.2	0.3	0.2	watt
Power Output (Approx.) . . . . .	48	52	66	70	watts

## Typical Operation as Amplifier at 175 Mc:

DC Plate Voltage .....	320	400	volts
DC Grid-No.2 Voltage <sup>†</sup> .....	180	190	volts
From series resistor of .....	13000	20000	ohms
DC Grid-No.1 Voltage <sup>‡</sup> .....	-51	-54	volts
From grid-No.1 resistor of .....	27000	24000	ohms
From cathode resistor of .....	330	330	ohms
Peak RF Grid-No.1 Voltage .....	64	68	volts
DC Plate Current .....	140	150	ma
DC Grid-No.2 Current .....	10	10.4	ma
DC Grid-No.1 Current (Approx.) .....	2	2.2	ma
Driving Power (Approx.) .....	3	3	watts
Power Output (Approx.) .....	25	35	watts

## Maximum Circuit Values (CCS or ICAS conditions):

- Grid-No.1-Circuit Resistance .....
- † Obtained preferably from separate source, from plate-voltage supply with a voltage divider, or through series resistor of value shown. Grid-No.2 voltage must not exceed 400 volts under key-up conditions.
- ‡ Obtained from fixed supply, by grid-No.1 resistor, by cathode resistor, or by combination methods.
- § For operation at less than maximum rated conditions, this value may be as high as 100000 ohms.

30000 $\frac{1}{2}$  max ohms

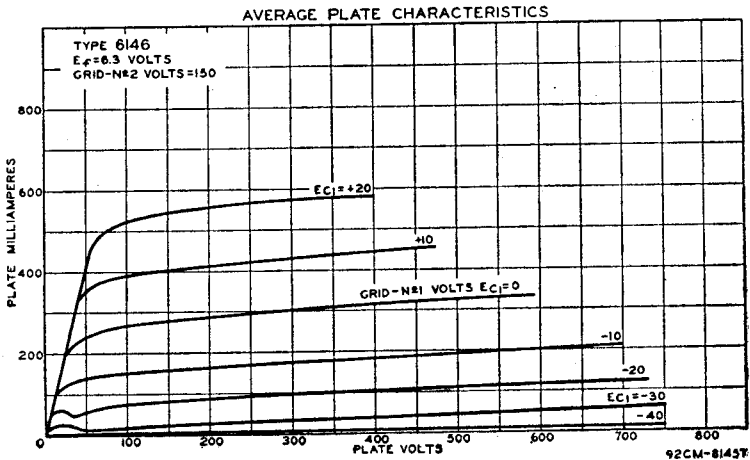
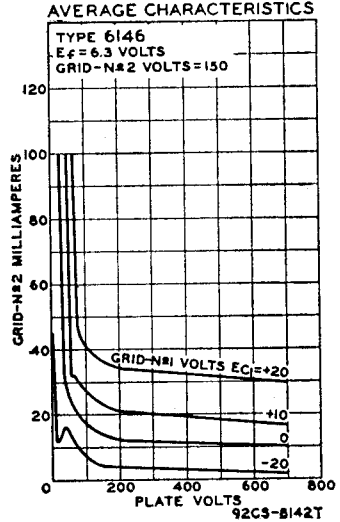
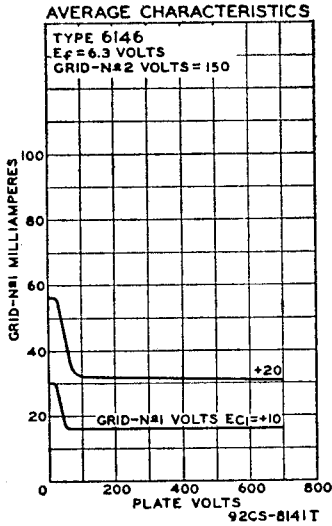

OPERATING CONSIDERATIONS

Type 6146 requires Octal socket and may be operated in any position. Simplified shielding and good performance are facilitated by the base sleeve with separate base-pin connection and the triple base-pin connection for cathode, grid No.3, and internal shield. OUTLINE 17, *Outlines* Section.

For operation at 120 Mc, plate voltage should be reduced to 67 per cent of maximum rating; plate input to 79 per cent. At 175 Mc, plate voltage should be reduced to 53 per cent of maximum rating; plate input to 66 per cent.

Plate shows no color when tube is operated at maximum CCS or ICAS ratings.

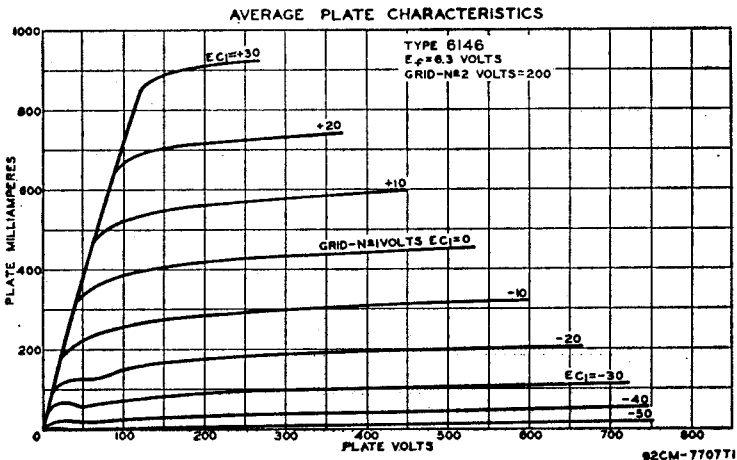
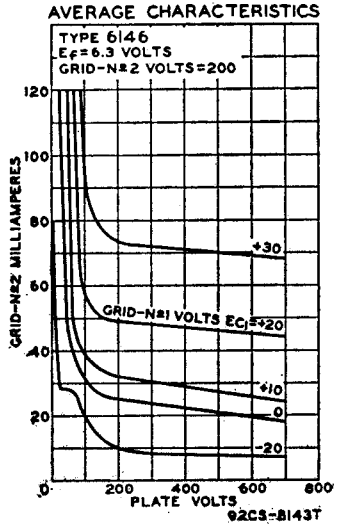
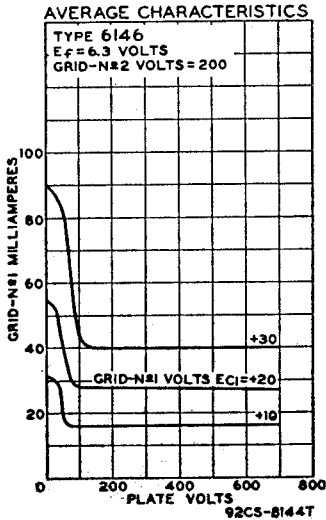

# 6155/ 4-125A

## BEAM POWER TUBE

Forced-air-cooled, thoriated-tungsten filament type used as af power amplifier and modulator, and as rf power amplifier and oscillator. May be used with full input to 120

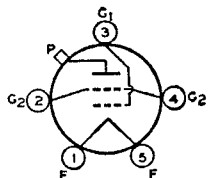

Mc, and with reduced input up to 250 Mc. Class C Telegraphy maximum CCS plate dissipation, 125 watts. Requires Giant five-contact socket and may be operated in vertical position only, base up or down. OUTLINE 30, *Outlines* Section.

FILAMENT VOLTAGE (AC/DC).....	5.0	volts
FILAMENT CURRENT.....	6.5	amperes
MU-FACTOR GRID No.2 TO GRID No.1*.....	6.2	
<b>DIRECT INTERELECTRODE CAPACITANCES:</b>		
Grid No.1 to plate.....	0.07 <i>max</i>	$\mu\mu\text{f}$
Grid No.1 to filament and grid No.2.....	11	$\mu\mu\text{f}$
Plate to filament and grid No.2.....	3	$\mu\mu\text{f}$
<b>SEAL TEMPERATURE:</b>		
Plate.....	220 <i>max</i>	°C
Grid No.2, grid No.1 and filament.....	180 <i>max</i>	°C

\* Plate volts, 3000; grid-No.2 volts, 400; plate milliamperes, 50.

### AF POWER AMPLIFIER AND MODULATOR

Maximum CCS Ratings:	Class AB <sub>1</sub>	Class AB <sub>2</sub>	
DC PLATE VOLTAGE.....	3000 <i>max</i>	3000 <i>max</i>	volts
DC GRID-NO.2 VOLTAGE.....	600 <i>max</i>	400 <i>max</i>	volts
DC GRID-NO.1 VOLTAGE.....	-500 <i>max</i>	-500 <i>max</i>	volts
MAXIMUM-SIGNAL DC PLATE CURRENT°.....	225 <i>max</i>	225 <i>max</i>	ma
MAXIMUM-SIGNAL PLATE INPUT°.....	350 <i>max</i>	500 <i>max</i>	watts
MAXIMUM-SIGNAL GRID-NO.2 INPUT°.....	20 <i>max</i>	20 <i>max</i>	watts
PLATE DISSIPATION°.....	125 <i>max</i>	125 <i>max</i>	watts

### RF POWER AMPLIFIER—Class B Telephony

Maximum CCS Ratings:			
DC PLATE VOLTAGE.....	3000 <i>max</i>	volts	
DC GRID-NO.2 VOLTAGE.....	400 <i>max</i>	volts	
DC PLATE CURRENT.....	135 <i>max</i>	ma	
PLATE INPUT.....	200 <i>max</i>	watts	
GRID-NO.2 INPUT.....	14 <i>max</i>	watts	
PLATE DISSIPATION.....	125 <i>max</i>	watts	

### PLATE-MODULATED RF POWER AMPLIFIER—Class C Telephony

Maximum CCS Ratings:			
DC PLATE VOLTAGE.....	2500 <i>max</i>	volts	
DC GRID-NO.2 VOLTAGE.....	400 <i>max</i>	volts	
DC GRID-NO.1 VOLTAGE.....	-500 <i>max</i>	volts	
DC PLATE CURRENT.....	200 <i>max</i>	ma	
DC GRID-NO.1 CURRENT.....	15 <i>max</i>	ma	
PLATE INPUT.....	415 <i>max</i>	watts	
GRID-NO.2 INPUT.....	20 <i>max</i>	watts	
PLATE DISSIPATION.....	83 <i>max</i>	watts	

### RF POWER AMPLIFIER AND OSCILLATOR—Class C Telegraphy and

### RF POWER AMPLIFIER—Class C FM Telephony

Maximum CCS Ratings:			
DC PLATE VOLTAGE.....	3000 <i>max</i>	volts	
DC GRID-NO.2 VOLTAGE.....	400 <i>max</i>	volts	
DC GRID-NO.1 VOLTAGE.....	-500 <i>max</i>	volts	
DC PLATE CURRENT.....	225 <i>max</i>	ma	
DC GRID-NO.1 CURRENT.....	15 <i>max</i>	ma	
PLATE INPUT.....	625 <i>max</i>	watts	
GRID-NO.2 INPUT.....	20 <i>max</i>	watts	
PLATE DISSIPATION.....	125 <i>max</i>	watts	

° Averaged over any audio-frequency of sine-wave form.

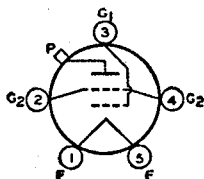

## BEAM POWER TUBE

Forced-air-cooled thoriated-tungsten-filament type used as a power amplifier and modulator, and as rf power amplifier and oscillator. May be used with full input up to 75

# 6156/ 4-250A

Mc and with reduced input up to 120 Mc. Class C Telegraphy maximum CCS plate dissipation, 250 watts. Requires Giant five-contact socket and may be operated in vertical position only, base up or down. OUTLINE 35, *Outlines* Section.

FILAMENT VOLTAGE (AC/DC).....	5.0	volts
FILAMENT CURRENT.....	14.1	amperes
MU-FACTOR, GRID No.2 To GRID No.1*.....	5.1	
DIRECT INTERELECTRODE CAPACITANCES:		
Grid No.1 to plate.....	0.14	max $\mu\text{f}$
Grid No.1 to filament and grid No.2.....	13	$\mu\text{f}$
Plate to filament and grid No.2.....	4.6	$\mu\text{f}$
SEAL TEMPERATURE:		
Plate.....	220	max °C
Grid No.2, grid No.1, and filament.....	180	max °C

\* Plate volts, 3000; grid No.2 volts, 500; plate milliamperes, 100.

### AF POWER AMPLIFIER AND MODULATOR

Maximum CCS Ratings:	Class AB <sub>1</sub>	Class AB <sub>2</sub>	
DC PLATE VOLTAGE.....	4000 max	4000 max	volts
DC GRID-NO.2 VOLTAGE.....	600 max	600 max	volts
DC GRID-NO.1 VOLTAGE.....	-500 max	-500 max	volts
MAXIMUM-SIGNAL DC PLATE CURRENT <sup>o</sup> .....	350 max	350 max	ma
MAXIMUM-SIGNAL PLATE INPUT <sup>o</sup> .....	750 max	1000 max	watts
MAXIMUM-SIGNAL GRID-NO.2 INPUT <sup>o</sup> .....	35 max	35 max	watts
PLATE DISSIPATION <sup>o</sup> .....	250 max	250 max	watts

### RF POWER AMPLIFIER—Class B Telephony

Maximum CCS Ratings:		
DC PLATE VOLTAGE.....	4000 max	volts
DC GRID-NO.2 VOLTAGE.....	600 max	volts
DC PLATE CURRENT.....	210 max	ma
PLATE INPUT.....	400 max	watts
GRID-NO.2 INPUT.....	23 max	watts
PLATE DISSIPATION.....	250 max	watts

### PLATE-MODULATED RF POWER AMPLIFIER—Class C Telephony

Maximum CCS Ratings:		
DC PLATE VOLTAGE.....	3200 max	volts
DC GRID-NO.2 VOLTAGE.....	600 max	volts
DC GRID-NO.1 VOLTAGE.....	-500 max	volts
DC PLATE CURRENT.....	275 max	ma
DC GRID-NO.1 CURRENT.....	20 max	ma
PLATE INPUT.....	825 max	watts
GRID-NO.2 INPUT.....	35 max	watts
PLATE DISSIPATION.....	165 max	watts

### RF POWER AMPLIFIER AND OSCILLATOR—Class C Telephony and RF POWER AMPLIFIER—Class C FM Telephony

Maximum CCS Ratings:		
DC PLATE VOLTAGE.....	4000 max	volts
DC GRID-NO.2 VOLTAGE.....	600 max	volts
DC GRID-NO.1 VOLTAGE.....	-500 max	volts
DC PLATE CURRENT.....	350 max	ma
DC GRID-NO.1 CURRENT.....	20 max	ma
PLATE INPUT.....	1250 max	watts
GRID-NO.2 INPUT.....	35 max	watts
PLATE DISSIPATION.....	250 max	watts

<sup>o</sup> Averaged over any audio-frequency cycle of sine-wave form.

**BEAM POWER TUBE**

**6159**

Small, sturdy, glass-octal heater-cathode type used as af power amplifier and modulator and as rf power amplifier and oscillator. May be used with full input up to 60 Mc and with

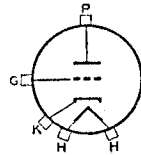

reduced input up to 175 Mc. Class C Telephony maximum plate dissipation, CCS 20 watts, ICAS 25 watts. OUTLINE 17, *Outlines* Section. Heater volts, 26.5; amperes, 0.3. Except for heater rating, this type is identical with type 6146.

**POWER TRIODE**

**6161**

Compact forced-air-cooled heater-cathode type having integral radiator used as rf power amplifier and oscillator and as frequency multiplier. Coaxial terminal arrangement facilitates

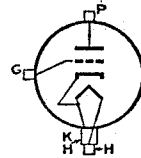

use in cathode-drive circuits of the coaxial-cylinder type. May be used with full input up to 900 Mc and with reduced input up to 2000 Mc. Class C Telephony maximum CCS plate dissipation, 250 watts.

**HEATER VOLTAGE (AC/DC):°**

Average .....	6.3	volts
Maximum .....	6.9	volts
HEATER CURRENT (At 6.3 volts) .....	3.4	amperes
AMPLIFICATION FACTOR* .....	25	

**DIRECT INTERELECTRODE CAPACITANCES:**

Grid to plate .....	6	$\mu\text{f}$
Grid to cathode and heater .....	11	$\mu\text{f}$
Plate to cathode and heater <sup>□</sup> .....	0.22	$\mu\text{f}$

° Because the cathode is subjected to considerable back bombardment as the frequency is increased with resultant increase in temperature, the heater voltage should be reduced depending on operating conditions and frequency to prevent overheating the cathode and resultant short life.

□ Average heater voltage must be applied for a minimum period of one minute before the application of plate voltage.

\* Grid volts, -15; plate milliamperes, 250.

□ With external flat shield having minimum diameter of 7 1/4 inches located in plane of grid terminal and perpendicular to axis of tube. Shield is connected to grid terminal.

**PLATE-MODULATED RF POWER AMPLIFIER—Class C Telephony**

**Maximum CCS Ratings:**

DC PLATE VOLTAGE .....	1300 <i>max</i>	volts
DC GRID VOLTAGE .....	-300 <i>max</i>	volts
DC PLATE CURRENT .....	210 <i>max</i>	ma
DC GRID CURRENT .....	See Rating Chart	
PLATE INPUT .....	270 <i>max</i>	watts
PLATE DISSIPATION .....	167 <i>max</i>	watts

**Typical Operation in Cathode-Drive Circuit:**

	600 Mc	900 Mc	
DC Plate-to-Grid Voltage .....	1400	1400	volts
DC Cathode-to-Grid Voltage .....	150	150	volts
Peak RF Cathode-to-Grid Voltage .....	200	200	volts
DC Plate Current .....	210	210	ma
DC Grid Current (Approx.) .....	70	70	ma
Driver Power Output (Approx.) <sup>■</sup> .....	70 <sup>Δ</sup>	75 <sup>†</sup>	watts
Output Circuit Efficiency (Approx.) .....	80	60	per cent
Useful Power Output (Approx.) .....	180	120	watts

■ In this type of service, the 6161 can be modulated 100 per cent if the rf driver stage is also modulated 100 per cent simultaneously. Care should be taken to insure that the driver-modulation and amplifier-modulation voltages are exactly in phase.

Δ This value includes 18 watts of circuit loss and 40 watts added to plate input.

† This value includes 23 watts of circuit loss and 40 watts added to plate input.

## Technical Data

### RF POWER AMPLIFIER AND OSCILLATOR—Class C Telegraphy and RF POWER AMPLIFIER—Class C FM Telephony

#### Maximum CCS Ratings:

DC PLATE VOLTAGE.....	1600 <i>max</i>	volts
DC GRID VOLTAGE.....	-300 <i>max</i>	volts
DC PLATE CURRENT.....	250 <i>max</i>	ma
DC GRID CURRENT.....	See Rating Chart	
PLATE INPUT.....	400 <i>max</i>	watts
PLATE DISSIPATION.....	250 <i>max</i>	watts

#### Typical Operation in Cathode-Drive Circuit:

	600 Mc	900 Mc	
DC Plate-to-Grid Voltage.....	1650	1650	volts
DC Cathode-to-Grid Voltage.....	150	150	volts
From grid resistor of.....	3000	15000	ohms
Peak RF Cathode-to-Grid Voltage.....	200	200	volts
DC Plate Current.....	250	250	ma
DC Grid Current (Approx.).....	50	10	ma
Driver Power Output (Approx.).....	75°	80°	watts
Output Circuit Efficiency (Approx.).....	82	60	per cent
Useful Power Output (Approx.).....	270	180	watts

° This value includes 18 watts of circuit loss and 45 watts added to plate input.

• This value includes 23 watts of circuit loss and 45 watts added to plate input.

### FREQUENCY MULTIPLIER—Class C

#### Maximum CCS Ratings:

DC PLATE VOLTAGE.....	1600 <i>max</i>	volts
DC GRID VOLTAGE.....	-300 <i>max</i>	volts
DC PLATE CURRENT.....	250 <i>max</i>	ma
DC GRID CURRENT.....	See Rating Chart	
PLATE INPUT.....	400 <i>max</i>	watts
PLATE DISSIPATION.....	250 <i>max</i>	watts

#### Typical Operation as Doubler in Cathode-Drive Circuit:

	600 Mc	900 Mc	
DC Plate-to-Grid Voltage.....	1760	1675	volts
DC Cathode-to-Grid Voltage.....	260	175	volts
From cathode resistor of.....	860	645	ohms
Peak RF Cathode-to-Grid Voltage.....	300	300	volts
DC Plate Current.....	250	250	ma
DC Grid Current (Approx.).....	50	21	ma
Driver Power Output (Approx.) ●.....	125	100	watts
Output Circuit Efficiency (Approx.).....	90	80	per cent
Useful Power Output (Approx.).....	180	140	watts

● Approximate total driving power required. A portion of this power appears in the plate circuit.

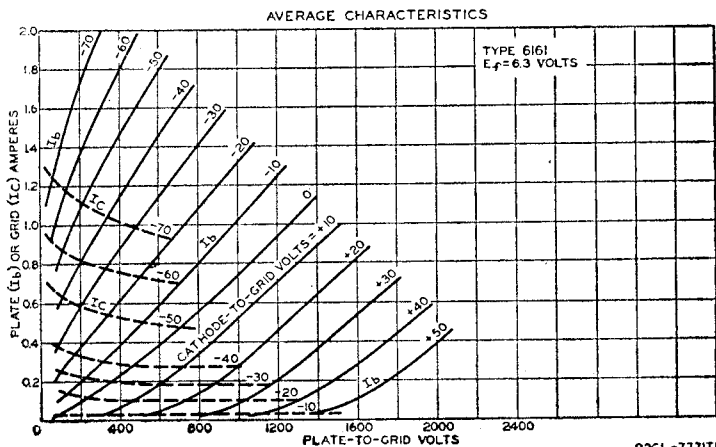

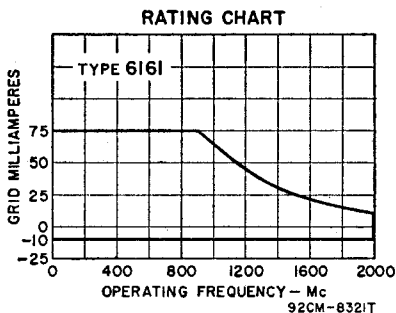

**OPERATING CONSIDERATIONS**

Type 6161 may be operated in any position. *OUTLINE 89, Outlines Section.*  
 For operation at 1200 Mc, plate voltage and plate input should be reduced to 80 per cent of maximum ratings; at 1400 Mc, to 71 per cent; at 1650 Mc, to 62.5 per cent; at 2000 Mc, to 62.5 per cent.

A minimum air flow of 16 cubic feet per minute should be directed by a blower through the radiator toward the bulb and the grid terminal when the 6161 is operated at maximum rated dissipation. Air flow should start before and continue during the application of any voltages to the 6161. Maximum temperatures; radiator (measured on core at end adjacent to plate ring), 180°C; grid terminal, 150°C; cathode terminal, 150°C; plate, grid, and cathode seals, 150°C.

The 6161 supersedes the 5588 for new equipment design.

**UHF DIODE**

**6173**

Small, sturdy, pencil type used in pulse-detection and pulse-power-measuring service at frequencies up to 3300 Mc. Type 6173 may be operated in any position. *OUTLINE 69, Outlines Section.*

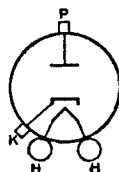

HEATER VOLTAGE (AC/DC).....	6.3	volts
HEATER CURRENT.....	0.135	ampere
RESONANT FREQUENCY (Approx.).....	1600	Mc
DIRECT INTERELECTRODE CAPACITANCE (Approx.):		
Plate to cathode.....	1.1	μf
TERMINAL TEMPERATURE (Plate and cathode).....	175 max	°C

**PULSE-DETECTION and PULSE-POWER-MEASURING SERVICE†**

<b>Maximum Ratings:</b>	<i>For altitudes up to 10,000 feet</i>
PEAK INVERSE PLATE VOLTAGE.....	1000 max volts
PEAK PULSE PLATE VOLTAGE.....	150 max volts
PEAK PULSE PLATE CURRENT.....	1 max ampere
DC PLATE CURRENT.....	1 max ma
PEAK HEATER-CATHODE VOLTAGE:	
Heater negative with respect to cathode.....	90 max volts
Heater positive with respect to cathode.....	90 max volts

**HALF-WAVE RECTIFIER**

<b>Maximum Ratings:</b>	<i>For altitudes up to 100,000 feet</i>
PEAK INVERSE PLATE VOLTAGE.....	375 max volts
PEAK PLATE CURRENT.....	50 max ma
HOT-SWITCHING TRANSIENT PLATE CURRENT:°	
For duration of 0.2 second maximum.....	250 max ma
DC OUTPUT CURRENT.....	5.5 max ma
PEAK HEATER-CATHODE VOLTAGE:	
Heater negative with respect to cathode.....	90 max volts
Heater positive with respect to cathode.....	90 max volts

† In this class of service, the heater should be allowed to warm up for a minimum of 60 seconds before plate voltage is applied in order to allow the cathode to reach normal operating temperature and to be able to supply the high peak plate currents encountered in this class of service.

° A minimum plate-load impedance (including the source impedance) of 300 ohms is required to limit the hot-switching transient plate current and thereby prevent damage to the tube when the plate voltage is applied.



OPERATING CONSIDERATIONS

Connections to the cathode terminal and the plate terminal should be made by flexible spring contacts only. The connectors must make firm, large-surface contact, yet must be sufficiently flexible so that no part of the tube is subjected to strain. Unless this recommendation is observed, the glass-to-metal seals may be damaged.

The heater leads should not be soldered to the circuit elements. The heat of the soldering operation may crack the glass seals of the heater leads and damage the tube.

The Pulse Rating Chart represents graphically the relationships between pulse duration, pulse-repetition rate, and peak-pulse plate current. This chart provides a wide choice of operating parameters within the tube's ratings. Dotted boundary line ABC is the locus of the maximum peak-pulse-plate-current values for various pulse durations. When two of the three parameters shown are known, the maximum allowable value of the third parameter can be selected from the chart. For example, if an application requires a 1-microsecond pulse and a pulse-repetition rate of 1000 pulses per second, the maximum allowable peak-pulse plate current is 1 ampere. Since the pulse-repetition rate of 1000 is a maximum value for a pulse duration of 1 microsecond, it follows that any pulse-repetition rate up to 1000 may be used under these conditions. If a longer pulse duration is required, e.g., 1.5 microseconds, and the same pulse-repetition rate of 1000 is required, the maximum allowable peak-pulse plate current is 0.67 ampere.

In applications where groups of pulses are employed, the total pulse duration of the individual pulses in any one group may be determined and treated as the pulse duration of the group as a single wide pulse.

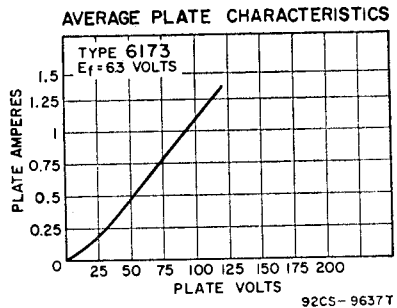
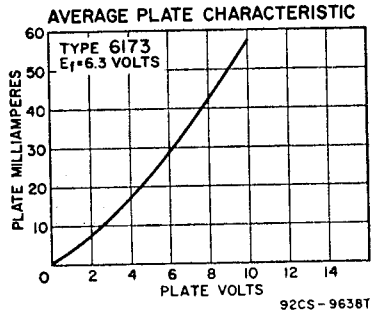
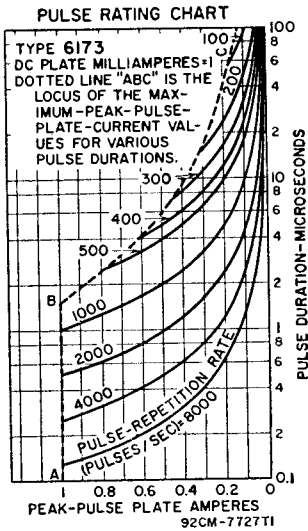

**BEAM POWER TUBE**

**6181**

Ceramic-metal, forced-air cooled, heater-cathode type used as an rf power amplifier and oscillator. May be used with full input up to 200 Mc. Class C Telegraphy maximum plate dissipation, CCS 2000 watts; must be operated in vertical position, either end up. OUTLINE 92, *Outlines* Section. Air flow must be adequate to limit the radiator-core and the terminal temperatures to their specified maximum values. Heater power, plate power, and air flow may be removed simultaneously.

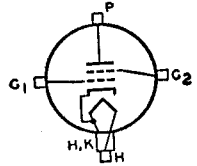

HEATER VOLTAGE† (AC/DC).....	120 max	volts
HEATER CURRENT (At 120 volts).....	1.6	amperes
MINIMUM HEATING TIME (At 117 volts).....	5	minutes
MU-FACTOR, Grid No.2 to Grid No.1 <sup>□</sup> .....	7	
DIRECT INTERELECTRODE CAPACITANCES:		
Grid No.1 to plate <sup>○</sup> .....	0.40 max	μf
Grid No.1 to cathode and heater.....	46	μf
Plate to cathode and heater <sup>■</sup> .....	0.10 max	μf
Grid No.1 to grid No.2.....	50	μf
Grid No.2 to plate.....	22	μf
Grid No.2 to cathode and heater <sup>■</sup> .....	4.4 max	μf
RADIATOR TEMPERATURE (Measured on core at end adjacent to plate-terminal flange).....	180 max	°C
SEAL AND TERMINAL TEMPERATURE:		
Cathode, heater, grid No.1, grid No.2, and plate.....	180 max	°C

† Because the cathode is subjected to considerable back bombardment as the frequency is increased, with resultant increase in temperature, the heater voltage should be reduced depending on operating conditions and frequency to prevent overheating the cathode and resultant short life.

○ With external flat metal shield having a diameter of 8 inches and center hole approximately 3-7/16 inches in diameter. Shield is located in plane of the grid-No.2 terminal, perpendicular to the tube axis, and is connected to grid-No.2 terminal.

■ Same as preceding, except that center hole has diameter of approximately 3 inches, and shield is connected to grid-No.1 terminal.

□ For plate volts, 1000; grid-No.2 volts, 400; plate amperes, 1.

**PLATE-MODULATED RF POWER AMPLIFIER—Class C Telephony**

Maximum CCS Ratings:

DC PLATE VOLTAGE.....	1600 max	volts
DC GRID-NO.2 VOLTAGE.....	400 max	volts
DC GRID-NO.1 VOLTAGE.....	-300 max	volts
DC PLATE CURRENT.....	1.05 max	amperes
DC GRID-NO.1 CURRENT.....	0.2 max	ampere
PLATE INPUT.....	1650 max	watts
GRID-NO.2 INPUT.....	25 max	watts
PLATE DISSIPATION.....	1300 max	watts

**RF POWER AMPLIFIER AND OSCILLATOR—Class C Telephony  
and  
RF POWER AMPLIFIER—Class C FM Telephony**

Maximum CCS Ratings:

DC PLATE VOLTAGE.....	2000 max	volts
DC GRID-NO.2 VOLTAGE.....	500 max	volts
DC GRID-NO.1 VOLTAGE.....	-300 max	volts
DC PLATE CURRENT.....	1.25 max	amperes
DC GRID-NO.1 CURRENT.....	0.2 max	ampere
PLATE INPUT.....	2500 max	watts
GRID-NO.2 INPUT.....	40 max	watts
PLATE DISSIPATION.....	2000 max	watts

**MEDIUM-MU TRIODE**

**6263**  
**6263A**

Pencil-type tubes having integral radiator; used as rf power amplifier and oscillator in mobile equipment and in aircraft transmitters at altitudes up to 60,000 feet without pressurized

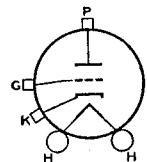

## Technical Data

chambers. The 6263A is used in applications requiring dependable performance under severe environmental conditions. The 6263A is unilaterally interchangeable with the 6263. Tubes may be used with full input up to 500 Mc and with reduced input up to 1700 Mc. Class C Telephony maximum plate dissipation, CCS 8 watts, ICAS 13 watts.

<b>HEATER VOLTAGE (AC/DC):</b>		
Under transmitting conditions.....	6.0	volts
Under stand-by conditions.....	6.3 <i>max</i>	volts
HEATER CURRENT at 6.0 volts.....	0.280	ampere
TRANSCONDUCTANCE*.....	7000	$\mu$ hos
AMPLIFICATION FACTOR.....	27	
<b>DIRECT INTERELECTRODES CAPACITANCES (Without external shield):</b>		
Grid to plate.....	1.7	$\mu$ f
Grid to cathode and heater.....	2.8	$\mu$ f
Plate to cathode and heater.....	0.08 <i>max</i>	$\mu$ f
INCOMING AIR TEMPERATURE.....	40 <i>max</i>	$^{\circ}$ C
PLATE-TERMINAL TEMPERATURE (Measured at plate terminal).....	175 <i>max</i>	$^{\circ}$ C

\* Plate volts, 200; plate milliamperes, 27.

### RF POWER AMPLIFIER AND OSCILLATOR—Class C Telephony

*For altitudes up to 60,000 feet*

<b>Maximum Ratings:</b>			
DC PLATE VOLTAGE.....	330 <i>max</i>	400 <i>max</i>	volts
DC GRID VOLTAGE.....	-100 <i>max</i>	-100 <i>max</i>	volts
DC PLATE CURRENT.....	40 <i>max</i>	55 <i>max</i>	ma
DC GRID CURRENT.....	25 <i>max</i>	25 <i>max</i>	ma
DC CATHODE CURRENT.....	55 <i>max</i>	70 <i>max</i>	ma
PLATE INPUT (6263A)*.....	13.2 <i>max</i>	22 <i>max</i>	watts
PLATE DISSIPATION.....	8 <i>max</i>	13 <i>max</i>	watts
<b>PEAK HEATER-CATHODE VOLTAGE:</b>			
Heater negative with respect to cathode.....	50 <i>max</i>	50 <i>max</i>	volts
Heater positive with respect to cathode.....	50 <i>max</i>	50 <i>max</i>	volts

\* CCS plate input 6263, 13 *max* watts.

#### Typical Operation as Oscillator in Cathode-Drive Circuit:

	<i>500 Mc</i>	<i>1700 Mc</i>	<i>500 Mc</i>	
	<i>CCS</i>	<i>CCS</i>	<i>ICAS</i>	
DC Plate-to-Grid Voltage.....	330	270	385	volts
DC Cathode-to-Grid Voltage <sup>■</sup> .....	30	20	35	volts
DC Plate Current.....	35	40	40	ma
DC Grid Current (Approx.).....	11	9	14	ma
Useful Power Output (Approx.) <sup>•</sup> .....	5	0.9	7	watts

#### Typical Operation as RF Power Amplifier in Cathode-Drive Circuit at 500 Mc:

	<i>CCS</i>	<i>ICAS</i>	
DC Plate-to-Grid Voltage.....	348	408	volts
DC Cathode-to-Grid Voltage <sup>■</sup> .....	48	58	volts
DC Plate Current.....	35	40	ma
DC Grid Current (Approx.).....	13	15	ma
Driver Power Output (Approx.).....	2.2	3	watts
Useful Power Output (Approx.).....	7 <sup>•</sup>	10 <sup>•</sup>	watts

#### Maximum Circuit Values:

Grid-Circuit Resistance.....	0.1 <i>max</i>	0.1 <i>max</i>	megohm
------------------------------	----------------	----------------	--------

### PLATE-MODULATED RF POWER AMPLIFIER—Class C Telephony

*For altitudes up to 60,000 feet*

<b>Maximum Ratings:</b>			
DC PLATE VOLTAGE.....	275 <i>max</i>	330 <i>max</i>	volts
DC GRID VOLTAGE.....	-100 <i>max</i>	-100 <i>max</i>	volts
DC PLATE CURRENT.....	33 <i>max</i>	46 <i>max</i>	ma
DC GRID CURRENT.....	25 <i>max</i>	25 <i>max</i>	ma
DC CATHODE CURRENT.....	50 <i>max</i>	60 <i>max</i>	ma
PLATE INPUT.....	9 <i>max</i>	15 <i>max</i>	watts
PLATE DISSIPATION.....	5.5 <i>max</i>	9 <i>max</i>	watts
<b>PEAK HEATER-CATHODE VOLTAGE:</b>			
Heater negative with respect to cathode.....	50 <i>max</i>	50 <i>max</i>	volts
Heater positive with respect to cathode.....	50 <i>max</i>	50 <i>max</i>	volts

**Typical Operation in Cathode-Drive Circuit at 500 Mc:**

	CCS	ICAS	
DC Plate-to-Grid Voltage.....	317	372	volts
DC Cathode-to-Grid Voltage.....	42	52	volts
DC Plate Current.....	35	35	ma
DC Grid Current (Approx.).....	13	12	ma
Driver Power Output (Approx.).....	2	2.4	watts
Useful Power Output (Approx.).....	6.7*	8*	watts

**Maximum Circuit Values:**

Grid-Circuit Resistance..... 0.1 max 0.1 max megohm

■ From a grid resistor, or from a suitable combination of grid resistor and fixed supply or grid resistor and cathode resistor.

• This value of useful power is measured at load of output circuit having an efficiency of about 75 per cent.

**OPERATING CONSIDERATIONS**

Types 6263 and 6263A may be operated in any position. *OUTLINE 72, Outlines Section.* Cooling must be sufficient to limit the plate-terminal temperature to 175°C. In most applications, natural air-cooling will be adequate. When natural air circulation is not adequate, a small blower should be used to direct sufficient air through the radiator fins.

To avoid possible tube damage, do not solder heater leads directly to circuit elements. The cathode should preferably be connected to one side of the heater. When the heater is not connected directly to the cathode, take care to keep the peak heater-cathode voltage within the maximum ratings.

AVERAGE CHARACTERISTICS

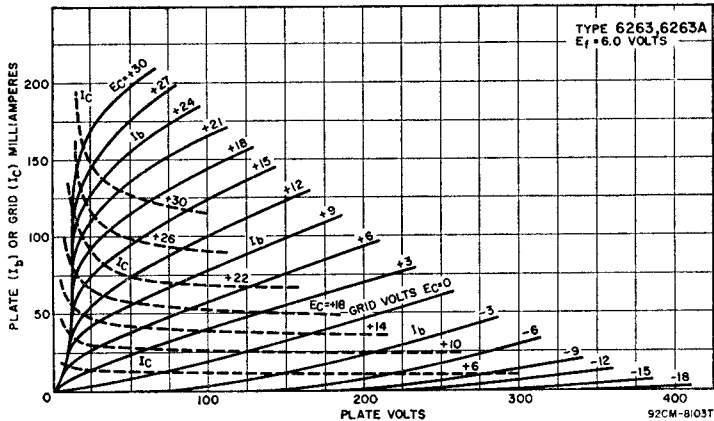

**6264**  
**6264A**

**MEDIUM-MU TRIODE**

Pencil-type tubes having integral radiator; used as rf power amplifier and oscillator and as frequency multiplier in mobile equipment and in aircraft transmitters at altitudes up to

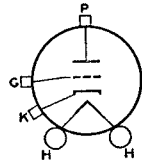

60,000 feet without pressurized chambers and under severe vibration conditions. May be used with full input up to 500 Mc and with reduced input up to 1700 Mc. Class C Telegraphy maximum plate dissipation, CCS 8 watts, ICAS 13 watts. The 6264A may be operated in any position. *OUTLINE 72, Outlines Section.* For other considerations refer to types 6263 and 6263A. The 6264 is a **DISCONTINUED** type listed for reference only. As a replacement, the 6264A is directly interchangeable.

## Technical Data

<b>HEATER VOLTAGE (AC/DC):</b>			
Under transmitting conditions	6	volts	
Under standby conditions	6.3 max	volts	
<b>HEATER CURRENT (At 6 volts)</b>	0.28	ampere	
<b>AMPLIFICATION FACTOR</b>	40		
<b>TRANSCONDUCTANCE*</b>	6800	μmhos	

	<i>Without</i>	<i>With</i>	
	<i>External</i>	<i>External</i>	
<b>DIRECT INTERELECTRODE CAPACITANCES:</b>	<i>Shield</i>	<i>Shield†</i>	
Grid to plate	1.75	1.5	μμf
Grid to cathode	2.95	—	μμf
Plate to cathode	0.07 max	—	μμf
<b>INCOMING-AIR TEMPERATURE</b>		40 max	°C
<b>PLATE-TERMINAL TEMPERATURE</b>		175 max	°C

† A flat plate shield, 1-1/4 inches in diameter, located parallel to the plane of the grid flange and midway between the grid flange and the radiator plate terminal. The shield is tied to the cathode.

\* For dc plate ma., 18.5; dc plate volts, 200.

### RF POWER AMPLIFIER AND OSCILLATOR—Class C Telegraphy

	<i>For altitudes up to 60,000 feet</i>		
	<i>CCS</i>	<i>ICAS</i>	
<b>Maximum Ratings:</b>			
DC PLATE VOLTAGE	330 max	400 max	volts
DC GRID VOLTAGE	-100 max	-100 max	volts
DC PLATE CURRENT	40 max	55 max	ma
DC GRID CURRENT	25 max	25 max	ma
DC CATHODE CURRENT	55 max	70 max	ma
PLATE INPUT	13.2 max	22 max	watts
PLATE DISSIPATION	8 max	13 max	watts
<b>PEAK HEATER-CATHODE VOLTAGE:</b>			
Heater negative with respect to cathode	50 max	50 max	volts
Heater positive with respect to cathode	50 max	50 max	volts

#### Typical Operation as Oscillator in Cathode-Drive Circuit:

	<i>At 500 Mc</i>		<i>At 1700 Mc</i>	
	<i>CCS</i>	<i>ICAS</i>	<i>CCS</i>	<i>ICAS</i>
DC Plate-to-Grid Voltage	325	380	263	volts
DC Cathode-to-Grid Voltage <sup>o</sup>	25	30	13	volts
DC Plate Current	35	35	40	ma
DC Grid Current (Approx.)	11	13	13	ma
Useful Power Output (Approx.) <sup>u</sup>	5	6	1	watts

#### Typical Operation as RF Power Amplifier in Cathode-Drive Circuit at 500 Mc:

	<i>CCS</i>	<i>ICAS</i>	
DC Plate-to-Grid Voltage	342	395	volts
DC Cathode-to-Grid Voltage <sup>o</sup>	42	45	volts
DC Plate Current	35	40	ma
DC Grid Current (Approx.)	13	15	ma
Driver Power Output (Approx.)	2.4	3	watts
Useful Power Output (Approx.) <sup>u</sup>	7.5	10	watts

#### Maximum Circuit Values:

Grid-Circuit Resistance	0.1 max	0.1 max	megohm
-------------------------	---------	---------	--------

### FREQUENCY MULTIPLIER

	<i>For altitudes up to 60,000 feet</i>		
	<i>CCS</i>	<i>ICAS</i>	
<b>Maximum Ratings:</b>			
DC PLATE VOLTAGE	300 max	350 max	volts
DC GRID VOLTAGE	-125 max	-140 max	volts
DC PLATE CURRENT	33 max	45 max	ma
DC GRID CURRENT	25 max	25 max	ma
DC CATHODE CURRENT	45 max	55 max	ma
PLATE INPUT	9.9 max	15.9 max	watts
PLATE DISSIPATION	6 max	9.5 max	watts
<b>PEAK HEATER-CATHODE VOLTAGE:</b>			
Heater negative with respect to cathode	50 max	50 max	volts
Heater positive with respect to cathode	50 max	50 max	volts

#### Typical Operation as Tripler to 510 Mc in Cathode-Drive Circuit:

	<i>CCS</i>	<i>ICAS</i>	
DC Plate-to-Grid Voltage	410	472	volts
DC Cathode-to-Grid Voltage <sup>o</sup>	110	122	volts
DC Plate Current	26	36.5	ma
DC Grid Current (Approx.)	4.1	5.8	ma
Driver Power Output (Approx.)	2.75	4.5	watts
Useful Power Output (Approx.) <sup>u</sup>	2.1	3.4	watts

## Maximum Circuit Values:

Grid-Circuit Resistance..... 0.1 max 0.1 max megohm  
 ° From a grid resistor, or from a suitable combination of grid resistor and fixed supply or grid resistor and cathode resistor.

\* This value of useful power is measured at load of output circuit having an efficiency of about 75 percent.

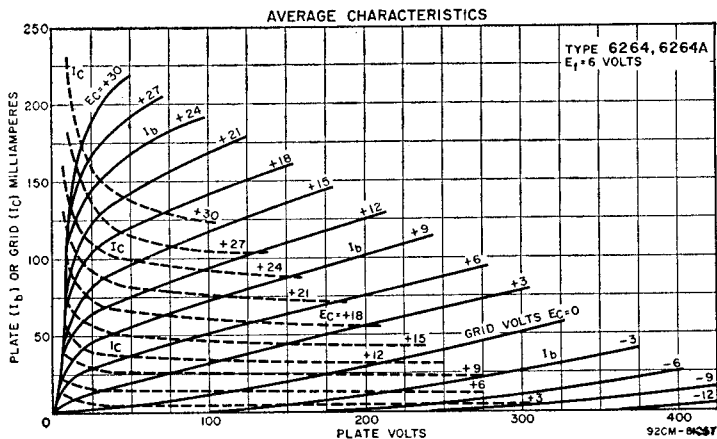

## BEAM POWER TUBE

# 6293

Heater-cathode type used as rectangular-wave pulse modulator. Rated for service with duty factors up to 0.1 at a maximum averaging time of 10,000 microseconds. Rectangular-Wave

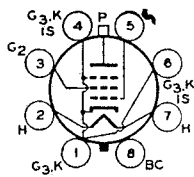

Modulator maximum plate dissipation, 10 watts. Requires Octal socket and may be operated in any position. OUTLINE 17, *Outlines* Section. Plate shows no color when tube is operated at maximum CCS ratings.

HEATER VOLTAGE (AC/DC).....	6.3	volts
HEATER CURRENT.....	1.25	amperes
TRANSCONDUCTANCE*.....	7000	μmhos
MU-FACTOR, Grid No.2 to Grid No.1*.....	4.5	

### DIRECT INTERELECTRODE CAPACITANCES:

Grid No.1 to plate.....	0.24 max	μμf
Grid No.1 to cathode, grid No.3, grid No.2, internal shield, base sleeve, and heater.....	13	μμf
Plate to cathode, grid No.3, grid No.2, internal shield, base sleeve, and heater.....	8.5	μμf

\* Plate and grid-No.2 volts, 200; plate milliamperes, 100.

### MODULATOR—Rectangular-Wave Modulation

#### Maximum and Minimum CCS Ratings:

For Duty Factor<sup>■</sup> up to 0.005

and Maximum Averaging Time of 10,000 Microseconds in Any Interval

DC PLATE-SUPPLY VOLTAGE <sup>▲</sup> .....	2000 max	3500 max	volts
INSTANTANEOUS PLATE VOLTAGE <sup>●</sup> .....	2300 max	4000 max	volts
DC GRID-NO.2 SUPPLY VOLTAGE <sup>▲</sup> .....	500 max	200 max	volts
DC GRID-NO.1 SUPPLY VOLTAGE <sup>▲</sup> .....	{ -300 max	{ -300 max	volts
	{ 250 min	{ -130 min	volts
GRID-NO.1 VOLTAGE:			
Instantaneous Negative Value.....	400 max	400 max	volts
Peak Positive Value.....	100 max	100 max	volts

PEAK PLATE CURRENT .....	3 <sup>Δ</sup> <i>max</i>	3 <sup>Δ</sup> <i>max</i>	amperes
PEAK GRID-NO.2 CURRENT .....	0.75 <i>max</i>	0.75 <i>max</i>	ampere
PEAK GRID-NO.1 CURRENT .....	0.5 <i>max</i>	0.5 <i>max</i>	ampere
PLATE INPUT .....	80 <i>max</i>	80 <i>max</i>	watts
GRID-NO.2 INPUT .....	1.75 <i>max</i>	1.75 <i>max</i>	watts
GRID-NO.1 INPUT .....	0.5 <i>max</i>	0.5 <i>max</i>	watt
PLATE DISSIPATION <sup>Δ</sup> .....	7 <i>max</i>	10 <i>max</i>	watts
<b>HEATER-CATHODE VOLTAGE:</b>			
Heater negative with respect to cathode .....	135 <i>max</i>	135 <i>max</i>	volts
Heater positive with respect to cathode .....	135 <i>max</i>	135 <i>max</i>	volts
BULB TEMPERATURE (At hottest point) .....	175 <i>max</i>	175 <i>max</i>	°C

<sup>Δ</sup> Duty factor is defined as the ON time in microseconds divided by 10,000 microseconds. ON time for this tube is defined as the sum of the durations of all the individual pulses which occur during any 10,000-microsecond interval. Pulse duration is defined as the time interval between the two points on the pulse at which the instantaneous value is 70 per cent of the peak value. The peak value is defined as the maximum value of a smooth curve through the average of the fluctuations over the top portion of the pulse.

<sup>Δ</sup> For tube protection, it is essential that sufficient resistance be used in the plate-supply circuit, the grid-No.-2 supply circuit, and the grid-No.1-supply circuit so that the short-circuit current is limited to 0.5 ampere in each circuit.

<sup>Δ</sup> This value is approximately 115 per cent of the maximum dc plate-supply voltage.

<sup>Δ</sup> For higher duty factors, the peak plate current must be reduced. The maximum rated current for a duty factor of 1.0 is 0.2 ampere.

<sup>Δ</sup> Averaged over any interval not exceeding 10,000 microseconds. Care should be used in determining the plate dissipation. A calculated value based on rectangular pulse can be considerably in error when the actual pulses have a finite rise and fall time. Plate dissipation should preferably be determined by measuring the bulb temperature under actual operating conditions; then, with the tube in the same socket and under the same ambient-temperature conditions, apply to the tube sufficient dc input to obtain the same bulb temperature. This value of dc input is a measure of the plate dissipation.

### POWER TRIODE

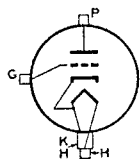

Compact liquid-and-forced-air-cooled type having heater cathode; used as af power amplifier and modulator, as rf power amplifier and oscillator, and as frequency multiplier at frequencies up to 2800 Mc. Coaxial terminal arrangement facilitates use in cathode-drive circuits of the coaxial-cylindrical type. Maximum over-all length, 4-9/32 inches; maximum diameter, 1.760 inches. Heater volts (ac/dc), 6.3; amperes, 3.4;

**6383**

amplification factor, 25. Direct interelectrode capacitances: grid to plate, 6 μf; grid to cathode and heater, 11 μf; plate to cathode and heater (with external flat shield in plane of grid terminal), 0.19 μf. Maximum CCS ratings as RF POWER AMPLIFIER AND OSCILLATOR: dc plate volts, 1500 *max*; dc grid volts, -300 *max*; dc plate ma., 400 *max*; dc grid ma. (up to 900 Mc), 75 *max*; plate input, 600 *max* watts; plate dissipation, 600 *max* watts. The 6383 is a DISCONTINUED type listed for reference only. As a replacement, the 6161 is a similar type, although not directly interchangeable.

### BEAM POWER TUBE

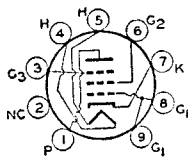

Nine-pin miniature heater-cathode type used as rf power amplifier and oscillator and as frequency multiplier. May be used with full input up to 50 Mc. Class C Telegraphy maxi-

**6417**

imum plate dissipation, CCS 12 watts, ICAS 13.5 watts. Requires Noval nine-contact socket and may be operated in any position. OUTLINE 9, *Outlines* Section. Heater volts (ac/dc), 12.6; amperes, 0.375. Except for heater ratings, the 6417 is identical with type 5763.

### TWIN BEAM POWER TUBE

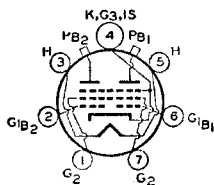

Small, sturdy, heater-cathode type used as af power amplifier and modulator, as push-pull rf power amplifier and oscillator, and as frequency tripler. May be used with full input up to 100

**6524**

Mc and with reduced input up to 470 Mc. Class C Telegraphy maximum plate dissipation (per tube), CCS 20 watts, ICAS 25 watts. Requires Septar seven-contact socket and may be operated in any position. **OUTLINE 14**, *Outlines* Section. Some forced-air cooling may be required to prevent exceeding the maximum bulb-temperature rating. Plates show no color when tube is operated at maximum CCS or ICAS ratings.

HEATER VOLTAGE (AC/DC).....	6.3	volts
HEATER CURRENT.....	1.25	amperes
TRANSCONDUCTANCE (Each unit)*.....	4500	$\mu$ mhos
MU-FACTOR, Grid No.2 to Grid No.1 (Each unit)*.....	8.5	
<b>DIRECT INTERELECTRODE CAPACITANCES (Each unit):</b>		
Grid No.1 to plate.....	0.11 max	$\mu$ f
Grid No.1 to cathode, grid No.3, internal shield, grid No.2 (pins 1 and 7), and heater.....	7	$\mu$ f
Plate to cathode, grid No.3, internal shield, grid No.2 (pins 1 and 7), and heater.....	3.4	$\mu$ f
BULB TEMPERATURE (At hottest point).....	210 max	$^{\circ}$ C

\* Plate and grid-No.2 volts, 200; plate milliamperes, 50.

### PLATE-MODULATED PUSH-PULL RF POWER AMPLIFIER—Class C Telephony

*Values are on a per-tube basis*

Maximum Ratings:	CCS	ICAS	
DC PLATE VOLTAGE.....	400 max	500 max	volts
DC GRID-NO.2 VOLTAGE.....	300 max	300 max	volts
DC GRID-NO.2 SUPPLY VOLTAGE.....	400 max	400 max	volts
DC GRID-NO.1 VOLTAGE.....	-200 max	-200 max	volts
DC PLATE CURRENT.....	125 max	125 max	ma
DC GRID-NO.1 CURRENT.....	4 max	4 max	ma
PLATE INPUT.....	45 max	55 max	watts
GRID-NO.2 INPUT.....	2 max	2 max	watts
PLATE DISSIPATION.....	13.5 max	16.7 max	watts
<b>PEAK HEATER-CATHODE VOLTAGE:</b>			
Heater negative with respect to cathode.....	135 max	135 max	volts
Heater positive with respect to cathode.....	135 max	135 max	volts

Maximum Circuit Values (CCS or ICAS conditions):

Grid-No.1-Circuit Resistance.....	30000 max	ohms
-----------------------------------	-----------	------

### PUSH-PULL RF POWER AMPLIFIER AND OSCILLATOR—Class C Telegraphy

and

### PUSH-PULL RF POWER AMPLIFIER—Class C FM Telephony

*Values are on a per-tube basis*

Maximum Ratings:	CCS	ICAS	
DC PLATE VOLTAGE.....	500 max	600 max	volts
DC GRID-NO.2 VOLTAGE.....	300 max	300 max	volts
DC GRID-NO.2 SUPPLY VOLTAGE.....	400 max	400 max	volts
DC GRID-NO.1 VOLTAGE.....	-200 max	-200 max	volts
DC PLATE CURRENT.....	150 max	150 max	ma
DC GRID-NO.1 CURRENT.....	4 max	4 max	ma
PLATE INPUT.....	70 max	85 max	watts
GRID-NO.2 INPUT.....	3 max	3 max	watts
PLATE DISSIPATION.....	20 max	25 max	watts
<b>PEAK HEATER-CATHODE VOLTAGE:</b>			
Heater negative with respect to cathode.....	135 max	135 max	volts
Heater positive with respect to cathode.....	135 max	135 max	volts

Maximum Circuit Values (CCS or ICAS conditions):

Grid-No.1-Circuit Resistance.....	30000 max	ohms
-----------------------------------	-----------	------

## FIXED-TUNED OSCILLATOR TRIODE

UHF pencil-type tubes having integral resonators; used in radiosonde service at a frequency of 1680 Mc. May be used at ambient temperatures ranging from  $-55^{\circ}$ C to  $+75^{\circ}$ C. Fixed-Tuned Oscillator maximum plate dissipation, 3.6 watts. The

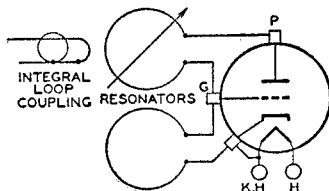

6562/  
5794A



6562 is a DISCONTINUED type listed for reference only. As a replacement, the 6562/5797A is directly interchangeable.

HEATER VOLTAGE RANGE <sup>o</sup> (AC/DC) . . . . .	5.2 to 6.6	volts
HEATER CURRENT (At 6.0 volts) . . . . .	0.160	ampere
FREQUENCY (Approx.) . . . . .	1680	Mc
FREQUENCY-ADJUSTMENT RANGE <sup>m</sup> . . . . .	±12	Mc

<sup>o</sup> This range of heater voltage is for radiosonde applications in which the heater is supplied from batteries and in which the equipment design requirements of minimum size, light weight, and high efficiency are the primary considerations even though the average life expectancy of the 6562/5794A in such service is only a few hours.

<sup>m</sup> As supplied, tubes are adjusted to 1680 ± 4 megacycles.

### FIXED-TUNED OSCILLATOR

#### Maximum Ratings:

DC PLATE VOLTAGE . . . . .	120 max	volts
DC PLATE CURRENT . . . . .	32 max	ma
DC GRID CURRENT . . . . .	8 max	ma
PLATE INPUT . . . . .	4 max	watts
PLATE DISSIPATION . . . . .	3.6 max	watts
PEAK HEATER-CATHODE VOLTAGE . . . . .	0 max	volts
AMBIENT-TEMPERATURE RANGE . . . . .	-55 to +75	°C

#### Operating Frequency Drift:

##### Maximum Frequency Drift:

For heater-voltage range of 5.2 to 6.6 volts, plate-voltage range of 95 to 117 volts, and ambient-temperature range of +22° to -40°C. . . . . +4 to -1 Mc

### OPERATING CONSIDERATIONS

Type 6562/5794A may be operated in any position. *OUTLINE 74, Outlines Section.*

The flexible heater leads of the 6562/5794A are usually soldered to the circuit elements. Soldering of these connections should not be made closer than 3/4" from the end of the tube (excluding cathode tab). If this precaution is not followed, the heat of the soldering operation may crack the glass seals of the leads and damage the tube. Under no circumstances should any of the electrodes be soldered to the circuit elements. Connections to the electrodes should be made by spring contact only.

The 6562/5794A should be supported by a suitable clamp around the metal shell either above or below the frequency-adjustment screw. It is essential, however, that the pressure exerted on the shell by the clamp be held to a minimum because excessive pressure can distort the resonators and result in a change of frequency.

The plate connection should have a flexible lead which will accommodate variations in the relative position of the plate terminal in individual tubes.

The 6562/5794A may be mechanically tuned by adjustment of the frequency-adjustment screw located on the metal shell of the tube. A clockwise rotation of the frequency-adjustment screw will decrease the frequency, while a counterclockwise rotation will increase the frequency. The range of adjustment provided by the screw is ± 12 megacycles.

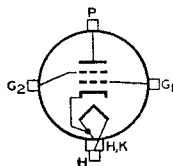

### BEAM POWER TUBE

Small, sturdy, uhf, forced-air-cooled, heater-cathode, cermolox type; used as af power amplifier and modulator, and as rf power amplifier and oscillator in compact mobile and fixed

# 6816

equipment. Useful at frequencies up to 2000 Mc and beyond. Class C Telegraphy maximum plate dissipation, CCS 115 watts.

HEATER VOLTAGE <sup>‡</sup> (AC/DC) . . . . .	6.3	volts
HEATER CURRENT . . . . .	2.1	amperes

## RCA Transmitting Tubes

MINIMUM HEATING TIME.....	60	seconds
MU-FACTOR, Grid No.2 to Grid No.1★.....	18	
DIRECT INTERELECTRODE CAPACITANCES:°		
Grid No.1 to plate.....	0.065 <i>max</i>	μμf
Grid No.1 to cathode and heater.....	14	μμf
Plate to cathode and heater.....	0.015 <i>max</i>	μμf
Grid No.1 to grid No.2.....	17	μμf
Grid No.2 to plate.....	4.4	μμf
Grid No.2 to cathode and heater.....	0.4 <i>max</i>	μμf
TERMINAL TEMPERATURE (Plate, Grid No.2, Grid No.1, Cathode, and Heater)	250 <i>max</i>	°C

† Because the cathode is subjected to considerable back bombardment as the frequency is increased with resultant increase in temperature, the heater voltage should be reduced depending on operating conditions and frequency to prevent overheating the cathode and resultant short life.

★ For plate and grid-No.2 volts, 250; plate ma., 100.

° Measured with special adapter.

### AF POWER AMPLIFIER AND MODULATOR—Class AB<sub>1</sub>

#### Maximum CCS Ratings:

DC PLATE VOLTAGE.....	1000 <i>max</i>	volts
DC GRID-NO.2 VOLTAGE.....	300 <i>max</i>	volts
MAXIMUM-SIGNAL DC PLATE CURRENT <sup>†</sup> .....	180 <i>max</i>	ma
MAXIMUM-SIGNAL PLATE INPUT <sup>†</sup> .....	180 <i>max</i>	watts
MAXIMUM-SIGNAL GRID-NO.2 INPUT <sup>†</sup> .....	4.5 <i>max</i>	watts
PLATE DISSIPATION <sup>†</sup> .....	115 <i>max</i>	watts

#### Typical CCS Operation:

	<i>Values are for 2 tubes</i>		
DC Plate Voltage.....	650	850	volts
DC Grid-No.2 Voltage**.....	300	300	volts
DC Grid-No.1 Voltage, From fixed-bias source.....	-15	-15	volts
Peak AF Grid-No.1-to-Grid-No.1 Voltage <sup>°°</sup> .....	30	30	volts
Zero-Signal DC Plate Current.....	80	80	ma
Maximum-Signal DC Plate Current.....	200	200	ma
Zero-Signal DC Grid-No.2 Current.....	0	0	ma
Maximum-Signal DC Grid-No.2 Current.....	20	20	ma
Effective Load Resistance (Plate to plate).....	4330	7000	ohms
Maximum-Signal Driving Power (Approx.).....	0	0	watts
Maximum-Signal Power Output (Approx.).....	50	80	watts

#### Maximum Circuit Values:

Grid-No.1-Circuit Resistance under Any Condition:●●

With fixed bias.....	30000 <i>max</i>	ohms
With cathode bias.....	Not recommended	

°° The driver stage should be capable of supplying the No.1 grids of the Class AB<sub>1</sub> stage with the specified driving voltage at low distortion.

●● The resistance introduced into the grid-No.1 circuit by the input coupling should be held to a low value. In no case should it exceed the specified maximum value. Transformer- or impedance-coupling devices are recommended.

### AF POWER AMPLIFIER AND MODULATOR—Class AB<sub>2</sub>

#### Maximum CCS Ratings:

DC PLATE VOLTAGE.....	1000 <i>max</i>	volts
DC GRID-NO.2 VOLTAGE.....	300 <i>max</i>	volts
MAXIMUM-SIGNAL DC PLATE CURRENT <sup>†</sup> .....	180 <i>max</i>	ma
MAXIMUM-SIGNAL DC GRID-NO.1 CURRENT <sup>†</sup> .....	30 <i>max</i>	ma
MAXIMUM-SIGNAL PLATE INPUT <sup>†</sup> .....	180 <i>max</i>	watts
MAXIMUM-SIGNAL GRID-NO.2 INPUT <sup>†</sup> .....	4.5 <i>max</i>	watts
PLATE DISSIPATION <sup>†</sup> .....	115 <i>max</i>	watts

#### Typical CCS Operation:

	<i>Values are for 2 tubes</i>		
DC Plate Voltage.....	650	850	volts
DC Grid-No.2 Voltage**.....	300	300	volts
DC Grid-No.1 Voltage, From fixed-bias source.....	-15	-15	volts
Peak AF Grid-No.1-to-Grid-No.1 Voltage.....	46	46	volts
Zero-Signal DC Plate Current.....	80	80	ma
Maximum-Signal DC Plate Current.....	355	355	ma
Zero-Signal DC Grid-No.2 Current.....	0	0	ma
Maximum-Signal DC Grid-No.2 Current.....	25	25	ma
Maximum-Signal DC Grid-No.1 Current.....	15	15	ma
Effective Load Resistance (Plate to plate).....	2450	3960	ohms
Maximum-Signal Driving Power (Approx.)●.....	0.3	0.3	watt
Maximum-Signal Power Output (Approx.).....	85	140	watts

## Technical Data

### PLATE-MODULATED RF POWER AMPLIFIER—Class C Telephony

#### Maximum CCS Ratings:

DC PLATE VOLTAGE.....	800 max	volts
DC GRID-NO.2 VOLTAGE.....	300 max	volts
DC GRID-NO.1 VOLTAGE.....	-100 max	volts
DC PLATE CURRENT.....	150 max	ma
DC GRID-NO.1 CURRENT.....	30 max	ma
PLATE INPUT.....	120 max	watts
GRID-NO.2 INPUT.....	3 max	watts
PLATE DISSIPATION.....	75 max	watts

#### Typical CCS Operation:

	<i>At 400 Mc</i>		
DC Plate Voltage.....	400	700	volts
DC Grid-No.2 Voltage <sup>□</sup> .....	200	250	volts
DC Grid-No.1 Voltage <sup>▲</sup> .....	-20	-50	volts
DC Plate Current.....	100	130	ma
DC Grid-No.2 Current.....	5	10	ma
DC Grid-No.1 Current.....	5	10	ma
Driver Power Output (Approx.) <sup>*</sup> .....	2	3	watts
Useful Power Output (Approx.).....	16	45	watts

#### Maximum Circuit Values:

Grid-No.1-Circuit Resistance under any condition.....	30000#max	ohms
---	-----------	------

### RF POWER AMPLIFIER AND OSCILLATOR—Class C Telegraphy and RF POWER AMPLIFIER—Class C FM Telephony

#### Maximum CCS Ratings:

DC PLATE VOLTAGE.....	1000 max	volts
DC GRID-NO.2 VOLTAGE.....	300 max	volts
DC GRID-NO.1 VOLTAGE.....	-100 max	volts
DC PLATE CURRENT.....	180 max	ma
DC GRID-NO.1 CURRENT.....	30 max	ma
PLATE INPUT.....	180 max	watts
GRID-NO.2 INPUT.....	4.5 max	watts
PLATE DISSIPATION.....	115 max	watts

#### Typical CCS Operation:

	<i>At 400 Mc</i>		<i>At 1200 Mc</i>		
DC Plate Voltage.....	400	900	900		volts
DC Grid-No.2 Voltage <sup>□</sup> .....	200	300	300		volts
DC Grid-No.1 Voltage <sup>†</sup> .....	-35	-30	-22		volts
DC Plate Current.....	150	170	170		ma
DC Grid-No.2 Current.....	5	1	1		ma
DC Grid-No.1 Current.....	3	10	4		ma
Driver Power Output (Approx.) <sup>*</sup> .....	3	3	5		watts
Useful Power Output (Approx.).....	23	80	40		watts

#### Maximum Circuit Values:

Grid-No.1-Circuit Resistance under any condition.....	30000#max	ohms
---	-----------	------

■ Averaged over any audio-frequency cycle of sine-wave form.

● Driver stage should be capable of supplying the specified driving power at low distortion to the No.1 grids of the AB<sub>2</sub> stage. To minimize distortion, the effective resistance per grid-No.1 circuit of the AB<sub>2</sub> stage should be held at a low value. For this purpose, the use of transformer coupling is recommended.

□ Obtained preferably from a separate source modulated along with the plate supply.

▲ Obtained from grid-No.1 resistor or from a combination of grid-No.1 resistor with either fixed supply or cathode resistor.

\* The driver stage is required to supply tube losses and rf-circuit losses. It should be designed to provide an excess of power above the indicated values to take care of variations in line voltage, in components, in initial tube characteristics, and in tube characteristics during life.

† If this value is insufficient to provide adequate bias, the additional required bias must be supplied by a cathode resistor or fixed supply.

\*\* Preferably obtained from a fixed supply.

□ Obtained preferably from a fixed supply, or from the plate-supply voltage with a voltage divider.

† Obtained from fixed supply, by grid-No.1 resistor, by cathode resistor, or by combination methods.

### OPERATING CONSIDERATIONS

Type 6816 may be operated in any position. OUTLINE 78, *Outlines* Section. Adequate forced-air cooling must be provided to limit the terminal temperatures to their specified value. Typical cooling requirements are shown in the accompanying graph; reduced air flow requirements may be achieved by placing a suitable cowling around the radiator to direct the air flow through radiator. Air flow should be established before and during the application of plate, grid-No.2, and grid-No.1 voltages. Plate power, grid-No.2 power, and air flow may be removed simultaneously. Cooling air is not normally required when only heater voltage is applied to the tube.

### TYPICAL PLATE CHARACTERISTICS

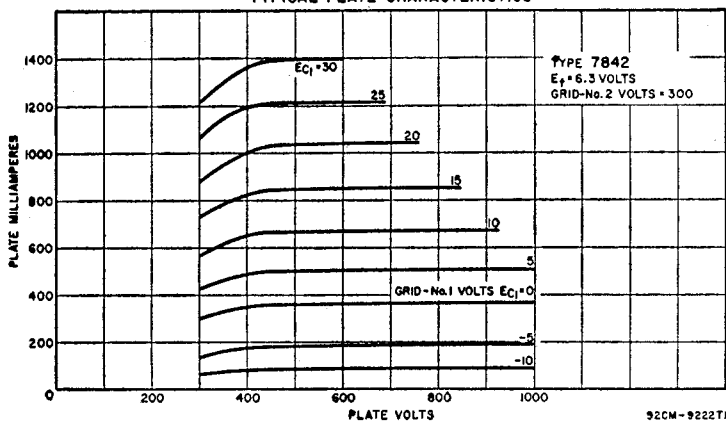

### TYPICAL CHARACTERISTICS

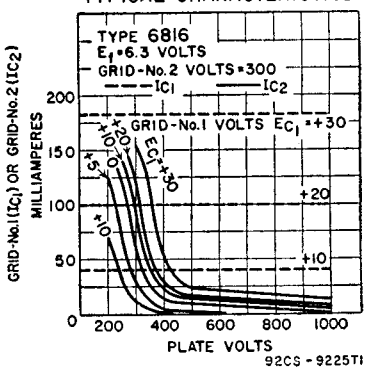

### TYPICAL COOLING REQUIREMENTS

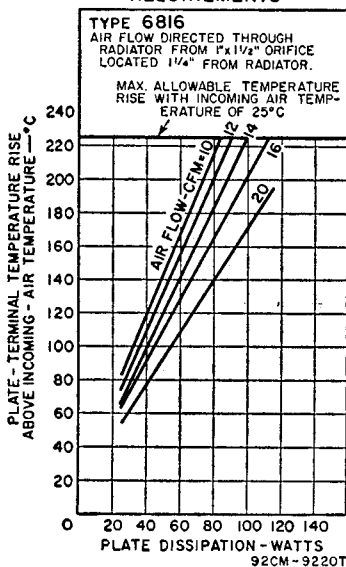

## TWIN BEAM POWER TUBE

# 6850

Small, sturdy, heater-cathode type used as af power amplifier and modulator, as push-pull rf power amplifier and oscillator, and as frequency tripler. May be used with full input up

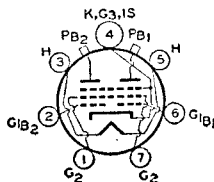

to 100 Mc and with reduced input up to 470 Mc. Class C Telegraphy maximum plate dissipation (per tube), CCS 20 watts, ICAS 25 watts. Requires Septar seven-contact socket and may be operated in any position. OUTLINE 14, *Outlines* Section. Heater volts (ac/dc), 12.6; amperes, 0.625. Except for heater rating, the 6850 is identical with type 6524.

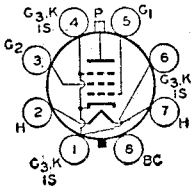

**BEAM POWER TUBE**

Small, sturdy, heater-cathode type used as af power amplifier and modulator and as rf power amplifier and oscillator. May be used with full input up to 60 Mc and with reduced input

6883

up to 175 Mc. Class C Telegraphy maximum plate dissipation, CCS 20 watts, ICAS 25 watts. Requires Octal socket and may be operated in any position. OUTLINE 18, *Outlines* Section. Heater volts (ac/dc), 12.6; amperes, 0.625. Except for heater rating and base, the 6883 is identical with type 6146.

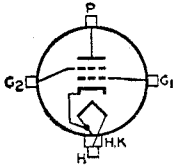

**BEAM POWER TUBE**

Small, sturdy, uhf, forced-air cooled, heater-cathode, cermet type used as af power amplifier and modulator, and rf power amplifier and oscillator in compact and mobile and fixed

6884

equipment. Useful at frequencies up to 2000 Mc and beyond. Class C Telegraphy maximum plate dissipation, CCS 115 watts. May be operated in any position. OUTLINE 78, *Outlines* Section. Heater volts (ac/dc), 26.5; amperes, 0.52. Except for heater rating, the 6884 is identical with type 6816.

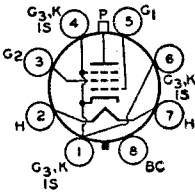

**BEAM POWER TUBE**

Small, sturdy, heater-cathode type used as rf power amplifier and modulator and as rf power amplifier and oscillator. May be used with full input up to 125 Mc and with reduced

6893

input up to 175 Mc. Class C Telegraphy maximum plate dissipation, CCS 10 watts, ICAS 13.5 watts. Requires Octal socket and may be operated in any position. OUTLINE 15, *Outlines* Section. Heater volts (ac/dc), 12.6; amperes, 0.4. Except for heater rating, the 6893 is identical to the 2E26.

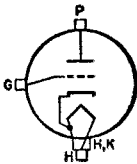

**UHF POWER TRIODE**

Forced-air-cooled type used as rf power amplifier and oscillator. May be used at full input up to 2500 Mc in cathode-drive circuits of the coaxial-cylinder type. Class C Telegraphy maximum

6897

CCS plate dissipation, 100 watts. May be operated in any position. OUTLINE 86, *Outlines* Section. Adequate air must be provided to prevent the temperature of the seals and the radiator from exceeding 250°C.

HEATER VOLTAGE (AC, DC)° .....	6.3	volts
HEATER CURRENT .....	1.05	amperes
TRANSCONDUCTANCE* .....	24800	μmhos
AMPLIFICATION FACTOR .....	95	
<b>DIRECT INTERELECTRODE CAPACITANCES:</b>		
Grid to plate .....	2.0	μμf
Grid to cathode .....	6.5	μμf
Plate to cathode .....	0.024	μμf

° Because the cathode is subjected to considerable back bombardment as the frequency is increased with resultant increase in temperature, the heater voltage should be reduced depending on operating conditions and frequency to prevent overheating of the cathode and resultant short life.

\* Plate volts, 600; plate milliamperes, 75.

# RCA Transmitting Tubes

## PLATE-MODULATED RF POWER AMPLIFIER—Class C Telephony

### Maximum CCS Ratings:

DC PLATE VOLTAGE.....	600 <sup>o</sup> max	volts
GRID VOLTAGE:		
DC.....	-150 max	volts
Peak Negative RF.....	400 max	volts
Peak Positive RF.....	30 max	volts
DC GRID CURRENT.....	50 max	ma
DC CATHODE CURRENT.....	100 max	ma
GRID INPUT.....	2 max	watts
PLATE DISSIPATION.....	70 max	watts

<sup>o</sup> For a modulation factor less than 1.0, it is permissible to use a higher dc plate voltage provided the sum of the peak positive modulation voltage and the dc plate voltage does not exceed 1200 volts.

## RF POWER AMPLIFIER AND OSCILLATOR—Class C Telephony

### Maximum CCS Ratings:

DC PLATE VOLTAGE.....	1000 max	volts
GRID VOLTAGE:		
DC.....	-150 max	volts
Peak Negative RF.....	400 max	volts
Peak Positive RF.....	30 max	volts
DC GRID CURRENT.....	50 max	ma
DC CATHODE CURRENT.....	125 max	ma
GRID INPUT.....	2 max	watts
PLATE DISSIPATION.....	100 max	watts

## TWIN POWER PENTODE

# 6939

Miniature, heater-cathode type used as push-pull, rf-power-amplifier and oscillator; as plate-modulated, push-pull rf amplifier; and as frequency-multiplier in communications

equipment operating at frequencies up to 500 Mc. Tube is internally neutralized for push-pull amplifier service. At 500 Mc, tube delivers useful power output of 5 watts in CCS or 6 watts in ICAS.

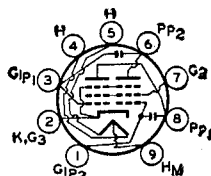

HEATER ARRANGEMENT:	Series	Parallel	
HEATER VOLTAGE (AC/DC).....	12.6	6.3	volts
HEATER CURRENT.....	0.3	0.6	ampere
TRANSCONDUCTANCE (Each unit) <sup>o</sup> .....		10500	μhos
MU FACTOR, Grid No.2 to Grid No.1 (Each unit) <sup>o</sup> .....		31	
DIRECT INTERELECTRODE CAPACITANCES (Approx., Each unit): <sup>o</sup>			
Grid No.1 to plate.....		0.15	μμf
Grid No.1 to cathode, heater, grid No.3, and grid No.2.....		6.4	μμf
Plate to cathode, heater, grid No.3, and grid No.2.....		1.6	μμf

<sup>o</sup> Plate and grid-No.2 volts, 150; plate ma., 25.

<sup>o</sup> Without external shield.

## PUSH-PULL RF POWER AMPLIFIER AND OSCILLATOR—Class C Telephony and

### PUSH-PULL RF POWER AMPLIFIER—Class C FM Telephony

*Values are on a per-tube basis unless specified otherwise*

*For operation at frequencies up to 500 Mc*

Maximum Ratings:	CCS	ICAS	
DC PLATE VOLTAGE.....	250 max	250 max	volts
DC GRID-NO.2 VOLTAGE.....	200 max	200 max	volts
DC GRID-NO.1 VOLTAGE.....	-100 max	-100 max	volts
DC PLATE CURRENT.....	90 max	100 max	ma
DC GRID-NO.1 CURRENT.....	6 max	8 max	ma
DC CATHODE CURRENT.....	100 max	120 max	ma
PLATE INPUT.....	13 max	14 max	watts
GRID-NO.2 INPUT.....	3 max	3.5 max	watts
GRID-NO.1 INPUT.....	0.2 max	0.24 max	watt
PLATE DISSIPATION.....	6 max	7.5 max	watts
PEAK HEATER-CATHODE VOLTAGE:			
Heater negative with respect to cathode.....	100 max	100 max	volts
Heater positive with respect to cathode.....	100 max	100 max	volts
BULB TEMPERATURE (At hottest point).....	225 max	225 max	°C

### Typical Operation at 500 Mc:

	CCS	ICAS	
DC Plate Voltage.....	180	200	volts
DC Grid-No.2 Voltage.....	180	200	volts

## Technical Data

DC Grid-No.1 Voltage.....	-20	-20	volts
From grid resistor for each grid of.....	27000	27000	ohms
Peak-to-Peak RF Grid-No.1 Voltage.....	50	50	volts
DC Plate Current.....	55	60	ma
DC Grid-No.2 Current.....	12.5	14	ma
DC Grid-No.1 Current.....	1.5	1.5	ma
Driver Power Output (Approx.).....	1.2	1.2	watts
Useful Power Output (Approx.) <sup>•</sup> .....	5	6	watts

### PLATE-MODULATED PUSH-PULL RF POWER AMPLIFIER—Class C Telephony

*Values are on a per-tube basis*

Maximum Ratings:	<i>For operation at frequencies up to 500 Mc</i>		
	CCS	ICAS	
DC PLATE VOLTAGE.....	200 max	200 max	volts
DC GRID-No.2 VOLTAGE.....	200 max	200 max	volts
DC GRID-No.1 VOLTAGE.....	-100 max	-100 max	volts
DC PLATE CURRENT.....	64 max	80 max	ma
DC GRID-No.1 CURRENT.....	6 max	8 max	ma
DC CATHODE CURRENT.....	80 max	96 max	ma
PLATE INPUT.....	8 max	10 max	watts
GRID-No.2 INPUT.....	2 max	2.3 max	watts
GRID-No.1 INPUT.....	0.2 max	0.24 max	watt
PLATE DISSIPATION.....	4 max	5 max	watts
PEAK HEATER-CATHODE VOLTAGE:			
Heater negative with respect to cathode.....	100 max	100 max	volts
Heater positive with respect to cathode.....	100 max	100 max	volts
BULB TEMPERATURE (At hottest point).....	225 max	225 max	°C

Typical Operation at 500 Mc:	<i>For operation at frequencies up to 500 Mc</i>		
	CCS	ICAS	
DC Plate Voltage.....	180	180	volts
DC Grid-No.2 Voltage.....	180	180	volts
DC Grid-No.1 Voltage.....	-20	-20	volts
From grid resistor for each grid of.....	68000	27000	ohms
Peak-to-Peak RF Grid-No.1 Voltage.....	45	50	volts
DC Plate Current.....	40	55	ma
DC Grid-No.2 Current.....	9.5	12.5	ma
DC Grid-No.1 Current.....	0.6	1.5	ma
Driver Power Output (Approx.).....	1	1.2	watts
Useful Power Output (Approx.) <sup>•</sup> .....	3.5	5	watts

### FREQUENCY TRIPLER—Class C

*Values are on a per-tube basis*

Maximum Ratings:	<i>For operation at frequencies up to 500 Mc</i>		
	CCS	ICAS	
DC PLATE VOLTAGE.....	250 max	250 max	volts
DC GRID-No.2 VOLTAGE.....	200 max	200 max	volts
DC GRID-No.1 VOLTAGE.....	-100 max	-100 max	volts
DC PLATE CURRENT.....	60 max	80 max	ma
DC GRID-No.1 CURRENT.....	6 max	8 max	ma
DC CATHODE CURRENT.....	70 max	80 max	ma
PLATE INPUT.....	8 max	10 max	watts
GRID-No.2 INPUT.....	3 max	3.5 max	watts
GRID-No.1 INPUT.....	0.2 max	0.24 max	watt
PLATE DISSIPATION.....	6 max	7.5 max	watts
PEAK HEATER-CATHODE VOLTAGE:			
Heater negative with respect to cathode.....	100 max	100 max	volts
Heater positive with respect to cathode.....	100 max	100 max	volts
BULB TEMPERATURE (At hottest point).....	225 max	225 max	°C

Typical Operation to 500 Mc:	<i>For operation at frequencies up to 500 Mc</i>		
	CCS	ICAS	
DC Plate Voltage.....	180	200	volts
DC Grid-No.2 Voltage (Approx.).....	180	190	volts
Through resistor of.....	1200	1200	ohms
DC Grid-No.1 Voltage.....	-74	-74	volts
From grid resistor (each grid) of.....	82000	82000	ohms
Peak-to-Peak RF Grid-No.1 Voltage.....	165	165	volts
DC Plate Current.....	40	46	ma
DC Grid-No.2 Current.....	9.7	11	ma
DC Grid-No.1 Current.....	1.8	1.8	ma
Driver Power Output (Approx.).....	1.1	1.1	watts
Useful Power Output (Approx.) <sup>•</sup> .....	1.8	2.2	watts

<sup>•</sup> Measured at load of output circuit.

### OPERATING CONSIDERATIONS

The 6939 requires a Noval nine-contact socket and may be operated in any position. OUTLINE 9, *Outlines* Section.

In "straight-through" rf amplifier service, shielding may be required for stable operation. To minimize external feedback from the plate to grid No.1, a grounded

shield, crossing the terminal end of the tube socket through the space between pins 4 and 5 and the space between pins 1 and 9, is generally adequate.

The heater may be effectively bypassed by grounding one heater pin at the tube socket and bypassing the other heater pin to ground with a low inductance capacitor. If further isolation of the ungrounded heater pin is required, a suitable rf choke, followed by another low-inductance bypass capacitor, is recommended.

To reduce the effect of cathode lead inductance, the cathode of the 6939 should be grounded by the shortest possible connection.

The rf impedance between grid No.2 and the cathode must be kept low, usually by a suitable bypass capacitor. In telephony service when grid No.2 is modulated, a smaller bypass capacitor may be required than is used for telegraphy service to avoid excessive af bypassing. If the capacitance value used is too small, rf feedback may occur between the plate and grid No.1, depending on the circuit layout, operating frequency, and power gain of the stage. AF bypassing difficulties can usually be eliminated if the grid-No.2 bypass capacitor is replaced by a series-resonant circuit tuned to resonate at the operating frequency. This circuit will present a high impedance to audio frequencies but a very low impedance to its resonant frequency.

It is recommended that a 100-ohm resistor be connected in series with grid No.2, as close as possible to the socket, to prevent the generation of parasitic oscillations.

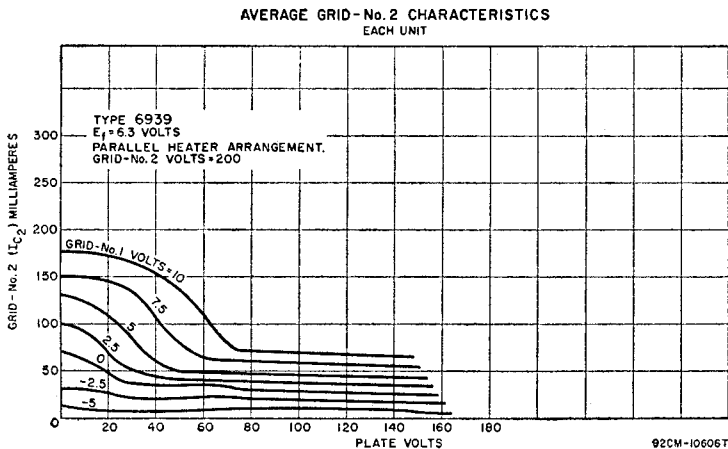
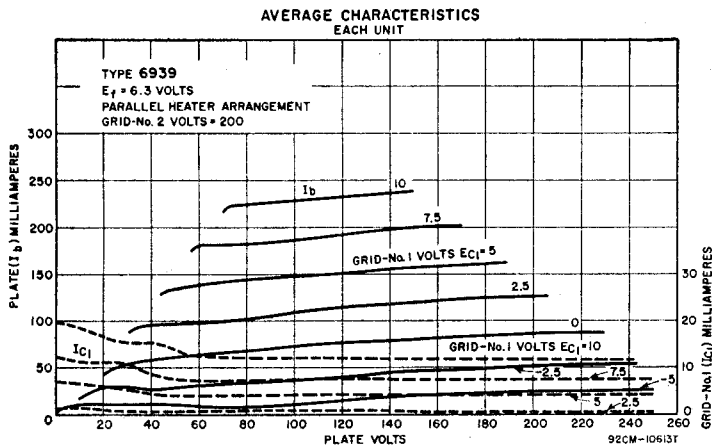



**FULL-WAVE GAS AND  
MERCURY-VAPOR RECTIFIER**

**7014**

See type 604/7014.

**HALF-WAVE MERCURY-  
VAPOR RECTIFIER**

**7018**

See type 615/7018.

**HALF-WAVE GAS AND  
MERCURY-VAPOR RECTIFIER**

**7019**

**7020**

See type 635/7019.

See type 635L/7020.

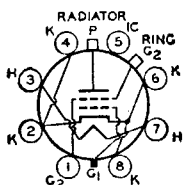

**BEAM POWER TUBE**

Glass-metal, forced-air-cooled, heater-cathode types having integral plate radiators; used as af power amplifiers and modulators and as rf power amplifiers and oscillators. Class C Te-

**7034/  
4X150A  
7035/  
4X150D**

legraphy maximum CCS plate dissipation, 250 watts. Full ratings to 150 Mc; reduced ratings to 500 Mc. May be operated in any position. **OUTLINE 82**, *Outlines* Section. Air flow must be adequate to limit the plate and seal temperatures to their specified maximum values. A minimum air flow of 5.3 cfm must pass through the radiator. Less air flow is required when an air-system socket is used to direct the flow of air through the radiator.

	7034/4X150A	7035/4X150D	
HEATER VOLTAGE (AC/DC)†	6.0	26.5	volts
HEATER CURRENT	2.6	0.68	amperes
HEATING TIME (Minimum)		30	seconds
MU-FACTOR, Grid No.2 to Grid No.1*		5	
DIRECT INTERELECTRODE CAPACITANCES:°			
Grid No.1 to plate		0.03	μf
Grid No.1 to cathode, grid No.2, and heater		16	μf
Plate to cathode, grid No.2, and heater		4.4	μf
PLATE TEMPERATURE (Measured on base end of plate surface at junction with fins)		250 max	°C
TEMPERATURE OF PLATE SEAL		200 max	°C
TEMPERATURE OF BASE SEALS AND GRID-NO.2 SEAL		175 max	°C
• Grid-No.2 volts, 300; grid-No.2 milliamperes, 50.			

**AF POWER AMPLIFIER AND MODULATOR—Class AB<sub>1</sub>**

**Maximum CCS Ratings:**

DC PLATE VOLTAGE	2000 max	volts
DC GRID-NO.2 VOLTAGE	400 max	volts
MAXIMUM-SIGNAL DC PLATE CURRENT*	250 max	ma
PLATE DISSIPATION*	250 max	watts
GRID-NO.2 DISSIPATION*	12 max	watts
<b>PEAK HEATER-CATHODE VOLTAGE:</b>		
Heater negative with respect to cathode	150 max	volts
Heater positive with respect to cathode	150 max	volts

**Maximum Circuit Values:**

Grid-No.1-Circuit Resistance (Per tube)	0.1 max	megohm
---	---------	--------

**AF POWER AMPLIFIER AND MODULATOR—Class AB<sub>2</sub>**

**Maximum CCS Ratings:**

DC PLATE VOLTAGE	2000 max	volts
------------------	----------	-------

DC GRID-NO.2 VOLTAGE.....	400 max	volts
MAXIMUM-SIGNAL DC PLATE CURRENT <sup>†</sup> .....	250 max	ma
PLATE DISSIPATION <sup>‡</sup> .....	250 max	watts
GRID-NO.2 INPUT <sup>§</sup> .....	12 max	watts
GRID-NO.1 INPUT.....	2 max	watts
PEAK HEATER-CATHODE VOLTAGE:		
Heater negative with respect to cathode.....	150 max	volts
Heater positive with respect to cathode.....	150 max	volts

### PLATE-MODULATED RF POWER AMPLIFIER—Class C Telephony

Maximum CCS Ratings:	<i>Up to</i>	<i>150 to</i>	
	<i>150 Mc</i>	<i>500 Mc</i>	
DC PLATE VOLTAGE.....	1600 max	1000 max	volts
DC GRID-NO.2 VOLTAGE.....	300 max	300 max	volts
DC GRID-NO.1 VOLTAGE.....	-250 max	250 max	volts
DC PLATE CURRENT.....	200 max	200 max	ma
PLATE DISSIPATION.....	165 max	165 max	watts
GRID-NO.2 INPUT.....	10 max	10 max	watts
GRID-NO.1 INPUT.....	2 max	2 max	watts
PEAK HEATER-CATHODE VOLTAGE:			
Heater negative with respect to cathode.....	150 max	150 max	volts
Heater positive with respect to cathode.....	150 max	150 max	volts
Maximum Circuit Values:			
Grid-No.1-Circuit Resistance, Under any condition.....		25000 max	ohms

### RF POWER AMPLIFIER AND OSCILLATOR—Class C Telegraphy and

#### RF POWER AMPLIFIER—Class C FM Telephony

Maximum CCS Ratings:	<i>Up to</i>	<i>150 to</i>	
	<i>150 Mc</i>	<i>500 Mc</i>	
DC PLATE VOLTAGE.....	2000 max	1250 max	volts
DC GRID-NO.2 VOLTAGE.....	300 max	300 max	volts
DC GRID-NO.1 VOLTAGE.....	-250 max	-250 max	volts
DC PLATE CURRENT.....	250 max	250 max	ma
PLATE DISSIPATION.....	250 max	250 max	watts
GRID-NO.2 INPUT.....	12 max	12 max	watts
GRID-NO.1 INPUT.....	2 max	2 max	watts
Maximum Circuit Values:			
Grid-No.1-Circuit Resistance, Under any condition.....		25000 max	ohms

† Because the cathode is subjected to considerable back bombardment as the frequency is increased with resultant increase in temperature, the heater voltage should be reduced depending on operating conditions and frequency to prevent overheating the cathode and resultant short life.

° With cylindrical shield having inside diameter of 1-13/16 inches completely surrounding radiator, and insulated from the top and sides of it by a 1/16-inch thickness of insulating material; and with a cylindrical shield having inside diameter of 1.460 inches and length of 5/16 inch surrounding the grid-No.2 ring terminal and insulated from it. Both shields are connected to ground.

‡ Averaged over any audio-frequency cycle of sine-wave form.

### POWER PENTODE

See type 8077/7054.

## 7054

### MEDIUM-MU TRIODE— POWER PENTODE

## 7060

Miniature heater-cathode type used in mobile communication equipment operating from 12-volt storage-battery systems. Pentode unit is used in Class C rf amplifier and frequency-

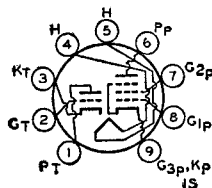

multiplier applications at frequencies up to 40 Mc; triode unit is used in reactance modulator circuits. Requires Miniature nine-contact socket and may be operated in any position. **OUTLINE 6, Outlines Section.** During manufacture, this tube is subjected to special controls and tests for heater-cycling, heater-cathode leakage, interelectrode leakage, low-frequency-vibration performance, 500-hour intermittent life performance, and intermittent shorts.

## Technical Data

HEATER VOLTAGE RANGE (AC/DC) .....	12 to 15	volts
HEATER CURRENT (APPROX.) at 13.5 volts .....	0.28	ampere
DIRECT INTERELECTRODE CAPACITANCES: <sup>o</sup>		
Triode Unit:		
Grid to Plate .....	2.2	$\mu\text{f}$
Grid to Cathode and Heater .....	2.4	$\mu\text{f}$
Plate to Cathode and Heater .....	0.22	$\mu\text{f}$
Pentode Unit:		
Grid No.1 to Plate .....	0.044	$\mu\text{f}$
Grid No.1 to all Other Electrodes except Plate .....	7.1	$\mu\text{f}$
Plate to all Other Electrodes except Grid No.1 .....	2.5	$\mu\text{f}$
Triode Grid to Pentode Plate .....	0.022 max	$\mu\text{f}$
Pentode Grid No.1 to Triode Plate .....	0.015 max	$\mu\text{f}$
Pentode Plate to Triode Plate .....	0.16	$\mu\text{f}$
<sup>o</sup> Without external shield.		

AVERAGE CHARACTERISTICS  
TRIODE UNIT

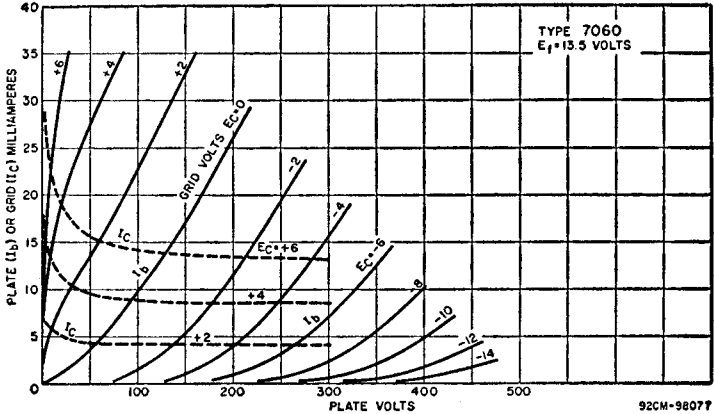

AVERAGE CHARACTERISTICS  
PENTODE UNIT

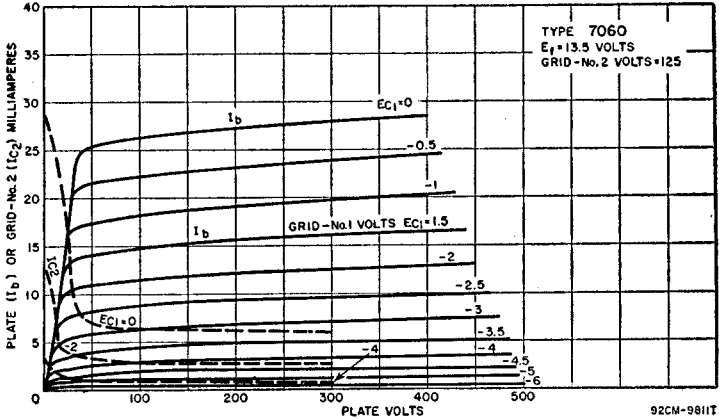

AMPLIFIER—Class A<sub>1</sub>

Maximum Ratings:

PLATE VOLTAGE .....	300 max	volts
GRID-NO.2 SUPPLY VOLTAGE .....	300 max	volts
GRID-NO.2 VOLTAGE .....	-	volts

Triode Unit	Pentode Unit	
300 max	300 max	volts
-	300 max	volts
See grid-No.2 Input Rating Chart		

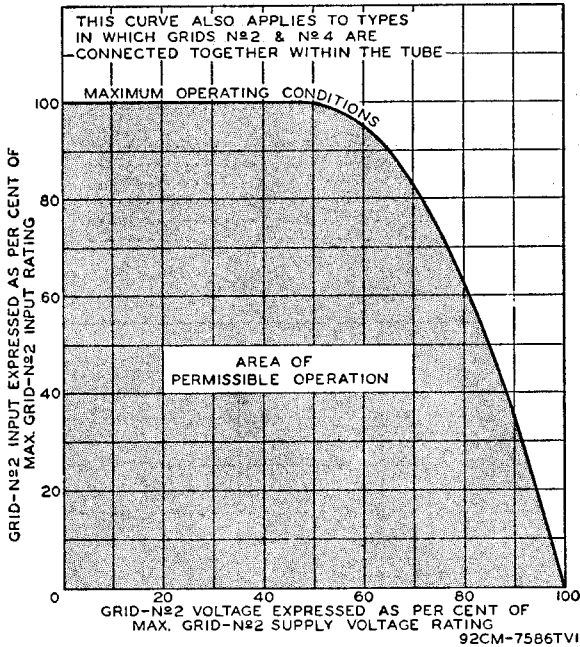

GRID-No.1 VOLTAGE, Positive bias value .....	0 max	0 max	volts
GRID-No.2 INPUT:			
For grid-No.2 voltages up to 150 volts .....	-	1 max	watt
For grid-No.2 voltages between 150 and 300 volts .....	See grid-No.2 Input Rating Chart		
PLATE DISSIPATION .....	2.5 max	3 max	watts
PEAK HEATER-CATHODE VOLTAGE:			
Heater negative with respect to cathode .....	120 max	120 max	volts
Heater positive with respect to cathode .....	120 max	120 max	volts

**Characteristics with 13.5 Volts on Heater:**

	<i>Triode Unit</i>	<i>Pentode Unit</i>	
Plate Supply Voltage .....	150	200	volts
Grid-No.2 Supply Voltage .....	-	125	volts
Cathode Resistor .....	150	82	ohms
Amplification Factor .....	40	-	
Plate Resistance (Approx.) .....	8200	150000	ohms
Transconductance .....	4900	7000	$\mu$ mhos
Plate Current .....	9	15	ma
Grid-No.2 Current .....	-	3.4	ma
Grid-No.1 Voltage (Approx.) for plate current of 100 $\mu$ a .....	-6.5	-8	volts

**Maximum Circuit Values:**

Grid-No.1-Circuit Resistance:			
For fixed-bias operation .....	0.5 max	0.25 max	megohm
For cathode-bias operation .....	1 max	1 max	megohm

**RF POWER AMPLIFIER AND OSCILLATOR—Class C Telegraphy  
and**

**RF POWER AMPLIFIER—Class C FM Telephony**

**Maximum CCS Ratings, (Pentode Unit):**

DC PLATE VOLTAGE .....	300 max	volts
DC GRID-No.2 VOLTAGE .....	150 max	volts
DC GRID-No.1 VOLTAGE:		
Negative-bias value .....	50 max	volts
Positive-bias value .....	0 max	volts

DC PLATE CURRENT.....	20 max	ma
DC GRID-NO.2 CURRENT.....	7 max	ma
DC GRID-NO.1 CURRENT.....	3 max	ma
GRID-NO.2 INPUT.....	0.8 max	watt
PLATE DISSIPATION.....	2.75 max	watts
<b>PEAK HEATER-CATHODE VOLTAGE:</b>		
Heater negative with respect to cathode.....	120 max	volts
Heater positive with respect to cathode.....	120 max	volts

**Typical Operation with 13.5 Volts on Heater:**

	<i>At frequencies up to 40 Mc</i>		
DC Plate Voltage.....	200	250	300
DC Grid-No.2 Voltage.....	85	105	125
DC Grid-No.1 Voltage.....	-7	-9	-11
DC Plate Current.....	11	15	20
DC Grid-No.2 Current.....	3.2	4.5	6
DC Grid-No.1 Current (Approx.).....	0.9	1.2	1.6
Driving Power (Approx.).....	9	15	25
Power Output.....	1.8	2.1	3.5

**Maximum Circuit Values:**

Grid-No.1-Circuit Resistance.....	0.1 max	megohm
-----------------------------------	---------	--------

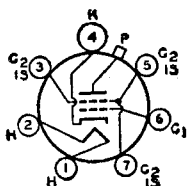

**BEAM POWER TUBE**

Sturdy heater-cathode type used as a power amplifier and modulator, and as rf power amplifier and oscillator. May be used with full input up to 60 Mc. For operation at 100 Mc, plate

7094

voltage and plate input should be reduced to 80 per cent of maximum ratings; at 175 Mc, to 70 per cent. Class C Telegraphy maximum plate dissipation, CCS 100 watts, ICAS 125 watts. May be operated in any position. OUTLINE 29, *Outlines* Section. Under operating conditions at maximum ratings, some forced-air cooling will be required to limit the maximum bulb temperature to its specified value.

HEATER VOLTAGE (AC/DC).....	6.3	volts
HEATER CURRENT at 6.3 volts.....	2.85	amperes
MU-FACTOR, GRID NO.2 TO GRID NO.1*.....	7	
<b>DIRECT INTERELECTRODE CAPACITANCES:</b>		
Grid No.1 to plate.....	0.6	μf
Grid No.1 to grid No.2 and internal shield.....	11	μf
Grid No.1 to cathode and heater.....	8.5	μf
Grid No.2 and internal shield to plate.....	9.5	μf
Grid No.2 and internal shield to cathode and heater.....	2.0	μf
Plate to cathode and heater.....	0.2	μf
BULB TEMPERATURE (At hottest point).....	250 max	°C

\* For plate and grid-No.2 volts, 300; plate ma., 250.

**AF POWER AMPLIFIER AND MODULATOR—Class AB<sub>1</sub>**

**Maximum Ratings:**

	<i>CCS</i>	<i>ICAS</i>	
DC PLATE VOLTAGE.....	1500 max	2000 max	volts
DC GRID-NO.2 VOLTAGE.....	400 max	400 max	volts
MAXIMUM-SIGNAL DC PLATE CURRENT†.....	350 max	350 max	ma
MAXIMUM-SIGNAL PLATE INPUT‡.....	300 max	400 max	watts
MAXIMUM-SIGNAL GRID-NO.2 INPUT‡.....	20 max	20 max	watts
PLATE DISSIPATION‡.....	100 max	125 max	watts
<b>PEAK HEATER-CATHODE VOLTAGE:</b>			
Heater negative with respect to cathode.....	135 max	135 max	volts
Heater positive with respect to cathode.....	135 max	135 max	volts

**PLATE-MODULATED RF POWER AMPLIFIER—Class C Telephony**

**Maximum Ratings:**

	<i>CCS</i>	<i>ICAS</i>	
DC PLATE VOLTAGE.....	1000 max	1200 max	volts
DC GRID-NO.2 VOLTAGE.....	400 max	400 max	volts
DC GRID-NO.1 VOLTAGE.....	-300 max	-300 max	volts
DC PLATE CURRENT.....	280 max	280 max	ma

## RCA Transmitting Tubes

DC GRID-NO.1 CURRENT.....	25 <i>max</i>	30 <i>max</i>	ma
PLATE INPUT.....	250 <i>max</i>	335 <i>max</i>	watts
GRID-NO.2 INPUT.....	13.5 <i>max</i>	13.5 <i>max</i>	watts
PLATE DISSIPATION.....	67 <i>max</i>	83 <i>max</i>	watts
<b>PEAK HEATER-CATHODE VOLTAGE:</b>			
Heater negative with respect to cathode.....	135 <i>max</i>	135 <i>max</i>	volts
Heater positive with respect to cathode.....	135 <i>max</i>	135 <i>max</i>	volts

**Maximum Circuit Values:**

Grid-No.1-Circuit Resistance°.....	30000 <i>max</i>	30000 <i>max</i>	ohms
------------------------------------	------------------	------------------	------

### RF POWER AMPLIFIER AND OSCILLATOR—Class C Telegraphy and

### RF POWER AMPLIFIER—Class C FM Telephony

Maximum Ratings:	CCS	ICAS	
DC PLATE VOLTAGE.....	1250 <i>max</i>	1500 <i>max</i>	volts
DC GRID-NO.2 VOLTAGE.....	400 <i>max</i>	400 <i>max</i>	volts
DC GRID-NO.1 VOLTAGE.....	-300 <i>max</i>	-300 <i>max</i>	volts
DC PLATE CURRENT.....	340 <i>max</i>	340 <i>max</i>	ma
DC GRID-NO.1 CURRENT.....	25 <i>max</i>	30 <i>max</i>	ma
PLATE INPUT.....	375 <i>max</i>	500 <i>max</i>	watts
GRID-NO.2 INPUT.....	20 <i>max</i>	20 <i>max</i>	watts
PLATE DISSIPATION.....	100 <i>max</i>	125 <i>max</i>	watts
<b>PEAK HEATER-CATHODE VOLTAGE:</b>			
Heater negative with respect to cathode.....	135 <i>max</i>	135 <i>max</i>	volts
Heater positive with respect to cathode.....	135 <i>max</i>	135 <i>max</i>	volts

**Maximum Circuit Values:**

Grid-No.1-Circuit Resistance°.....	30000 <i>max</i>	30000 <i>max</i>	ohms
------------------------------------	------------------	------------------	------

† Averaged over any audio-frequency cycle of sine-wave form.

° When grid No.1 is driven positive, the total dc grid-No.1-circuit resistance should not exceed the specified maximum value of 30,000 ohms. If this value is insufficient to provide adequate bias, the additional required bias must be supplied by a cathode resistor or fixed supply.

### BEAM POWER TUBE

7203/  
4CX250B  
7204/  
4CX250F

Ceramic-metal, forced-air-cooled, heater-cathode types used as af power amplifiers and modulators and as rf power amplifiers and oscillators. May be used with full input up to 500 Mc. Class C Telegraphy maximum plate dissipation, CCS 250 watts.

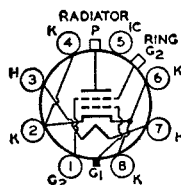

	7203/ 4CX250B	7204/ 4CX250F	
HEATER VOLTAGE‡ (AC/DC).....	6	26.5	volts
HEATER CURRENT.....	2.6	0.58	amperes
MINIMUM HEATING TIME.....	—	30	seconds
MU-FACTOR, GRID NO.2 TO GRID NO.1★.....	—	5	
<b>DIRECT INTERELECTRODE CAPACITANCES:°</b>			
Grid No.1 to plate.....	—	0.03	μf
Grid No.1 to cathode, grid No.2, and heater.....	—	16	μf
Plate to cathode, grid No.2, and heater.....	—	4.4	μf
<b>PLATE TEMPERATURE (Measured on base end of plate surface at junction with fins).....</b>			
TEMPERATURE OF PLATE SEAL, GRID-NO.2 SEAL, AND BASE SEALS.....	—	250 <i>max</i>	°C
TEMPERATURE OF PLATE SEAL, GRID-NO.2 SEAL, AND BASE SEALS.....	—	250 <i>max</i>	°C

★ For grid-No.2 volts, 300; grid-No.2 ma., 50.

### AF POWER AMPLIFIER AND MODULATOR—Class AB<sub>1</sub>

**Maximum CCS Ratings:**

DC PLATE VOLTAGE.....	2000 <i>max</i>	volts
DC GRID-NO.2 VOLTAGE.....	400 <i>max</i>	volts
MAXIMUM-SIGNAL DC PLATE CURRENT <sup>†</sup> .....	250 <i>max</i>	ma
PLATE DISSIPATION <sup>†</sup> .....	250 <i>max</i>	watts
GRID-NO.2 INPUT <sup>†</sup> .....	12 <i>max</i>	watts
<b>PEAK HEATER-CATHODE VOLTAGE:</b>		
Heater negative with respect to cathode.....	150 <i>max</i>	volts
Heater positive with respect to cathode.....	150 <i>max</i>	volts

## Technical Data

### Typical CCS Operation:

	<i>Values are for 2 tubes</i>			
DC Plate Voltage.....	1000	1500	2000	volts
DC Grid-No.2 Voltage.....	350	350	350	volts
DC Grid-No.1 Voltage.....	-55	-55	-55	volts
Peak AF Grid-No.1-to-Grid-No.1 Voltage.....	94	94	94	volts
Zero-Signal DC Plate Current.....	166	166	166	ma
Maximum-Signal DC Plate Current.....	500	500	500	ma
Zero-Signal DC Grid-No.2 Current.....	0	0	0	ma
Maximum-Signal DC Grid-No.2 Current (Approx.)...	10	8	8	ma
Effective Load Resistance (Plate to plate).....	3300	6000	8700	ohms
Maximum-Signal Driving Power (Approx.).....	0	0	0	watts
Maximum-Signal Power Output (Approx.).....	220	400	590	watts

### Maximum Circuit Values:

Grid-No.1-Circuit Resistance (Per tube).....	0.1 max	megohm
--	---------	--------

### PLATE-MODULATED RF POWER AMPLIFIER—Class C Telephony

	<i>Up to 500 Mc</i>			
DC PLATE VOLTAGE.....	1500 max			volts
DC GRID-NO.2 VOLTAGE.....	300 max			volts
DC GRID-NO.1 VOLTAGE.....	-250 max			volts
DC PLATE CURRENT.....	200 max			ma
PLATE DISSIPATION.....	165 max			watts
GRID-NO.2 INPUT.....	8 max			watts
GRID-NO.1 INPUT.....	2 max			watts
<b>PEAK HEATER-CATHODE VOLTAGE:</b>				
Heater negative with respect to cathode.....	150 max			volts
Heater positive with respect to cathode.....	150 max			volts

### Typical CCS Operation:

	<i>At frequencies up to 175 Mc</i>			
DC Plate Voltage.....	500	1000	1500	volts
DC Grid-No.2 Voltage (Modulated approx. 55%) <sup>2</sup> .....	250	250	250	volts
DC Grid-No.1 Voltage <sup>1</sup> .....	-100	-100	-100	volts
Peak RF Grid-No.1 Voltage.....	113	113	113	volts
DC Plate Current.....	200	200	200	ma
DC Grid-No.2 Current.....	32	31	31	ma
DC Grid-No.1 Current (Approx.).....	6	6	6	ma
Driving Power (Approx.) <sup>3</sup> .....	0.7	0.7	0.7	watt
Power Output (Approx.).....	50	140	235	watts

### Maximum Circuit Values:

Grid-No.1-Circuit Resistance, Under any condition.....	25000 max	ohms
--	-----------	------

### RF POWER AMPLIFIER AND OSCILLATOR—Class C Telegraphy

and

### RF POWER AMPLIFIER—Class C FM Telephony

### Maximum CCS Ratings:

	<i>Up to 500 Mc</i>			
DC PLATE VOLTAGE.....	2000 max			volts
DC GRID-NO.2 VOLTAGE.....	300 max			volts
DC GRID-NO.1 VOLTAGE.....	-250 max			volts
DC PLATE CURRENT.....	250 max			ma
PLATE DISSIPATION.....	250 max			watts
GRID-NO.2 INPUT.....	12 max			watts
GRID-NO.1 INPUT.....	2 max			watts
<b>PEAK HEATER-CATHODE VOLTAGE:</b>				
Heater negative with respect to cathode.....	150 max			volts
Heater positive with respect to cathode.....	150 max			volts

### Typical CCS Operation:

	<i>At frequencies up to 175 Mc</i>				
DC Plate Voltage.....	500	1000	1500	2000	volts
DC Grid-No.2 Voltage.....	250	250	250	250	volts
DC Grid-No.1 Voltage.....	-90	-90	-90	-90	volts
Peak RF Grid-No.1 Voltage.....	109	109	109	109	volts
DC Plate Current.....	250	250	250	250	ma
DC Grid-No.2 Current.....	48	45	36	30	ma
DC Grid-No.1 Current (Approx.).....	12	12	11	11	ma
Driving Power (Approx.).....	1	1	1	1	watt
Power Output (Approx.).....	65	180	290	400	watts

# RCA Transmitting Tubes

*At frequency of 500 Mc with coaxial cavity*

DC Plate Voltage .....	2000	volts
DC Grid-No.2 Voltage .....	300	volts
DC Grid-No.1 Voltage .....	-90	volts
DC Plate Current .....	250	ma
DC Grid-No.2 Current .....	10	ma
DC Grid-No.1 Current (Approx.) .....	25	ma
Driver Power Output (Approx.) <sup>o</sup> .....	18	watts
Useful Power Output (Approx.) .....	250	watts

**Maximum Circuit Values:**

Grid-No.1-Circuit Resistance, Under any condition .....	25000 max	ohms
---	-----------	------

## LINEAR RF POWER AMPLIFIER— Single-Sideband Suppressed-Carrier Service

**Maximum CCS Ratings:**

*Up to 500 Mc*

DC PLATE VOLTAGE .....	2000 max	volts
DC GRID-NO.2 VOLTAGE .....	400 max	volts
MAXIMUM-SIGNAL DC PLATE CURRENT .....	250 max	ma
PLATE DISSIPATION .....	250 max	watts
GRID-NO.2 INPUT .....	12 max	watts
<b>PEAK HEATER-CATHODE VOLTAGE:</b>		
Heater negative with respect to cathode .....	150 max	volts
Heater positive with respect to cathode .....	150 max	volts

**Typical CCS Operation:**

*With two-tone modulation at 30 Mc:*

DC Plate Voltage .....	1000	1500	2000	volts
DC Grid-No.2 Voltage* .....	350	350	350	volts
DC Grid-No.1 Voltage** .....	-55	-55	-55	volts
Zero-Signal DC Plate Current .....	83	83	83	ma
Effective RF Load Resistance .....	1650	3000	4350	ohms
DC Plate Current at Peak of Envelope .....	250	250	250	ma
Average DC Plate Current .....	175	175	175	ma
DC Grid-No.2 Current at Peak of Envelope .....	30	30	30	ma
Average DC Grid-No.2 Current .....	6	9.5	15	ma
Average DC Grid-No.1 Current .....	0	0	0	ma
Peak-Envelope Driver Power (Approx.) .....	1	1	1	watt
Output-Circuit Efficiency (Approx.) .....	95	95	95	%
<b>Distortion Products Level:<sup>o</sup></b>				
Third Order .....	29	29	30	db
Fifth Order .....	40	38	35	db
<b>Useful Power Output (Approx.):†</b>				
Average .....	55	100	147.5	watts
Peak Envelope .....	110	200	295	watts

**Maximum Circuit Values:**

Grid-No.1-Circuit Resistance, Under any condition:

With fixed bias .....	25000 max	ohms
With cathode bias .....	Not recommended	

† Because the cathode is subjected to considerable back bombardment as the frequency is increased with resultant increase in temperature, the heater voltage should be reduced depending on operating conditions and frequency to prevent overheating the cathode and resultant short life.

<sup>o</sup> With cylindrical shield JETEC No.320 surrounding radiator, and with a cylindrical shield JETEC No.321 surrounding the grid-No.2 ring terminal. Both shields are connected to ground.

<sup>a</sup> Averaged over any audio-frequency cycle of sine-wave form.

• The driver stage is required to supply tube losses and rf-circuit losses. The driver stage should be designed to provide an excess of power above the indicated values to take care of variations in line voltage, in components, in initial tube characteristics, and in tube characteristics during life.

<sup>‡</sup> The dc grid-No.2 voltage must be modulated approximately 55% in phase with the plate modulation in order to obtain 100% modulation of the 7203. The use of a series grid-No.2 resistor or reactor may not give satisfactory performance and is therefore not recommended.

<sup>o</sup> Obtained from grid-No.1 resistor or from a combination of grid-No.1 resistor with either fixed supply or cathode resistor.

\* Preferably obtained from a fixed supply.

<sup>‡</sup> Two-tone modulation operation refers to that class of amplifier service in which the input consists of two equal monofrequency rf signals having constant amplitude. These signals are produced in a single-sideband suppressed-carrier system when two equal-and-constant-amplitude audio frequencies are applied to the input of the system.

\*\* Obtained from a fixed supply.

<sup>o</sup> Without the use of feedback to enhance linearity.

† Measured at load of output circuit having indicated efficiency.



**OPERATING CONSIDERATIONS**

Types 7203/4CX250B and 7204/4CX250F may be operated in any position. OUTLINE 83, *Outlines* Section. It is essential that adequate cooling air be directed over the base seals, past the envelope, and through the radiator. Under these conditions and with the tube operating at maximum plate dissipation for each class of service, a minimum air flow of 3.6 cfm must pass through the radiator. The corresponding pressure drop is approximately 0.1 inch of water. These requirements are for operation at sea level and at an ambient temperature of 20°C. At higher altitudes and ambient temperatures, the air flow must be increased to maintain the respective seal temperatures and the plate temperature within maximum ratings. Less air flow will be needed if an air-system socket is used to direct the flow of air through the radiator.

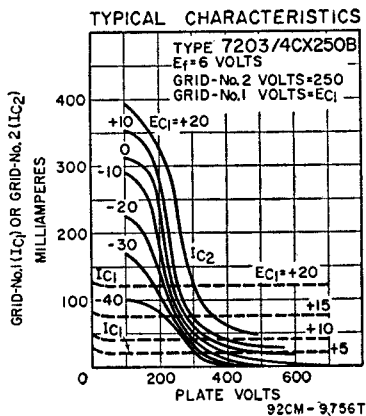
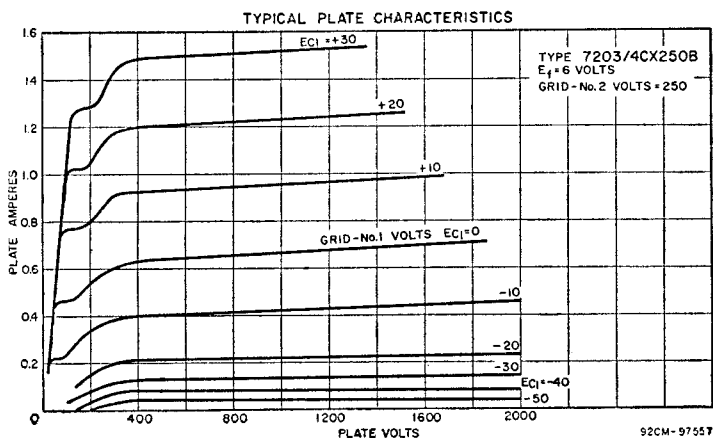

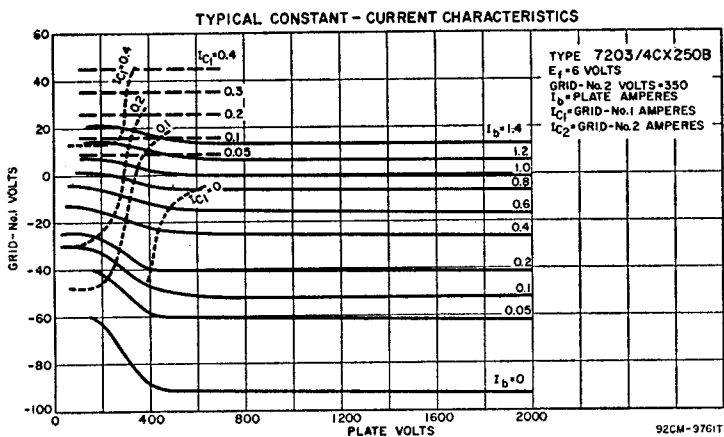
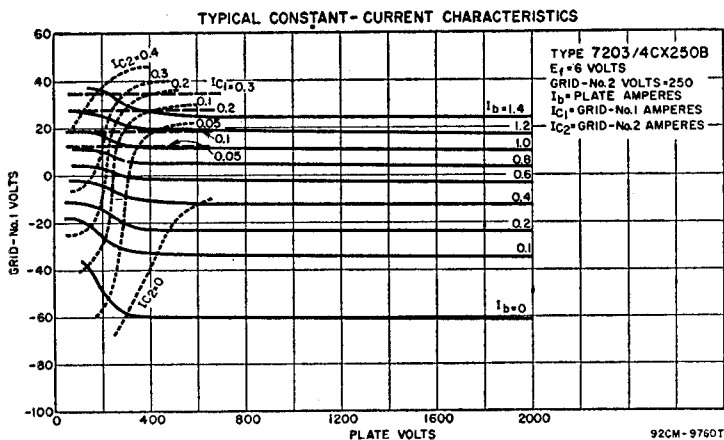

### BEAM POWER TUBE

# 7212

Small, rugged, heater-cathode type used as a power amplifier and modulator and as rf amplifier and oscillator in applications where dependable performance under severe shock

and vibration is essential. May be used with full input up to 60 Mc and with reduced input up to 175 Mc. Class C Telegraphy maximum plate dissipation, CCS 20 watts, ICAS 25 watts. Requires Octal socket and may be operated in any position. OUTLINE 18, *Outlines* Section. Except for base and special ratings and performance data for shock and vibration, the 7212 is identical with type 6146.

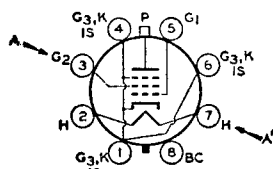

AA' = PLANE OF ELECTRODES

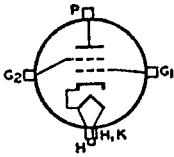

## BEAM POWER TUBE

Sturdy, uhf, forced-air-cooled, heater-cathode, cermolox type used as rf power amplifier and oscillator in compact mobile and fixed equipment. Tube employs matrix-type cathode. Useful

# 7213

with full ratings at frequencies up to 1215 Mc. Class C Telegraphy maximum plate dissipation, CCS 1500 watts.

HEATER VOLTAGE (AC/DC)†	5.5 typical	volts
	6 max	volts
HEATER CURRENT (At 5.5 volts)	17.3	amperes
MINIMUM HEATING TIME (At 5.5 volts)	5	minutes
MU-FACTOR, GRID NO.2 TO GRID NO.1★	17	
<b>DIRECT INTERELECTRODE CAPACITANCES:</b>		
Grid No.1 to plate <sup>⊖</sup>	0.17 max	μf
Grid No.1 to cathode and heater	42	μf
Plate to cathode and heater <sup>⊖</sup> ■	0.017	μf
Grid No.1 to grid No.2	55	μf
Grid No.2 to plate	16	μf
Grid No.2 to cathode and heater	1.4 max	μf
SEAL TEMPERATURE (Plate, grid No.2, grid No.1, cathode, and heater)	250 max	°C

★ For plate volts, 2500; grid-No.2 volts, 600; plate ma., 600.

### PLATE-MODULATED RF POWER AMPLIFIER—Class C Telephony

<b>Maximum CCS Ratings:</b>		
DC PLATE VOLTAGE	<i>Up to 1215 Mc</i>	
DC GRID-NO.2 VOLTAGE	2000 max	volts
DC GRID-NO.1 VOLTAGE	1000 max	volts
DC PLATE CURRENT	-300 max	volts
DC GRID-NO.1 CURRENT	0.85 max	ampere
PLATE INPUT	0.2 max	ampere
GRID-NO.2 INPUT	1700 max	watts
PLATE DISSIPATION	35 max	watts
	1000 max	watts

<b>Typical CCS Operation:</b>		
	<i>In grid-drive circuit at 600 Mc</i>	
DC Plate Voltage	1800	2000
DC Grid-No.2 Voltage*	500	500
DC Grid-No.1 Voltage <sup>⊖</sup>	-30	-30
DC Plate Current	0.75	0.83
DC Grid-No.2 Current	0.015	0.015
DC Grid-No.1 Current (Approx.)	0.04	0.04
Driver Power Output (Approx.)*	50	55
Useful Power Output (Approx.)*	650	800

<b>Maximum Circuit Values:</b>		
Grid-No.1-Circuit Resistance, Under any condition	5000 <sup>‡</sup> max	ohms

### RF POWER AMPLIFIER AND OSCILLATOR—Class C Telegraphy and RF POWER AMPLIFIER—Class C FM Telephony

<b>Maximum CCS Ratings:</b>		
	<i>Up to 1215 Mc</i>	
DC PLATE VOLTAGE	2500 max	volts
DC GRID-NO.2 VOLTAGE	1000 max	volts
DC GRID-NO.1 VOLTAGE	-300 max	volts
DC PLATE CURRENT	1 max	ampere
DC GRID-NO.1 CURRENT	0.2 max	ampere
PLATE INPUT	2500 max	watts
GRID-NO.2 INPUT	50 max	watts
PLATE DISSIPATION	1500 max	watts

<b>Typical CCS Operation:</b>		
	<i>In grid-drive circuit at 600 Mc</i>	
DC Plate Voltage	2250	2500
DC Grid-No.2 Voltage**	500	500
DC Grid-No.1 Voltage <sup>⊖</sup>	-30	-30
DC Plate Current	0.9	1
DC Grid-No.2 Current	0.02	0.02

## RCA Transmitting Tubes

DC Grid-No.1 Current (Approx.)	0.07	0.07	ampere
Driver Power Output (Approx.) <sup>*</sup>	70	75	watts
Useful Power Output (Approx.) <sup>*</sup>	1050	1350	watts

### Maximum Circuit Values:

Grid-No.1-Circuit Resistance, Under any condition. . . . . 5000<sup>max</sup> ohms

†Because the cathode is subjected to considerable back bombardment as the frequency is increased with resultant increase in temperature, the heater voltage should be reduced depending on operating conditions and frequency to prevent overheating the cathode and resultant short life.

°With external, flat, metal shield having diameter of 8 inches, and center hole approximately 3 inches in diameter, provided with spring fingers that connect the shield to grid-No.2 terminal. Shield is located in plane of grid-No.2 terminal perpendicular to the tube axis.

■With external, flat, metal shield having diameter of 8 inches, and center hole approximately 2¾ inches in diameter, provided with spring fingers that connect the shield to grid-No. 1 terminal. Shield is located in plane of grid-No.1 terminal perpendicular to the tube axis.

●Obtained preferably from a separate source modulated along with the plate supply.

□Obtained from grid-No.1 resistor or from a combination of grid-No.1 resistor with either fixed supply or cathode resistor.

▲The driver stage is required to supply tube losses and rf-circuit losses. It should be designed to provide an excess of power above the indicated value to take care of variations in line voltage, in components, in initial tube characteristics, and in tube characteristics during life.

\*This value of useful power is measured in load of output circuit.

†If this value is insufficient to provide adequate bias, the additional required bias must be supplied by a cathode resistor or fixed supply.

\*\*Obtained preferably from a fixed supply, or from the plate-supply voltage with a voltage divider.

\* Obtained from fixed supply, by grid-No.1 resistor, by cathode resistor, or by combination methods.

## OPERATING CONSIDERATIONS

Type 7213 may be operated in any position. OUTLINE 88, *Outlines* Section. Adequate forced-air cooling must be provided to limit the terminal temperatures to their specified values. Typical cooling requirements are shown in the accompanying graph for air flow through the radiator. An air flow of 10 cfm is usually adequate to grid-No.2, grid-No.1, cathode, and heater terminals.

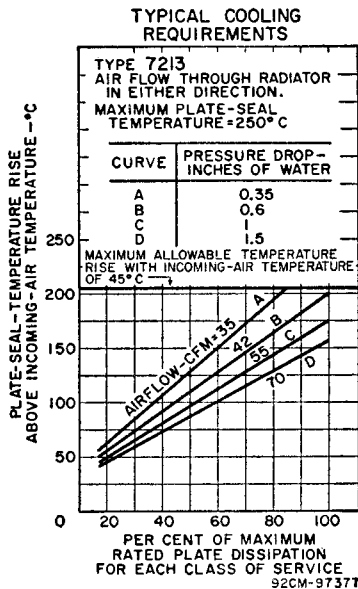
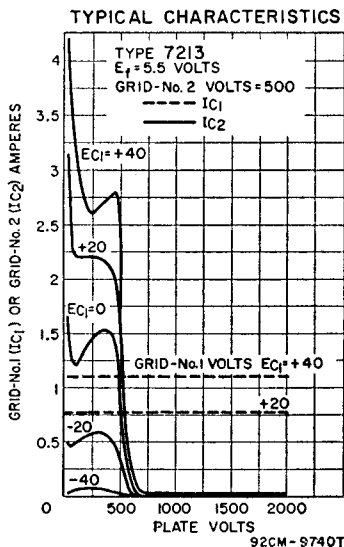

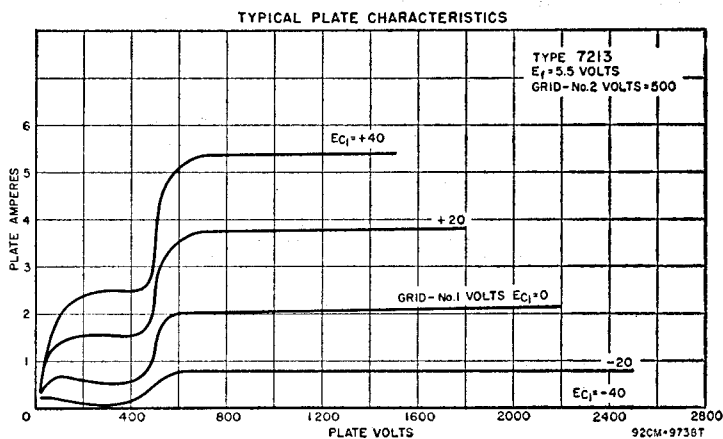

### BEAM POWER TUBE

# 7214

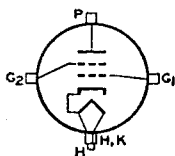

Sturdy, uhf, forced-air-cooled, heater-cathode, cermolox type used as rf-pulse power amplifier in compact mobile and fixed equipment. Useful with full ratings at frequencies up to

1215 Mc. Plate-and-Screen-Pulsed RF Amplifier maximum average plate dissipation, 1500 watts; maximum pulse duration, 10 microseconds. Tube has matrix-type cathode.

HEATER VOLTAGE (AC/DC) †	5.5 typical	volts
	6 max	volts
HEATER CURRENT (At 5.5 volts)	17.3	amperes
MINIMUM HEATING TIME (At 5.5 volts)	15	minutes
MU-FACTOR, GRID NO.2 TO GRID NO.1*	19	
DIRECT INTERELECTRODE CAPACITANCES:		
Grid No.1 to plate <sup>o</sup>	0.17 max	μf
Grid No.1 to cathode and heater	42	μf
Plate to cathode and heater <sup>o</sup>	0.017 max	μf
Grid No.1 to grid No.2	55	μf
Grid No.2 to plate	16	μf
Grid No.2 to cathode and heater <sup>o</sup>	1.4 max	μf
SEAL TEMPERATURE (Plate, grid No.2, grid No.1, cathode, and heater)	250 max	°C

\* For plate volts, 2500; grid-No.2 volts, 600; plate ma., 600.

### GRID-PULSED RF AMPLIFIER

For maximum ON time<sup>o</sup> of 10 microseconds

Maximum CCS Ratings:	Up to 1215 Mc	
DC PLATE VOLTAGE	5000 max	volts
DC GRID-NO.2 VOLTAGE	1200 max	volts
DC GRID-NO.1 VOLTAGE	-300 max	volts
DC PLATE CURRENT DURING PULSE	18 max	amperes
DC PLATE CURRENT	0.2 max	ampere
GRID-NO.2 INPUT (Average)	50 max	watts
GRID-NO.1 INPUT (Average)	30 max	watts
PLATE DISSIPATION (Average)	1500 max	watts

### Typical Operation:

In Class C cathode-drive circuit with rectangular-wave pulses at 1215 Mc and with duty factor<sup>2</sup> of 0.01

DC Plate Voltage	4500	volts
------------------	------	-------

# RCA Transmitting Tubes

DC Grid-No.2 Voltage.....	1000	volts
DC Grid-No.1 Voltage.....	-80	volts
DC Plate Current during pulse.....	11	amperes
DC Plate Current.....	0.11	ampere
DC Grid-No.2 Current.....	0.005	ampere
DC Grid-No.1 Current.....	0.01	ampere
Driver Power Output at peak of pulse (Approx.) <sup>†</sup> .....	4.5	kw
Useful Power Output at peak of pulse (Approx.).....	20	kw

## PLATE-AND-SCREEN-PULSED RF AMPLIFIER

For maximum ON time<sup>•</sup> of 10 microseconds

Maximum CCS Ratings:	<i>Up to 1215 Mc</i>	
PEAK POSITIVE-PULSE PLATE VOLTAGE.....	10000 max	volts
PEAK POSITIVE-PULSE GRID-NO.2 VOLTAGE.....	1200 max	volts
DC GRID-NO.1 VOLTAGE.....	-300 max	volts
DC PLATE CURRENT DURING PULSE.....	18 max	amperes
DC PLATE CURRENT.....	0.2 max	ampere
GRID-NO.2 INPUT (Average).....	50 max	watts
GRID-NO.1 INPUT (Average).....	30 max	watts
PLATE DISSIPATION (Average).....	1500 max	watts

### Typical Operation:

In Class C cathode-drive circuit with rectangular-wave pulses at 1215 Mc and with duty factor<sup>□</sup> of 0.01

Peak Positive-Pulse Plate Voltage.....	9000	10000	volts
Peak Positive-Pulse Grid-No.2 Voltage.....	1000	1000	volts
DC Grid-No.1 Voltage.....	-80	-80	volts
DC Plate Current during pulse.....	16	18	amperes
DC Plate Current.....	0.16	0.18	ampere
DC Grid-No.2 Current.....	0.008	0.009	ampere
DC Grid-No.1 Current.....	0.014	0.016	ampere
Driver Power Output at peak of pulse (Approx.) <sup>†</sup> .....	10	11	kw
Useful Power Output at peak of pulse (Approx.).....	50	65	kw

†Because the cathode is subjected to considerable back bombardment as the frequency is increased with resultant increase in temperature, the heater voltage should be reduced depending on operating conditions and frequency to prevent overheating the cathode and resultant short life.

□ Duty factor for the 7214 is defined as the ON time in microseconds divided by 1000 microseconds.

• ON time is defined as the sum of the durations of all the individual pulses which occur during any 1000-microsecond interval. Pulse duration is defined as the time interval between the two points on the pulse at which the instantaneous value is 70 per cent of the peak value. The peak value is defined as the maximum value of a smooth curve through the average of the fluctuations over the top portion of the pulse.

†The driver stage is required to supply tube losses, rf-circuit losses, and in cathode-drive circuits, the rf power added to the plate input. The driver stage should be designed to provide an excess of power above the indicated value to take care of variations in line voltage, in components, in initial tube characteristics, and in tube characteristics during life.

TYPICAL PLATE CHARACTERISTICS

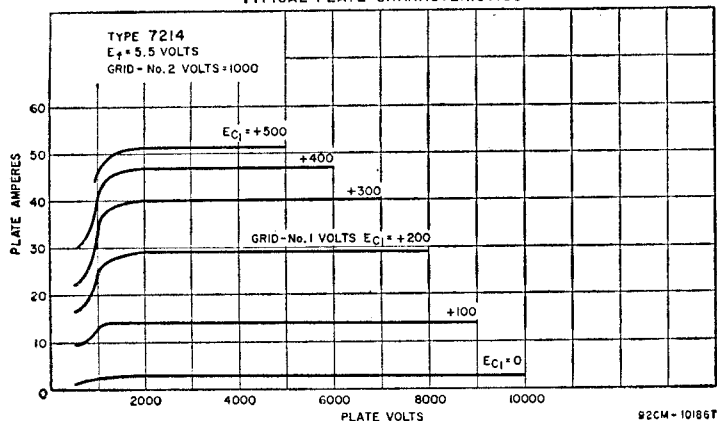

**OPERATING CONSIDERATIONS**

Type 7214 may be operated in any position. OUTLINE 88, *Outlines* Section. Adequate forced-air cooling must be provided to limit the terminal temperatures to their specified values. For typical cooling requirements for air flow through the radiator refer to graph for type 7213. An air flow of 10 cfm is usually adequate to grid-No.2, grid-No.1, cathode, and heater terminals.

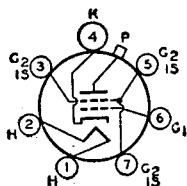

**BEAM POWER TUBE**

7270  
7271

Sturdy heater-cathode types used as af power amplifier and modulator and rf power amplifier and oscillator. May be used with full input at frequencies up to 60 Mc. For operation at

100 Mc, plate voltage should be reduced to 80 per cent and plate input should be reduced to 85 per cent of maximum ratings; at 175 Mc, reduce plate voltage to 62 per cent and plate input to 70 per cent. Class C Telegraphy maximum plate dissipation, CCS 60 watts, ICAS 80 watts. Requires Septar 7-contact socket and may be operated in any position. OUTLINE 28, *Outlines* Section. Under operating conditions at maximum ratings, some forced-air cooling will be required to limit the maximum bulb temperature to its specified value. The plate shows no color when the tube is operated at maximum rated plate dissipation under CCS conditions. At maximum rated plate dissipation under ICAS conditions, the plate may show a barely discernible color in a dark room.

	7270	7271	
HEATER VOLTAGE (AC/DC).....	6.3	13.5 { +10%	volts
		{ -20%	
HEATER CURRENT.....	2.85	1.25	amperes
		7270 & 7271	
MU-FACTOR, GRID NO.2 TO GRID NO.1 <sup>■</sup> .....		8.25	
DIRECT INTERELECTRODE CAPACITANCES (Approx.):			
Grid No.1 to plate.....		0.4	μf
Grid No.1 to grid No.2 and internal shield.....		10	μf
Grid No.1 to cathode and heater.....		8	μf
Grid No.2 and internal shield to plate.....		10	μf
Grid No.2 and internal shield to cathode and heater.....		2.2	μf
Plate to cathode and heater.....		0.14	μf
Heater to cathode.....		17	μf
BULB TEMPERATURE (At hottest point).....		250 max	°C

<sup>■</sup> For plate volts, 250; grid-No.2 volts, 250; plate ma., 10.

**AF POWER AMPLIFIER AND MODULATOR—Class AB<sub>1</sub>**

<b>Maximum Ratings:</b>	<i>CCS</i>	<i>ICAS</i>	
DC PLATE VOLTAGE.....	1100 max	1350 max	volts
DC GRID-NO.2 VOLTAGE.....	425 max	425 max	volts
MAXIMUM-SIGNAL DC PLATE CURRENT†.....	340 max	340 max	ma
MAXIMUM-SIGNAL PLATE INPUT‡.....	180 max	250 max	watts
MAXIMUM-SIGNAL GRID-NO.2 INPUT‡.....	20 max	20 max	watts
PLATE DISSIPATION‡.....	60 max	80 max	watts
<b>PEAK HEATER-CATHODE VOLTAGE:</b>			
Heater negative with respect to cathode.....	135 max	135 max	volts
Heater positive with respect to cathode.....	135 max	135 max	volts

**PLATE-MODULATED RF POWER AMPLIFIER—Class C Telephony**

<b>Maximum Ratings:</b>	<i>CCS</i>	<i>ICAS</i>	
DC PLATE VOLTAGE.....	900 max	1100 max	volts
DC GRID-NO.2 VOLTAGE.....	425 max	425 max	volts
DC GRID-NO.1 VOLTAGE.....	-300 max	-300 max	volts
DC PLATE CURRENT.....	280 max	280 max	ma
DC GRID-NO.1 CURRENT.....	25 max	30 max	ma
PLATE INPUT.....	160 max	210 max	watts
GRID-NO.2 INPUT.....	13.5 max	13.5 max	watts
PLATE DISSIPATION.....	40 max	50 max	watts

## RCA Transmitting Tubes

<b>PEAK HEATER-CATHODE VOLTAGE:</b>			
Heater negative with respect to cathode.....	135 max	135 max	volts
Heater positive with respect to cathode.....	135 max	135 max	volts

**Maximum Circuit Values:**

Grid-No.1-Circuit Resistance <sup>o</sup> .....	30000 max	30000 max	ohms
---	-----------	-----------	------

### RF POWER AMPLIFIER AND OSCILLATOR—Class C Telegraphy and

#### RF POWER AMPLIFIER—Class C FM Telephony

**Maximum Ratings:**

	CCS	ICAS	
DC PLATE VOLTAGE.....	1100 max	1350 max	volts
DC GRID-NO.2 VOLTAGE.....	425 max	425 max	volts
DC GRID-NO.1 VOLTAGE.....	-300 max	-300 max	volts
DC PLATE CURRENT.....	340 max	340 max	ma
DC GRID-NO.1 CURRENT.....	25 max	30 max	ma
PLATE INPUT.....	235 max	315 max	watts
GRID-NO.2 INPUT.....	20 max	20 max	watts
PLATE DISSIPATION.....	60 max	80 max	watts
<b>PEAK HEATER-CATHODE VOLTAGE:</b>			
Heater negative with respect to cathode.....	135 max	135 max	volts
Heater positive with respect to cathode.....	135 max	135 max	volts

**Maximum Circuit Values:**

Grid-No.1-Circuit Resistance <sup>o</sup> .....	30000 max	30000 max	ohms
---	-----------	-----------	------

†Averaged over any audio-frequency cycle of sine-wave form.

<sup>o</sup>If this value is insufficient to provide adequate bias, the additional required bias must be supplied by a cathode resistor or fixed supply.

### BEAM POWER TUBE

# 7357

Small, rugged, heater-cathode type used as af power amplifier and modulator and as rf power amplifier and oscillator in applications where dependable performance under severe

shock and vibration is essential. May be used with full input up to 60 Mc and with reduced input up to 175 Mc. Class C Telegraphy maximum plate dissipation, CCS 20 watts, ICAS 25 watts. Requires Octal socket and may be operated in any position. OUTLINE 18, *Outlines* Section. Heater volts (ac/dc), 26.5; amperes, 0.3. Except for heater rating, base, and special ratings and performance, the 7357 is identical with type 6146.

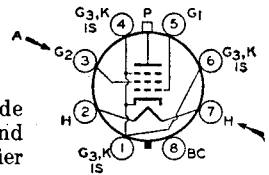

AA'=PLANE OF ELECTRODES

### BEAM POWER TUBE

# 7358

Rugged, heater-cathode type used as rectangular-wave pulse modulator in applications where dependable performance under severe shock and vibration is essential. Rated for service

with duty factors up to 1.0 at a maximum averaging time of 10000 microseconds. Rectangular-wave modulator maximum plate dissipation, 10 watts.

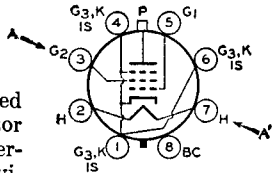

AA'=PLANE OF ELECTRODES

HEATER VOLTAGE (AC/DC).....	6.3	volts
HEATER CURRENT at 6.3 volts.....	1.25	amperes
TRANSCONDUCTANCE <sup>o</sup> .....	7000	μmhos
MU-FACTOR, GRID NO.2 TO GRID NO.1 <sup>o</sup> .....	4.5	
<b>DIRECT INTERELECTRODE CAPACITANCES:</b>		
Grid No.1 to plate.....	0.24 max	μf
Grid No.1 to cathode and grid No.3 and internal shield, grid No.2, base sleeve, and heater.....	13	μf
Plate to cathode and grid No.3 and internal shield, grid No.2, base sleeve, and heater.....	8.5	μf



# Technical Data

BULB TEMPERATURE (At hottest point) . . . . . 220 max °C  
 • For plate volts, 200; grid-No.2 volts, 200; plate ma., 100.

## MODULATOR—Rectangular-Wave Modulation

For duty factor  $\frac{1}{2}$  between 0.001 and 1 and maximum averaging time of 10,000 microseconds in any interval

### Maximum CCS Ratings:

DC PLATE SUPPLY VOLTAGE ( $E_{bb}$ )° . . . . .	See Rating Chart I
INSTANTANEOUS PLATE VOLTAGE . . . . .	115% of $E_{bb}$
DC GRID-NO.2 SUPPLY VOLTAGE° . . . . .	500 max volts
DC GRID-NO.1 SUPPLY VOLTAGE° . . . . .	300 max volts
(Minimum) . . . . .	See Rating Chart I
<b>GRID-NO.1 VOLTAGE:</b>	
Instantaneous-negative value . . . . .	400 max volts
Peak positive value . . . . .	100 max volts
<b>PEAK PLATE CURRENT</b>	
PEAK GRID-NO.2 CURRENT . . . . .	See Rating Chart II
PEAK GRID-NO.1 CURRENT . . . . .	0.75 max ampere
PLATE INPUT . . . . .	0.5 max ampere
GRID-NO.2 INPUT . . . . .	80 max watts
GRID-NO.1 INPUT . . . . .	1.75 max watts
PLATE DISSIPATION . . . . .	0.5 max watt
PEAK HEATER-CATHODE VOLTAGE:	See Rating Chart I
Heater negative with respect to cathode . . . . .	135 max volts
Heater positive with respect to cathode . . . . .	135 max volts

### Maximum Circuit Values:

Grid-No.1-Circuit Resistance . . . . . 30000 max ohms

TYPICAL CHARACTERISTICS

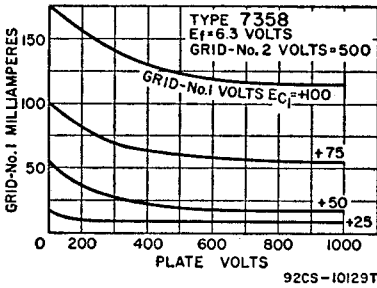

TYPICAL CHARACTERISTICS

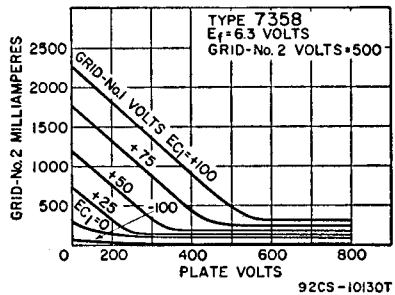

RATING CHART I

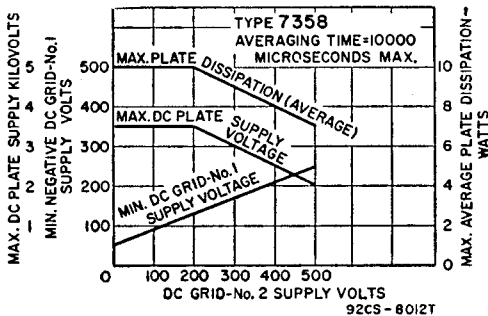

‡ Duty factor for the 7358 is defined as the ON time in microseconds divided by 10,000 microseconds. ON time is defined as the sum of the durations of all the individual pulses which occur during any 10,000-microsecond interval.

Pulse duration is defined as the time interval between the two points on the pulse at which the instantaneous value is 70 per cent of the peak value. The peak value is defined as the maximum value of a smooth curve through the average of the fluctuations over the top portion of the pulse.

° For tube protection, sufficient resistance must be used in the plate supply circuit, the grid-No. 2 supply circuit, and the grid-No.1 supply circuit so that the short-circuit current is limited to 0.5 ampere in each circuit.

▪ Averaged over any interval not exceeding 10,000 microseconds. Care should be used in determining the plate dissipation. A calculated value based on rectangular pulses can be considerably in error when the actual pulses have a finite rise and fall time. Plate dissipation should preferably be determined by measuring the bulb temperature under actual operating conditions; then, with the tube in the same socket and under the same ambient-temperature conditions, apply sufficient dc input to the tube to obtain the same bulb temperature. This value of dc input is a measure of the plate dissipation.

## OPERATING CONSIDERATIONS

Requires Octal socket and may be operated in any position. *OUTLINE 18, Outlines Section.* The bulb becomes hot during operation. To insure adequate cooling, therefore, free circulation of air must be provided around the 7358. The plate shows no color when operated with maximum rated dissipation. Connection to the plate cap should be made with a flexible lead to prevent any strain on the seal of the cap.

For tube protection, sufficient resistance must be used in the plate supply circuit, the grid-No.2 supply circuit, and the grid-No.1 supply circuit so that the short-circuit current is limited to 0.5 ampere in each circuit.

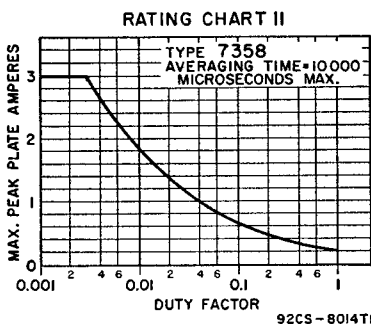

TYPICAL PLATE CHARACTERISTICS

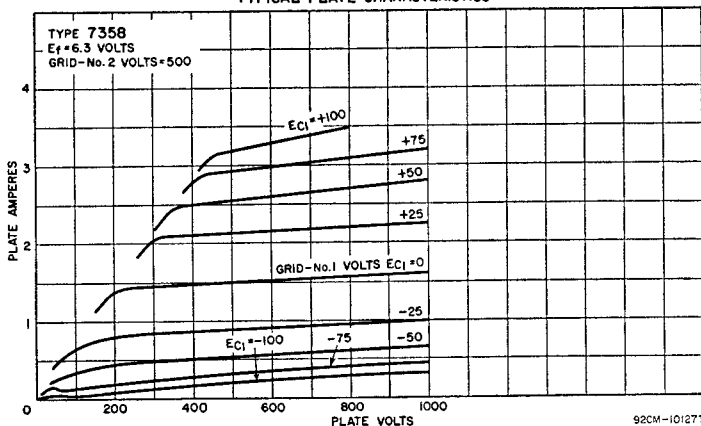

## BEAM-DEFLECTION TUBE

# 7360

Miniature heater-cathode type having unique design and mount structure consisting of two plates, two deflecting electrodes, together with a cathode, grid No.1, and grid No.2.

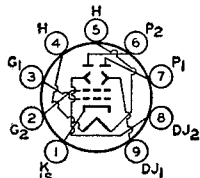

Used for modulator, demodulator, and frequency-converter applications in single- and double-sideband, suppressed-carrier communications equipment operating at frequencies up to 100 Mc; used with single-ended or push-pull input to provide push-pull balanced output; used in low-cost balanced-modulator, balanced-mixer, and product-detector service.

HEATER VOLTAGE (AC/DC).....	6.3	volts
HEATER CURRENT.....	0.35	ampere
DIRECT INTERELECTRODE CAPACITANCES (Approx.): <sup>o</sup>		
Grid No.1 to all other electrodes, except plate.....	7.5	$\mu\text{f}$
Grid No.1 to deflecting electrode No.1.....	0.15	$\mu\text{f}$
Grid No.1 to deflecting electrode No.2.....	0.15	$\mu\text{f}$
Grid No.1 to plate No.1.....	0.003	$\mu\text{f}$
Grid No.1 to plate No.2.....	0.003	$\mu\text{f}$
Plate No.1 to all other electrodes, except deflecting-electrode No.2.....	0.8	$\mu\text{f}$
Plate No.2 to all other electrodes, except deflecting-electrode No.2.....	0.8	$\mu\text{f}$
Plate No.1 to plate No.2.....	0.3	$\mu\text{f}$
Deflecting-electrode No.1 to all other electrodes, except plate No.1.....	4.6	$\mu\text{f}$
Deflecting-electrode No.2 to all other electrodes, except plate No.2.....	4.6	$\mu\text{f}$
Deflecting-electrode No.1 to plate No.1.....	4	$\mu\text{f}$
Deflecting-electrode No.2 to plate No.2.....	4	$\mu\text{f}$
Deflecting-electrode No.1 to deflecting-electrode No.2.....	1.4	$\mu\text{f}$

<sup>o</sup>Without external shield.

**Characteristics, Class A<sub>1</sub> Amplifier:**

Plate-No.1 Supply Voltage.....	150	volts
Plate-No.2 Supply Voltage.....	150	volts
Deflecting-Electrode-No.1 Supply Voltage.....	25	volts
Deflecting-Electrode-No.2 Supply Voltage.....	25	volts
Grid-No.2 Supply Voltage.....	175	volts
Cathode Resistor.....	150	ohms
Total Beam Current (plate-No.1 current plus plate-No.2 current).....	8.5	ma
Grid-No.2 Current.....	2.1	ma
Transconductance:		
Grid No.1 to both plates connected together.....	5400	$\mu\text{mhos}$
Deflecting-electrode No.1 to plate No.1 <sup>▪</sup> .....	800	$\mu\text{mhos}$
Deflecting-electrode No.2 to plate No.2 <sup>▪</sup> .....	800	$\mu\text{mhos}$
Switching Voltage <sup>•</sup> .....	11	volts

<sup>▪</sup> Defined as the partial derivative of the plate current with respect to the difference between the deflecting-electrode voltages, evaluated about the point of equal plate currents.

<sup>•</sup> Defined as the sum of (a) the absolute value of the difference between the deflecting-electrode voltages when the current to one plate is equal to 90 per cent of the total beam current and (b) the absolute value of the difference between the deflecting-electrode voltages when the current to the same plate is equal to 10 per cent of the total beam current. This sum, expressed in terms of signal voltage, corresponds to the peak-to-peak value of signal voltage that is required between the deflecting electrodes to produce peak-to-peak signal current at either plate equal to 80 per cent of the total beam current.

**Maximum Ratings: BALANCED-MODULATOR SERVICE**

PLATE-NO.1 VOLTAGE.....	300 max	volts
PLATE-NO.2 VOLTAGE.....	300 max	volts
DEFLECTING-ELECTRODE NO.1 VOLTAGE.....	$\pm 100$ max	volts
DEFLECTING-ELECTRODE NO.2 VOLTAGE.....	$\pm 100$ max	volts
GRID-NO.2 VOLTAGE.....	250 max	volts
PLATE-NO.1 DISSIPATION.....	1.5 max	watts
PLATE-NO.2 DISSIPATION.....	1.5 max	watts
GRID-NO.2 INPUT.....	0.5 max	watt
PEAK HEATER-CATHODE VOLTAGE:		
Heater negative with respect to cathode.....	180 max	volts
Heater positive with respect to cathode.....	180 <sup>□</sup> max	volts

**Typical Operation:**

*In accompanying balanced-modulator circuit using separate excitation\**

Plate Voltage, Each plate.....	150	volts
Deflecting-Electrode Voltage, Each electrode (Approx.).....	25	volts
Grid-No.2 Voltage.....	175	volts
Cathode Resistor.....	1200	ohms
Peak-to-peak AF Deflecting Electrode Voltage <sup>•••</sup> .....	2.8	volts
Peak-to-peak RF Grid-No.1 Voltage.....	10	volts
Plate Current, Each plate.....	1.5	ma

Grid-No.2 Current .....	0.75	ma
Plate-to-Plate Load Impedance (Approx.) .....	5000	ohms
Push-Pull, Peak-to-Peak, Double-Sideband Output Voltage .....	4	volts
Carrier Suppression† .....	60	db
Third-Order Distortion† .....	-47	db
Fourth-Order Distortion† .....	-45	db

**Maximum Circuit Values:**

Grid-No.1-Circuit Resistance:		
For fixed-bias operation .....	0.5 max	megohm
For cathode-bias operation .....	2.2 max	megohms
Deflecting-Electrode-Circuit Resistance, Each .....	0.05 max	megohm

**Balanced-Modulator Circuit**

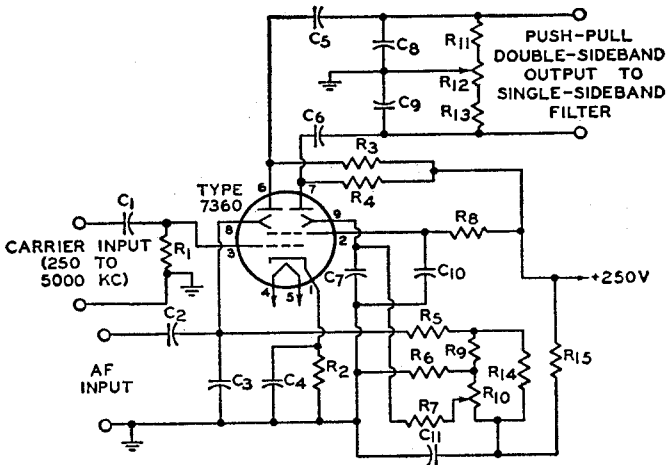

92CS-10258

C <sub>1</sub> : 0.001 μf	R <sub>1</sub> : 0.47 megohm	R <sub>11</sub> : 2700 ohms
C <sub>2</sub> : 0.22 μf	R <sub>2</sub> : 1200 ohms	R <sub>12</sub> : Quadrature Balance
C <sub>3</sub> : 0.001 μf	R <sub>3</sub> , R <sub>4</sub> : 68000 ohms	Potentiometer, 2500 ohms
C <sub>4</sub> : 0.01 μf	R <sub>5</sub> : 47000 ohms	R <sub>13</sub> , R <sub>14</sub> : 2700 ohms
C <sub>5</sub> , C <sub>6</sub> : 0.0033 μf	R <sub>6</sub> : 12000 ohms	R <sub>15</sub> : 0.1 megohm
C <sub>7</sub> : 0.1 μf	R <sub>7</sub> : 47000 ohms	NOTE: All resistors 1/2 watt, ±10
C <sub>8</sub> , C <sub>9</sub> : Sufficient to resonate	R <sub>8</sub> : 0.1 megohm	percent, unless specified. All ca-
Input of SSB filter	R <sub>9</sub> : 2700 ohms	pacitors 400 volts.
C <sub>10</sub> : 0.22 μf	R <sub>10</sub> : Carrier Balance Potenti-	
C <sub>11</sub> : 0.47 μf	ometer, 5000 ohms	

**BALANCED-MIXER SERVICE**

<b>Maximum Ratings:</b>		
PLATE-No.1 VOLTAGE .....	300 max	volts
PLATE-No.2 VOLTAGE .....	300 max	volts
DEFLECTING-ELECTRODE-No.1 VOLTAGE .....	±100 max	volts
DEFLECTING-ELECTRODE-No.2 VOLTAGE .....	±100 max	volts
GRID-No.2 VOLTAGE .....	250 max	volts
PLATE-No.1 DISSIPATION .....	1.5 max	watts
PLATE-No.2 DISSIPATION .....	1.5 max	watts
GRID-No.2 INPUT .....	0.5 max	watt
PEAK HEATER-CATHODE VOLTAGE:		
Heater negative with respect to cathode .....	180 max	volts
Heater positive with respect to cathode .....	180 <sup>□</sup> max	volts

**Typical Operation:**

*In accompanying balanced-mixer circuit using separate excitation\**

Plate Voltage, Each plate .....	150	volts
Deflecting-Electrode Voltage, Each electrode (Approx.) .....	25	volts
Grid-No.2 Voltage .....	175	volts

Cathode Resistor.....	1200	ohms
Peak-to-Peak Single-Sideband Deflecting-Electrode Voltage**	8	volts
Peak-to-Peak RF Grid-No.1 Voltage.....	10	volts
Plate Current, Each plate.....	1.5	ma
Grid-No.2 Current.....	0.75	ma
Plate-to-Plate Load Impedance (Approx.).....	40000	ohms
Push-Pull, Peak-to-Peak, Single-Sideband Output Voltage.....	25	volts
Oscillator Suppression†.....	-40	db
Third-Order Distortion†.....	-40	db
Fourth-Order Distortion†.....	-39	db

### Maximum Circuit Values:

Grid-No.1-Circuit Resistance:		
For fixed-bias operation.....	0.5 max	megohm
For cathode-bias operation.....	2.2 max	megohms
Deflecting-Electrode-Circuit Resistance, Each.....	0.05 max	megohm

### Balanced-Mixer Circuit

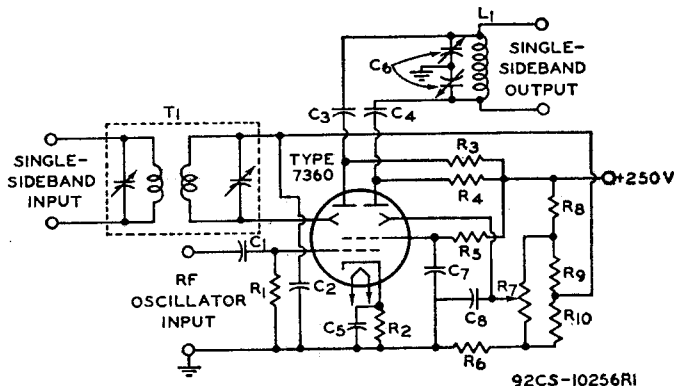

C <sub>1</sub> : 0.001 μf	L <sub>1</sub> : Inductor	ometer, 5000 ohms
C <sub>2</sub> : 0.04 μf	R <sub>1</sub> : 0.47 megohm	R <sub>3</sub> : 0.1 megohm
C <sub>3</sub> , C <sub>4</sub> : 0.001 μf	R <sub>2</sub> : 1200 ohms	R <sub>9</sub> , R <sub>10</sub> : 2700 ohms
C <sub>5</sub> : 0.04 μf	R <sub>3</sub> , R <sub>1</sub> : 68000 ohms	T <sub>1</sub> : Tuned Input Transformer
C <sub>6</sub> : Split-Stator Tuning Capacitor	R <sub>4</sub> : 0.1 megohm	NOTE: All resistors, ½ watt, ±10
to Resonate with L <sub>1</sub>	R <sub>5</sub> : 12000 ohms	percent unless specified; all ca-
C <sub>7</sub> , C <sub>8</sub> : 0.04 μf	R <sub>7</sub> : Oscillator Rejection Potenti-	pacitors 400 volts

†The dc component must not exceed 100 volts.

\*Operation with self-excitation and cathode resistor of 300 ohms is similar to operation with separate excitation.

\*\* To either electrode: the other electrode is bypassed.

† Referred to single-sideband output voltage.

### OPERATING CONSIDERATIONS

OUTLINE 9, *Outlines* Section. Tube requires miniature nine-contact socket and may be operated in any position. To avoid excessive distortion, the plate voltage must be sufficiently high so that the instantaneous plate-voltage excursion does not enter the knee region of the tube characteristic where the grid-No.2 current increases rapidly. A deflecting-electrode voltage in the range of 20 to 35 volts for each electrode is satisfactory for most applications. Some means should be provided for varying one of the deflecting-electrode voltages for balancing purposes. The balance control should allow the positive dc bias voltage to vary approximately ±10 per cent about the mean value. To minimize distortion, the peak signal voltage applied to grid No.1 should be smaller than the grid-No.1 bias voltage so that the instantaneous grid-No.1 voltage never reaches zero.

Deflecting-electrode-circuit resistance should be kept below 50000 ohms to prevent nonlinear tube operation. The resistances of the two deflecting-electrode circuits should be approximately equal to minimize unbalance. The current drawn by each deflecting-electrode is in the order of 40 microamperes.

AVERAGE CHARACTERISTICS

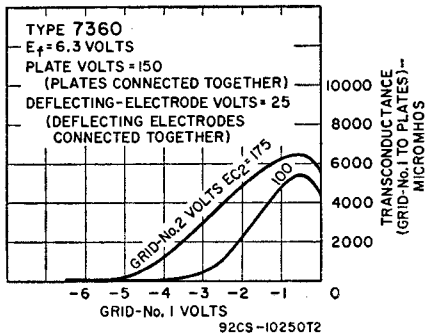

AVERAGE CHARACTERISTICS

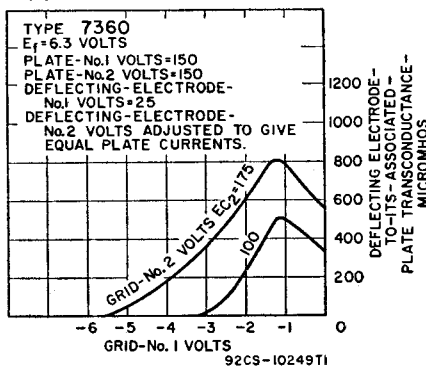

AVERAGE CHARACTERISTICS

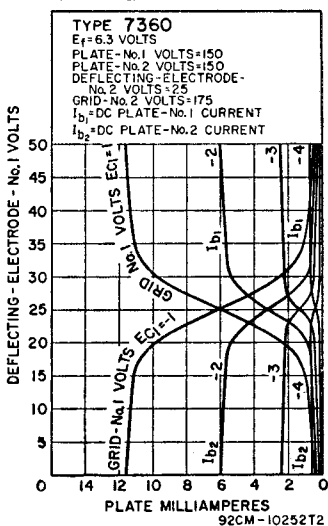

OPERATION CHARACTERISTICS

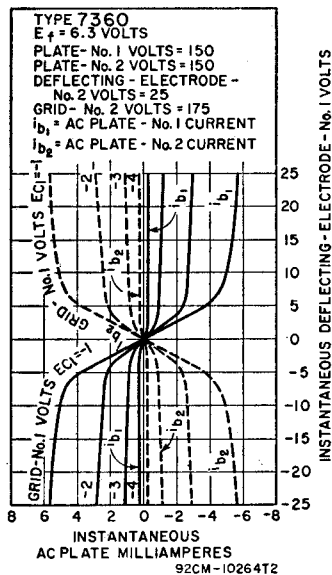

Magnetic fields adversely affect the intrinsic operating plate-current balance of the 7360. Although this tube is internally shielded to minimize this effect, the tube should be mounted as far as possible from all devices producing extraneous magnetic fields such as transformers, chokes, motors, or similar components. It is recommended that an external shield be used in those applications critical for balance.

Chassis layout should be such that all components and wiring associated with the plates and deflecting electrodes are symmetrical. This consideration is particularly important in rf applications where very small differences in stray capacitance can result in unbalance. Chassis layouts which permit heat or vibration to affect the components associated with one deflecting-electrode circuit or plate circuit more than the other should be avoided. All components should be rigidly mounted.

AVERAGE CHARACTERISTICS

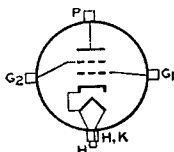
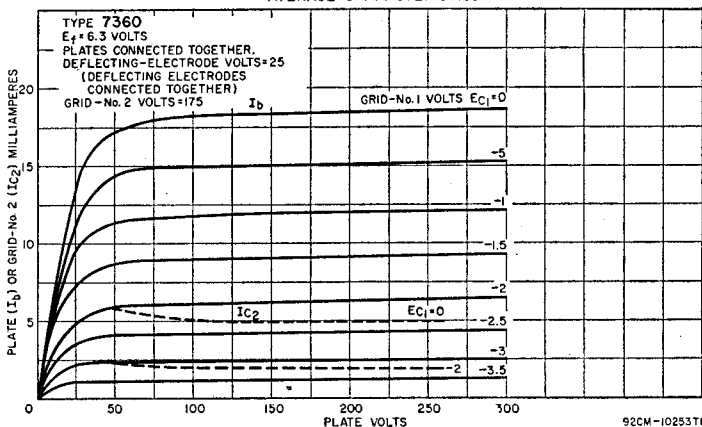

BEAM POWER TUBE

7457

Small, rugged, uhf, forced-air, cooled, heater-cathode, cermolox type used as af power amplifier and modulator, and as rf power amplifier and oscillator in compact mobile and fixed

equipment where dependable performance under severe shock and vibration is essential. Useful at frequencies up to 2000 Mc and beyond. Class C Telegraphy maximum plate dissipation, CCS 115 watts. May be operated in any position. OUTLINE 78, Outlines Section. Except for special ratings and performance data, internal construction, and minor differences in general characteristics as shown below, the 7457 is identical with type 6816. Tube has matrix cathode.

HEATER VOLTAGE (AC/DC) <sup>o</sup> .....	6.3	volts
HEATER CURRENT.....	3.2	amperes
HEATING TIME, MINIMUM.....	60	seconds
MU FACTOR <sup>•</sup> .....	18	
DIRECT INTERELECTRODE CAPACITANCES: <sup>•</sup> .....	6	
Grid No.1 to plate.....	0.065 max	μf
Grid No.1 to cathode and heater.....	14	μf
Plate to cathode and heater.....	0.019 max	μf
Grid No.1 to grid No.2.....	19	μf
Grid No.2 to plate.....	4.5	μf
Grid No.2 to cathode and heater.....	1.3 max	μf

<sup>o</sup>Because the cathode is subjected to considerable back bombardment as the frequency is increased with resultant increase in temperature, the heater voltage should be reduced depending on operating conditions and frequency to prevent overheating the cathode and resultant short life.

<sup>•</sup>For plate volts, 250; grid-No.2 volts, 250; plate ma., 100.

<sup>•</sup>Measured with special shield adapter.

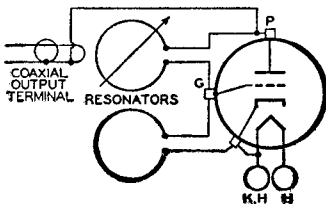

TUNABLE OSCILLATOR TRIODE

7533

Heater-cathode, pencil type having integral resonators; used as uhf oscillator in radiosonde equipment. Tunable at frequencies between 1660 and 1700 Mc. May be used at ambient

temperatures ranging from -55 to +75°C. UHF Oscillator maximum plate dissipation, 3.6 watts.

HEATER VOLTAGE RANGE (AC/DC).....	5.2 to 6.6†	volts
HEATER CURRENT at 6 volts.....	0.16	ampere
FREQUENCY (Approx.).....	1680°	Mc
TUNING RANGE.....	1660 to 1700	Mc
RF COAXIAL OUTPUT TERMINAL: Characteristic impedance (Approx.).....	50	ohms
TUNING SCREWS (2):		
Maximum Torque (Absolute) at tuning-range stops.....	6.5	oz-in.

**UHF OSCILLATOR—Class C**

**Maximum Ratings:**

*At frequencies between 1660 and 1700 Mc and altitudes up to 100,000 feet*

DC PLATE-TO-GRID VOLTAGE.....	130 max	volts
DC PLATE CURRENT.....	34 max	ma
DC GRID CURRENT.....	8 max	ma
PLATE INPUT.....	4 max	watts
PLATE DISSIPATION.....	3.6 max	watts
AMBIENT-TEMPERATURE RANGE.....	-55 to +75	°C

*As cathode-driver oscillator at frequency of*

**Typical Operation:**

	1660 Mc	1680 Mc	1700 Mc	
Heater Voltage.....	6	6	6	volts
DC Plate-to-Grid Voltage.....	124.5	124	123	volts
DC Cathode-to-Grid Voltage.....	7.5	6.75	6	volts
From grid resistor of.....	1500	1500	1500	ohms
DC Cathode Current.....	35	31.5	32	ma
DC Grid Current.....	5	4.5	6	ma
Useful Power Output (Approx.).....	575	575	475	mw

**Circuit Values:**

Grid-Circuit Resistance, maximum.....	2400	ohms
Grid-Circuit Resistance, minimum.....	1300	ohms

† This range of heater voltage is for radiosonde applications in which the heater is supplied from batteries and in which the equipment design requirements of minimum size, light weight, and high efficiency are the primary considerations even though the average life expectancy of the 7533 in such service is only a few hours.

°As supplied, tubes are adjusted to 1680 ± 4 Mc.

**OPERATING CONSIDERATIONS**

Type 7533 may be operated in any position. OUTLINE 75, *Outlines* Section. The flexible heater leads of the 7533 may be soldered to the circuit elements, but not closer than 3/4-inch from the surface of the glass button. Otherwise the heat of the soldering operation may crack the glass button and damage the tube.

Support for the 7533 should be provided by a suitable clamp around the metal shell of the tube, preferably in the indicated zone shown on the dimensional outline. Care must be taken to avoid clamping so tightly as to cause distortion of the resonator cavity with resultant change in operating frequency. Connections to the grid terminal and to the plate terminal should be made by means of spring contacts only. Under no circumstances should connections be soldered to these terminals.

Accurate frequency adjustment in the 1660-to-1700 Mc operating range, together with minimum frequency drift, may be obtained by using both tuning screws. Alternately turn each tuning screw not more than one-half turn at a time, in a clockwise direction, to lower the frequency. Repeat this procedure until the desired lower frequency adjustment is reached. To reach a higher frequency, follow the same procedure except that the tuning screws are turned in a counterclockwise direction.

**BEAM POWER TUBE**

**7551**

Miniature, heater-cathode type used in mobile communications equipment operating from 12-volt storage battery systems. Used in rf amplifier, oscillator, and frequency multiplier

service at frequencies up to 175 Mc; also used in modulator and af power-amplifier

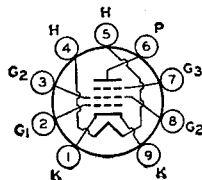



applications. During manufacture, the 7551 is subjected to special controls and tests for heater-cycling, heater-cathode leakage, interelectrode leakage, low-frequency-vibration performance, 500-hour intermittent life performance, and intermittent shorts.

HEATER VOLTAGE RANGE.....	12 to 15	volts
HEATER CURRENT, at 13.5 volts.....	0.36	ampere
DIRECT INTERELECTRODE CAPACITANCES: <sup>o</sup>		
Grid No.1 to Plate.....	0.15 max	μmf
Grid No.1 to Cathode, Heater, Grid No.3, and Grid No.2.....	10	μmf
Plate to Cathode, Heater, Grid No.3, and Grid No.2.....	5.5	μmf

<sup>o</sup> Without external shield.

**Characteristics, Class A<sub>1</sub> Amplifier, with 13.5 Volts on Heater:**

Plate Voltage.....	250	volts
Grid No.3.....	Connected to cathode at socket	
Grid-No.2 Voltage.....	250	volts
Grid-No.1 Voltage.....	-18	volts
Mu-Factor, Grid No.2 to Grid No.1.....	8.7	
Transconductance.....	5300	μmhos
Plate Current.....	40	ma
Grid-No.2 Current.....	3	ma

**AF POWER AMPLIFIER AND MODULATOR—Class AB<sub>1</sub>**

**Maximum CCS Ratings:**

DC PLATE VOLTAGE.....	300 max	volts
Grid No.3.....	Connect to cathode at socket	
DC GRID-NO.2 VOLTAGE.....	250 max	volts
MAXIMUM-SIGNAL DC PLATE CURRENT <sup>o</sup> .....	70 max	ma
MAXIMUM-SIGNAL PLATE INPUT <sup>o</sup> .....	21 max	watts
MAXIMUM-SIGNAL GRID-NO.2 INPUT <sup>o</sup> .....	2 max	watts
PLATE DISSIPATION <sup>o</sup> .....	10 max	watts
PEAK HEATER-CATHODE VOLTAGE:		
Heater negative with respect to cathode.....	100 max	volts
Heater positive with respect to cathode.....	100 max	volts
BULB TEMPERATURE (At hottest point).....	225 max	°C

**Typical CCS Push-Pull Operation With 13.5 Volts on Heater:**

*Values are for two tubes*

DC Plate Voltage.....	300	volts
Grid No.3.....	Connected to cathode at socket	
DC Grid-No.2 Voltage <sup>o</sup> .....	250	volts
DC Grid-No.1 Voltage <sup>o</sup> .....	-21	volts
Peak AF Grid-No.1-to-Grid-No.1 Voltage.....	40	volts
Zero-Signal DC Plate Current.....	40	ma
Maximum-Signal DC Plate Current.....	125	ma
Zero-Signal DC Grid-No.2 Current.....	2	ma
Maximum-Signal DC Grid-No.2 Current.....	14	ma
Effective Load Resistance (Plate to plate).....	5000	ohms
Maximum-Signal Driving Power.....	0	watts
Total Harmonic Distortion.....	5	per cent
Maximum-Signal Power Output (Approx.).....	20.5	watts

**Maximum Circuit Values:**

Grid-No.1-Circuit Resistance.....	0.1 max	megohm
-----------------------------------	---------	--------

**RF POWER AMPLIFIER AND OSCILLATOR—Class C Telephony  
and**

**RF POWER AMPLIFIER—Class C FM Telephony**

<b>Maximum Ratings:</b>	<i>At frequencies up to 175 Mc</i>		
	CCS	ICAS	
DC PLATE VOLTAGE.....	300 max	300 max	volts
GRID NO.3.....	Connect to cathode at socket		
DC GRID-NO.2 VOLTAGE.....	250 max	250 max	volts
DC GRID-NO.1 VOLTAGE.....	-125 max	-125 max	volts
DC PLATE CURRENT.....	70 max	80 max	ma
DC GRID-NO.2 CURRENT.....	15 max	15 max	ma
DC GRID-NO.1 CURRENT.....	5 max	5 max	ma
PLATE INPUT.....	21 max	24 max	watts
GRID-NO.2 INPUT.....	2 max	2 max	watts

## RCA Transmitting Tubes

PLATE DISSIPATION.....	10 max	12 max	watts
PEAK HEATER-CATHODE VOLTAGE:			
Heater negative with respect to cathode.....	100 max	100 max	volts
Heater positive with respect to cathode.....	100 max	100 max	volts
BULB TEMPERATURE (At hottest point).....	225 max	225 max	°C

### Typical Operation With 13.5 Volts on Heater:

	<i>As amplifier at 175 Mc</i>		
	CCS	ICAS	
DC Plate Voltage.....	250	300	300 volts
Grid No.3.....			Connected to cathode at socket
DC Grid-No.2 Voltage <sup>2</sup> .....	200	200	250 volts
DC Grid-No.1 Voltage*.....	-40	-42	-55 volts
Peak RF Grid-No.1 Voltage.....	47	52	62 volts
DC Plate Current.....	60	70	80 ma
DC Grid-No.2 Current.....	3.7	3.7	5.1 ma
DC Grid-No.1 Current (Approx.).....	1.5	2.1	1.6 ma
Driver Power Output (Approx.)**.....	1	1	1.5 watts
Useful Power Output (Approx.)†.....	6.5	8.5	10 watts

### Maximum Circuit Values:

Grid-No.1-Circuit Resistance.....	0.1 max	0.1 max	megohm
-----------------------------------	---------	---------	--------

### PLATE-MODULATED RF POWER AMPLIFIER—Class C Telephony

	<i>At frequencies up to 175 Mc</i>		
	CCS	ICAS	
Maximum Ratings:			
DC PLATE VOLTAGE.....	250 max	250 max	volts
GRID NO.3.....			Connect to cathode at socket
DC GRID-NO.2 VOLTAGE.....	250 max	250 max	volts
DC GRID-NO.1 VOLTAGE.....	-125 max	-125 max	volts
DC PLATE CURRENT.....	60 max	70 max	ma
DC GRID-NO.2 CURRENT.....	10 max	10 max	ma
DC GRID-NO.1 CURRENT.....	5 max	5 max	ma
PLATE INPUT.....	15 max	17.5 max	watts
GRID-NO.2 INPUT.....	1.4 max	1.4 max	watts
PLATE DISSIPATION.....	7 max	8 max	watts
PEAK HEATER-CATHODE VOLTAGE:			
Heater negative with respect to cathode.....	100 max	100 max	volts
Heater positive with respect to cathode.....	100 max	100 max	volts
BULB TEMPERATURE (At hottest point).....	225 max	225 max	°C

### Typical Operation with 13.5 Volts on Heater:

	<i>At 175 Mc</i>		
	CCS	ICAS	
DC Plate Voltage.....	250	250	volts
Grid No.3.....			Connected to cathode at socket
DC Grid-No.2 Voltage*.....	250	250	volts
DC Grid-No.1 Voltage**.....	-70	-75	volts
From a grid-No.1 resistor of.....	33000	33000	ohms
RF Grid-No.1 Voltage.....	75	80	volts
DC Plate Current.....	60	70	ma
DC Grid-No.2 Current.....	2.5	3	ma
DC Grid-No.1 Current (Approx.).....	2.1	2.3	ma
Driving Power (Approx.)**.....	1	1	watt
Useful Power Output†.....	6.5	7.5	watts

### Maximum Circuit Values:

Grid-No.1-Circuit Resistance.....	0.1 max	0.1 max	megohm
-----------------------------------	---------	---------	--------

### FREQUENCY MULTIPLIER

	CCS	ICAS	
Maximum Ratings:			
DC PLATE VOLTAGE.....	300 max	300 max	volts
GRID NO.3.....			Connect to cathode at socket
DC GRID-NO.2 VOLTAGE.....	250 max	250 max	volts
DC GRID-NO.1 VOLTAGE.....	-125 max	-125 max	volts
DC PLATE CURRENT.....	50 max	60 max	ma
DC GRID-NO.2 CURRENT.....	15 max	15 max	ma
DC GRID-NO.1 CURRENT.....	5 max	5 max	ma
PLATE INPUT.....	13 max	15 max	watts
GRID-NO.2 INPUT.....	2 max	2 max	watts
PLATE DISSIPATION.....	10 max	12 max	watts
PEAK HEATER-CATHODE VOLTAGE:			
Heater negative with respect to cathode.....	100 max	100 max	volts
Heater positive with respect to cathode.....	100 max	100 max	volts

# Technical Data

BULB TEMPERATURE (At hottest point)..... 225 max    225 max    °C

### Typical Operation With 13.5 Volts on Heater:

DC Plate Voltage.....	250	300	volts
Grid No.3.....	Connected to cathode at socket		
DC Grid-No.2 Voltage.....	200	250	volts
DC Grid-No.1 Voltage*.....	-53	-66	volts
From a grid-No.1 resistor of.....	53000	44000	ohms
Peak RF Grid-No.1 Voltage.....	60	74	volts
DC Plate Current.....	50	60	ma
DC Grid-No.2 Current.....	2.6	3.5	ma
DC Grid-No.1 Current (Approx.).....	1	1.5	ma
Driving Power (Approx.)**.....	0.4	0.6	watt
Useful Power Output†.....	3	4.5	watts

### As tripler to 175 Mc

DC Plate Voltage.....	200	250	volts
Grid No.3.....	Connected to cathode at socket		
DC Grid-No.2 Voltage.....	200	250	volts
DC Grid-No.1 Voltage.....	-90	-120	volts
From a grid-No.1 resistor of.....	50000	70000	ohms
Peak RF Grid-No.1 Voltage.....	105	130	volts
DC Plate Current.....	50	60	ma
DC Grid-No.2 Current.....	3	3.9	ma
DC Grid-No.1 Current (Approx.).....	1.85	1.7	ma
Driving Power (Approx.)**.....	0.4	0.6	watt
Useful Power Output†.....	1.4	2.3	watts

### Maximum Circuit Values:

Grid-No.1-Circuit Resistance..... 0.1 max    0.1 max    megohm

- Averaged over any audio-frequency cycle of sine-wave form.
- Obtained preferably from a fixed supply.
- Obtained preferably from a separate source or from the plate-voltage supply with a voltage divider. If a series resistor is used, it should be adjustable to permit obtaining the desired operating plate current after initial tuning adjustments are completed.
- \* Obtained from a grid-No.1 resistor or from a combination of grid-No.1 resistor with either fixed supply or cathode resistor.
- \*\* Driver stage is required to supply tube losses and rf circuit losses. The driver stage should be designed to provide an excess of power above the indicated values to take care of variations in line voltage, components, initial tube characteristics, and tube characteristics during life.
- † Measured at load.
- ▲ Obtained preferably from a separate source modulated along with the plate supply, or from the modulated plate supply through a series resistor. It is recommended that this resistor be adjustable to permit obtaining the desired operating plate current after initial tuning adjustments are made.
- ▲▲ Obtained from a grid-No.1 resistor or from a combination of grid-No.1 resistor with either fixed supply or cathode resistor. The combination of grid resistor and fixed supply has the advantage of not only protecting the tube from damage through loss of excitation but also of minimizing distortion by bias-supply compensation.

### AVERAGE CHARACTERISTICS

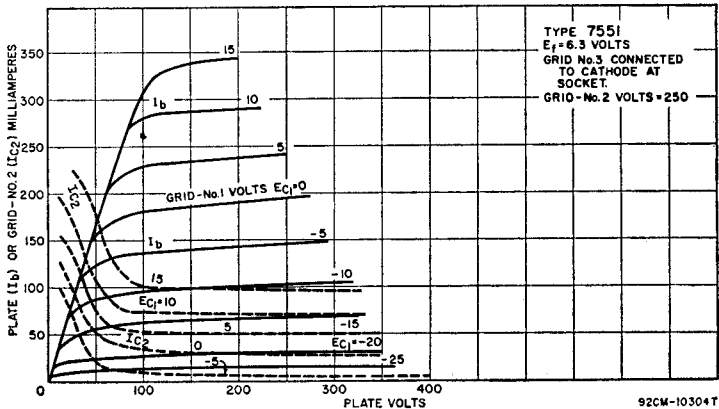

**OPERATING CONSIDERATIONS**

Type 7551 requires Miniature nine-contact socket and may be operated in any position. **OUTLINE 9, Outlines Section.**

Shielding of the 7551 in straight-through rf amplifier service is required for stable operation. To minimize external feedback from the plate to grid No.1, a grounded shield crossing the terminal end of the tube socket through the space between pins 2 and 3 and the space between pins 8 and 9, is generally adequate for this purpose.

The heater may be effectively bypassed by grounding one heater pin at the tube socket and by passing the other heater pin to ground with a low inductance capacitor. To reduce degeneration in the cathode circuit, two base-pin connections (pins 1 and 9) are provided. The cathode circuit should be arranged so that the input ac current flows through one cathode connection and the output ac current flows through the other. This circuit arrangement will reduce the effect of the cathode lead inductance. Both cathode circuit returns should be grounded through the shortest possible connection.

The rf impedance between grid No.2 and the cathode must be kept low, usually by means of a suitable bypass capacitor. In telephony service when grid No.2 is

modulated, a smaller base bypass capacitor than is used for telegraphy service may be required to avoid excessive af bypassing. However, if the capacitance value is too small, rf feedback may occur between plate and grid No.1, depending on the circuit layout, operating frequency, and power gain of the stage. AF bypassing difficulties can usually be eliminated if the grid-No.2 bypass capacitor is replaced by a series-resonant circuit which is tuned to resonate at the operating frequency. This circuit presents a high impedance to audio frequencies but a very low impedance to its resonant frequency.

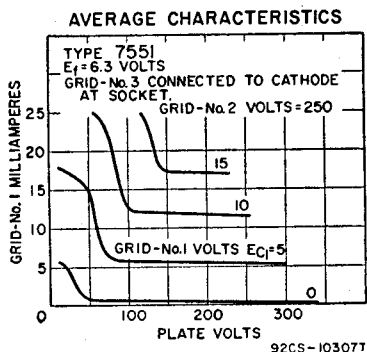

**HIGH-MU TRIODE**

**7552**

Heater-cathode, ceramic-metal, pencil type used as a low-noise amplifier in receiver applications up to 1500 Mc. It is also useful in applications requiring fast warm-up time and in

equipment where dependable service under severe environmental conditions and long life are essential.

HEATER VOLTAGE (AC/DC) .....	6.3	volts
HEATER CURRENT at 6.3 volts .....	0.225	ampere
CATHODE WARM-UP TIME (Average, to reach 80% of operating plate current: for heater volts, 6.3; dc plate supply volts, 80; dc grid volts, 0; cathode resistor, 0 ohms, load resistor, 10 ohms) .....	10	seconds
<b>DIRECT INTERELECTRODE CAPACITANCES:</b>		
Grid to plate .....	2.4	$\mu\mu\text{f}$
Grid to cathode and heater .....	4.4	$\mu\mu\text{f}$
Plate to cathode and heater .....	0.04 max	$\mu\mu\text{f}$
Heater to cathode .....	2.6	$\mu\mu\text{f}$
Cathode to plate .....	0.04 max	$\mu\mu\text{f}$
Cathode to grid and heater .....	7	$\mu\mu\text{f}$
Plate to grid and heater .....	2.0	$\mu\mu\text{f}$
PLATE SEAL TEMPERATURE .....	225 max	$^{\circ}\text{C}$

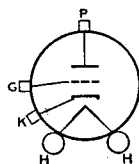

## Characteristics, Class A<sub>1</sub> Amplifier:

Plate Voltage.....	125	volts
Cathode Resistor.....	50	ohms
Amplification Factor.....	80	
Plate Resistance (Approx.).....	6000	ohms
Transconductance.....	13500	$\mu$ mhos
Plate Current.....	13	ma

## RF AMPLIFIER—Class A<sub>1</sub>

**Maximum CCS Ratings:** *For altitudes up to 100,000 feet and frequencies up to 1500 Mc*

DC PLATE VOLTAGE.....	250 max	volts
DC GRID VOLTAGE.....	-50 max	volts
DC PLATE CURRENT.....	25 max	ma
PLATE DISSIPATION.....	2.5 max	watts
<b>PEAK HEATER-CATHODE VOLTAGE:</b>		
Heater negative with respect to cathode.....	50 max	volts
Heater positive with respect to cathode.....	50 max	volts

**Typical CCS Operation in Cathode-Drive Circuits:**

	<i>At 550 Mc with 5 Mc Bandwidth</i>	<i>At 1100 Mc with 10 Mc Bandwidth</i>	
DC Plate-to-Grid Voltage.....	125	150	volts
Cathode Resistor.....	50	50	ohms
Input Signal Level Range.....	-70 to -20	-70 to -20	dbm
DC Plate Current.....	13	13.5	ma
Power Gain.....	16.5	16	db
Noise Figure.....	6.5	12.5	db

**Maximum Circuit Values:**

<b>Grid-Circuit Resistance:</b>		
For fixed-bias operation.....		Not recommended
For cathode-bias operation.....		0.25 max megohm

## OPERATING CONSIDERATIONS

Type 7552 may be operated in any position. OUTLINE 68, *Outlines* Section. Connections to the cathode cylinder, grid flange, and plate cylinder should be made by flexible spring contacts. The connectors should make firm, large-surface contact, yet must be sufficiently flexible to insure that no part of the tube is subjected to excessive strain.

The cathode should preferably be connected to one side of the heater. When, in some circuit designs, the heater is not connected directly to the cathode, precautions must be taken to hold the peak heater-cathode voltage within the maximum rated values. For curve of average plate characteristics in cathode-drive service, refer to type 7553.

**GAIN CHARACTERISTICS**  
CATHODE-DRIVE SERVICE

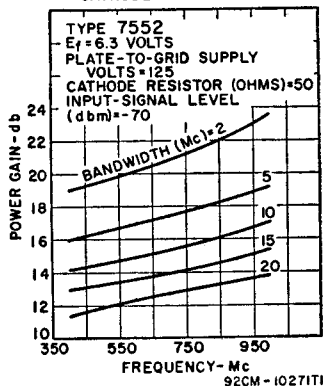

**NOISE FIGURE CHARACTERISTIC**  
CATHODE-DRIVE-SERVICE

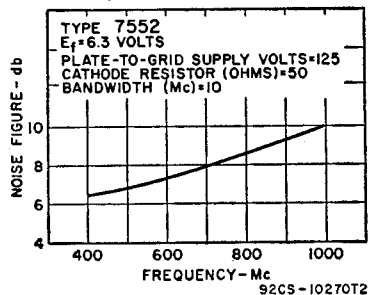

### HIGH-MU TRIODE

# 7553

Heater-cathode, ceramic-metal, pencil type used as a low-noise amplifier in receiver applications up to 1500 Mc. It is also useful in applications requiring fast warm-up time and in

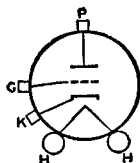

equipment where dependable service under severe environmental conditions and long life are essential. The 7553 is similar to type 7552, but has superior performance and environmental features. Type 7553 may be operated in any position. OUTLINE 68, *Outlines* Section. For other considerations, refer to type 7552.

HEATER VOLTAGE (AC/DC).....	6.3	volts
HEATER CURRENT at 6.3 volts.....	0.225	ampere
CATHODE WARM-UP TIME to reach 80% of operating plate current†.....	10 max	seconds
DIRECT INTERELECTRODE CAPACITANCES:‡		
Grid to plate.....	2.4	$\mu\text{f}$
Grid to cathode and heater.....	4.4	$\mu\text{f}$
Plate to cathode and heater.....	0.03 max	$\mu\text{f}$
Heater to cathode.....	2.6	$\mu\text{f}$
Cathode to plate.....	0.03 max	$\mu\text{f}$
Cathode to grid and heater.....	7	$\mu\text{f}$
Plate to grid and heater.....	2.4	$\mu\text{f}$
PLATE SEAL TEMPERATURE.....	225 max	$^{\circ}\text{C}$

† For heater volts, 6.3; dc plate volts, 80; dc grid volts, 0; cathode resistor, 0 ohms.

‡ Without external shield.

AVERAGE PLATE CHARACTERISTICS  
CATHODE-DRIVE SERVICE

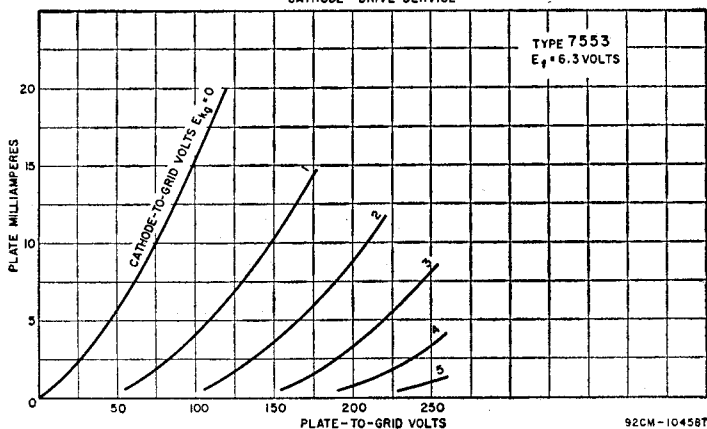

NOISE FIGURE CHARACTERISTICS  
CATHODE DRIVE-SERVICE

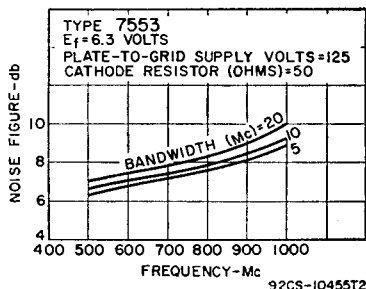

GAIN CHARACTERISTICS  
CATHODE-DRIVE SERVICE

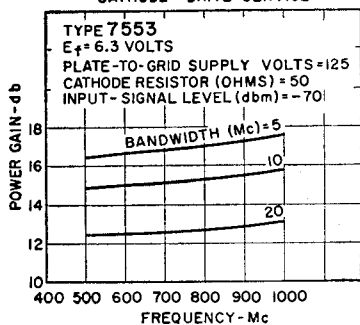

**Characteristics, Class A<sub>1</sub> Amplifier:**

Plate Voltage.....	125	volts
Cathode Resistor.....	50	ohms
Amplification Factor.....	80	
Plate Resistance (Approx.).....	6150	ohms
Transconductance.....	13000	μmhos
Plate Current.....	12.5	ma

**RF AMPLIFIER—Class A<sub>1</sub>**

**Maximum CCS Ratings:** *For altitudes up to 100,000 feet and frequencies up to 1500 Mc*

DC PLATE VOLTAGE.....	250 <i>max</i>	volts
DC GRID VOLTAGE.....	-50 <i>max</i>	volts
DC PLATE CURRENT.....	25 <i>max</i>	ma
PLATE DISSIPATION.....	2.5 <i>max</i>	watts
<b>PEAK HEATER-CATHODE VOLTAGE:</b>		
Heater negative with respect to cathode.....	50 <i>max</i>	volts
Heater positive with respect to cathode.....	50 <i>max</i>	volts

**Typical CCS Operation in Cathode-Drive Circuit:**

	<i>At 550 Mc</i>	<i>At 1100 Mc</i>	
DC Plate-to-Grid Voltage.....	125	150	volts
Cathode Resistor.....	50	50	ohms
Input-Signal Level Range.....	-70 to -20	-70 to -20	dbm
DC Plate Current.....	12.5	14	ma
<b>Power Gain for bandwidth of:</b>			
4 Mc.....	-	20	db
5 Mc.....	16.5	-	db
8 Mc.....	-	18	db
Noise Figure.....	6.5	11.5	db

**Maximum Circuit Values:**

<b>Grid-Circuit Resistance:</b>		
For fixed-bias operation.....		Not recommended
For cathode-bias operation.....		0.25 <i>max</i> megohm

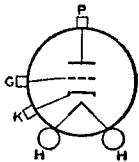

**HIGH-MU TRIODE**

Heater-cathode, ceramic-metal, pencil type used as rf amplifier, oscillator, and multiplier in airborne equipment up to 100,000 feet without pressurization and where dependable performance under severe shock and vibration is essential. Useful with full input at frequencies up to 5000 Mc. Class C Telegraphy maximum plate dissipation, CCS 2.5 watts.

7554

HEATER VOLTAGE (AC/DC).....	6.3	volts
HEATER CURRENT at 6.3 volts.....	0.225	ampere
CATHODE WARM-UP TIME to reach 80% of operating plate current†.....	10	seconds
<b>DIRECT INTERELECTRODE CAPACITANCES:‡</b>		
Grid to plate.....	2.4	μμf
Grid to cathode and heater.....	4.4	μμf
Plate to cathode and heater.....	0.04 <i>max</i>	μμf
Heater to cathode.....	2.6	μμf
Cathode to plate.....	0.04 <i>max</i>	μμf
Cathode to grid and heater.....	7	μμf
Plate to grid and heater.....	2.4	μμf
PLATE-SEAL TEMPERATURE.....	225 <i>max</i>	°C

† For heater volts, 6.3; dc plate volts, 80; grid volts, 0; cathode resistor, 0 ohms; load resistor, 10 ohms.

‡ Without external shield.

**Characteristics, Class A<sub>1</sub> Amplifier:**

Plate Voltage.....	125	volts
Cathode Resistor.....	50	ohms
Amplification Factor.....	70	
Plate Resistance (Approx.).....	4400	ohms
Transconductance.....	16000	μmhos
Plate Current.....	14	ma

# RCA Transmitting Tubes

## RF POWER AMPLIFIER AND OSCILLATOR—Class C Telegraphy

and

## RF POWER AMPLIFIER—Class C FM Telephony

At frequencies up to 5000 Mc and altitudes:

Maximum CCS Ratings:	Up to 80,000 feet	Between 80,000 and 100,000 feet	
DC PLATE VOLTAGE.....	250 max	200 max	volts
DC GRID VOLTAGE.....	-50 max	-50 max	volts
DC CATHODE CURRENT.....	25 max	25 max	ma
DC GRID CURRENT.....	6 max	6 max	ma
PLATE DISSIPATION.....	2.5 max	2.5 max	watts
<b>PEAK HEATER-CATHODE VOLTAGE:</b>			
Heater negative with respect to cathode.....	50 max	50 max	volts
Heater positive with respect to cathode.....	50 max	50 max	volts

### Typical CCS Operation in Cathode-Drive Circuit:

<i>As oscillator</i>						
	At 500 Mc	At 1000 Mc	At 2000 Mc	At 3000 Mc	At 4150 Mc	
DC-Plate-to-Grid Voltage.....	205	203	151	125	200	volts
DC Cathode-to-Grid Voltage.....	5	3	1	0.1	0.26	volts
From a grid resistor of.....	1000	600	250	500	130	ohms
DC Cathode Current.....	21	24	24	20	23	ma
DC Grid Current.....	5	5	4	0.2	2	ma
Useful Power Output (Approx.).....	1.6	1.3	0.5	0.15	0.1	watts
<i>As amplifier</i>						
	At 500 Mc	At 1000 Mc				
DC Plate-to-Grid Voltage.....	204	185				volts
DC Cathode-to-Grid Voltage.....	4	10				volts
From a grid resistor of.....	800	2000				ohms
DC Cathode Current.....	21	24				ma
DC Grid Current.....	5	5				ma
Driver Power Output (Approx.).....	0.2	0.2				watt
Useful Power Output (Approx.).....	2.2	1.4				watts

### Maximum Circuit Values:

Grid-Circuit Resistance.....	0.25 max	megohm
------------------------------	----------	--------

## FREQUENCY DOUBLER—Class C

At frequencies up to 2000 Mc and altitudes:

Maximum CCS Ratings:	Up to 80,000 feet	Between 80,000 and 100,000 feet	
DC PLATE VOLTAGE.....	250 max	200 max	volts
DC GRID VOLTAGE.....	-50 max	-50 max	volts
DC CATHODE CURRENT.....	22 max	22 max	ma
DC GRID CURRENT.....	6 max	6 max	ma
PLATE DISSIPATION.....	2.5 max	2.5 max	watts

### Typical CCS Operation in Cathode-Drive Circuit:

	Up to 550 Mc	Up to 1000 Mc			
DC Plate-to-Grid Voltage.....	193	207	218	181	volts
DC Cathode-to-Grid Voltage.....	18	7	18	6	volts
From a grid resistor of.....	3600	2300	2600	2000	ohms
DC Cathode Current.....	20	18	21	19	ma
DC Grid Current.....	5	3	5	3	ma
Driver Power Output (Approx.).....	0.8	0.2	0.8	0.2	watt
Useful Power Output (Approx.).....	1.3	0.75	0.9	0.4	watts

### Maximum Circuit Values:

Grid-Circuit Resistance.....	0.25 max	megohm
------------------------------	----------	--------

## FREQUENCY TRIPLER—Class C

At frequencies up to 2000 Mc and altitudes:

Maximum CCS Ratings:	Up to 80,000 feet	Between 80,000 and 100,000 feet	
DC PLATE VOLTAGE.....	250 max	200 max	volts
DC GRID VOLTAGE.....	-50 max	-50 max	volts
DC CATHODE CURRENT.....	20 max	20 max	ma
DC GRID CURRENT.....	6 max	6 max	ma
PLATE DISSIPATION.....	2.5 max	2.5 max	watts



**Typical CCS Operation in Cathode-Drive Circuit:**

	<i>Up to 645 Mc</i>		
DC Plate-to-Grid Voltage.....	202	240	volts
DC Cathode-to-Grid Voltage.....	27	15	volts
From a grid resistor of.....	9000	25000	ohms
DC Cathode Current.....	19	13	ma
DC Grid Current.....	3	0.6	ma
Driver Power Output (Approx.).....	0.6	0.2	watt
Useful Power Output (Approx.).....	0.7	0.4	watt
	<i>Up to 1000 Mc</i>		
DC Plate-to-Grid Voltage.....	205	185	volts
DC Cathode-to-Grid Voltage.....	30	10	volts
From a grid resistor of.....	10000	14000	ohms
DC Cathode Current.....	19	12	ma
DC Grid Current.....	3	0.7	ma
Driver Power Output (Approx.).....	0.6	0.2	watt
Useful Power Output (Approx.).....	0.4	0.15	watt

**Maximum Circuit Values:**

Grid-Circuit Resistance.....	0.25	megohm
------------------------------	------	--------

**OPERATING CONSIDERATIONS**

Type 7554 may be operated in any position. OUTLINE 68, *Outlines* Section. Connections to the cathode cylinder, grid flange, and plate cylinder should be made by flexible spring contacts. The connectors should make firm, large-surface contact, yet must be sufficiently flexible to insure that no part of the tube is subjected to excessive strain.

**AVERAGE CHARACTERISTICS  
CATHODE-DRIVE SERVICE**

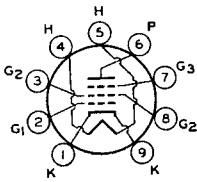
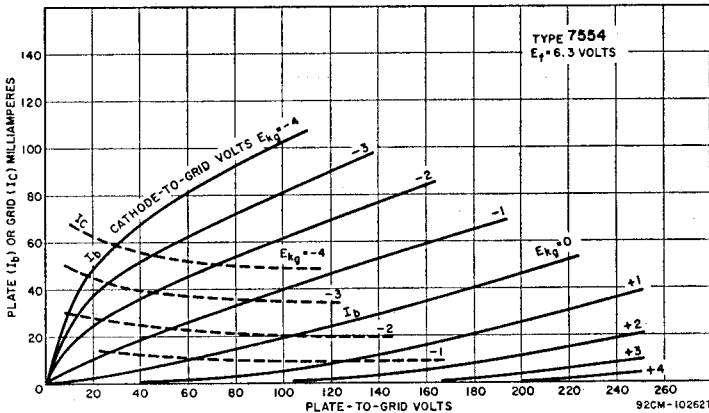

**BEAM POWER TUBE**

Miniature, heater-cathode type used in fixed-station communications equipment; used in Class C rf amplifier, oscillator, and frequency-multiplier service; also used in modulator

7558

and af power-amplifier applications. Requires Miniature, nine-contact socket and may be operated in any position. OUTLINE 9, *Outlines* Section. Heater volts, 6.3; amperes, 0.8; characteristics range (with 6.3 volts on heater): heater amperes, 0.745 *min*, 0.855 *max*. Except for heater ratings, the 7558 is electrically identical with type 7551; the characteristics curves shown for type 7551 also apply to the 7558. For mobile applications, use type 7551.

# 7580

**BEAM POWER TUBE**  
 Ceramic-metal, forced-air-cooled, heater-cathode type used as a linear rf power amplifier for Single-Sideband Suppressed-Carrier and AM Telephony service in compact mobile and fixed

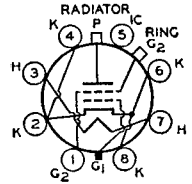

equipment. May be used with full input up to 500 Mc. Maximum plate dissipation for either service, CCS 250 watts.

HEATER VOLTAGE (AC/DC) †	6	volts
HEATER CURRENT at 6 volts	2.6	amperes
MINIMUM HEATING TIME	30	seconds
MU-FACTOR, GRID No.2 To GRID No.1 †	4	
DIRECT INTERELECTRODE CAPACITANCES (Approx.):°		
Grid No.1 to plate	0.03	μμf
Grid No.1 to cathode, grid No.2, and heater	17	μμf
Plate to cathode, grid No.2, and heater	4.5	μμf
PLATE TEMPERATURE (Measured on base end of plate surface at junction with fins)	250 max	°C
TEMPERATURE OF PLATE SEAL, GRID No.2 SEAL, AND BASE SEALS	250 max	°C

† For grid-No.2 volts, 300; grid-No.2 ma., 50.

**LINEAR RF POWER AMPLIFIER**  
**Single-Sideband Suppressed-Carrier Service**

*Peak envelope conditions for a signal having a minimum peak-to-average power ratio of 2*

<b>Maximum CCS Ratings:</b> <i>For altitudes up to 20,000 feet and frequencies up to 500 Mc</i>		
DC PLATE VOLTAGE	2000 max	volts
DC GRID-NO.2 VOLTAGE	500 max	volts
DC GRID-NO.1 VOLTAGE	-250 max	volts
DC PLATE CURRENT AT PEAK OF ENVELOPE	350 max	ma
PLATE DISSIPATION	250 max	watts
GRID-NO.2 INPUT	12 max	watts
<b>PEAK HEATER-CATHODE VOLTAGE:</b>		
Heater negative with respect to cathode	150 max	volts
Heater positive with respect to cathode	150 max	volts

<b>Typical CCS Operation with Two-Tone Modulation:°</b>		
	<i>At 30 Mc</i>	<i>At 500 Mc</i>
DC Plate Voltage	2000	2000
DC Grid-No.2 Voltage <sup>2</sup>	400	400
DC Grid-No.1: With fixed bias source	-77	-77
Zero-Signal DC Plate Current	70	70
Effective RF Load Resistance	3050	3050
DC Plate Current:		
Peak envelope	350	350
Average	225	225
DC Grid-No.2 Current:		
Peak envelope	35	25
Average	16	10
Average DC Grid-No.1 Current*	0.05	0.05
Peak-Envelope Driver Power Output (Approx.)*	1	12
Output-Circuit Efficiency (Approx.)	95	85
<b>Distortion Products Level:#</b>		
Third order	21	—
Fifth order	29	—
<b>Useful Power Output (Approx.):</b>		
Peak envelope**	400	360
Average**	200	180

**Maximum Circuit Values:**

<b>Grid-No.1-Circuit Resistance, Under any condition:</b>		
With fixed bias	25000 max	ohms
With cathode bias		Not recommended

**LINEAR RF POWER AMPLIFIER—AM Telephony**

<b>Maximum CCS Ratings:</b> <i>For altitudes up to 20,000 feet and frequencies up to 550 Mc</i>		
DC PLATE VOLTAGE	2000 max	volts
DC GRID-NO.2 VOLTAGE	500 max	volts

## Technical Data

DC GRID-NO.1 VOLTAGE.....	-250 <i>max</i>	volts
DC PLATE CURRENT.....	180 <i>max</i>	ma
PLATE DISSIPATION.....	250 <i>max</i>	watts
GRID-NO.2 INPUT.....	12 <i>max</i>	watts
GRID-NO.1 INPUT.....	2 <i>max</i>	watts
PEAK HEATER-CATHODE VOLTAGE:		
Heater negative with respect to cathode.....	150 <i>max</i>	volts
Heater positive with respect to cathode.....	150 <i>max</i>	volts

<b>Typical CCS Operation:</b>	<i>At 30 Mc</i>	<i>At 500 Mc</i>	
DC Plate Voltage.....	2000	2000	volts
DC Grid-No.2 Voltage <sup>□</sup> .....	400	400	volts
DC Grid-No.1 Voltage:			
With fixed-bias source.....	-77	-77	volts
DC Plate Current.....	175	175	ma
DC Grid-No.2 Current.....	6	4	ma
Effective RF Load Resistance.....	3050	3050	ohms
Driver Power Output (Approx.) <sup>*</sup> .....	0.25	3	watts
Output-Circuit Efficiency (Approx.).....	95	85	per cent
Useful Power Output (Approx.) <sup>**</sup> .....	100	90	watts

**Maximum Circuit Values:**

Grid-No.1-Circuit Resistance, Under any condition:	
With fixed bias.....	25000 <i>max</i> ohms
With cathode bias.....	Not recommended

† Because the cathode is subjected to considerable back bombardment as the frequency is increased with resultant increase in temperature, the heater voltage should be reduced depending on operating conditions and frequency to prevent overheating the cathode and resultant short life.

□ With cylindrical shield JEDEC No.320 surrounding radiator, and with a cylindrical shield JEDEC No.321 surrounding the grid-No.2 ring terminal. Both shields are connected to ground.

\* The maximum rating for a signal having a minimum peak-to-average power ratio less than 2, such as is obtained in Single-Tone operation, is 250 ma. During short periods of circuit adjustment under Single-Tone conditions, the average plate current may be as high as 350 ma.

• Two-Tone Modulation operation refers to that class of amplifier service in which the input consists of two equal monofrequency rf signals having constant amplitude. These signals are produced in a single-side-band suppressed-carrier system when two equal-and-constant amplitude audio frequencies are applied to the input of the system.

□ Obtained preferably from a fixed supply.

\* This value represents the approximate grid-No.1 current obtained due to initial electron velocities and contact-potential effects when grid No.1 is driven to zero volts at maximum signal.

† Driver power output represents circuit losses and is the actual power measured at input to grid-No.1 circuit of the 7580. The actual power required depends on the operating frequency and the circuit used. The tube driving power is approximately zero watts.

‡ Without the use of feedback to enhance linearity.

\*\* This value of useful power is measured at load of output circuit having indicated efficiency.

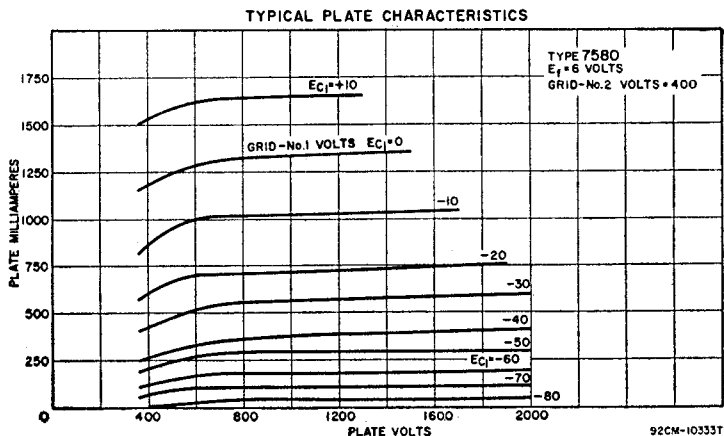

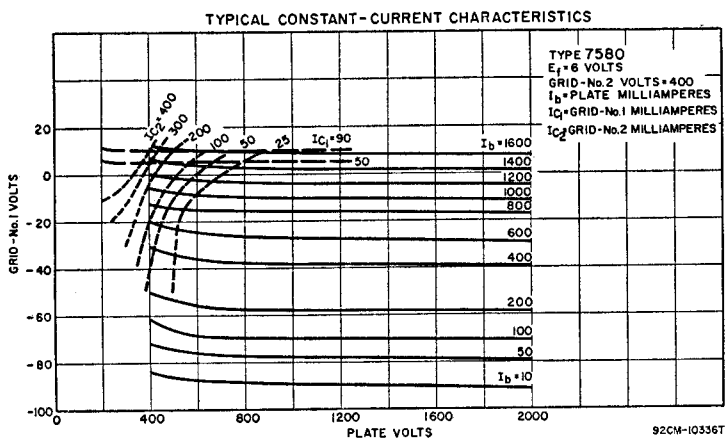
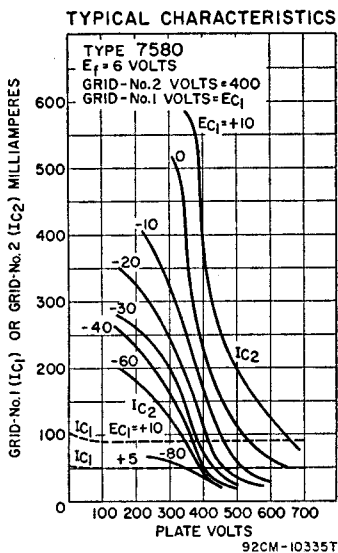

### OPERATING CONSIDERATIONS

Type 7580 may be operated in any position. *OUTLINE 83, Outlines Section.* It is essential that adequate cooling air be directed over the base seals, past the envelope, and through the radiator. Under these conditions and with the tube operating at maximum plate dissipation for each class of service, a minimum air flow of 3.6 cfm must pass through the radiator. The corresponding pressure drop is approximately 0.1 inch of water. These requirements are for operation at sea level and at an ambient temperature of 20 C. At higher altitudes and ambient temperatures, the air flow must be increased to maintain the respective seal temperatures and the plate temperature within maximum ratings. Less air flow is needed if an air-system socket is used to direct the flow of air through the radiator.

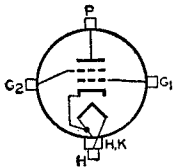

## BEAM POWER TUBE

# 7649

Small, rugged, uhf, forced-air-cooled, heater-cathode, cermolox type used as rf pulsed-power amplifier in compact mobile and fixed equipment where dependable performance under severe

shock and vibration is essential. Useful at frequencies up to 2000 Mc and beyond. Plate-and-Screen-Pulsed RF Amplifier maximum average plate dissipation, CCS 115 watts; maximum pulse duration, 10 microseconds during any 1000-microsecond interval. Tube has matrix-type cathode.

HEATER VOLTAGE (AC/DC) .....	6.3	volts
HEATER CURRENT at 6.3 volts .....	3.2	amperes
MINIMUM HEATING TIME .....	60	seconds
MU-FACTOR, GRID No.2 to GRID No.1 <sup>□</sup> .....	18	
<b>DIRECT INTERELECTRODE CAPACITANCES:†</b>		
Grid No.1 to plate .....	0.13	max $\mu\mu\text{f}$
Grid No.1 to cathode and heater .....	14	$\mu\mu\text{f}$
Plate to cathode and heater .....	0.019	max $\mu\mu\text{f}$
Grid No.1 to grid No.2 .....	20	$\mu\mu\text{f}$
Grid No.2 to plate .....	6.5	$\mu\mu\text{f}$
Grid No.2 to cathode and heater .....	1.3	max $\mu\mu\text{f}$
TERMINAL TEMPERATURE (Plate, grid No.2, grid No.1, cathode, and heater)	250	max $^{\circ}\text{C}$

<sup>□</sup> For plate volts, 1000; grid-No.2 volts, 500; plate ma., 115.

### GRID-AND-SCREEN-PULSED RF AMPLIFIER

*For maximum ON time<sup>o</sup> of 10 microseconds*

**Maximum CCS Ratings:**

DC PLATE VOLTAGE .....	2250	max	volts
PEAK POSITIVE PULSE-GRID-NO.2 VOLTAGE .....	750	max	volts
DC GRID-NO.1 VOLTAGE .....	-200	max	volts
DC PLATE CURRENT DURING PULSE .....	3000	max	ma
DC PLATE CURRENT .....	80	max	ma
GRID-NO.2 INPUT (Average) .....	4.5	max	watts
GRID-NO.1 INPUT (Average) .....	2	max	watts
PLATE DISSIPATION (Average) .....	115	max	watts

**Typical Operation:**

*In Class-AB<sub>2</sub> cathode-drive<sup>o</sup> circuit with rectangular-wave pulses at 1215 Mc and with duty factor<sup>o</sup> of 0.01*

DC Plate Voltage .....	1350	1500	volts
Peak Positive-Pulse Grid-No.2 Voltage .....	700	700	volts
DC Grid-No.1 Voltage .....	0	0	volts
DC Plate Current, during pulse .....	2700	3000	ma
DC Plate Current .....	47	53	ma
DC Grid-No.2 Current .....	1.6	2	ma
DC Grid-No.1 Current .....	5	5	ma
Driver Power Output at peak of pulse (Approx.) <sup>o</sup> .....	390	4600	watts
Useful Power Output at peak of pulse (Approx.) <sup>o</sup> .....	1600	2300	watts

**Maximum Circuit Values:**

Grid-No.1-Circuit Resistance, Under any condition .....	30000	max	ohms
---	-------	-----	------

### PLATE-AND-SCREEN-PULSED RF AMPLIFIER

**Maximum CCS Ratings:**

*For maximum ON time<sup>o</sup> of 10 microseconds*

PEAK POSITIVE-PULSE PLATE VOLTAGE .....	3000	max	volts
PEAK POSITIVE-PULSE GRID-NO.2 VOLTAGE .....	750	max	volts
DC GRID-NO.1 VOLTAGE .....	-200	max	volts
DC PLATE CURRENT DURING PULSE .....	3000	max	ma
DC PLATE CURRENT .....	50	max	ma
GRID-NO.2 INPUT (Average) .....	4.5	max	watts
GRID-NO.1 INPUT (Average) .....	2.0	max	watts
PLATE DISSIPATION (Average) .....	115	max	watts

**Typical Operation:**

*In Class AB<sub>2</sub> cathode-drive<sup>o</sup> circuit with rectangular-wave pulses at 1215 Mc and with duty factor<sup>o</sup> of 0.01*

Peak Positive-Pulse Plate Voltage .....	2700	3000	volts
---	------	------	-------

Peak Positive-Pulse Grid-No.2 Voltage.....	700	700	volts
DC Grid-No.1 Voltage.....	0	0	volts
DC Plate Current during pulse.....	2700	3000	ma
DC Plate Current.....	32	35	ma
DC Grid-No.2 Current.....	1	2	ma
DC Grid-No.1 Current.....	9	8	ma
Driver Power Output at peak of pulse (Approx.) <sup>a</sup> .....	350	450	watts
Useful Power Output at peak of pulse (Approx.) <sup>*</sup> .....	3700	4500	watts

**Maximum Circuit Values:**

Grid-No.1-Circuit Resistance, Under any condition..... 30000 *max* ohms

‡ Measured with special shield adapter.

° ON time is defined as the sum of the duration of all the individual pulses which occur during any 1000-microsecond interval. An increase in dc plate current during the pulse may be permissible at shorter ON times, and a decrease is usually required at longer ON times. Pulse duration is defined as the time interval between the two points on the pulse at which the instantaneous value is 70 per cent of the peak value. The peak value is defined as the maximum value of a smooth curve through the average of the fluctuations over the top portion of the pulse.

▪ Cathode is at dc ground potential.

• Duty factor is defined as the ratio of ON time to total elapsed time in any 1000-microsecond interval.

<sup>a</sup> Driver power output includes circuit losses and feed-through power. It is actual power measured at input to the tube drive circuit. It will vary with frequency of operation and driver circuitry.

<sup>\*</sup>This value of useful power is measured in load of output circuit.

## OPERATING CONSIDERATIONS

Type 7649 may be operated in any position. OUTLINE 78, *Outlines* Section. Adequate forced-air cooling must be provided to limit the terminal temperatures to their specified values. Typical cooling requirements are shown in the accompanying graph; air flow requirements may be reduced by placing a suitable cowling around the radiator to direct the air flow through radiator. Air flow should be effected before and during the application of plate, grid-No.2, and grid-No.1 voltages. Plate power, grid-No.2 power, and air flow may be removed simultaneously. Cooling air is not normally required when only heater voltage is applied to the tube.

### TYPICAL COOLING REQUIREMENTS

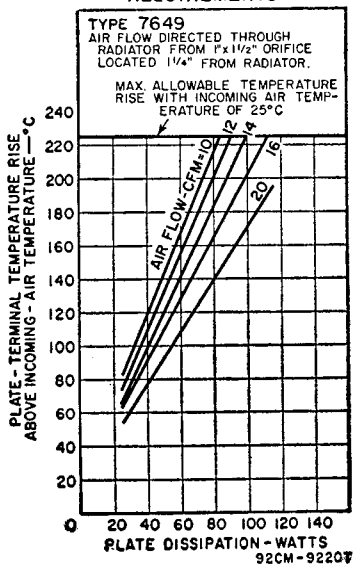

### TYPICAL CHARACTERISTICS

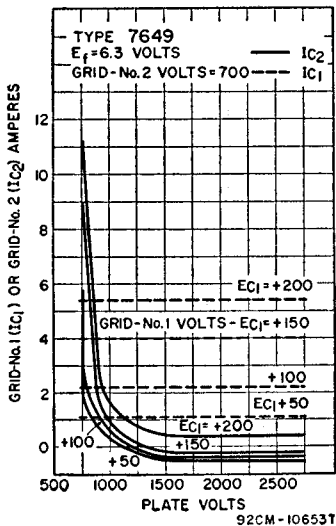

TYPICAL PLATE CHARACTERISTICS

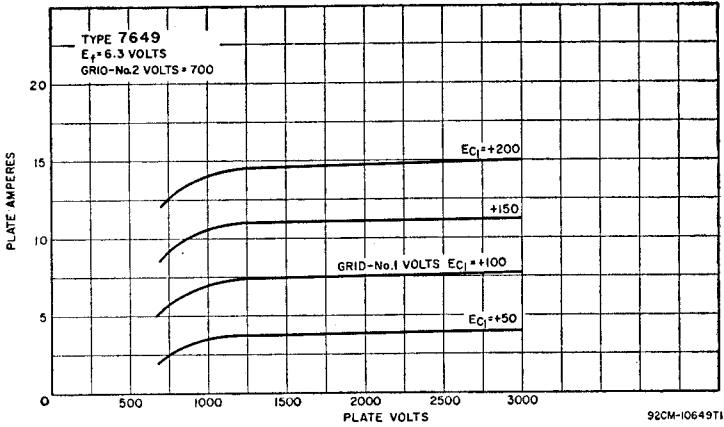

92CM-10649T1

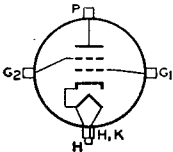

**BEAM POWER TUBE**

**7650**

Rugged, uhf, forced-air-cooled, heater-cathode, cermolox type used as af power amplifier and modulator and as rf power amplifier and oscillator in compact mobile and fixed equipment

where dependable performance under severe shock and vibration is essential. May be useful with full input at frequencies up to 1215 Mc and higher. Class C Telegraphy maximum plate dissipation, CCS 700 watts. Tube has matrix-type cathode.

HEATER VOLTAGE (AC/DC)†	6.3	volts
HEATER CURRENT AT 6.3 volts	7.85	amperes
MINIMUM HEATING TIME	120	seconds
MU-FACTOR, GRID-NO.2 TO GRID NO.1*	13	
DIRECT INTERELECTRODE CAPACITANCES:‡		
Grid No.1 to plate	0.011 max	μμf
Grid No.1 to cathode and heater	29	μμf
Plate to cathode and heater	0.011 max	μμf
Grid No.1 to grid No.2	37	μμf
Grid No.2 to plate	5.3	μμf
Grid No.2 to cathode and heater	1.1 max	μμf
PLATE-CORE TEMPERATURE	250 max	°C
TERMINAL TEMPERATURE		
(Plate, Grid No.2, Grid No.1, Cathode, and Heater)	250 max	°C

\*For plate volts, 225; grid-No.2 volts, 225; and plate ma., 100.

**AF POWER AMPLIFIER AND MODULATOR—Class AB<sub>1</sub>**

**Maximum CCS Ratings:**

DC PLATE VOLTAGE	3000 max	volts
DC GRID-NO.2 VOLTAGE	1200 max	volts
MAXIMUM-SIGNAL DC PLATE CURRENT <sup>§</sup>	500 max	ma
MAXIMUM-SIGNAL GRID-NO.1 CURRENT <sup>§</sup>	100 max	ma
MAXIMUM-SIGNAL PLATE INPUT <sup>§</sup>	1500 max	watts
MAXIMUM-SIGNAL GRID-NO.2 INPUT <sup>§</sup>	25 max	watts
PLATE DISSIPATION <sup>§</sup>	600 max	watts

**Typical CCS Operation:**

<i>Values are for 2 tubes</i>			
DC Plate Voltage	2700	3000	volts
DC Grid-No.2 Voltage <sup>¶</sup>	450	450	volts
DC Grid-No.1 Voltage from fixed-bias source	-40	-40	volts
Peak AF Grid-No.1-to-Grid-No.1 Voltage	80	80	volts
Zero-Signal DC Plate Current	200	200	ma

# RCA Transmitting Tubes

Maximum-Signal DC Plate Current.....	900	1000	ma
Zero-Signal DC Grid-No.2 Current.....	0	0	ma
Maximum-Signal DC Grid-No.2 Current.....	6	5	ma
Effective Load Resistance (Plate to plate).....	6000	6400	ohms
Maximum-Signal Driving Power (Approx.).....	0	0	watts
Maximum-Signal Power Output (Approx.).....	1400	1600	watts

### Maximum Circuit Values:

Grid-No.1-Circuit Resistance, Under any condition:			
With fixed bias.....		15000 max	ohms
With cathode bias.....			Not recommended

### LINEAR RF POWER AMPLIFIER

*Single-Sideband Suppressed-Carrier Service*

<b>Maximum CCS Ratings:</b>		<i>Up to 1215 Mc</i>	
DC PLATE VOLTAGE.....		2500 max	volts
DC GRID-No.2 VOLTAGE.....		1200 max	volts
MAXIMUM-SIGNAL DC PLATE CURRENT.....		500 max	ma
MAXIMUM-SIGNAL DC GRID-No.1 CURRENT.....		100 max	ma
MAXIMUM-SIGNAL PLATE INPUT.....		1250 max	watts
MAXIMUM-SIGNAL GRID-No.2 INPUT.....		25 max	watts
PLATE DISSIPATION.....		600 max	watts

### Typical CCS Operation with Two-Tone Modulation:†

		<i>At 30 Mc</i>	
DC Plate Voltage.....	2250	2500	volts
DC Grid-No.2 Voltage*.....	450	450	volts
DC Grid-No.1 Voltage*.....	-37	-37	volts
Zero-Signal DC Plate Current.....	160	160	ma
Effective RF Load Resistance.....	2500	2700	ohms
DC Plate Current at Peak of Envelope.....	450	500	ma
Average DC Plate Current.....	315	350	ma
DC Grid-No.2 Current at Peak of Envelope.....	3	4	ma
Average DC Grid-No.2 Current.....	1.8	2.5	ma
Average DC Grid-No.1 Current.....	0.005	0.05	ma
Peak-Envelope Driver Power (Approx.).....	1	1	watt
Output-Circuit Efficiency (Approx.).....	90	90	%
Distortion Products Level:▲▲			
Third Order.....	-31	-31	db
Fifth Order.....	-36	-36	db
Useful Power Output (Approx.):			
Average.....	290	340	watts
Peak Envelope□.....	580	680	watts

†Two-Tone Modulation operation refers to that class of amplifier service in which the input consists of two monofrequency rf signals having equal peak amplitude.

▲▲With maximum signal output used as a reference, and without the use of feedback to enhance linearity.

### PLATE-MODULATED RF POWER AMPLIFIER—Class C Telephony

<b>Maximum CCS Ratings:</b>		<i>Up to 1215 Mc</i>	
DC PLATE VOLTAGE.....		2000 max	volts
DC GRID-No.2 VOLTAGE.....		1200 max	volts
DC GRID-No.1 VOLTAGE.....		-250 max	volts
DC PLATE CURRENT.....		500 max	ma
DC GRID-No.1 CURRENT.....		100 max	ma
PLATE INPUT.....		1000 max	watts
GRID-No.2 INPUT.....		17 max	watts
PLATE DISSIPATION.....		400 max	watts

### Typical CCS Operation:

		<i>In cathode-drive* circuit at 400 Mc</i>	
DC Plate Voltage.....	1800	2000	volts
DC Grid-No.2 Voltage*.....	400	400	volts
DC Grid-No.1 Voltage#.....	-45	-35	volts
DC Plate Current.....	450	500	ma
DC Grid-No.2 Current.....	6	8	ma
DC Grid-No.1 Current (Approx.).....	15	12	ma
Output-Circuit Efficiency (Approx.).....	80	80	%
Driver Power Output (Approx.)**.....	35	35	watts
Useful Power Output (Approx.)□.....	500	500	watts

### Maximum Circuit Values:

Grid-No.1-Circuit Resistance, Under any condition.....		15000 max	ohms
--	--	-----------	------



## RF POWER AMPLIFIER AND OSCILLATOR—Class C Telegraphy and RF POWER AMPLIFIER—Class C FM Telephony

<b>Maximum CCS Ratings:</b>	<i>Up to 1215 Mc</i>	
DC PLATE VOLTAGE . . . . .	2500 <i>max</i>	volts
DC GRID-NO.2 VOLTAGE . . . . .	1200 <i>max</i>	volts
DC GRID-NO.1 VOLTAGE . . . . .	-250 <i>max</i>	volts
DC PLATE CURRENT . . . . .	500 <i>max</i>	ma
DC GRID-NO.1 CURRENT . . . . .	100 <i>max</i>	ma
PLATE INPUT . . . . .	1250 <i>max</i>	watts
GRID-NO.2 INPUT . . . . .	25 <i>max</i>	watts
PLATE DISSIPATION . . . . .	700 <i>max</i>	watts

<b>Typical CCS Operation:</b>	<i>In cathode-drive<sup>a</sup> circuit</i>	<i>At 400 Mc</i>	<i>At 1215 Mc</i>	
DC Plate Voltage . . . . .		2250	2500	volts
DC Grid-No.2 Voltage <sup>Ⓞ</sup> . . . . .		400	400	volts
DC Grid-No.1 Voltage . . . . .		-45	-35	volts
DC Plate Current . . . . .		450	500	ma
DC Grid-No.2 Current . . . . .		7	8	ma
DC Grid-No.1 Current (Approx.) . . . . .		10	12	ma
Output-Circuit Efficiency (Approx.) . . . . .		80	80	per cent
Driver Power Output (Approx.)** . . . . .		30	35	watts
Useful Power Output (Approx.) <sup>□</sup> . . . . .		650	800	watts

**Maximum Circuit Values:**

Grid-No.1-Circuit Resistance, Under any condition:	
With fixed bias . . . . .	15000 <i>max</i> ohms
With cathode bias . . . . .	Not recommended

† Because the cathode is subjected to considerable back bombardment as the frequency is increased with resultant increase in temperature, the heater voltage should be reduced depending on operating conditions and frequency to prevent overheating the cathode and resultant short life.

Ⓞ Measured with special shield adapter.

▪ Averaged over any audio-frequency cycle of sine-wave form.

• Preferably obtained from a fixed supply.

□ This value of useful power is measured in load of output circuit.

▲ Cathode is at dc ground potential.

\* Obtained preferably from a separate source modulated along with the plate supply.

# Obtained from grid-No.1 resistor or from a combination of grid-No.1 resistor with either fixed supply or cathode resistor.

\*\* Driver power output includes circuit losses and feed-through power. It is the actual power measured at input to drive circuit.

Ⓞ Obtained preferably from a fixed supply, or from the plate supply voltage with a voltage divider.

### OPERATING CONSIDERATIONS

Type 7650 may be operated in any position. OUTLINE 84, *Outlines* Section. Adequate forced-air cooling must be provided to limit the plate core and terminal temperatures to their specific values. Typical values of air flow directed through

TYPICAL PLATE CHARACTERISTICS

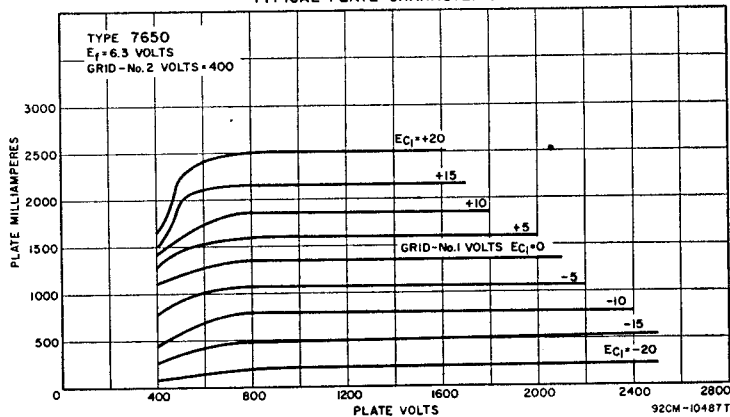

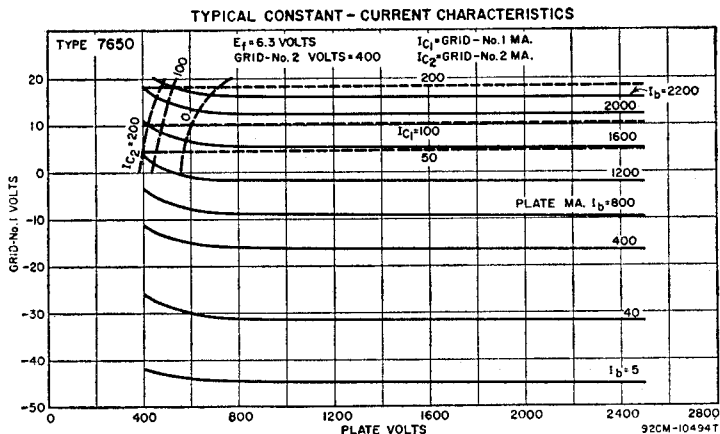
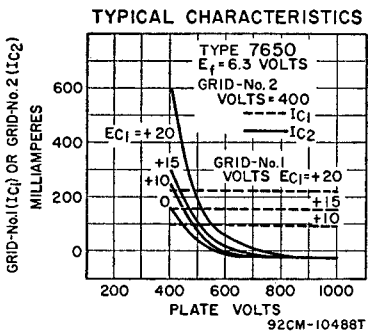

the radiator to maintain the plate core at 250 C with an incoming air temperature of 25 C and with no restrictions at the plate-contact flange are:

Plate Dissipation	100	300	600	700	watts
Air Flow	2	4	11	16	cu ft/min
Static Pressure	0.04	0.14	0.66	0.96	in. water

A sufficient quantity of air should be directed at the heater terminal and allowed to flow past each of the terminals so that no terminal temperature exceeds the specified maximum value of 250 C; an air flow of 2.5 cfm is usually adequate. Forced-air cooling of heater and cathode terminals is usually required during standby (heater only) operation. Air flow may be removed simultaneously with all voltages.

### BEAM POWER TUBE

# 7651

Rugged, uhf, forced-air-cooled, heater-cathode, cermolox type used as rf-pulse power amplifier in compact mobile and fixed equipment where dependable performance under severe

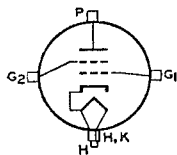

shock and vibration is essential. May be used with full input up to 1215 Mc, and with reduced efficiency at higher frequencies. Plate-and-Screen Pulsed RF Amplifier maximum average plate dissipation, CCS 600 watts; maximum pulse duration, 10 microseconds in any 1000-microsecond interval. Tube has matrix-type cathode.

## Technical Data

HEATER VOLTAGE (AC/DC) .....	6.3	volts
HEATER CURRENT at 6.3 volts .....	7.5	amperes
MINIMUM HEATING TIME .....	120	seconds
MU-FACTOR, GRID-NO.2 TO GRID NO.1* .....	13	
DIRECT INTERELECTRODE CAPACITANCES:†		
Grid No.1 to plate .....	0.13 max	μf
Grid No.1 to cathode and heater .....	29	μf
Plate to cathode and heater .....	0.01 max	μf
Grid No.1 to grid No.2 .....	38	μf
Grid No.2 to plate .....	6.5	μf
Grid No.2 to cathode and heater .....	0.8 max	μf
PLATE-CORE TEMPERATURE .....	250 max	°C
TERMINAL TEMPERATURE (Plate, Grid No.2, Grid No.1, Cathode, and Heater)	250 max	°C

\* For plate volts, 225; grid-No.2 volts, 225; plate ma., 100.

### GRID-PULSED RF AMPLIFIER and GRID-AND-SCREEN-PULSED RF AMPLIFIER

*For maximum ON time<sup>o</sup> of 10 microseconds*

Maximum CCS Ratings:	<i>Up to 1215 Mc</i>	
DC PLATE VOLTAGE .....	5000 max	volts
PEAK POSITIVE-PULSE GRID-NO.2 VOLTAGE .....	1200 max	volts
DC GRID-NO.1 VOLTAGE .....	-250 max	volts
DC PLATE CURRENT DURING PULSE .....	9 max	amperes
DC PLATE CURRENT .....	0.5 max	ampere
GRID-NO.2 INPUT (Average) .....	25 max	watts
GRID-NO.1 INPUT (Average) .....	10 max	watts
PLATE DISSIPATION (Average) .....	600 max	watts

#### Typical Operation:

*In grid-pulsed cathode-drive<sup>o</sup> circuit with rectangular-wave pulse at 1215 Mc and with duty factor<sup>o</sup> of 0.01*

DC Plate Voltage .....	3600	4000	volts
Peak Positive-Pulse Grid-No.2 Voltage .....	800	1000	volts
DC Grid-No.1 Voltage .....	-100	-120	volts
DC Plate Current during pulse .....	8	9	amperes
DC Plate Current .....	0.19	0.2	ampere
DC Grid-No.2 Current .....	0.005	0.006	ampere
DC Grid-No.1 Current .....	0.02	0.02	ampere
Output-Circuit Efficiency (Approx.) .....	80	80	per cent
Driver Power Output at peak of pulse (Approx.) <sup>□</sup> .....	5.2	6.3	kw
Useful Power Output at peak of pulse (Approx.) <sup>▲</sup> .....	15	20	kw

*In grid-and-screen-pulsed cathode-drive<sup>o</sup> circuit with rectangular-wave pulses at 1215 Mc with duty factor<sup>o</sup> of 0.01*

DC Plate Voltage .....	3600	4000	volts
Peak Positive-Pulse Grid-No.2 Voltage .....	800	1000	volts
DC Grid-No.1 Voltage .....	0	0	volts
DC Plate Current during pulse .....	8	9	amperes
DC Plate Current .....	0.145	0.165	ampere
DC Grid-No.2 Current .....	0.003	0.006	ampere
DC Grid-No.1 Current .....	0.017	0.017	ampere
Output-Circuit Efficiency (Approx.) .....	80	80	ampere
Driver Power Output at peak of pulse (Approx.) <sup>□</sup> .....	2.4	2.9	kw
Useful Power Output at peak of pulse (Approx.) <sup>▲</sup> .....	11	15	kw

### PLATE-AND-SCREEN-PULSED RF AMPLIFIER

*For maximum ON time<sup>o</sup> of 10 microseconds*

Maximum CCS Ratings:	<i>Up to 1215 Mc</i>	
PEAK POSITIVE-PULSE PLATE VOLTAGE .....	8000 max	volts
PEAK POSITIVE-PULSE GRID-NO.2 VOLTAGE .....	1200 max	volts
DC GRID-NO.1 VOLTAGE .....	-250 max	volts
DC PLATE CURRENT DURING PULSE .....	9 max	amperes
DC PLATE CURRENT .....	0.12 max	ampere
GRID-NO.2 INPUT (Average) .....	25 max	watts
GRID-NO.1 INPUT (Average) .....	10 max	watts
PLATE DISSIPATION (Average) .....	600 max	watts

### TYPICAL PLATE CHARACTERISTICS

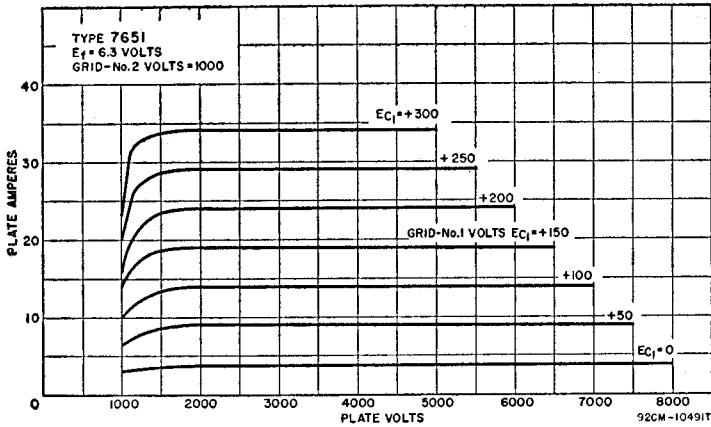

### TYPICAL CHARACTERISTICS

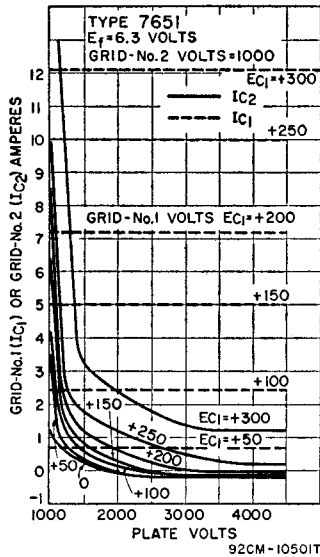

#### Typical Operation.

*In cathode-drive<sup>o</sup> circuit with rectangular-wave pulses at 1215 Mc and with duty factor<sup>o</sup> of 0.01*

Peak Positive-Pulse Plate Voltage.....	7200	8000	7200	8000	volts
Peak Positive-Pulse Grid-No.2 Voltage.....	800	1000	800	1000	volts
DC Grid-No.1 Voltage.....	0	0	-75	-80	volts
DC Plate Current during pulse.....	8	9	8	9	amperes
DC Grid-No.2 Current.....	0.09	0.1	0.09	0.1	ampere
DC Grid-No.1 Current.....	0.003	0.008	0.003	0.004	ampere
DC Grid-No.1 Current.....	0.015	0.016	0.019	0.02	ampere
Output-Circuit Efficiency (Approx.).....	80	80	80	80	per cent
Driver Power Output at peak of pulse (Approx.) <sup>o</sup>	1.8	2.2	4.5	5.3	kw
Useful Power Output at peak of pulse (Approx.) <sup>*</sup>	22	28	30	39	kw

† Measured with special shield adapter.

<sup>o</sup> ON time is defined as the sum of the durations of all the individual pulses which occur during any 1000-microsecond interval. An increase in dc plate current during the pulse may be permissible at shorter ON times, and a decrease is usually required at longer ON times.

*Pulse duration* is defined as the time interval between the two points on the pulse at which the instantaneous value is 70 per cent of the peak value. The peak value is defined as the maximum value of a smooth curve through the average of the fluctuations over the top portion of the pulse.

- Cathode is at dc ground potential.
- Duty factor is defined as the ratio of ON time to total elapsed time in any 1000-microsecond interval.
- Driver power output includes circuit losses and feed-through power. It is actual power measured at input to tube drive circuit. It will vary with frequency of operation and driver circuitry.
- This value of useful power is measured in load of output circuit.

**OPERATING CONSIDERATIONS**

Type 7651 may be operated in any position. OUTLINE 84, *Outlines* Section. Within its maximum ratings, forced-air cooling considerations for the 7651 are identical with those given under *Operating Considerations* for Type 7650.

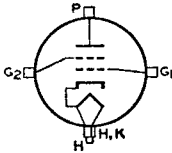

**BEAM POWER TUBE**

Very small, uhf, conduction-cooled, heater-cathode, cermolox type used as rf power amplifier and oscillator in compact mobile and fixed equipment where the use of air may not be

**7801**

practical. May be useful at frequencies up to 3000 Mc and beyond. Class C Telegraphy maximum plate input, CCS 52.5 watts. Type 7801 may be operated in any position. OUTLINE 76, *Outlines* Section. For thermal considerations, refer to *Power Tube Installation Section*.

HEATER VOLTAGE (AC/DC)†	12.6	volts
HEATER CURRENT at 12.6 volts	0.5	ampere
MINIMUM HEATING TIME	40	seconds
MU-FACTOR, GRID No.2 To GRID No.1#	30	
DIRECT INTERELECTRODE CAPACITANCES:°		
Grid No.1 to plate	0.025 max	μf
Grid No.1 to cathode and heater	9.5	μf
Plate to cathode and heater	0.004 max	μf
Grid No.1 to grid No.2	17	μf
Grid No.2 to plate	2.2	μf
Grid No.2 to cathode and heater	0.18 max	μf
TERMINAL TEMPERATURE (Plate, grid No.2, grid No.1, cathode, and heater)	250 max	°C

# For plate volts, 250; grid-No.2 volts, 250; plate ma., 35.

**RF POWER AMPLIFIER AND OSCILLATOR—Class C Telegraphy  
and  
RF POWER AMPLIFIER—Class C FM Telephony**

**Maximum CCS Ratings:**

DC PLATE VOLTAGE	750 max	volts
DC GRID-No.2 VOLTAGE	250 max	volts
DC GRID-No.1 VOLTAGE	-100 max	volts
DC PLATE CURRENT	70 max	ma
DC GRID-No.1 CURRENT	15 max	ma
PLATE INPUT	52.5 max	watts
GRID-No.2 INPUT	2 max	watts
PLATE DISSIPATION	•	

**Typical CCS Operation in Cathode-Drive Circuit:**

*Shown graphically in the following three charts:*

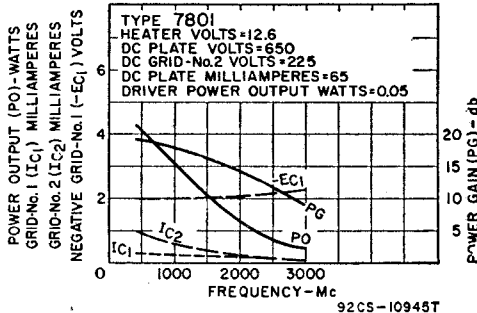

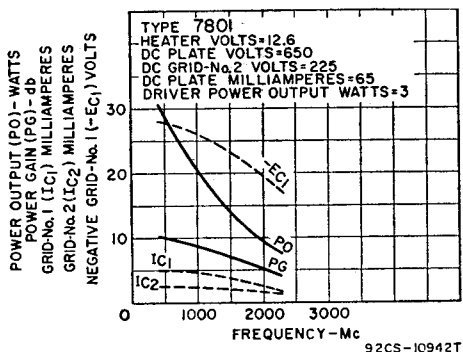
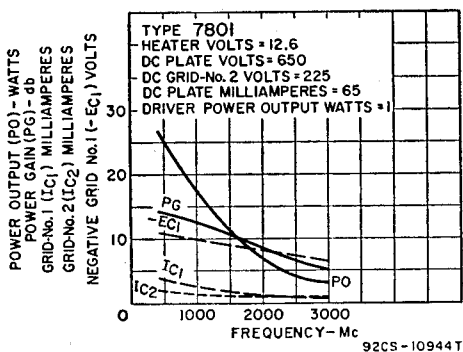

### PLATE-MODULATED RF POWER AMPLIFIER—Class C Telephony

*Carrier conditions per tube for use with a maximum modulation factor of 1*

#### Maximum CCS Ratings:

DC PLATE VOLTAGE.....	750 max	volts
DC GRID-No.2 VOLTAGE.....	250 max	volts
DC GRID-No.1 VOLTAGE.....	-100 max	volts
DC PLATE CURRENT.....	60 max	ma
DC GRID-No.1 CURRENT.....	15 max	ma
PLATE INPUT.....	45 max	watts
GRID-No.2 INPUT.....	2 max	watts
PLATE DISSIPATION.....	•	

#### Typical CCS Operation in Cathode-Drive Circuit:

*Shown graphically in the following chart:*

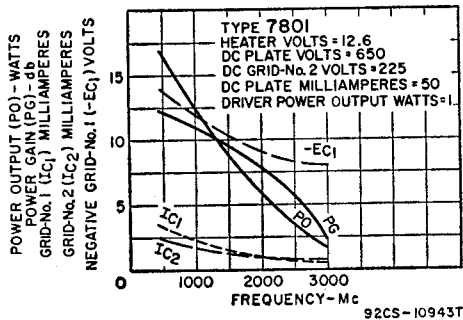

## AF POWER AMPLIFIER AND MODULATOR and LINEAR RF POWER AMPLIFIER *Single-Sideband Suppressed-Carrier Service*

### Maximum CCS Ratings:

DC PLATE VOLTAGE.....	750 <i>max</i>	volts
DC GRID-No.2 VOLTAGE.....	250 <i>max</i>	volts
MAXIMUM-SIGNAL DC PLATE CURRENT <sup>□</sup> .....	70 <i>max</i>	ma
MAXIMUM-SIGNAL DC GRID-No.1 CURRENT <sup>□</sup> .....	15 <i>max</i>	ma
MAXIMUM-SIGNAL PLATE INPUT <sup>□</sup> .....	52.5 <i>max</i>	watts
MAXIMUM-SIGNAL GRID-No.2 INPUT <sup>□</sup> .....	2 <i>max</i>	watts
PLATE DISSIPATION <sup>□</sup> .....	•	

### RF POWER AMPLIFIER—Class B Telephony

### Maximum CCS Ratings:

DC PLATE VOLTAGE.....	750 <i>max</i>	volts
DC GRID-No.2 VOLTAGE.....	250 <i>max</i>	volts
DC PLATE CURRENT.....	35 <i>max</i>	ma
DC GRID-No.1 CURRENT.....	8 <i>max</i>	ma
PLATE INPUT.....	52.5 <i>max</i>	watts
GRID-No.2 INPUT.....	2 <i>max</i>	watts
PLATE DISSIPATION.....	•	

### Maximum Circuit Values:

Grid-No.1-Circuit Resistance, Under any condition..... 30000 *max*<sup>▲</sup> ohms

‡ Because the cathode is subjected to considerable back bombardment as the frequency is increased with resultant increase in temperature, the heater voltage should be reduced depending on operating conditions and frequency to prevent overheating the cathode and resultant short life.

° Measured with special shield adapter.

• Maximum plate dissipation is a function of the maximum plate input, efficiency of the class of service and the effectiveness of the cooling system.

□ Averaged over any audio-frequency cycle of sine-wave form for *AF Power Amplifier and Modulator Service*.

▲ If this value is insufficient to provide adequate bias, the additional required bias must be supplied by a cathode resistor or fixed supply.

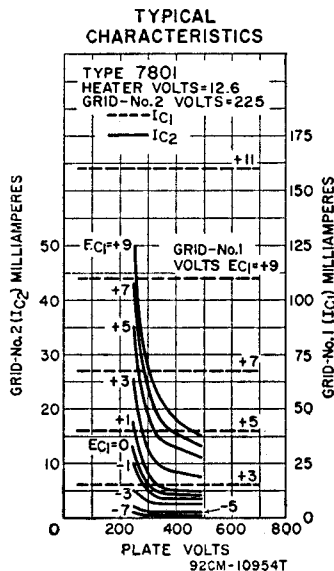

TYPICAL PLATE CHARACTERISTICS

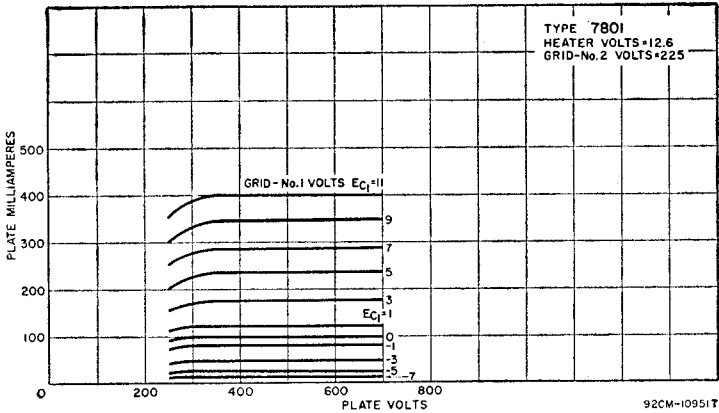

TYPICAL CONSTANT-CURRENT CHARACTERISTICS

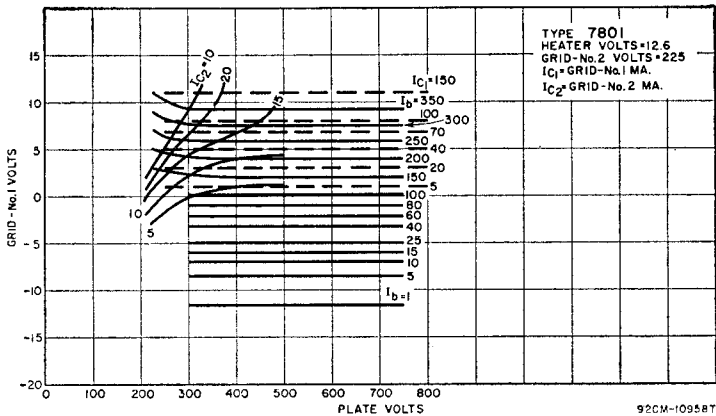

**7842**  
**7843**  
**7844**

**BEAM POWER TUBE**

Small, uhf, conduction-cooled, heater-cathode, cermolox types used as af power amplifier and modulator, and rf power amplifier and oscillator in compact mobile and fixed equipment

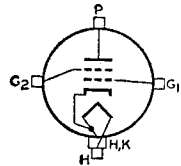

where the use of air may not be practical. Useful at frequencies up to 2000 Mc and beyond. Class C Telegraphy maximum plate input, CCS 180 watts. Except for heater rating, the 7843 is identical to type 7844. The 7842 is used in equipment where dependable performance under severe shock and vibration is essential. Types 7842, 7843, and 7844 may be operated in any position. OUTLINE 77, Outlines Section. For thermal considerations, refer to *Power Tube Installation* Section. Except for special ratings and performance data, internal construction, and minor changes in general characteristics as shown below, the 7842 is identical to type 7844. Type 7842 has matrix-type cathode.



## Technical Data

	7842	7843	7844	
HEATER VOLTAGE (AC/DC)†	6.3	26.5	6.3	volts
HEATER CURRENT	3.2	0.52	2.1	amperes
MINIMUM HEATING TIME	60	60	60	seconds
			7845, 7844	
MU-FACTOR, GRID No.2 To GRID No.1#	18		18	
DIRECT INTERELECTRODE CAPACITANCES:‡				
Grid No.1 to plate	0.065 <i>max</i>		0.065 <i>max</i>	μf
Grid No.1 to cathode and heater	14		14	μf
Plate to cathode and heater	0.019 <i>max</i>		0.015 <i>max</i>	μf
Grid No.1 to grid No.2	19		17	μf
Grid No.2 to plate	4.5		4.4	μf
Grid No.2 to cathode and heater	1.3 <i>max</i>		0.4 <i>max</i>	μf
CONDUCTION-CYLINDER TEMPERATURE	250 <i>max</i>		250 <i>max</i>	°C
SEAL TEMPERATURE (Plate, grid No.2, grid No.1, cathode and heater)	250 <i>max</i>		250 <i>max</i>	°C

‡ For plate volts, 250; grid-No.2 volts, 250; plate ma., 100.

### AF POWER AMPLIFIER AND MODULATOR—Class AB<sub>1</sub>

#### Maximum CCS Ratings:

DC PLATE VOLTAGE	1000 <i>max</i>	volts
DC GRID-NO.2 VOLTAGE	300 <i>max</i>	volts
MAXIMUM-SIGNAL DC PLATE CURRENT*	180 <i>max</i>	ma
MAXIMUM-SIGNAL PLATE INPUT*	180 <i>max</i>	watts
MAXIMUM-SIGNAL GRID-NO.2 INPUT*	4.5 <i>max</i>	watts
PLATE DISSIPATION*	•	

#### Typical CCS Push-Pull Operation:

*Values are for 2 tubes*

DC Plate Voltage	650	850	volts
DC Grid-No.2 Voltage‡	300	300	volts
DC Grid-No.1 Voltage from fixed-bias source	-15	-15	volts
Peak AF Grid-No.1-to-Grid-No.1 Voltage <sup>Δ</sup>	30	30	volts
Zero-Signal DC Plate Current	80	80	ma
Maximum-Signal DC Plate Current	200	200	ma
Zero-Signal DC Grid-No.2 Current	0	0	ma
Maximum-Signal DC Grid-No.2 Current	20	20	ma
Effective Load Resistance (Plate to plate)	4330	7000	ohms
Maximum-Signal Driving Power (Approx.)	0	0	watts
Maximum-Signal Power Output (Approx.)	50	80	watts

#### Maximum Circuit Values:

Grid-No.1-Circuit Resistance, Under any condition:*		
For fixed-bias operation	30000 <i>max</i>	ohms
For cathode-bias operation		Not recommended

### AF POWER AMPLIFIER AND MODULATOR—CLASS AB<sub>2</sub>

#### Maximum CCS Ratings:

DC PLATE VOLTAGE	1000 <i>max</i>	volts
DC GRID-NO.2 VOLTAGE	300 <i>max</i>	volts
MAXIMUM-SIGNAL DC PLATE CURRENT*	180 <i>max</i>	ma
MAXIMUM-SIGNAL DC GRID-NO.1 CURRENT*	30 <i>max</i>	ma
MAXIMUM-SIGNAL PLATE INPUT*	180 <i>max</i>	watts
MAXIMUM-SIGNAL GRID-NO.2 INPUT*	4.5 <i>max</i>	watts
PLATE DISSIPATION*	•	

#### Typical CCS Push-Pull Operation:

*Values are for 2 tubes*

DC Plate Voltage	650	850	volts
DC Grid-No.2 Voltage‡	300	300	volts
DC Grid-No.1 Voltage from fixed-bias source	-15	-15	volts
Peak AF Grid-No.1-to-Grid-No.1 Voltage	46	46	volts
Zero-Signal DC Plate Current	80	80	ma
Maximum-Signal DC Plate Current	355	355	ma
Zero-Signal DC Grid-No.2 Current	0	0	ma
Maximum-Signal DC Grid-No.2 Current	25	25	ma
Maximum-Signal DC Grid-No.1 Current	15	15	ma
Effective Load Resistance (Plate to plate)	2450	3960	ohms
Maximum-Signal Driving Power (Approx.)**	0.3	0.3	watt
Maximum-Signal Power Output (Approx.)	85	140	watts

# RCA Transmitting Tubes

## PLATE-MODULATED RF POWER AMPLIFIER—Class C Telephony

Maximum CCS Ratings:	<i>Up to 1215 Mc</i>	
DC PLATE VOLTAGE.....	800 <i>max</i>	volts
DC GRID-NO.2 VOLTAGE.....	300 <i>max</i>	volts
DC GRID-NO.1 VOLTAGE.....	-100 <i>max</i>	volts
DC PLATE CURRENT.....	150 <i>max</i>	ma
DC GRID-NO.1 CURRENT.....	30 <i>max</i>	ma
PLATE INPUT.....	120 <i>max</i>	watts
GRID-NO.2 INPUT.....	3 <i>max</i>	watts
PLATE DISSIPATION.....	•	

Typical CCS Operation:	<i>A 400 Mc</i>	
DC Plate Voltage.....	400	700
DC Grid-No.2 Voltage <sup>Ⓞ</sup> .....	200	250
DC Grid-No.1 Voltage <sup>†</sup> .....	-20	-50
DC Plate Current.....	100	130
DC Grid-No.2 Current.....	5	10
DC Grid-No.1 Current.....	5	10
Driver Power Output (Approx.) <sup>▲▲</sup> .....	2	3
Useful Power Output (Approx.).....	16	45

Maximum Circuit Values:		
Grid-No.1-Circuit Resistance, Under any condition.....	30000★ <i>max</i>	ohms

## RF POWER AMPLIFIER AND OSCILLATOR—Class C Telegraphy and RF POWER AMPLIFIER—Class C FM Telephony

Maximum CCS Ratings:	<i>Up to 1215 Mc</i>	
DC PLATE VOLTAGE.....	1000 <i>max</i>	volts
DC GRID-NO.2 VOLTAGE.....	300 <i>max</i>	volts
DC GRID-NO.1 VOLTAGE.....	-100 <i>max</i>	volts
DC PLATE CURRENT.....	180 <i>max</i>	ma
DC GRID-NO.1 CURRENT.....	30 <i>max</i>	ma
PLATE INPUT.....	180 <i>max</i>	watts
GRID-NO.2 INPUT.....	4.5 <i>max</i>	watts
PLATE DISSIPATION.....	•	

Typical CCS Operation:	<i>At 400 Mc</i>		<i>A 1215 Mc</i>	
DC Plate Voltage.....	400	900	900	volts
DC Grid-No.2 Voltage <sup>Ⓞ</sup> .....	200	300	300	volts
DC Grid-No.1 Voltage <sup>★</sup> .....	-35	-30	-22	volts
DC Plate Current.....	150	170	170	ma
DC Grid-No.2 Current.....	5	1	1	ma
DC Grid-No.1 Current.....	3	10	4	ma
Driver Power Output (Approx.) <sup>▲▲</sup> .....	3	3	5	watts
Useful Power Output (Approx.).....	23	80	40	watts

Maximum Circuit Values:		
Grid-No.1-Circuit Resistance, Under any condition.....	30000★ <i>max</i>	ohms

‡ Because the cathode is subjected to considerable back bombardment as the frequency is increased with resultant increase in temperature, the heater voltage should be reduced, depending on operating conditions and frequency, to prevent overheating the cathode and resultant short life.

Ⓞ Measured with special shield adapter.

▲ Averaged over any audio-frequency cycle of sine-wave form.

▲▲ Maximum plate dissipation is a function of the maximum plate input, efficiency of the class of service and the effectiveness of the cooling system.

Ⓢ Preferably obtained from a fixed supply.

\* The driver stage should be capable of supplying the No.1 grids of the Class AB<sub>1</sub> stage with the specified driving voltage at low distortion.

\* The resistance introduced into the grid-No.1 circuit by the input coupling should be held to a low value. In no case should it exceed the specified maximum value; transformer- or impedance-coupling devices are recommended.

\*\* Driver stage should be capable of supplying the specified driving power at low distortion to the No.1 grids of the AB<sub>2</sub> stage. To minimize distortion, the effective resistance per grid-No.1 circuit of the AB<sub>2</sub> stage should be held at a low value. For this purpose, the use of transformer coupling is recommended.

Ⓢ Obtained preferably from a separate source modulated along with the plate supply.

†Obtained from grid-No.1 resistor or from a combination of grid-No.1 resistor with either fixed supply or cathode resistor.

▲▲The driver stage is required to supply tube losses and rf-circuit losses. It should be designed to provide an excess of power above the indicated values to take care of variations in line voltage, components, initial tube characteristics, and tube characteristics during life.

★If this value is insufficient to provide adequate bias, the additional required bias must be supplied by a cathode resistor or fixed supply.

●●Obtained preferably from a fixed supply, or from the plate supply voltage with a voltage divider.

★★Obtained from fixed supply, by grid-No.1 resistor, by cathode resistor, or by combination methods.

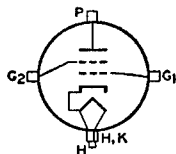
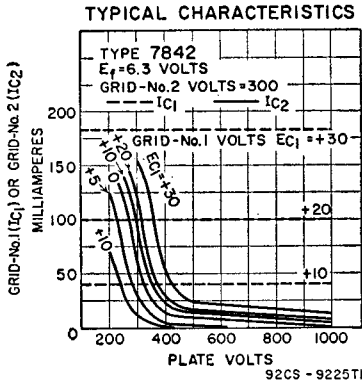
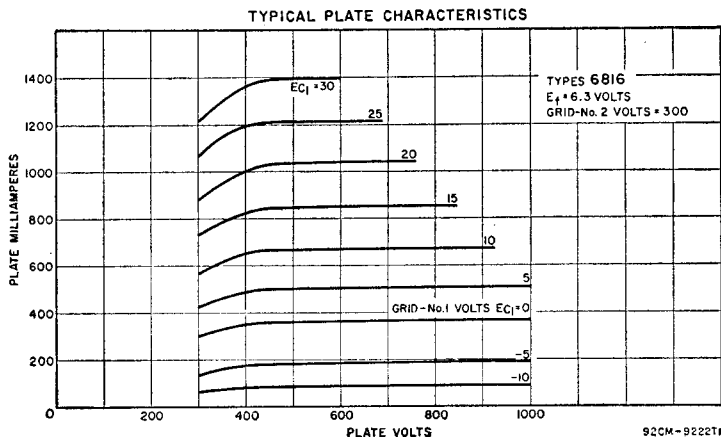

### BEAM POWER TUBE

Very small, uhf, conduction-cooled, heater-cathode, cermet type used as rf power amplifier and oscillator in compact mobile and fixed equipment where forced-air cooling may not

# 7870

be practical. Useful at frequencies up to 3000 Mc and beyond. Class C Telegraphy maximum plate input CCS, 52.5 watts. Heater volts (ac/dc), 6.3; amperes, 1. May be operated in any position. OUTLINE 76, *Outlines* Section. Except for heater rating, the 7870 is identical to type 7801.

**BEAM POWER TUBE**

**7905**

Miniature, quick-heating filament type used in rf power-amplifier, oscillator, and frequency-multiplier service at frequencies up to 175 Mc in mobile- and emergency-communications equipment. Delivers 7 watts useful power (ICAS) at 175 Mc.

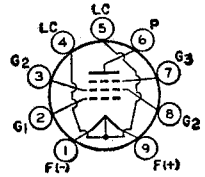

FILAMENT VOLTAGE (AC/DC).....	6.3	volts
FILAMENT CURRENT.....	0.65	ampere
FILAMENT WARM-UP TIME.....	Less than one second	
DIRECT INTERELECTRODE CAPACITANCES: <sup>o</sup>		
Grid No.1 to plate.....	0.14	max $\mu\text{f}$
Grid No.1 to filament, grid No.3, and grid No.2.....	8.5	$\mu\text{f}$
Plate to filament, grid No.3, and grid No.2.....	5.5	$\mu\text{f}$

<sup>o</sup>Without external shield.

**Characteristics, Class A<sub>1</sub> Amplifier:**

Plate Voltage.....	200	volts
Grid No.3.....	Connected to pin 1 at socket	
Grid-No.2 Voltage.....	185	volts
Grid-No.1 Voltage.....	-6	volts
Mu-Factor, Grid No.2 to grid No.1.....	11.5	
Transconductance.....	6700	$\mu\text{mhos}$
Plate Current.....	36	ma
Grid-No.2 Current.....	2.5	ma

**RF POWER AMPLIFIER AND OSCILLATOR—Class C Telegraphy  
and  
RF POWER AMPLIFIER—Class C FM Telegraphy**

*At frequencies up to 175 Mc*

<b>Maximum Ratings:</b>		
DC PLATE VOLTAGE.....	300	max volts
GRID NO.3.....	Connect to pin 1 at socket	
DC GRID-NO.2 SUPPLY VOLTAGE.....	300	max volts
DC GRID-NO.2 VOLTAGE.....	250	max volts
DC GRID-NO.1 VOLTAGE.....	-125	max volts
DC PLATE CURRENT.....	60	max ma
DC GRID-NO.2 CURRENT.....	10	max ma
DC GRID-NO.1 CURRENT.....	5	max ma
PLATE INPUT.....	18	max watts
GRID-NO.2 INPUT.....	1.5	max watts
PLATE DISSIPATION.....	10	max watts
BULB TEMPERATURE (At hottest point).....	225	max °C

*As amplifier at 175 Mc<sup>\*</sup>*

<b>Typical Operation:</b>		
DC Plate Voltage.....	300	300 volts
Grid No.3.....	Connected to pin 1 at socket	
DC Grid-No.2 Voltage <sup>*</sup> .....	160	185 volts
DC Grid-No.1 Voltage <sup>**</sup> .....	-36	-39 volts
From a grid-No.1 resistor of.....	18000	18000 ohms
Peak RF Grid-No.1 Voltage.....	41	43 volts
DC Plate Current.....	50	60 ma
DC Grid-No.2 Current.....	2.5	4 ma
DC Grid-No.1 Current (Approx.).....	2	2.2 ma
Driving Power (Approx.)†.....	1	1 watt
Useful Power Output (Approx.)††.....	5.5	7 watts

**Maximum Circuit Values:**

Grid-No.1-Circuit Resistance.....	0.1	max	0.1	max	megohm
-----------------------------------	-----	-----	-----	-----	--------

**PLATE-MODULATED RF POWER AMPLIFIER—Class C Telegraphy**

*At frequencies up to 175 Mc*

<b>Maximum Ratings:</b>		
DC PLATE VOLTAGE.....	250	max volts
GRID NO.3.....	Connect to pin 1 at socket	

## Technical Data

DC GRID-NO.2 VOLTAGE.....	250 max	volts
DC GRID-NO.1 VOLTAGE.....	-125 max	volts
DC PLATE CURRENT.....	60 max	ma
DC GRID-NO.2 CURRENT.....	10 max	ma
DC GRID-NO.1 CURRENT.....	5 max	ma
PLATE INPUT.....	15 max	watts
GRID-NO.2 INPUT.....	1.4 max	watts
PLATE DISSIPATION.....	7 max	watts
BULB TEMPERATURE (At hottest point).....	225 max	°C

### Typical Operation:\*

At 175 Mc

ICAS

DC Plate Voltage.....	250	volts
Grid No.3.....	Connected to pin 1 at socket	
DC Grid-No.2 Voltage <sup>‡</sup> .....	250	volts
DC Grid-No.1 Voltage**.....	-70	volts
From a grid-No.1 resistor of.....	33000	ohms
Peak RF Grid-No.1 Voltage.....	75	volts
DC Plate Current.....	60	ma
DC Grid-No.2 Current.....	2.5	ma
DC Grid-No.1 Current (Approx.).....	2.1	ma
Driving Power (Approx.)†.....	1	watt
Useful Power Output (Approx.)††.....	6.5	watts

### Maximum Circuit Values:

Grid-No.1-Circuit Resistance.....	0.1 max	megohm
-----------------------------------	---------	--------

### FREQUENCY MULTIPLIER

#### Maximum Ratings:

ICAS

DC PLATE VOLTAGE.....	300 max	volts
Grid No.3.....	Connect to pin 1 at socket	
DC GRID-NO.2 SUPPLY VOLTAGE.....	300 max	volts
DC GRID-NO.2 VOLTAGE.....	250 max	volts
DC GRID-NO.1 VOLTAGE.....	-125 max	volts
DC PLATE CURRENT.....	50 max	ma
DC GRID-NO.2 CURRENT.....	10 max	ma
DC GRID-NO.1 CURRENT.....	5 max	ma
PLATE INPUT.....	15 max	watts
GRID-NO.2 INPUT.....	1.5 max	watts
PLATE DISSIPATION.....	10 max	watts
BULB TEMPERATURE (At hottest point).....	225 max	°C

As doubler to 175 Mc

ICAS

DC Plate Voltage.....	250	300	volts
Grid No.3.....	Connected to pin 1 at socket		
DC Grid-No.2 Voltage*.....	200	215	volts
DC Grid-No.1 Voltage**.....	-53	-80	volts
From a grid-No.1 resistor of.....	53000	53000	ohms
Peak RF Grid-No.1 Voltage.....	60	87	volts
DC Plate Current.....	45	50	ma
DC Grid-No.2 Current.....	3.4	3.4	ma
DC Grid-No.1 Current (Approx.).....	1	1.5	ma
Driving Power (Approx.)†.....	0.4	0.5	watt
Useful Power Output (Approx.)††.....	2.5	3.5	watts

As tripler to 175 Mc

ICAS

DC Plate Voltage.....	250	250	volts
Grid No.3.....	Connected to pin 1 at socket		
DC Grid-No.2 Voltage*.....	180	225	volts
DC Grid-No.1 Voltage.....	-90	-108	volts
From a grid-No.1 resistor of.....	50000	60000	ohms
Peak RF Grid-No.1 Voltage.....	105	118	volts
DC Plate Current.....	40	50	ma
DC Grid-No.2 Current.....	2.5	3.4	ma
DC Grid-No.1 Current (Approx.).....	1.8	1.8	ma
Driving Power (Approx.)†.....	0.4	0.6	watt
Useful Power Output (Approx.)††.....	1.4	2	watts

### Maximum Circuit Values:

Grid-No.1-Circuit Resistance.....	0.1 max	0.1 max	megohm
-----------------------------------	---------	---------	--------

• Pins 4 and 5 at rf ground.

\* Obtained preferably from a separate source or from the plate-voltage supply with a voltage divider. If a series resistor is used, it should be adjustable to permit obtaining the desired operating plate current after initial tuning adjustments are completed.

\*\* Obtained from a grid-No.1 resistor, or from a combination of grid-No.1 resistor and either fixed supply or cathode resistor. The combination of grid resistor and fixed supply has the advantage of not only protecting the tube from damage through loss of excitation but also of minimizing distortion by bias-supply compensation.

† Driving power includes circuit losses and is the actual power measured at the input to the grid circuit.

‡ Measured at load.

‡ Obtained preferably from a separate source modulated along with the plate supply, or from the modulated plate supply through a series resistor. It is recommended that this resistor be adjustable to permit obtaining the desired operating plate current after initial tuning adjustments are made.

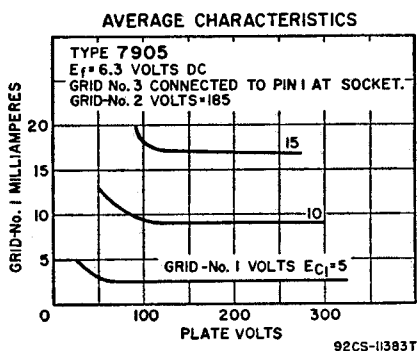
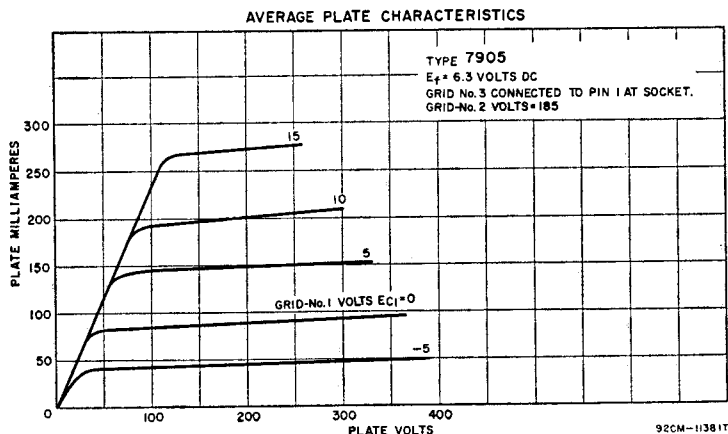

## OPERATING CONSIDERATIONS

Type 7905 requires Miniature nine-contact socket and may be operated in vertical position (base up or down), or in horizontal position with pins 2 and 8 in vertical plane. *OUTLINE 9, Outlines Section.*

Shielding of the 7905 may be used in straight-through rf amplifier service to minimize external feedback from the plate to grid No.1. A grounded shield crossing the terminal end of the tube socket through the space between pins 2 and 3 and the space between pins 8 and 9, is generally adequate for this purpose. No shielding is necessary for either frequency doubler or tripler operation.

When operated from automotive electrical systems, the filament may be subjected to voltage variations as great as  $\pm 20\%$ . Although such extremes in filament

voltage may be tolerated for short periods, increased equipment reliability can be achieved with improved supply-voltage regulation.

The socket connections to pins 4 and 5, which are designated LC on the basing diagram, may be used to minimize the absorption of rf power in the filament circuit by connecting pins 4 and 5 to ground through a capacitor, close to the socket. Pin 1 is directly grounded and pin 9 is bypassed by using a feedthrough capacitor when bringing this filament lead through the chassis.

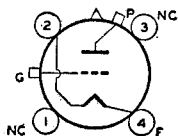

### POWER TRIODE

8000

Thoriated-tungsten-filament type used as af power amplifier and modulator and as rf power amplifier and oscillator. May be used with full input up to 30 Mc; for operation at 60 Mc,

plate voltage and plate input should be reduced to 70 per cent of maximum ratings; at 100 Mc, to 50 per cent. Class C Telegraphy maximum plate dissipation, CCS 125 watts, ICAS 175 watts. Type 8000 requires Jumbo four-contact socket and may be operated in vertical position with base down, or in horizontal position with pins 1 and 2 in vertical plane. OUTLINE 55, *Outlines* Section. Plate shows a barely perceptible red color when tube is operated at maximum CCS ratings and a cherry-red color at maximum ICAS ratings.

FILAMENT VOLTAGE (AC/DC) .....	10	volts
FILAMENT CURRENT .....	4.5	amperes
AMPLIFICATION FACTOR .....	16.5	
DIRECT INTERELECTRODE CAPACITANCES:		
Grid to plate .....	6.4	μf
Grid to filament .....	5.0	μf
Plate to filament .....	3.3	μf

#### PLATE-MODULATED RF POWER AMPLIFIER—Class C Telephony

Maximum Ratings:	CCS	ICAS	
DC PLATE VOLTAGE .....	1600 max	2000 max	volts
DC GRID VOLTAGE .....	-500 max	-500 max	volts
DC PLATE CURRENT .....	210 max	250 max	ma
DC GRID CURRENT .....	40 max	45 max	ma
PLATE INPUT .....	335 max	500 max	watts
PLATE DISSIPATION .....	85 max	125 max	watts

#### RF POWER AMPLIFIER AND OSCILLATOR—Class C Telephony and

#### RF POWER AMPLIFIER—Class C FM Telephony

Maximum Ratings:	CCS	ICAS	
DC PLATE VOLTAGE .....	2000 max	2500 max	volts
DC GRID VOLTAGE .....	-500 max	-500 max	volts
DC PLATE CURRENT .....	250 max	300 max	ma
DC GRID CURRENT .....	40 max	45 max	ma
PLATE INPUT .....	500 max	750 max	watts
PLATE DISSIPATION .....	125 max	175 max	watts

### BEAM POWER TUBE

See type 4E27/8001.

8001

### POWER TRIODE

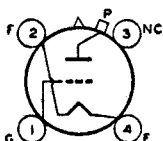

Thoriated-tungsten-filament type used as af power amplifier and modulator and as rf power amplifier and oscillator. May be used with full input up to 30 Mc and with reduced input up to 50 Mc. Requires Jumbo four-contact socket and may be operated in vertical position with base down, or in horizontal position with pins 1 and 3 in vertical plane. Maximum length, 8-3/16 inches; maximum diameter,

8003

2-9/16 inches. For operation at 50 Mc, plate voltage and plate input should be reduced to 83 per cent of maximum ratings. Filament volts (ac/dc), 10; amperes, 3.25. Direct interelectrode capacitances: grid to plate, 11.7  $\mu\mu\text{f}$ ; grid to filament, 5.8  $\mu\mu\text{f}$ ; plate to filament, 3.4  $\mu\mu\text{f}$ . Maximum CCS ratings as AF POWER AMPLIFIER AND MODULATOR: dc plate volts, 1350 *max*; maximum-signal dc plate milliamperes, 250 *max*; maximum-signal plate input, 330 *max* watts; plate dissipation, 100 *max* watts. Maximum CCS ratings as RF POWER AMPLIFIER AND OSCILLATOR: dc plate volts, 1350 *max*; dc grid volts, -400 *max*; dc plate milliamperes, 250 *max*; dc grid milliamperes, 50 *max*; plate input, 330 *max* watts; plate dissipation, 100 *max* watts. Plate shows no color when tube is operated at maximum CCS ratings. The 8003 is a DISCONTINUED type listed for reference only.

# 8005

## POWER TRIODE

Thoriated-tungsten-filament type used as af power amplifier and modulator and as rf power amplifier and oscillator. May be used with full input up to 60 Mc. For operation at 80 Mc,

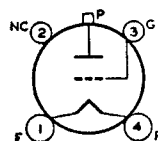

plate voltage and plate input should be reduced to 75 per cent of maximum ratings; at 100 Mc, to 60 per cent. Class C Telephony maximum plate dissipation, CCS 75 watts, ICAS 85 watts. Type 8005 requires Small four-contact socket and may be operated in vertical position with base down, or in horizontal position with pins 2 and 3 in vertical plane. OUTLINE 45, *Outlines* Section. Plate shows a cherry-red color when tube is operated at maximum CCS ratings and an orange-red color at maximum ICAS ratings.

FILAMENT VOLTAGE (AC/DC) .....	10	volts
FILAMENT CURRENT .....	3.25	amperes
AMPLIFICATION FACTOR* .....	20	
DIRECT INTERELECTRODE CAPACITANCES:		
Grid to plate .....	5.0	$\mu\mu\text{f}$
Grid to filament .....	6.4	$\mu\mu\text{f}$
Plate to filament .....	1.0	$\mu\mu\text{f}$

\*Grid volts, 50; plate amperes, 0.5.

### PLATE-MODULATED RF POWER AMPLIFIER—Class C Telephony

Maximum Ratings:	CCS	ICAS	
DC PLATE VOLTAGE .....	1000 <i>max</i>	1250 <i>max</i>	volts
DC GRID VOLTAGE .....	-200 <i>max</i>	-200 <i>max</i>	volts
DC PLATE CURRENT .....	160 <i>max</i>	200 <i>max</i>	ma
DC GRID CURRENT .....	45 <i>max</i>	45 <i>max</i>	ma
PLATE INPUT .....	160 <i>max</i>	240 <i>max</i>	watts
PLATE DISSIPATION .....	50 <i>max</i>	75 <i>max</i>	watts

### RF POWER AMPLIFIER AND OSCILLATOR—Class C Telephony and

### RF POWER AMPLIFIER—Class C FM Telephony

Maximum Ratings:	CCS	ICAS	
DC PLATE VOLTAGE .....	1250 <i>max</i>	1500 <i>max</i>	volts
DC GRID VOLTAGE .....	-200 <i>max</i>	-200 <i>max</i>	volts
DC PLATE CURRENT .....	200 <i>max</i>	200 <i>max</i>	ma
DC GRID CURRENT .....	45 <i>max</i>	45 <i>max</i>	ma
PLATE INPUT .....	240 <i>max</i>	300 <i>max</i>	watts
PLATE DISSIPATION .....	75 <i>max</i>	85 <i>max</i>	watts

## HALF-WAVE MERCURY-VAPOR RECTIFIER

# 8008

Coated-filament type used in power supply of transmitting and industrial equipment. Maximum peak inverse anode volts, 10,000; maximum average anode amperes, 1.25. Requires

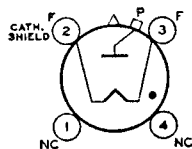

Super-Jumbo four-contact socket and may be operated in vertical position only, base down. OUTLINE 56, *Outlines* Section. Except for physical dimension and base, the 8008 is identical to type 872A.



**POWER TRIODE**

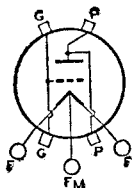

**8012A**

Thoriated-tungsten-filament type having filament mid-tap used as rf power amplifier and oscillator. May be used with full input up to 500 Mc. For operation at 600 Mc, plate voltage should be reduced to 70 per cent of maximum rating. May be mounted in vertical position only, filament end down or up. Maximum length (excluding flexible leads), 3-5/16 inches; maximum radius, 1-5/64 inches. Filament volts (ac/dc), 6.3; amperes, 1.92. Direct interelectrode capacitances: grid to plate, 2.5  $\mu\text{f}$ ; grid to filament mid-tap, 2.7  $\mu\text{f}$ ; plate to filament mid-tap, 0.4  $\mu\text{f}$ . Maximum CCS ratings as RF POWER AMPLIFIER, Class C Telegraphy service: dc plate volts, 1000 *max*; dc grid volts, -200 *max*; dc plate ma., 80 *max*; dc grid ma., 20 *max*; plate input, 50 *max* watts; plate dissipation, 40 *max* watts. Forced-air cooling is required when plate dissipation exceeds 75 per cent of the maximum rated value. Plate shows an orange-red color when tube is operated at maximum CCS ratings. The 8012A is a DISCONTINUED type listed for reference only.

**POWER TRIODE**

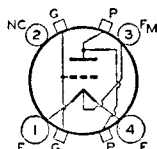

**8025A**

Thoriated-tungsten-filament type having filament mid-tap used as rf power amplifier and oscillator. May be used with full input up to 500 Mc. For operation at 600 Mc, plate voltage should be reduced to 70 per cent of maximum ratings. Class C Telegraphy maximum plate dissipation, CCS 40 watts with forced-air cooling, ICAS 30 watts with natural cooling. Requires Small four-contact socket and may be mounted in vertical position only, base down or up. Maximum length, 4-11/16 inches; maximum radius, 1-5/64 inches. Filament volts (ac/dc), 6.3; amperes, 1.92. Direct interelectrode capacitances: grid to plate, 3.0  $\mu\text{f}$ ; grid to filament mid-tap, 2.7  $\mu\text{f}$ ; plate to filament mid-tap, 0.4  $\mu\text{f}$ . Maximum CCS ratings as RF POWER AMPLIFIER, Class C Telegraphy service: dc plate volts, 1000 *max*; dc grid volts, -200 *max*; dc plate ma., 20 *max*; plate input, 75 *max* watts; plate dissipation, 40 *max* watts. Forced-air cooling is required for operation near maximum ratings. Plate shows an orange-red color when tube is operated at maximum CCS ratings and a bright orange-red color at maximum ICAS ratings. The 8025A is a DISCONTINUED type listed for reference only.

**BEAM POWER TUBE**

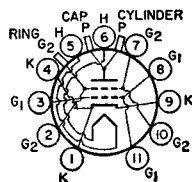

**8072**

Small, ceramic-metal, conduction-cooled, heater-cathode type having precision-aligned grids, and used as linear rf power amplifier and rf power amplifier and oscillator in mobile or fixed

equipment where the use of cooling air may not be practical. Useful with full input at frequencies up to 500 Mc. Type 8072 requires a special 11-contact socket such as Mycalex No. CP464-2, or equivalent, and may be operated in any position. OUTLINE 80, *Outlines* Section. For thermal considerations, see *Power Tube Installation* Section.

HEATER VOLTAGE RANGE (AC/DC).....	12 to 15	volts
HEATER CURRENT AT 13.5 volts.....	1.3	amperes
MINIMUM HEATING TIME.....	60	seconds
MU-FACTOR, GRID No.2 To GRID No.1★.....	11	
DIRECT INTERELECTRODE CAPACITANCES: <sup>2</sup>		
Grid No.1 to plate.....	0.13 <i>max</i>	$\mu\text{f}$
Grid No.1 to cathode.....	16	$\mu\text{f}$
Plate to cathode.....	0.011	$\mu\text{f}$
Grid No.1 to grid No.2.....	22	$\mu\text{f}$
Grid No.2 to plate.....	6.5	$\mu\text{f}$
Grid No.2 to cathode.....	3.2	$\mu\text{f}$
Cathode to heater.....	3.4	$\mu\text{f}$
TERMINAL TEMPERATURE (All terminals).....	250 <i>max</i>	$^{\circ}\text{C}$
PLATE CORE TEMPERATURE (See dimensional outline).....	250 <i>max</i>	$^{\circ}\text{C}$

★ For plate volts, 250; grid-No.2 volts, 200; plate amperes, 1.2.

## LINEAR RF POWER AMPLIFIER Single-Sideband Suppressed-Carrier Service

*Peak envelope conditions for a signal having a minimum peak-to-average power ratio of 2*

Maximum CCS Ratings:		<i>Up to 500 Mc</i>	
DC PLATE VOLTAGE.....		2200 <i>max</i>	volts
DC GRID-NO.2 VOLTAGE.....		400 <i>max</i>	volts
DC GRID-NO.1 VOLTAGE.....		-100 <i>max</i>	volts
DC PLATE CURRENT AT PEAK OF ENVELOPE.....		450* <i>max</i>	ma
DC GRID-NO.1 CURRENT.....		100 <i>max</i>	ma
PLATE DISSIPATION.....		100* <i>max</i>	watts
GRID-NO.2 INPUT.....		8 <i>max</i>	watts
<b>PEAK HEATER-CATHODE VOLTAGE:</b>			
Heater negative with respect to cathode.....		150 <i>max</i>	volts
Heater positive with respect to cathode.....		150 <i>max</i>	volts
<b>Typical CCS Operation with Two-Tone Modulation:</b>		<i>At 30 Mc</i>	
DC Plate Voltage.....		700	volts
DC Grid-No.2 Voltage <sup>□</sup> .....		250	volts
DC Grid-No.1 Voltage <sup>□</sup> .....		-20	volts
Zero-Signal DC Plate Current.....		100	ma
Effective RF Load Resistance.....		1420	ohms
DC Plate Current at Peak of Envelope.....		205	ma
Average DC Plate Current.....		150	ma
DC Grid-No.2 Current at Peak of Envelope.....		16	ma
Average DC Grid-No.2 Current.....		10	ma
Average DC Grid-No.1 Current.....		1.0 <sup>▲</sup>	ma
Peak-Envelope Driver Power Output (Approx.)*.....		0.3	watt
Output-Circuit Efficiency (Approx.).....		95	per cent
Distortion Products Level:#			
Third order.....		30	db
Fifth order.....		35	db
Useful Power Output (Approx.):**			
Average.....		40	watts
Peak Envelope.....		80	watts

### Maximum Circuit Values:

Grid-No.1-Circuit Resistance, Under any condition:			
With fixed bias.....		25000 <i>max</i>	ohms

## RF POWER AMPLIFIER AND OSCILLATOR—Class C Telegraphy and RF POWER AMPLIFIER—Class C FM Telephony

Maximum CCS Ratings:		<i>Up to 500 Mc</i>			
DC PLATE VOLTAGE.....		2200 <i>max</i>			volts
DC GRID-NO.2 VOLTAGE.....		400 <i>max</i>			volts
DC GRID-NO.1 VOLTAGE.....		-100 <i>max</i>			volts
DC PLATE CURRENT.....		300 <i>max</i>			ma
DC GRID-NO.1 CURRENT.....		100 <i>max</i>			ma
GRID-NO.2 INPUT.....		8 <i>max</i>			watts
PLATE DISSIPATION.....		100* <i>max</i>			watts
<b>PEAK HEATER-CATHODE VOLTAGE:</b>					
Heater negative with respect to cathode.....		150 <i>max</i>			volts
Heater positive with respect to cathode.....		150 <i>max</i>			volts

### *In Grid-Drive Circuit*

Typical CCS Operation:	<i>At 150 Mc</i>		<i>At 175 Mc</i>		<i>At 470 Mc</i>		
DC Plate Voltage.....	500	700	500	700	700		volts
DC Grid-No.2 Voltage.....	160	175	200	200	200		volts
DC Grid-No.1 Voltage.....	-10	-10	-30	-30	-30		volts
DC Plate Current.....	300	300	300	300	300		ma
DC Grid-No.2 Current.....	25	25	30	20	10		ma
DC Grid-No.1 Current.....	50	50	40	40	20		ma
Driver Power Output (Approx.)†.....	1.2	1.2	3	3	5		watts
Useful Power Output**.....	85	110	70	105	85		watts

### Maximum Circuit Value:

Grid-No.1-Circuit Resistance, Under any condition:			
With fixed bias.....		25000	ohms
Grid-No.2 Circuit Impedance.....		10000 <i>max</i>	ohms
Plate Circuit Impedance.....			See note <sup>Ⓟ</sup>

‡ Because the cathode is subjected to back bombardment as the frequency is increased with resultant increase in temperature, the heater voltage should, for optimum life, be reduced to a value such that at the heater voltage obtained at minimum supply voltage conditions (all other voltages constant), the tube performance just starts to show some degradation; e.g., at 470 Mc, heater volts = 12.5 (Approx.).

° Measured with special shield adapter.

▪ The maximum rating for a signal having a minimum peak-to-average power ratio less than 2, such as is obtained in single-tone operation, is 300 ma. During short periods of circuit adjustment under single-tone conditions, the average plate current may be as high as 450 ma.

• Maximum plate dissipation is limited by the maximum plate core temperature and the cooling system to maintain tube operation below the specified maximum plate core temperature. With simple low-cost cooling techniques, maximum plate dissipation may be only about 100 watts; with more sophisticated cooling techniques, maximum plate dissipation may be as high as 300 watts.

□ Obtained preferably from a separate well-regulated source.

▲ This value represents the approximate grid-No.1 current obtained due to initial electron velocities and contact-potential effects when grid-No.1 is driven to zero volts at maximum signal.

\* Driver power output represents circuit losses and is the actual power measured at input to grid-No.1 circuit. The actual power required depends on the operating frequency and the circuit used. The tube driving power is approximately zero watts.

# With maximum signal output used as a reference, and without the use of feedback to enhance linearity.

\*\* This value of useful power is measured at load of output circuit.

⊙ The tube should see an effective plate supply impedance which limits the peak current through the tube under surge conditions to 15 amperes.

† Driver power output includes circuit losses and is the actual power measured at the input to the grid circuit. It will vary depending upon the frequency of operation and the circuit used.

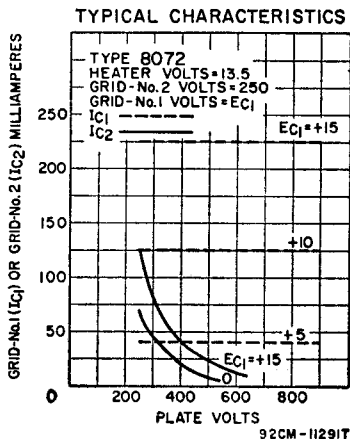
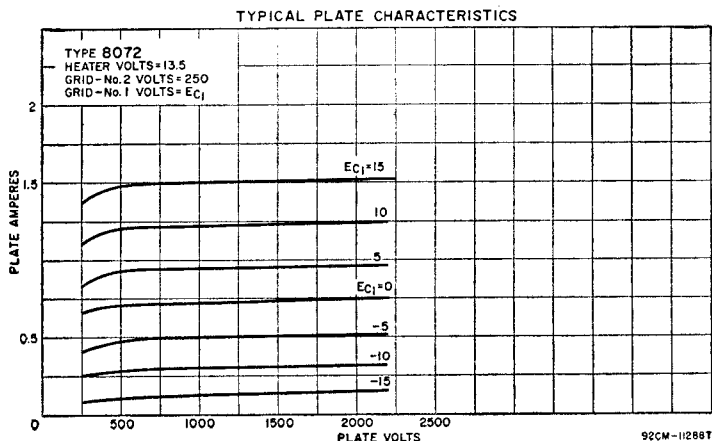

# 8077/ 7054

## POWER PENTODE

Miniature heater-cathode type used in mobile communication equipment operating from 12-volt storage-battery systems. Used in Class C rf power-amplifier, oscillator, and frequency-multiplier service at frequencies up to 40 Mc; also used in modulator and power-amplifier applications. Requires Miniature nine-contact socket and may be operated in any position. OUTLINE 6, *Outlines* Section. During manufacture, this tube is subjected to special controls and tests for heater-cycling, heater-cathode leakage, interelectrode leakage, low-frequency-vibration performance, 500-hour intermittent life performance, and intermittent shorts.

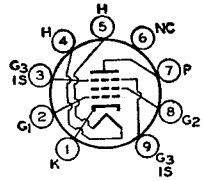

HEATER VOLTAGE RANGE (AC/DC).....	12 to 15	volts
HEATER CURRENT (Approx.) at 13.5 volts.....	0.275	ampere
DIRECT INTERELECTRODE CAPACITANCES (Approx.): <sup>o</sup>		
Grid No.1 to Plate.....	0.063	μf
Grid No.1 to All Other Electrodes except Plate.....	10.2	μf
Plate to All Other Electrodes except Grid No.1.....	3.5	μf

<sup>o</sup> Without external shield.

### AMPLIFIER—Class A<sub>1</sub>

**Maximum Ratings:**

PLATE VOLTAGE.....	330 <i>max</i>	volts
GRID-NO.3 VOLTAGE.....	0 <i>max</i>	volts
GRID-NO.2 VOLTAGE.....	180 <i>max</i>	volts
GRID-NO.1 VOLTAGE:		
Negative-bias value.....	55 <i>max</i>	volts
Positive-bias value.....	0 <i>max</i>	volts
GRID-NO.2 INPUT.....	1 <i>max</i>	watt
PLATE DISSIPATION.....	5 <i>max</i>	watts
PEAK HEATER-CATHODE VOLTAGE:		
Heater negative with respect to cathode.....	120 <i>max</i>	volts
Heater positive with respect to cathode.....	120 <i>max</i>	volts

**Characteristics With 13.5 Volts on Heater:**

Plate Supply Voltage.....	250	volts
Grid-No.3.....	Connected to cathode at socket	
Grid-No.2 Voltage.....	150	volts
Cathode Resistor.....	120	ohms
Plate Resistance (Approx.).....	0.1	megohm
Transconductance.....	11500	μmhos
Plate Current.....	19	ma
Grid-No.2 Current.....	3.5	ma
Grid-No.1 Voltage (Approx.) for plate μa=20.....	-10	volts

**Maximum Circuit Values:**

Grid-No.1-Circuit Resistance:		
For fixed-bias operation.....	0.1 <i>max</i>	megohm
For cathode-bias operation.....	0.25 <i>max</i>	megohm

### RF POWER AMPLIFIER AND OSCILLATOR—Class C Telegraphy and RF POWER AMPLIFIER—Class C FM Telephony

**Maximum CCS Ratings:**

DC PLATE VOLTAGE.....	300 <i>max</i>	volts
DC GRID-NO.3 VOLTAGE.....	0 <i>max</i>	volts
DC GRID-NO.2 VOLTAGE.....	175 <i>max</i>	volts
DC GRID-NO.1 VOLTAGE.....	-50 <i>max</i>	volts
DC PLATE CURRENT.....	33 <i>max</i>	ma
DC GRID-NO.2 CURRENT.....	5.5 <i>max</i>	ma
DC GRID-NO.1 CURRENT.....	3 <i>max</i>	ma
GRID-NO.2 INPUT.....	1 <i>max</i>	watt
PLATE DISSIPATION.....	5 <i>max</i>	watts
PEAK HEATER-CATHODE VOLTAGE:		
Heater negative with respect to cathode.....	120 <i>max</i>	volts
Heater positive with respect to cathode.....	120 <i>max</i>	volts

## Technical Data

### Typical Operation with 13.5 Volts on Heater:

	At frequencies up to 40 Mc			
DC Plate Voltage	200	250	300	volts
Grid No.3	Connected to cathode at socket			
DC Grid-No.2 Voltage	115	145	175	volts
DC Grid-No.1 Voltage	-7	-9	-12	volts
Peak RF Grid-No.1 Voltage	9	11	16	volts
DC Plate Current	14.5	20	26	ma
DC Grid-No.2 Current	3	4.1	5.5	ma
DC Grid-No.1 Current (Approx.)	0.6	0.85	1	ma
Driving Power (Approx.)	10	12	15	mw
Power Output (Approx.)	1.5	2.7	4	watts

### Maximum Circuit Values:

Grid-No.1-Circuit Resistance	0.1 max megohm
------------------------------	----------------

## FREQUENCY MULTIPLIER

### Maximum CCS Ratings:

DC PLATE VOLTAGE	300 max	volts
DC GRID-NO.3 VOLTAGE	0 max	volts
DC GRID-NO.2 VOLTAGE	175 max	volts
DC GRID-NO.1 VOLTAGE	-50 max	volts
DC PLATE CURRENT	33 max	ma
DC GRID NO.2 CURRENT	5.5 max	ma
DC GRID NO.1 CURRENT	3 max	ma
GRID NO.2 INPUT	1 max	watt
PLATE DISSIPATION	5 max	watts
<b>PEAK HEATER-CATHODE VOLTAGE:</b>		
Heater negative with respect to cathode	120 max	volts
Heater positive with respect to cathode	120 max	volts

### Typical Operation as Doubler:

	At frequencies up to 40 Mc			
DC Plate Voltage	200	250	300	volts
Grid No.3	Connected to cathode at socket			
DC Grid-No.2 Voltage	115	145	175	volts
DC Grid-No.1 Voltage	-16	-20	-25	volts
Peak RF Grid-No.1 Voltage	19	24	31	volts
DC Plate Current	11	15	20	ma
DC Grid-No.2 Current	2	3	4	ma
DC Grid-No.1 Current (Approx.)	0.3	0.45	0.6	ma
Driving Power (Approx.)	5	9	13	mw
Useful Power Output (Approx.)	1.4	1.9	2.5	watts

### Maximum Circuit Values:

Grid-No.1-Circuit Resistance	0.1 max megohm
------------------------------	----------------

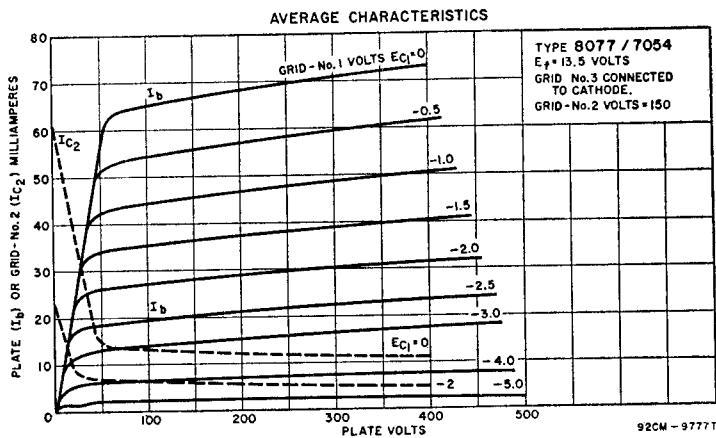

## BEAM POWER TUBE

# 8121

Small, ceramic-metal, forced-air-cooled, heater-cathode type having precision-aligned grids; used as linear rf power amplifier and rf power amplifier and oscillator in mobile or fixed equipment.

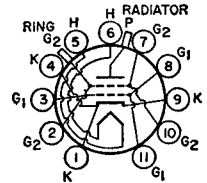

Useful with full input at frequencies up to 500 Mc. For plate and average characteristics curves refer to type 8072.

HEATER VOLTAGE (AC/DC)†	13.5	volts
HEATER CURRENT at 13.5 volts	1.3	amperes
MINIMUM HEATING TIME	60	seconds
MU-FACTOR, GRID No.2 To GRID No.1★	12	
<b>DIRECT INTERELECTRODE CAPACITANCES:‡</b>		
Grid No.1 to plate	0.13 max	μf
Grid-No.1 to cathode	16	μf
Plate to cathode	0.011	μf
Grid No.1 to grid No.2	22	μf
Grid No.2 to plate	6.5	μf
Grid No.2 to cathode	3.2	μf
Cathode to heater	3.4	μf
TERMINAL TEMPERATURE (All terminals)	250 max	°C
RADIATOR CORE TEMPERATURE (See dimensional outline)	250 max	°C

★ For plate volts, 450; grid-No.2 volts, 325; plate amperes, 1.2.

### LINEAR RF POWER AMPLIFIER

#### Single-Sideband Suppressed-Carrier Service

*Peak envelope conditions for a signal having a minimum peak-to-average power ratio of 2*

<b>Maximum CCS Ratings:</b>	<i>Up to 500 Mc</i>	
DC PLATE VOLTAGE	2200 max	volts
DC GRID-No.2 VOLTAGE	400 max	volts
DC GRID-No.1 VOLTAGE	-100 max	volts
DC PLATE CURRENT AT PEAK OF ENVELOPE	450 max	ma
DC GRID-No.1 CURRENT	100 max	ma
PLATE INPUT	150 max	watts
GRID No.2 DISSIPATION	8 max	watts
<b>PEAK HEATER-CATHODE VOLTAGE:</b>		
Heater negative with respect to cathode	150 max	volts
Heater positive with respect to cathode	150 max	volts

#### Typical CCS Operation with Two-Tone Modulation:

*At 30 Mc*

DC Plate Voltage	1000	1500	
DC Grid-No.2 Voltage*	250	250	volts
DC Grid-No.1 Voltage*	-20	-20	volts
Zero-Signal DC Plate Current	100	100	ma
Effective RF Load Resistance	2270	3800	ohms
DC Plate Current at Peak of Envelope	210	210	ma
Average DC Plate Current	160	160	ma
DC Grid-No.2 Current at Peak of Envelope	10	10	ma
Average DC Grid-No.2 Current	7	7	ma
Average DC Grid No.1 Current	0.05 <sup>D</sup>	0.05 <sup>D</sup>	ma
Peak-Envelope Driver Power Output (Approx.)*	0.3	0.3	watt
Output-Circuit Efficiency (Approx.)	90	85	%
<b>Distortion Products Level:*</b>			
Third order	35	35	db
Fifth Order	40	40	db
<b>Useful Power Output (Approx.):</b>			
Average#	55	85	watts
Peak envelope#	110	170	watts

#### Maximum Circuit Values:

<b>Grid-No.1-Circuit Resistance, Under any conditions:</b>		
With fixed bias	25000 max	ohms
With fixed bias (In Class AB <sub>1</sub> operation)	100000 max	ohms
With cathode bias	Not recommended	
<b>Grid-No.2 Circuit Impedance</b>	10000 max	ohms
<b>Plate Circuit Impedance</b>		See note **

**RF POWER AMPLIFIER AND OSCILLATOR—Class C Telegraphy  
and  
RF POWER AMPLIFIER—Class C FM Telephony**

<b>Maximum CCS Ratings:</b>	<i>Up to 500 Mc</i>	
DC PLATE VOLTAGE.....	2200 <i>max</i>	volts
DC GRID-NO.2 VOLTAGE.....	400 <i>max</i>	volts
DC GRID-NO.1 VOLTAGE.....	-100	volts
DC PLATE CURRENT.....	300 <i>max</i>	ma
DC GRID-NO.1 CURRENT.....	100 <i>max</i>	ma
GRID-NO.2 DISSIPATION.....	8 <i>max</i>	watts
PLATE DISSIPATION.....	150 <i>max</i>	watts
<b>PEAK HEATER-CATHODE VOLTAGE:</b>		
Heater negative with respect to cathode.....	150 <i>max</i>	volts
Heater positive with respect to cathode.....	150 <i>max</i>	volts

<b>Typical CCS Operation: In grid-drive circuit</b>	<i>At 50 Mc</i>			<i>At 470 Mc</i>			
DC Plate Voltage.....	700	1000	1500	700	1000	1500	volts
DC Grid-No.2 Voltage.....	175	200	200	200	200	200	volts
DC Grid-No.1 Voltage.....	-10	-30	-30	-30	-30	-30	volts
DC Plate Current.....	300	300	300	300	300	300	ma
DC Grid-No.2 Current.....	25	20	20	10	10	5	ma
DC Grid-No.1 Current.....	50	40	40	30	30	30	ma
Driver Power Output (Approx.) <sup>Ⓞ</sup> .....	1.2	2	2	5	5	5	watts
Useful Power Output.....	120 <sup>‡</sup>	175 <sup>‡</sup>	275 <sup>‡</sup>	100 <sup>†</sup>	165 <sup>†</sup>	235 <sup>†</sup>	watts

**Maximum Circuit Values:**

Grid-No.1-Circuit Resistance, Under any condition:		
With fixed bias.....	25000 <i>max</i>	ohms
Grid-No.2 Circuit Impedance.....	10000 <i>max</i>	ohms
Plate Circuit Impedance.....		See note **

‡ Because the cathode is subjected to back bombardment as the frequency is increased with resultant increase in temperature, the heater voltage should, for optimum life, be reduced to a value such that at the heater voltage obtained at minimum supply voltage conditions (all other voltages constant) the tube performance just starts to show some degradation; e.g., at 470 Mc, heater volts=12.5 (Approx.)

- Ⓞ Measured with special shield adapter.
- The maximum rating for a signal having a minimum peak-to-average power ratio less than 2, such as is obtained in single-tone operation, is 300 ma. During short periods of circuit adjustment under single-tone conditions, the average plate current may be as high as 450 ma.
- Obtained preferably from a separate, well-regulated source.

Ⓞ This value represents the approximate grid-No.1 current obtained due to initial electron velocities and contact-potential effects when grid-No.1 is driven to zero volts at maximum signal.

† Driver power output represents circuit losses and is the actual power measured at input to grid-No.1 circuit. The actual power required depends on the operating frequency and the circuit used. The tube driving power is approximately zero watts.

\* With maximum signal output used as a reference, and without the use of feedback to enhance linearity.

\* This value of useful power is measured at load of output circuit.

\*\* The tube should see an effective plate supply impedance which limits the peak current through the tube under surge conditions to 15 amperes.

Ⓞ Driver power output includes circuit losses and is the actual power measured at the input to the grid circuit. It will vary depending upon the frequency of operation and the circuit used.

‡ Measured in a typical coaxial-cavity circuit.

**OPERATING CONSIDERATIONS**

Type 8121 requires a special 11-contact socket such as Mycalex No.CP464-2, or equivalent, and may be operated in any position. OUTLINE 79, *Outlines* Section.

Adequate forced-air cooling must be provided simultaneously with electrode voltages to limit the radiator core and terminal temperatures to their specified values.

**BEAM POWER TUBE**

Small, ceramic-metal, forced-air-cooled, heater-cathode type having precision-aligned grids and used as linear rf power amplifier and rf power oscillator in mobile or fixed equipment. Useful with full input at frequencies up to 500 Mc.

8122

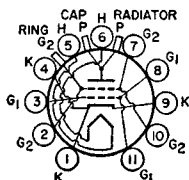

## RCA Transmitting Tubes

HEATER VOLTAGE (AC/DC)†	13.5	volts
HEATER CURRENT at 13.5 volts	1.3	amperes
MINIMUM HEATING TIME	60	seconds
MU-FACTOR, GRID No.2 TO GRID No.1★	12	
DIRECT INTERELECTRODE CAPACITANCES:°		
Grid No.1 to plate	0.13 max	μf
Grid No.1 to cathode	16	μf
Plate to cathode	0.011	μf
Grid No.1 to grid No.2	22	μf
Grid No.2 to plate	6.5	μf
Grid No.2 to cathode	3.2	μf
Cathode to heater	3.4	μf
TERMINAL TEMPERATURE (All terminals)	250 max	°C
RADIATOR CORE TEMPERATURE (See dimensional outline)	250 max	°C

★ For plate volts, 450; grid-No.2 volts, 325; plate amperes, 1.2.

### LINEAR RF POWER AMPLIFIER

#### Single-Sideband Suppressed-Carrier Service

*Peak envelope conditions for a signal having a minimum peak-to-average power ratio of 2*

<b>Maximum CCS Ratings:</b>	<i>Up to 500 Mc</i>	
DC PLATE VOLTAGE	2200 max	volts
DC GRID-NO.2 VOLTAGE	400 max	volts
DC GRID-NO.1 VOLTAGE	-100 max	volts
DC PLATE CURRENT AT PEAK OF ENVELOPE	450* max	ma
DC GRID-NO.1 CURRENT	100 max	ma
PLATE DISSIPATION	400 max	watts
GRID-NO.2 INPUT	8 max	watts
PEAK HEATER-CATHODE VOLTAGE:		
Heater negative with respect to cathode	150 max	volts
Heater positive with respect to cathode	150 max	volts
<b>Typical CCS Operation with Two-Tone Modulation:</b>	<i>At 50 Mc</i>	
DC Plate Voltage	2000	volts
DC Grid-No.2 Voltage*	400	volts
DC Grid-No.1 Voltage*	-35	volts
Zero-Signal DC Plate Current	100	ma
Effective RF Load Resistance	3050	ohms
DC Plate Current at Peak of Envelope	335	ma
Average DC Plate Current	250	ma
DC Grid-No.2 Current at Peak of Envelope	10	ma
Average DC Grid-No.2 Current	7	ma
Average DC Grid-No.1 Current	0.05 <sup>□</sup>	ma
Peak-Envelope Driver Power Output (Approx.) <sup>▲</sup>	0.3	watt
Output-Circuit Efficiency (Approx.)	90	per cent
Distortion Products Level:*		
Third order	29	db
Fifth order	32	db
Useful Power Output (Approx.):		
Average	190#	watts
Peak envelope	380#	watts

#### Maximum Circuit Values:

Grid-No.1 Circuit Resistance, Under any condition:		
With fixed bias	25000 max	ohms
With fixed bias (In Class AB <sub>1</sub> operation)	100000 max	ohms
With cathode bias	Not recommended	
Grid-No.2 Circuit Impedance	10000 max	ohms
Plate Circuit Impedance	See note **	

### RF POWER AMPLIFIER AND OSCILLATOR—Class C Telegraphy and RF POWER AMPLIFIER—Class C FM Telephony

<b>Maximum CCS Ratings:</b>	<i>Up to 500 Mc</i>	
DC PLATE VOLTAGE	2200 max	volts
DC GRID-NO.2 VOLTAGE	400 max	volts
DC GRID-NO.1 VOLTAGE	-100 max	volts
DC PLATE CURRENT	300 max	ma
DC GRID-NO.1 CURRENT	100 max	ma



## Technical Data

GRID-NO.2 INPUT.....	8 max	watts
PLATE DISSIPATION.....	400 max	watts
PEAK HEATER-CATHODE VOLTAGE:		
Heater negative with respect to cathode.....	150 max	volts
Heater positive with respect to cathode.....	150 max	volts

### Typical CCS Operation:

	In Grid-Drive Circuit at 50 Mc				
DC Plate Voltage.....	700	1000	1500	2000	volts
DC Grid-No.2 Voltage.....	175	200	200	200	volts
DC Grid-No.1 Voltage.....	-10	-30	-30	-30	volts
DC Plate Current.....	300	300	300	300	ma
DC Grid-No.2 Current.....	25	20	20	20	ma
DC Grid-No.1 Current.....	50	40	40	30	ma
Driver Power Output (Approx.) <sup>Ⓞ</sup> .....	1.2	2	2	2	watts
Useful Power Output#.....	120	175	275	375	watts

	In Grid-Drive Circuit at 470 Mc				
DC Plate Voltage.....	700	1000	1500	2000	volts
DC Grid-No.2 Voltage.....	200	200	200	200	volts
DC Grid-No.1 Voltage.....	-30	-30	-30	-30	volts
DC Plate Current.....	300	300	300	300	ma
DC Grid-No.2 Current.....	10	10	5	5	ma
DC Grid-No.1 Current.....	30	30	30	30	ma
Driver Power Output (Approx.) <sup>Ⓞ</sup> .....	5	5	5	5	watts
Useful Power Output#.....	100	165	235	300	watts

### Maximum Circuit Values:

Grid-No.1 Circuit Resistance, Under any condition:		
With fixed bias.....	25000 max	ohms
Grid-No.2 Circuit Impedance.....	10000 max	ohms
Plate Circuit Impedance.....		See note **

† Because the cathode is subjected to back bombardment as the frequency is increased with resultant increase in temperature, the heater voltage should, for optimum life, be reduced to a value such that at the heater voltage obtained at minimum supply voltage conditions (all other voltages constant) the tube performance just starts to show some degradation; e.g., at 470 Mc, heater volts=12.5 (approx.).

Ⓞ Measured with special shield adapter.

• The maximum rating for a signal having a minimum peak-to-average power ratio less than 2, such as is obtained in single-tone operation, is 300 ma. During short periods of circuit adjustment under single-tone conditions, the average plate current may be as high as 450 ma.

• Obtained preferably from a separate, well-regulated source.

□ This value represents the approximate grid No.1 current obtained due to initial electron velocities and contact-potential effects when grid-No.1 is driven to zero volts at maximum signal.

▲ Driver power output represents circuit losses and is the actual power measured at input to grid-No.1 circuit. The actual power required depends on the operating frequency and the circuit used. The tube driving power is approximately zero watts.

\* With maximum signal output used as a reference, and without the use of feedback to enhance linearity.

# This value of useful power is measured at load of output circuit.

\*\* The tube should see an effective plate supply impedance which limits the peak current through the tube under surge conditions to 15 amperes.

Ⓞ Driver power output includes circuit losses and is the actual power measured at the input to the grid circuit. It will vary depending upon the frequency of operation and the circuit used.

† Measured in a typical coaxial-cavity circuit.

TYPICAL PLATE CHARACTERISTICS

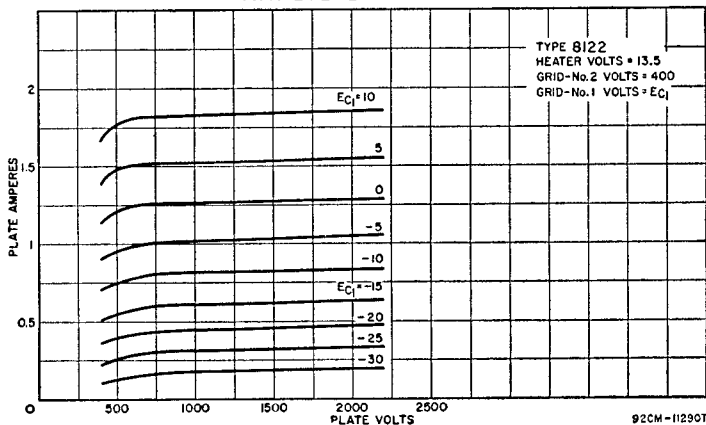

TYPICAL CHARACTERISTICS

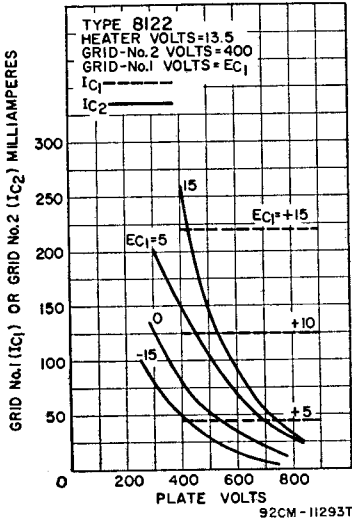

TYPICAL COOLING REQUIREMENTS

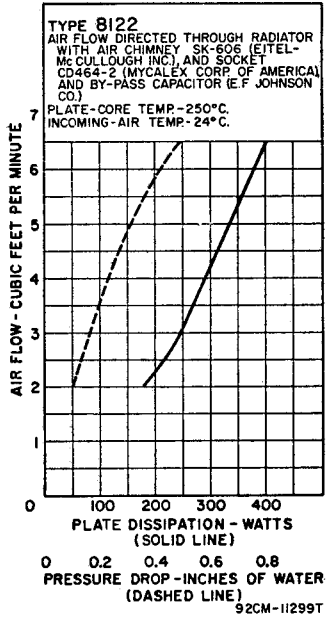

OPERATING CONSIDERATIONS

Type 8122 requires a special 11-contact socket such as Mycalex No. CP464-2, or equivalent, and may be operated in any position. OUTLINE 81, *Outlines* Section.

Adequate forced-air cooling must be provided simultaneously with electrode voltages to limit the radiator core and terminal temperatures to their specified values.

MEDIUM-MU TRIODE

Seven-pin miniature heater-cathode type used as af amplifier and as rf amplifier and oscillator at frequencies up to 500 Mc. Class A<sub>1</sub> Amplifier maximum CCS plate dissipation (design-center value), 1.6 watts. Direct interelectrode capacitances: grid to plate, 1.4  $\mu\mu\text{f}$ ; grid to cathode and heater, 1.2  $\mu\mu\text{f}$ ; plate to cathode and heater, 1.1  $\mu\mu\text{f}$ . Requires Miniature seven-contact socket and may be operated in any position.

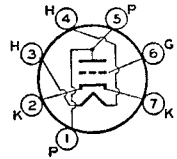

9002

Maximum over-all length, 1-3/4 inch; maximum diameter, 3/4 inch. Except for interelectrode capacitances, the 9002 is electrically identical with type 955. The 9002 is a DISCONTINUED type listed for reference only.

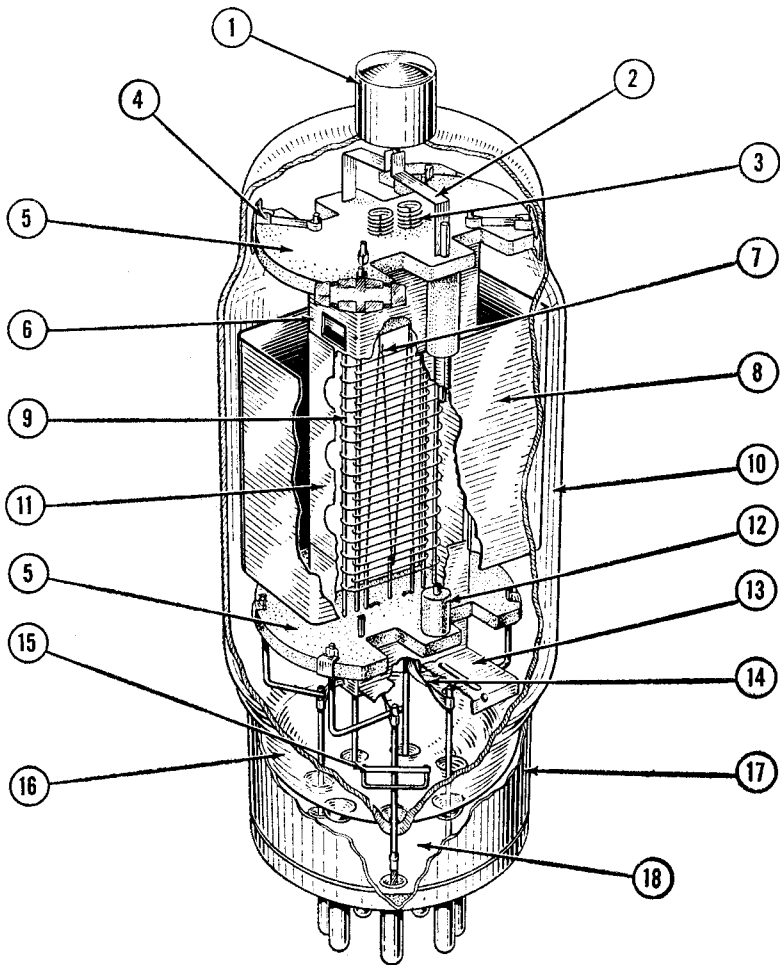

## Tube-Part Materials Used in RCA-813 Beam Power Tube

- |  |  |
|--|--|
| <p>1. MEDIUM METAL CAP—nickel-plated brass</p> <p>2. PLATE CONNECTOR—nickel</p> <p>3. FILAMENT SUPPORT SPRINGS—tungsten</p> <p>4. MOUNT SPACER—nickel-chromium strip</p> <p>5. MOUNT SUPPORT—ceramic</p> <p>6. TOP SHIELD—nickel</p> <p>7. HEAVY-DUTY FILAMENT—thoriated tungsten</p> <p>8. PLATE—zirconium-coated nickel</p> <p>9. ALIGNED-TURN CONTROL GRID (GRID No. 1) AND SCREEN GRID (GRID No. 2)—molybdenum</p> | <p>10. BULB OR ENVELOPE—hard glass</p> <p>11. BEAM-FORMING ELECTRODE—nickel</p> <p>12. PLATE-SUPPORT SPACER—ceramic</p> <p>13. BOTTOM SHIELD DISK—nickel</p> <p>14. FILAMENT CONNECTOR—nickel-plated steel</p> <p>15. DIRECTIVE-TYPE GETTER</p> <p>16. MOLDED-FLARE STEM—hard glass</p> <p>17. GIANT BASE—aluminum with ceramic insert</p> <p>18. TUNGSTEN-TO-GLASS SEAL</p> |
|--|--|

# Outlines

## OUTLINES 1-11

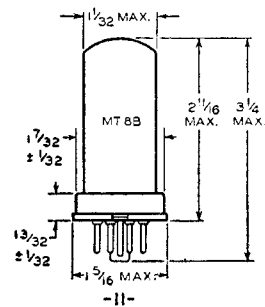
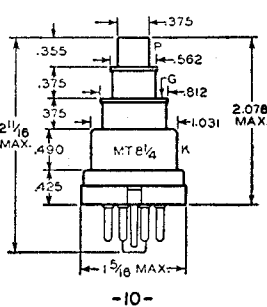
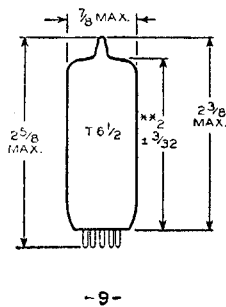
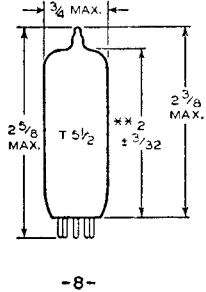
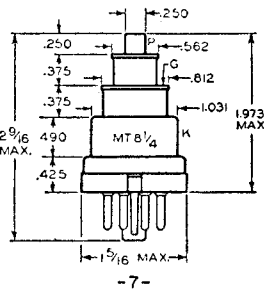
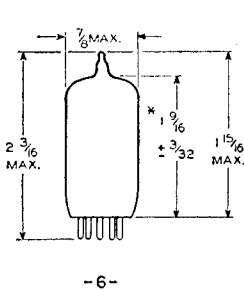
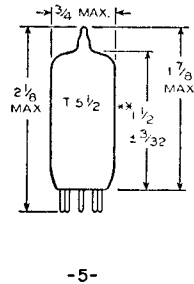
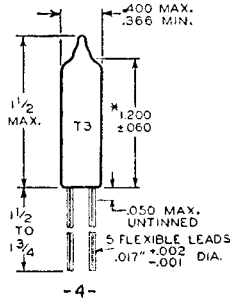
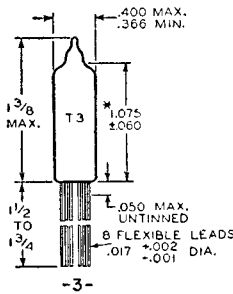
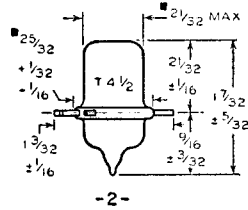
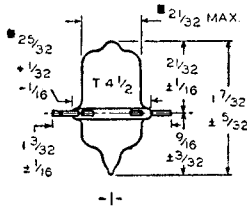

\* Including eccentricity.

\*\* Measured from bulb seat to bulb-top line as determined by ring gauge of 0.210" ± 0.001" I.D.

\*\* Measured from base seat to bulb-top line as determined by ring gauge of 7/16" I.D.

NOTE: Where units are not given, dimensions are in inches.

OUTLINES 12-20

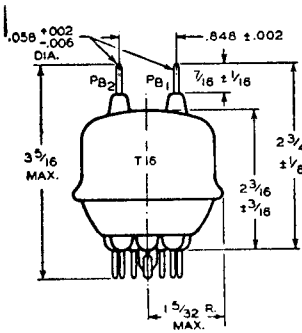

-12-

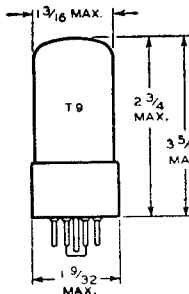

-13-

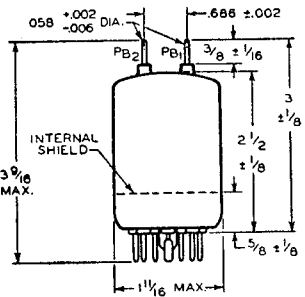

-14-

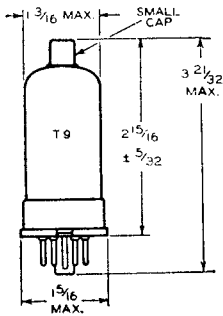

-15-

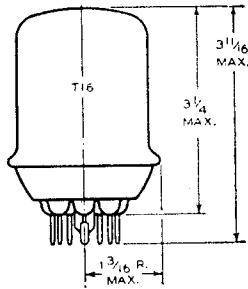

-16-

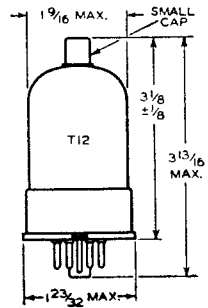

-17-

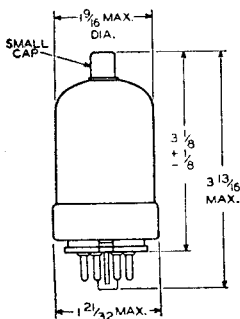

-18-

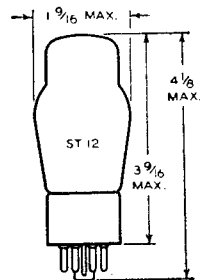

-19-

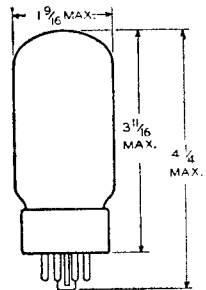

-20-

OUTLINES 21-29

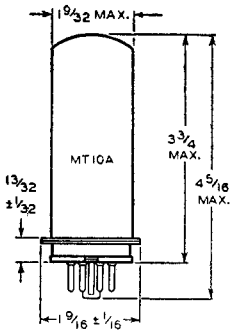

-21-

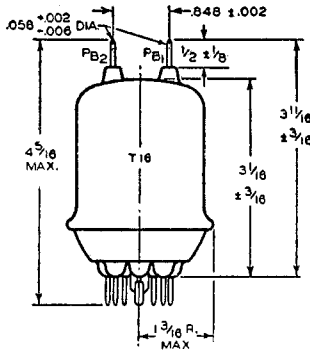

-22-

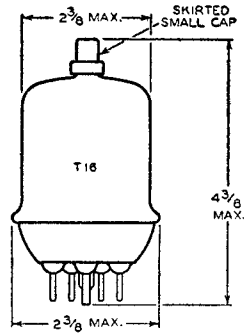

-23-

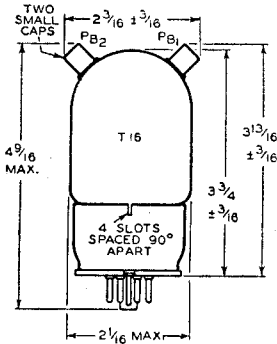

-24-

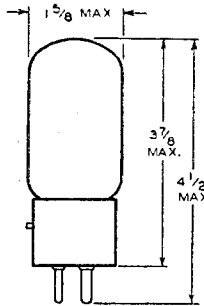

-25-

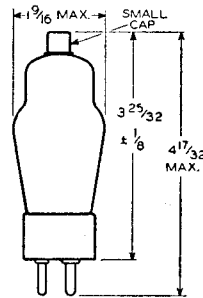

-26-

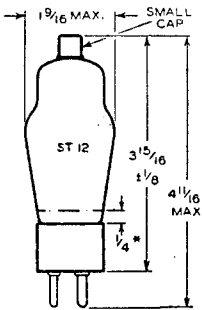

-27-

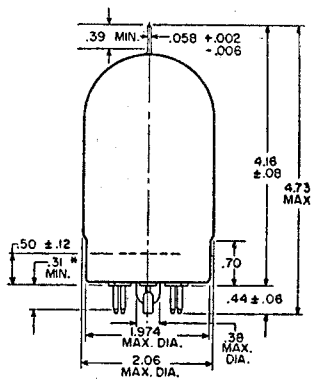

-28-

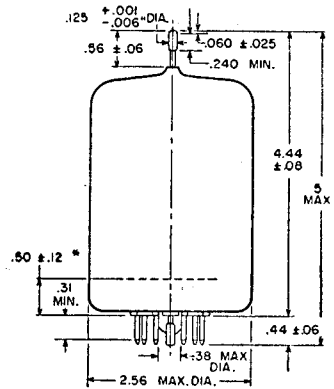

-29-

\* Zone where condensed-mercury temperature should be measured.

OUTLINES 30-38

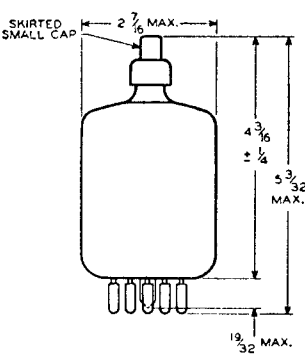

-30-

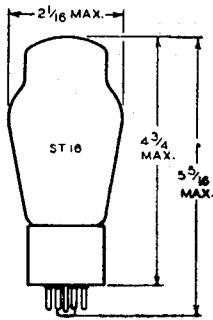

-31-

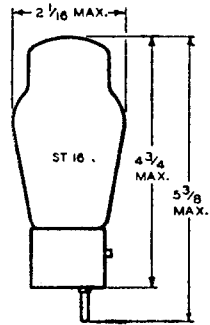

-32-

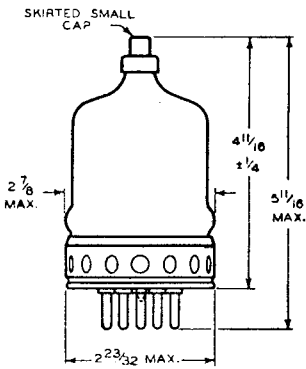

-33-

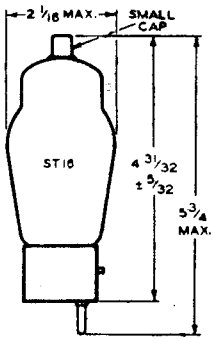

-34-

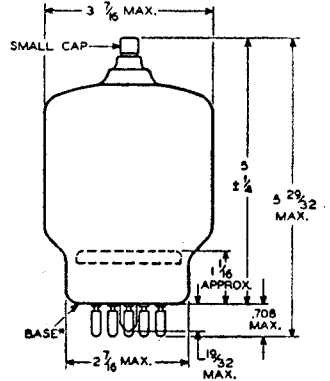

-35-

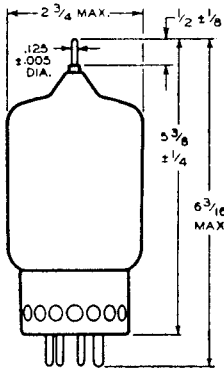

-36-

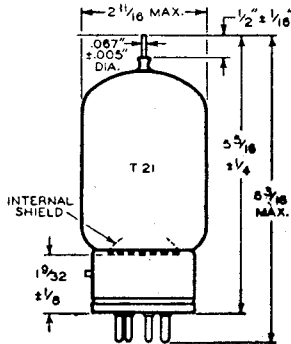

-37-

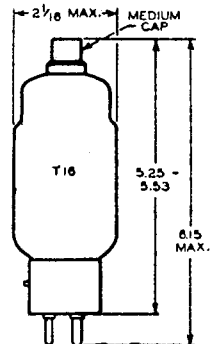

-38-

\* Special Button Giant 5-pin base.

OUTLINES 39-47

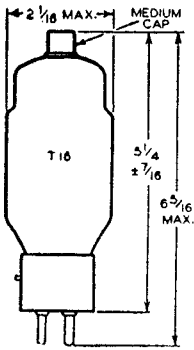

-39-

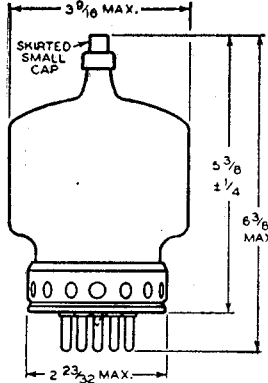

-40-

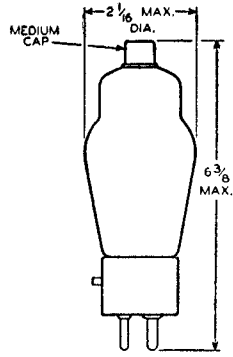

-41-

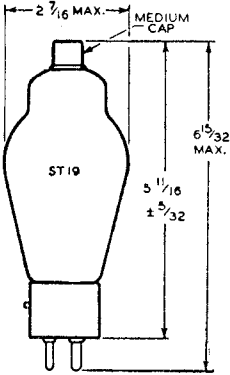

-42-

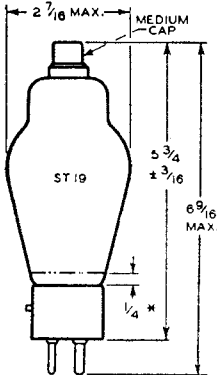

-43-

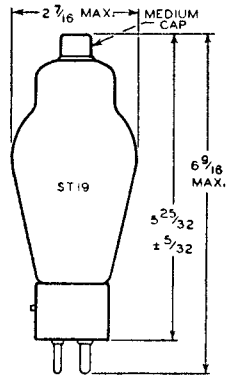

-44-

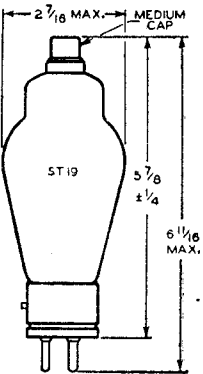

-45-

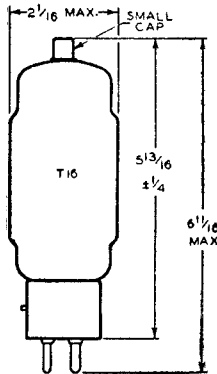

-46-

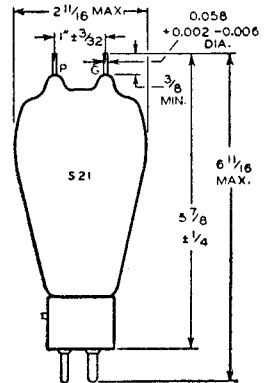

-47-

\* Zone where condensed-mercury temperature should be measured.



OUTLINES 48-53

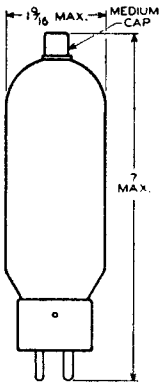

-48-

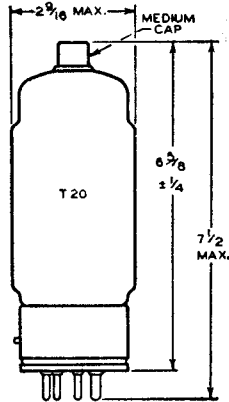

-49-

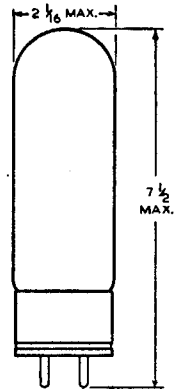

-50-

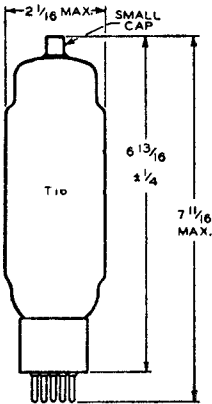

-51-

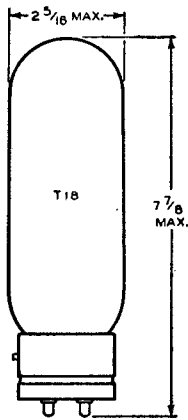

-52-

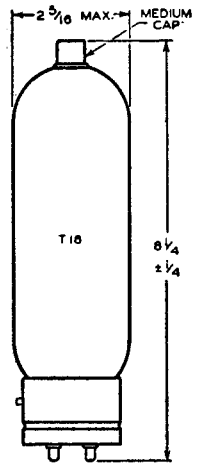

-53-

OUTLINES 54-58

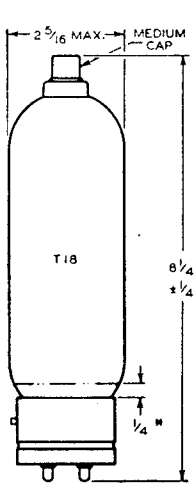

-54-

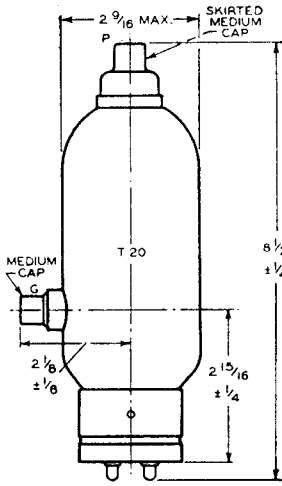

-55-

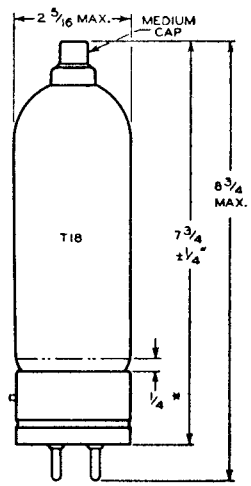

-56-

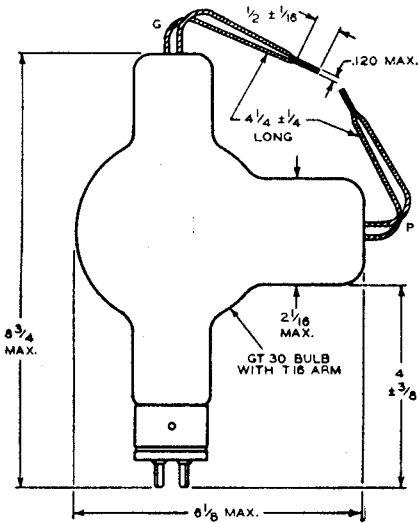

-57-

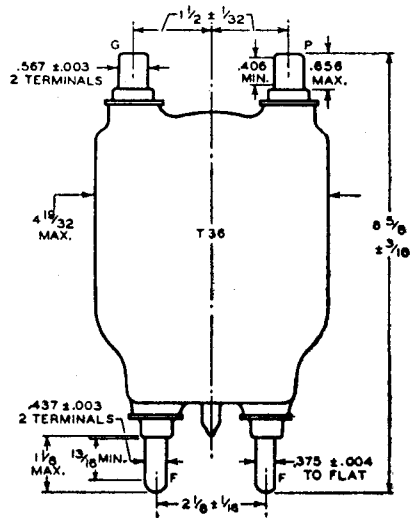

-58-

\* Zone where condensed-mercury temperature should be measured.

OUTLINES 59-63

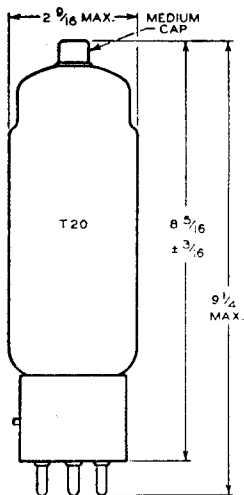

-59-

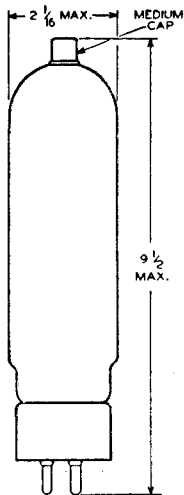

-60-

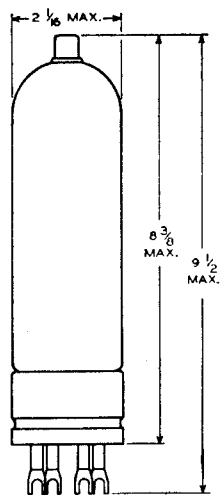

-61-

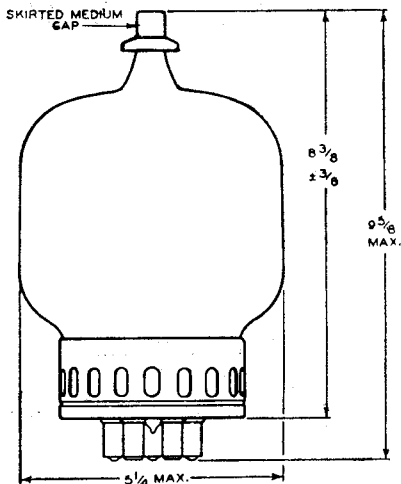

-62-

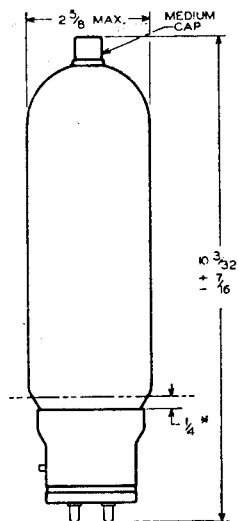

-63-

\* Zone where condensed-mercury temperature should be measured.

OUTLINES 64-67

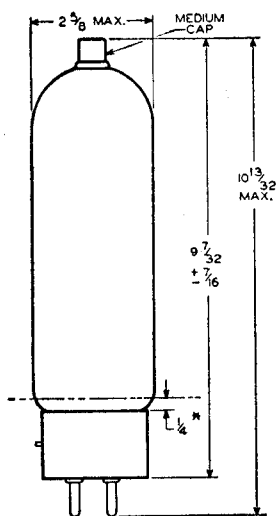

- 64 -

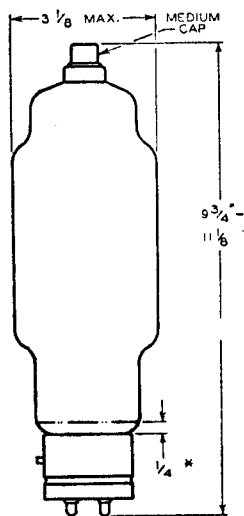

- 65 -

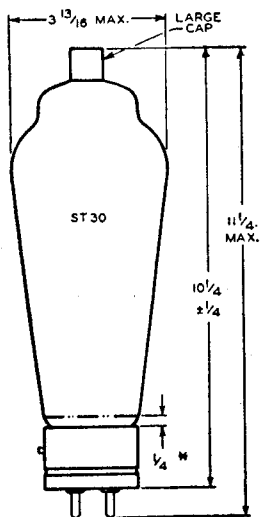

- 66 -

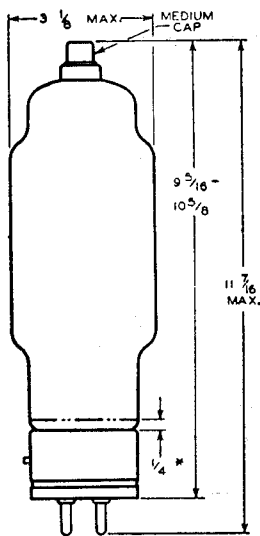

- 67 -

\* Zone where condensed-mercury temperature should be measured.



OUTLINES 74-76

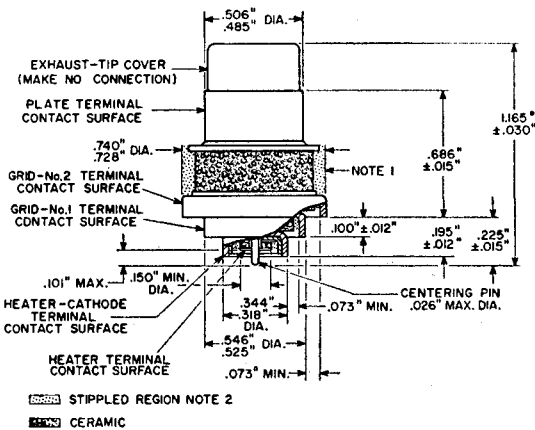
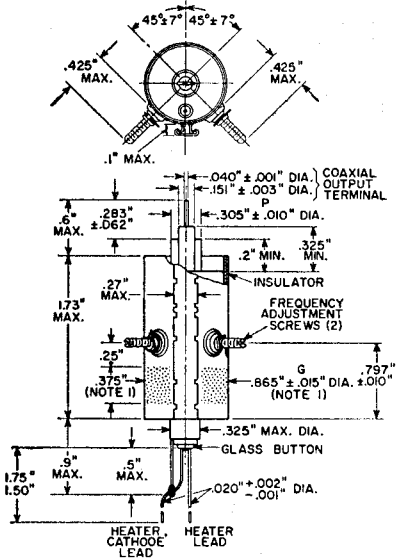
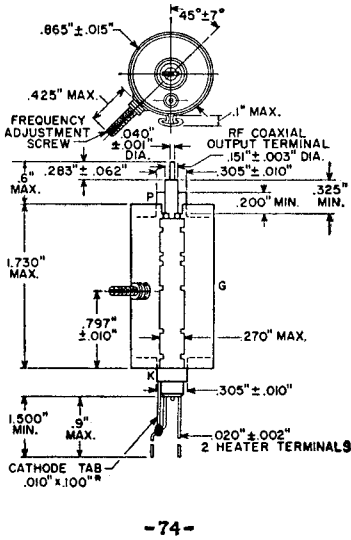

\* Applies to types 6562 and 6562/5794A only. Type 5794 does not have cathode tab and length of heater terminal is only  $0.200'' \pm 0.040''$ .  
 NOTE 1: Stippled region (which extends around tube) indicates recommended clamping and contact area.  
 NOTE 2: Keep stippled regions clear; do not allow contacts or circuit components to protrude into these annular volumes.

OUTLINES 77-80

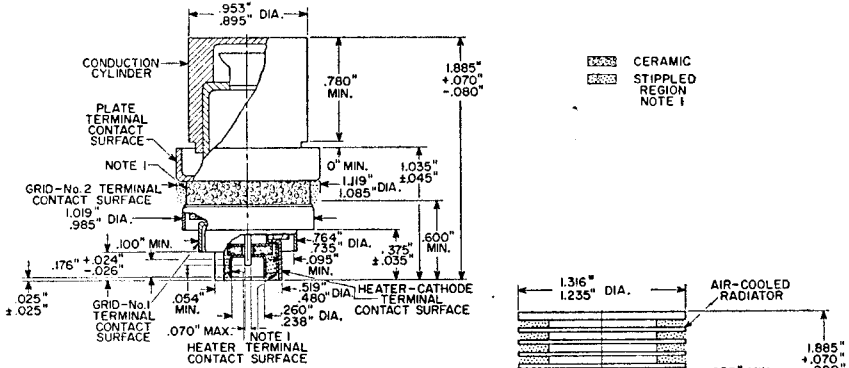

- 77 -

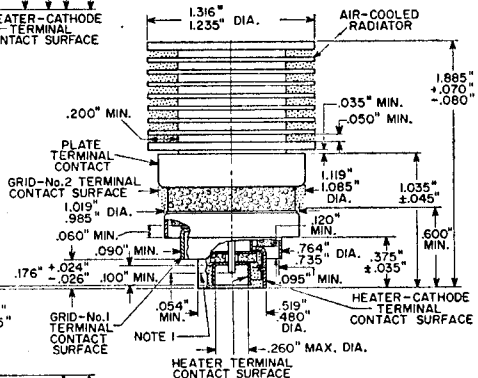

- 78 -

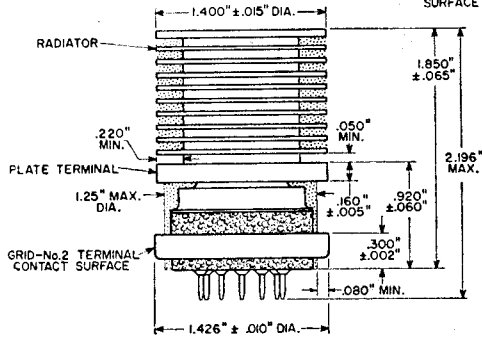

- 79 -

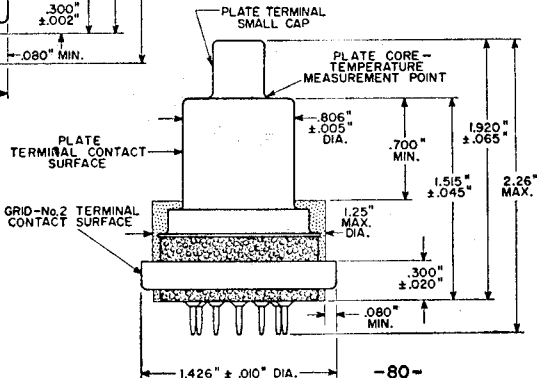

- 80 -

NOTE 1: Keep stippled regions clear; do not allow contacts or circuit components to protrude into these annular volumes.

OUTLINES 81-82

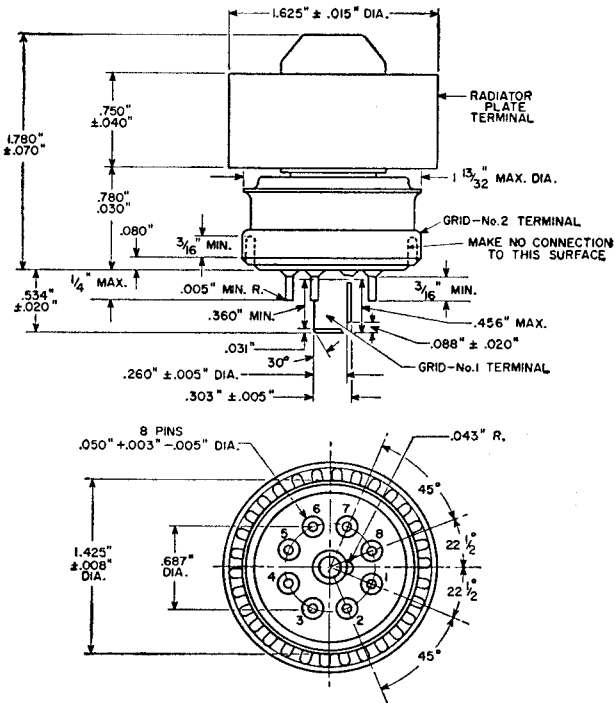
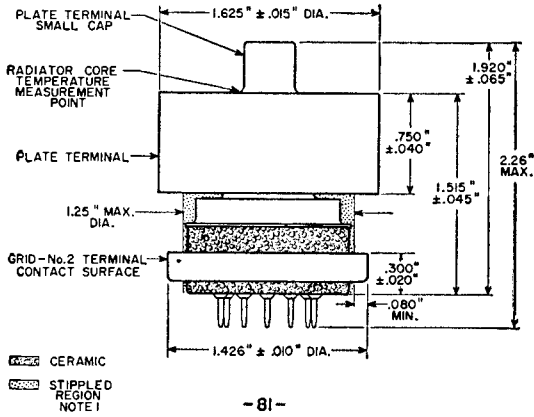

NOTE 1: Keep stippled regions clear; do not allow contacts or circuit components to protrude into these annular volumes.



OUTLINES 83-84

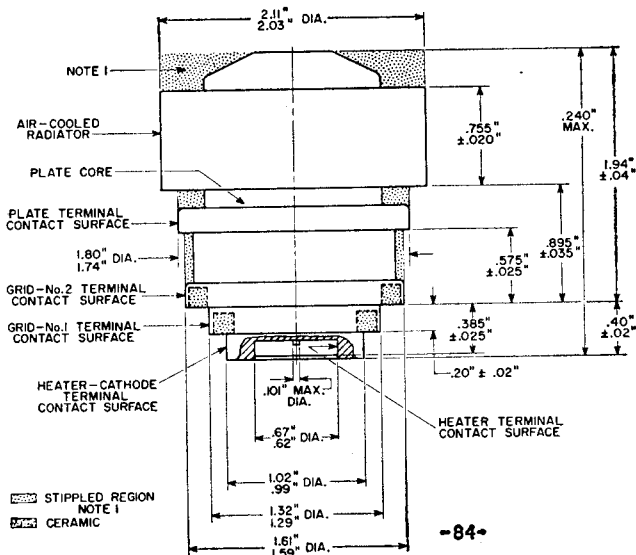
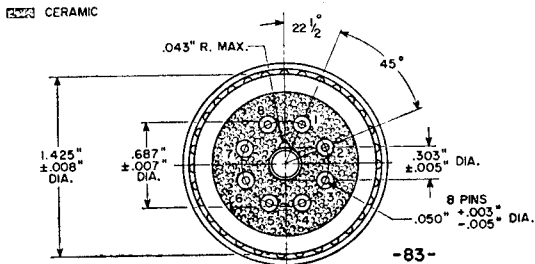
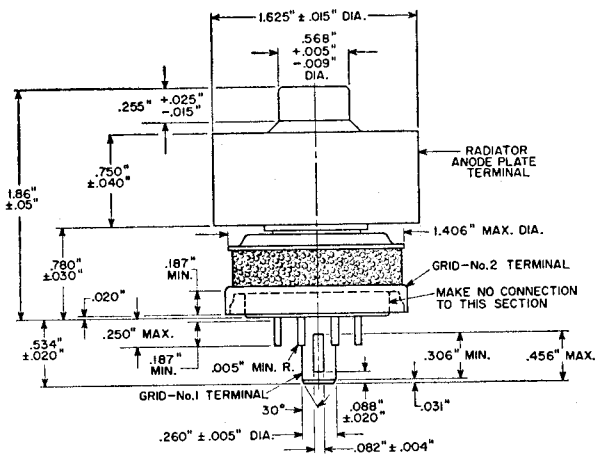

NOTE 1: Keep stippled regions clear; do not allow contacts or circuit components to protrude into these annular volumes. Diameters of stippled area above air-cooled radiator, plate-terminal contact surface, and grid-No.2 terminal contact surface shall not be greater than its associated diameter.

OUTLINES 85-87

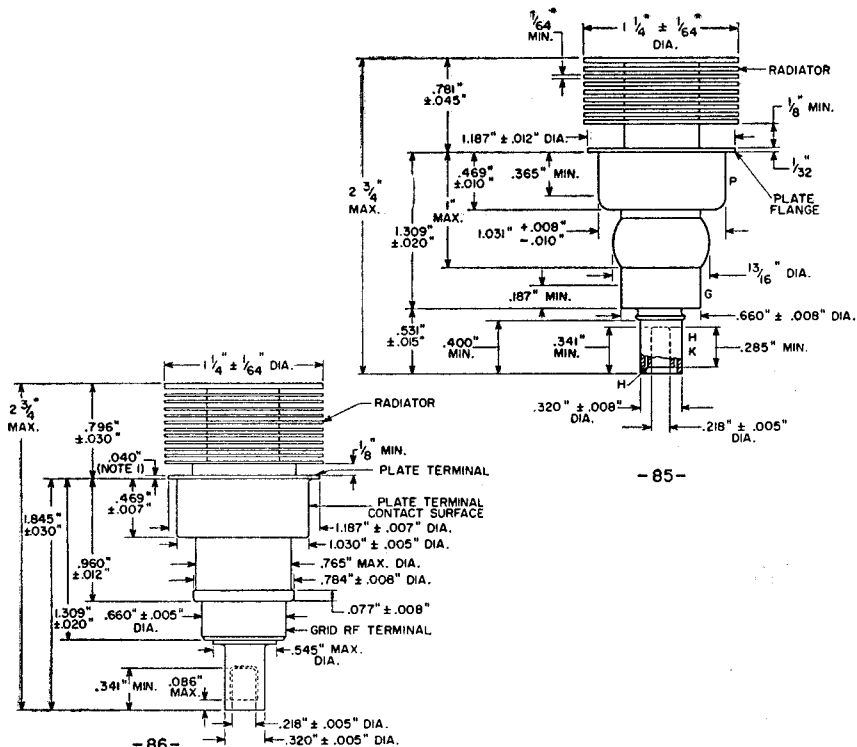

-85-

-86-

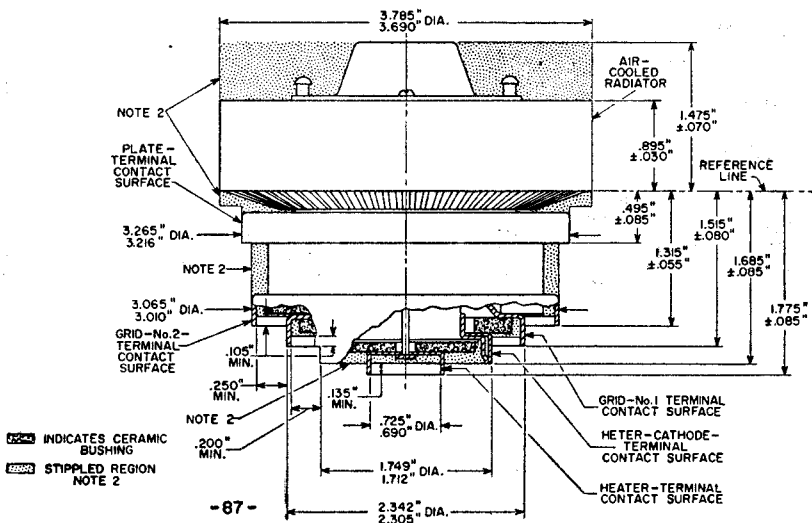

-87-

NOTE 1: Only this flange may be used as a socket stop and clamp.

NOTE 2: Keep stippled regions clear; do not allow contacts or circuit components to protrude into these annular volumes.

OUTLINES 88-90

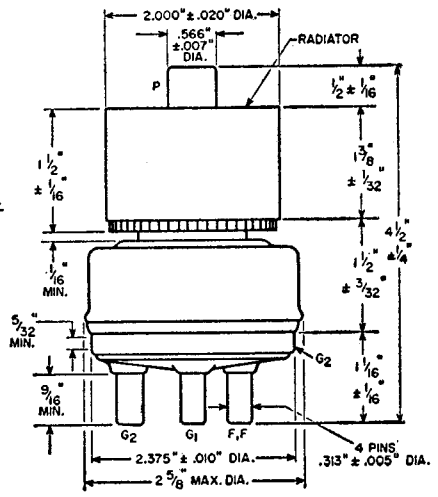
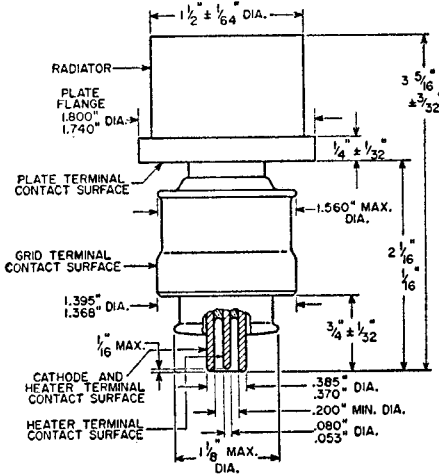
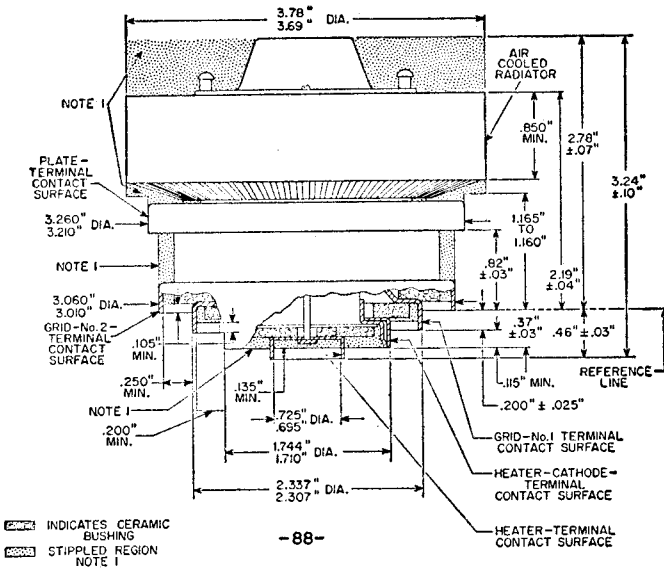

NOTE 1: Keep stippled regions clear; do not allow contacts or circuit components to protrude into these annular volumes.

OUTLINES 91-92

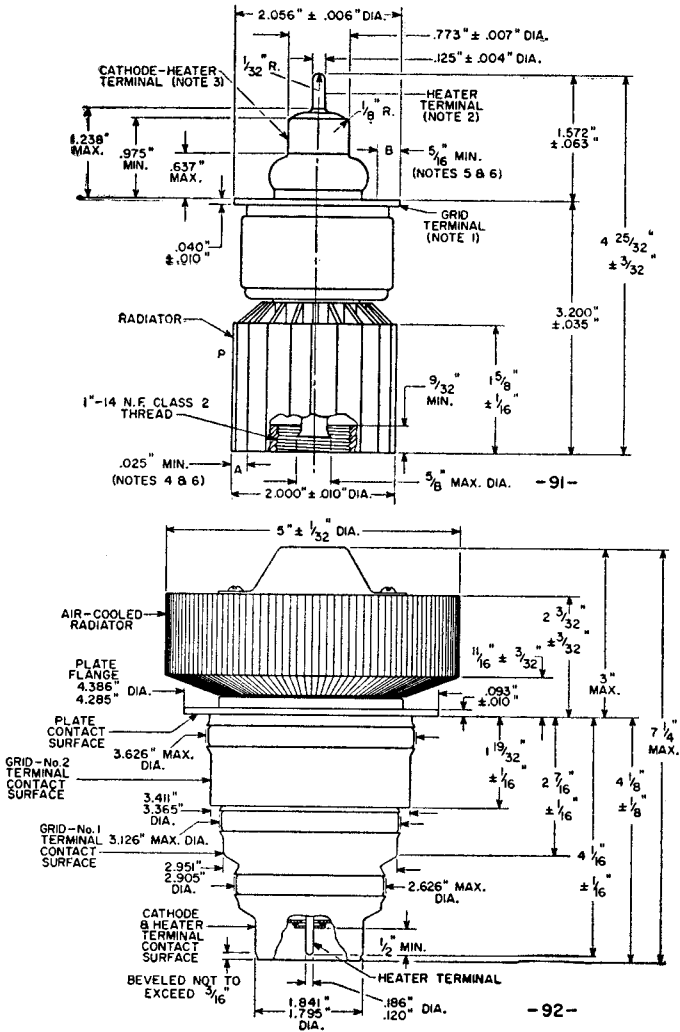

- NOTE 1: Maximum eccentricity of the axis of the grid-terminal flange with respect to the axis of the plate radiator is  $0.040$ ", measured within  $1/32$ " of the bottom of the radiator.
- NOTE 2: Maximum eccentricity of the axis of the heater terminal with respect to the axis of the cathode-heater terminal is  $0.020$ ".
- NOTE 3: Maximum eccentricity of the axis of the cathode-heater terminal with respect to the axis of the grid-terminal flange is  $0.020$ ".
- NOTE 4: Surface of annular area indicated by "A" on bottom of radiator is in the same plane within  $0.005$ ", as determined by a gauge  $1/16$ " wide and  $0.005$ " thick. This gauge will not enter more than  $1/16$ " with the bottom of the radiator resting on a flat plate.
- NOTE 5: Surface of annular area indicated by "B" on the grid-terminal flange is in the same plane within  $0.008$ ", as determined by the gauge method described in Note 4.
- NOTE 6: Surface of annular area indicated by "A" on bottom of radiator is parallel within  $0.030$ " to the surface of the annular area indicated by "B" on the grid-terminal flange.

OUTLINES 93-94

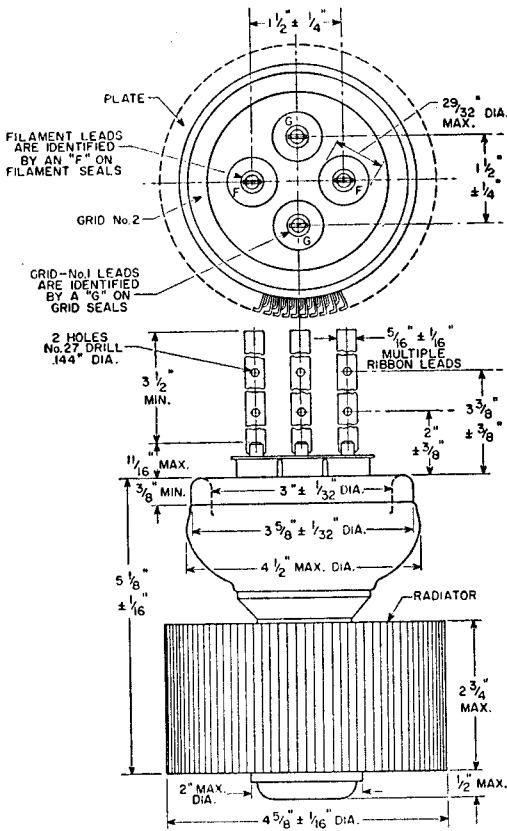

- 93 -

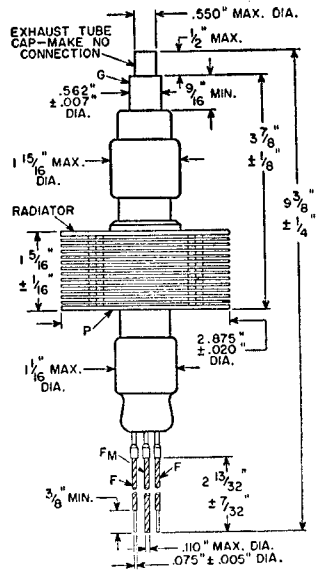

- 94 -

LIST OF CIRCUITS

*Circuit No.*

Variable-Frequency Oscillator (2.5-4.0 Mc).....	5-1
Variable-Frequency Oscillator (8.0-8.6 Mc).....	5-2
Crystal Oscillator for Fundamental Output.....	5-3
Crystal Oscillator for Harmonic Output.....	5-4
175-Mc Amplifier, Doubler, or Tripler.....	5-5
Triode Amplifier, Class C Telegraphy Service.....	5-6
Beam-Power-Tube Amplifier, Class C Telegraphy Service.....	5-7
Push-Pull Triode Amplifier, Class C Plate-Modulated Service.....	5-8
Push-Pull Beam-Power-Tube Amplifier, Class C Plate-Modulated Service.....	5-9
Class B Push-Pull Triode Modulator (590 watts).....	5-10
Class B Modulator with Type 807 in Special Triode Connection (120 watts).....	5-11
Class AB <sub>1</sub> , Push-Pull Modulator (100 watts).....	5-12
Class B Linear RF Amplifier for Single-Sideband.....	5-13
50-Mc Transmitter (120 watts).....	5-14
Single-Sideband Exciter (filter type).....	5-15
144-148 Mc Transmitter for Mobile Operation.....	5-16
Five-Band 10-80 Meter Transmitter (90 watts).....	5-17
Typical Coaxial Cavity for Beam Power Tube 7650.....	5-18
462-Megacycle Transmitter for Fixed or Mobile Operation.....	5-19
Transmitter Power-Supply Circuit.....	5-20
Oscillator for Dielectric Heating (27 Mc).....	5-21
Oscillator for Induction Heating (450 kc).....	5-22
VHF Oscillator for Dielectric Heating (160 Mc).....	5-23

## Circuits

The circuits presented in the following pages have been included in this Manual primarily to illustrate the use of generic tube types in diversified transmitting and industrial applications. These circuits have been conservatively designed and are capable of excellent performance. Several of these circuits, namely 5-13, 5-15, 5-17, and 5-20, are based on circuits which have been described in articles in QST magazine. These circuits are used with permission of the American Radio Relay League.

Although relatively few circuits are given, it is often practical to use a portion of one circuit in combination with portions of other circuits to obtain a design meeting specific requirements. In general, almost any circuit shown using a triode, beam power tube, or pentode type is equally suitable for any other tube type in the same generic group, provided the necessary revisions are made to meet the ratings of the tube used.

Electrical specifications are given for the circuit components to assist those interested in home construction. Layouts and mechanical details are omitted because they vary widely with the requirements of individual set builders and with the sizes and shapes of the components employed.

The results that may be expected by those undertaking construction of any of these circuits depend as much on the quality of the components selected

and on the care employed in layout, construction, and adjustment as on the circuits themselves.

The voltage ratings specified for capacitors are the minimum dc working voltages required. Where paper, mica, or ceramic capacitors are called for, there is no objection to using capacitors having higher voltage ratings than those specified, except insofar as the physical sizes of such capacitors may affect equipment layout. However, if electrolytic capacitors having substantially higher voltage ratings than those specified are used, they may not "form" completely at the voltages present in these circuits, with the result that the effective capacitances of such units may be below their rated values. The wattage ratings specified for resistors assume methods of construction that provide adequate ventilation; compact installations having poor ventilation may require resistors of higher wattage ratings.

Information on the characteristics and application features of each tube will be found in the *Tube Types—Technical Data* Section of this Manual, or, for the receiving-type tubes, in the *Tube Types—Technical Data* Section of the RCA RECEIVING TUBE MANUAL. This information, as well as the material in the early sections of this Manual on installation, application, and operation of power and rectifier tubes, will prove of assistance in understanding and utilizing the circuits

(5-1)

### VARIABLE-FREQUENCY OSCILLATOR

Frequency 3.5 to 4.0 Mc (80 meters) Output 3 watts (approx.)

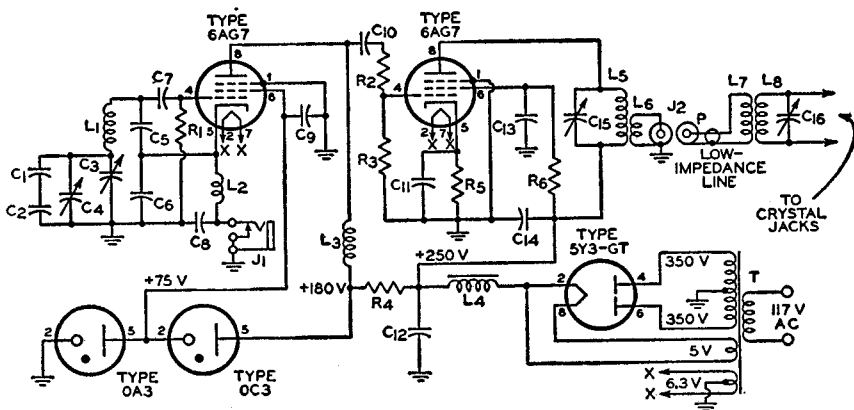

$C_1$  = 15  $\mu$ f, ceramic, zero temperature coefficient  
 $C_2$  = 100  $\mu$ f, ceramic, negative temperature coefficient 750 PPM  
 $C_3$  = 6-75  $\mu$ f, trimmer, air gap 0.015 inch, Hammarlund APC-75 or equivalent  
 $C_4$  = 10-75  $\mu$ f, trimmer, air gap 0.060 inch, Bud GE-2014 or equivalent  
 $C_5$   $C_6$  = 0.001  $\mu$ f, silver mica, 500 v.  
 $C_7$  = 100  $\mu$ f, silver mica, 500 v.  
 $C_8$   $C_9$   $C_{11}$   $C_{13}$   $C_{14}$  = 0.01  $\mu$ f, disk ceramic, 600 v.  
 $C_{10}$  = 15  $\mu$ f, silver mica, 500 v.

$C_{15}$   $C_{16}$  = 3-30  $\mu$ f, trimmer, mica  
 $J_1$  = Closed-circuit jack for key  
 $J_2$  = Coaxial receptacle for P  
 $L_1$  = 28 turns of No. 18 Enam. spaced over 2 3/4 inches on 1 3/4-inch diameter ceramic form, National XR-13 or equivalent  
 $L_2$   $L_3$  = 2.5 mh, 125 ma, rf choke  
 $L_4$  = 8 henries, 80 ma, choke  
 $L_5$  = No. 26 Enam., close wound for 13/16 inch on 1-5/16-inch diameter (B & W Mini-inductor 3016 or equivalent may be used)  
 $L_6$  = 3 turns No. 18 hookup wire wound on  $L_5$  at "cold" end

$L_7$  = 56 turns No. 26 Enam. random wound for approx. 3/4 inch on 1 1/8-inch-diameter coil form  
 $L_8$  = 3 turns No. 18 hookup wire wound over "ground" end of  $L_7$   
 P = Coaxial plug for  $J_2$   
 $R_1$   $R_2$  = 100000 ohms, 0.5 watt  
 $R_3$  = 27000 ohms, 0.5 watt  
 $R_4$  = 2000 ohms, 10 watts  
 $R_5$  = 100 ohms, 0.5 watt  
 $R_6$  = 15000 ohms, 1 watt  
 T = Power transformer; 350-0-350 volts rms, 90 ma; 5 volts rms, 2 amperes; 6.3 volts rms, 3.5 amperes



(5-2)

### VARIABLE-FREQUENCY OSCILLATOR

Frequency 8.0 to 8.6 Mc    Output 150 volts peak (Approx.) at 16-17.2 Mc

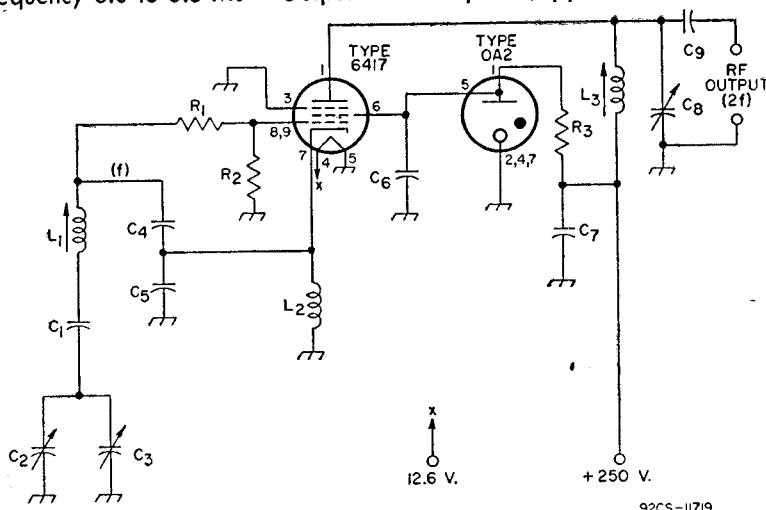

- C<sub>1</sub> = 220 μμf, ceramic, zero temperature coefficient
- C<sub>2</sub> = 5.5-20 μμf, variable, air gap 0.0245 inch, double-bearing Hammarlund MC-20-S or equivalent
- C<sub>3</sub> = 4.5-25 μμf, trimmer, ceramic, zero temperature coefficient Centralab 822-AZ or equivalent
- C<sub>4</sub> C<sub>5</sub> = 390 μμf, silver mica, zero temperature coefficient

- C<sub>6</sub> C<sub>7</sub> = 0.001 μf, disk ceramic, 600 v.
- C<sub>8</sub> = 2.3-14.2 μμf, variable, miniature, air gap 0.017 inch, Johnson 160-107 or equivalent
- C<sub>9</sub> = 100 μμf, disk ceramic, 600 v.
- L<sub>1</sub> = 32 turns of No. 24 Enam. on 1/2-inch diameter ceramic form, winding length 11/16 inch; form, CTC PLS7-2C4L or equivalent; tuned with powdered-iron slug

- L<sub>2</sub> = RF choke, 750 μh
- L<sub>3</sub> = 26 turns of No. 28 Enam. on 1/4-inch diameter ceramic form, winding length 3/8-inch; form, CTC PLS6-2C4L or equivalent; tuned with powdered-iron slug
- R<sub>1</sub> = 68 ohms, 0.5 watt, carbon
- R<sub>2</sub> = 47000 ohms, 0.5 watt, carbon
- R<sub>3</sub> = 5000 ohms, 10 watts, wire-wound

NOTE: Capacitor C<sub>2</sub> tunes from 8.0 to 8.6 Mc to permit frequency multiplication for both 6-meter and 2-meter transmitters. The tuned circuit L<sub>3</sub> and C<sub>8</sub> provides an rf output at twice the VFO frequency. For an output at 8.0 to 8.6 Mc, replace L<sub>3</sub> with 2.5-mh rf choke and eliminate C<sub>8</sub>.

(5-3)

### CRYSTAL OSCILLATOR FOR FUNDAMENTAL OUTPUT

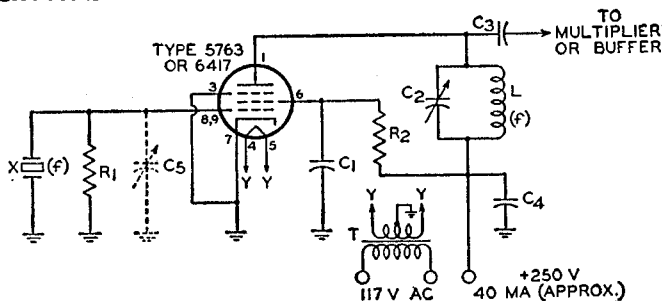

- C<sub>1</sub> C<sub>5</sub> = 0.005 μf, mica, 600 v.
- C<sub>2</sub> = 1.0 μμf per meter (approximate value for resonance at frequency f), variable, air gap 0.015 inch
- C<sub>3</sub> = 50 μμf (approx.), mica (may

- be in range of 10 to 100 μμf), 600 v.
- C<sub>4</sub> = 3-30 μμf air padder. (Normally omitted. Use only if it is desired to vary operating frequency slightly from crystal frequency)

- L = Tune to fundamental frequency f with C<sub>2</sub>
- R<sub>1</sub> = 27000 ohms, 0.5 watt
- R<sub>2</sub> = 47000 ohms, 0.5 watt
- T = Filament transformer
- X = Crystal

(5-4)

**CRYSTAL OSCILLATOR FOR HARMONIC OUTPUT**

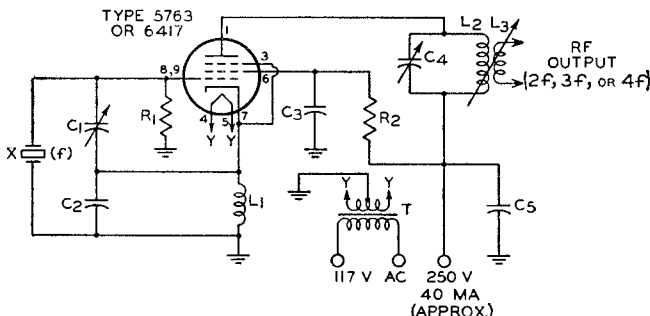

- C<sub>1</sub>=3-35  $\mu$ f, air trimmer
- C<sub>2</sub>=200  $\mu$ f, silver mica, 500v.
- C<sub>3</sub> C<sub>5</sub>=0.01  $\mu$ f, disk ceramic, 600 v.
- C<sub>4</sub>=1.5  $\mu$ f per meter (approximate value for resonance at

- frequency 2f, 3f, or 4f),
- variable air gap 0.023 inch
- L<sub>1</sub>=2.5 mh, rf choke
- L<sub>2</sub>=Tune to harmonic
- frequency 2f, 3f, or 4f with
- C<sub>4</sub> (See note)

- L<sub>3</sub>=2-turn link at rf ground
- end of L<sub>2</sub>
- R<sub>1</sub>=100000 ohms, 0.5 watt
- R<sub>2</sub>=22000 ohms, 0.5 watt
- T=Filament transformer
- X=Crystal

NOTE: For tank-coil design information, refer to **Parallel-Tuned Tank Circuits** in the *Power-Tube Circuit-Design Considerations* Section.

(5-5)

**175-MC AMPLIFIER, DOUBLER, OR TRIPLER**

Power Output (Approx.) 8.5 Watts for Amplifier, 3 Watts for Doubler, 1.4 Watts for Tripler

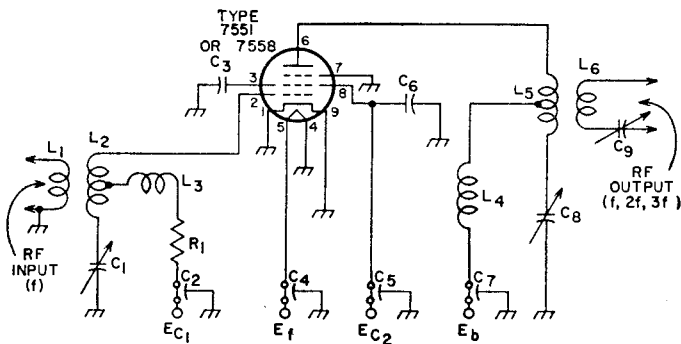

- C<sub>1</sub> C<sub>3</sub>=7-45  $\mu$ f, trimmer, disk ceramic; for doubler C<sub>1</sub>=4-30  $\mu$ f disk ceramic
- C<sub>2</sub> C<sub>4</sub> C<sub>5</sub> C<sub>7</sub>=1000  $\mu$ f, feed-through, silver mica
- C<sub>3</sub> C<sub>6</sub>=1000  $\mu$ f, silver mica
- C<sub>8</sub>=3.6-15  $\mu$ f, variable, air gap 0.045 inch, Hammarlund HF-15-X or equivalent
- E<sub>b</sub>=300 v. for amplifier; 250 v. for doubler; 200 v. for tripler
- E<sub>c1</sub>=-42 v. for amplifier; -53 v. for doubler; -90 v. for tripler
- E<sub>c2</sub>=200 v. for amplifier, doubler and tripler

- E<sub>f</sub>=12-15 v. for 7551; 6.3 v. for 7558
- f=175 Mc for amplifier, 87.5 Mc for doubler, 58.5 Mc for tripler
- L<sub>1</sub>=2 turns of No. 18 Enam. wound on  $\frac{1}{2}$ -inch diameter form, close wound
- L<sub>2</sub>=5 turns centertapped for amplifier, 7 turns center tapped for doubler, 8 turns center tapped for tripler; No. 18 Enam. wound on  $\frac{1}{2}$ -inch diameter form, close wound
- L<sub>3</sub> L<sub>4</sub>=RF choke, 1.8  $\mu$ h, 1000 ma, 80-200 Mc, Ohmite Z-144

- or equivalent; for doubler and tripler L<sub>5</sub>=7.0  $\mu$ h, 1000 ma, 35 -110 Mc, Ohmite Z-50 or equivalent
- L<sub>5</sub>=4 turns center tapped No. 18 Enam. wound on  $\frac{1}{2}$ -inch diameter form, close wound
- L<sub>6</sub>=3 turns of No. 18 Enam. wound on  $\frac{1}{2}$ -inch diameter form, close wound
- R<sub>1</sub>=22000 ohms, 0.5 watt for amplifier; 47000 ohms, 0.5 watt for doubler; 68000 ohms, 0.5 watt for tripler

(5-6)

### TRIODE AMPLIFIER Class C Telegraphy Service

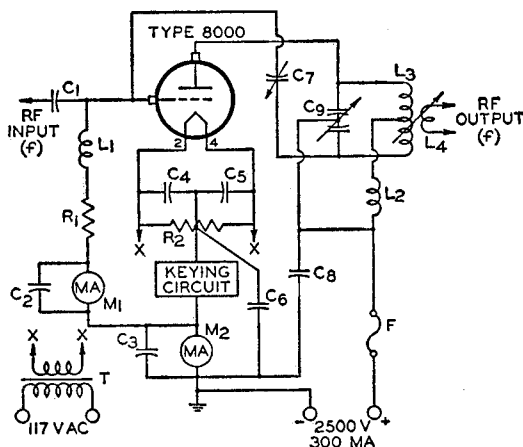

$C_1=0.0005 \mu f$ , mica, 1500 v.  
 $C_2 C_3 C_4 C_5=0.002 \mu f$ , mica, 600 v.  
 $C_6 C_8=0.002 \mu f$ , mica, 5000 v.  
 $C_7=5-10 \mu \mu f$ , neutralizing capacitor, air gap 0.3 inch min

$C_9=0.75 \mu f$  per meter per section (approximate value for resonance at frequency  $f$ )  
 $F$ =Fuse, 0.5 amp  
 $L_1=2.5$  mh, 100 ma, rf choke  
 $L_2=1$  mh, 600 ma, rf choke  
 $L_3$ =Tune to frequency  $f$  with  $C_9$   
 $L_4=2$ -turn link at center of  $L_3$

$M_1$ =Milliammeter, 0-100 ma, dc  
 $M_2$ =Milliammeter, 0-500 ma, dc  
 $R_1=6000$  ohms, 20 watts  
 $R_2=50$  ohms, center-tapped, wire-wound  
 $T$ =Filament transformer, 10 v., 4.5 amp, insulated for 2500 v.

**Keying Circuit:** Because this circuit is at a high dc voltage, a relay-type circuit should be used for keying.

(5-7)

### BEAM POWER TUBE AMPLIFIER Class C Telegraphy Service

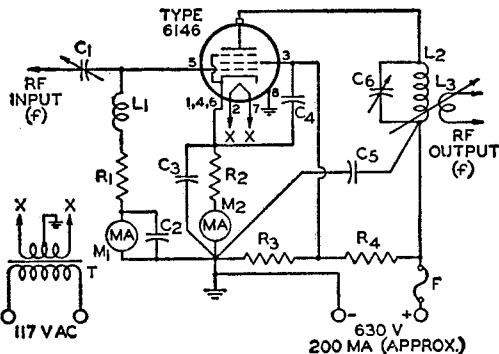

$C_1=4-50 \mu \mu f$ , trimmer, air gap 0.015 inch  
 $C_2 C_3 C_4=0.01$ , disk ceramic, 600 v.  
 $C_5=0.005 \mu f$ , mica, 1500 v.  
 $C_6=2 \mu f$  per meter (approximate value, including tube output capacitance, for resonance. For operation above

60 Mc use lowest value which will permit tuning over desired range), air gap 0.075 inch min.  
 $F$ =Fuse, 0.25 amp  
 $L_1=2.5$  mh, rf choke  
 $L_2$ =Tune to frequency  $f$  with  $C_5$   
 $L_3=2$ -turn link at rf ground end of  $L_2$

$M_1$ =Milliammeter, 0-10 ma, dc  
 $M_2$ =Milliammeter, 0-200 ma, dc  
 $R_1=5100$  ohms, 1 watt  
 $R_2=390$  ohms, 10 watts  
 $R_3=15000$  ohms, 10 watts  
 $R_4=25000$  ohms, 20 watts  
 $T$ =Filament transformer, 6.3 v., 1.25 amp

(5-8)

**PUSH-PULL TRIODE AMPLIFIER**  
Class C Plate-Modulated Service

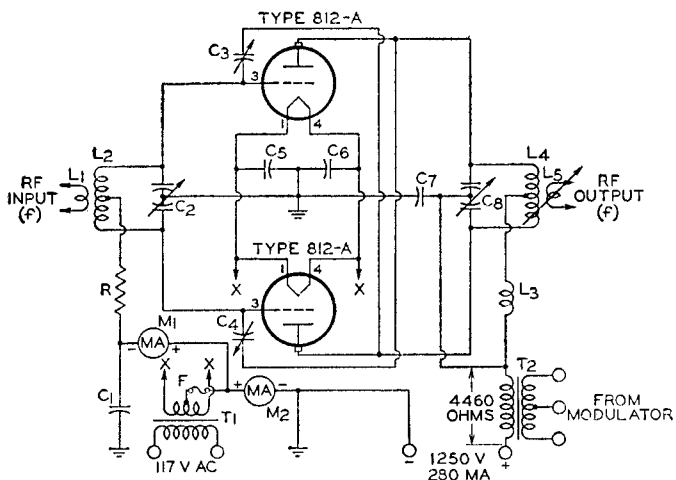

$C_1$   $C_3$   $C_6=0.005 \mu\text{f}$ , mica, 600 v.  
 $C_2=2 \mu\text{f}$  per meter per section  
 (approximate value for resonance at frequency  $f$ ),  
 air gap 0.026 inch, min.  
 $C_3$   $C_4=4-10 \mu\text{f}$  neutralizing capacitor, Hammarlund NC-75 or equivalent  
 $C_7=0.002 \mu\text{f}$ , mica, 5000 v.

$C_5=1.5 \mu\text{f}$  per meter per section  
 (approximate value for resonance at frequency  $f$ ), air gap 0.170 inch min.  
 $F$ =Fuse, 0.5 amp  
 $L_1=3$ -turn link at center of  $L_2$   
 $L_2$ =Tune to frequency  $f$  with  $C_2$   
 $L_3=2.5$  mh, 500 ma, rf choke  
 $L_4$ =Tune to frequency  $f$  with  $C_5$

$L_5=3$ -turn link at center of  $L_4$   
 $M_1$ =Milliammeter, 0-150 ma, dc  
 $M_2$ =Milliammeter, 0-500 ma, dc  
 $R=1650$  ohms, 20 watts  
 $T_1$ =Filament transformer, 6.3 v., 8 amp  
 $T_2$ =Modulation transformer, 125 watts audio level

(5-9)

## PUSH-PULL BEAM POWER TUBE AMPLIFIER

### Class C Plate-Modulated Service

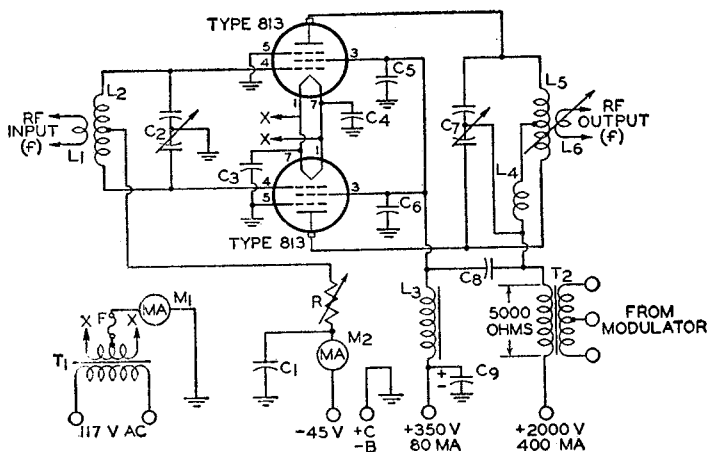

$C_1 = 0.005 \mu\text{f}$ , mica, 600 v.  
 $C_2 = 2 \mu\text{f}$  per meter per section  
 (approximate value for resonance  
 at frequency  $f$ ), air gap  
 0.030 inch min.  
 $C_3 = 0.002 \mu\text{f}$ , mica, 500 v.  
 $C_4 = 0.003 \mu\text{f}$ , mica, 5000 v.  
 $C_5 = 1.5 \mu\text{f}$  per meter per section  
 (approximate value for resonance  
 at frequency  $f$ ), air gap

0.175 inch min.  
 $C_6 = 0.002 \mu\text{f}$ , mica, 6000 v.  
 $C_7 = 4 \mu\text{f}$ , electrolytic, 600 v.  
 $F = \text{Fuse}$ , 1 amp  
 $L_1 = 3\text{-turn link}$  at center of  $L_2$   
 $L_2 = \text{Tune}$  to frequency  $f$  with  $C_2$   
 $L_3 = 6$  henries, 150 ma, choke  
 $L_4 = 1$  mh, 600 ma, rf choke,  
 $L_5 = \text{Tune}$  to frequency  $f$  with  $C_7$   
 $L_6 = 3\text{-turn link}$  at center of  $L_4$

$M_1 = \text{Milliammeter}$ , 0-800 ma, dc  
 $M_2 = \text{Milliammeter}$ , 0-50 ma, dc  
 $R = 4000$  ohms, adjustable,  
 wire-wound, 25 watts  
 $T_1 = \text{Filament transformer}$ ,  
 10 v., 10 amp  
 $T_2 = \text{Modulation transformer}$ ,  
 150 watts audio level

(5-10)

### CLASS B PUSH-PULL TRIODE MODULATOR

Power Output 590 Watts (Approx.)

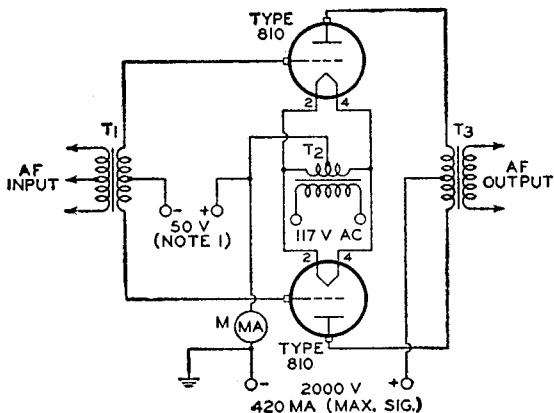

M=Milliammeter, 0-500 ma, dc  
 T<sub>1</sub>=Driver Transformer, plate-to-plate impedance 1500 ohms, turns ratio of total

primary to one-half secondary 1.5 to 1 (Note 2)  
 T<sub>2</sub>=Filament transformer, 10 v., 9 amp, center-tapped

T<sub>3</sub>=Modulation transformer, load impedance 11000 ohms plate-to-plate; turns ratio depends on modulating impedance of modulated stage

NOTES: 1. This voltage should be obtained from a low-impedance source such as a battery or a power supply having a minimum bleeder current of 100 ma and a minimum filter output capacitance of 150  $\mu$ f.  
 2. As the driver for this modulator stage, a circuit having a low output impedance and an output of approximately 25 watts is recommended. For this circuit, four 2A3's in push-pull-parallel Class AB<sub>1</sub>, operating with a plate voltage of 300 volts and a fixed bias voltage of -62 volts, with the indicated driver transformer T<sub>1</sub>, may be used.

(5-11)

### CLASS B MODULATOR

WITH TYPE 807 IN SPECIAL TRIODE CONNECTION

Power Output 120 Watts (Approx.)

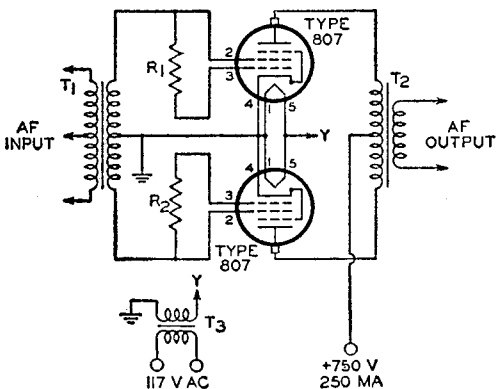

R<sub>1</sub>, R<sub>2</sub>=20000 ohms, 1 watt, carbon

T<sub>1</sub>=Driver transformer, turns ratio of total primary to one-half secondary 1:1.25;

Stancor A4761 or equivalent  
 T<sub>2</sub>=Modulation transformer, audio level 120 watts (approx.), primary 6650 ohms (approx.), center-tapped;

turns ratio depends on modulating impedance of modulated stage

T<sub>3</sub>=Filament transformer, 6.3 volts rms, 1.8 amp

NOTE: As the driver for this modulator stage, a circuit having a low output impedance and an output of approximately 10 watts is recommended. For this circuit, with the indicated driver transformer T<sub>1</sub>, two 2A3's in push-pull Class AB<sub>1</sub> operating with a plate voltage of 300 volts and a cathode-bias resistor of 780 ohms may be used.

(5-12)

## CLASS AB<sub>1</sub> PUSH-PULL MODULATOR

Power Output 100 Watts (Approx.)

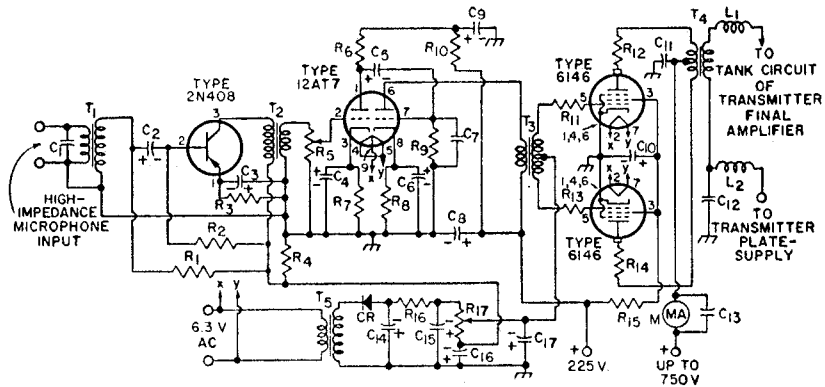

- C<sub>1</sub>=500 µf, mica, 500 v.
- C<sub>2</sub>=16 µf, miniature electrolytic, 12 v.
- C<sub>3</sub>=25 µf, miniature electrolytic, 12 v.
- C<sub>4</sub> C<sub>6</sub>=25 µf, electrolytic 25 v.
- C<sub>5</sub>=0.01 µf, paper, 400 v.
- C<sub>7</sub>=0.002 µf, paper, 400 v.
- C<sub>8</sub> C<sub>9</sub> C<sub>10</sub>=8 µf, electrolytic, 450 v.
- C<sub>11</sub>=0.5 µf, paper, 750 v.
- C<sub>12</sub>=0.005 µf, mica, 1500 v.
- C<sub>13</sub>=0.1 µf, paper, 750 v.
- C<sub>14</sub> C<sub>15</sub> C<sub>16</sub>=20 µf, electrolytic, 150 v.
- C<sub>17</sub>=8 µf, electrolytic, 150 v.
- CR=Silicon rectifier, type 1N-3193

- L<sub>1</sub> L<sub>2</sub>=RF choke, 2.5 mb, 125 ma.
- M=Milliammeter, 0-100 ma, dc
- R<sub>1</sub>=3300 ohms, 0.5 watt
- R<sub>2</sub>=220000 ohms, 0.5 watt
- R<sub>3</sub> R<sub>11</sub> R<sub>13</sub>=1000 ohms, 0.5 watt
- R<sub>4</sub>=470 ohms, 0.5 watt
- R<sub>5</sub>=Potentiometer, 0.25 meg-ohm
- R<sub>6</sub> R<sub>9</sub>=270000 ohms, 0.5 watt
- R<sub>7</sub>=2200 ohms, 0.5 watt
- R<sub>8</sub>=390 ohms, 1 watt
- R<sub>10</sub>=22000 ohms, 1 watt
- R<sub>12</sub> R<sub>14</sub>=47 ohms, 1 watt
- R<sub>15</sub>=1000 ohms, 1 watt
- R<sub>16</sub>=2200 ohms, 2 watts
- R<sub>17</sub>=10000 ohms, adjustable, 25 watts

- T<sub>1</sub>=Transistor input transformer, primary 200000 ohms, secondary 1000 ohms.
- T<sub>2</sub>=Interstage transformer, single plate to single grid, 1.3 turns ratio
- T<sub>3</sub>=Driver transformer, single plate to push-pull grids, primary 10000 ohms, turns ratio primary—to one half secondary 1.5:1.1. Stancor A-4752 or equivalent
- T<sub>4</sub>=Modulation transformer, 100-115 watts, UTC S-21 or equivalent
- T<sub>5</sub>=Filament transformer, 117 v. to 6.3 v., 1 amp

(5-13)

**CLASS B LINEAR RF AMPLIFIER FOR SINGLE SIDEBAND**

Power Output 875 Watts (Approx.) Frequency 3.5-28 Mc

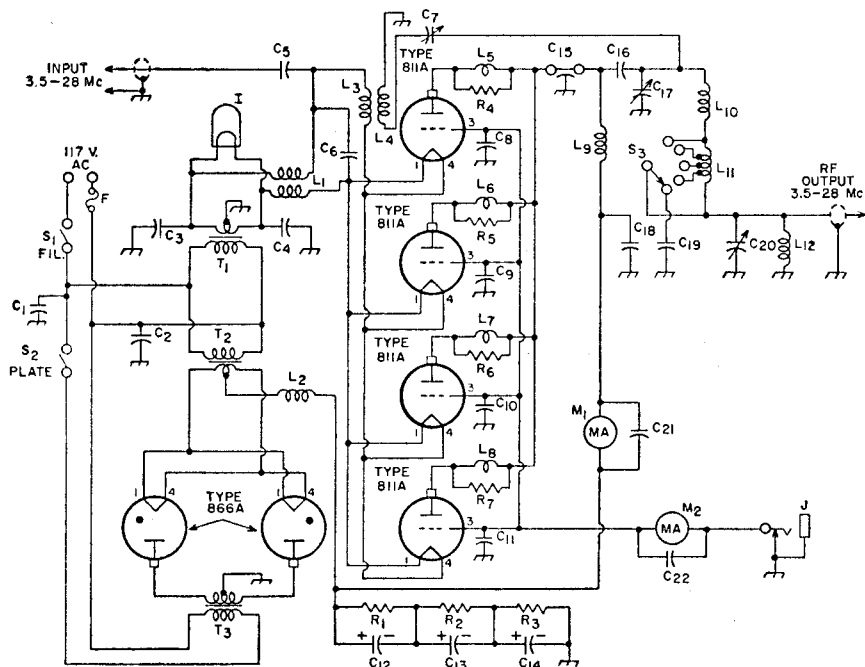

- C<sub>1</sub> C<sub>2</sub> C<sub>3</sub> C<sub>4</sub> C<sub>5</sub> C<sub>6</sub> C<sub>8</sub> C<sub>9</sub> C<sub>10</sub> C<sub>11</sub>  
C<sub>12</sub>=0.01 μf, disk ceramic, 600 v.
- C<sub>7</sub>=Neutralizing capacitor, 6 μf (Approx.) air gap 0.06 inch, Bud (R-2028 or equivalent)
- C<sub>13</sub> C<sub>14</sub> C<sub>15</sub>=100 μf, electrolytic, 450 v.
- C<sub>16</sub>=VHF by-pass; 4-inch length of coaxial cable RG-58/U used as connecting lead with outer shield connected to chassis
- C<sub>16</sub> C<sub>18</sub> C<sub>21</sub>=1000 μf, disk ceramic, 6000 v.
- C<sub>17</sub>=Tuning capacitor, 19-488 μf, air gap 0.045 inch, 2000 v., Johnson 154-3 or equivalent
- C<sub>19</sub>=1500 μf, silver mica, 2500 v.
- C<sub>22</sub>=Output (loading) capacitor, 3-section, 10-365 μf per section with sections connected in parallel.
- F=Fuse, 10 amperes

- I=Indicator lamp, 6.3 v.
- J=Closed-circuit jack. For application of 100 volts negative standby bias
- L<sub>1</sub>=RF choke, bifilar, B & W FC-15 or equivalent
- L<sub>2</sub>=Filter choke, 5-8 h, 300 ma, Stancor C-1722 or equivalent
- L<sub>3</sub>=6 turns of No. 14 Enam. close wound on ½-inch diameter form
- L<sub>4</sub>=5 turns of insulated hook-up wire wound over L<sub>3</sub>
- L<sub>4</sub> L<sub>6</sub> L<sub>7</sub> L<sub>8</sub>=Parasitic suppressor choke; 7 turns of No. 18 Enam. wound on and connected across R<sub>4</sub>, R<sub>5</sub>, R<sub>6</sub>, and R<sub>7</sub>.
- L<sub>9</sub>=RF choke, 1 mh, 600 ma, National R 154-U or equivalent
- L<sub>10</sub> L<sub>11</sub>=Pi-network inductor, Illumitronic Pi Dux No. 195-1 or equivalent, tapped at 0.4, 0.7, 1, 2.2 and 4.5 μh, respectively for 10 to 80 meters.

- L<sub>11</sub> wound with No. 8 wire; L<sub>10</sub> with ½-inch copper strap. About half the turns from close-wound end of coil can be removed.
- L<sub>12</sub>=RF choke, 2.5 mh
- M<sub>1</sub>=Milliammeter, 0-1000 ma, dc
- M<sub>2</sub>=Milliammeter, 0-200 ma, dc
- R<sub>1</sub>, R<sub>2</sub>, R<sub>3</sub>=25000 ohms, 25 watts
- R<sub>4</sub>, R<sub>5</sub>, R<sub>6</sub>, R<sub>7</sub>=39 ohms, 1 watt
- S<sub>1</sub>, S<sub>2</sub>=Switch, single-pole, single-throw
- S<sub>3</sub>=Band switch, rotary, single-pole, 5-position, heavy duty
- T<sub>1</sub>=Filament transformer, 6.3 v., 16 amp., Triad F-22A or equivalent
- T<sub>2</sub>=Filament transformer, 2.5 v., 10 amp., Stancor P-3024 or equivalent
- T<sub>3</sub>=Plate transformer, 1250 v., 300 ma, Stancor PT-8313 or equivalent.



(5-14)

## 50-MEGACYCLE TRANSMITTER

### Power Output 120 Watts (Approx.)

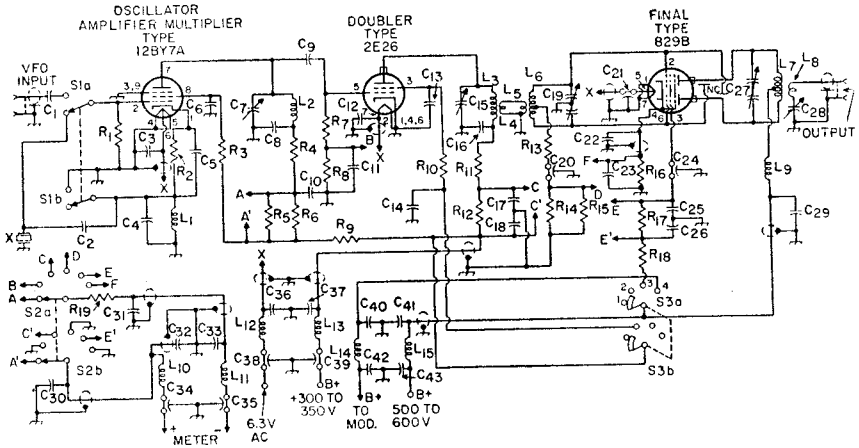

$C_1=220 \mu\text{f}$ , mica, 500 v.  
 $C_2=10 \mu\text{f}$ , mica, 500 v.  
 $C_3 C_5 C_6 C_8 C_{10} C_{11} C_{12} C_{13} C_{14}$   
 $C_{16} C_{17} C_{18} C_{22} C_{23} C_{25} C_{26}$   
 $C_{29} C_{31} C_{32} C_{33} C_{36} C_{37}=1000$   
 $\mu\text{f}$ , disk ceramic, 1000 v.  
 $C_4=100 \mu\text{f}$ , mica, 500 v.  
 $C_7 C_{28}=3.7\text{-}52 \mu\text{f}$ , variable, air  
 gap 0.015 inch, Hammarlund  
 HF-50 or equivalent  
 $C_9=47 \mu\text{f}$ , mica, 500 v.  
 $C_{15}=5.2\text{-}30 \mu\text{f}$ , variable, air  
 gap 0.045 inch, Hammarlund  
 HF-30-X or equivalent  
 $C_{19}=5.0\text{-}28.5 \mu\text{f}$ , double-sec-  
 tion variable, air gap 0.045  
 inch, Hammarlund HFD-30-  
 X or equivalent  
 $C_{20} C_{21} C_{24} C_{34} C_{35} C_{38} C_{39}=$   
 $1000 \mu\text{f}$ , feed-through, ceram-  
 ic, 500 v.  
 $C_{27}=4.8\text{-}27.3 \mu\text{f}$ , butterfly,  
 variable, air gap 0.030 inch,  
 Hammarlund BFC-25 or  
 equivalent  
 $C_{23} C_{24} C_{31} C_{32} C_{45}=1000 \mu\text{f}$ ,  
 disk ceramic, 3000 v.  
 $L_1=$  RF choke, 1 mh  
 $L_2=$  10 turns of No. 20 tinned on  
 $\frac{1}{2}$ -inch diameter form, wind-  
 ing length  $\frac{3}{4}$ -inch

$L_3=5\frac{1}{2}$  turns of No. 10 solid,  
 tinned, on  $\frac{5}{8}$ -inch diameter,  
 winding length 1 inch.  
 $L_4 L_5=2$  turns of No. 20 plastic  
 covered on  $\frac{1}{2}$ -inch diameter,  
 close wound  
 $L_6=8$  turns of No. 10 solid,  
 tinned, on  $\frac{5}{8}$ -inch diameter,  
 winding length  $1\frac{1}{2}$  inch  
 $L_7=6$  turns of No. 10 solid  
 tinned on  $\frac{7}{8}$ -inch diameter,  
 winding length 1 inch  
 $L_8=2$  turns of No. 14 Enam.  
 covered with insulation tub-  
 ing on  $\frac{5}{8}$ -inch diameter, close  
 wound  
 $L_9 L_{10} L_{11} L_{13} L_{14} L_{15}=$  RF choke,  
 $7 \mu\text{h}$ , 1000 ma, Ohmite Z-50  
 or equivalent  
 $L_{12}=$  RF choke, 25 turns of No.  
 16 Enam. on  $\frac{1}{4}$ -inch dia-  
 meter, close wound  
 $NC=$  Neutralizing capacitors:  
 No. 12, tinned wire;  $\frac{1}{2}$ -inch  
 length placed in proximity of  
 829B plates  
 $R_1=100000$  ohms, 0.5 watt  
 $R_2=120$  ohms, 0.5 watt  
 $R_3=33000$  ohms, 0.5 watt  
 $R_4 R_5 R_{11} R_{19}=1000$  ohms, 0.5  
 watt

$R_6 R_{11}=47$  ohms, 0.5 watt  
 $R_7 R_{12}=130$  ohms, 0.5 watt  
 $R_8=47000$  ohms, 1 watt  
 $R_9=3300$  ohms, 1 watt  
 $R_{10}=10000$  ohms, 2 watts  
 $R_{13}=10$  ohms, 0.5 watt  
 $R_{14}=56000$  ohms, 2 watts  
 $R_{16}=3.3$  ohms, 0.5 watt, wire  
 wound  
 $R_{17}=33$  ohms, 0.5 watt, wire  
 wound  
 $R_{18}=15000$  ohms, 10 watts, wire  
 wound  
 $S_1=$  Crystal - VFO Switch; two-  
 pole, two-position, wafer, non-  
 shorting, rotary  
 $S_2=$  Meter Switch; two-pole, six-  
 position, wafer, non-shorting,  
 rotary; Shown in oscillator,  
 amplifier, multiplier plate-  
 current position  
 $S_3=$  Tuning Switch; 60-degree  
 indexing Centralab PA-304  
 or equivalent; two progres-  
 sively shorting 30-degree wa-  
 fers, Centralab PA-12 or  
 equivalent, using every sec-  
 ond contact.  
 $X=$  Crystal, 8-Mc range

**NOTES:** 1. With 8-Mc crystal input, first stage is a tripler. With VFO input, depending on input frequency, this stage may be amplifier, doubler, or tripler.  
 2. With 0-1 ma. dc meter, shunts provide full-scale reading of oscillator amplifier-multiplier plate current to 30 ma; doubler grid-No. 1 current to 2 ma; doubler plate current to 100 ma; final grid-No. 1 current to 30 ma; final grid-No. 2 current to 100 ma; and final plate current to 300 ma.

(5-15)

SINGLE-SIDEBAND EXCITER (FILTER TYPE)

Output Frequency 3.8-4.0 Mc

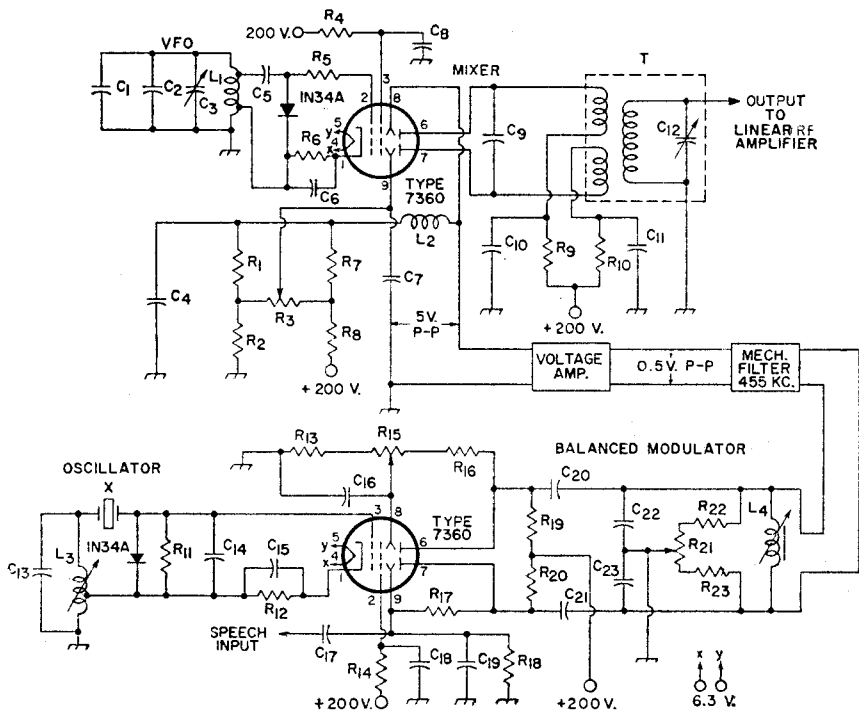

- C<sub>1</sub>=68  $\mu$ f, ceramic, zero temperature coefficient
- C<sub>2</sub>=300  $\mu$ f, ceramic, zero temperature coefficient
- C<sub>3</sub>=5-60  $\mu$ f, variable
- C<sub>4</sub> C<sub>6</sub> C<sub>7</sub> C<sub>10</sub> C<sub>11</sub> C<sub>18</sub>=0.005  $\mu$ f, mica, 600 v.
- C<sub>5</sub>=470  $\mu$ f, silver mica, 500 v.
- C<sub>8</sub>=0.001  $\mu$ f, mica, 500 v.
- C<sub>9</sub> C<sub>14</sub>=22  $\mu$ f, mica, 500 v.
- C<sub>12</sub>=65-320  $\mu$ f, variable
- C<sub>13</sub>=1500  $\mu$ f, mica, 500 v.
- C<sub>15</sub>=0.01  $\mu$ f, disk ceramic, 600 v.
- C<sub>16</sub>=0.02  $\mu$ f, disk ceramic, 600 v.
- C<sub>17</sub>=0.2  $\mu$ f, paper, 200 v.
- C<sub>19</sub>=0.002  $\mu$ f, paper, 200 v.
- C<sub>20</sub> C<sub>21</sub>=0.04  $\mu$ f, paper, 200 v.
- C<sub>22</sub> C<sub>23</sub>=0.0056  $\mu$ f, mica, 500 v.
- L<sub>1</sub>=15 turns of No. 22 Enam. spaced uniformly over 0.6 inch on 1-inch diameter form; grid-No. 1 tap, 7½ turns above ground end; cathode tap, 1.9 turns above ground end
- L<sub>2</sub>=RF choke, 2.5 mh

- L<sub>3</sub>=88  $\mu$ h, approx., adjustable; high Q, ferrite core; converter-tube oscillator coil for standard AM band may be used; cathode tap, approx. 15 per cent of total turns above ground.
- L<sub>4</sub>=50  $\mu$ h, approx., adjustable; 63 turns of No. 36 Enam., close wound in single layer on 9/32-inch tube, tuned to crystal frequency with ¼-inch iron slug
- R<sub>1</sub> R<sub>7</sub>=1500 ohms, 0.5 watt
- R<sub>2</sub>=3300 ohms, 0.5 watt
- R<sub>3</sub>=Amplitude Balance Control; 2500 ohms, composition, linear taper
- R<sub>4</sub> R<sub>14</sub>=33000 ohms, 0.5 watt
- R<sub>5</sub>=39 ohms, 0.5 watt
- R<sub>6</sub> R<sub>12</sub>=300 ohms, 0.5 watt
- R<sub>8</sub>=27000 ohms, 2 watts
- R<sub>9</sub> R<sub>10</sub> R<sub>19</sub> R<sub>20</sub>=68000 ohms, 0.5 watt
- R<sub>11</sub>=470000 ohms, 0.5 watt

- R<sub>12</sub>=47000 ohms, 0.5 watt
- R<sub>15</sub>=Carrier Amplitude Balance Control, 25000 ohms, composition, linear taper
- R<sub>16</sub>=100000 ohms, 0.5 watt
- R<sub>17</sub>=120000 ohms, 0.5 watt
- R<sub>18</sub>=56000 ohms, 0.5 watt
- R<sub>21</sub>=Carrier Phase Balance Control, 2500 ohms, composition, linear taper
- R<sub>22</sub> R<sub>23</sub>=2700 ohms, 0.5 watt
- T=Primary: Two wires wound in parallel, each 23½ turns of No. 34 wire, single Teflon insulation (or silk if necessary), bifilar wound on ½-inch diameter tube; winding length, ¾ inch; tuning slug, ¼ inch
- Secondary: 26 turns of No. 32, Formex insulation, close wound in single layer
- X=Crystal, 456.85 kilocycles

NOTE: The leakage resistance of the IN34A serves as the grid resistor for the mixer stage; in some cases, however, it may be necessary to add a 470000-ohm grid resistor across the diode.

(5-16)

## 144-148 MEGACYCLE TRANSMITTER FOR MOBILE OPERATION

Quick Heating

Power Output 30 Watts (Approx.)

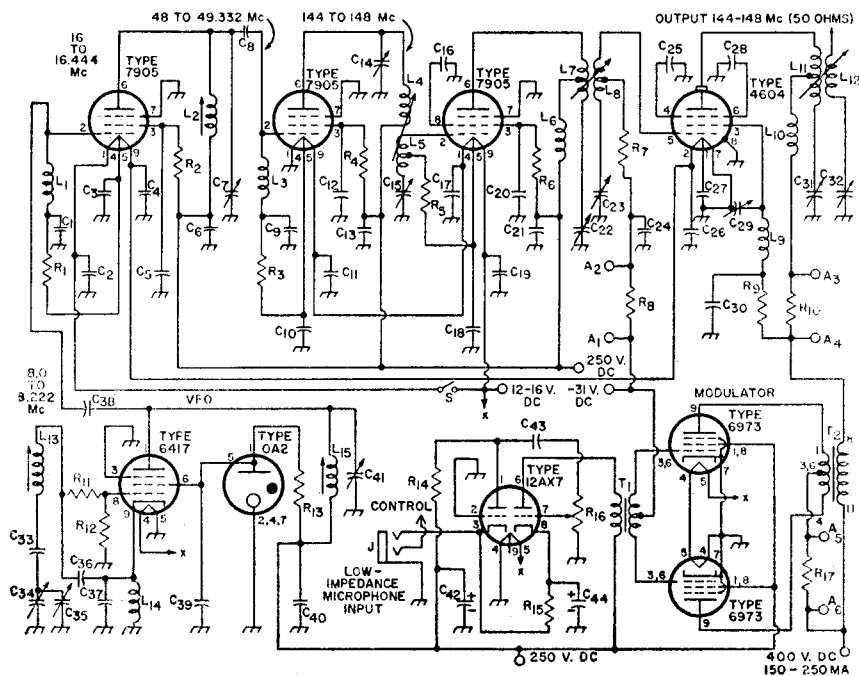

C<sub>1</sub> C<sub>2</sub> C<sub>3</sub> C<sub>4</sub> C<sub>5</sub> C<sub>6</sub> C<sub>9</sub> C<sub>10</sub> C<sub>11</sub> C<sub>12</sub>  
 C<sub>13</sub> C<sub>16</sub> C<sub>17</sub> C<sub>18</sub> C<sub>19</sub> C<sub>20</sub> C<sub>24</sub>  
 C<sub>25</sub> C<sub>29</sub> C<sub>30</sub> = 0.001  $\mu$ f, disk ceramic, 600 v.  
 C<sub>7</sub> C<sub>41</sub> = 2.3-14.2  $\mu$ f, variable, miniature, air gap 0.017 inch, Johnson 160-107 or equivalent  
 C<sub>8</sub> C<sub>38</sub> = 100  $\mu$ f, disk ceramic, 600 v.  
 C<sub>14</sub> = 1.5-5.0  $\mu$ f, variable, miniature, air gap 0.017 inch, Johnson 160-102 or equivalent  
 C<sub>18</sub> C<sub>23</sub> = 1-8  $\mu$ f, tubular trimmer, Erie 832-B or equivalent  
 C<sub>21</sub> C<sub>22</sub> C<sub>26</sub> C<sub>27</sub> C<sub>28</sub> = 0.001  $\mu$ f, silver mica, Erie 370-FA-102J or equivalent  
 C<sub>22</sub> = 2.8-17.5  $\mu$ f, variable, air gap 0.015 inch, Hammarlund HF-15 or equivalent  
 C<sub>29</sub> = 5-80  $\mu$ f, trimmer, mica, Arco 462 or equivalent  
 C<sub>31</sub> = 3.6-15  $\mu$ f, variable, air gap 0.0715 inch, Hammarlund HF-15-X or equivalent  
 C<sub>32</sub> = 6.3-50  $\mu$ f, variable, air gap 0.0245 inch, Hammarlund MC-50-M or equivalent  
 C<sub>33</sub> = 220  $\mu$ f, disk ceramic, zero temperature coefficient

C<sub>34</sub> = 5.5-20  $\mu$ f, variable, air gap 0.0245 inch, double-bearing Hammarlund MC-20-S or equivalent  
 C<sub>35</sub> = 4.5-25  $\mu$ f, trimmer, ceramic, zero temperature coefficient Centralab 822-AZ or equivalent  
 C<sub>36</sub> C<sub>37</sub> = 390  $\mu$ f, silver mica, zero temperature coefficient  
 C<sub>42</sub> = 8  $\mu$ f, electrolytic, 450 v.  
 C<sub>43</sub> = 0.01  $\mu$ f, paper, 600 v.  
 C<sub>44</sub> = 10  $\mu$ f, electrolytic, 50 v.  
 J = Microphone jack, 2 contact and shield, Amphenol 80 PC2F or equivalent  
 L<sub>1</sub> L<sub>3</sub> L<sub>14</sub> = RF choke, 750  $\mu$ h  
 L<sub>2</sub> = 7 turns of No. 24 Enam. on  $\frac{1}{2}$ -inch diameter ceramic form, winding length 5/32 inch; form, CTC PLS6-2C4L or equivalent, tuned with powdered-iron slug  
 L<sub>4</sub> = 2 $\frac{1}{2}$  turns of No. 18 Enam. on 7/16-inch diameter, winding length  $\frac{1}{2}$ -inch  
 L<sub>5</sub> = 4 $\frac{1}{2}$  turns of No. 18 Enam. on 7/16-inch diameter, winding length  $\frac{3}{8}$  inch, center tapped

L<sub>6</sub> L<sub>10</sub> = RF choke, 1.8  $\mu$ h, Ohmite Z-144 or equivalent  
 L<sub>7</sub> = 3 turns of No. 20 Enam. on  $\frac{1}{2}$ -inch diameter, winding length  $\frac{3}{8}$  inch, center tapped  
 L<sub>8</sub> = 3 turns of No. 20 Enam. on  $\frac{1}{2}$ -inch diameter, winding length 5/16 inch, center tapped  
 L<sub>9</sub> = RF choke, 7.0  $\mu$ h, Ohmite Z-50 or equivalent  
 L<sub>11</sub> = 4 turns of No. 14 tinned on  $\frac{3}{4}$ -inch diameter, winding length  $\frac{3}{4}$ -inch, center tapped  
 L<sub>12</sub> = 1 $\frac{3}{4}$  turns of No. 14 Enam. on  $\frac{3}{4}$ -inch diameter, winding length  $\frac{1}{4}$  inch  
 L<sub>13</sub> = 32 turns of No. 24 Enam. on  $\frac{1}{2}$ -inch diameter ceramic form, winding length 11/16 inch; form, CTC PLS7-2C4L or equivalent; tuned with powdered-iron slug  
 L<sub>15</sub> = 26 turns of No. 28 Enam. on  $\frac{1}{2}$ -inch diameter ceramic form, winding length  $\frac{3}{8}$  inch; form CTC PLS6-2C4L or equivalent; tuned with powdered-iron slug

(Continued on page 307)

(5-17)

**FIVE-BAND 10 TO 80 METER TRANSMITTER**

Power Output 90 Watts Frequency 3.5, 7, 14, 21, 28 Megacycles

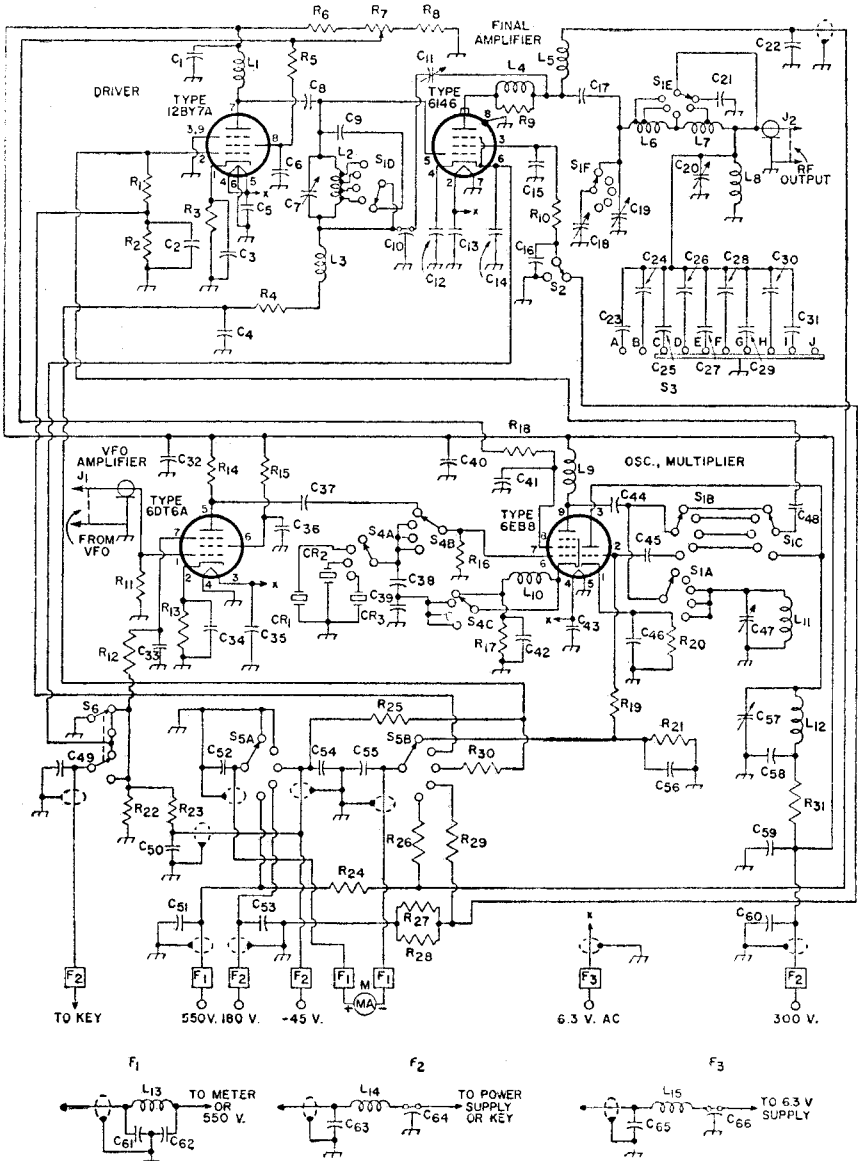

(5-17)

## FIVE-BAND 10 TO 80 METER TRANSMITTER (Cont'd)

C<sub>1</sub> C<sub>34</sub> C<sub>36</sub> C<sub>42</sub>=0.005  $\mu$ f, disk ceramic, 1000 v.  
 C<sub>2</sub> C<sub>3</sub> C<sub>4</sub> C<sub>5</sub> C<sub>6</sub> C<sub>12</sub> C<sub>13</sub> C<sub>14</sub> C<sub>15</sub>  
 C<sub>16</sub> C<sub>35</sub> C<sub>39</sub> C<sub>41</sub> C<sub>43</sub> C<sub>46</sub> C<sub>49</sub>  
 C<sub>50</sub> C<sub>53</sub> C<sub>54</sub> C<sub>56</sub> C<sub>59</sub> C<sub>60</sub> C<sub>63</sub>  
 C<sub>65</sub>=0.001  $\mu$ f, disk ceramic, 1000 v.  
 C<sub>7</sub> C<sub>17</sub> C<sub>37</sub>=3.7-52  $\mu$ f, variable, air gap 0.015 inch, Hammarlund HF-50 or equivalent  
 C<sub>8</sub> C<sub>27</sub> C<sub>44</sub> C<sub>45</sub> C<sub>18</sub> C<sub>38</sub>=0.001  $\mu$ f, mica  
 C<sub>9</sub>=56  $\mu$ f, mica  
 C<sub>10</sub>=500  $\mu$ f, feed-through, ceramic  
 C<sub>11</sub>=1-7.5  $\mu$ f, trimmer, tubular ceramic, Centralab 829-7 or equivalent  
 C<sub>17</sub>=0.003  $\mu$ f, ceramic, 1600 v., Centralab DD16-302 or equivalent  
 C<sub>18</sub> C<sub>19</sub>=16.5-100  $\mu$ f, variable, air gap 0.0715 inch, Hammarlund MC-100-S-X or equivalent; C<sub>18</sub> is used as fixed 100- $\mu$ f capacitor  
 C<sub>39</sub>=6.3-142  $\mu$ f, variable, air gap 0.015 inch, Hammarlund HF-140 or equivalent  
 C<sub>31</sub>=330  $\mu$ f, mica  
 C<sub>32</sub> C<sub>33</sub> C<sub>52</sub> C<sub>55</sub> C<sub>61</sub> C<sub>62</sub>=0.001  $\mu$ f, disk ceramic, 3000 v.  
 C<sub>25</sub> C<sub>24</sub> C<sub>25</sub> C<sub>26</sub> C<sub>27</sub> C<sub>28</sub> C<sub>29</sub> C<sub>30</sub>  
 C<sub>31</sub>=120  $\mu$ f, mica  
 C<sub>35</sub>=0.01  $\mu$ f, disk ceramic, 1000 v.  
 C<sub>35</sub>=0.02  $\mu$ f, disk ceramic, 1000 v.  
 C<sub>36</sub>=22  $\mu$ f, mica, 500 v.  
 C<sub>39</sub>=220  $\mu$ f, mica, 500 v.  
 C<sub>61</sub> C<sub>65</sub>=1500  $\mu$ f, feed-through, Centralab FT-1500 or equivalent  
 CR<sub>1</sub> CR<sub>2</sub>=Crystal  
 F<sub>1</sub> F<sub>2</sub> F<sub>3</sub>=Harmonic filters  
 J<sub>1</sub> J<sub>2</sub>=Coaxial connector  
 L<sub>1</sub> L<sub>2</sub> L<sub>3</sub> L<sub>8</sub> L<sub>10</sub>=RF choke, 2.5 mh

L<sub>5</sub>=57 turns of No. 24 on 5/8-inch diameter, wound 32 turns per inch; tapped 5 1/2, 8 1/2, 11 1/2, and 28 turns from grid end; B & W 3008 or equivalent  
 L<sub>4</sub>=7 turns of No. 16 Enam. wound on R<sub>9</sub>  
 L<sub>5</sub>=RF choke, 1 mh  
 L<sub>6</sub>=10 turns of No. 10 Enam. on 1-inch diameter, winding length 2 inches; tapped 4 1/2 and 7 1/2 turns from plate end  
 L<sub>6</sub>=10 turns of No. 10 Enam. on 1-inch diameter, winding length 2 inches; tapped 4 1/2 and 7 1/2 turns from plate end  
 L<sub>7</sub>=20 3/4 turns of No. 18 on 1 1/4-inch diameter, wound 16 turns per inch; tapped 11 turns from plate end; B & W 3019 or equivalent  
 L<sub>11</sub>=28 turns of No. 24 on 5/8-inch diameter, wound 32 turns per inch; B & W 3008 or equivalent  
 L<sub>12</sub>=14 turns of No. 20 on 5/8-inch diameter, wound 16 turns per inch; B & W 3007 or equivalent  
 L<sub>12</sub> L<sub>14</sub>=1kF choke; 7  $\mu$ h, Ohmite Z-50 or equivalent  
 L<sub>15</sub>=25 turns of No. 16 Enam. close wound on 3/8-inch diameter plastic rod  
 M=Milliammeter, 0-3 ma. dc  
 R<sub>1</sub> R<sub>15</sub>=68000 ohms, 0.5 watt  
 R<sub>2</sub> R<sub>3</sub> R<sub>10</sub> R<sub>21</sub> R<sub>25</sub> R<sub>26</sub> R<sub>29</sub> R<sub>30</sub>  
 R<sub>21</sub>=1000 ohms, 0.5 watt  
 R<sub>3</sub>=120 ohms, 0.5 watt  
 R<sub>4</sub> R<sub>8</sub> R<sub>18</sub>=12000 ohms, 1 watt  
 R<sub>7</sub>=50000 ohms, variable, 4 watts  
 R<sub>9</sub>=100 ohms, 1 watt  
 R<sub>11</sub> R<sub>12</sub> R<sub>16</sub>=100000 ohms, 0.5 watt  
 R<sub>15</sub>=270 ohms, 0.5 watt

R<sub>14</sub>=3900 ohms, 1 watt  
 R<sub>15</sub>=33000 ohms, 0.5 watt  
 R<sub>17</sub>=100 ohms, 0.5 watt  
 R<sub>18</sub>=22000 ohms, 0.5 watt  
 R<sub>29</sub>=470 ohms, 0.5 watt  
 R<sub>22</sub> R<sub>23</sub>=220000 ohms, 0.5 watt  
 R<sub>24</sub>=10 ohms, 0.5 watt  
 R<sub>27</sub> R<sub>28</sub>=220 ohms, 0.5 watt  
 S<sub>1</sub>=Band switch; rotary, ceramic, 6 poles, 5 positions, 6 sections; Centralab index assembly PA-305 and wafers PA-17 or equivalent; shown in 3.5 Mc position  
 S<sub>2</sub>=Tune-operate switch; single-pole, double-throw; shown in operate position  
 S<sub>3</sub>=Coarse loading switch; rotary, ceramic, 1 pole, 2-10 positions, 1 section, progressive opening; Centralab PA-2052 or equivalent  
 S<sub>4</sub>=Crystal-VFO switch; rotary, ceramic, 3 poles, 2-5 positions, 1 section; Centralab PA-2006 or equivalent  
 S<sub>5</sub>=Meter switch; rotary, ceramic, 2 poles, 2-6 positions, 1 section, non-shorting; Centralab PA-2003 or equivalent; shown in 6EB8 triode unit grid-current position (0-3 ma.); succeeding positions in order are 12BY7A grid-No.1 current (0-3 ma.), 6146 grid-No.1 current (0-6 ma.), 6146 grid-No. 2 current (0-30 ma.), 6146 plate current (0-300 ma.)  
 S<sub>6</sub>=Keying switch; double-pole, double-throw; shown in cathode-circuit keying position

(5-16, continued):

R<sub>1</sub> R<sub>2</sub>=56000 ohms, 0.5 watt, carbon  
 R<sub>3</sub> R<sub>4</sub> R<sub>5</sub>=15000 ohms, 0.5 watt  
 R<sub>6</sub> R<sub>7</sub>=18000 ohms, 0.5 watt  
 R<sub>8</sub>=1000 ohms, 0.5 watt, carbon  
 R<sub>9</sub>=18500 ohms, 3 watts (three 5000-ohm, 1-watt resistors in parallel)  
 R<sub>10</sub>=33 ohms, 1 watt  
 R<sub>11</sub>=68 ohms, 0.5 watt, carbon

R<sub>12</sub> R<sub>14</sub>=47000 ohms, 0.5 watt, carbon  
 R<sub>15</sub>=5000 ohms, 10 watts, wire wound  
 R<sub>16</sub>=1000 ohms, 1 watt, carbon  
 R<sub>17</sub>=Potentiometer, 0.5 meg-ohm  
 R<sub>17</sub>=50 ohms, 1 watt  
 S=Relay contact on transmit-receive switch

T<sub>1</sub>=Driver transformer, single-plate to push-pull grids, primary 10000 ohms, turns ratio primary to one-half secondary 3:1; Stancor A-4723 or equivalent  
 T<sub>2</sub>=Modulation transformer, 30 watts, Stancor A-3892 or equivalent. Terminals 9 & 12 connected together

NOTES: 1. A metal shield should be used to isolate the final amplifier and the driver output circuit from the other rf circuits. Filament and 250-volt B+ line through shield should be by-passed by 0.001- $\mu$ f ceramic feed-through capacitors such as Centralab MFT-100 or equivalent.

2. Placement of a 0-1 milliamperemeter (in series with a 5000-ohm 0.5-watt resistor) across terminals A1-A2, A3-A4, and A5-A6 will provide readings for adjustment of driver, final, and modulator output circuits, respectively

(5-18)

**TYPICAL COAXIAL CAVITY FOR BEAM POWER TUBE 7650**

Frequency 300 to 1500 Mc. Cathode Drive

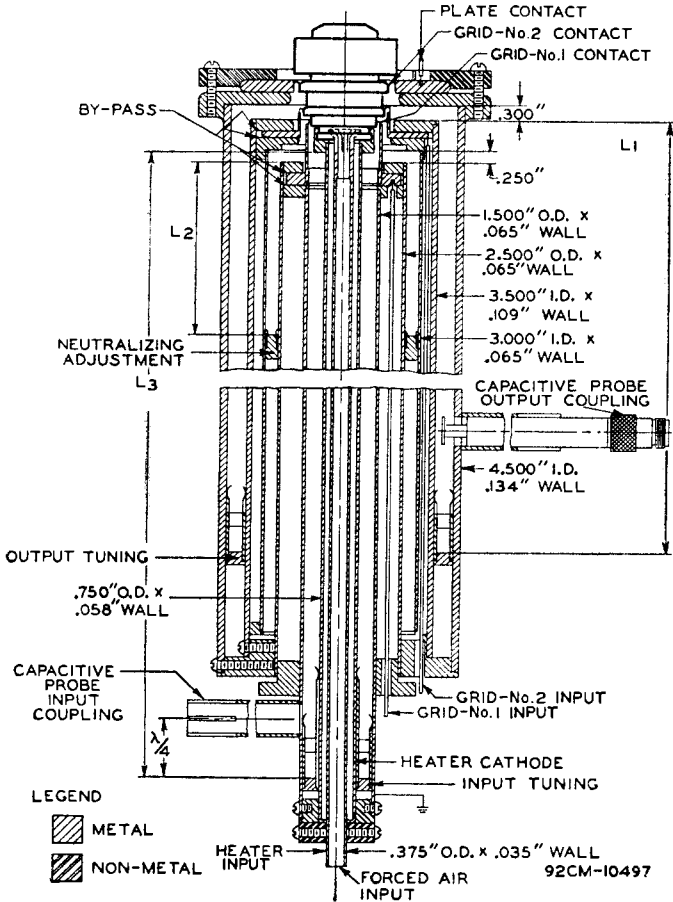

$L_1$  = Length of Grid-No.2-Plate Cavity, 1 to 20 inches, approx., depending on frequency and mode

$L_2$  = Length of Grid-No.1-Grid-No.2 Cavity, 0 to 20 inches, approx., depending on frequency and mode.

$L_3$  = Length of Cathode-Grid-No.1 Cavity, 0.4 to 20 inches, approx., depending on frequency and mode.

NOTES: 1. At 1250 megacycles in three-quarter wavelength mode, approximate length of  $L_1$  is 4.3 inches,  $L_2$  is 3.3 inches, and  $L_3$  is 416 inches.

2. Apertures are provided in the various walls to permit passage of air to all terminals.

(5-19)

**462-MEGACYCLE TRANSMITTER FOR FIXED OR MOBILE OPERATION**

Power Output 20 Watts (Approx.)

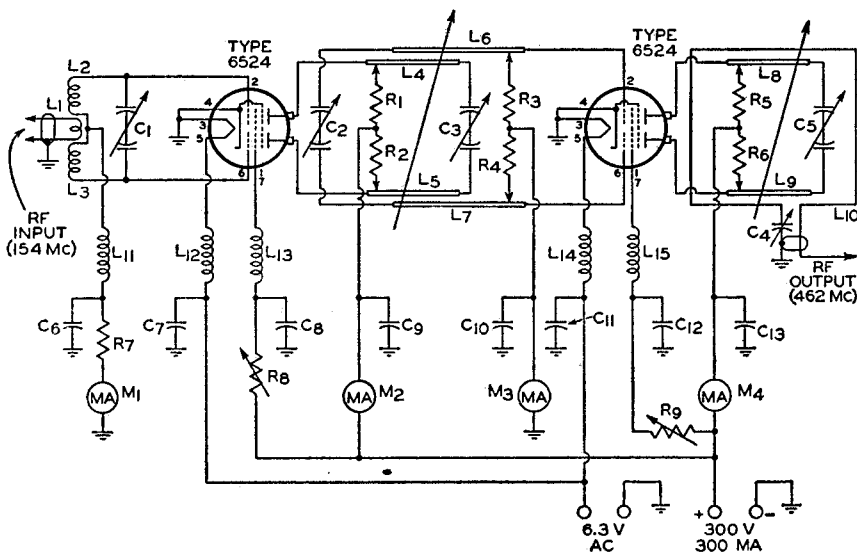

- $C_1$   $C_2$  = 2.2-8.0  $\mu$ f per section, variable, butterfly, air gap 0.017 inch, Johnson 9MB11 or equivalent  
 $C_3$   $C_5$  = 2.7-10.8  $\mu$ f per section, variable, butterfly, air gap 0.017 inch, Johnson 11MB11 or equivalent  
 $C_4$  = 1.5-5.0  $\mu$ f, variable, air gap 0.017 inch, Johnson 5M11 or equivalent  
 $C_6$   $C_7$   $C_8$   $C_9$   $C_{10}$   $C_{11}$   $C_{12}$   $C_{13}$  = 1500  $\mu$ f, feed-through ceramic, Eric 362-152 or equivalent

- $L_1$  = 1 turn of No. 10 base copper wire, wound on  $\frac{1}{2}$ -inch diameter  
 $L_2$   $L_3$  =  $1\frac{1}{2}$  turns of No. 10 base copper wire close-wound on  $\frac{1}{2}$ -inch diameter.  $L_2$  and  $L_3$  are spaced to accommodate  $L_1$   
 $L_4$   $L_6$   $L_8$   $L_9$  = Silver-plated copper rod 3/16-inch diameter approximately 3 inches long. Rods of each pair spaced 11/16 inch on centers  
 $L_5$   $L_7$  = Silver-plated copper rod 3/16-inch diameter approximately  $1\frac{1}{2}$  inches long. Rod

- spaced 1 inch on centers  
 $L_{10}$  = 1 turn of No. 8 silver-plated copper wire approximately 1 inch square  
 $L_{11}$   $L_{12}$   $L_{13}$   $L_{14}$   $L_{15}$  = RF choke, Ohmite Z-460 or equivalent  
 $M_1$   $M_3$  = Milliammeter, 0-5 ma, dc  
 $M_2$   $M_4$  = Milliammeter, 0-150 ma, dc  
 $R_1$   $R_2$   $R_5$   $R_6$  = 57 ohms, 1 watt  
 $R_3$   $R_4$  = 25000 ohms, 0.25 watt  
 $R_7$  = 51000 ohms, 0.5 watt  
 $R_8$   $R_9$  = Potentiometer, 20000 ohms, 2 watts

NOTE: Suitable tube sockets are Johnson 122-248 or equivalent mounted 9/16 inch below chassis. For detailed operating conditions of this circuit, refer to type 6524 in the *Tube Types* Section where typical operation values for Intermittent Commercial and Amateur Service (ICAS) are given for both the tripler and final at 462 Mc.





(5-21)

## OSCILLATOR FOR DIELECTRIC HEATING

Frequency 27 Mc (Approx.)

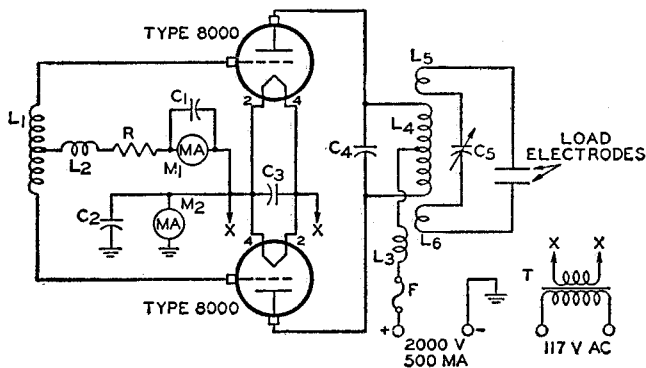

$C_1$   $C_2$   $C_3=0.005 \mu\text{f}$ , mica, 600 v.  
 $C_4=2$  plates  $3/32$ -inch aluminum, 5 inches x 7 inches spaced  $7/8$  inch  
 $C_5=50 \mu\text{f}$ , max., depends on work load  
 F=Fuse, 0.5 amp  
 $L_1=5$  turns  $3/16$ -inch copper

tubing spaced  $3/4$  inch on  $2 1/4$ -inch I.D.  
 $L_2=$ RF choke, 40 ma  
 $L_3=$ RF choke, 600 ma  
 $L_4=3$  turns  $5/16$ -inch copper tubing spaced  $5/8$  inch on  $3 3/4$ -inch I.D.  
 $L_5$   $L_6=2$  turns  $3/16$ -inch copper

tubing with adjustable spacing between turns on  $3 3/4$ -inch I.D.  
 $M_1=$  Milliammeter, 0-100 ma, dc  
 $M_2=$  Milliammeter, 0-1000 ma, dc  
 $R=5000$  ohms, 25 watts  
 T=Filament transformer, 10 volts rms, 9 amp

NOTE: Adequate shielding should be used to assure compliance with FCC requirements regarding spurious radiation.

(5-22)

## OSCILLATOR FOR INDUCTION HEATING

Frequency 450 Kc (Approx.)

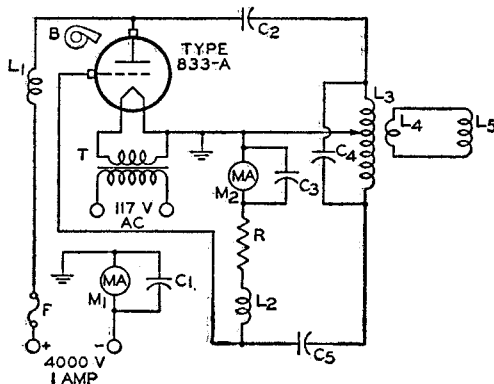

$C_1$   $C_3=0.01 \mu\text{f}$ , mica, 600 v.  
 $C_2$   $C_5=0.1 \mu\text{f}$ , paper, 5000 v., 0.6 amp rms min.  
 $C_4=0.002 \mu\text{f}$ , mica, 8000 volts min., 15 amp rms  
 F=Fuse, 1 amp  
 $L_1=3$ mh, rf choke, 1 amp rms, insulated for 10000 peak volts, single-layer solenoid, 300 turns No. 18 Enam., 12

inches long on 4-inch diameter  
 $L_2=3.5$  mh, rf choke, 250 ma  
 $L_3=63 \mu\text{h}$ , choke, 15 amp rms, insulated for 5000 peak volts, 40 turns No. 8 Enam., 8 inches on 4-inch diameter form.  
 $L_4=$ Single-turn secondary, sheet copper  
 $L_5=$ Work coil

$M_1=$  Milliammeter, 0-1000 ma, dc  
 $M_2=$  Milliammeter, 0-150 ma, dc  
 $R=2500$  ohms, 50 watts  
 T=Filament transformer, 10 volts rms, 10 amp  
 B=Blower, designed to supply an air flow of 40 cfm from a 2-inch-diameter nozzle directed vertically on bulb between grid and plate seals.

NOTE: Adequate shielding should be used to assure compliance with FCC requirements regarding spurious radiation.

(5-23)

### VHF OSCILLATOR FOR DIELECTRIC HEATING

Frequency 160 Mc (Approx.)

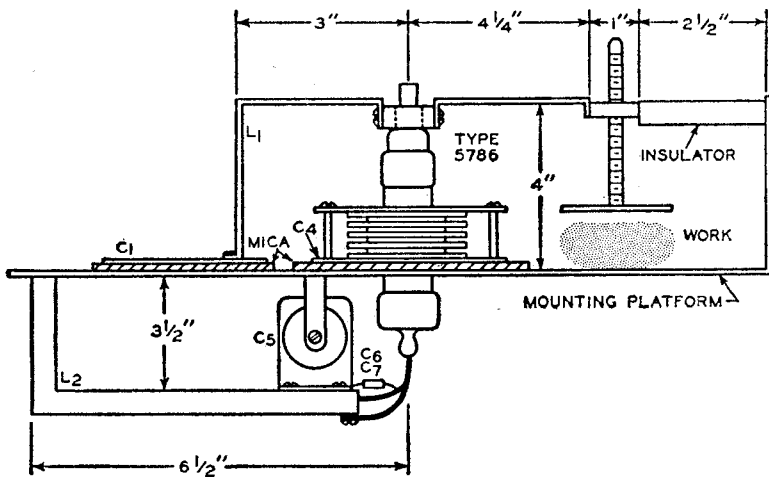
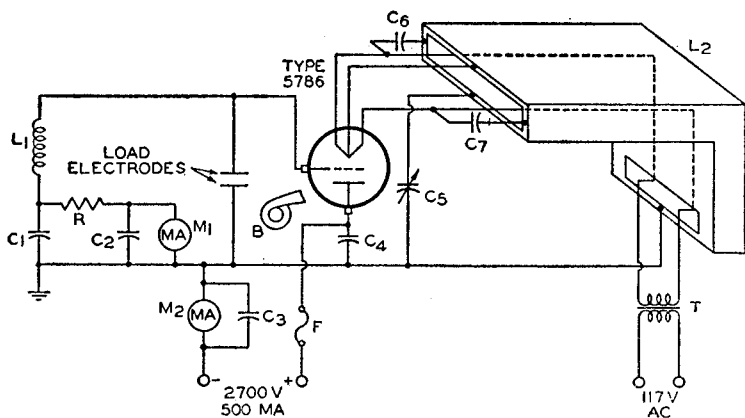

$C_1$  = 250  $\mu$ f, mica 0.005 inch thick, 3 inches x 3 3/4 inches copper plate, held to mounting platform by insulated pressure clamps  
 $C_2$   $C_3$  = 0.001  $\mu$ f, mica, 600 v.  
 $C_4$  = 200  $\mu$ f, mica 0.005 inch thick, 4 inches x 5 inches copper plate, held to mounting platform by insulated pressure clamps  
 $C_5$  = 10-30  $\mu$ f, variable, consisting of copper plate

3 inches x 3 1/2 inches mounted on  $L_2$  and round disk 3 inches in diameter, air gap 1/4 inch to 1 inch  
 $C_6$   $C_7$  = 100  $\mu$ f, mica ("postage stamp"), 600 v.  
 $F$  = Fuse, 0.5 amp  
 $L_1$  = Copper strap 1-3/16 inches wide x 1/16 inch thick  
 $L_2$  = 1/2 inch x 1 inch rectangular waveguide or equivalent  
 $M_1$  = Milliammeter, 0-150 ma, dc  
 $M_2$  = Milliammeter, 0-750 ma, dc

$R$  = 2000 ohms, wire-wound, 50 watts  
 $T$  = Filament transformer, 11 volts rms, 12.5 amp, maximum starting surge 50 amp  
 $B$  = Blower, designed to supply an air flow of at least 140 cfm through an outlet area of 6 1/4 square inches to the radiator and the filament and grid seals.

NOTE: Entire oscillator and load assembly is enclosed in metal box having one end open for cooling-air exit and for ease of loading work. Mounting platform divides box into two compartments. See tube data for RCA-5786 forced-air-cooling requirements. Tube and circuit must be protected from fumes or vapors that may come from work. Adequate shielding should be used to assure compliance with FCC requirements regarding spurious radiation.

# Index

<b>A</b>		<i>Page</i>	<i>Page</i>
Absolute Maximum Ratings.....		84	
AC Circuit Returns.....		67	
Adjustment and Tuning.....		59	
Adjustments, Neutralizing.....		61	
Amplification.....		15	
Amplifier:			
audio-frequency.....		29	
cathode-drive.....		26	
cathode-follower.....		26	
class A.....		15, 16	
class AB.....		15, 19	
class AB, calculations.....		54	
class B.....		15, 17	
class B, calculations.....		56, 57	
class C.....		15, 20	
class C, calculations.....		47	
keyed.....		21	
modulated.....		21	
parallel.....		17	
push-pull.....		17, 18	
radio-frequency.....		32	
Amplitude Modulation.....		18	
Anode:			
current.....		74	
types.....		12	
voltage.....		74	
AF Power Amplifiers.....		29	
<b>B</b>			
Basic Considerations.....		3	
Beam Power Tubes.....		9	
Bias:			
cathode-resistor (self).....		29, 35	
fixed.....		34	
grid-resistor.....		35	
self (cathode-resistor).....		29, 35	
supply.....		69	
<b>C</b>			
Calculation of:			
average anode current.....		79	
cathode (self-bias) resistor.....		35	
class AB and class B af amplifier service		54	
class AB <sub>2</sub> amplifiers, multigrid tubes.....		55	
class B amplifiers, triodes.....		56, 57	
class C telegraphy service, multigrid		47	
tubes.....		47	
class C telegraphy service, triodes.....		49	
conversion factors.....		57	
frequency multipliers.....		51	
grid resistor.....		35	
operating conditions.....		46	
peak inverse anode voltage.....		79	
plate-modulated class C telephony		51	
service.....		51	
Capacitances.....		7	
Capacitive Coupling.....		40, 42	
Capacitor-Input Filters.....		80	
Cathode:			
bias.....		29, 35	
directly heated.....		10	
drive.....		26	
follower.....		26	
indirectly heated.....		11	
modulation.....		23	
types.....		10	
unipotential.....		11	
Characteristics Curves, Use of.....		47	
Charts and Tables:			
conversion constants.....		46, 51	
conversion-factor nomograph.....		58	
filter-design curves.....		81, 82	
power tubes for af power amplifier and		88	
modulator service.....		88	
power tubes for linear rf amplifier service,		92	
SSB suppressed carrier, 2-tone mod-		92	
ulation.....		92	
power tubes for plate-modulated rf ampli-		90	
fier service—class C telephony.....		90	
power tubes for plate- or grid-pulsed		93	
amplifiers or oscillators.....		93	
power tubes for rf amplifier service—		91	
class C telegraphy.....		91	
power tubes for special services.....		93	
rectifier operating-value ratios.....		78	
rectifier tubes.....		94	
Choke-Input Filters.....		80	
Circuit Configuration.....		26	
Circuit Diagrams, List of.....		291	
Circuits, Rectifier.....		75	
Circuit Returns.....		66	
Class A Amplifiers.....		15, 16	
Class AB Amplifiers.....		15, 19, 54	
Class AB <sub>1</sub> SSB Service.....		51	
Class AB <sub>2</sub> Amplifiers.....		55	
Class B Amplifiers.....		15, 17, 54, 56	
Class C Amplifiers.....		15, 20, 46	
Class C Telegraphy Service, Multigrid		47	
Tubes.....		47	
Class C Telegraphy Service, Triodes.....		49	
Continuous Commercial Service (CCS)...		84	
Control-Grid Modulation.....		23	
Control-Grid Supply.....		69	
Conversion Constants, Tables of.....		46, 51	
Conversion Factors.....		57	
Coupling:			
capacitive.....		40, 42	
inductive.....		41, 42	
interstage.....		40	
link.....		41	
output.....		41	
Crystal Oscillators.....		25, 35	
Current:			
anode.....		74	
peak plate.....		20	
plate.....		3, 4	
Curves, Use of.....		47	

# INDEX (Continued)

	<i>Page</i>		<i>Page</i>
<b>D</b>			
DC Circuit Returns.....	66	Heater:	
Design-Center Maximum Ratings.....	84	cathode.....	11
Design of Choke-Input Filters.....	80	cathode voltage.....	86
Diodes.....	5	supply.....	67
Direct Inductive Coupling.....	41	High-Level Modulation.....	18
Distortion, Waveform.....	16	<b>I</b>	
Driver Transformer.....	31	Inductive Coupling.....	41, 42
Driving Power.....	33, 85	Input Signal.....	6
Driving Signal.....	16	Insulation, Internal.....	14
Dynatron Action.....	8	Interelectrode Capacitances.....	7
<b>E</b>			
Efficiency, Plate-Circuit.....	16	Intermittent Commercial and Amateur Service (ICAS).....	84
Emission:		Intermittent Mobile Service (IMS).....	84
secondary.....	5	Internal Insulation.....	14
thermionic.....	10	Interstage Coupling.....	40
Envelopes.....	14	Interstage Transformer.....	31
<b>F</b>			
Fault Current.....	74	Inverse Voltage.....	74
Filament:		<b>K</b>	
cathode.....	10	Keyed Amplifier.....	21
heating time.....	71	Key to Base and Envelope Connections ..... Inside Back Cover	
quick-heating.....	11	<b>L</b>	
supply.....	67	Linear RF Power Amplifiers.....	32
Filters.....	80	Link Coupling.....	41
Filter-Design Curves.....	81, 82	Low-Level Modulation.....	18
Fixed Bias.....	34	<b>M</b>	
Formulas (see Calculation)		Mercury Temperature.....	72
Forward Current.....	74	Mercury-Vapor Tubes.....	5, 71
Forward Voltage.....	74	Modulated Class C Amplifiers.....	21
Frequency Multiplication.....	24	Modulation:	
Frequency Multipliers.....	35, 51	amplitude.....	18
Full-Wave Rectifiers.....	5	cathode.....	23
<b>G</b>			
Gas Tubes.....	5	control-grid.....	22
Generic Tube Types.....	5	plate.....	22
Getters.....	13	screen-grid.....	23
Grid:		suppressor-grid.....	23
bias.....	34	transformer.....	24, 31
control.....	7	Modulators.....	31
drive.....	26	Mountings.....	63
driving power.....	85	Multiple-Tube Stages.....	29
modulation.....	22	Multiplication, Frequency.....	25
neutralization.....	43	Multipliers, Frequency.....	35, 51
resistor.....	35	<b>N</b>	
screen.....	7	Neutralization.....	7, 42, 43
supply.....	68	Neutralizing Adjustments.....	61
suppressor.....	8	<b>O</b>	
types.....	14	Operating Conditions, Calculation of.....	46
<b>H</b>			
Half-Wave Rectifiers.....	5	Oscillations, Parasitic.....	43
		Oscillators.....	25, 36

# INDEX (Continued)

	<i>Page</i>		<i>Page</i>
Output Coupling.....	41	Regulator Tubes.....	35
Output Transformers.....	31	Resistance, Plate.....	4
<b>P</b>		Returns, Circuit.....	66
Parallel Operation.....	17, 29, 35	<b>S</b>	
Parallel-Tuned Tank Circuits.....	37	Safety Considerations.....	70
Parasitic Oscillations.....	43	Saturation.....	4, 33
Peak Anode Current.....	74	Screen Grid (Grid No.2):	
Peak Heater-Cathode Voltage.....	86	input.....	85
Peak Inverse Anode Voltage.....	74	modulation.....	23
Peak Plate Current.....	20	supply.....	68
Pentodes.....	8	Secondary Emission.....	5
Plate:		Shielding.....	72
construction.....	10	Signal, Input.....	6
current.....	3, 4	Single-Sideband Transmitters.....	19
dissipation.....	85	Sockets.....	63, 4
efficiency.....	16	Space Charge.....	4
input.....	85	Stabilization.....	42
modulation.....	22	Supply-Voltage Variations.....	69
neutralization.....	43	Suppressor Grid (Grid No.3):	
resistance.....	4	modulation.....	23
supply.....	68	supply.....	68
types.....	12	<b>T</b>	
voltage.....	4	Tables and Charts (see Charts and Tables)	
Plate-Modulated Class C Telephony Service.....	51	Tank Circuits, Parallel Tuned.....	37
Power Amplifiers:		Temperature, Mercury.....	72
audio-frequency.....	29	Tetrodes.....	7
radio-frequency.....	32	Transformer:	
Power Oscillators.....	25	driver.....	31
Power Output.....	85	interstage.....	31
Power Rectifiers.....	4, 5	modulation.....	24, 31
Power-Supply Considerations.....	45, 67	output.....	31
Power-Tube Amplifiers.....	3	Triodes.....	6
Power-Tube Application Tables.....	88	Tube Selection.....	28
Protective Devices.....	69	Tuned Tank Circuits.....	37
Push-Pull Operation.....	17, 18, 29, 35	Tuning Procedure.....	60
Push-Push Operation.....	25	<b>U</b>	
<b>Q</b>		Unipotential Cathodes.....	47
Quadrature Operation.....	77	Use of Characteristics Curves.....	47
<b>R</b>		<b>V</b>	
Radio-Frequency Power Amplifiers.....	32	Vacuum Tubes.....	4
Ratings:		Ventilation and Cooling.....	63
absolute maximum.....	84	Voltage:	
design-center.....	84	forward.....	74
rectifier.....	74	heater-cathode.....	86
Rectifier Tube:		inverse.....	74
circuits.....	75	plate.....	4
full-wave.....	5	Voltage Regulator Tubes.....	35
half-wave.....	5	<b>W</b>	
mercury-vapor.....	5, 71	Waveform Distortion.....	16
operating-value ratios.....	78	Wiring Considerations.....	64
ratings.....	74		
Rectifier Tubes, Selection Guide.....	94		
Regulation.....	79		

# RCA Technical Publications

## *on Electron Tubes, Semiconductor Products, Batteries, and Test and Measuring Equipment*

Copies of the publications listed below may be obtained from your RCA distributor or from Commercial Engineering, Radio Corporation of America, Harrison, N. J.

### Electron Tubes

- **RCA TRANSMITTING TUBES**—TT-5 (8¼" x 5⅝")—320 pages. Written for the engineer, technician, radio amateur, and student, this new larger edition has been comprehensively revised and updated. Gives data on over 180 tube types, including cermolox, ceramic-and-metal, pencil, and pulse-rated types. Provides basic tube information on generic types, parts and materials, installation and application, and interpretation of data. Includes maximum ratings, typical operating values, and characteristics curves for power tubes having plate-input ratings up to 4 kw and for associated rectifier tubes. Contains material on power-tube circuit-design considerations and rectifier circuits and filters, as well as new application tables for quick, easy selection of tubes, and circuit diagrams for transmitting and industrial applications. Also gives new design information on linear rf amplifiers for single sideband applications. Features lie-flat binding. Price \$1.00.\*
- **RCA RECEIVING TUBE MANUAL**—RC-21 (8¼" x 5⅝")—480 pages. Revised, expanded, and brought up to date. Contains technical data on 903 receiving tubes and 106 picture tubes for black-and-white and color television. Features tube theory written for the layman, application data for radio and television circuits, Resistance-Coupled Amplifier Section, new receiving-tube and picture-tube charts, and several circuits for high-fidelity audio amplifiers. Features lie-flat binding. Price \$1.00.\*
- **RCA ELECTRON TUBE HANDBOOK**—HB-3 (7⅜" x 5⅝"). Five deluxe 2¼-inch-capacity black binders imprinted in gold. The "bible" of the industry—contains over 5000 pages of loose-leaf data and curves on RCA receiving tubes, transmitting tubes, cathode-ray tubes, picture tubes, photocells, phototubes, camera tubes, ignitrons, vacuum and gas rectifiers, magnetrons, traveling-wave tubes, premium tubes, pencil tubes, and other miscellaneous types for special applications. Available on subscription basis. Price \$20.00\* including service for first year. Also available with RCA Semiconductor Products Handbook HB-10 at special combination price of \$25.00\* Write to Commercial Engineering for descriptive flyer and order form.
- **RADIOTRON† DESIGNER'S HANDBOOK**—4th Edition (8¾" x 5½")—1500 pages. Comprehensive reference thoroughly covering the design of radio and audio circuits and equipment. Written for the design engineer, student, and experimenter. Contains 1000 illustrations, 2500 references, and cross-referenced index of 7000 entries. Edited by F. Langford-Smith of Amalgamated Wireless Valve Co., Pty., Ltd. in Australia. Price \$7.00.\*
- **RCA POWER TUBES**—PG-101E (10⅞" x 8⅜")—46 pages. Completely revised and brought up to date. Technical information on 200 RCA vacuum

†Trade Mark Reg. U. S. Pat. Off.

\*Prices shown apply in U.S.A. and are subject to change without notice.

○Optional List Price.

power tubes, rectifier tubes, thyratrons, and ignitrons. Includes terminal connections. Price 75 cents.\*°

• **RCA RECEIVING-TYPE TUBES FOR INDUSTRY AND COMMUNICATIONS**—RIT 104B (10 $\frac{7}{8}$ " x 8 $\frac{3}{8}$ ")—32 pages. Technical information on over 190 RCA "special red" tubes, premium tubes, nuvistors, computer tubes, pencil tubes, glow-discharge tubes, small thyratrons, low-microphonic amplifier tubes, vacuum-gauge tubes, mobile communications tubes, and other special types. Includes socket-connection diagrams. Price 30 cents.\*°

• **RCA RECEIVING TUBES AND PICTURE TUBES**—1275K (10 $\frac{7}{8}$ " x 8 $\frac{3}{8}$ ")—64 pages. New, enlarged, and up-to-date booklet contains classification chart, application guide, characteristics chart, and base and envelope connection diagrams on more than 1050 entertainment receiving tubes and picture tubes. Price 50 cents.\*°

• **RCA PHOTSENSITIVE DEVICES AND CATHODE-RAY TUBES**—CRPD-105B (10 $\frac{7}{8}$ " x 8 $\frac{3}{8}$ ")—36 pages. Contains technical information on 151 RCA tubes including single-unit, twin-unit, and multiplier phototubes; photocells; camera and image-converter tubes; flying-spot tubes; monitor, projection, transcriber, and view-finder kinescopes; oscillograph and storage tubes. Price 50 cents.\*°

• **RCA INTERCHANGEABILITY DIRECTORY OF INDUSTRIAL-TYPE ELECTRON TUBES**—ID-1020C (10 $\frac{7}{8}$ " x 8 $\frac{3}{8}$ ")—16 pages. Lists more than 1450 basic type designations for 18 classes of industrial tube types; shows the RCA Direct Replacement Type or the RCA Similar Type, when available. Price 35 cents.\*°

• **RCA PHOTOCELLS**—1CE-261 (10 $\frac{7}{8}$ " x 8 $\frac{3}{8}$ ")—20 pages. Contains a selection of photocell-circuit diagrams; technical data and characteristic curves of RCA photoconductive, photojunction, and photovoltaic cells; interchangeability information; and supplementary information on tungsten and fluorescent light sources. Booklet is designed to introduce the engineer, the hobbyist, and the ex-

perimeter to application possibilities of RCA photocells. Price 25 cents.\*°

• **RCA MAGNETRONS AND TRAVELING-WAVE TEBUS**—MT-301A (10 $\frac{7}{8}$ " x 8 $\frac{3}{8}$ ")—48 pages. Operating theory for magnetrons and traveling-wave tubes, application considerations, and techniques for measurement of electrical parameters. Price 60 cents.\*°

• **RCA PENCIL TUBES**—1CE-219 (10 $\frac{7}{8}$ " x 8 $\frac{3}{8}$ ")—28 pages. Contains operating theory for pencil tubes, electrical and mechanical circuit-design considerations, environmental considerations, application considerations, and data for commercial types. Price 50 cents.\*°

• **RCA PHOSPHORS**—TPM-1508A (10 $\frac{7}{8}$ " x 8 $\frac{3}{8}$ ")—20 pages. Contains defining data for over 25 different industrial phosphors, spectral-energy emission curves, persistence curves, and quick-reference classification charts. Price 75 cents.\*°

• **RCA CAMERA TUBES**—1CE-262 (10 $\frac{7}{8}$ " x 8 $\frac{3}{8}$ ")—24 pages. Technical information on RCA image orthicons and vidicons aimed at helping the camera tube user select the most appropriate tube for his application. Includes concise data on all commercially available RCA camera tubes as well as typical curves and information defining the most important characteristics of camera tubes. Also contains cutaway views of a vidicon and image orthicon illustrating construction features. Price 75 cents.\*°

• **RCA INTERCHANGEABILITY DIRECTORY OF FOREIGN vs. U.S.A. RECEIVING-TYPE ELECTRON TUBES**—1CE-197B (8 $\frac{3}{8}$ " x 10 $\frac{7}{8}$ ")—8 pages. Covers approximately 800 foreign tube types used principally in AM and FM radios, TV receivers, and audio amplifiers. Indicates U.S.A. direct replacement type or similar type if available. Price 10 cents.\*°

• **TECHNICAL BULLETINS**—Authorized information on RCA transmitting tubes and other tubes for communications and industry. Be sure to mention tube-type bulletin desired. Single copy on any type free on request.

†Trade Mark Reg. U. S. Pat. Off.

\*Prices shown apply in U.S.A. and are subject to change without notice.

°Optional List Price.

## Semiconductor Products

● **RCA TRANSISTOR MANUAL—SC-10** ( $8\frac{3}{8}'' \times 5\frac{3}{8}''$ )—304 pages. New manual contains detailed technical data on RCA semiconductor devices. Easy-to-read text contains information on basic theory, application, and installation of transistors, silicon rectifiers, and semiconductor diodes. Includes circuit diagrams and parts lists for many typical applications. Features lie-flat binding. Price \$1.00.\*<sup>o</sup>

● **RCA SEMICONDUCTOR PRODUCTS HANDBOOK—HB-10.** Two binders, each  $7\frac{3}{8}''$  L x  $5\frac{3}{8}''$  W x  $2\frac{7}{8}''$  D, having gold-imprinted red covers. Contains over 1000 pages of loose-leaf data and curves on RCA semiconductor devices such as germanium transistors, silicon transistors, silicon rectifiers, and semiconductor diodes. Available on subscription basis. Price \$10.00\* including service for first year. Also available with RCA Electron Tube Handbook HB-3 at special combination price of \$25.00\*. Write to Commercial Engineering for descriptive flyer and order form.

● **RCA SEMICONDUCTOR PRODUCT GUIDE—60S16R3** ( $10\frac{7}{8}'' \times 8\frac{3}{8}''$ )—12 pages. Contains classification chart, index, and ratings and characteristics on RCA's line of transistors, silicon recti-

fiers, semiconductor diodes, and photocells. Single copy free on request.

● **RCA SILICON POWER TRANSISTORS APPLICATION GUIDE—1CE-215** ( $10\frac{7}{8}'' \times 8\frac{3}{8}''$ )—28 pages. Describes outstanding features of RCA silicon power transistors and their use in many critical industrial and military applications. Includes construction details, discussion of voltage ratings, thermal stability conditions, and equivalent circuits for these transistors. Price 50 cents.\*<sup>o</sup>

● **RCA SILICON VHF TRANSISTORS APPLICATION GUIDE—1CE-228** ( $10\frac{7}{8}'' \times 8\frac{3}{8}''$ )—20 pages. Describes unique capabilities of RCA silicon vhf transistors and their use in critical industrial and military applications up to 300 Mc. Price 50 cents.\*<sup>o</sup>

● **TRANSISTORIZED VOLTAGE REGULATORS APPLICATION GUIDE—1CE-254** ( $10\frac{7}{8}'' \times 8\frac{3}{8}''$ )—12 pages. Describes and discusses transistorized voltage regulators of the series and shunt types. Included are design considerations, step-by-step design procedures, and the solutions to sample design problems. An Appendix contains the derivation of design equations. Price 25 cents.\*<sup>o</sup>

## Batteries

● **RCA BATTERY MANUAL—BDG-111** ( $10\frac{7}{8}'' \times 8\frac{3}{8}''$ )—64 pages. Contains information for the designer, application engineer, experimenter, and student on dry cells and batteries [carbon zinc (Leclanché), mercury, and alkaline types]. Included in this manual are battery theory and applications, detailed electrical and mechanical characteristics, a classification chart, dimensional outlines and terminal connections on each battery type. Price 50 cents.\*<sup>o</sup>

● **RCA BATTERIES—BAT-134E** ( $10\frac{7}{8}'' \times 8\frac{3}{8}''$ )—16 pages. Technical data on 106 Leclanché, alkaline, and mercury-type dry batteries, for radios, industrial applications, flashlights, lanterns, electronic toys, and for photoflash service. Price 35 cents.\*<sup>o</sup>

● **RCA BATTERIES FOR TRANSISTOR APPLICATIONS—TBA-107A** ( $10\frac{7}{8}'' \times 8\frac{3}{8}''$ )—12 pages. Technical data and curves on 25 RCA Leclanché-and-mercury-type dry batteries specifically designed for use in applications utilizing transistors. Price 25 cents.\*<sup>o</sup>

†Trade Mark Reg. U. S. Pat. Off.

\*Prices shown apply in U.S.A. and are subject to change without notice.

<sup>o</sup>Optional List Price.



# Test and Measuring Equipment

**INSTRUCTION BOOKLETS** — Illustrated instruction booklets, containing specifications, operating and maintenance data, application information, schematic diagrams, and replacement parts lists, are

available for all RCA test instruments. Booklets for the following popular instruments are available at the prices indicated. Prices for booklets on other instruments are available on request.

WA-44 (Audio Signal Generator).....	\$0.50*	WV-74A (High-Sensitivity AC VTVM).....	0.75*
WA-44C (Sine-Square Wave Audio Generator).....	1.00*	WV-75A (VoltOhmyst†).....	0.25*
WO-33A (Super-Portable Oscilloscope).....	1.00*	WV-77A (VoltOhmyst†).....	0.25*
WO-88A (5-in. Oscilloscope)....	0.50*	WV-77B (VoltOhmyst†).....	0.25*
WO-91A (5-in. Oscilloscope)....	1.00*	WV-77E (VoltOhmyst†).....	1.00*
WR-36A (Dot-Bar Generator)..	0.50*	WV-84C (Ultra-Sensitive DC Microammeter)..	0.75*
WR-39C (TV Calibrator).....	0.50*	WV-87B (Master VoltOhmyst†)	0.75*
WR-46A (Video Dot/Crosshatch Generator).....	0.75*	WV-95A (VoltOhmyst†).....	0.25*
WR-49A (RF Signal Generator)	0.50*	WV-97A (VoltOhmyst†).....	0.50*
WR-49B (RF Signal Generator)	1.00*	WV-98A (VoltOhmyst†).....	1.00*
WR-61B (Color-Bar Generator)	1.00*	WV-98B (Senior VoltOhmyst†)	1.00*
WR-64A (Color-Bar/Dot/Crosshatch Generator)	1.00*	WV-98C (Senior VoltOhmyst†)	0.50*
WR-67A (Test-Oscillator).....	0.25*	195-A (VoltOhmyst†).....	0.25*
WR-69A (TV-FM Sweep Generator).....	1.00*	WT-100A (Electron-Tube MicroMhoMeter, Ser. No.1001 and over) ..	2.00*
WR-70A (RF-IF-VF Marker Adder).....	0.75*	WT-100A (Tube Chart 1CE —163).....	3.00*
WR-86A (UHF Sweep Generator).....	0.50*	WT-110A (Automatic Electron-Tube Tester).....	1.00*
WR-99A (Marker Calibrator) ..	1.00*	WT-110A (1CE-174 Card Punch Data).....	0.25*
WV-37B (Radio Battery Tester)	0.25*	WT-110A (1CE-234 Card Punch Data).....	1.00*
WV-38A (Volt-Ohm-Milliammeter).....	0.50*	WT-110A (Supplement 2 to 1CE-234 Card Punch Data).....	0.50*
WV-65A (VoltOhmyst†).....	0.25*		

†Trade Mark Reg. U. S. Pat. Off.

\*Prices shown apply in U.S.A. and are subject to change without notice.

°Optional List Price.

# Reading List

The publications listed represent both elementary and advanced treatments of power and rectifier tube theory, applications, and circuit design. The list, obviously, is not inclusive, but additional references are given in the publications listed.

ARRL *Antenna Book*. American Radio Relay League.

BENEDICT, R. R. *Industrial Electronics*. Prentice-Hall, Inc.

CHUTE, G. M. *Electronics in Industry*. McGraw-Hill Book Co., Inc.

DAVIS AND WEED. *Industrial Electronic Engineering*. Prentice-Hall, Inc.

DOME, R. B. *Television Principles*. McGraw-Hill Book Co., Inc.

EVERITT, W. L. *Communication Engineering*. McGraw-Hill Book Co., Inc.

FINK, D. G. *Engineering Electronics*. McGraw-Hill Book Co., Inc.

GRAY, T. S. *Applied Electronics*. John Wiley & Sons, Inc.

KLOEFFLER, R. G. *Industrial Electronics and Control*. John Wiley & Sons, Inc.

KOLLER, L. R. *Physics of Electron Tubes*. McGraw-Hill Book Co., Inc.

MARKUS AND ZELUFF. *Electronics for Communication Engineers*. McGraw-Hill Book Co., Inc.

MARKUS AND ZELUFF. *Handbook of Industrial Electronic Circuits*. McGraw-Hill Book Co., Inc.

PENDER, DELMAR, AND MCILWAIN. *Handbook for Electrical Engineering—Communications and Electronics*. John Wiley & Sons, Inc.

PREISMAN, A. *Graphical Constructions for Vacuum Tube Circuits*. McGraw-Hill Book Co., Inc.

PRINCIPLES OF ELECTRICAL ENGINEERING SERIES. *Applied Electronics*. John Wiley & Sons, Inc.

RADIATION LABORATORY SERIES. Vol. 18—*Vacuum-Tube Amplifiers*; Vol. 19—*Wave-forms*. McGraw-Hill Book Co., Inc.

RADIO RESEARCH LABORATORY, HARVARD UNIVERSITY. *Very-High-Frequency Techniques*. McGraw-Hill Book Co., Inc.

REICH, H. J. *Theory and Applications of Electron Tubes*. McGraw-Hill Book Co., Inc.

RICHTER, WALTHER. *Fundamentals of Industrial Electronic Circuits*. McGraw-Hill Book Co., Inc.

*Single Sideband for the Radio Amateur*. American Radio Relay League.

SPANGENBERG, K. R. *Vacuum Tubes*. McGraw-Hill Book Co., Inc.

TERMAN, F. E. *Electronic and Radio Engineering*. McGraw-Hill Book Co., Inc.

TERMAN, F. E. *Radio Engineers Handbook*. McGraw-Hill Book Co., Inc.

TERMAN AND PETTIT. *Electronic Measurements*. McGraw-Hill Book Co., Inc.

*The Radio Amateurs Handbook*. American Radio Relay League.

*The Radio Handbook*. Editors & Engineers, Ltd.

FEDERAL COMMUNICATIONS COMMISSION

Part 12: *Rules Governing Amateur Radio Service*.

Part 18: *Rules and Regulations Relating to Industrial, Scientific, and Medical Service*.

# Key to Base and Envelope Connection Diagrams

*Diagrams show terminals viewed from base or filament end of tube*

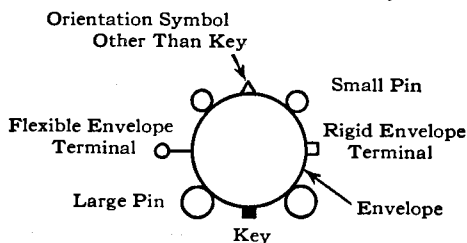

- |                             |                                   |                    |
|-----------------------------|-----------------------------------|--------------------|
| ● Gas-Type Tube             | G Grid                            | IS Internal Shield |
| BC Base Sleeve              | H Heater                          | K Cathode          |
| CP Center Pin               | H <sub>M</sub> Heater Tap         | NC No Connection   |
| F Filament                  | IC Internal Connection—Do not use | P Plate or Anode   |
| F <sub>M</sub> Filament Tap |                                   | S Shell            |

*Subscripts for multi-unit types: B, beam unit; D, diode unit; P, pentode unit; T, triode unit, TR, tetrode unit.*

In addition to the tube types described in this manual, the ELECTRON TUBE DIVISION OF RADIO CORPORATION OF AMERICA offers a comprehensive line of high-power and super-power tubes for transmitting and industrial applications. Other available lines of RCA electron devices include:

## PHOTOCELLS

*Photoconductive and Photojunction Types*

## MICROWAVE TUBES

*Magnetrons, Traveling-Wave Tubes, Pencil Tubes*

## CATHODE-RAY TUBES

*Special-Purpose Kinescopes, Storage-Tubes, and Oscillograph Types*

## THYRATRONS AND IGNITRONS

## SPECIAL TYPES

*Vacuum-Gauge Tubes, Image Converters*

## TELEVISION CAMERA TUBES

*Vidicons, Image Orthicons, and Monoscopes*

## PHOTOTUBES

*Single-Unit, Twin-Unit, and Multiplier Types*

## SEMICONDUCTOR DEVICES

*Germanium and Silicon Transistors, Silicon Rectifiers, Diodes*

## RECEIVING TUBES

*Voltage and Power Amplifiers, Converters, Oscillators, Mixers, Rectifiers, and Diode Detectors*

## PICTURE TUBES

*Black-and-White and Color*

For sales information,  
write to Sales

For technical information,  
write to Commercial Engineering

# RADIO CORPORATION OF AMERICA

ELECTRON TUBE DIVISION

HARRISON, N. J.